

S32K1xx Reference Manual

This is the S32K1xx Reference Manual set, consisting of the following files:

- S32K1xx Reference Manual Addendum, Rev. 1
- S32K1xx Reference Manual, Rev. 14



S32K1xx Reference Manual Addendum



Contents

Chapter 1 Introduction.....	3
Chapter 2 System OSC Divide Register (SCG_SOSCDIV).....	4
Chapter 3 Program Partition command.....	5
Chapter 4 CMD_VERIFY_MAC.....	9
Chapter 5 Program Partition command.....	12
Chapter 6 CMD_VERIFY_MAC.....	16

Chapter 1

Introduction

This addendum describes corrections or updates to the S32K1xx Reference Manual. The currently-available version of the S32K1xx Reference Manual is Revision 14. In the table below, the page numbers in the Location column are relative to that version.

Navigation tip: When navigating this PDF file using the hyperlinks, pressing the ALT and "left arrow" keys simultaneously will return you to the previously viewed page.

Table 1. S32K1xxRM Rev. 1 addendum

Location	Description
602	<ul style="list-style-type: none"> Added bit field SCG_SOSCDIV[SOSCDIV1]. See System OSC Divide Register (SCG_SOSCDIV)
866	<ul style="list-style-type: none"> In the table Program Partition command FCCOB requirements added FCCOB numbers 6 and 7. For FCCOB 1 added MAC Length Provision. See Program Partition command
866 and 978	<ul style="list-style-type: none"> In the table Program Partition command error handling Updated FCCOB Error conditions. See Table 10
894	<ul style="list-style-type: none"> Added the text "The provided MAC_LENGTH...in an ERC_GENERAL_ERROR" in the CMD_VERIFY_MAC command description. See CMD_VERIFY_MAC
978	<ul style="list-style-type: none"> Updated the section Program Partition command. See Program Partition command
1006	<ul style="list-style-type: none"> Added the text "The provided MAC_LENGTH...in an ERC_GENERAL_ERROR" in the CMD_VERIFY_MAC command description. See CMD_VERIFY_MAC

Chapter 2

System OSC Divide Register (SCG_SOSCDIV)

The SCG_SOSCDIV register provides the control of clock trees which can be used to provide optional peripheral functional clocks, or alternative module clocks. Each clock tree has optional dividers of the input SOSC clock. Changes to SOSCDIV should be done when System OSC is disabled to prevent glitches to output divided clock.

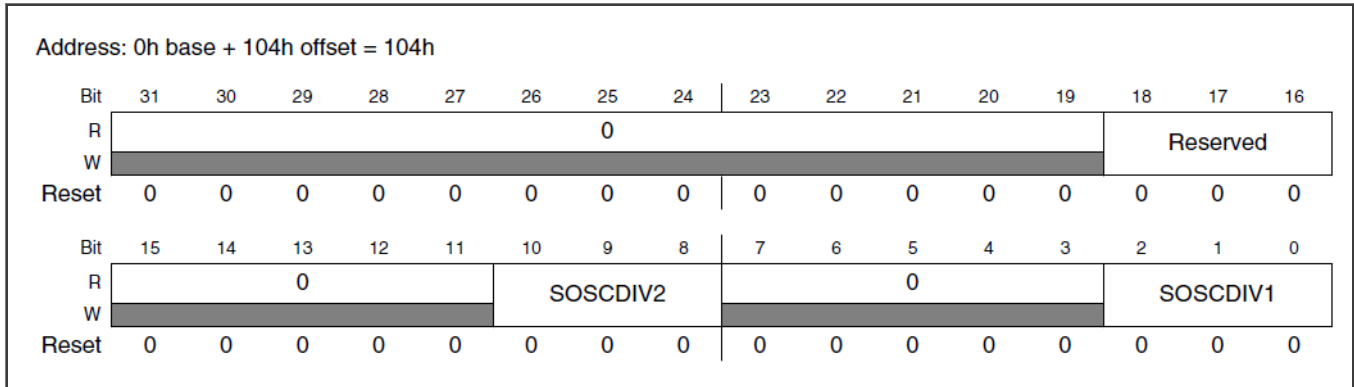

Field	Description
31–19	This field is reserved. This read-only field is reserved and always has the value 0.
18–16 Reserved	This field is reserved. This read-only field is reserved and always has the value 0.
15–11 Reserved	This field is reserved. This read-only field is reserved and always has the value 0.
10–8 SOSCDIV2	System OSC Clock Divide 2 Clock divider 2 for System OSC. Used by modules that need an asynchronous clock source. 000 Output disabled 001 Divide by 1 010 Divide by 2 011 Divide by 4 100 Divide by 8 101 Divide by 16 110 Divide by 32 111 Divide by 64
7–3 Reserved	This field is reserved. This read-only field is reserved and always has the value 0.
2–0 SOSCDIV1	System OSC Clock Divide 1 Clock divider 1 for System OSC. Used to generate the clock source for modules that need an asynchronous clock source. 000 Output disabled 001 Divide by 1 010 Divide by 2 011 Divide by 4 100 Divide by 8 101 Divide by 16 110 Divide by 32 111 Divide by 64

Chapter 3

Program Partition command

The Program Partition command prepares the FlexNVM block for use as data flash, emulated EEPROM backup, or a combination of both and initializes the FlexRAM. The Program Partition command must not be launched from flash memory, since flash memory resources are not accessible during Program Partition command execution. Changes related to execution of the Program Partition command take effect after the next reset.

The Program Partition command is expected to be run for fresh parts before other FTFC and CSEc commands are launched.

CAUTION

While different partitions of the FlexNVM are available, the intention is that a single partition choice is used throughout the entire lifetime of a given application. The FlexNVM Partition Code choices affect the endurance and data retention characteristics of the device.

Interrupting a Program Partition operation (due to power loss, reset, supplies out of specified operational ranges, or any other reasons) can leave the partition codes in an indeterminate state. The user must take appropriate counter measures to prevent data loss in case of an interrupted Program Partition operation.

Table 2. Program Partition command FCCOB requirements

FCCOB Number	FCCOB Contents [7:0]
0	0x80(PGMPART)
1	MAC Length Provision, CSEc Key Size
2	SFE
3	FlexRAM load during reset option (only bit 0 used): 0 - FlexRAM loaded with valid EEPROM data during reset sequence 1 - FlexRAM not loaded during reset sequence
4	EEPROM Data Set Size Code
5	FlexNVM Partition Code
6	BKRON - Boot Key Restriction On (only bit 0 used): 0 - Keys with boot protection enabled are accessible when Secure Boot is not enabled 1 - Keys with boot protection enabled are not accessible when Secure Boot is not enabled or Secure Boot failed
7	Minimum MAC Length for CMD_VERIFY_MAC command: 0x0 - 128-bits 0x1 to 0x7F - 1 to 127-bits

Table 3. CSEc/SHE key size

FCCOB1 [1:0]	Number of Flash Keys ({MASTER_ECU_KEY, BOOT_MAC_KEY, BOOT_MAC, KEY_<n>})	Number of Bytes (subtracts from the total EEERAM space)
2'b00	Zero	0
2'b01	1 to 5 keys	128 Bytes
2'b10	1 to 10 keys	256 Bytes
2'b11	1 to 20 keys	512 Bytes

For non-CSEc enabled parts, the number of Flash Keys must be configured as 2'b00 (no keys). The BKRON value in FCCOB6 is ignored and left unprogrammed/erased (1b1) if the CSEc Key Size is 0.

For CSEc enabled parts, the number of Flash Keys is user configurable, but the space will assume that the MASTER_ECU_KEY, BOOT_MAC_KEY and BOOT_MAC are there (if any keys are enabled), and thus will occupy 3 key slots of the available 20 key slot space. This results in leaving key slots for a range of 1 to 17 User Key_<n> keys.

For non-CSEc enabled parts the key allocation must be set to Zero keys (2'b00), otherwise the command will return an error.

NOTE

For CSEc enabled parts, once Flash Keys are allocated (regardless of being initialized or not), the SHE spec requirement of not erasing Flash Keys without authentication will apply. This will mean Authentication (DBG_CHAL & DBG_AUTH) commands must be run and pass (removing all flash keys) before erase of the DFlash (all Flash Keys are backed up in emulated EEPROM in DFlash). Thus Erase All Blocks and Erase All Blocks Unsecure will not work, nor will Erase Flash Block or Sector IF the selected Block/Sector includes the DFlash where the keys are stored. Additionally if any Flash Keys are write protected, they can't be erased/removed, thus the DFlash can't be erased and the Authentication process will not pass.

Table 4. Security Flag Extension (SFE)

SFE	Results
SFE == 0x01	Flash Key 'Verify Only' attribute enabled
SFE == 0x00	Flash Key 'Verify Only' attribute not enabled

The FCCOB[2] field is for the enhanced Security Flag Extension (SFE) is in a 8-bit field, but only bit [0] is used (bits [7:1] are ignored). This feature is an extension to the SHE specification. For standard SHE usage model, the user should configure this as 'not enabled' (SFE == 0x00). This addition is to add capability to flag a key as 'VERIFY_ONLY'. That is, the user can configure SFE == 0x01 and then use the LOAD_KEY command to add a new attribute to the key which would tell the GENERATE_MAC command that the key is to be used only by the VERIFY_MAC command (by configuring SFE as 'enabled' and then using LOAD_KEY to set the new VERIFY_ONLY attribute on that key).

The VERIFY_ONLY attribute has no effect if the KEY_USAGE attribute is '0'.

See the CMD_LOAD_KEY command for more information on the new attribute.

When FCCOB1[7] equals 0x1, the content of FCCOB7[6:0] sets the minimum MAC length for VERIFY_MAC commands for both data and pointer methods (FCCOB7[7] is ignored). A value of 0x0 is interpreted as 128-bits, while values 0x1 to 0x7F are directly interpreted as 1 to 127-bits.

When FCCOB1[7] equals 0x0, the value of FCCOB7 is ignored, instead using 1-bit as the minimum MAC length for VERIFY_MAC commands.

Table 5. Valid emulated EEPROM data set size codes : 2 KB FlexRAM configurations

EEPROM Data Set Size Code (FCCOB4) ¹	EEPROM Data Set Size (Bytes)
EEESIZE (FCCOB4[3:0])	
0xF	0 ²
0x3	2k

1. FCCOB4[7:4] = 0000
2. EEPROM Data Set Size must be set to 0 Bytes when the FlexNVM Partition Code is set for no EEPROM.

Table 6. Valid emulated EEPROM data set size codes : 4 KB FlexRAM configurations

EEPROM Data Set Size Code (FCCOB4) ¹	EEPROM Data Set Size (Bytes)
EEESIZE (FCCOB4[3:0])	
0xF	0 ²
0x2	4k

1. FCCOB4[7:4] = 0000
2. EEPROM Data Set Size must be set to 0 Bytes when the FlexNVM Partition Code is set for no EEPROM.

Table 7. Valid FlexNVM partition codes : 128 KB and 256 KB configurations with 32 KB FlexNVM

FlexNVM Partition Code DEPART (FCCOB5[3:0]) ¹	Data flash Size (KB)	EEPROM-backup Size (KB)
0000	32	0
0011	0	32
1000	0	32
1001	8	24
1011	32	0

1. FCCOB5[7:4] = 0000

Table 8. Valid FlexNVM partition codes : 128 KB , 256 KB, 512 KB and 1MB configurations with 64 KB FlexNVM

FlexNVM Partition Code DEPART (FCCOB5[3:0]) ¹	Data flash Size (KB)	EEPROM-backup Size (KB)
0000	64	0
0011	32	32
0100	0	64
1000	0	0
1010	16	48
1011	32	32
1100	64	0

1. FCCOB5[7:4] = 0000

NOTE

For the 2M configuration (where DFlash is implemented in multiple blocks) the FlexNVM may only be configured into: all Data flash, or 64 KB emulated EEPROM backup with the remainder left as Data Flash. Thus there are only three valid values for DEPART (FCCOB5[3:0]) : either 4'b0100 (64 KB emulated EEPROM, remainder is DFlash) or 4'b0000, 4'b1111 (0 KB emulated EEPROM/all DFlash).

Table 9. Valid FlexNVM partition codes: 2 MB configurations

FlexNVM Partition Code DEPART (FCCOB5[3:0]) ¹	Data flash Size (KB)	EEPROM-backup Size (KB)
0000	DFlash size (512 KB)	0
0100	DFlash size - EEPROM size (512 KB - 64 KB = 448 KB)	64
1111	DFlash size (512 KB)	0

1. FCCOB5[7:4] = 0000

After clearing CCIF to launch the Program Partition command, the FTFC first verifies that the EEPROM Data Set Size Code and FlexNVM Partition Code in the data flash IFR are erased. If erased, the Program Partition operation command erases the contents of the FlexNVM memory. If the FlexNVM is to be partitioned for emulated EEPROM backup, the allocated emulated EEPROM backup sectors are formatted for emulated EEPROM use. Finally, the partition codes are programmed into the data flash IFR using the values provided. The Program Partition command also verifies that the partition codes read back correctly after programming. The CCIF flag is set after the Program Partition operation operation completes.

Prior to launching the Program Partition command, the data flash IFR must be in an erased state, which can be accomplished by executing the Erase All Blocks or Erase All Blocks Unsecure commands or by an external request (see Triggering an erase all external to the flash module).

Table 10. Program Partition command error handling

Error Condition	Error Bit
Command not available in current mode/security	FSTAT[ACCERR]
The EEPROM data size and FlexNVM partition code bytes are not initially 0xFFFF	FSTAT[ACCERR]
Invalid EEPROM Data Set Size Code is entered (see Table 6 for valid codes)	FSTAT[ACCERR]
Invalid FlexNVM Partition Code is entered (see Table 7 for valid codes)	FSTAT[ACCERR]
FlexNVM Partition Code = full data flash (no emulated EEPROM) and EEPROM Data Set Size Code allocates FlexRAM for emulated EEPROM	FSTAT[ACCERR]
FlexNVM Partition Code allocates space for emulated EEPROM backup, but EEPROM Data Set Size Code allocates no FlexRAM for emulated EEPROM	FSTAT[ACCERR]
FCCOB1[6:0] > 0x3	FSTAT[ACCERR]
FCCOB1[6:0] > 0 for non-CSEc enabled parts	FSTAT[ACCERR]
FCCOB1[6:0] > 0, when EEPROM-backup Size is 0	FSTAT[ACCERR]
FCCOB1[6:0] > 0, when SFE = 1	FSTAT[ACCERR]
FCCOB1[6:0] > 0, when FCCOB3[0] = 1	FSTAT[ACCERR]
FCCOB4[7:4] != 0000	FSTAT[ACCERR]
FCCOB5[7:4] != 0000	FSTAT[ACCERR]
Any errors have been encountered during the verify operation	FSTAT[MGSTAT0]

Chapter 4

CMD_VERIFY_MAC

The Verify MAC command verifies a MAC of a given MESSAGE, which can be multiple 128-bit blocks of data, against a provided for MAC. The MESSAGE to compare, starting with the leftmost bit of the MAC, are given in the MESSAGE_LENGTH. A MAC_LENGTH value of 0 is interpreted by SHE to compare all bits of the MAC. The function returns an error if the length provided for message has another length than stated in MESSAGE_LENGTH. Input DATA1-DATAn until all messages are entered, with the expected MAC being the last entry after all DATA are input, i.e., MAC will be the position of block N+1 for 'N' number of DATA blocks. The provided MAC_LENGTH must be greater than or equal to the minimum MAC length set by the PGMPART command. Failure to meet this condition will result in an ERC_GENERAL_ERROR.

All padding is to be done according to SHE specification using MESSAGE_LENGTH.

$$n = \text{CEIL}(\text{MESSAGE_LENGTH} / 128)$$

The first example shows 6 DATA blocks followed by the expected MAC, with the output overwriting the DATA1 block at the end of the operation with the MAC verification status.

The continuation examples show DATA1-10 by continuing from the first example but DATA7 would be written in place of the CMAC from the first example, followed by continuation with DATA8 which follows on the next page. Finally ending in DATA10 for this example, following with the expected CMAC value after the DATA 10 entry.

Table 11. Verify MAC command details

Parameter	Direction	Width
KEY_ID	IN	5
MESSAGE_LENGTH	IN	32
MESSAGE (DATA <n>)	IN	n * 128
MAC	IN	128
MAC_LENGTH (MAC Length[6:0])	IN	7
VERIFICATION_STATUS (Verification Status[0])	OUT	1
$\text{MAC}_{\text{calc}} = \text{TRUNCATE}(\text{CMAC}_{\text{KEY, KEY_ID}}(\text{MESSAGE}, \text{MESSAGE_LENGTH}), \text{MAC_LENGTH})$ $\text{MAC}_{\text{ref}} = \text{TRUNCATE}(\text{MAC}, \text{MAC_LENGTH})$ $\text{VERIFICATION_STATUS} = (0 \sim (\text{MAC}_{\text{calc}} - \text{MAC}_{\text{ref}}))$		
Error Codes: ERC_NO_ERROR, ERC_SEQUENCE_ERROR, ERC_KEY_NOT_AVAILABLE, ERC_KEY_INVALID, ERC_KEY_EMPTY, ERC_MEMORY_FAILURE, ERC_BUSY, ERC_GENERAL_ERROR		

Figure 1. Verify MAC input parameters

	3	2	1	0	7	6	5	4	B	A	9	8	F	E	D	C
0	0x06	0x00	0x00	Keyl D	Error Bits		Reserved		MAC Length		Reserved		MESSAGE_LENGTH			
1	DATA 1															
2	DATA 2															

Table continues on the next page...

Table continued from the previous page...

	3	2	1	0	7	6	5	4	B	A	9	8	F	E	D	C
3	DATA 3															
4	DATA 4															
5	DATA 5															
6	DATA 6															
7	MAC															

Figure 2. Verify MAC output parameters

	3	2	1	0	7	6	5	4	B	A	9	8	F	E	D	C
0	0x06	0x00	0x00	Keyl D	Error Bits		Reserved		MAC Length		Reserved		MESSAGE_LENGTH			
1					Verification Status	DATA 1										
2	DATA 2															
3	DATA 3															
4	DATA 4															
5	DATA 5															
6	DATA 6															
7	MAC															

Figure 3. Continuation of input parameters

	3	2	1	0	7	6	5	4	B	A	9	8	F	E	D	C
0	0x06	0x00	0x01	Keyl D	Error Bits		Reserved		MAC Length		Reserved		MESSAGE_LENGTH			
1	DATA 8															
2	DATA 9															
3	DATA 10															
4	MAC															
5																
6																
7																

Table continues on the next page...

	3	2	1	0	7	6	5	4	B	A	9	8	F	E	D	C
--	---	---	---	---	---	---	---	---	---	---	---	---	---	---	---	---

Figure 4. Continuation of output parameters

	3	2	1	0	7	6	5	4	B	A	9	8	F	E	D	C
0	0x06	0x00	0x01	Keyl D	Error Bits		Reserved		MAC Length		Reserved		MESSAGE_LENGTH			
1					Verification Status	Data 8										
2	DATA 9															
3	DATA 10															
4	MAC															
5																
6																
7																

Chapter 5

Program Partition command

The Program Partition command prepares the FlexNVM block for use as data flash, emulated EEPROM backup data memory, or a combination of both and initializes the FlexRAM. The Program Partition command must not be launched from flash memory, since flash memory resources are not accessible during Program Partition command execution. After partitioning for emulated EEPROM activity, the flash module must be reset before any emulated EEPROM activity can be performed.

The Program Partition command is expected to be run on fresh parts before other FTFM and CSEc commands are launched.

CAUTION

While different partitions of the FlexNVM are available, the intention is that a single partition choice is used throughout the entire lifetime of a given application. The FlexNVM Partition Code choices affect the endurance and data retention characteristics of the device.

Interrupting a Program Partition operation (due to power loss, reset, supplies out of specified operational ranges, or any other reasons) can leave the partition codes in an indeterminate state. The user must take appropriate counter measures to prevent data loss in case of an interrupted Program Partition operation.

Table 12. Program Partition command FCCOB requirements

FCCOB Number	FCCOB Contents [7:0]
0	0x80 (PGMPART)
1	MAC Length Provision, CSEc Key Size
2	SFE
3	EEERST - FlexRAM load during reset option (only bit 0 used): 0 - FlexRAM loaded with valid EEPROM data during reset sequence 1 - FlexRAM not loaded during reset sequence unless CSEc feature is enabled
4	EEPROM Data Set Size Code
5	FlexNVM Partition Code
6	BKRON - Boot Key Restriction On (only bit 0 used): 0 - Keys with boot protection enabled are accessible when Secure Boot is not enabled 1 - Keys with boot protection enabled are not accessible when Secure Boot is not enabled or Secure Boot failed
7	Minimum MAC Length for CMD_VERIFY_MAC command: 0x0 - 128-bits 0x1 to 0x7F - 1 to 127-bits

Table 13. Valid CSEc/SHE user key size

Key Size Code KEYSIZE (FCCOB1[2:0]) ¹	Number of Flash Keys {MASTER_ECU_KEY, BOOT_MAC_KEY, BOOT_MAC, KEY_<n>}	Number of Bytes Allocated (subtracts from the total FlexRAM space)
000	0	0
001	1 to 5	128
010	1 to 10	256
011	1 to 20	512

1. FCCOB1 [6:3] = 00000

For non-CSEc enabled parts, the number of User Keys must be configured as 2'b00 (no keys).

For non-CSEc enabled parts, the number of Flash Keys must be set to 0 (no keys). The BKRON value in FCCOB6 is ignored and left unprogrammed/erased (1'b1) if the CSEc Key Size is 0.

For CSEc enabled parts, the number of Flash Keys is user configurable and the allocated space will assume that the MASTER_ECU_KEY, BOOT_MAC_KEY and BOOT_MAC are there if any keys are enabled. These keys will occupy 3 key slots of the allocated space leaving up to 20 key slots available for user keys (KEY_<n>).

NOTE

For CSEc enabled parts, once Flash Keys are allocated (regardless of being initialized or not), the SHE spec requirement of not erasing Flash Keys without authentication will apply. This will mean Authentication (DBG_CHAL and DBG_AUTH) commands must be run and pass (removing all Flash Keys) before erase of the FlexNVM (all Flash Keys are backed up in EFlash). Thus, the Erase All Blocks and Erase All Blocks Unsecure commands will not work, nor will the Erase Flash Block command if the FlexNVM is selected. Additionally if any Flash Keys are write protected, they cannot be erased/removed, thus the FlexNVM cannot be erased and the Authentication process will not pass.

Table 14. Security Flag Extension (SFE)

Security Flag Extension Code SFE (FCCOB2[7:0]) ¹	Results
SFE == 0x00	User Key 'Verify Only' attribute not enabled
0x00	User Key 'Verify Only' attribute enabled

1. FCCOB2[7:1] is ignored

The enhanced Security Flag Extension (SFE) feature is an extension to the SHE specification. For standard SHE usage model, the user should configure this feature as 'not enabled' (SFE set to 0x00). This addition is to provide capability to flag a key as 'VERIFY_ONLY'. That is, the user can configure SFE set to 0x01 and then use the LOAD_KEY command to add a new attribute to the key which would tell the GENERATE_MAC command that the key is to be used only by the VERIFY_MAC command (by configuring SFE as 'enabled' and then using LOAD_KEY to set the new VERIFY_ONLY attribute on that key).

The VERIFY_ONLY attribute has no effect if the KEY_USAGE attribute is '0'.

See the CMD_LOAD_KEY command for more information on the new attribute.

When FCCOB1[7] equals 0x1, the content of FCCOB7[6:0] sets the minimum MAC length for VERIFY_MAC commands for both data and pointer methods (FCCOB7[7] is ignored). A value of 0x0 is interpreted as 128-bits, while values 0x1 to 0x7F are directly interpreted as 1 to 127-bits.

When FCCOB1[7] equals 0x0, the value of FCCOB7 is ignored, instead using 1-bit as the minimum MAC length for VERIFY_MAC commands.

Table 15. Valid emulated EEPROM data set size codes

EEPROM Data Set Size Code (FCCOB4) EEESIZE (FCCOB4[3:0]) ¹	EEPROM Data Set Size (KB)
0010	4
1111	0 ²

1. FCCOB4[7:4] = 0000
2. EEPROM Data Set Size must be set to 0 Bytes when the FlexNVM Partition Code is set for no EEPROM.

Table 16. Valid FlexNVM partition codes

FlexNVM Partition Code DEPART (FCCOB5[3:0]) ¹	Data flash Size (KB)	EEPROM-backup Size (KB)
0000	64	0
0011	32	32
0100	0	64
1000	0	64
1010	16	48
1011	32	32
1100	64	0

1. FCCOB5[7:4] = 0000

After clearing CCIF to launch the Program Partition command, the FTFM first verifies that the EEPROM Data Set Size Code and FlexNVM Partition Code in the data flash IFR are erased. If erased, the Program Partition command erases the contents of the FlexNVM memory. If the FlexNVM is to be partitioned for emulated EEPROM backup, the allocated emulated EEPROM backup sectors are formatted for emulated EEPROM use. Finally, the partition codes are programmed into the data flash IFR using the values provided. The Program Partition command also verifies that the partition codes read back correctly after programming. The CCIF flag is set after the Program Partition operation completes.

Prior to launching the Program Partition command, the data flash IFR must be in an erased state, which can be accomplished by executing the Erase All Blocks Unsecure command or by an external request (see Triggering an erase all external to the flash module).

Table 17. Program Partition command error handling

Error Condition	Error Bit
Command not available in current mode/security	FSTAT[ACCERR]
Invalid Key Size Code is entered (see Table 13 for valid codes)	FSTAT[ACCERR]
FCCOB1[6:3] != 00000	FSTAT[ACCERR]
FCCOB1[6:0] > 0 for non-CSEc enabled parts	FSTAT[ACCERR]
FCCOB1[6:0] > 0, when EEPROM-backup size is 0 KB	FSTAT[ACCERR]
FCCOB1[6:0] > 0, when SFE = 0x01	FSTAT[ACCERR]
FCCOB1[6:0] > 0, when FCCOB3[0] = 1	FSTAT[ACCERR]

Table continues on the next page...

Table 17. Program Partition command error handling (continued)

Error Condition	Error Bit
FCCOB3[0] = 1 for CSEc enabled parts with Flash Keys allocated	FSTAT[ACCERR]
The EEPROM data size and FlexNVM partition code bytes are not initially 0xFFFF	FSTAT[ACCERR]
Invalid EEPROM Data Set Size Code is entered (see Table 15 for valid codes)	FSTAT[ACCERR]
Invalid FlexNVM Partition Code is entered (see Table 16 for valid codes)	FSTAT[ACCERR]
FlexNVM Partition Code = full data flash (no emulated EEPROM) and EEPROM Data Set Size Code allocates FlexRAM for emulated EEPROM	FSTAT[ACCERR]
FlexNVM Partition Code allocates space for emulated EEPROM backup, but EEPROM Data Set Size Code allocates no FlexRAM for emulated EEPROM	FSTAT[ACCERR]
FCCOB4[7:4] != 0000	FSTAT[ACCERR]
FCCOB5[7:4] != 0000	FSTAT[ACCERR]
Any errors have been encountered during the verify operation	FSTAT[MGSTAT0]
An uncorrectable ECC fault was detected while reading command executable code	FSTAT[MGSTAT1]
An uncorrectable ECC fault was detected while reading the FlexRAM	FSTAT[MGSTAT1]

Chapter 6

CMD_VERIFY_MAC

The Verify MAC command verifies a MAC of a given MESSAGE, which can be multiple 128-bit blocks of data, against a provided for MAC. The MESSAGE to compare, starting with the leftmost bit of the MAC, are given in the MESSAGE_LENGTH. The value 0 is not allowed and is interpreted by SHE to compare all bits of the MAC. The function returns an error if the provided for message has another length than stated in MESSAGE_LENGTH. Input DATA1-DATAn until all messages are entered, with the expected MAC being the last entry after all DATA are input, i.e., MAC will be the position of block N+1 for 'N' number of DATA blocks. The provided MAC_LENGTH must be greater than or equal to the minimum MAC length set by the PGMPART command. Failure to meet this condition will result in an ERC_GENERAL_ERROR.

All padding is to be done according to SHE specification using MESSAGE_LENGTH.

$$n = \text{CIEL}(\text{MESSAGE_LENGTH} / 128)$$

The first example shows 6 DATA blocks followed by the expected MAC, with the output overwriting the DATA1 block at the end of the operation with the MAC verification status.

The continuation examples show DATA1-10 by continuing from the first example but DATA7 would be written in place of the CMAC from the first example, followed by continuation with DATA8 which follows on the next page. Finally ending in DATA10 for this example, following with the expected CMAC value after the DATA 10 entry.

Table 18. Verify MAC command details

Parameter	Direction	Width
KEY_ID	IN	5
MESSAGE_LENGTH	IN	32
MESSAGE	IN	n * 128
MAC	IN	128
MAC_LENGTH	IN	7
VERIFICATION_STATUS	OUT	1
$\text{MAC}_{\text{calc}} = \text{TRUNCATE}(\text{CMAC}_{\text{KEY, KEY_ID}}(\text{MESSAGE}, \text{MESSAGE_LENGTH}), \text{MAC_LENGTH})$ $\text{MAC}_{\text{ref}} = \text{TRUNCATE}(\text{MAC}, \text{MAC_LENGTH})$ $\text{VERIFICATION_STATUS} = (0 \sim= (\text{MAC}_{\text{calc}} - \text{MAC}_{\text{ref}}))$		
Error Codes: ERC_NO_ERROR, ERC_SEQUENCE_ERROR, ERC_KEY_NOT_AVAILABLE, ERC_KEY_INVALID, ERC_KEY_EMPTY, ERC_MEMORY_FAILURE, ERC_BUSY, ERC_GENERAL_ERROR		

Figure 5. Verify MAC input parameters

	0	1	2	3	4	5	6	7	8	9	A	B	C	D	E	F
0	0x06	0x00	0x00	Keyl D	Error Bits		Reserved		MAC Length		Reserved		MESSAGE_LENGTH			
1	DATA 1															
2	DATA 2															

Table continues on the next page...

Table continued from the previous page...

	0	1	2	3	4	5	6	7	8	9	A	B	C	D	E	F
3	DATA 3															
4	DATA 4															
5	DATA 5															
6	DATA 6															
7	MAC															

Figure 6. Verify MAC output parameters

	0	1	2	3	4	5	6	7	8	9	A	B	C	D	E	F
0	0x06	0x00	0x00	Keyl D	Error Bits		Reserved		MAC Length		Reserved		MESSAGE_LENGTH			
1					Verification Status		DATA 1 [6:15]									
2	DATA 2															
3	DATA 3															
4	DATA 4															
5	DATA 5															
6	DATA 6															
7	MAC															

Figure 7. Continuation of input parameters

	0	1	2	3	4	5	6	7	8	9	A	B	C	D	E	F
0	0x06	0x00	0x01	Keyl D	Error Bits		Reserved		MAC Length		Reserved		MESSAGE_LENGTH			
1	DATA 8															
2	DATA 9															
3	DATA 10															
4	MAC															
5																
6																
7																

Table continues on the next page...

	0	1	2	3	4	5	6	7	8	9	A	B	C	D	E	F
--	---	---	---	---	---	---	---	---	---	---	---	---	---	---	---	---

Figure 8. Continuation of output parameters

	0	1	2	3	4	5	6	7	8	9	A	B	C	D	E	F
0	0x06	0x00	0x01	Keyl D	Error Bits		Reserved		MAC Length		Reserved		MESSAGE_LENGTH			
1					Verification Status	Data 7 [6:15]										
2	DATA 9															
3	DATA 10															
4	MAC															
5																
6																
7																

Legal information

Definitions

Draft — A draft status on a document indicates that the content is still under internal review and subject to formal approval, which may result in modifications or additions. NXP Semiconductors does not give any representations or warranties as to the accuracy or completeness of information included in a draft version of a document and shall have no liability for the consequences of use of such information.

Disclaimers

Limited warranty and liability — Information in this document is believed to be accurate and reliable. However, NXP Semiconductors does not give any representations or warranties, expressed or implied, as to the accuracy or completeness of such information and shall have no liability for the consequences of use of such information. NXP Semiconductors takes no responsibility for the content in this document if provided by an information source outside of NXP Semiconductors.

In no event shall NXP Semiconductors be liable for any indirect, incidental, punitive, special or consequential damages (including - without limitation - lost profits, lost savings, business interruption, costs related to the removal or replacement of any products or rework charges) whether or not such damages are based on tort (including negligence), warranty, breach of contract or any other legal theory.

Notwithstanding any damages that customer might incur for any reason whatsoever, NXP Semiconductors' aggregate and cumulative liability towards customer for the products described herein shall be limited in accordance with the Terms and conditions of commercial sale of NXP Semiconductors.

Right to make changes — NXP Semiconductors reserves the right to make changes to information published in this document, including without limitation specifications and product descriptions, at any time and without notice. This document supersedes and replaces all information supplied prior to the publication hereof.

Applications — Applications that are described herein for any of these products are for illustrative purposes only. NXP Semiconductors makes no representation or warranty that such applications will be suitable for the specified use without further testing or modification.

Customers are responsible for the design and operation of their applications and products using NXP Semiconductors products, and NXP Semiconductors accepts no liability for any assistance with applications or customer product design. It is customer's sole responsibility to determine whether the NXP Semiconductors product is suitable and fit for the customer's applications and products planned, as well as for the planned application and use of customer's third party customer(s). Customers should provide appropriate design and operating safeguards to minimize the risks associated with their applications and products.

NXP Semiconductors does not accept any liability related to any default, damage, costs or problem which is based on any weakness or default in the customer's applications or products, or the application or use by customer's third party customer(s). Customer is responsible for doing all necessary testing for the customer's applications and products using NXP Semiconductors products in order to avoid a default of the applications and the products or of the application or use by customer's third party customer(s). NXP does not accept any liability in this respect.

Terms and conditions of commercial sale — NXP Semiconductors products are sold subject to the general terms and conditions of commercial sale, as published at <http://www.nxp.com/profile/terms>, unless otherwise agreed in a valid written individual agreement. In case an individual agreement is concluded only the terms and conditions of the respective agreement shall apply. NXP Semiconductors hereby expressly objects to applying the customer's general terms and conditions with regard to the purchase of NXP Semiconductors products by customer.

Export control — This document as well as the item(s) described herein may be subject to export control regulations. Export might require a prior authorization from competent authorities.

Translations — A non-English (translated) version of a document, including the legal information in that document, is for reference only. The English version shall prevail in case of any discrepancy between the translated and English versions.

Security — Customer understands that all NXP products may be subject to unidentified vulnerabilities or may support established security standards or specifications with known limitations. Customer is responsible for the design and operation of its applications and products throughout their lifecycles to reduce the effect of these vulnerabilities on customer's applications and products. Customer's responsibility also extends to other open and/or proprietary technologies supported by NXP products for use in customer's applications. NXP accepts no liability for any vulnerability. Customer should regularly check security updates from NXP and follow up appropriately.

Customer shall select products with security features that best meet rules, regulations, and standards of the intended application and make the ultimate design decisions regarding its products and is solely responsible for compliance with all legal, regulatory, and security related requirements concerning its products, regardless of any information or support that may be provided by NXP.

NXP has a Product Security Incident Response Team (PSIRT) (reachable at PSIRT@nxp.com) that manages the investigation, reporting, and solution release to security vulnerabilities of NXP products.

Suitability for use in automotive applications (functional safety) — This NXP product has been qualified for use in automotive applications. It has been developed in accordance with ISO 26262, and has been ASIL classified accordingly. If this product is used by customer in the development of, or for incorporation into, products or services (a) used in safety critical applications or (b) in which failure could lead to death, personal injury, or severe physical or environmental damage (such products and services hereinafter referred to as "Critical Applications"), then customer makes the ultimate design decisions regarding its products and is solely responsible for compliance with all legal, regulatory, safety, and security related requirements concerning its products, regardless of any information or support that may be provided by NXP. As such, customer assumes all risk related to use of any products in Critical Applications and NXP and its suppliers shall not be liable for any such use by customer. Accordingly, customer will indemnify and hold NXP harmless from any claims, liabilities, damages and associated costs and expenses (including attorneys' fees) that NXP may incur related to customer's incorporation of any product in a Critical Application.

NXP B.V. — NXP B.V. is not an operating company and it does not distribute or sell products.

Trademarks

Notice: All referenced brands, product names, service names, and trademarks are the property of their respective owners.

NXP — wordmark and logo are trademarks of NXP B.V.

AMBA, Arm, Arm7, Arm7TDMI, Arm9, Arm11, Artisan, big.LITTLE, Cordio, CoreLink, CoreSight, Cortex, DesignStart, DynamIQ, Jazelle, Keil, Mali, Mbed, Mbed Enabled, NEON, POP, RealView, SecurCore, Socrates, Thumb, TrustZone, ULINK, ULINK2, ULINK-ME, ULINK-PLUS, ULINKpro, μ Vision, Versatile — are trademarks and/or registered trademarks of Arm Limited (or its subsidiaries or affiliates) in the US and/or elsewhere. The related technology may be protected by any or all of patents, copyrights, designs and trade secrets. All rights reserved.

I2C-bus — logo is a trademark of NXP B.V.

NXP SECURE CONNECTIONS FOR A SMARTER WORLD — is a trademark of NXP B.V.

SafeAssure — is a trademark of NXP B.V.

SafeAssure — logo is a trademark of NXP B.V.



© NXP B.V. 2024.

All rights reserved.

For more information, please visit: <http://www.nxp.com>

For sales office addresses, please send an email to: salesaddresses@nxp.com

Date of release: 01/2024

Document identifier: S32K1xxRMAD

S32K1xx Series Reference Manual

Supports S32K116, S32K118, S32K142, S32K142W, S32K144,
S32K144W, S32K146, and S32K148

Document Number: S32K1XXRM
Rev. 14, 09/2021





Contents

Section number	Title	Page
Chapter 1		
About This Manual		
1.1	Audience.....	51
1.2	Organization.....	51
1.3	Module descriptions.....	51
1.3.1	Example: chip-specific information that clarifies content in the same chapter.....	52
1.3.2	Example: chip-specific information that refers to a different chapter.....	53
1.4	Register descriptions.....	54
1.5	Conventions.....	55
1.5.1	Notes, Cautions, and Warnings.....	55
1.5.2	Numbering systems.....	55
1.5.3	Typographic notation.....	56
1.5.4	Special terms.....	56
Chapter 2		
Introduction		
2.1	Overview.....	59
2.2	S32K1xx Series introduction.....	59
2.2.1	S32K14x.....	59
2.2.2	S32K14xW.....	61
2.2.3	S32K11x	62
2.3	Feature summary.....	62
2.4	Block diagram.....	66
2.5	Feature comparison.....	68
2.5.1	Differences between S32K14x/S32K14xW, and S32K11x.....	70
2.6	Applications.....	71
2.7	Module functional categories.....	72
2.7.1	Arm Cortex-M4F Core Modules.....	73
2.7.2	Arm Cortex-M0+ Core Modules.....	74

Section number	Title	Page
2.7.3	System modules.....	74
2.7.4	Memories and memory interfaces.....	75
2.7.5	Power Management.....	76
2.7.6	Clocking.....	76
2.7.7	Analog modules.....	77
2.7.8	Timer modules.....	77
2.7.9	Communication interfaces.....	78
2.7.10	Debug modules.....	79

Chapter 3 Memory Map

3.1	Introduction.....	81
3.2	SRAM memory map.....	81
3.2.1	S32K14x: SRAM memory map	81
3.2.2	S32K11x: SRAM memory map	81
3.3	Flash memory map.....	82
3.4	Peripheral bridge (AIPS-Lite) memory map.....	82
3.4.1	Read-after-write sequence and required serialization of memory operations.....	83
3.5	Private Peripheral Bus (PPB) memory map.....	84
3.6	Aliased bit-band regions for CM4 core.....	85

Chapter 4 Signal Multiplexing and Pin Assignment

4.1	Introduction.....	87
4.2	Functional description.....	87
4.3	Pad description.....	88
4.4	Default pad state.....	89
4.5	Signal Multiplexing sheet.....	90
4.5.1	IO Signal Table	90
4.5.2	Input muxing table.....	92
4.6	Pinout diagrams.....	93

Section number	Title	Page
Chapter 5		
Security Overview		
5.1	Introduction.....	95
5.2	Device security.....	95
5.2.1	Flash memory security.....	95
5.2.2	Cryptographic Services Engine (CSEc) security features.....	96
5.2.3	Device Boot modes.....	97
5.3	Security use case examples.....	97
5.3.1	Secure boot: check bootloader for integrity and authenticity.....	97
5.3.2	Chain of trust: check flash memory for integrity and authenticity.....	98
5.3.3	Secure communication.....	99
5.3.4	Component protection.....	100
5.3.5	Message-authentication example.....	101
5.4	Steps required before failure analysis.....	102
5.5	Security programming flow example (Secure Boot).....	103
Chapter 6		
Safety Overview		
6.1	Introduction.....	105
6.2	S32K1xx safety concept.....	106
6.2.1	Cortex-M4/M0+ Structural Core Self Test (SCST).....	107
6.2.2	ECC on RAM and flash memory.....	108
6.2.3	Power supply monitoring.....	108
6.2.4	Clock monitoring.....	109
6.2.5	Temporal protection.....	109
6.2.6	Operational interference protection.....	109
6.2.7	CRC.....	111
6.2.8	Diversity of system resources.....	111
Chapter 7		
CM4 Overview		
7.1	Arm Cortex-M4F core configuration.....	113

Section number	Title	Page
7.1.1	Buses, interconnects, and interfaces.....	114
7.1.2	System Tick Timer.....	114
7.1.3	Debug facilities.....	114
7.1.4	Caches.....	115
7.1.5	Core privilege levels.....	115
7.2	Nested Vectored Interrupt Controller (NVIC) Configuration.....	116
7.2.1	Interrupt priority levels.....	116
7.2.2	Non-maskable interrupt.....	117
7.2.3	Determining the bitfield and register location for configuring a particular interrupt.....	117
7.3	Asynchronous Wake-up Interrupt Controller (AWIC) Configuration.....	118
7.3.1	Wake-up sources.....	118
7.4	FPU configuration.....	119
7.5	JTAG controller configuration.....	120

Chapter 8 CM0+ Overview

8.1	Arm Cortex-M0+ core introduction.....	121
8.1.1	Buses, interconnects, and interfaces.....	122
8.1.2	System tick timer.....	122
8.1.3	Debug facilities.....	122
8.1.4	Core privilege levels.....	122
8.2	Nested vectored interrupt controller (NVIC)	123
8.2.1	Interrupt priority levels.....	123
8.2.2	Non-maskable interrupt.....	123
8.2.3	Determining the bitfield and register location for configuring a particular interrupt.....	123
8.3	AWIC introduction.....	124
8.3.1	Wake-up sources.....	124

Chapter 9 Micro Trace Buffer (MTB)

9.1	Introduction.....	127
-----	-------------------	-----

Section number	Title	Page
9.1.1	Overview.....	127
9.1.2	Features.....	129
9.1.3	Modes of operation.....	130
9.2	Memory map and register definition.....	130
9.2.1	MTB_DWT Memory Map.....	131

Chapter 10 Miscellaneous Control Module (MCM)

10.1	Chip-specific MCM information.....	143
10.2	Introduction.....	144
10.2.1	Features.....	144
10.3	Memory map/register descriptions.....	144
10.3.1	Crossbar Switch (AXBS) Slave Configuration (MCM_PLASC).....	145
10.3.2	Crossbar Switch (AXBS) Master Configuration (MCM_PLAMC).....	146
10.3.3	Core Platform Control Register (MCM_CPCR).....	147
10.3.4	Interrupt Status and Control Register (MCM_ISCR).....	150
10.3.5	Process ID Register (MCM_PID).....	153
10.3.6	Compute Operation Control Register (MCM_CPO).....	154
10.3.7	Local Memory Descriptor Register (MCM_LMDR _n).....	155
10.3.8	Local Memory Descriptor Register2 (MCM_LMDR2).....	158
10.3.9	LMEM Parity and ECC Control Register (MCM_LMPECR).....	162
10.3.10	LMEM Parity and ECC Interrupt Register (MCM_LMPEIR).....	163
10.3.11	LMEM Fault Address Register (MCM_LMFAR).....	164
10.3.12	LMEM Fault Attribute Register (MCM_LMFATR).....	165
10.3.13	LMEM Fault Data High Register (MCM_LMFDHR).....	166
10.3.14	LMEM Fault Data Low Register (MCM_LMFDLR).....	166
10.4	Functional description.....	167
10.4.1	Interrupts.....	167

Chapter 11 System Integration Module (SIM)

Section number	Title	Page
11.1	Chip-specific SIM information.....	169
11.1.1	SIM register/bitfield implementation.....	169
11.2	Introduction.....	178
11.2.1	Features.....	178
11.3	Memory map and register definition.....	178
11.3.1	SIM register descriptions.....	179

Chapter 12 Port Control and Interrupts (PORT)

12.1	Chip-specific PORT information.....	205
12.1.1	Number of PCRs.....	205
12.1.2	Finding address for PORTx_PCRn	206
12.1.3	I/O configuration sequence	206
12.1.4	Digital input filter configuration sequence	207
12.1.5	Reset pin configuration	208
12.2	Introduction.....	208
12.2.1	Overview.....	208
12.2.2	Features.....	208
12.2.3	Modes of operation.....	209
12.3	External signal description.....	210
12.4	Detailed signal description.....	210
12.5	Memory map and register definition.....	210
12.5.1	Pin Control Register n (PORT_PCRn).....	213
12.5.2	Global Pin Control Low Register (PORT_GPCLR).....	216
12.5.3	Global Pin Control High Register (PORT_GPCHR).....	216
12.5.4	Global Interrupt Control Low Register (PORT_GICLR).....	217
12.5.5	Global Interrupt Control High Register (PORT_GICHR).....	217
12.5.6	Interrupt Status Flag Register (PORT_ISFR).....	218
12.5.7	Digital Filter Enable Register (PORT_DFER).....	219
12.5.8	Digital Filter Clock Register (PORT_DFRCR).....	219

Section number	Title	Page
12.5.9	Digital Filter Width Register (PORT_DFWR).....	220
12.6	Functional description.....	220
12.6.1	Pin control.....	220
12.6.2	Global pin control.....	221
12.6.3	Global interrupt control.....	222
12.6.4	External interrupts.....	222
12.6.5	Digital filter.....	223

Chapter 13 General-Purpose Input/Output (GPIO)

13.1	Chip-specific GPIO information.....	225
13.1.1	Instantiation information.....	225
13.1.2	GPIO ports memory map.....	225
13.1.3	GPIO register reset values	226
13.2	Introduction.....	226
13.2.1	Features.....	227
13.2.2	Modes of operation.....	227
13.2.3	GPIO signal descriptions.....	227
13.3	Memory map and register definition.....	228
13.3.1	GPIO register descriptions.....	228
13.4	Functional description.....	236
13.4.1	General-purpose input.....	236
13.4.2	General-purpose output.....	236

Chapter 14 Crossbar Switch Lite (AXBS-Lite)

14.1	Chip-specific AXBS-Lite information.....	239
14.1.1	Crossbar Switch master assignments.....	239
14.1.2	Crossbar Switch slave assignments.....	239
14.2	Introduction.....	240
14.2.1	Features.....	240

Section number	Title	Page
14.3	Functional Description.....	241
14.3.1	General operation.....	241
14.3.2	Arbitration.....	241
14.4	Initialization/application information.....	243

Chapter 15 Memory Protection Unit (MPU)

15.1	Chip-specific MPU information.....	245
15.1.1	MPU Slave Port Assignments.....	245
15.1.2	MPU Logical Bus Master Assignments.....	246
15.1.3	Current PID.....	246
15.1.4	Region descriptors and slave port configuration.....	246
15.2	Introduction.....	247
15.3	Overview.....	247
15.3.1	Block diagram.....	247
15.3.2	Features.....	248
15.4	MPU register descriptions.....	249
15.4.1	MPU memory map.....	250
15.4.2	Control/Error Status Register (CESR).....	252
15.4.3	Error Address Register, slave port n (EAR0 - EAR4).....	254
15.4.4	Error Detail Register, slave port n (EDR0 - EDR4).....	256
15.4.5	Region Descriptor n, Word 0 (RGD0_WORD0 - RGD15_WORD0).....	257
15.4.6	Region Descriptor 0, Word 1 (RGD0_WORD1).....	258
15.4.7	Region Descriptor 0, Word 2 (RGD0_WORD2).....	259
15.4.8	Region Descriptor 0, Word 3 (RGD0_WORD3).....	262
15.4.9	Region Descriptor n, Word 1 (RGD1_WORD1 - RGD15_WORD1).....	264
15.4.10	Region Descriptor n, Word 2 (RGD1_WORD2 - RGD15_WORD2).....	265
15.4.11	Region Descriptor n, Word 3 (RGD1_WORD3 - RGD15_WORD3).....	268
15.4.12	Region Descriptor Alternate Access Control 0 (RGDAAC0).....	269
15.4.13	Region Descriptor Alternate Access Control n (RGDAAC1 - RGDAAC15).....	272

Section number	Title	Page
15.5	Functional description.....	275
15.5.1	Access evaluation macro.....	275
15.5.2	Putting it all together and error terminations.....	277
15.5.3	Power management.....	277
15.6	Initialization information.....	278
15.7	Application information.....	278

Chapter 16 Peripheral Bridge (AIPS-Lite)

16.1	Chip-specific AIPS information.....	281
16.1.1	Instantiation information.....	281
16.1.2	Memory maps.....	281
16.2	Introduction.....	283
16.2.1	Features.....	283
16.2.2	General operation.....	283
16.3	Memory map/register definition.....	284
16.3.1	AIPS register descriptions.....	284
16.4	Functional description.....	328
16.4.1	Access support.....	328

Chapter 17 Direct Memory Access Multiplexer (DMAMUX)

17.1	Chip-specific DMAMUX information.....	329
17.1.1	Number of channels	329
17.1.2	DMA transfers via TRGMUX trigger.....	329
17.2	Introduction.....	330
17.2.1	Overview.....	330
17.2.2	Features.....	330
17.2.3	Modes of operation.....	331
17.3	Memory map/register definition.....	331
17.3.1	DMAMUX register descriptions.....	331

Section number	Title	Page
17.4	Functional description.....	333
17.4.1	DMA channels with periodic triggering capability.....	333
17.4.2	DMA channels with no triggering capability.....	336
17.4.3	Always-enabled DMA sources.....	336
17.5	Initialization/application information.....	337
17.5.1	Reset.....	337
17.5.2	Enabling and configuring sources.....	337

Chapter 18

Enhanced Direct Memory Access (eDMA)

18.1	Chip-specific eDMA information	341
18.1.1	Seamless eDMA transfer	341
18.1.2	Number of channels	342
18.2	Overview.....	342
18.2.1	Block diagram.....	342
18.2.2	Block parts.....	343
18.2.3	Features.....	344
18.3	Memory map/register definition.....	346
18.3.1	TCD memory.....	346
18.3.2	TCD initialization.....	346
18.3.3	TCD structure.....	346
18.3.4	Reserved memory and fields.....	347
18.3.5	DMA register descriptions.....	347
18.4	Functional description.....	396
18.4.1	Modes of operation.....	396
18.4.2	eDMA basic data flow.....	397
18.4.3	Fault reporting and handling.....	400
18.4.4	Channel preemption.....	402
18.5	Initialization/application information.....	403
18.5.1	eDMA initialization.....	403

Section number	Title	Page
18.5.2	Programming errors.....	405
18.5.3	Arbitration mode considerations.....	406
18.5.4	DMA transfer examples.....	406
18.5.5	Monitoring transfer descriptor status.....	410
18.5.6	Channel linking.....	411
18.5.7	Dynamic programming.....	413
18.5.8	Suspend/resume a DMA channel with active hardware service requests.....	416

Chapter 19 Trigger MUX Control (TRGMUX)

19.1	Chip-specific TRGMUX information.....	419
19.1.1	Module interconnectivity.....	419
19.1.2	TRGMUX register information.....	423
19.2	Introduction.....	423
19.3	Features.....	423
19.4	Memory map and register definition.....	424
19.4.1	TRGMUX register descriptions.....	424

Chapter 20 External Watchdog Monitor (EWM)

20.1	Chip-specific EWM information	463
20.1.1	EWM_OUT signal configuration.....	463
20.1.2	EWM Memory Map access.....	463
20.1.3	EWM low-power modes.....	463
20.2	Introduction.....	463
20.2.1	Features.....	464
20.2.2	Modes of Operation.....	464
20.2.3	Block Diagram.....	465
20.3	EWM Signal Descriptions.....	466
20.4	Memory Map/Register Definition.....	467
20.4.1	EWM register descriptions.....	467

Section number	Title	Page
20.5	Functional Description.....	472
20.5.1	The EWM_OUT_b Signal.....	472
20.5.2	EWM_OUT_b pin state in low power modes.....	473
20.5.3	The EWM_in Signal.....	473
20.5.4	EWM Counter.....	474
20.5.5	EWM Compare Registers.....	474
20.5.6	EWM Refresh Mechanism.....	474
20.5.7	EWM Interrupt.....	475
20.5.8	Counter clock prescaler.....	475

Chapter 21 Error Injection Module (EIM)

21.1	Chip-specific EIM information.....	477
21.1.1	EIM channel assignments.....	477
21.2	Introduction.....	477
21.2.1	Overview.....	477
21.2.2	Features.....	479
21.3	EIM register descriptions.....	479
21.3.1	EIM memory map.....	480
21.3.2	Error Injection Module Configuration Register (EIMCR).....	480
21.3.3	Error Injection Channel Enable register (EICHEN).....	481
21.3.4	Error Injection Channel Descriptor n, Word0 (EICHD0_WORD0 - EICHD1_WORD0).....	484
21.3.5	Error Injection Channel Descriptor n, Word1 (EICHD0_WORD1 - EICHD1_WORD1).....	486
21.4	Functional description.....	487
21.4.1	Error injection scenarios.....	487

Chapter 22 Error Reporting Module (ERM)

22.1	Chip-specific ERM information.....	489
22.1.1	Sources of memory error events.....	489
22.2	Introduction.....	489

Section number	Title	Page
22.2.1	Overview.....	489
22.2.2	Features.....	490
22.3	ERM register descriptions.....	490
22.3.1	ERM memory map.....	490
22.3.2	ERM Configuration Register 0 (CR0).....	491
22.3.3	ERM Status Register 0 (SR0).....	493
22.3.4	ERM Memory n Error Address Register (EAR0 - EAR1).....	495
22.4	Functional description.....	496
22.4.1	Single-bit correction events.....	496
22.4.2	Non-correctable error events.....	497
22.5	Initialization.....	498

Chapter 23 Watchdog timer (WDOG)

23.1	Chip-specific WDOG information.....	499
23.1.1	WDOG clocks.....	499
23.1.2	WDOG low-power modes.....	499
23.1.3	Default watchdog timeout	500
23.1.4	Watchdog Timeout Reaction.....	500
23.2	Introduction.....	501
23.2.1	Features.....	501
23.2.2	Block diagram.....	502
23.3	Memory map and register definition.....	502
23.3.1	WDOG register descriptions.....	502
23.4	Functional description.....	509
23.4.1	Clock source.....	509
23.4.2	Watchdog refresh mechanism.....	510
23.4.3	Configuring the Watchdog.....	511
23.4.4	Using interrupts to delay resets.....	512
23.4.5	Backup reset.....	513

Section number	Title	Page
23.4.6	Functionality in debug and low-power modes.....	513
23.4.7	Fast testing of the watchdog.....	514
23.5	Application Information.....	515
23.5.1	Disable Watchdog.....	515
23.5.2	Disable Watchdog after Reset.....	516
23.5.3	Configure Watchdog.....	516
23.5.4	Refreshing the Watchdog.....	517

Chapter 24

Cyclic Redundancy Check (CRC)

24.1	Chip-specific CRC information.....	519
24.2	Introduction.....	519
24.2.1	Features.....	519
24.2.2	Block diagram.....	520
24.2.3	Modes of operation.....	520
24.3	Memory map and register descriptions.....	520
24.3.1	CRC register descriptions.....	521
24.4	Functional description.....	525
24.4.1	CRC initialization/reinitialization.....	525
24.4.2	CRC calculations.....	525
24.4.3	Transpose feature.....	526
24.4.4	CRC result complement.....	528
24.5	Use cases.....	529
24.5.1	CRC Control Register programming.....	529
24.5.2	Expected read data fields.....	530

Chapter 25

Reset and Boot

25.1	Introduction.....	533
25.2	Reset.....	533
25.2.1	Power-on reset (POR).....	534

Section number	Title	Page
25.2.2	System reset sources.....	534
25.2.3	MCU Resets.....	538
25.2.4	Reset pin	538
25.2.5	Debug resets.....	539
25.3	Boot.....	540
25.3.1	Boot sources.....	540
25.3.2	FOPT boot options.....	540
25.3.3	Boot sequence.....	541

Chapter 26 Reset Control Module (RCM)

26.1	Chip-specific RCM information.....	543
26.1.1	RCM register information	543
26.2	Reset pin filter operation in STOP1/2 modes	544
26.3	Introduction.....	544
26.4	Reset memory map and register descriptions.....	544
26.4.1	Version ID Register (RCM_VERID).....	545
26.4.2	Parameter Register (RCM_PARAM).....	546
26.4.3	System Reset Status Register (RCM_SRS).....	548
26.4.4	Reset Pin Control register (RCM_RPC).....	551
26.4.5	Sticky System Reset Status Register (RCM_SSRS).....	553
26.4.6	System Reset Interrupt Enable Register (RCM_SRIE).....	555

Chapter 27 Clock Distribution

27.1	Introduction.....	559
27.2	High level clocking diagram.....	559
27.3	Clock definitions.....	560
27.4	Internal clocking requirements.....	562
27.4.1	Clock divider values after reset.....	567
27.4.2	HSRUN mode clocking.....	567

Section number	Title	Page
27.4.3	VLPR mode clocking.....	567
27.4.4	VLPR/VLPS mode entry.....	568
27.5	Clock Gating.....	568
27.6	Module clocks.....	568

Chapter 28 System Clock Generator (SCG)

28.1	Chip-specific SCG information.....	583
28.1.1	Register reset values.....	583
28.1.2	Supported frequency ranges.....	583
28.1.3	Oscillator and SPLL guidelines.....	584
28.1.4	System clock switching	584
28.1.5	System clock and clock monitor requirement	585
28.2	Introduction.....	585
28.2.1	Features.....	586
28.3	Memory Map/Register Definition.....	587
28.3.1	Version ID Register (SCG_VERID).....	588
28.3.2	Parameter Register (SCG_PARAM).....	588
28.3.3	Clock Status Register (SCG_CSR).....	589
28.3.4	Run Clock Control Register (SCG_RCCR).....	592
28.3.5	VLPR Clock Control Register (SCG_VCCR).....	594
28.3.6	HSRUN Clock Control Register (SCG_HCCR).....	596
28.3.7	SCG CLKOUT Configuration Register (SCG_CLKOUTCNFG).....	598
28.3.8	System OSC Control Status Register (SCG_SOSCCSR).....	600
28.3.9	System OSC Divide Register (SCG_SOSCDIV).....	602
28.3.10	System Oscillator Configuration Register (SCG_SOSCCFG).....	603
28.3.11	Slow IRC Control Status Register (SCG_SIRCCSR).....	604
28.3.12	Slow IRC Divide Register (SCG_SIRCDIV).....	605
28.3.13	Slow IRC Configuration Register (SCG_SIRCCFG).....	606
28.3.14	Fast IRC Control Status Register (SCG_FIRCCSR).....	607

Section number	Title	Page
28.3.15	Fast IRC Divide Register (SCG_FIRCDIV).....	609
28.3.16	Fast IRC Configuration Register (SCG_FIRCCFG).....	610
28.3.17	System PLL Control Status Register (SCG_SPLLCSR).....	611
28.3.18	System PLL Divide Register (SCG_SPLLDIV).....	613
28.3.19	System PLL Configuration Register (SCG_SPLLCFG).....	613
28.4	Functional description.....	615
28.4.1	SCG Clock Mode Transitions.....	615

Chapter 29 Peripheral Clock Controller (PCC)

29.1	Chip-specific PCC information.....	619
29.1.1	PCC register information.....	619
29.2	Introduction.....	624
29.3	Features.....	624
29.4	Functional description.....	625
29.5	Memory map and register definition.....	625
29.6	PCC register descriptions.....	625
29.6.1	PCC memory map.....	625
29.6.2	PCC FTFC Register (PCC_FTFC).....	627
29.6.3	PCC DMAMUX Register (PCC_DMAMUX).....	628
29.6.4	PCC FlexCAN0 Register (PCC_FlexCAN0).....	630
29.6.5	PCC FlexCAN1 Register (PCC_FlexCAN1).....	631
29.6.6	PCC FTM3 Register (PCC_FTM3).....	633
29.6.7	PCC ADC1 Register (PCC_ADC1).....	634
29.6.8	PCC FlexCAN2 Register (PCC_FlexCAN2).....	636
29.6.9	PCC LPSPI0 Register (PCC_LPSPI0).....	637
29.6.10	PCC LPSPI1 Register (PCC_LPSPI1).....	639
29.6.11	PCC LPSPI2 Register (PCC_LPSPI2).....	640
29.6.12	PCC PDB1 Register (PCC_PDB1).....	642
29.6.13	PCC CRC Register (PCC_CRC).....	644

Section number	Title	Page
29.6.14	PCC PDB0 Register (PCC_PDB0).....	645
29.6.15	PCC LPIT Register (PCC_LPIT).....	647
29.6.16	PCC FTM0 Register (PCC_FTM0).....	648
29.6.17	PCC FTM1 Register (PCC_FTM1).....	650
29.6.18	PCC FTM2 Register (PCC_FTM2).....	651
29.6.19	PCC ADC0 Register (PCC_ADC0).....	653
29.6.20	PCC RTC Register (PCC_RTC).....	655
29.6.21	PCC LPTMR0 Register (PCC_LPTMR0).....	656
29.6.22	PCC PORTA Register (PCC_PORTA).....	658
29.6.23	PCC PORTB Register (PCC_PORTB).....	660
29.6.24	PCC PORTC Register (PCC_PORTC).....	661
29.6.25	PCC PORTD Register (PCC_PORTD).....	663
29.6.26	PCC PORTE Register (PCC_PORTE).....	664
29.6.27	PCC SAI0 Register (PCC_SAI0).....	666
29.6.28	PCC SAI1 Register (PCC_SAI1).....	667
29.6.29	PCC FlexIO Register (PCC_FlexIO).....	669
29.6.30	PCC EWM Register (PCC_EWM).....	670
29.6.31	PCC LPI2C0 Register (PCC_LPI2C0).....	672
29.6.32	PCC LPI2C1 Register (PCC_LPI2C1).....	673
29.6.33	PCC LPUART0 Register (PCC_LPUART0).....	675
29.6.34	PCC LPUART1 Register (PCC_LPUART1).....	676
29.6.35	PCC LPUART2 Register (PCC_LPUART2).....	678
29.6.36	PCC FTM4 Register (PCC_FTM4).....	680
29.6.37	PCC FTM5 Register (PCC_FTM5).....	681
29.6.38	PCC FTM6 Register (PCC_FTM6).....	683
29.6.39	PCC FTM7 Register (PCC_FTM7).....	685
29.6.40	PCC CMP0 Register (PCC_CMP0).....	686
29.6.41	PCC QSPI Register (PCC_QSPI).....	688
29.6.42	PCC ENET Register (PCC_ENET).....	690

Section number	Title	Page
Chapter 30		
Clock Monitoring Unit (CMU)		
30.1	CMU chip-specific information.....	693
30.2	Introduction.....	694
30.2.1	Basic operation.....	695
30.2.2	Features.....	696
30.3	CMU_FC register descriptions.....	696
30.3.1	CMU_FC Memory map.....	696
30.3.2	Global Configuration Register (GCR).....	697
30.3.3	Reference Count Configuration Register (RCCR).....	698
30.3.4	High Threshold Configuration Register (HTCR).....	699
30.3.5	Low Threshold Configuration Register (LTCR).....	700
30.3.6	Status Register (SR).....	701
30.3.7	Interrupt Enable Register (IER).....	702
30.4	Functional description.....	705
30.4.1	Monitored clock lost.....	705
30.5	Programming guidelines.....	705
30.5.1	Programming HFREF and LFREF.....	705
30.5.2	Programming RCCR[REF_CNT].....	706
30.5.3	CMU_FC programming sequence.....	707
Chapter 31		
Memories and Memory Interfaces		
31.1	Introduction.....	709
31.2	Flash Memory Controller and flash memory modules.....	709
31.3	SRAM configuration.....	710
31.3.1	SRAM sizes.....	710
31.3.2	SRAM accessibility.....	711
31.3.3	SRAM arbitration and priority control.....	712
31.3.4	SRAM retention: power modes and resets.....	712

Section number	Title	Page
31.3.5	SRAM access: Behavior of device when in accessing a memory with multi-bit ECC error.....	713

Chapter 32 PRAM Controller (PRAMC)

32.1	PRAMC chip-specific information	715
32.2	Introduction.....	715
32.3	Memory map and register definition.....	716
32.4	Functional description.....	716
32.4.1	Error Correcting Code (ECC).....	716
32.4.2	Read/Write introduction.....	717
32.4.3	Reads.....	717
32.4.4	Writes.....	718
32.4.5	Late write hits.....	719
32.5	Initialization / application information.....	720

Chapter 33 Local Memory Controller (LMEM)

33.1	Chip-specific LMEM information	721
33.1.1	LMEM region description.....	721
33.1.2	LMEM SRAM sizes.....	721
33.2	Introduction.....	721
33.2.1	Block Diagram.....	722
33.2.2	Cache features.....	723
33.3	Memory Map/Register Definition.....	725
33.3.1	LMEM register descriptions.....	725
33.4	Functional Description.....	734
33.4.1	LMEM Function.....	734
33.4.2	SRAM Function.....	735
33.4.3	Cache Function.....	737
33.4.4	Cache Control.....	738

Chapter 34 Miscellaneous System Control Module (MSCM)

Section number	Title	Page
34.1	Chip-specific MSCM information.....	743
34.1.1	Chip-specific TMLSZ/TMUSZ information.....	743
34.1.2	Chip-specific register information.....	743
34.2	Overview.....	744
34.3	Chip Configuration and Boot.....	744
34.4	MSCM Memory Map/Register Definition.....	745
34.4.1	CPU Configuration Memory Map and Registers.....	745
34.4.2	MSCM register descriptions.....	745

Chapter 35 Flash Memory Controller (FMC)

35.1	Chip-specific FMC information.....	777
35.1.1	FMC masters.....	777
35.1.2	Program flash and Data flash port width.....	778
35.1.3	ECC Implementation for NVM	778
35.2	Introduction.....	778
35.2.1	Overview.....	778
35.2.2	Features.....	779
35.3	Modes of operation.....	780
35.4	External signal description.....	780
35.5	Functional description.....	780
35.5.1	Default configuration.....	780
35.5.2	Speculative reads.....	780
35.6	Initialization and application information.....	781

Chapter 36 Flash Memory Module (FTFC)

36.1	Chip-specific FTFC information.....	783
36.1.1	Flash memory types.....	784
36.1.2	Flash memory sizes.....	784
36.1.3	Flash memory map.....	803

Section number	Title	Page
36.1.4	Flash memory security.....	804
36.1.5	Power mode restrictions on flash memory programming.....	804
36.1.6	Flash memory modes.....	804
36.1.7	Erase all contents of flash memory.....	804
36.1.8	Customize MCU operations via FTFC_FOFT register.....	805
36.1.9	Simultaneous operations on PFLASH read partitions	805
36.2	Introduction.....	805
36.2.1	Features.....	806
36.2.2	Block diagram.....	808
36.2.3	Glossary.....	809
36.3	External signal description.....	811
36.4	Memory map and registers.....	812
36.4.1	Flash configuration field description.....	812
36.4.2	Program flash 0 IFR map.....	812
36.4.3	Data flash 0 IFR map.....	813
36.4.4	Register descriptions.....	814
36.5	Functional description.....	832
36.5.1	Flash protection.....	832
36.5.2	FlexNVM description.....	834
36.5.3	Interrupts.....	837
36.5.4	Flash operation in low-power modes.....	838
36.5.5	Functional modes of operation.....	838
36.5.6	Flash memory reads and ignored writes.....	838
36.5.7	Read while write (RWW).....	839
36.5.8	Flash program and erase.....	839
36.5.9	FTFC command operations.....	839
36.5.10	Margin read commands.....	846
36.5.11	Flash command descriptions.....	847
36.5.12	Security.....	873

Section number	Title	Page
36.5.13	Cryptographic Services Engine (CSEc).....	875
36.5.14	Reset sequence.....	913

Chapter 37 Flash Memory Module (FTFM)

37.1	Chip-specific FTFM information	915
37.2	Introduction.....	915
37.2.1	Features.....	916
37.2.2	Block diagram.....	918
37.2.3	Glossary.....	918
37.3	External signal description.....	920
37.4	Memory map and registers.....	921
37.4.1	Flash configuration field description.....	921
37.4.2	Program flash 0 IFR map.....	922
37.4.3	Data flash 0 IFR map.....	922
37.4.4	Register descriptions.....	923
37.5	Functional description.....	944
37.5.1	Flash protection.....	944
37.5.2	FlexMemory description.....	946
37.5.3	Interrupts.....	950
37.5.4	Flash operation in low-power modes.....	950
37.5.5	Flash memory reads and ignored writes.....	951
37.5.6	Read while write (RWW).....	951
37.5.7	Flash program and erase.....	952
37.5.8	Flash command operations.....	952
37.5.9	Flash command descriptions.....	960
37.5.10	Security.....	985
37.5.11	Cryptographic Services Engine (CSEc).....	987
37.5.12	Reset sequence.....	1026

Chapter 38

Section number	Title	Page
Quad Serial Peripheral Interface (QuadSPI)		
38.1	Chip-specific QuadSPI information.....	1029
38.1.1	Overview.....	1029
38.1.2	Memory size requirement	1029
38.1.3	QuadSPI register reset values.....	1030
38.1.4	Use case.....	1030
38.1.5	Supported read modes.....	1030
38.1.6	External memory options.....	1031
38.1.7	Recommended software configuration.....	1031
38.1.8	Recommended programming sequence.....	1032
38.1.9	Clock ratio between QuadSPI clocks	1032
38.1.10	QuadSPI_MCR[SCLKCFG] implementation	1032
38.1.11	QuadSPI_SOCCR[SOC CFG] implementation	1033
38.2	Introduction.....	1035
38.2.1	Features.....	1035
38.2.2	Block Diagram.....	1036
38.2.3	QuadSPI Modes of Operation.....	1037
38.2.4	Acronyms and Abbreviations.....	1038
38.2.5	Glossary for QuadSPI module.....	1038
38.3	External Signal Description.....	1040
38.3.1	Driving External Signals.....	1041
38.4	Memory Map and Register Definition.....	1043
38.4.1	Register Write Access.....	1043
38.4.2	Peripheral Bus Register Descriptions.....	1044
38.4.3	Serial Flash Address Assignment.....	1088
38.5	Flash memory mapped AMBA bus.....	1089
38.5.1	AHB Bus Access Considerations.....	1090
38.5.2	Memory Mapped Serial Flash Data - Individual Flash Mode on Flash A.....	1090
38.5.3	Memory Mapped Serial Flash Data - Individual Flash Mode on Flash B.....	1091

Section number	Title	Page
38.5.4	AHB RX Data Buffer (QSPI_ARDB0 to QSPI_ARDB31).....	1092
38.6	Interrupt Signals.....	1095
38.7	Functional Description.....	1095
38.7.1	Serial Flash Access Schemes.....	1095
38.7.2	Normal Mode.....	1096
38.7.3	HyperRAM Support.....	1115
38.8	Initialization/Application Information.....	1116
38.8.1	Power Up and Reset.....	1116
38.8.2	Available Status/Flag Information.....	1116
38.8.3	Flash Device Selection.....	1119
38.8.4	DMA Usage.....	1119
38.9	Byte Ordering - Endianness.....	1123
38.9.1	Programming Flash Data.....	1124
38.9.2	Reading Flash Data into the RX Buffer.....	1124
38.9.3	Reading Flash Data into the AHB Buffer.....	1125
38.10	Driving Flash Control Signals in Single and Dual Mode.....	1126
38.11	Serial Flash Devices.....	1126
38.11.1	Example Sequences.....	1126
38.12	Sampling of Serial Flash Input Data.....	1132
38.12.1	Basic Description.....	1132
38.12.2	Supported read modes.....	1133
38.12.3	Data Strobe (DQS) sampling method.....	1136
38.13	Data Input Hold Requirement of Flash.....	1139

Chapter 39 Power Management

39.1	Introduction.....	1141
39.2	Power modes description.....	1141
39.3	Entering and exiting power modes.....	1143
39.4	Clocking modes.....	1143

Section number	Title	Page
39.4.1	Clock gating.....	1143
39.4.2	Stop mode options.....	1143
39.4.3	DMA wake-up.....	1144
39.4.4	Compute Operation (CPO).....	1145
39.4.5	Peripheral Doze.....	1146
39.5	Power mode transitions.....	1147
39.6	Shutdown sequencing for power modes.....	1148
39.7	Power mode restrictions on flash memory programming.....	1148
39.8	Module operation in available power modes.....	1149
39.9	QuadSPI, Ethernet, and SAI operation	1152

Chapter 40 System Mode Controller (SMC)

40.1	Introduction.....	1153
40.2	Modes of operation.....	1153
40.3	Memory map and register descriptions.....	1155
40.3.1	SMC Version ID Register (SMC_VERID).....	1156
40.3.2	SMC Parameter Register (SMC_PARAM).....	1157
40.3.3	Power Mode Protection register (SMC_PMPROT).....	1158
40.3.4	Power Mode Control register (SMC_PMCTRL).....	1159
40.3.5	Stop Control Register (SMC_STOPCTRL).....	1161
40.3.6	Power Mode Status register (SMC_PMSTAT).....	1163
40.4	Functional description.....	1163
40.4.1	Power mode transitions.....	1164
40.4.2	Power mode entry/exit sequencing.....	1165
40.4.3	Run modes.....	1168
40.4.4	Stop modes.....	1170
40.4.5	Debug in low power modes.....	1171

Chapter 41 Power Management Controller (PMC)

Section number	Title	Page
41.1	Chip-specific PMC information	1173
41.2	Modes supported.....	1173
41.2.1	LVD, LVW and LVR threshold levels.....	1173
41.3	Introduction.....	1173
41.4	Features.....	1173
41.5	Modes of Operation.....	1174
41.5.1	Full Performance Mode (FPM).....	1174
41.5.2	Low Power Mode (LPM).....	1174
41.6	Low Voltage Detect (LVD) System.....	1174
41.6.1	Low Voltage Reset (LVR) Operation.....	1175
41.6.2	LVD Interrupt Operation.....	1175
41.6.3	Low-voltage warning (LVW) interrupt operation.....	1175
41.7	Memory Map and Register Definition.....	1176
41.7.1	PMC register descriptions.....	1176

Chapter 42

Power Management Controller (PMC)

42.1	Chip-specific PMC information	1183
42.2	Introduction.....	1183
42.3	Features.....	1183
42.4	Modes of Operation.....	1183
42.4.1	Full Performance Mode (FPM).....	1183
42.4.2	Low Power Mode (LPM).....	1184
42.5	Low Voltage Reset and Detect System.....	1184
42.5.1	Low Voltage Reset (LVR) Operation.....	1184
42.5.2	Low-voltage warning (LVW) interrupt operation.....	1184
42.6	Memory Map and Register Definition.....	1185
42.6.1	PMC register descriptions.....	1185

Chapter 43

ADC Configuration

Section number	Title	Page
43.1	Instantiation information.....	1193
43.1.1	Number of ADC channels.....	1193
43.1.2	ADC Connections/Channel Assignment.....	1194
43.2	Register implementation.....	1195
43.3	DMA Support on ADC.....	1195
43.4	ADC Hardware Interleaved Channels.....	1196
43.5	ADC internal supply monitoring.....	1197
43.6	ADC Reference Options.....	1197
43.7	ADC Trigger Sources.....	1198
43.7.1	PDB triggering scheme.....	1200
43.7.2	TRGMUX trigger scheme.....	1201
43.8	Trigger Selection.....	1202
43.9	Trigger Latching and Arbitration.....	1203
43.10	ADC triggering configurations	1205
43.11	ADC low-power modes.....	1212
43.12	ADC Trigger Concept – Use Case.....	1212
43.13	ADC calibration scheme.....	1214
43.14	S32K11X to S32K14X difference	1215

Chapter 44

Analog-to-Digital Converter (ADC)

44.1	Chip-specific ADC information.....	1217
44.2	Introduction.....	1217
44.2.1	Features.....	1217
44.2.2	Block diagram.....	1218
44.3	ADC signal descriptions.....	1219
44.3.1	Analog Power (VDDA).....	1219
44.3.2	Analog Ground (VSSA).....	1219
44.3.3	Voltage Reference Select.....	1219
44.3.4	Analog Channel Inputs (ADx).....	1220

Section number	Title	Page
44.4	ADC register descriptions.....	1220
44.4.1	ADC Memory map.....	1220
44.4.2	ADC Status and Control Register 1 (SC1A - aSC1P).....	1222
44.4.3	ADC Configuration Register 1 (CFG1).....	1225
44.4.4	ADC Configuration Register 2 (CFG2).....	1227
44.4.5	ADC Data Result Registers (RA - aRP).....	1228
44.4.6	Compare Value Registers (CV1 - CV2).....	1230
44.4.7	Status and Control Register 2 (SC2).....	1231
44.4.8	Status and Control Register 3 (SC3).....	1234
44.4.9	BASE Offset Register (BASE_OFS).....	1235
44.4.10	ADC Offset Correction Register (OFS).....	1236
44.4.11	USER Offset Correction Register (USR_OFS).....	1237
44.4.12	ADC X Offset Correction Register (XOFS).....	1238
44.4.13	ADC Y Offset Correction Register (YOFS).....	1239
44.4.14	ADC Gain Register (G).....	1240
44.4.15	ADC User Gain Register (UG).....	1242
44.4.16	ADC General Calibration Value Register S (CLPS).....	1243
44.4.17	ADC Plus-Side General Calibration Value Register 3 (CLP3).....	1244
44.4.18	ADC Plus-Side General Calibration Value Register 2 (CLP2).....	1245
44.4.19	ADC Plus-Side General Calibration Value Register 1 (CLP1).....	1245
44.4.20	ADC Plus-Side General Calibration Value Register 0 (CLP0).....	1246
44.4.21	ADC Plus-Side General Calibration Value Register X (CLPX).....	1247
44.4.22	ADC Plus-Side General Calibration Value Register 9 (CLP9).....	1248
44.4.23	ADC General Calibration Offset Value Register S (CLPS_OFS).....	1249
44.4.24	ADC Plus-Side General Calibration Offset Value Register 3 (CLP3_OFS).....	1250
44.4.25	ADC Plus-Side General Calibration Offset Value Register 2 (CLP2_OFS).....	1251
44.4.26	ADC Plus-Side General Calibration Offset Value Register 1 (CLP1_OFS).....	1252
44.4.27	ADC Plus-Side General Calibration Offset Value Register 0 (CLP0_OFS).....	1253
44.4.28	ADC Plus-Side General Calibration Offset Value Register X (CLPX_OFS).....	1254

Section number	Title	Page
44.4.29	ADC Plus-Side General Calibration Offset Value Register 9 (CLP9_OFS).....	1255
44.4.30	ADC Status and Control Register 1 (SC1AA - SC1Z).....	1256
44.4.31	ADC Data Result Registers (RAA - RZ).....	1259
44.5	Functional description.....	1261
44.5.1	Clock select and divide control.....	1261
44.5.2	Voltage reference selection.....	1262
44.5.3	Hardware trigger and channel selects.....	1262
44.5.4	Conversion control.....	1263
44.5.5	Automatic compare function.....	1267
44.5.6	Calibration function.....	1268
44.5.7	User-defined offset function.....	1269
44.5.8	MCU Normal Stop mode operation.....	1270

Chapter 45 Comparator (CMP)

45.1	Chip-specific CMP information.....	1271
45.1.1	Instantiation information.....	1271
45.1.2	CMP input connections.....	1271
45.1.3	CMP external references.....	1273
45.1.4	External window/sample input.....	1273
45.1.5	CMP trigger mode.....	1273
45.1.6	Programming recommendation.....	1274
45.1.7	S32K11X to S32K14X difference	1275
45.2	Introduction.....	1275
45.3	Features.....	1275
45.3.1	CMP features.....	1275
45.3.2	8-bit DAC key features.....	1276
45.3.3	ANMUX key features.....	1277
45.4	CMP, DAC, and ANMUX diagram.....	1277
45.5	CMP block diagram.....	1278

Section number	Title	Page
45.6	CMP pin descriptions.....	1280
45.6.1	External pins.....	1280
45.7	CMP functional modes.....	1281
45.7.1	Disabled mode (# 1).....	1282
45.7.2	Continuous mode (#s 2A & 2B).....	1283
45.7.3	Sampled, Non-Filtered mode (#s 3A & 3B).....	1283
45.7.4	Sampled, Filtered mode (#s 4A & 4B).....	1285
45.7.5	Windowed mode (#s 5A & 5B).....	1287
45.7.6	Windowed/Resampled mode (# 6).....	1289
45.7.7	Windowed/Filtered mode (#7).....	1290
45.8	Memory map/register definitions.....	1291
45.8.1	CMP Control Register 0 (CMP_C0).....	1291
45.8.2	CMP Control Register 1 (CMP_C1).....	1295
45.8.3	CMP Control Register 2 (CMP_C2).....	1298
45.9	CMP functional description.....	1300
45.9.1	Initialization.....	1300
45.9.2	Low-pass filter.....	1301
45.10	Interrupts.....	1303
45.11	DMA support.....	1303
45.12	DAC functional description.....	1304
45.12.1	Digital-to-analog converter block diagram.....	1304
45.12.2	DAC resets.....	1304
45.12.3	DAC clocks.....	1305
45.12.4	DAC interrupts.....	1305
45.13	Trigger mode.....	1305

Chapter 46

Programmable delay block (PDB)

46.1	Chip-specific PDB information.....	1309
46.1.1	Instantiation Information.....	1309

Section number	Title	Page
46.1.2	PDB trigger interconnections with ADC and TRGMUX.....	1310
46.1.3	Back-to-back acknowledgement connections.....	1310
46.1.4	Pulse-Out Enable Register Implementation.....	1320
46.1.5	S32K11X to S32K14X difference	1320
46.2	Introduction.....	1320
46.2.1	Features.....	1320
46.2.2	Implementation.....	1321
46.2.3	Back-to-back acknowledgment connections.....	1322
46.2.4	Block diagram.....	1322
46.2.5	Modes of operation.....	1323
46.3	Memory map and register definition.....	1324
46.3.1	Status and Control register (PDB_SC).....	1326
46.3.2	Modulus register (PDB_MOD).....	1329
46.3.3	Counter register (PDB_CNT).....	1330
46.3.4	Interrupt Delay register (PDB_IDLY).....	1330
46.3.5	Channel n Control register 1 (PDB_CHnC1).....	1331
46.3.6	Channel n Status register (PDB_CHnS).....	1332
46.3.7	Channel n Delay 0 register (PDB_CHnDLY0).....	1332
46.3.8	Channel n Delay 1 register (PDB_CHnDLY1).....	1333
46.3.9	Channel n Delay 2 register (PDB_CHnDLY2).....	1334
46.3.10	Channel n Delay 3 register (PDB_CHnDLY3).....	1334
46.3.11	Channel n Delay 4 register (PDB_CHnDLY4).....	1335
46.3.12	Channel n Delay 5 register (PDB_CHnDLY5).....	1336
46.3.13	Channel n Delay 6 register (PDB_CHnDLY6).....	1336
46.3.14	Channel n Delay 7 register (PDB_CHnDLY7).....	1337
46.3.15	Pulse-Out n Enable register (PDB_POEN).....	1337
46.3.16	Pulse-Out n Delay register (PDB_POnDLY).....	1338
46.4	Functional description.....	1338
46.4.1	PDB pre-trigger and trigger outputs.....	1338

Section number	Title	Page
46.4.2	PDB trigger input source selection.....	1341
46.4.3	Pulse-Out's.....	1341
46.4.4	Updating the delay registers.....	1342
46.4.5	Interrupts.....	1344
46.4.6	DMA.....	1344
46.5	Application information.....	1344
46.5.1	Impact of using the prescaler and multiplication factor on timing resolution.....	1344

Chapter 47 FlexTimer Module (FTM)

47.1	Chip-specific FTM information.....	1347
47.1.1	Instantiation Information.....	1347
47.1.2	FTM Interrupts.....	1348
47.1.3	FTM Fault Detection Inputs.....	1349
47.1.4	FTM Hardware Triggers and Synchronization.....	1350
47.1.5	FTM Input Capture Options.....	1352
47.1.6	FTM Hall sensor support.....	1353
47.1.7	FTM Modulation Implementation.....	1353
47.1.8	FTM Global Time Base.....	1354
47.1.9	FTM BDM and debug halt mode.....	1355
47.1.10	FTM fixed frequency clock	1355
47.1.11	S32K11X to S32K14X difference	1355
47.2	Introduction.....	1357
47.2.1	Features.....	1357
47.2.2	Modes of operation.....	1359
47.2.3	Block Diagram.....	1359
47.3	FTM signal descriptions.....	1361
47.4	Memory map and register definition.....	1361
47.4.1	Memory map.....	1361
47.4.2	Register descriptions.....	1362

Section number	Title	Page
47.4.3	FTM register descriptions.....	1362
47.5	Functional Description.....	1419
47.5.1	Clock source.....	1419
47.5.2	Prescaler.....	1419
47.5.3	Counter.....	1420
47.5.4	Channel Modes.....	1426
47.5.5	Input Capture Mode.....	1428
47.5.6	Output Compare mode.....	1433
47.5.7	Edge-Aligned PWM (EPWM) mode.....	1434
47.5.8	Center-Aligned PWM (CPWM) mode.....	1436
47.5.9	Combine mode.....	1438
47.5.10	Modified Combine PWM Mode.....	1446
47.5.11	Complementary Mode.....	1449
47.5.12	Registers updated from write buffers.....	1451
47.5.13	PWM synchronization.....	1452
47.5.14	Inverting.....	1468
47.5.15	Software Output Control Mode.....	1469
47.5.16	Deadtime insertion.....	1471
47.5.17	Output mask.....	1475
47.5.18	Fault Control.....	1476
47.5.19	Polarity Control.....	1480
47.5.20	Initialization.....	1481
47.5.21	Features Priority.....	1481
47.5.22	External Trigger.....	1482
47.5.23	Initialization Trigger.....	1483
47.5.24	Capture Test Mode.....	1485
47.5.25	DMA.....	1486
47.5.26	Dual Edge Capture Mode.....	1487
47.5.27	Quadrature Decoder Mode.....	1495

Section number	Title	Page
47.5.28	Debug mode.....	1501
47.5.29	Reload Points.....	1502
47.5.30	Global Load.....	1505
47.5.31	Global time base (GTB).....	1506
47.5.32	Channel trigger output.....	1507
47.5.33	External Control of Channels Output.....	1508
47.5.34	Dithering.....	1508
47.6	Reset Overview.....	1519
47.7	FTM Interrupts.....	1521
47.7.1	Timer Overflow Interrupt.....	1521
47.7.2	Reload Point Interrupt.....	1521
47.7.3	Channel (n) Interrupt.....	1521
47.7.4	Fault Interrupt.....	1521
47.8	Initialization Procedure.....	1522

Chapter 48 Low Power Interrupt Timer (LPIT)

48.1	Chip-specific LPIT information.....	1525
48.1.1	Instantiation Information.....	1525
48.1.2	LPIT/DMA Periodic Trigger Assignments	1525
48.1.3	LPIT input triggers	1526
48.1.4	LPIT/ADC Trigger.....	1526
48.1.5	Current timer value.....	1527
48.1.6	S32K11X to S32K14X difference	1528
48.2	Introduction.....	1528
48.2.1	Overview.....	1528
48.2.2	Block Diagram.....	1529
48.3	Modes of operation.....	1530
48.4	Memory Map and Registers.....	1531
48.4.1	LPIT register descriptions.....	1531

Section number	Title	Page
48.5	Functional description.....	1547
48.5.1	LPIT programming model.....	1547
48.5.2	Initialization.....	1548
48.5.3	Timer Modes.....	1549
48.5.4	Trigger Control for Timers.....	1550
48.5.5	Channel Chaining.....	1551
48.5.6	Detailed timing.....	1551

Chapter 49 Low Power Timer (LPTMR)

49.1	Chip-specific LPTMR information.....	1565
49.1.1	Instantiation Information.....	1565
49.1.2	LPTMR pulse counter input options.....	1566
49.1.3	S32K11X to S32K14X difference	1566
49.2	Introduction.....	1566
49.2.1	Features.....	1566
49.2.2	Modes of operation.....	1567
49.3	LPTMR signal descriptions.....	1567
49.3.1	Detailed signal descriptions.....	1567
49.4	Memory map and register definition.....	1568
49.4.1	LPTMR register descriptions.....	1568
49.5	Functional description.....	1573
49.5.1	LPTMR power and reset.....	1573
49.5.2	LPTMR clocking.....	1574
49.5.3	LPTMR prescaler/glitch filter.....	1574
49.5.4	LPTMR counter.....	1575
49.5.5	LPTMR compare.....	1576
49.5.6	LPTMR interrupt.....	1576
49.5.7	LPTMR hardware trigger.....	1577

Chapter 50

Section number	Title	Page
Real Time Clock (RTC)		
50.1	Chip-specific RTC information.....	1579
50.1.1	RTC instantiation.....	1579
50.1.2	RTC interrupts	1579
50.1.3	Software recommendation.....	1579
50.1.4	Multiple trigger	1580
50.1.5	S32K11X to S32K14X difference	1580
50.2	Introduction.....	1580
50.2.1	Features.....	1580
50.2.2	Modes of operation.....	1580
50.2.3	RTC signal descriptions.....	1581
50.3	Register definition.....	1581
50.3.1	RTC register descriptions.....	1581
50.4	Functional description.....	1592
50.4.1	Power, clocking, and reset.....	1592
50.4.2	Time counter.....	1593
50.4.3	Compensation.....	1593
50.4.4	Time alarm.....	1594
50.4.5	Update mode.....	1595
50.4.6	Register lock.....	1595
50.4.7	Interrupt.....	1595

Chapter 51 Low Power Serial Peripheral Interface (LPSPI)

51.1	Chip-specific LPSPI information.....	1597
51.1.1	Instantiation Information.....	1597
51.2	Introduction.....	1598
51.2.1	Features.....	1598
51.2.2	Block Diagram.....	1599
51.2.3	Modes of operation.....	1600

Section number	Title	Page
51.2.4	Signal Descriptions.....	1600
51.3	Memory Map and Registers.....	1601
51.3.1	LPSPi register descriptions.....	1601
51.4	Functional description.....	1626
51.4.1	Clocking and resets.....	1626
51.4.2	Master Mode.....	1626
51.4.3	Slave Mode.....	1632
51.4.4	Interrupts and DMA Requests.....	1634
51.4.5	Peripheral Triggers.....	1635

Chapter 52
Low Power Inter-Integrated Circuit (LPI2C)

52.1	Chip-specific LPI2C information.....	1637
52.1.1	Instantiation information.....	1637
52.2	Introduction.....	1638
52.2.1	Features.....	1638
52.2.2	Block Diagram.....	1639
52.2.3	Modes of operation.....	1640
52.2.4	Signal Descriptions.....	1640
52.3	Functional description.....	1641
52.3.1	Clocking and Resets.....	1641
52.3.2	Master Mode.....	1642
52.3.3	Slave Mode.....	1648
52.3.4	Interrupts and DMA Requests.....	1650
52.3.5	Peripheral Triggers.....	1652
52.4	Memory Map and Registers.....	1653
52.4.1	LPI2C register descriptions.....	1653

Chapter 53
Low Power Universal Asynchronous Receiver/Transmitter (LPUART)

53.1	Chip-specific LPUART information.....	1693
------	---------------------------------------	------

Section number	Title	Page
53.1.1	Instantiation Information.....	1693
53.2	Introduction.....	1694
53.2.1	Features.....	1694
53.2.2	Modes of operation.....	1695
53.2.3	Signal Descriptions.....	1695
53.2.4	Block diagram.....	1695
53.3	Register definition.....	1697
53.3.1	LPUART register descriptions.....	1697
53.4	Functional description.....	1723
53.4.1	Clocking and Resets.....	1723
53.4.2	Baud rate generation.....	1723
53.4.3	Transmitter functional description.....	1724
53.4.4	Receiver functional description.....	1727
53.4.5	Additional LPUART functions.....	1735
53.4.6	Infrared interface.....	1737
53.4.7	Interrupts and status flags.....	1738
53.4.8	Peripheral Triggers.....	1739
 Chapter 54 Flexible I/O (FlexIO) 		
54.1	Chip-specific FlexIO information.....	1741
54.1.1	FlexIO Configuration.....	1741
54.2	Introduction.....	1741
54.2.1	Overview.....	1741
54.2.2	Features.....	1742
54.2.3	Block Diagram.....	1742
54.2.4	Modes of operation.....	1743
54.2.5	FlexIO Signal Descriptions.....	1743
54.3	Memory Map and Registers.....	1744
54.3.1	FLEXIO register descriptions.....	1744

Section number	Title	Page
54.4	Functional description.....	1768
54.4.1	Clocking and Resets.....	1768
54.4.2	Shifter operation.....	1769
54.4.3	Timer Operation.....	1771
54.4.4	Pin operation.....	1775
54.4.5	Interrupts and DMA Requests.....	1776
54.4.6	Peripheral Triggers.....	1776
54.5	Application Information.....	1777
54.5.1	UART Transmit.....	1777
54.5.2	UART Receive.....	1778
54.5.3	SPI Master.....	1780
54.5.4	SPI Slave.....	1782
54.5.5	I2C Master.....	1783
54.5.6	I2S Master.....	1785
54.5.7	I2S Slave.....	1787
 Chapter 55 FlexCAN 		
55.1	Chip-specific FlexCAN information.....	1789
55.1.1	Instantiation information.....	1789
55.1.2	FlexCAN register information.....	1790
55.1.3	Reset value of MDIS bit.....	1797
55.1.4	FlexCAN external time tick	1797
55.1.5	FlexCAN Interrupts.....	1797
55.1.6	FlexCAN Operation in Low Power Modes.....	1798
55.1.7	FlexCAN oscillator clock.....	1798
55.1.8	Supported baud rate	1798
55.1.9	Requirements for entering FlexCAN modes: Freeze, Disable, Stop.....	1798
55.2	Overview.....	1800
55.2.1	Block diagram.....	1801

Section number	Title	Page
55.2.2	Features.....	1801
55.3	Functional description.....	1803
55.3.1	Modes of operation.....	1804
55.3.2	Transmit process.....	1809
55.3.3	Arbitration process.....	1811
55.3.4	Receive process.....	1814
55.3.5	Matching process.....	1816
55.3.6	Receive process under Pretended Networking mode.....	1821
55.3.7	Move process.....	1825
55.3.8	Data coherence.....	1827
55.3.9	Rx FIFO.....	1830
55.3.10	CAN protocol related features.....	1833
55.3.11	Clocks.....	1853
55.3.12	Reset.....	1858
55.3.13	Interrupts.....	1858
55.3.14	Bus interface.....	1859
55.4	FlexCAN signal descriptions.....	1862
55.4.1	CAN Rx	1863
55.4.2	CAN Tx	1863
55.5	Memory map/register definition.....	1863
55.5.1	FlexCAN memory mapping.....	1863
55.5.2	CAN register descriptions.....	1865
55.5.3	Message buffer structure.....	1933
55.5.4	FlexCAN memory partition for CAN FD.....	1940
55.5.5	FlexCAN message buffer memory map.....	1941
55.5.6	Rx FIFO structure.....	1943
55.6	Initialization/application information.....	1945
55.6.1	FlexCAN initialization sequence.....	1945

Chapter 56

Section number	Title	Page
Synchronous Audio Interface (SAI)		
56.1	Chip-specific SAI information	1947
56.1.1	SAI configuration.....	1947
56.1.2	Chip-specific register information.....	1948
56.2	Introduction.....	1949
56.2.1	Features.....	1949
56.2.2	Block diagram.....	1949
56.2.3	Modes of operation.....	1950
56.3	External signals.....	1951
56.4	Memory map and register definition.....	1951
56.4.1	I2S register descriptions.....	1951
56.5	Functional description.....	1984
56.5.1	SAI clocking.....	1984
56.5.2	SAI resets.....	1986
56.5.3	Synchronous modes.....	1987
56.5.4	Frame sync configuration.....	1988
56.5.5	Data FIFO.....	1988
56.5.6	Word mask register.....	1992
56.5.7	Interrupts and DMA requests.....	1993
Chapter 57		
Ethernet MAC (ENET)		
57.1	Chip-specific ENET information.....	1997
57.1.1	Software guideline during ENET operation.....	1997
57.2	Introduction.....	1997
57.3	Overview.....	1998
57.3.1	Features.....	1998
57.3.2	Block diagram.....	2001
57.4	External signal description.....	2001
57.5	Memory map/register definition.....	2003

Section number	Title	Page
57.5.1	Interrupt Event Register (ENET_EIR).....	2008
57.5.2	Interrupt Mask Register (ENET_EIMR).....	2011
57.5.3	Receive Descriptor Active Register (ENET_RDAR).....	2014
57.5.4	Transmit Descriptor Active Register (ENET_TDAR).....	2015
57.5.5	Ethernet Control Register (ENET_ECR).....	2016
57.5.6	MII Management Frame Register (ENET_MMFR).....	2018
57.5.7	MII Speed Control Register (ENET_MSCR).....	2018
57.5.8	MIB Control Register (ENET_MIBC).....	2021
57.5.9	Receive Control Register (ENET_RCR).....	2022
57.5.10	Transmit Control Register (ENET_TCR).....	2025
57.5.11	Physical Address Lower Register (ENET_PALR).....	2027
57.5.12	Physical Address Upper Register (ENET_PAUR).....	2027
57.5.13	Opcode/Pause Duration Register (ENET_OPD).....	2028
57.5.14	Descriptor Individual Upper Address Register (ENET_IAUR).....	2028
57.5.15	Descriptor Individual Lower Address Register (ENET_IALR).....	2029
57.5.16	Descriptor Group Upper Address Register (ENET_GAUR).....	2029
57.5.17	Descriptor Group Lower Address Register (ENET_GALR).....	2030
57.5.18	Transmit FIFO Watermark Register (ENET_TFWR).....	2030
57.5.19	Receive Descriptor Ring Start Register (ENET_RDSR).....	2031
57.5.20	Transmit Buffer Descriptor Ring Start Register (ENET_TDSR).....	2032
57.5.21	Maximum Receive Buffer Size Register (ENET_MRBR).....	2033
57.5.22	Receive FIFO Section Full Threshold (ENET_RSFL).....	2034
57.5.23	Receive FIFO Section Empty Threshold (ENET_RSEM).....	2034
57.5.24	Receive FIFO Almost Empty Threshold (ENET_RAEM).....	2035
57.5.25	Receive FIFO Almost Full Threshold (ENET_RAFL).....	2035
57.5.26	Transmit FIFO Section Empty Threshold (ENET_TSEM).....	2036
57.5.27	Transmit FIFO Almost Empty Threshold (ENET_TAEM).....	2036
57.5.28	Transmit FIFO Almost Full Threshold (ENET_TAFL).....	2037
57.5.29	Transmit Inter-Packet Gap (ENET_TIPG).....	2037

Section number	Title	Page
57.5.30	Frame Truncation Length (ENET_FTRL).....	2038
57.5.31	Transmit Accelerator Function Configuration (ENET_TACC).....	2038
57.5.32	Receive Accelerator Function Configuration (ENET_RACC).....	2039
57.5.33	Reserved Statistic Register (ENET_RMON_T_DROP).....	2040
57.5.34	Tx Packet Count Statistic Register (ENET_RMON_T_PACKETS).....	2041
57.5.35	Tx Broadcast Packets Statistic Register (ENET_RMON_T_BC_PKT).....	2041
57.5.36	Tx Multicast Packets Statistic Register (ENET_RMON_T_MC_PKT).....	2042
57.5.37	Tx Packets with CRC/Align Error Statistic Register (ENET_RMON_T_CRC_ALIGN).....	2042
57.5.38	Tx Packets Less Than Bytes and Good CRC Statistic Register (ENET_RMON_T_UNDERSIZE).....	2042
57.5.39	Tx Packets GT MAX_FL bytes and Good CRC Statistic Register (ENET_RMON_T_OVERSIZE).....	2043
57.5.40	Tx Packets Less Than 64 Bytes and Bad CRC Statistic Register (ENET_RMON_T_FRAG).....	2043
57.5.41	Tx Packets Greater Than MAX_FL bytes and Bad CRC Statistic Register (ENET_RMON_T_JAB).....	2044
57.5.42	Tx Collision Count Statistic Register (ENET_RMON_T_COL).....	2044
57.5.43	Tx 64-Byte Packets Statistic Register (ENET_RMON_T_P64).....	2044
57.5.44	Tx 65- to 127-byte Packets Statistic Register (ENET_RMON_T_P65TO127).....	2045
57.5.45	Tx 128- to 255-byte Packets Statistic Register (ENET_RMON_T_P128TO255).....	2045
57.5.46	Tx 256- to 511-byte Packets Statistic Register (ENET_RMON_T_P256TO511).....	2046
57.5.47	Tx 512- to 1023-byte Packets Statistic Register (ENET_RMON_T_P512TO1023).....	2046
57.5.48	Tx 1024- to 2047-byte Packets Statistic Register (ENET_RMON_T_P1024TO2047).....	2047
57.5.49	Tx Packets Greater Than 2048 Bytes Statistic Register (ENET_RMON_T_P_GTE2048).....	2047
57.5.50	Tx Octets Statistic Register (ENET_RMON_T_OCTETS).....	2047
57.5.51	Reserved Statistic Register (ENET_IEEE_T_DROP).....	2048
57.5.52	Frames Transmitted OK Statistic Register (ENET_IEEE_T_FRAME_OK).....	2048
57.5.53	Frames Transmitted with Single Collision Statistic Register (ENET_IEEE_T_1COL).....	2049
57.5.54	Frames Transmitted with Multiple Collisions Statistic Register (ENET_IEEE_T_MCOL).....	2049
57.5.55	Frames Transmitted after Deferral Delay Statistic Register (ENET_IEEE_T_DEF).....	2049
57.5.56	Frames Transmitted with Late Collision Statistic Register (ENET_IEEE_T_LCOL).....	2050
57.5.57	Frames Transmitted with Excessive Collisions Statistic Register (ENET_IEEE_T_EXCOL).....	2050
57.5.58	Frames Transmitted with Tx FIFO Underrun Statistic Register (ENET_IEEE_T_MACERR).....	2051

Section number	Title	Page
57.5.59	Frames Transmitted with Carrier Sense Error Statistic Register (ENET_IEEE_T_CSERR).....	2051
57.5.60	Reserved Statistic Register (ENET_IEEE_T_SQE).....	2051
57.5.61	Flow Control Pause Frames Transmitted Statistic Register (ENET_IEEE_T_FDXFC).....	2052
57.5.62	Octet Count for Frames Transmitted w/o Error Statistic Register (ENET_IEEE_T_OCTETS_OK).....	2052
57.5.63	Rx Packet Count Statistic Register (ENET_RMON_R_PACKETS).....	2053
57.5.64	Rx Broadcast Packets Statistic Register (ENET_RMON_R_BC_PKT).....	2053
57.5.65	Rx Multicast Packets Statistic Register (ENET_RMON_R_MC_PKT).....	2053
57.5.66	Rx Packets with CRC/Align Error Statistic Register (ENET_RMON_R_CRC_ALIGN).....	2054
57.5.67	Rx Packets with Less Than 64 Bytes and Good CRC Statistic Register (ENET_RMON_R_UNDERSIZE).....	2054
57.5.68	Rx Packets Greater Than MAX_FL and Good CRC Statistic Register (ENET_RMON_R_OVERSIZE)...	2055
57.5.69	Rx Packets Less Than 64 Bytes and Bad CRC Statistic Register (ENET_RMON_R_FRAG).....	2055
57.5.70	Rx Packets Greater Than MAX_FL Bytes and Bad CRC Statistic Register (ENET_RMON_R_JAB).....	2055
57.5.71	Reserved Statistic Register (ENET_RMON_R_RESVD_0).....	2056
57.5.72	Rx 64-Byte Packets Statistic Register (ENET_RMON_R_P64).....	2056
57.5.73	Rx 65- to 127-Byte Packets Statistic Register (ENET_RMON_R_P65TO127).....	2057
57.5.74	Rx 128- to 255-Byte Packets Statistic Register (ENET_RMON_R_P128TO255).....	2057
57.5.75	Rx 256- to 511-Byte Packets Statistic Register (ENET_RMON_R_P256TO511).....	2057
57.5.76	Rx 512- to 1023-Byte Packets Statistic Register (ENET_RMON_R_P512TO1023).....	2058
57.5.77	Rx 1024- to 2047-Byte Packets Statistic Register (ENET_RMON_R_P1024TO2047).....	2058
57.5.78	Rx Packets Greater than 2048 Bytes Statistic Register (ENET_RMON_R_P_GTE2048).....	2059
57.5.79	Rx Octets Statistic Register (ENET_RMON_R_OCTETS).....	2059
57.5.80	Frames not Counted Correctly Statistic Register (ENET_IEEE_R_DROP).....	2059
57.5.81	Frames Received OK Statistic Register (ENET_IEEE_R_FRAME_OK).....	2060
57.5.82	Frames Received with CRC Error Statistic Register (ENET_IEEE_R_CRC).....	2060
57.5.83	Frames Received with Alignment Error Statistic Register (ENET_IEEE_R_ALIGN).....	2061
57.5.84	Receive FIFO Overflow Count Statistic Register (ENET_IEEE_R_MACERR).....	2061
57.5.85	Flow Control Pause Frames Received Statistic Register (ENET_IEEE_R_FDXFC).....	2061
57.5.86	Octet Count for Frames Received without Error Statistic Register (ENET_IEEE_R_OCTETS_OK).....	2062

Section number	Title	Page
57.5.87	Adjustable Timer Control Register (ENET_ATCR).....	2062
57.5.88	Timer Value Register (ENET_ATVR).....	2064
57.5.89	Timer Offset Register (ENET_ATOFF).....	2065
57.5.90	Timer Period Register (ENET_ATPER).....	2065
57.5.91	Timer Correction Register (ENET_ATCOR).....	2066
57.5.92	Time-Stamping Clock Period Register (ENET_ATINC).....	2066
57.5.93	Timestamp of Last Transmitted Frame (ENET_ATSTMP).....	2067
57.5.94	Timer Global Status Register (ENET_TGSR).....	2067
57.5.95	Timer Control Status Register (ENET_TCSR _n).....	2068
57.5.96	Timer Compare Capture Register (ENET_TCCR _n).....	2069
57.6	Functional description.....	2070
57.6.1	Ethernet MAC frame formats.....	2070
57.6.2	IP and higher layers frame format.....	2073
57.6.3	IEEE 1588 message formats.....	2077
57.6.4	MAC receive.....	2081
57.6.5	MAC transmit.....	2087
57.6.6	Full-duplex flow control operation.....	2091
57.6.7	Magic packet detection.....	2093
57.6.8	IP accelerator functions.....	2094
57.6.9	Resets and stop controls.....	2098
57.6.10	IEEE 1588 functions.....	2101
57.6.11	FIFO thresholds.....	2105
57.6.12	Loopback options.....	2108
57.6.13	Legacy buffer descriptors.....	2109
57.6.14	Enhanced buffer descriptors.....	2110
57.6.15	Client FIFO application interface.....	2116
57.6.16	FIFO protection.....	2119
57.6.17	Reference clock.....	2121
57.6.18	PHY management interface.....	2122

Section number	Title	Page
57.6.19	Ethernet interfaces.....	2125

Chapter 58 Debug

58.1	Introduction.....	2131
58.2	CM4 and CM0+ ROM table.....	2134
58.3	Debug port.....	2135
58.3.1	JTAG-to-SWD change sequence.....	2136
58.4	Debug port pin descriptions.....	2137
58.5	System TAP connection.....	2137
58.5.1	IR codes.....	2137
58.6	MDM-AP status and control registers.....	2138
58.6.1	MDM-AP Control Register.....	2139
58.6.2	MDM-AP Status Register.....	2140
58.7	Debug resets.....	2141
58.8	AHB-AP.....	2142
58.9	ITM.....	2142
58.10	Core trace connectivity.....	2143
58.11	TPIU.....	2143
58.12	DWT.....	2144
58.13	MTB	2144
58.14	Debug in low-power modes.....	2145
58.14.1	Debug module state in low-power modes.....	2145
58.15	Debug and security.....	2146

Chapter 59 JTAG Controller (JTAGC)

59.1	Chip-specific JTAGC information.....	2147
59.2	Introduction.....	2147
59.2.1	Block diagram.....	2147
59.2.2	Features.....	2148

Section number	Title	Page
59.2.3	Modes of operation.....	2148
59.3	External signal description.....	2150
59.3.1	Test clock input (TCK).....	2150
59.3.2	Test data input (TDI).....	2150
59.3.3	Test data output (TDO).....	2150
59.3.4	Test mode select (TMS).....	2151
59.4	Register description.....	2151
59.4.1	Instruction register.....	2151
59.4.2	Bypass register.....	2152
59.4.3	Device identification register.....	2152
59.4.4	Boundary scan register.....	2153
59.5	Functional description.....	2153
59.5.1	JTAGC reset configuration.....	2153
59.5.2	IEEE 1149.1-2001 (JTAG) TAP.....	2153
59.5.3	TAP controller state machine.....	2154
59.5.4	JTAGC block instructions.....	2156
59.5.5	Boundary scan.....	2159
59.6	Initialization/application information.....	2159

Chapter 1

About This Manual

1.1 Audience

This reference manual is intended for system software and hardware developers and applications programmers who want to develop products with this device. It assumes that the reader understands operating systems, microprocessor system design, and basic principles of software and hardware. The manual describes the functionality of the superset device of the S32K1xx and S32K14xW series. For the available features, register implementation of a specific derivative (derivative device), please refer to the respective Chip-specific *module* information.

1.2 Organization

This manual has two main sets of chapters.

1. Chapters in the first set contain information that applies to all components on the chip.
2. Chapters in the second set are organized into functional groupings that detail particular areas of functionality.
 - Examples of these groupings are clocking, timers, and communication interfaces.
 - Each grouping includes chapters that provide a technical description of individual modules.

1.3 Module descriptions

Each module chapter has two main parts:

- The first section, *Chip-specific [module name] information*, provides details such as the number of module instances on the chip and connections between the module and other modules. Read this section *first* because its content is crucial to understanding the information in other sections of the chapter.
- The subsequent sections provide general information about the module, including its signals, registers, and functional description.

Chapter 49
Enhanced Serial Communication Interface (eSCI)

49.1 Chip-specific eSCI information

This chip has six instances of the eSCI module. Some feature details vary between the instances.

The following table summarizes the feature differences. The table does not list feature details that the instances share.

Table 49-1. eSCI instance feature differences

Instance	Feature	Support
eSCI_A and eSCI_B	...	Yes
eSCI_C, eSCI_D, eSCI_E, and eSCI_F

NOTE
For eSCI_D, the single-wire feature does not apply to TX/RX via PC112 because this pad works as an output.

49.2 Introduction

The eSCI block is an enhanced SCI block with a LIN master interface layer and DMA support. The LIN master layer complies with the specifications LIN 1.3, LIN 2.0, LIN 2.1, and CANAE J2602/1.

49.2.1 Pin configuration

- LIN Specification Package Revision 1.3; December 12, 2002
- LIN Specification Package Revision 2.0; September 23, 2003

Sample Reference Manual

Annotations on the right side of the page:

- Chip-specific information that should be read first
- Beginning of general module information

Figure 1-1. Example: chapter chip-specific information and general module information

1.3.1 Example: chip-specific information that clarifies content in the same chapter

The example below shows chip-specific information that clarifies general module information presented later in the chapter. In this case, the chip-specific register reset values supercede the reset values that appear in the register diagram.

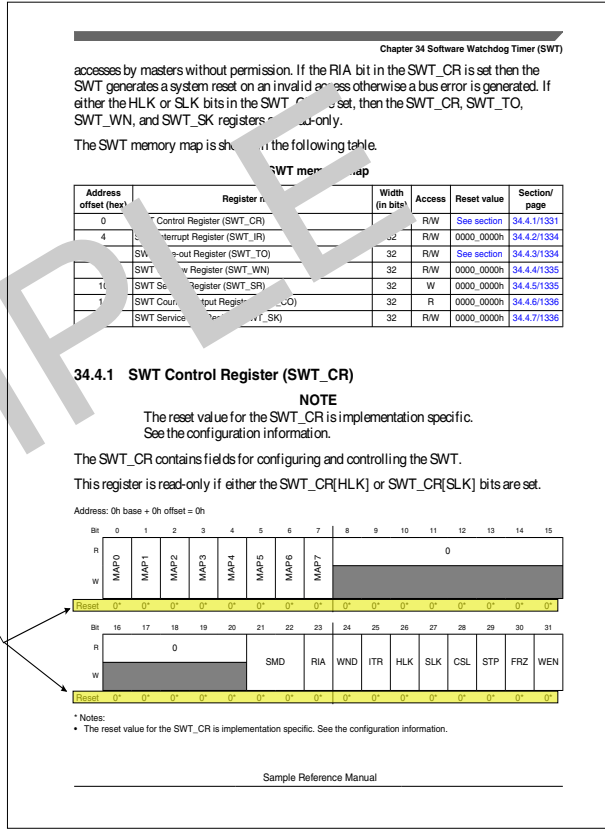
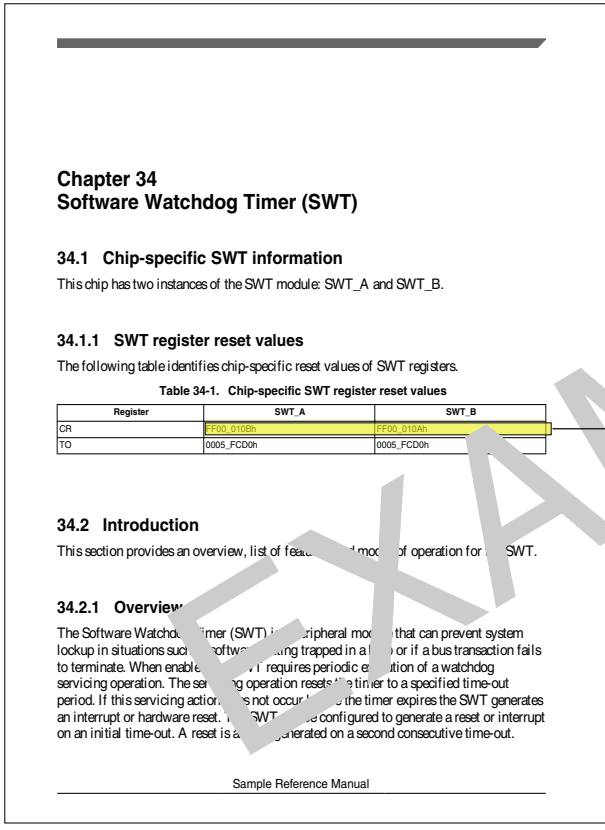

Figure 1-2. Example: chip-specific information that clarifies content in the same chapter

1.3.2 Example: chip-specific information that refers to a different chapter

The chip-specific information below refers to another chapter's chip-specific information. In this case, read both sets of chip-specific information before reading further in the chapter.

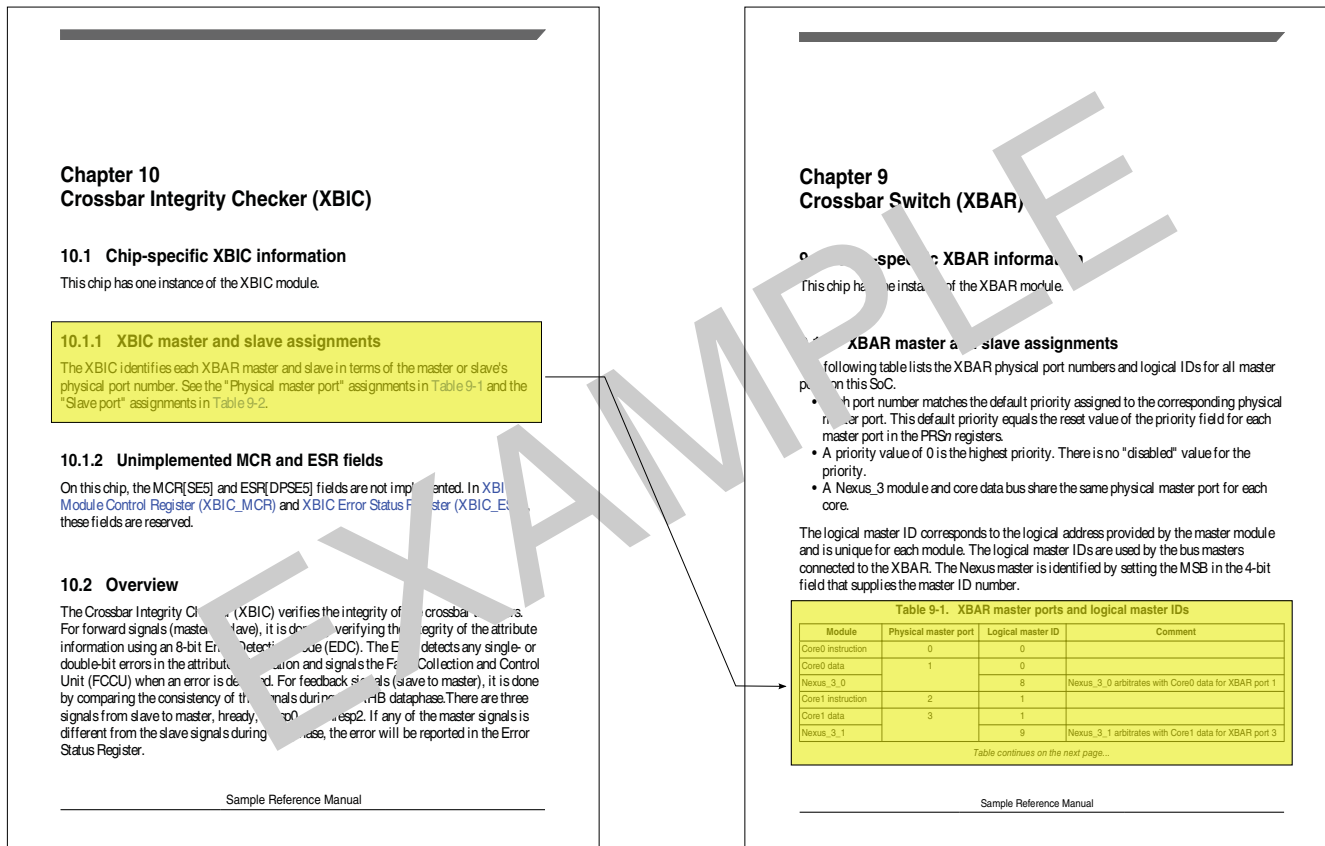

Figure 1-3. Example: chip-specific information that refers to a different chapter

1.4 Register descriptions

Module chapters present register information in:

- Memory maps containing:
 - An offset from the module's base address
 - The name and acronym/abbreviation of each register
 - The width of each register (in bits)
 - Each register's reset value
 - The page number on which each register is described
- Register figures
- Field-description tables
- Associated text

The register figures show the field structure using the conventions in the following figure.

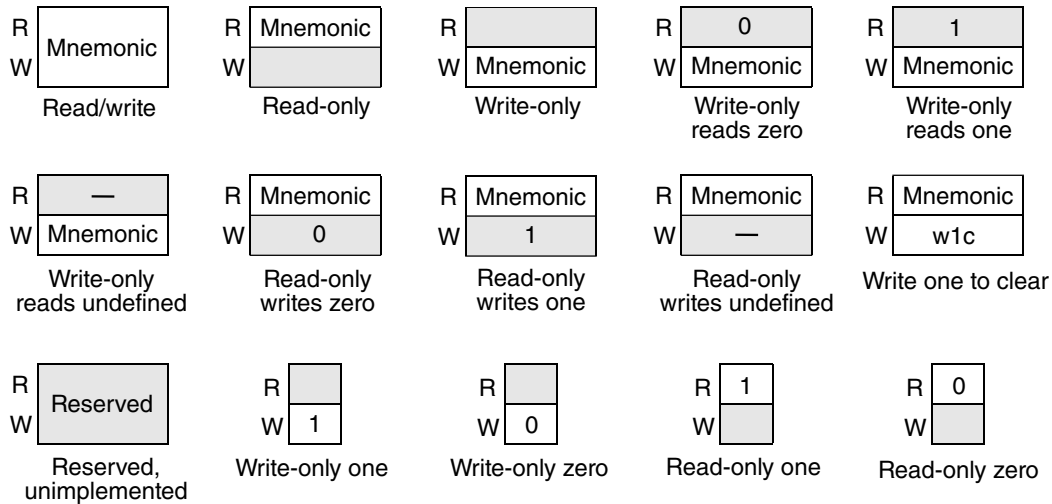

Figure 1-4. Register figure conventions

1.5 Conventions

1.5.1 Notes, Cautions, and Warnings

Note, Caution, and Warning notices appear throughout this manual. Each notice type alerts readers to a specific kind of information.

NOTE

Notes convey information that may be tangential to a topic or that may not apply to all readers.

CAUTION

Caution notices call out information that readers should know before taking further action. Cautions frequently point to trouble spots that may damage the chip or board.

WARNING

Warning notices inform readers about actions that could result in unwanted consequences, especially those that may cause bodily injury.

1.5.2 Numbering systems

The following suffixes identify different numbering systems:

Conventions

This suffix	Identifies a
b	Binary number. For example, the binary equivalent of the number 5 is written 101b. In some cases, binary numbers are shown with the prefix <i>0b</i> .
d	Decimal number. Decimal numbers are followed by this suffix only when the possibility of confusion exists. In general, decimal numbers are shown without a suffix.
h	Hexadecimal number. For example, the hexadecimal equivalent of the number 60 is written 3Ch. In some cases, hexadecimal numbers are shown with the prefix <i>0x</i> .

1.5.3 Typographic notation

The following typographic notation is used throughout this document:

Example	Description
<i>placeholder, x</i>	Items in italics are placeholders for information that you provide. Italicized text is also used for the titles of publications and for emphasis. Plain lowercase letters are also used as placeholders for single letters and numbers.
<code>code</code>	Fixed-width type indicates text that must be typed exactly as shown. It is used for instruction mnemonics, directives, symbols, subcommands, parameters, and operators. Fixed-width type is also used for example code. Instruction mnemonics and directives in text and tables are shown in all caps; for example, BSR.
SR[SCM]	A mnemonic in brackets represents a named field in a register. This example refers to the Scaling Mode (SCM) field in the Status Register (SR).
REVNO[6:4], XAD[7:0]	Numbers in brackets and separated by a colon represent either: <ul style="list-style-type: none">• A subset of a register's named field For example, REVNO[6:4] refers to bits 6–4 that are part of the COREREV field that occupies bits 6–0 of the REVNO register.• A continuous range of individual signals of a bus For example, XAD[7:0] refers to signals 7–0 of the XAD bus.

1.5.4 Special terms

The following terms have special meanings:

Term	Meaning
asserted	Refers to the state of a signal as follows: <ul style="list-style-type: none">• An active-high signal is asserted when high (1).• An active-low signal is asserted when low (0).
deasserted	Refers to the state of a signal as follows: <ul style="list-style-type: none">• An active-high signal is deasserted when low (0).• An active-low signal is deasserted when high (1). <p>In some cases, deasserted signals are described as <i>negated</i>.</p>

Table continues on the next page...

Term	Meaning
reserved	Refers to a memory space, register, field, or programming setting. Device operation is not guaranteed when reserved locations are written to any value. <ul style="list-style-type: none"><li data-bbox="451 250 1469 306">• Do not modify the default value of a reserved programming setting, such as the reset value of a reserved register field.<li data-bbox="451 308 1068 337">• Consider undefined locations in memory to be reserved.
w1c	Write 1 to clear: Refers to a register bitfield that must be written as 1 to be "cleared."

Chapter 2

Introduction

2.1 Overview

The S32K1xx and S32K14xW product series further extends the highly scalable portfolio of Arm® Cortex®-M0+/M4F MCUs in the automotive industry. It builds on the legacy of the KEA series, while introducing higher memory options alongside a richer peripheral set extending capability into a variety of automotive applications. With a 2.70–5.5 V supply and focus on automotive environment robustness, the S32K product series devices are well suited to a wide range of applications in electrically harsh environments, and are optimized for cost-sensitive applications offering low pin-count options. The S32K product series offers a broad range of memory, peripherals, and package options. It shares common peripherals and pin counts, allowing developers to migrate easily within an MCU family or among the MCU families to take advantage of more memory or feature integration. This scalability allows developers to use the S32K product series as the standard for their end product platforms, maximizing hardware and software reuse and reducing time to market.

2.2 S32K1xx Series introduction

2.2.1 S32K14x

S32K14x series of devices are 32-bit general purpose automotive microcontrollers based on the Arm Cortex-M4F core. They offer superior performance, large memories and the most scalable peripherals in this class. This product series provides up to 112 MHz CPU performance with DSP and FPU support, with up to 2 MB Flash and up to 256 KB SRAM. Overview of device features:

- 32-bit Arm Cortex-M4F core with FPU, up to 112 MHz (HSRUN) and 80 MHz (Normal RUN)

- Up to 2 MB code flash memory and 64 KB FlexMem (supports up to 4 KB emulated EEPROM ¹ with 4 KB FlexRAM)
- Up to 256 KB SRAM supporting both CPU private access and crossbar access to provide parallel access of instruction and data
- Modified Harvard connections with Local Memory controller (LMEM) to support tightly coupled RAM and 4 KB Code Cache²
- Integrated clocking architecture with on-chip fast IRC 48-60 MHz, slow IRC 8 MHz / 2 MHz, 128 KHz LPO and a PLL unit
- Analog modules providing precision mixed-signal capabilities, including 12-bit up to two 1 Msps SAR ADC, high-speed comparator
- Power Management Controller (PMC) with internal regulators capable of supporting multiple power modes including:
 - HSRUN ^{2, , 3}
 - RUN
 - STOP
 - VLPR
 - VLPS
- I/O supporting 2.7 V to 5.5 V supply
- Wide operating voltage ranges (2.7–5.5 V) with fully functional flash memory program/erase/read operations
- 48 LQFP, 64 LQFP, 100 LQFP, 144 LQFP, 176 LQFP and 100 MAPBGA packages with up to 156 GPIO pins
- Ambient operating temperature ranges from –40 °C to 125 °C ³

The S32K14x MCU portfolio is supported by a highly comprehensive set of development tools and software. The enablement package includes: NXP Arduino compatible evaluation boards, S32K Software Development Kit (SDK) including graphical configurability and S32 Design Studio software, as well as broad support from IAR Systems, Arm, Software, Green Hills, and other partners.

1. CSEc (Security) or EEPROM writes/erase will trigger error flags in HSRUN mode (112 MHz) because this use case is not allowed to execute simultaneously. The device will need to switch to RUN mode (80 Mhz) to execute CSEc (Security) or EEPROM writes/erase.

2. This refers to region addressable by Arm CM4 Code bus and is used to cache code as well as data in this region. See S32K1xx_memory_map.xlsx for more details on cacheability of different regions.

3. HSRUN mode (112 MHz) operation is not valid at 125 °C.

2.2.2 S32K14xW

S32K14xW series of devices are 32-bit general purpose automotive micro-controllers based on the Arm Cortex-M4F core. They offer superior performance, large memories and the most scalable peripherals in this class. This product series provides up to 80 MHz CPU performance with DSP and FPU support, with up to 512 KB Flash and up to 64 KB SRAM. Overview of device features:

- 32-bit Arm Cortex-M4F core with FPU, up to 80 MHz
- Up to 512 KB code flash memory and 64 KB FlexMem (supports up to 4 KB emulated EEPROM with 4 KB FlexRAM)
- Up to 64 KB SRAM supporting both CPU private access and crossbar access to provide parallel access of instruction and data
- Modified Harvard connections with Local Memory controller (LMEM) to support tightly coupled RAM and 4 KB Code Cache⁴
- Integrated clocking architecture with on-chip fast IRC 48-60 MHz, slow IRC 8 MHz / 2 MHz, 128 KHz LPO and a PLL unit
- Analog modules providing precision mixed-signal capabilities, including 12-bit up to two 1 Msp/s SAR ADC, high-speed comparator
- Power Management Controller (PMC) with internal regulators capable of supporting multiple power modes including:
 - RUN
 - STOP
 - VLPR
 - VLPS
- I/O supporting 3.13 V to 5.5 V supply
- Wide operating voltage ranges (3.13–5.5 V) with fully functional flash memory program/erase/read operations
- 48 LQFP and 64 LQFP packages with up to 58 GPIO pins
- Ambient operating temperature ranges from –40 °C to 150 °C

The S32K14xW MCU portfolio is supported by a highly comprehensive set of development tools and software. The enablement package includes: NXP Arduino compatible evaluation boards, S32K Software Development Kit (SDK) including graphical configurability and S32 Design Studio software, as well as broad support from IAR Systems, Arm, Software, Green Hills, and other partners.

4. This refers to region addressable by Arm CM4 Code bus and is used to cache code as well as data in this region. See S32K1xx_memory_map.xlsx for more details on cacheability of different regions.

2.2.3 S32K11x

S32K11x series of devices are 32-bit general purpose automotive microcontrollers based on the Arm Cortex-M0+ core. They offer superior performance, large memories and the most scalable peripherals in this class. This product series provides 48 MHz CPU performance, with up to 256 KB Flash and up to 25 KB SRAM. Overview of device features:

- 32-bit Arm Cortex-M0+ core with 48 MHz CPU
- Up to 256 KB code flash memory and 32 KB FlexMem (supports up to 2 KB emulated EEPROM with 2 KB FlexRAM)
- Up to 25 KB SRAM
- Integrated clocking architecture with on-chip fast IRC 48 MHz, slow IRC 8MHz, and 128 KHz LPO
- Analog modules providing precision mixed-signal capabilities, including 12-bit 1 Msps SAR ADC, high-speed comparator
- Power Management Controller (PMC) with internal regulators capable of supporting multiple power modes including:
 - RUN
 - STOP
 - VLPR
 - VLPS
- I/O supporting 2.7 V to 5.5 V supply
- Wide operating voltage ranges (2.7–5.5 V) with fully functional flash memory program/erase/read operations
- 32-pin QFN, 48-pinLQFP, 64-pinLQFP with up to 58 GPIO pins
- Ambient operating temperature ranges from –40 °C to 125 °C

The S32K11x MCU portfolio is supported by a highly comprehensive set of development tools and software. The enablement package includes: NXP Arduino compatible evaluation boards, S32K Software Development Kit (SDK) including graphical configurability and S32 Design Studio software, as well as broad support from IAR Systems, Cosmic Software, Green Hills, and other partners.

2.3 Feature summary

The following table lists the features integrated on S32K1xx/S32K14xW product series.

Table 2-1. Device feature summary

Feature	S32K11x product series	S32K14x product series	S32K14xW product series
---------	------------------------	------------------------	-------------------------

Table continues on the next page...

Table 2-1. Device feature summary (continued)

Feature	S32K11x product series	S32K14x product series	S32K14xW product series
Package	32-pin QFN , 5*5 mm, 0.5 mm pitch 48-pin LQFP, 7*7 mm, 0.5 mm pitch 64-pin LQFP, 10*10 mm, 0.5 mm pitch	48-pin LQFP, 7*7 mm, 0.5 mm pitch 64-pin LQFP, 10*10 mm, 0.5 mm pitch 100-pin LQFP, 14*14 mm, 0.5 mm pitch 144-pin LQFP, 20*20 mm, 0.5 mm pitch 176-pin LQFP, 24*24 mm, 0.5 mm pitch 100-pin MAPBGA, 11*11 mm, 1 mm ball pitch	48-pin LQFP, 7*7 mm, 0.5 mm pitch 64-pin LQFP, 10*10 mm, 0.5 mm pitch
Voltage range	2.7 V to 5.5 V		3.13 V to 5.5 V
Temperature range (T _A)	-40 °C to 125 °C	-40 °C to 125 °C ¹²	-40 °C to 150 °C
Temperature range (T _J)	-40 °C to 135 °C		-40 °C to 175 °C
System			
Central processing unit (CPU)	Arm Cortex-M0+	Arm Cortex-M4F	
Maximum CPU frequency	48 MHz	112 MHz ^{1, 2}	80 MHz
Digital signal processor (DSP)	No	Yes	
Floating point unit (FPU)	No	Yes	
System memory protection unit (MPU) ³	Yes		
Code Cache size	Not available	4 KB	
Nested vectored Interrupt controller (NVIC)	up to 48 interrupts 4 programmable interrupt priority levels	up to 240 vectored interrupts 16 programmable interrupt priority levels	
Wake-up interrupt controller (WIC)	Yes		
Direct memory access (DMA)	4 channels	16 channels	
Direct memory access multiplexer (DMAMUX)	Yes		
Non-maskable interrupt (NMI)	Yes		
Software watchdog	Yes		
Hardware watchdog	Not available	Yes, with external monitor pin.	
Debug	2-pin serial wire debug (SWD)		
	Available only for BSR	IEEE 1149.1 Joint Test Access Group (JTAG)	
Trace	MTB	Trace Port Interface Unit (TPIU)	
Boundary scan	Yes		
Unique Identification (ID) Number	128-bit wide		
Memory			
Program flash memory	up to 256 KB	up to 2MB	upto 512 KB

Table continues on the next page...

Table 2-1. Device feature summary (continued)

Feature	S32K11x product series	S32K14x product series	S32K14xW product series
FlexMemory	32 KB Data flash (D-flash)/emulated EEPROM backup (E-Flash) memory: 2 KB additional FlexRAM supporting high-endurance, non-volatile emulated EEPROM	64 KB Data flash (D-flash)/emulated EEPROM ² backup (E-Flash) memory: 4 KB additional FlexRAM supporting high-endurance, non-volatile emulated EEPROM	
Flash memory controller cache	Yes (single speculative prefetch buffer only)		
Flash memory access control (FAC)	No		
Random-access memory (RAM)	Up to 25 KB. 2 KB is part of the EEERAM solution	Up to 256 KB. 4 KB is part of the EEERAM solution	Up to 64 KB. 4 KB is part of the EEERAM solution
Low-leakage standby memory	RAM retained in all modes		
QuadSPI	Not available	Supports SDR and HyperRAM modes upto 4 and 8 bidirectional data lines respectively	Not available
Cyclic redundancy check (CRC)	16- or 32-bit CRC with programmable generator polynomial		
Clocks			
System clock generator (SCG)	OSC, FIRC, SIRC	OSC, FIRC, SIRC, PLL	
External crystal oscillator or resonator	OSC: 4 - 40 MHz with low power or full-swing		
External square wave input clock	DC to 50 MHz		
Internal clock references (IRC)	48 MHz internal IRC (FIRC) with 1.1% max deviation across full temperature 8 MHz internal IRC (SIRC) with 3.3% maximum deviation across full temperature	48 MHz internal IRC (FIRC) with 1.4% max deviation across full temperature 8 MHz internal IRC (SIRC) with 3.3 % maximum deviation across full temperature	
Phase-locked loop (PLL)	Not available	Up to 320 MHz VCO	Up to 320 MHz VCO
Human-Machine Interface (HMI)			
General-purpose input/output (GPIO)	Up to 58 GPIOs	Up to 156 GPIOs	Up to 58 GPIOs
	Pin interrupt / DMA request capability		
	Configurable digital glitch filter		
	Hysteresis, pull up and pull down control on all input pins		
	Passive input filter on NMI_b and RESET_B input pins		
	High drive capability on up to 32 pins		
Analog			
Power management controller (PMC)	Low voltage warning Internal regulators offering various power modes		

Table continues on the next page...

Table 2-1. Device feature summary (continued)

Feature	S32K11x product series	S32K14x product series	S32K14xW product series
	128 kHz LPO clock		
12-bit analog-to-digital converter	1 Msps with 12-bit mode		
	1.2 Msps with 10-bit mode		
	Up to 32 single-ended external channels	Up to 64 single-ended external channels	Up to 29 single-ended external channels
	Up to 32 control and result registers	Up to 64 control and result registers	Up to 29 control and result registers
	Support result compare		
High-speed comparator (CMP)	Comparator with own 8-bit DAC		
Timers			
Programmable delay block (PDB)	PDB0 with up to 4 ADC channels with 8 pre-triggers for each channel for ADC0 1 pulse-out channel		PDB0 with up to 2 ADC channels with 8 pre-triggers for each channel for ADC0 1 pulse-out channel
	Not available	PDB1 with up 4 ADC channel with 8 pre-triggers for each channel for ADC1 1 pulse-out channel	PDB1 with up 2 ADC channel with 8 pre-triggers for each channel for ADC1 1 pulse-out channel
Flexible timer (FTM)	16-bit, 16 channels	16-bit, 64 channels	16-bit, 32 channels
	GTB and Global Load		
	Up to 2 with Quadrature Decoder		
	Deadtime by Pair		
	Up to 2 with Dither enable		
32-bit Low-power programmable interrupt timer (LPIT)	4 independent channels		
Real-time clock (RTC)	Yes		
Low-power timer (LPTMR)	LPTMR		
	1-channel, 16-bit pulse counter or Periodic interrupt		
Communication Interfaces			
Ethernet controller	Not available	Dual-speed 10/100-Mbit/s Ethernet MAC compliant with the IEEE802.3-2002 standard. Compatible with half- or full-duplex 10/100-Mbit/s Ethernet LANs	Not available
Control Area Network (CAN)	With optional ISO CAN-FD support		
FlexIO	Capable of supporting a wide range of protocols (UART, I2C, SPI, I2S) and PWM/waveform generation		
Low Power Serial peripheral interface (LPSPI)	DMA support, 4 word FIFO support on all LPSPIs		
Low Power Inter-Integrated Circuit (LPI2C)	Standard SMBUS compatible I ² C 4 word FIFO support on LPI ² C0		

Table continues on the next page...

Table 2-1. Device feature summary (continued)

Feature	S32K11x product series	S32K14x product series	S32K14xW product series
	DMA support 1 Mbps ability (even with maximum I ² C bus loading of 400 pF) Only high-drive pins are able to support 1 Mbps		
Low Power UART (LPUART)	Supports LIN protocol versions 1.3, 2.0, 2.1, 2.2A, and SAE J2602 Standard features Configurable from 4x to 32x oversampling LIN slave operation support 32-bit data width All LPUARTs support DMA and 4-word FIFO		
SAI	Not available	Supports full duplex serial interfaces with frame synchronization such as I2S, AC97, TDM, and codec/DSP interfaces.	Not available

1. HSRUN mode is limited to a maximum ambient temperature of 105°C T_A
2. CSEc (Security) or EEPROM writes/erase will trigger error flags in HSRUN mode (112 MHz) because this use case is not allowed to execute simultaneously. The device need to switch to RUN mode (80 Mhz) to execute CSEc (Security) or EEPROM writes/erase.
3. On this device, NXP's system MPU implements the safety mechanisms to prevent masters from accessing restricted memory regions. This system MPU provides memory protection at the level of the Crossbar Switch. Each Crossbar master (Core, DMA, Ethernet) can be assigned different access rights to each protected memory region. The Arm M4 core version in this family does not integrate the Arm Core MPU, which would concurrently monitor only core-initiated memory accesses. In this document, the term MPU refers to NXP's system MPU.

2.4 Block diagram

The following figure shows block diagram of the S32K14x product series.

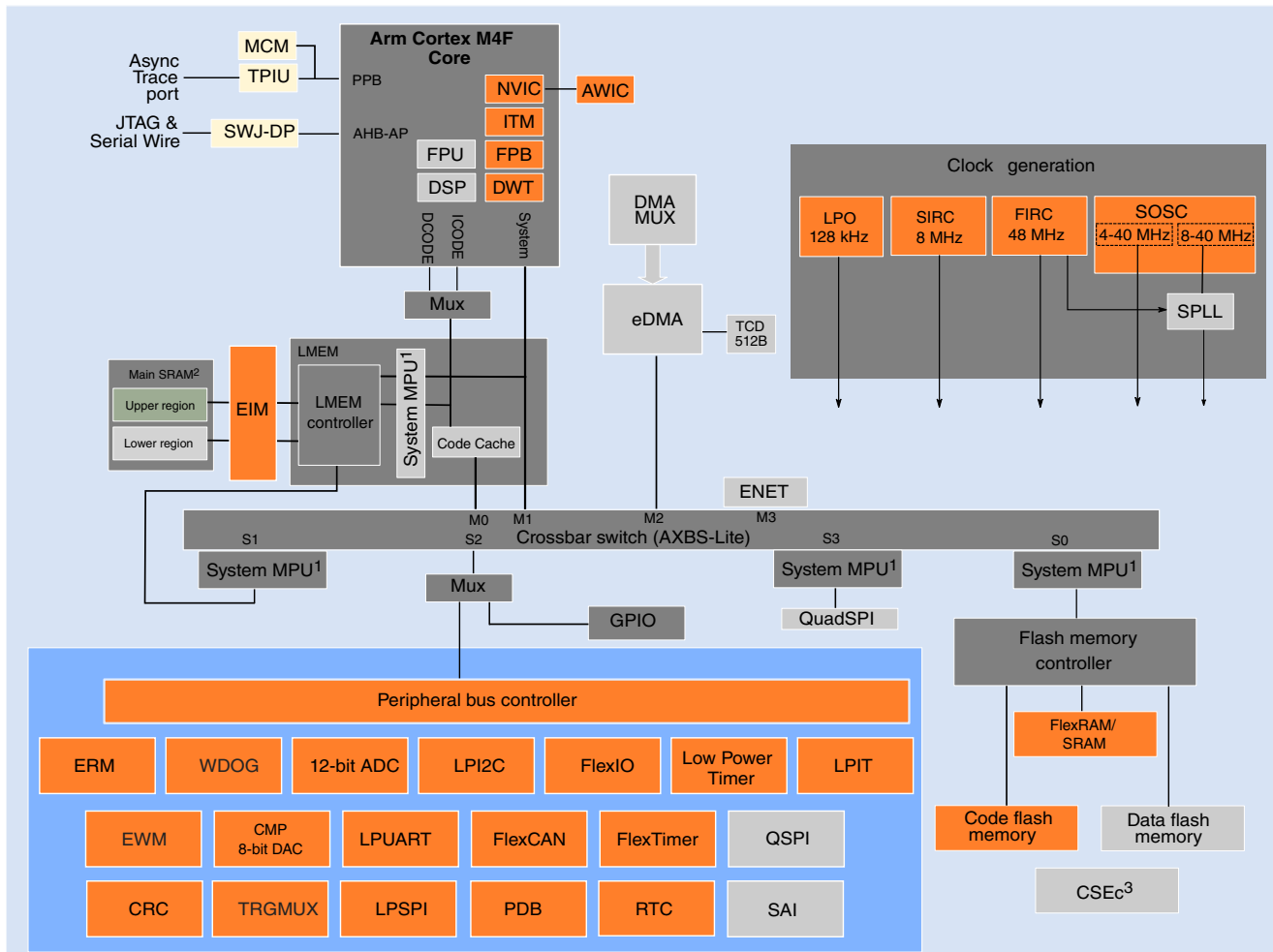

1: On this device, NXP's system MPU implements the safety mechanisms to prevent masters from accessing restricted memory regions. This system MPU provides memory protection at the level of the Crossbar Switch. Each Crossbar master (Core, DMA, Ethernet) can be assigned different access rights to each protected memory region. The Arm M4 core version in this family does not integrate the Arm Core MPU, which would concurrently monitor only core-initiated memory accesses. In this document, the term MPU refers to NXP's system MPU.

2: For the device-specific sizes, see the "On-chip SRAM sizes" table in the "Memories and Memory Interfaces" chapter of the S32K1xx Series Reference Manual.

3: CSEc (Security) or EEPROM writes/erase will trigger error flags in HSRUN mode (112 MHz) because this use case is not allowed to execute simultaneously. The device need to switch to RUN mode (80 MHz) to execute CSEc (Security) or EEPROM writes/erase.

Key:

- Device architectural IP on all S32K devices
- Peripherals present on all S32K devices
- Peripherals present on selected S32K devices (see the "Feature Comparison" section)

Figure 2-1. S32K14x and S32K14xW product series block diagram

The following figure shows block diagram of the S32K11x product series.

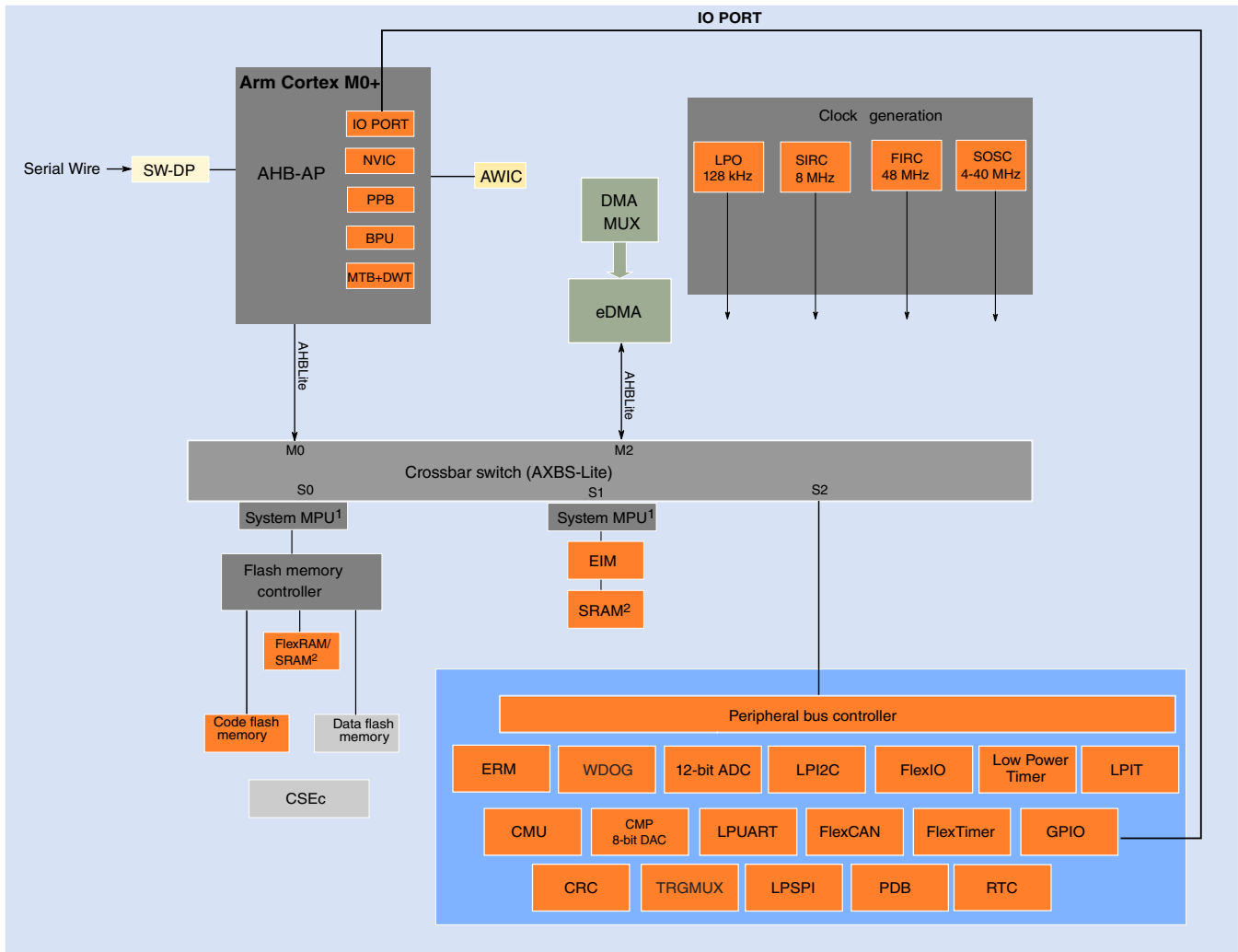

1: On this device, NXP's system MPU implements the safety mechanisms to prevent masters from accessing restricted memory regions. This system MPU provides memory protection at the level of the Crossbar Switch. Crossbar master (Core, DMA) can be assigned different access rights to each protected memory region. The Arm M0+ core version in this family does not integrate the Arm Core MPU, which would concurrently monitor only core-initiated memory accesses. In this document, the term MPU refers to NXP's system MPU.

2: For the device-specific sizes, see the "On-chip SRAM sizes" table in the "Memories and Memory Interfaces" chapter of the S32K1xx Series Reference Manual.

Device architectural IP on all S32K devices
Peripherals present on all S32K devices
Peripherals present on selected S32K devices (see the "Feature Comparison" section)

Figure 2-2. S32K11x product series block diagram

2.5 Feature comparison

The following figure summarizes the memory, peripherals and packaging options for the S32K1xx and S32K14xW devices. All devices which share a common package are pin-to-pin compatible.

NOTE

Availability of peripherals depends on the pin availability in a particular package. For more information see *IO Signal*

Description Input Multiplexing sheet(s) attached with Reference Manual.

Parameter	S32K11x		S32K14x			
	K116	K118	K142	K144	K146	K148
Core	Arm® Cortex™-M0+		Arm® Cortex™-M4F			
Frequency	48 MHz		80 MHz (RUN mode) or 112 MHz (HSRUN mode) ¹			
IEEE-754 FPU	○		●			
Cryptographic Services Engine (CSEc) ¹	●		●			
CRC module	1x		1x			
ISO 26262	capable up to ASIL-B		capable up to ASIL-B			
Peripheral speed	up to 48 MHz		up to 112 MHz (HSRUN)			
Crossbar	●		●			
DMA	●		●			
External Watchdog Monitor (EWM)	○		●			
Memory Protection Unit (MPU)	●		●			
FIRC CMU	●		○			
Watchdog	1x		1x			
Low power modes	●		●			
HSRUN mode ¹	○		●			
Number of I/Os	up to 43	up to 58	up to 89		up to 128	up to 156
Single supply voltage	2.7 - 5.5 V		2.7 - 5.5 V			
Ambient Operation Temperature (T _a)	-40°C to +105°C / +125°C		-40°C to +105°C / +125°C			
Flash	128 KB	256 KB	256 KB	512 KB	1 MB	2 MB ²
Error Correcting Code (ECC)	●		●			
System RAM (including FlexRAM and MTB)	17 KB	25 KB	32 KB	64 KB	128 KB	256 KB
FlexRAM (also available as system RAM)	2 KB		4 KB			
Cache	○		4 KB			
EEPROM emulated by FlexRAM ¹	2 KB (up to 32 KB D-Flash)		4 KB (up to 64 KB D-Flash)			See footnote 3
External memory interface	○		○			QuadSPI incl. HyperBus™
Low Power Interrupt Timer (LPIT)	1x		1x			
FlexTimer (16-bit counter) 8 channels	2x (16)		4x (32)		6x (48)	8x (64)
Low Power Timer (LPTMR)	1x		1x			
Real Time Counter (RTC)	1x		1x			
Programmable Delay Block (PDB)	1x		2x			
Trigger mux (TRGMUX)	1x (43)	1x (45)	1x (64)		1x (73)	1x (81)
12-bit SAR ADC (1 Msps each)	1x (13)	1x (16)	2x (16)		2x (24)	2x (32)
Comparator with 8-bit DAC	1x		1x			
10/100 Mbps IEEE-1588 Ethernet MAC	○		○		1x	
Serial Audio Interface (AC97, TDM, I2S)	○		○		2x	
Low Power UART/LIN (LPUART) (Supports LIN protocol versions 1.3, 2.0, 2.1, 2.2A, and SAE J2602)	2x		2x	3x		
Low Power SPI (LPSPI)	1x	2x	2x	3x		
Low Power I2C (LPI2C)	1x		1x			2x
FlexCAN (CAN-FD ISO/CD 11898-1)	1x (1x with FD)		2x (1x with FD)	3x (1x with FD)	3x (2x with FD)	3x (3x with FD)
FlexIO (8 pins configurable as UART, SPI, I2C, I2S)	1x		1x			
Debug & trace	SWD, MTB (1 KB), JTAG ⁴		SWD, JTAG (ITM, SWV, SWO)			SWD, JTAG (ITM, SWV, SWO), ETM
Ecosystem (IDE, compiler, debugger)	NXP S32 Design Studio (GCC) + SDK, IAR, GHS, Arm®, Lauterbach, iSystems		NXP S32 Design Studio (GCC) + SDK, IAR, GHS, Arm®, Lauterbach, iSystems			
Other	32-pin QFN 48-pin LQFP	48-pin LQFP 64-pin LQFP	48-pin LQFP 64-pin LQFP 100-pin LQFP	48-pin LQFP 64-pin LQFP 100-pin LQFP 100-pin MAPBGA	64-pin LQFP 100-pin MAPBGA 100-pin LQFP 144-pin LQFP	100-pin MAPBGA 100-pin LQFP ⁶ 144-pin LQFP 176-pin LQFP

LEGEND:

○ Not implemented

● Available on the device

1 No write or erase access to Flash module, including Security (CSEc) and EEPROM commands, are allowed when device is running at HSRUN mode (112MHz) or VLPR mode.

2 Available when EEPROM, CSEc and Data Flash are not used. Else only up to 1,984 KB is available for Program Flash.

3 4 KB (up to 512 KB D-Flash as a part of 2 MB Flash). Up to 64 KB of flash is used as EEPROM backup and the remaining 448 KB of the last 512 KB block can be used as Data flash or Program flash. See chapter FTFC for details.

4 Only for Boundary Scan Register

5 See Dimensions section for package drawings

6 QuadSPI is not supported for S32K148 in 100-pin LQFP

Figure 2-3. S32K1xx product series comparison

Feature comparison

		S32K14xW		
Parameter		S32K144W	S32K142W	
System	Core	Arm® Cortex™-M4F		
	Frequency	up to 80 MHz		
	IEEE-754 FPU	•		
	Cryptographic Services Engine (CSEc)	•		
	CRC module	1x		
	ISO 26262	capable up to ASIL-B		
	Peripheral speed	up to 80 MHz		
	Crossbar	•		
	DMA	•		
	External Watchdog Monitor (EWM)	•		
	Memory Protection Unit (MPU)	•		
	FIRC CMU	○		
	Watchdog	•		
	Low power modes	•		
	HSRUN mode	○		
	Memory	Number of I/Os	43 (48-pin LQFP)	58 (64-pin LQFP)
		Single supply voltage	3.13 - 5.5 V	
Ambient Operation Temperature (T _a)		-40°C to +150°C		
Flash		512 KB	256 KB	
Error Correcting Code (ECC)		•		
System RAM (including FlexRAM)		64 KB	32 KB	
FlexRAM		4 KB		
Cache		4 KB		
EEPROM emulated by FlexRAM		4 KB (up to 64 KB D-Flash)		
External memory interface		○		
Timer	Low Power Interrupt Timer (LPIT)	1x		
	FlexTimer (16-bit counter) 8 channels	48-pin LQFP: 4x (26 channels)	64-pin LQFP: 4x (30 channels)	
	Low Power Timer (LPTMR)	1x		
	Real Time Counter (RTC)	1x		
	Programmable Delay Block (PDB)	2x		
Analog	Trigger mux (TRGMUX)	1x (59)		
	12-bit SAR ADC (1 Msps each)	48-pin LQFP: 1x (14 channels), 1x(9 channels) 64-pin LQFP: 1x (16 channels), 1x(13 channels)		
	Comparator with 8-bit DAC	48-pin LQFP: 1x (6 channels)	64-pin LQFP: 1x (8 channels)	
Communication	10/100 Mbps IEEE-1588 Ethernet MAC	○		
	Serial Audio Interface (AC97, TDM, I2S)	○		
	Low Power UART/LIN (LPUART) (Supports LIN protocol versions 1.3, 2.0, 2.1, 2.2A, and SAE J2602)	48-pin LQFP: 2x	64-pin LQFP: 3x	
	Low Power SPI (LPSPi)	48-pin LQFP: 2x	64-pin LQFP: 3x	
	Low Power I2C (LPI2C)	1x		
	FlexCAN (CAN-FD ISO/CD 11898-1)	48-pin LQFP: 2x(2x FD)	64-pin LQFP: 2x(2x FD)	
IDEs	FlexIO (8 pins configurable as UART, SPI, I2C, I2S)	1x		
	Debug & trace	SWD, JTAG (ITM, SWV, SWO)		
Other	Ecosystem (IDE, compiler, debugger)	NXP S32 Design Studio (GCC) + SDK, IAR, GHS, Arm®, Lauterbach, iSystems		
	Packages ¹	48-pin LQFP	64-pin LQFP	

LEGEND:

- Not implemented
- Available on the device

1 See Dimensions section of Datasheet for package drawings

Figure 2-4. S32K14xW product series comparison

2.5.1 Differences between S32K14x/S32K14xW, and S32K11x

Due to the differences in core and cache architecture between S32K11x and S32K14x/S32K14xW devices, their CPU execution and interrupt latency will be different which in turn will affect the observed time among the timers, and the associated events triggered by them. See [Arm Cortex-M4F Technical Reference Manual](#) and [Arm Cortex-M0+ Technical Reference Manual](#) for core architecture details. For more differences, see [AN11997](#), available at [nxp.com](#).

2.6 Applications

The S32K1xx product series are the ideal choices for general purpose automotive applications, which include but not limited to:

- Exterior and interior lighting
- HVAC
- Door/Window/Wiper/Seat controller
- BLDC/PMSM motor control
- Park assistant
- E-shifter
- TPMS
- Real time control in infotainment system
- Battery management system
- Human machine interface such as touch sense control
- Secured vehicle data transfer
- Safety controller
- Over the air update ⁵

Moreover, the 100 Mbit IEEE-1588 Ethernet MAC and Serial audio interface (AC97, TDM, and I2S) on S32K148 make it fit perfectly for Ethernet connected edge nodes in vehicle, and the audio streaming application.

In addition to automotive applications, the S32K1xx product series can also be used in challenging environments found in industrial, automation, communications, transportation, medical and A & D applications which need high level quality, reliability and safety.

NOTE

- For safety aware and critical application, the user must refer to S32K1xx Safety Manual and [Using the S32K1xx EEPROM Functionality](#) application note available on [nxp.com](#) for correct part operation requirements.
- See S32K1xx Safety Manual and [Production Flash Programming Best Practices for S32K1xx MCUs](#)

5. See [S32K Architecture and Capabilities to Enable Over the Air Updates](#)

application note available on nxp.com for correct part operation and memory handling during programming of the internal flash memory.

2.7 Module functional categories

The modules on this device are grouped into functional categories. The following sections describe the modules assigned to each category in more detail.

Table 2-2. Module functional categories

Module category	Description
Arm® Cortex®-M4F core	<ul style="list-style-type: none"> 32-bit MCU core from Arm's Cortex-M class adding DSP instructions and single-precision floating point unit based on Armv7 architecture
Arm® Cortex®-M0+ core	<ul style="list-style-type: none"> 32-bit MCU core from Arm's Cortex-M class, implements the Armv6-M architecture profile.
System	<ul style="list-style-type: none"> Miscellaneous control module (MCM) System integration module (SIM) Port Control and Interrupts (PORT) General purpose input/output controller (GPIO) Crossbar switch (AXBS-Lite) Peripheral bridge (AIPS-Lite) Trigger Mux Control (TRGMUX) Watchdog timer (WDOG) Cyclic Redundancy Check (CRC)
Clocking	<ul style="list-style-type: none"> Multiple clock generation options available from internally- and externally-generated clocks System oscillator to provide clock source for the MCU
Memories	<ul style="list-style-type: none"> Internal memories include: <ul style="list-style-type: none"> Program flash memory FlexMemory <ul style="list-style-type: none"> FlexNVM FlexRAM SRAM Direct memory access (DMA) controller with multiplexer to increase available DMA requests. DMA can now handle transfers in VLPS mode
Power Management	Power management and mode controllers (PMC) <ul style="list-style-type: none"> Multiple power modes available based on high speed run, run, stop
Security	<ul style="list-style-type: none"> Error-correcting code (ECC) on Flash and SRAM memories 128-bit unique identification (ID) number System Memory Protection Unit (MPU) module
Safety	Clock monitoring unit (CMU), for monitoring FIRC clock
Power Management	Power management and mode controllers (PMC) <ul style="list-style-type: none"> Multiple power modes available based on high speed run, run, stop
Analog	<ul style="list-style-type: none"> High speed analog-to-digital converter (ADC) Comparator (CMP), containing 8 bit reference DAC Bandgap voltage reference (1V reference voltage)
Timers	<ul style="list-style-type: none"> Programmable delay block (PDB) FlexTimers

Table continues on the next page...

Table 2-2. Module functional categories (continued)

Module category	Description
	<ul style="list-style-type: none"> • Low-power periodic interrupt timer (LPIT) • Low power timer (LPTMR) • Independent real time clock (RTC)
Communications	<ul style="list-style-type: none"> • Ethernet MAC with IEEE802.3-2002 standard. • Low-power Serial peripheral interface (LPSPi) • Low-power Inter-integrated circuit (LPI2C) • Low-power UART (LPUART) • Synchronous Audio Interface (SAI)/Integrated interchip sound (I2S) • FlexIO • FlexCAN
Debug	<ul style="list-style-type: none"> • JTAG Controller (JTAGC)

2.7.1 Arm® Cortex®-M4F Core Modules

The following core modules are available on this device.

Table 2-3. Core modules

Module	Description
Arm Cortex-M4F	The Arm® Cortex®-M4F is the newest member of the Cortex M Series of processors targeting microcontroller cores focused on very cost sensitive, deterministic, interrupt driven environments. The Cortex M4F processor is based on the Armv7 Architecture and Thumb®-2 ISA and is upward compatible with the Cortex M3, Cortex M1, and Cortex M0 architectures. Cortex M4F improvements include an Armv7 Thumb-2 DSP (ported from the Armv7-A/R profile architectures) providing 32-bit instructions with SIMD (single instruction multiple data) DSP style multiply-accumulates and saturating arithmetic.
Floating point unit (FPU)	A single-precision floating point unit (FPU) that is compliant to the <i>IEEE Standard for Floating-Point Arithmetic</i> (IEEE 754).
NVIC	The Armv7-M exception model and nested-vector interrupt controller (NVIC) implement a relocatable vector table supporting many external interrupts, a single non-maskable interrupt (NMI), and priority levels. The NVIC replaces shadow registers with equivalent system and simplified programmability. The NVIC contains the address of the function to execute for a particular handler. The address is fetched via the instruction port allowing parallel register stacking and look-up. The first sixteen entries are allocated to Arm internal sources, with the others mapping to MCU-defined interrupts.
AWIC	The primary function of the Asynchronous Wake-up Interrupt Controller (AWIC) is to detect asynchronous wake-up events in stop modes and then signal to clock control logic to resume system clocking. After clock restart, the NVIC observes the pending interrupt and performs the normal interrupt or event processing.
Debug interfaces	Most of the debug capability on this device is based on the Arm CoreSight™ architecture. Following debug interfaces are supported: <ul style="list-style-type: none"> • Serial wire IEEE 1149.1 JTAG debug Port (SWJ-DP), with 2 pin serial wire debug (SWD) for external debugger • Debug Watchpoint and Trace (DWT), with four configurable comparators as hardware watchpoints

Table 2-3. Core modules

Module	Description
	<ul style="list-style-type: none"> Serial wire output (SWO)-synchronous trace data support Instrumentation Trace Macrocell (ITM) with software and hardware trace, plus time stamping Flash Patch and Breakpoints (FPB) with ability to patch code and data from code space to system space Serial Wire Viewer (SWV): A trace capability providing displays of reads, writes, exceptions, PC Samples and printf. Supports 4 pin trace interface

2.7.2 Arm Cortex-M0+ Core Modules

The following core modules are available on this device.

Table 2-4. Core modules

Module	Description
Arm Cortex-M0+	The Arm® Cortex™-M0+processor is a configurable, multistage, 32-bit RISC processor. It has an AMBA AHB-Lite interface and includes an NVIC component. It also has optional hardware debug, single-cycle I/O interfacing, and memory-protection functionality. The processor can execute Thumb code and is compatible with other Cortex-M profile processors.
NVIC	NVIC features up to 32 external interrupt inputs, each with four levels of priority. It implements optional relocation of the vector table. It features dedicated Non-Maskable Interrupt (NMI) input, supports optional Wake-up Interrupt Controller (WIC), providing ultra-low power sleep mode support.
AWIC	The primary function of the Asynchronous Wake-up Interrupt Controller (AWIC) is to detect asynchronous wake-up events in stop modes and signal to clock control logic to resume system clocking. After clock restart, the NVIC observes the pending interrupt and performs the normal interrupt or event processing.
Single-cycle I/O Port	For high-speed, single-cycle access to peripherals, the Cortex-M0+ processor implements a dedicated single-cycle I/O port.
Debug interfaces	Most of this device's debug is based on the Arm CoreSight™ architecture. One debug interfaces are supported: <ul style="list-style-type: none"> Serial Wire Debug (SWD) Micro Trace Buffer (MTB)

2.7.3 System modules

The following system modules are available on this device.

Table 2-5. System modules

Module	Description
Miscellaneous control module (MCM)	The MCM includes miscellaneous control logic for Core and System modules.
System integration module (SIM)	The SIM includes miscellaneous device configuration and status registers.
PORT	The Port Control and Interrupt (PORT) module provides support for port control, digital filtering, and external interrupt functions.
GPIO	The general-purpose input and output (GPIO) module communicates to the processor core via a zero wait state interface for maximum pin performance. The GPIO registers support 8-bit, 16-bit or 32-bit accesses.
Crossbar switch (AXBS-Lite)	The AXBS-Lite connects bus masters and bus slaves, allowing all bus masters to access different bus slaves simultaneously and providing arbitration among the bus masters when they access the same slave.
System Memory protection unit (MPU)	The system MPU provides memory protection and task isolation. It concurrently monitors all bus master transactions for the slave connections.
Peripheral bridge (AIPS-Lite)	The AIPS-Lite converts the crossbar switch interface to an interface that allows access to a majority of peripherals on the device.
Direct memory access multiplexer (DMAMUX)	The DMAMUX selects from many DMA requests down to a smaller number for the DMA controller.
enhanced Direct Memory Access controller (eDMA)	The eDMA provides programmable channels with transfer control descriptors for data movement via dual-address transfers for 8-bit, 16-bit, 32-bit, 16-byte and 32-byte data values.
TRGMUX	The trigger multiplexer (TRGMUX) module allows software to configure the trigger sources for various peripherals.
External watchdog monitor (EWM)	The EWM is a redundant mechanism to the software watchdog module that monitors both internal and external system operation for fail conditions.
Software watchdog (WDOG)	The WDOG monitors internal system operation and forces a reset in case of failure. It can run from an independent 128 kHz low power oscillator with a programmable refresh window to detect deviations in program flow or system frequency.
CRC	Hardware CRC generator circuit using 16/32-bit shift register. Error detection for all single, double, odd, and most multi-bit errors, programmable initial seed value, and optional feature to transpose input data and CRC result via transpose register.

2.7.4 Memories and memory interfaces

The following memories and memory interfaces are available on this device.

Table 2-6. Memories and memory interfaces

Module	Description
Local memory controller(LMEM)	Manages simultaneous accesses to system RAM by multiple master peripherals and core. Also provide cache control, which improves system performance by providing single-cycle access to the instruction and data pipelines.
Miscellaneous System Control Module (MSCM)	The Miscellaneous System Control Module (MSCM) contains CPU configuration registers and on-chip memory controller registers.

Table continues on the next page...

Table 2-6. Memories and memory interfaces (continued)

Module	Description
Flash memory	<ul style="list-style-type: none"> • Program flash memory — non-volatile flash memory that can execute program code • FlexMemory — encompasses the following memory types: <ul style="list-style-type: none"> • FlexNVM — Non-volatile flash memory that can execute program code, store data, or backup emulated EEPROM data • FlexRAM — RAM memory that can be used as traditional SRAM or as high-endurance emulated EEPROM storage, and also accelerates flash programming
QuadSPI	The Quad Serial Peripheral Interface (QuadSPI) block acts as an interface to external serial flash device. It supports SDR and HyperRAM modes up to 4 and 8 bidirectional data lines respectively.
Flash memory controller	Manages the interface between the device and the on-chip flash memory.
SRAM	Internal system RAM.

2.7.5 Power Management

The following modules are available on this device for power management and system power modes control:

Table 2-7. Power Management modules

Module	Description
PMC	The PMC contains the internal voltage regulator, power on reset (POR) and the low voltage detect (LVD) system.
SMC	The System Mode Controller (SMC) is responsible for sequencing the system into and out of all low-power Stop and Run modes.

2.7.6 Clocking

The following clock modules are available on this device.

Table 2-8. Clock modules

Module	Description
System clock generator (SCG)	<p>The SCG provides several clock sources for the MCU that include:</p> <ul style="list-style-type: none"> • Phase-locked loop (PLL) — Voltage-controlled oscillator (VCO) • Fast internal reference clock (FIRC) — An internally-generated 48 MHz clock, which can be used as a clock source for other on-chip peripherals • Slow internal reference clock (SIRC) — An internally-generated 8 MHz clock, which can be used as a clock source for other on-chip peripherals • System oscillator (OSC) — The system oscillator, in conjunction with an external crystal or resonator, generates a reference clock for the MCU

Table continues on the next page...

Table 2-8. Clock modules (continued)

Module	Description
Low Power Oscillator (LPO)	An internally-generated low power clock with typical frequency of 128 kHz, which can be used as clock source for modules operational in low power modes.
Peripheral Clock Control (PCC)	Controls the clock selection for most modules.

2.7.7 Analog modules

The following analog modules are available on this device:

Table 2-9. Analog modules

Module	Description
12-bit analog-to-digital converters (ADC)	12-bit successive-approximation ADC
Analog comparators (CMP)	Compares two analog input voltages across the full range of the supply voltage.
8-bit digital-to-analog converters (DAC) within CMP	256-tap resistor ladder network which provides a selectable voltage reference for applications where a voltage reference is needed.

2.7.8 Timer modules

The following timer modules are available on this device:

Table 2-10. Timer modules

Module	Description
Programmable delay block (PDB)	<ul style="list-style-type: none"> • 16-bit resolution • 3-bit prescaler • Positive transition of trigger event signal initiates the counter • Supports multiple triggered delay output signals, each with an independently-controlled delay from the trigger event • Continuous-pulse output or single-shot mode supported, each output is independently enabled, with possible trigger events • Supports bypass mode • Supports DMA
Flexible timer module (FTM)	<ul style="list-style-type: none"> • Selectable FTM source clock, programmable prescaler • 16-bit counter supporting free-running or initial/final value, and counting is up or up-down • Input capture, output compare, and edge-aligned and center-aligned PWM modes • Operation of FTM channels as pairs with equal outputs, pairs with complementary outputs, or independent channels with independent outputs • Deadtime insertion is available for each complementary pair • Generation of hardware triggers • Software control of PWM outputs • Up to 4 fault inputs for global fault control

Table continues on the next page...

Table 2-10. Timer modules (continued)

Module	Description
	<ul style="list-style-type: none"> Configurable channel polarity Programmable interrupt on input capture, reference compare, overflowed counter, or detected fault condition and reload opportunity. Quadrature decoder with input filters, relative position counting, and interrupt on position count or capture of position count on external event DMA support for FTM events
Low-power periodic interrupt timer (LPIT)	<ul style="list-style-type: none"> Four general purpose interrupt timers Interrupt timers for triggering ADC conversions 32-bit counter resolution The counter is clocked by an asynchronous clock that can remain enabled in low power modes. DMA support Supports chaining of Timer channels
Low power timer (LPTMR)	<ul style="list-style-type: none"> Selectable clock for prescaler/glitch filter of 128 kHz (internal LPO), or internal reference clock Configurable glitch filter or prescaler with 16-bit counter 16-bit time or pulse counter with compare Interrupt generated on Timer Compare Hardware trigger generated on Timer Compare
Real-time clock (RTC)	<ul style="list-style-type: none"> 32-bit seconds counter with 32-bit alarm 16-bit prescaler with compensation that can correct errors between 0.12 ppm and 3906 ppm

2.7.9 Communication interfaces

The following communication interfaces are available on this device:

Table 2-11. Communication modules

Module	Description
Low-power Serial peripheral interface (LPSPi)	Synchronous serial bus for communication to an external device. LPSPi optionally remains functional in low power modes.
Low-power Inter-integrated circuit (LPI2C)	Allows communication between a number of devices. Also supports the System Management Bus (SMBus) Specification, version 2. LPI2C optionally remains functional in low power modes.
Low-power Universal asynchronous receiver/transmitters (LPUART)	Asynchronous serial bus communication interface, supporting LIN master and slave operation. LPUART optionally remains functional in low power modes.
SAI/I2S	The I2S (or I2S) module provides a synchronous audio interface (SAI) that supports full duplex serial interfaces with frame synchronization such as I2S, AC97, TDM, and codec/DSP interfaces.
ENET	The core implements a dual-speed 10/100-Mbit/s Ethernet MAC compliant with the IEEE802.3-2002 standard. The MAC layer provides compatibility with half- or full duplex 10/100-Mbit/s Ethernet LANs.
FlexCAN	The FlexCAN module is a communication controller implementing the CAN protocol according to the ISO 11898-1 standard and CAN 2.0 B protocol specifications.

2.7.10 Debug modules

The following Debug modules are available on this device:

Table 2-12. Debug modules

Module	Description
JTAGC	The JTAGC block provides the means to test chip functionality and connectivity while remaining transparent to system logic when not in test mode. Testing is performed via a boundary scan technique, as defined in the IEEE 1149.1-2001 standard. All data input to and output from the JTAGC block is communicated in serial format.

Chapter 3

Memory Map

3.1 Introduction

This chip contains various memories and memory-mapped peripherals that are located in one 32-bit contiguous memory space. This chapter describes the memory and peripheral locations within that memory space.

Details about the memory map appear in the spreadsheet that is attached to this document: S32K1xx_memory_map.xlsx. To access this spreadsheet, view the document's list of attachments.

3.2 SRAM memory map

3.2.1 S32K14x: SRAM memory map

The on-chip RAM is split in two regions: SRAM_L and SRAM_U. The RAM is implemented such that the SRAM_L and SRAM_U ranges form a contiguous block in the memory map. See S32K1xx_memory_map.xlsx attached to this document for details.

Accesses to the SRAM_L and SRAM_U memory ranges outside the amount of RAM on the chip causes the bus cycle to be terminated with an error followed by the appropriate response in the requesting bus master.

3.2.2 S32K11x: SRAM memory map

In S32K11x on-chip RAM can be used in following applications:

- Safety critical applications: SRAM_U can be used, which starts from 2000_0000
- Non-safety critical applications: SRAM_U along with 1 KB MTB can be used

NOTE

CM0+ architecture implements single RAM controller, hence SRAM_U and MTB are referred as single contiguous memory regions. MTB in S32K11x is present at the same location as SRAM_L in S32K14x.

See S32K1xx_memory_map.xlsx attached to this document for details. Accesses to the memory ranges outside the amount of RAM on the chip causes the bus cycle to be terminated with an error followed by the appropriate response in the requesting bus master.

3.3 Flash memory map

The various flash memories and the flash memory registers are located at different base addresses as shown in the following figure. The base address for each is specified in the S32K1xx_memory_map.xlsx file attached to this document.

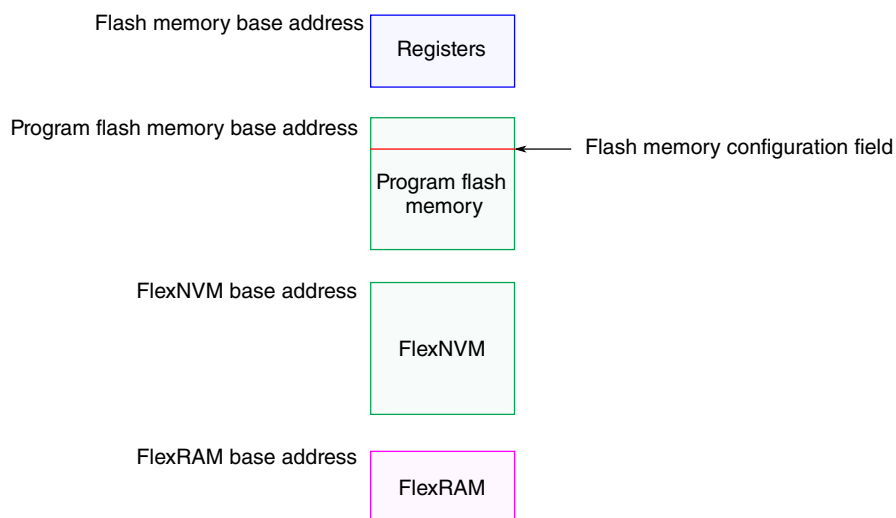

Figure 3-1. Flash memory map

3.4 Peripheral bridge (AIPS-Lite) memory map

The peripheral memory map is accessible via a crossbar slave port.

There are three regions associated with peripheral space, as shown in the following table.

Table 3-1. Regions associated with peripheral space

Address space	Region description
0x4000_0000–0x4001_FFFF	A 128 KB region, partitioned as 32 spaces, each 4 KB in size and reserved for on-platform peripheral devices. AIPS-Lite generates unique module enables for all 32 spaces.
0x4002_0000–0x4007_FFFF	A 384 KB region, partitioned as 96 spaces, each 4 KB in size and reserved for off-platform modules. AIPS-Lite generates unique module enables for all 96 spaces.
0x400F_F000	A 4 KB region for accessing the GPIO module. This block is connected to the AMBA bus via the port splitter and provides direct master access without incurring wait states associated with accesses via the AIPS-Lite modules. The GPIO is implemented only in the upper space of this region (4 KB beginning at 0x400F_F000).

Modules that are disabled via their clock gate control bits in the PCC/SIM registers disable the associated AIPS-Lite slots. Access to any address within an unimplemented or disabled peripheral bridge slot results in a transfer error termination.

NOTE

While trying to access memory map region of unavailable feature (See SIM_SDID[FEATURES]) with corresponding module clock enabled through PCC CGC bit, there will not be any transfer error termination.

3.4.1 Read-after-write sequence and required serialization of memory operations

In some situations, a write to a peripheral must be completed fully before a subsequent action can occur. Examples of such situations include:

- Exiting an interrupt service routine (ISR)
- Changing a mode
- Configuring a function

In these situations, the application software must perform a read-after-write sequence to guarantee the required serialization of the memory operations, as shown in the following table.

Table 3-2. Read-after-write sequence to guarantee required serialization of memory operations

Step	Action
1	Write the peripheral register.
2	Read the written peripheral register to verify the write.
3	Continue with subsequent operations.

NOTE

In S32K14x series of devices, one factor contributing to these situations is processor write buffering. The processor architecture has a programmable configuration field to disable write buffering: ACTLR[DISDEFWBUFF]. (For details see Arm® Cortex® M4 Processor Technical Reference Manual, Revision r0p1, at <http://arm.com>). However, disabling buffered writes is likely to degrade system performance much more than simply performing the required memory serialization for the situations that truly require it.

3.5 Private Peripheral Bus (PPB) memory map

The PPB is part of the defined Arm bus architecture and provides access to select processor-local modules. These resources are only accessible from the core; other system masters do not have access to them.

Table 3-3. PPB memory map for CM4

System 32-bit address range	Resource
0xE000_0000–0xE000_0FFF	Instrumentation Trace Macrocell (ITM)
0xE000_1000–0xE000_1FFF	Data Watchpoint and Trace (DWT)
0xE000_2000–0xE000_2FFF	Flash Patch and Breakpoint (FPB)
0xE000_3000–0xE000_DFFF	Reserved
0xE000_E000–0xE000_EFFF	System Control Space (SCS) (for NVIC and FPU)
0xE000_F000–0xE003_FFFF	Reserved
0xE004_0000–0xE004_0FFF	Trace Port Interface Unit (TPIU)
0xE004_1000–0xE004_1FFF	Reserved
0xE004_2000–0xE004_2FFF	Reserved
0xE004_3000–0xE004_3FFF	Reserved
0xE004_4000–0xE007_FFFF	Reserved
0xE008_0000–0xE008_0FFF	Miscellaneous Control Module (MCM)
0xE008_1000–0xE008_1FFF	Reserved
0xE008_2000–0xE008_2FFF	Cache Controller (LMEM)
0xE008_3000–0xE00F_EFFF	Reserved
0xE00F_F000–0xE00F_FFFF	Arm Core ROM Table ¹ - allows auto-detection of debug components

1. The Arm Core ROM table is optionally required by Arm CoreSight debug infrastructure to discover the components on the chip. This ROM table has no any relationship with the MCU Boot ROM.

Table 3-4. PPB memory map for CM0+

System 32-bit address range	Resource
0xE000_0000–0xE000_0FFF	Reserved ¹
0xE000_1000–0xE000_1FFF	Data Watchpoint and Trace (DWT)
0xE000_2000–0xE000_2FFF	Arm Core ROM Table
0xE000_3000–0xE000_DFFF	Reserved ¹
0xE000_E000–0xE000_EFFF	System Control Space (SCS) (for NVIC)
0xE000_F000–0xE003_FFFF	Reserved ¹
0xE004_0000–0xE004_0FFF	Reserved ¹
0xE004_1000–0xE004_1FFF	Reserved ¹
0xE004_2000–0xE004_2FFF	Reserved ¹
0xE004_3000–0xE004_3FFF	Reserved ¹
0xE004_4000–0xE007_FFFF	Reserved ¹
0xE008_0000–0xE008_0FFF	Reserved ¹
0xE008_1000–0xE008_1FFF	Reserved ¹
0xE008_2000–0xE008_2FFF	Reserved ¹
0xE008_3000–0xE00F_EFFF	Reserved ¹
0xE00F_F000–0xE00F_FFFF	Reserved ¹
0xE010_0000–0xEFFF_FFFF	Reserved ¹

1. Reserved area return transfer error. Reserved is Unknown/Should be 0. Software must not rely on reading as all 0s, and it must treat the value as if it is unknown.

3.6 Aliased bit-band regions for CM4 core

The SRAM_U, AIPS-Lite, and general purpose input/output (GPIO) module resources reside in the Cortex-M4F processor bit-band regions.

The processor also includes two 32 MB aliased bit-band regions associated with the two 1 MB bit-band spaces. Each 32-bit location in the 32 MB space maps to an individual bit in the bit-band region. A 32-bit write in the alias region has the same effect as a read-modify-write operation on the targeted bit in the bit-band region.

Bit 0 of the value written to the alias region determines what value is written to the target bit:

- Writing a value with bit 0 set writes a 1 to the target bit.
- Writing a value with bit 0 clear writes a 0 to the target bit.

A 32-bit read in the alias region returns either:

- a value of 0x0000_0000 to indicate the target bit is clear
- a value of 0x0000_0001 to indicate the target bit is set

Aliased bit-band regions for CM4 core

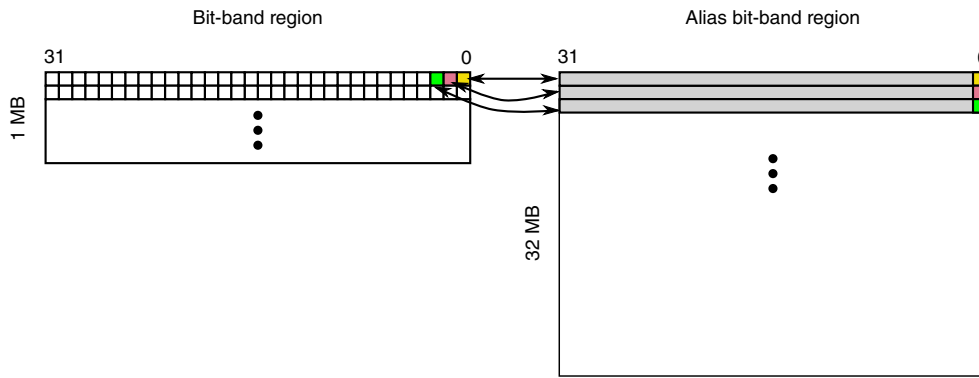

Figure 3-2. Alias bit-band mapping

NOTE

Each bit in a bit-band region has an equivalent bit that can be manipulated through bit 0 in a corresponding long word in the alias bit-band region.

NOTE

Do not use bit banding for w1c status bits.

CAUTION

The S32K product series and the software drivers support bit-banding, but Arm no longer promotes its usage. Therefore, we recommend that bit-banding should not be used.

Chapter 4

Signal Multiplexing and Pin Assignment

4.1 Introduction

The signal multiplexing enables the sharing of single pad for multiple functions.

The signal multiplexing unit comprises of control signals from [GPIO](#), [PORT](#) and pad interface logic. The signal multiplexing unit consists of several individual sub-units, each handling the signal multiplexing of one pad.

The Port Control block controls the module specific pad settings (pull up etc) and the signal present on the external pin. See [PORT_PCR](#) for the description of control signals. For reset values per port, see IO Signal Description Input Multiplexing sheet(s) attached to the Reference Manual.

4.2 Functional description

The signal multiplexing architectural implementation is as shown in the following figure.

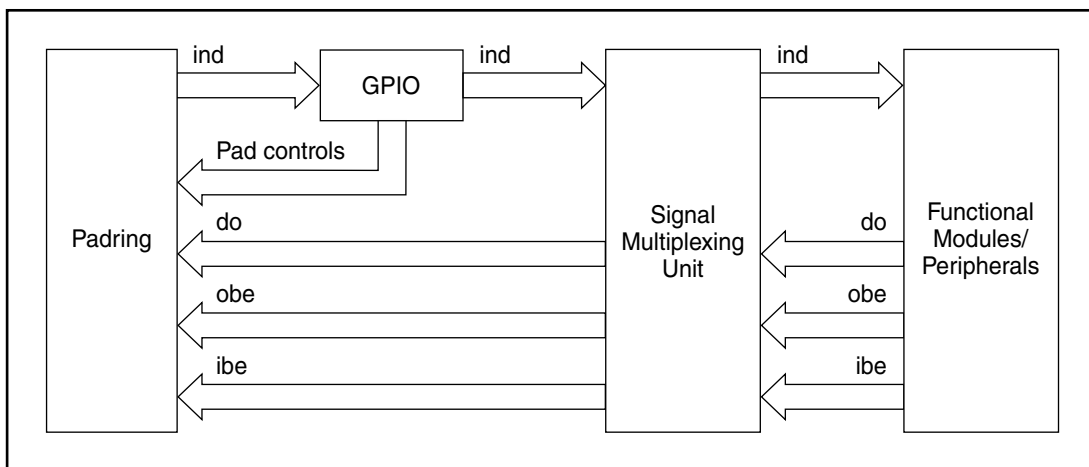

Figure 4-1. Signal Multiplexing

4.3 Pad description

Following figure shows the basic representation of a GPIO Pad.

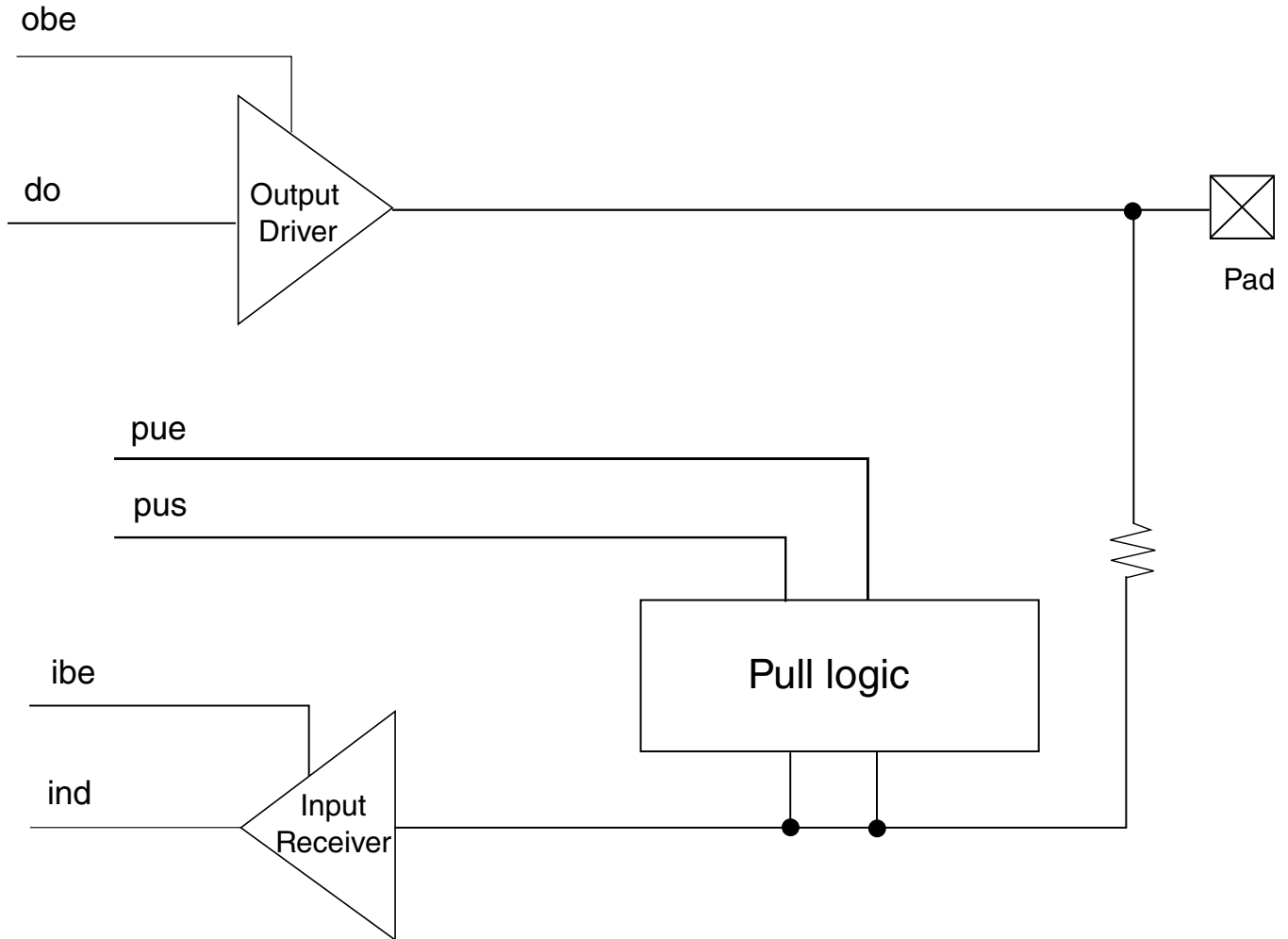

Figure 4-2. GPIO pad representation

Table 4-1. Pad Signal description

Signal name	Direction	Description
pad	I/O	I/O to external world
do	I	Data coming from the core into the pad
obe	I	Enable output driver
pue	I	0: Disable internal pullup or pulldown resistor 1: Enable internal pullup or pulldown resistor
pus	I	0: Enable internal pulldown resistor if pue is set 1: Enable internal pullup resistor if pue is set
ibe	I	Enable input receiver
ind	O	Data coming out of the pad into the core

Table 4-2. Truth table

obe	do	pad	Description
0	X	Z	Output buffer disabled, pad hi-Z (If not configured as input)
1	0/1	0/1	Output buffer enable, pad = do

pue	pus	pad	Description
0	0/1	-	Weak pull disabled. Pad retains previous state
1	0	0	Weak pull down enabled
1	1	1	Weak pull up enabled

ibe	pad	ind	Description
0	X	0	Input buffer disabled, ind gets low
1	0/1	0/1	Input buffer enabled, ind = pad

NOTE

The device does not support open drain on all the pins. Only pins that are configured for a protocol that requires open-drain (e.g., LPI2C, LPUART single-wire) will work in open-drain mode.

4.4 Default pad state

The default pad configurations out of reset are as follows. For PTA4, PTA5, PTC4 and PTC5, the default configurations are as per protocol specifications/requirements.

Table 4-3. Default pad configurations

Pin	Default function	Default pad state ¹	ibe	obe	pue	pus
PTA4	JTAG_TMS	Weak pull-up enabled	1	0	1	1
PTA5 ²	RESET_b	Weak pull-up enabled	1	0	1	1
PTC4	JTAG_TCK	Weak pull-down enabled	1	0	1	0
PTC5	JTAG_TDI	Weak pull-up enabled	1	0	1	1
Others	Disabled	High impedance	0	0	0	0

Signal Multiplexing sheet

1. The IO pad states are undefined until V_{DD} rises sufficiently to enable the POR circuits. The level at which this occurs will vary from device to device, but for reference it is approximately 700 mV. After POR circuits are enabled, the IO pad states are high impedance with weak pull devices disabled until POR release.
2. While in reset, the pin behavior is same apart from reset pin. Chip drives pad low via $obe=1$, $pue=0$, till reset sequence is complete to indicate reset to off-chip connected devices.

4.5 Signal Multiplexing sheet

IO Signal Description Input Multiplexing sheet(s) attached to the Reference Manual contains information on pins/balls of this device.

The 'IO Signal Table' and 'Input Muxing' tabs in the sheet correspond to the signal multiplexing information. The 'IO Signal Table' consists of all the pin muxing details and the 'Input Muxing' specifies the priority for the input muxing where an input path is driven by more than one pad.

S32K1xx variant specific IO Signal Description Input Multiplexing sheets attached to the Reference Manual contains information about the pins/balls of the particular variant. Module functionality is dependent on the availability of functional pins in a particular package. For example LPI2C HREQ pin is not available in 48-LQFP and 32-QFN package.

4.5.1 IO Signal Table

Following is an example snippet of IO Signal Table. For selecting any functionality, the pad PCR register (refer to PORT_PCRn) needs to be configured accordingly.

Port	CR	SSS	Function	Module	Description	Direction	Pad Type	PCR												Reset	Blls Configurable		
								S32K144_1001qfp	S32K144_641qfp	S32K144_B01A	ICE	INOC[3:0]	ILK	INUX[2:0]	DOE	DPE	DS	AS					
PTA0	PCR_PTA0	0000_0000	DISABLED		Signal Path Disabled		GPI0	79	50	A9	0	0000	0	0000	0	0	0	0	'00000000000000000000000000000000'	'00000001100011111000011100000011'			
		0000_0001	PTA0	PTA	Port A I/O	I/O																	
		0000_0010	FTM2_CH1	FTM2	FTM Channel	I/O																	
		0000_0011	LPI2C_SCL5	LPI2C0	LPI2C0	LPI2C Secondary Clock I/O	I/O																
		0000_0100	FXIO_D2	FXIO	FXIO	FlexIO Bi-directional Shift/timer I/O	I/O																
		0000_0101	FTM2_QD_PHA	FTM2	FTM2	FTM quadrature Decode PhaseA	I																
		0000_0110	LPUART0_CTS	LPUART0	LPUART0	Clear To Send (bar)	I																
		0000_0111	TRGMUX_OUT3	TRGMUX	TRGMUX	Trigger Mux Output	O																
		-	-	-	ADC0_S09	ADC0	ADC Single Ended Input	I															
		-	-	-	CMPO_IN0	CMPO	Comparator Input Signal	I															

Figure 4-3. IO signal table snippet

The columns of the above figure are described below:

- Port: This field in IO Signal Table specifies the PAD names of the device.
- CR(Control Register): This field specifies the name of PCR corresponding to the Port field. On this device there are five PORT instances, namely, PTA, PTB, PTC, PTD and PTE. Each pad has a corresponding Control Register, referred to as PCR_PTXn

in the IO Signal Table, where X refers to PORT instance and n refers to corresponding pin of that PORT instance. Refer PORT_PCR for description of PCR fields.

- SSS: This field specifies the ALT mode of operation as per PCR[Mux_mode]. Not all pins support all pin muxing slots. Unimplemented pin muxing slots are reserved. The corresponding pin is configured in the following pin muxing slot as follows:
 - 000: Alternative 0 (Signal path disabled)
 - 001: Alternative 1 (GPIO)
 - 010: Alternative 2 (chip-specific)
 - 011: Alternative 3 (chip-specific)
 - 100: Alternative 4 (chip-specific)
 - 101: Alternative 5 (chip-specific)
 - 110: Alternative 6 (chip-specific)
 - 111: Alternative 7 (chip-specific)

The analog functionalities are specified with '-' in this field. Here ADC_SE0 and CMP_IN0 represent analog functions.

By default, ALT0 mode (configured by PTXn_PCR[SSS] as 3'b000) corresponds to disabled functionality and pad represents disabled (high-impedance) state. In case if the pad consists of analog functions, the ALT0 mode corresponds to analog functionality once the analog module is configured to enable corresponding channel/input.

For example, PTA0 supports ADC0 channel 0 and CMP channel 0. By default the pad is disabled. After ADC0 is configured to enable channel0 using ADC0_SC1n[ADCH], the pad functions as ADC input channel. Alternatively if CMP is configured to enable channel 0 using CMP_C1[PSEL] or CMP_C1[MSEL], the pad functions as CMP input channel. The software must ensure to enable only one function at a time.

- Function: This field specifies the functionality of the pad as per the corresponding ALT mode specified by SSS field.
- Module: The Module field contains the module which is governing the pad for the ALT mode.
- Description: This field mentions a short description of pad functionality.
- Direction: This field specifies the direction (Input, Output or Inout) of the pad for the concerned functionality.
- The next columns specify the pin number in the supported packages for the device.
- PCR: This field specifies the default PCR value for corresponding pad. Refer PORT_PCR for description of PCR fields.

- The next two columns specify the reset value and the configurable bit fields of PCR corresponding to pad.
- Pad Type: This field mentions the pad type of the corresponding pad.
 - GPIO: General Purpose IO Pad (Standard)
 - GPIO-HD: General Purpose IO Pad that support high drive functionality (Strong)
 - GPIO-FAST: General Purpose IO Pad that support High Speed (applicable for S32K148 only)

NOTE

If oscillator is enabled then enabling the GPIO or LPI2C function for EXTAL/XTAL pins can lead to device damage. This must be avoided by software.

4.5.2 Input muxing table

As the same function can be multiplexed to several pads by configuring their respective PCRs, there is priority input muxing. In case of same input being driven from multiple pads, the one with highest priority (1 being the highest) will drive the input. Following is a snippet of Input Muxing Table.

Destination Instance	Destination Function	Priority	SSS	Source Instance	Source Signal
CAN0	CAN0_RX	1	0000_0011	IO_PAD	PTC2
		2	0000_0101	IO_PAD	PTE4
		3	0000_0101	IO_PAD	PTB0
		4		-	disable low

Figure 4-4. Input muxing table snippet

The columns of the figure are briefly described below:

- Destination Instance: This field contains the instance name of the input path to where the signal will propagate from padding.
- Destination Function: This field mentions the function name of the input path.
- Priority: This field specifies the priority of the path. Priority level 1 is highest and it decreases onwards.
- SSS: This field specifies the PCR[Mux_mode] value corresponding to the pad specified in source signal column. A blank is mentioned for the default source when none pad is driving the input path.
- Source Instance: This field specifies the source pad type. A blank is mentioned for the default source when none pad is driving the input path.
- Source Signal: This field mentions the pad name. A 'disable low'/'disable high' specifies the signal behavior when none of the pads are driving the input path.

4.6 Pinout diagrams

See IO Signal Description Input Multiplexing sheet(s) attached to the Reference Manual for pinout diagrams corresponding to available packages.

Chapter 5

Security Overview

5.1 Introduction

All chips of this S32K1xx product series have a comprehensive set of customer-configurable security features designed to protect code and data from unauthorized access.

5.2 Device security

Flash memory security is available to both CSEc and non-CSEc parts. [SIM_SDID\[7\]](#) indicates whether CSEc is available on your device.

Both CSEc and non CSEc users need to run PGMPART command to configure the Key Size for the device. For more information, see [Program Partition command](#). This process involves configuring a number of user keys. For non CSEc users, Key Size will be 00.

- The total size of EEERAM is reduced by the space required to store the user keys. (See [Introduction](#) chapter for available EEERAM.)
- The user key space effectively becomes un-addressable space in the EEERAM.
- For non-CSEc parts and CSEc parts with key size=00, [CSEc_PRAM](#) access is not guaranteed.

5.2.1 Flash memory security

The flash memory module provides security information to the MCU based on the state held by the FSEC[SEC] field. The MCU, in turn, confirms the security request and limits access to flash memory resources. During reset, the flash memory module initializes the FSEC register using data read from the security byte of the flash memory configuration field.

NOTE

The security features apply only to external accesses via debug. CPU accesses to the flash memory are not affected by the status of FSEC.

In the unsecured state, all flash memory commands are available to the programming interfaces (SWD (Serial Wire Debug) and JTAG (Joint Test Access Group)), as are user code execution of Flash Memory Controller commands. When the flash memory is secured (FSEC[SEC] = 00b, 01b, or 11b), programmer interfaces are allowed to launch only mass erase operations and have no access to memory locations.

Further information regarding the flash memory security options and enabling/disabling flash security is available in the [Flash Memory Module](#).

5.2.1.1 Flash memory security interactions with debug

When flash memory security is active, the JTAG port cannot access the memory resources of the MCU. Boundary scan chain operations work, but debugging capabilities are disabled so that the debug port cannot read flash memory contents.

When flash memory security is active, the SWD port cannot access the memory resources of the MCU.

Although most debug functions are disabled, the debugger can write to the Flash Mass Erase in Progress bit in the MDM-AP Control register to trigger a mass erase (Erase All Blocks) command provided that MEEN (mass erase) is enabled. Running the mass erase de-asserts the FSEC and after that JTAG port can access the memory resources. A mass erase via the debugger is allowed even when some memory locations are protected.

When mass erase is disabled, mass erase via the debugger is blocked. Hence, you will not be able to connect the debugger in a secure device (MEEN disabled). An alternative in that case would be to run verify backdoor key access through any communication interface.

The FTFC_FCSESTAT[EDB] bit clear status is as follows:

- If the debugger has switched to SWD mode, the FTFC_FCSESTAT[EDB] bit can be reset only through POR.
- If the debugger remains in JTAG mode, the FTFC_FCSESTAT[EDB] bit is reset on pin_reset if correct debugger disconnection takes place or on POR.

5.2.2 Cryptographic Services Engine (CSEc) security features

The FTFC module's [Cryptographic Services Engine \(CSEc\)](#) implements a comprehensive set of cryptographic functions as described in the SHE Functional Specification, including:

- >10 general purpose keys
- AES-128, CBC, ECB, CMAC
- Sequential, Parallel, and Strict Boot mode
- AES-128 CMAC calculation and authentication
- Pseudo random number generation (PRNG) and true random number generation (TRNG)

5.2.3 Device Boot modes

In parallel secure boot mode, secure boot and application boot shall happen in parallel. Also even if the secure boot fails, the application shall boot. But Keys having BOOT_PROT attribute set to one, would be disabled. Application can make use of rest of the keys and encryption/decryption/SHE functions. However, application code should poll the Busy Flag FCSESTAT[BSY] , before attempting to actuate any SHE command. Additionally, during parallel secure boot, any mode transition initiated by Core will be aborted and secure boot will proceed.

During parallel boot operation FLASH_CLK must be the default FIRC_CLK and should not be changed until boot operation is complete. Once the boot operation is complete it can be changed to any value including its maximum value of 26.6 MHz in RUN mode and 28 MHz in HSRUN mode.

In Sequential Secure boot, Application shall boot only after successful completion of Secure boot. And, Application can actuate any command without bothering for FCSESTAT[BSY] flag. However, in Strict boot mode, the chip will not boot at all and will remain stuck in reset, if secure boot fails.

5.3 Security use case examples

5.3.1 Secure boot: check bootloader for integrity and authenticity

The following diagram illustrates a use case for detecting and preventing bootloader modification.

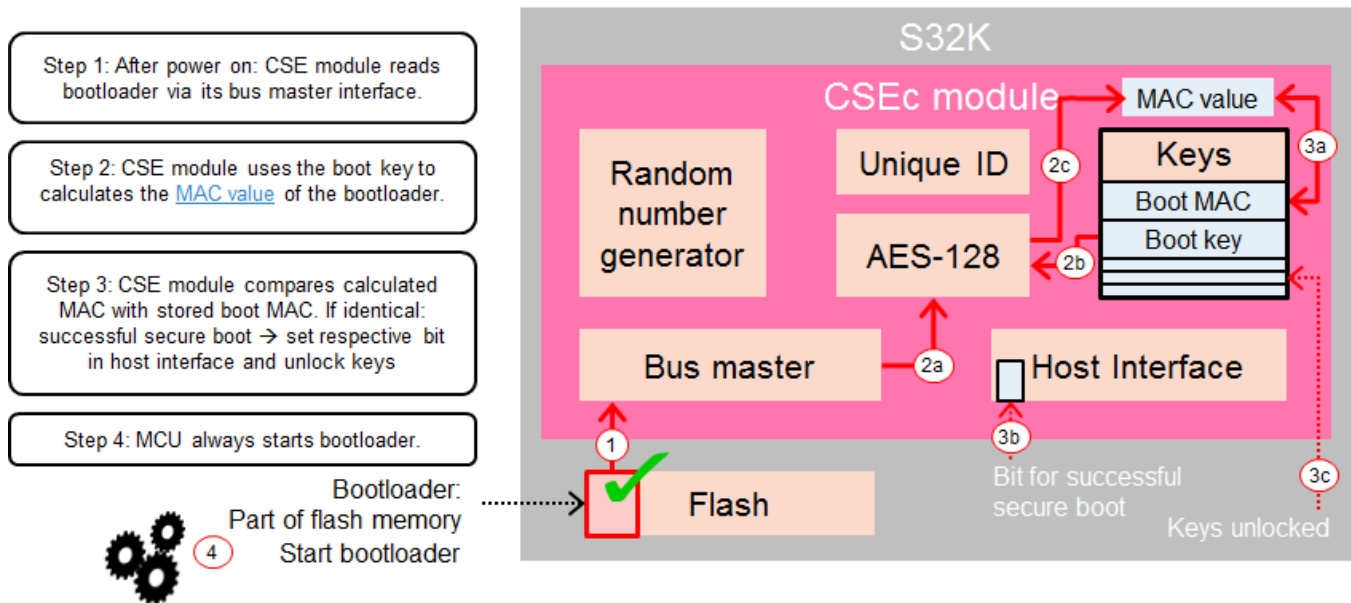

Figure 5-1. Bootloader integrity and authenticity

The MAC protects against modification of the bootloader and depends on the (secret) boot key.

Only if the calculated MAC value matches the stored boot MAC value: a successful secure boot occurs, and keys become unlocked for further use.

5.3.2 Chain of trust: check flash memory for integrity and authenticity

In this use case:

- The bootloader is protected by the secure boot process.
- MACs stored in the bootloader provide integrity and authenticity of the related parts in flash memory.
- Part-by-part checking of flash memory ensures each part's integrity and authenticity before executing it. Critical parts of flash memory (for example, MCU configuration/IRQ table) are checked and then executed as soon as possible.

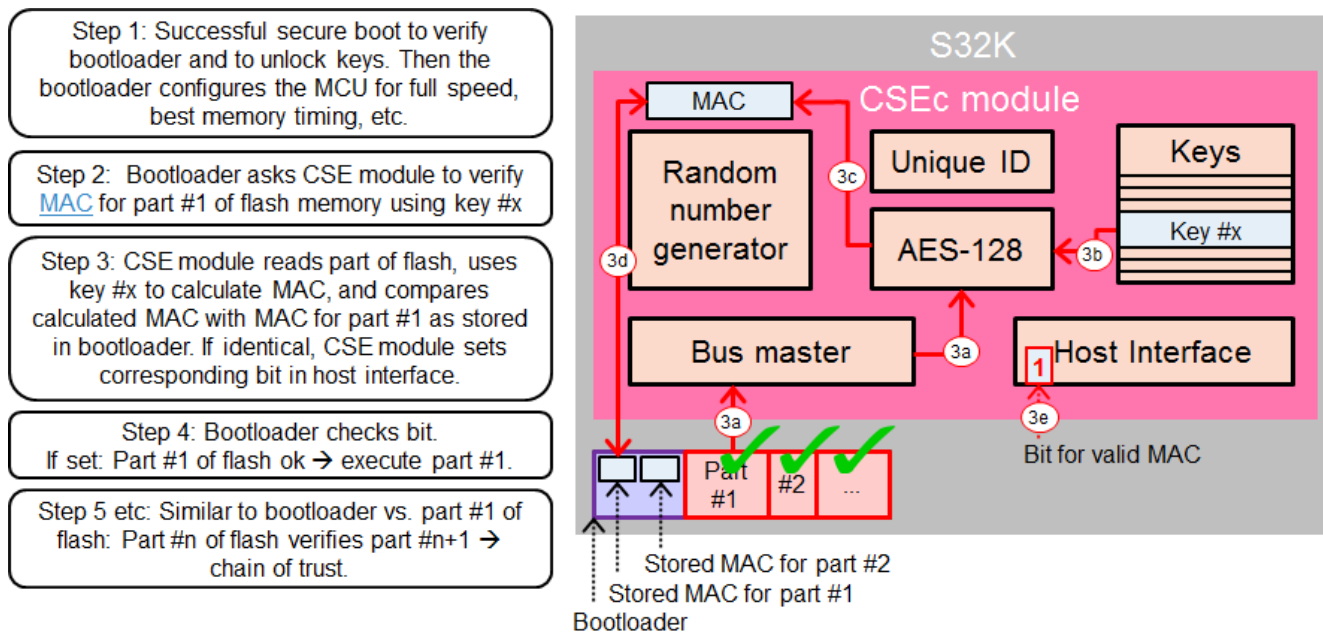

Figure 5-2. Flash memory integrity and authenticity

5.3.3 Secure communication

This use case demonstrates how to prevent illegal messages sent by ECUs.

- Random number generation and checking protect against replay attacks.
- Encryption protects against eavesdropping.
- Random number generation/checking and encryption ensure data integrity and authenticity.

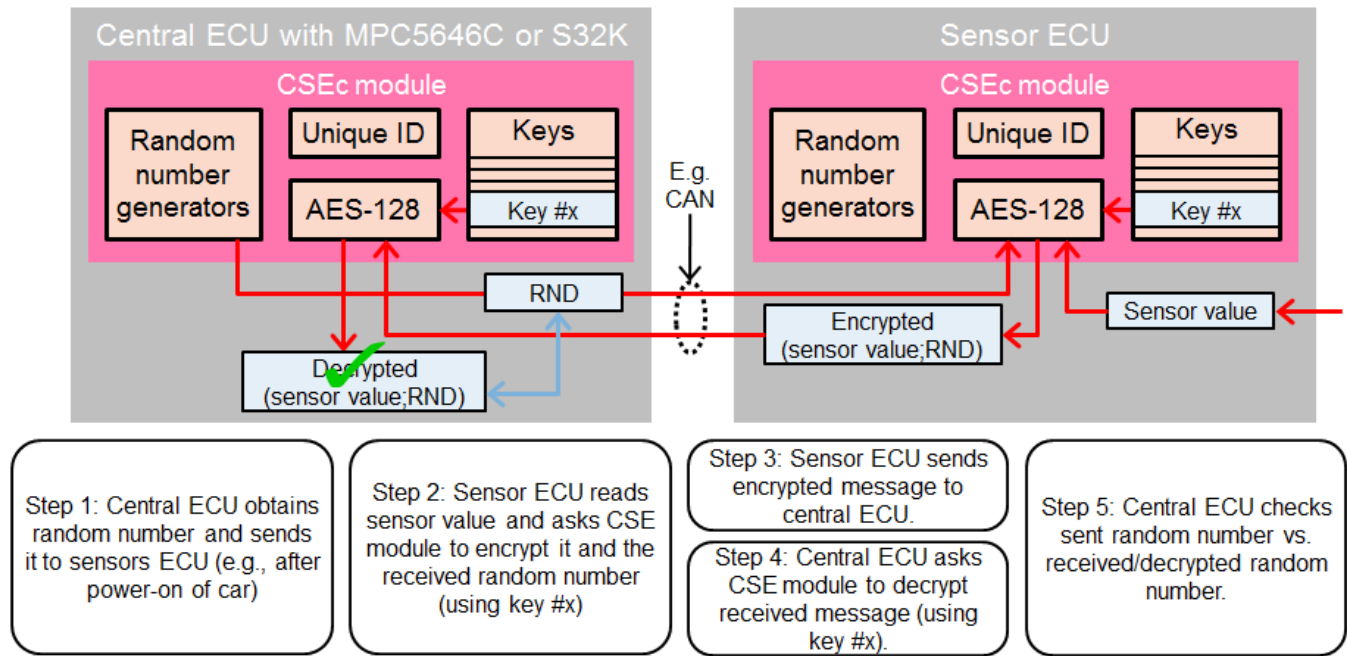

Figure 5-3. Secure communication

5.3.4 Component protection

The replacement or modification of ECU <n> will change its unique ID and/or keys. This use case shows how both changes are detected.

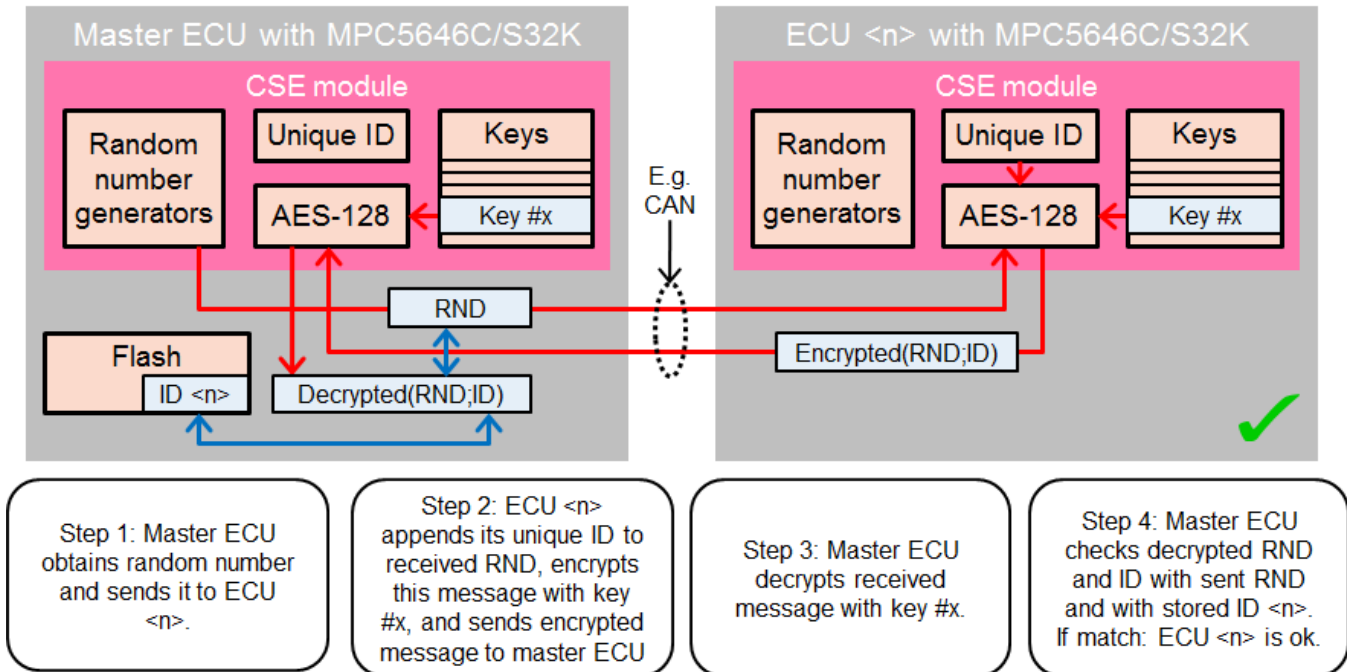

Figure 5-4. Component protection

5.3.5 Message-authentication example

This use case consists of an Rx-CAN message authentication scenario:

1. CAN data stored in local buffer
2. FlexCAN triggers interrupt to core/DMA
3. Transfer data to CSEc memory (maximum 12 CAN messages of 8 bytes + 16-byte CMAC)
4. Trigger CSEc CMAC calculation/verification
5. CSEc triggers interrupt to core
6. Core reads processed message data

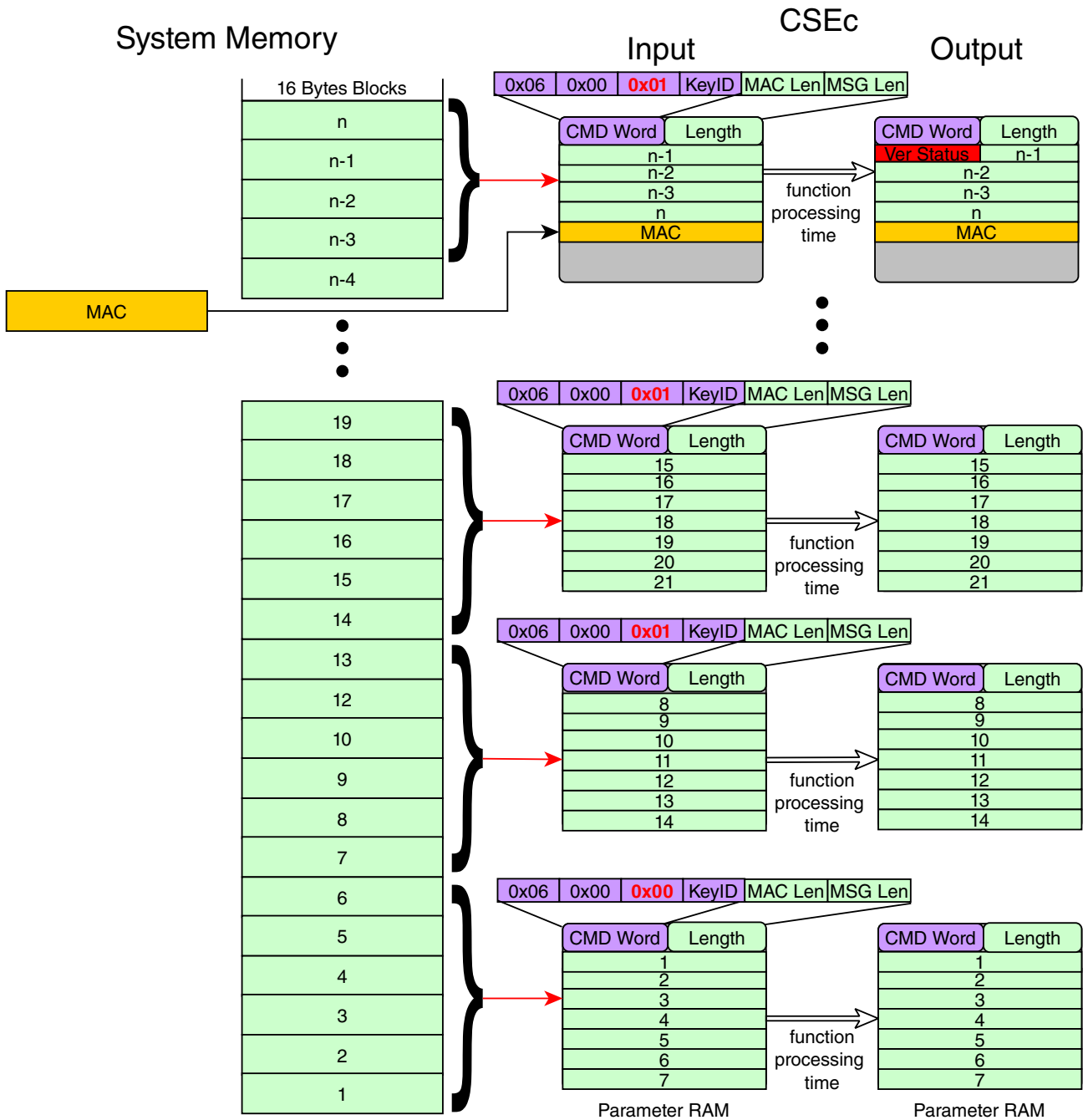

Figure 5-5. Message authentication

5.4 Steps required before failure analysis

Before returning a device to NXP for failure analysis, the user must run the [CMD_DBG_CHAL](#) and [CMD_DBG_AUTH](#) commands and ensure that all keys stored in NVM memory are deleted. This is a mandatory step to enable failure analysis at NXP.

NOTE

If WRITE_PROTECTION flag is set for any key then the user will be unable to delete that key with DEBUG_CHAL and DEBUG_AUTH commands and failure analysis would not be possible.

5.5 Security programming flow example (Secure Boot)

1. Run PGMPART to configure desired number of keys and other parameters
2. Program code section in Pflash to be checked in secure boot
3. LOAD_KEY(BOOT_MAC_KEY)
4. CMD_BOOT_DEFINE to select the flavor of boot and size of data to validate in Pflash

Then optionally reset the part to "auto calculate" and program the BOOT_MAC or the user loads the BOOT_MAC by external calculation.

Chapter 6

Safety Overview

6.1 Introduction

The S32K1xx series is developed according to ISO 26262 and has an integrated safety concept targeting an ISO26262 ASIL-B integrity level. The following documentation supports the integration of an S32K1xx chip into safety-related systems:

- Reference Manual (S32K1XXRM): describes the programming model and functionality of S32K1xx chips
- Data Sheet (S32K1XX): describes S32K1xx operating conditions as well as timing and electrical characteristics
- Safety Manual (S32K1XXSM): describes the S32K1xx safety concept and possible safety mechanisms (integrated in S32K1xx, system-level hardware, or system-level software) as well as measures to reduce dependent failures
- Dynamic FMEDA: inductive analysis enabling customization of system-level safety mechanisms, including the resulting safety metrics for ISO 26262 (SPFM, LFM & PMHF) and IEC 61508 (SFF & Beta IC Factor)
- FMEDA Report: describes the FMEDA methodology and safety mechanisms supported in the FMEDA, including source of failure rates, failure modes, and assumptions during the analysis

The S32K1xx series is a SafeAssure™ solution. For more information regarding functional safety at NXP, visit <http://www.nxp.com/safeassure>.



Figure 6-1. Functional safety overview

6.2 S32K1xx safety concept

The S32K1xx series has an integrated safety concept targeting safety-related systems that require an ASIL-B safety integrity level. In general, safety integrity is achieved by using and applying S32K1xx safety features as described in the Safety Manual.

The following diagram provides an overview of integrated S32K1xx architecture and safety features.

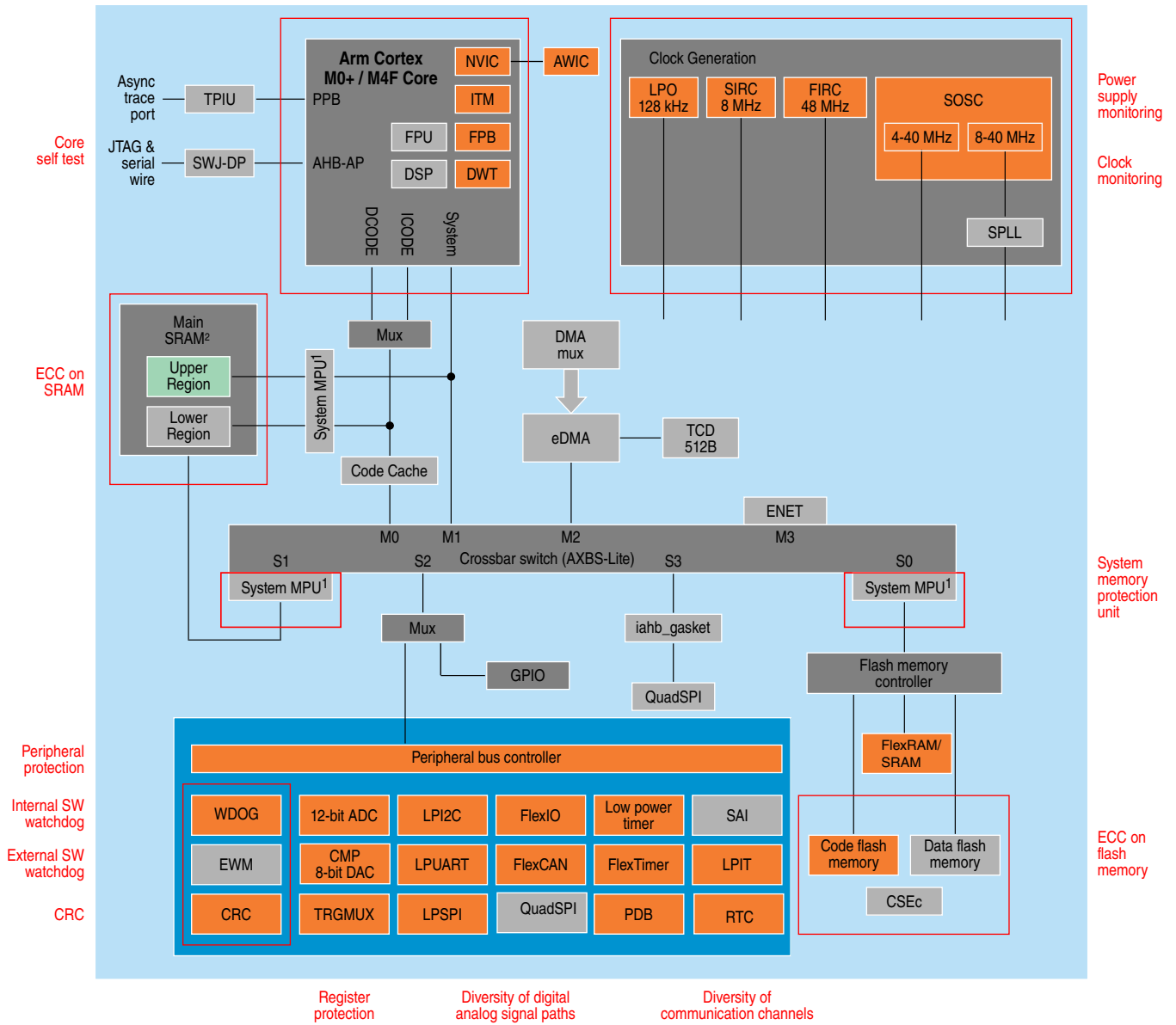

Figure 6-2. S32K1xx safety block diagram

6.2.1 Cortex-M4/M0+ Structural Core Self Test (SCST)

Cortex-M4/M0+ Structural Core Self Test (SCST) is a software product from NXP. It was developed for detecting hardware permanent faults in a core by executing machine opcodes with a fixed set of operands and comparing their execution results. This library is considered a Safety Element out of context and was developed according to ASIL-B.

The SCST delivery contains the SCST library, a quality package, and a safety package.

- The quality package contains code coverage analysis, a MISRA report, a software requirements specification, and a Test Specification.
- The safety package consists of the SCST fault coverage estimation, the Safety Analysis and Concept, and the SCST Safety Manual.

The Safety Manual for Structural Core Self Test Library contains a list of recommendations and assumptions that should be fulfilled and verified by a user for the proper use of the SCST library for a Cortex-M4/M0+ core.

6.2.2 ECC on RAM and flash memory

Error correcting codes are used to protect transfers from a CPU core to flash memory and from a CPU core to system memory. Error Correcting Code (ECC) is implemented with Single-Error Correction, Double-Error Detection (SECDED).

References:

- Functional description: in this Reference Manual, see [MCM](#), [EIM](#), [ERM](#), [LMEM](#), and [FTFC](#)
- ECC on RAM and flash memory in safety concept: see Safety Manual

6.2.3 Power supply monitoring

S32K1xx includes a system for managing low-voltage conditions to protect memory contents and control MCU system states during supply voltage variations.

- Power-on reset (POR)
- Low-voltage detection (LVD)

References:

- Functional description: in this Reference Manual, see [Power Management](#)
- Power supply monitoring in safety concept: see Safety Manual chapter

6.2.4 Clock monitoring

Clocks in the S32K1xx are supervised by clock monitor units.

- System PLL clock monitor¹: monitors the loss of PLL clock
- System Oscillator (SOSC) clock monitor²: monitors the loss of oscillator clock
- CMU monitor³ FIRC clock for:
 - Loss of clock
 - Out of high and low range

References:

- Functional description: in this Reference Manual, see [Clock Distribution](#)
- Clock monitoring in safety concept: see Safety Manual chapter

6.2.5 Temporal protection

In a safety concept, watchdog timers provide temporal protection and monitor the operation of the system by expecting periodic communication from the software.

S32K1xx offers two watchdog timers:

- Watchdog timer (WDOG)⁴: An independent timer that is available for system use. It provides a safety feature to ensure that software is executing as planned and that the CPU is not stuck in an infinite loop.
- External Watchdog Monitor (EWM)⁵: A redundant watchdog system for safety. The EWM provides an independent output signal. It does not reset the MCU and peripherals.

References:

- Functional description: in this Reference Manual, see [WDOG](#) and [EWM](#)
- Temporal protection in safety concept: see Safety Manual chapter

6.2.6 Operational interference protection

S32K1xx provides safety mechanisms to:

1. Available in S32K14x variants only
 2. Available in all S32K1xx variants
 3. Available in S32K11x only
 4. Available in all S32K1xx variants
 5. Available in S32K14x variants only

- prevent non-safety masters from interfering with the operation of the Safety Core
- manage the concurrent execution of software with different (lower) ASIL

A hierarchical memory protection scheme, which includes the following, protects against interference:

- System Memory Protection Unit (MPU)
- Peripheral Bridge (AIPS-Lite)
- Register protection

6.2.6.1 System Memory Protection Unit (MPU)

For ASIL-B applications, the system Memory Protection Unit (MPU) is used for execution control. It assigns access rights and ensures that only authorized software tasks can configure modules and access their allocated resources.

- The system MPU⁶ provides memory protection at the Crossbar Switch. It splits the physical memory into 16 different regions.
- Each XBAR master (core, DMA, Ethernet) can be assigned different access rights to each region.
- The system MPU can be used to prevent non-safety masters (including DMA or Ethernet Controller) from accessing restricted memory regions.

References:

- Functional description: in this Reference Manual, see [MPU](#)
- MPU in safety concept: see Safety Manual chapter

6.2.6.2 Peripheral protection

Peripheral protection is based on the Peripheral Bridge (AIPS-Lite) module. It provides memory protection functionality by defining bus masters' access rights to various peripherals on the chip.

References:

- Functional description: in this Reference Manual, see [AIPS-Lite](#)
- Peripheral protection in safety concept: see Safety Manual chapter

6. On this device, NXP's system MPU implements the safety mechanisms to prevent masters from accessing restricted memory regions. This system MPU provides memory protection at the level of the Crossbar Switch. Each Crossbar master (Core, DMA, Ethernet) can be assigned different access rights to each protected memory region. The Arm M4 core version in this family does not integrate the Arm Core MPU, which would concurrently monitor only core-initiated memory accesses. In this document, the term MPU refers to NXP's system MPU.

6.2.6.3 Register protection

S32K1xx offers register protection for safety-critical registers. This protection is based on CPU program execution mode—User vs. Supervisor (privileged) mode—as well as another type of access restriction based on a lock feature implemented for certain registers. The lock-based access restriction inhibits a register update until the next system reset or requires a special key to unlock access.

References:

- Functional description: in this Reference Manual, see notes about register protection features for a specific register or a group of registers in the register-description sections for SIM, SCG, ERM, RCM, MSCM, and others
- Register protection in safety concept: see Safety Manual

6.2.7 CRC

The CRC unit supports the detection of accidental alteration of data in memory or configuration registers by calculating its CRC signature and comparing it to a previously calculated CRC. The CRC module can also detect erroneous corruption of data during transmission or storage.

References:

- Functional description: in this Reference Manual, see [CRC](#)
- CRC in safety concept: see Safety Manual chapter

6.2.8 Diversity of system resources

Features that are relevant to functional safety usually have redundant support in the system. S32K1xx offers a diversity of system resources to provide this support.

- Digital inputs can be replicated to acquire safety-critical inputs redundantly
- Safety-critical digital outputs can always be written redundantly or in combination with a read-back operation
- Analog inputs can operate in oversampling mode to detect transient faults affecting the ADC channel, and two ADC units can acquire and digitize redundant copies of an analog signal connected to a safety-relevant signal
- For cases of communication-channel redundancy for safety reasons, S32K1xx offers redundant instances of communication peripherals:
 - Synchronous Serial Communication Controller (LPSPI) modules

S32K1xx safety concept

- FlexIO module: capable of supporting a wide range of protocols (UART, I2C, SPI, I2S) and PWM/waveform generation
- UART modules: support UART and LIN communication

References:

- Functional description: in this Reference Manual, see [SIM](#), [LPSPI](#), [LPI2C](#), [FlexIO](#), and [LPUART](#)
- Diversity of system resources in safety concept: see Safety Manual

Chapter 7

CM4 Overview

7.1 Arm Cortex-M4F core configuration

This section summarizes how the module has been configured in the chip. Full documentation for this module is provided by Arm and can be found at arm.com.

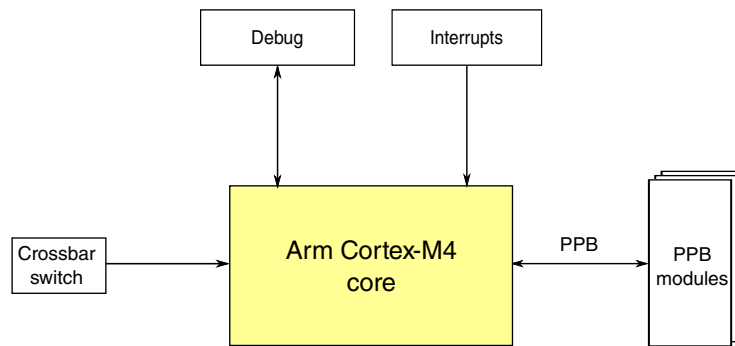

Figure 7-1. Core configuration

Table 7-1. Reference links to related information

Topic	Related module	Reference
Full description	Arm Cortex-M4F core	Arm Cortex-M4F Technical Reference Manual
—	ARM Cortex-M4 Devices Generic User Guide	ARM Cortex-M4 Devices Generic User Guide
System memory map	—	See the S32K1xx_memory_map.xlsx attached to this document.
Clocking	—	Clock distribution
Power management	—	Power management
System/instruction/data bus module	Crossbar switch	Crossbar switch
Debug	IEEE 1149.1 JTAG Serial Wire Debug (SWD) Arm Real-Time Trace Interface	Debug

Table continues on the next page...

Table 7-1. Reference links to related information (continued)

Topic	Related module	Reference
Interrupts	Nested Vectored Interrupt Controller (NVIC)	NVIC
Private Peripheral Bus (PPB) module	Miscellaneous Control Module (MCM)	MCM
Private Peripheral Bus (PPB) module	Single-precision floating point unit (FPU)	FPU

7.1.1 Buses, interconnects, and interfaces

The Arm Cortex-M4 core has four buses as described in the following table.

Table 7-2. Arm core buses

Bus name	Description
Instruction code (ICODE) bus	The ICODE and DCODE buses are muxed. This muxed bus is called the CODE bus and is connected to the crossbar switch via a single master port.
Data code (DCODE) bus	
System bus	The system bus is connected to a separate master port on the crossbar.
Private peripheral (PPB) bus	The PPB provides access to these modules: <ul style="list-style-type: none"> • Arm modules such as the NVIC, ITM, DWT, FBP, and ROM table • NXP Miscellaneous Control Module (MCM)

7.1.2 System Tick Timer

The System Tick Timer's clock source is always the core clock, CORE_CLK. This results in the following:

- The CLKSOURCE bit in SysTick Control and Status register is always set to select the core clock.
- Because the timing reference (CORE_CLK) is a variable frequency, the TENMS bit in the SysTick Calibration Value Register is always zero.
- The NOREF bit in SysTick Calibration Value Register is always set, implying that CORE_CLK is the only available source of reference timing.

7.1.3 Debug facilities

This chip has extensive debug capabilities including run control and tracing capabilities. This is a standard Arm debug port that supports JTAG and SWD interfaces.

7.1.4 Caches

This device includes one 4 KB code cache to minimize the performance impact of memory access latencies. The code cache exists on the I/D bus, and there is no cache on the system bus.

Features of the cache are:

- 2-way set associative
- 4 word lines
- Lines can be individually flushed
- Entire cache can be flushed at once

7.1.4.1 Control

For control purposes, the cache can be in one of these states:

1. Write Back / Write Allocate (WBWA)
2. Write Through
3. No cache

For each defined region there will be 2 bits allocated on the control register (see [PCCRRMR](#) that determines the cache state for the memory region associated with this section. The user can only "lower" the cache attribute, given the fixed relationship of WBWA > WT > NC - so, you can demote a WBWA region to either WT or NC, you can demote a WT space to NC. In order to change the state upwards a system reset is required.

NOTE

See [LMEM](#) for the cache reset states.

7.1.5 Core privilege levels

The Arm documentation uses different terms than this document to distinguish between privilege levels.

Table 7-3. Terms used

If you see this term...	it also means this term...
Privileged	Supervisor
Unprivileged or user	User

7.2 Nested Vectored Interrupt Controller (NVIC) Configuration

This section summarizes how the module has been configured in the chip. Full documentation for this module is provided by Arm and can be found at arm.com.

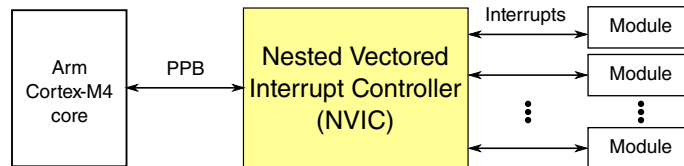

Figure 7-2. NVIC configuration

Table 7-4. Reference links to related information

Topic	Related module	Reference
Full description	Nested Vectored Interrupt Controller (NVIC)	Arm Cortex-M4F Technical Reference Manual - Nested Vectored Interrupt Controller
System memory map	—	Refer to the S32K1xx_memory_map.xlsx attached to this document.
Clocking	—	Clock distribution
Power management	—	Power management
Private Peripheral Bus (PPB)	Arm Cortex-M4 core	Arm Cortex-M4F Technical Reference Manual - Private Peripheral Bus (PPB)

7.2.1 Interrupt priority levels

This device supports 16 priority levels for interrupts. Therefore, in the NVIC each source in the IPR registers contains 4 bits. For example, the IPR0 diagram is shown below.

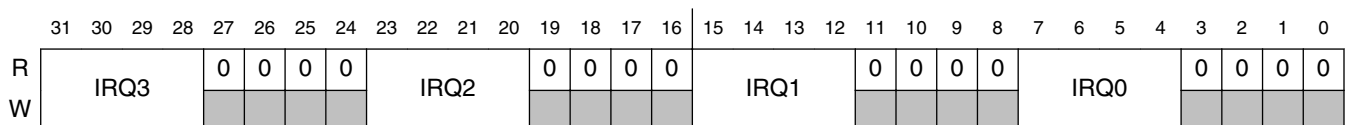

7.2.2 Non-maskable interrupt

The non-maskable interrupt request to the NVIC is controlled by the external $\overline{\text{NMI}}$ signal. The pin on which the $\overline{\text{NMI}}$ signal is multiplexed must be configured for the $\overline{\text{NMI}}$ function in order to generate the non-maskable interrupt request.

See IO Signal Description Input Multiplexing sheet(s) attached to the Reference Manual for details on NMI pad.

7.2.3 Determining the bitfield and register location for configuring a particular interrupt

Suppose you need to configure the low-power timer (LPTMR) interrupt. The following table is an excerpt of the LPTMR row from the file 'S32K1xx_DMA_INT_mapping.xlsm' attached to this Reference Manual.

Table 7-6. LPTMR interrupt vector assignment

Address	Vector	IRQ ¹	NVIC non-IPR register number ²	NVIC IPR register number ³	Source module
0x0000_0128	74	58	1	14	Low Power Timer

1. Indicates the NVIC's interrupt source number.
2. Indicates the NVIC's ISER, ICER, ISPR, ICPR, and IABR register number used for this IRQ. The equation to calculate this value is: $\text{IRQ} \div 32$
3. Indicates the NVIC's IPR register number used for this IRQ. The equation to calculate this value is: $\text{IRQ} \div 4$

The NVIC registers you would use to configure the interrupt are:

- NVICISER1
- NVICICER1
- NVICISPR1
- NVICICPR1
- NVICIABR1
- NVICIPR14

To determine the particular IRQ's bitfield location within these particular registers:

- NVICISER1, NVICICER1, NVICISPR1, NVICICPR1, NVICIABR1 bit location = $\text{IRQ} \bmod 32 = 26$
- NVICIPR14 bitfield starting location = $8 \times (\text{IRQ} \bmod 4) + 4 = 20$

Since the NVICIPR bitfields are 4-bit wide (16 priority levels), the NVICIPR14 bitfield range is 20-23

Therefore, the following bitfield locations are used to configure the LPTMR interrupts:

- NVICISER1[26]
- NVICICER1[26]
- NVICISPR1[26]
- NVICICPR1[26]
- NVICIABR1[26]
- NVICIPR14[23:20]

7.3 Asynchronous Wake-up Interrupt Controller (AWIC) Configuration

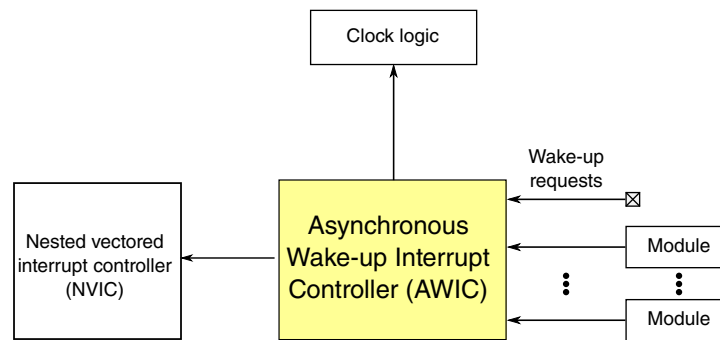

Figure 7-3. Asynchronous Wake-up Interrupt Controller configuration

Table 7-7. Reference links to related information

Topic	Related module	Reference
System memory map	—	Refer to the S32K1xx_memory_map.xlsx attached to Reference Manual for details.
Clocking	—	Clock distribution
Power management	—	Power management
Nested Vectored Interrupt Controller (NVIC)	—	NVIC
Wake-up requests	—	AWIC wake-up sources

7.3.1 Wake-up sources

Table 7-8. AWIC stop and VLPS wake-up sources

Wake-up source	Description
Available system resets	RESET pin, WDOG, JTAG

Table continues on the next page...

Table 7-8. AWIC stop and VLPS wake-up sources (continued)

Wake-up source	Description
Pin interrupts	Port Control Module - Any enabled pin interrupt is capable of waking the system
ADCx	(1) Sync Interrupt in STOP2
CMP	(1) Async Interrupt in STOP1 (2) Sync Interrupt in STOP2 (3) Functional in VLPS modes and will cause async Interrupt for wake up
LPI2C0	(1) Async Interrupt in STOP1 (2) Sync Interrupt in STOP2 (3) Functional in VLPS mode with SIRC as clock source
LPUART	(1) Async Interrupt in STOP1 (2) Sync Interrupt in STOP2 (3) Functional in VLPS mode with SIRC as clock source
LPSPi	(1) Async Interrupt in STOP1 (2) Sync Interrupt in STOP2 (3) Functional in VLPS mode with SIRC as clock source
LPTMR0	(1) Async Interrupt in STOP1 (2) Sync Interrupt in STOP2 (3) Functional in VLPS modes and will cause async Interrupt for wake up
RTC	(1) Async Interrupt in STOP1 (2) Sync Interrupt in STOP2 (3) RTC running in VLPS from either LPO or RTC_CLKIN. Wakeup from alarm interrupt
CAN	PNET is supported in STOP1/2 modes and will cause wake up. Only CAN0 supports PNET feature.
NMI	Non-maskable interrupt
WDOG	(1) Async Interrupt in STOP1 (2) Sync Interrupt in STOP2 (3) Functional in VLPS modes and will cause async Interrupt for wake up
FlexIO	(1) Async Interrupt in STOP1 (2) Sync Interrupt in STOP2
LPIT	(1) Async Interrupt in STOP1 (2) Sync Interrupt in STOP2 (3) Functional in VLPS mode with SIRC as clock source.
EWM	Module off in STOP1 and VLPS. Can cause wakeup through sync Interrupt in STOP2.
CRC	Module off in STOP1 and VLPS. Can cause wakeup through sync Interrupt in STOP2.
SCG	(1) Async Interrupt in STOP1 (2) Sync Interrupt in STOP2

7.4 FPU configuration

This section summarizes how the module has been configured in the chip.

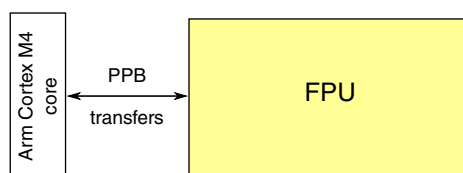
**Figure 7-4. FPU configuration****Table 7-9. Reference links to related information**

Topic	Related module	Reference
Full description	FPU	Arm Cortex-M4 Technical Reference Manual - Floating-Point Unit

Table continues on the next page...

Table 7-9. Reference links to related information (continued)

Topic	Related module	Reference
System memory map	—	Refer to the S32K1xx_memory_map.xlsx attached to this document.
Clocking	—	Clock Distribution
Power Management	—	Power Management
Transfers Private Peripheral Bus (PPB)	Arm Cortex M4 core	Arm Cortex-M4 Technical Reference Manual - Private Peripheral Bus

7.5 JTAG controller configuration

This section summarizes how the module has been configured in the chip.

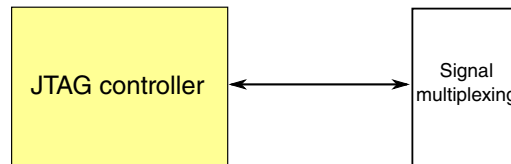

Figure 7-5. JTAG controller configuration

Table 7-10. Reference links to related information

Topic	Related module	Reference
Full description	JTAGC	JTAGC
Signal multiplexing	Port control	See IO Signal Description Input Multiplexing sheet(s) attached to the Reference Manual attached to this document for details.

Chapter 8

CM0+ Overview

8.1 Arm Cortex-M0+ core introduction

The enhanced Arm Cortex M0+ is the member of the Cortex-M Series of processors targeting microcontroller cores focused on very cost sensitive, low power applications. It has a single 32-bit AMBA AHB-Lite interface and includes an NVIC component. It also has hardware debug functionality including support for simple program trace capability. The processor supports the Armv6-M instruction set (Thumb) architecture including all but three 16-bit Thumb opcodes (52 total) plus seven 32-bit instructions. It is upward compatible with other Cortex-M profile processors.

Table 8-1. Reference links to related information

Topic	Related module	Reference
Full description	Arm Cortex-M0+ core	Arm Cortex-M0+ Technical Reference Manual
—	ARM Cortex-M0 Devices Generic User Guide	ARM Cortex-M0 Devices Generic User Guide
System memory map	—	See the S32K1xx_memory_map.xlsx attached to this document.
Clocking	—	Clock distribution
Power management	—	Power management
System/instruction/data bus module	Crossbar switch	Crossbar switch
Debug	IEEE 1149.1 JTAG Serial Wire Debug (SWD) MTB Arm Real-Time Trace Interface	Debug
Interrupts	Nested Vectored Interrupt Controller (NVIC)	NVIC

8.1.1 Buses, interconnects, and interfaces

The Arm Cortex-M0+ core has two bus interfaces:

- Single 32-bit AMBA-3 AHB-Lite system interface that provides connections to peripherals and all system memory, which includes flash memory and RAM
- Single 32-bit I/O port bus interfacing to the GPIO with 1-cycle loads and stores

8.1.2 System tick timer

The CLKSOURCE field in SysTick Control and Status register selects either the core clock (when CLKSOURCE = 1) or a divide-by-16 of the core clock (when CLKSOURCE = 0). Because the timing reference is a variable frequency, the TENMS field in the SysTick Calibration Value Register is always 0.

8.1.3 Debug facilities

This device supports standard Arm 2-pin SWD debug port.

8.1.4 Core privilege levels

The core on this device is implemented with both privileged and unprivileged levels. The Arm documentation uses different terms than this document to distinguish between privilege levels.

If you see this term...	it also means this term...
Privileged	Supervisor
Unprivileged or user	User

8.2 Nested vectored interrupt controller (NVIC)

8.2.1 Interrupt priority levels

This device supports four priority levels for interrupts. Therefore, in the NVIC, each source in the IPR registers contains two bits. For example, IPR0 is shown below:

	31	30	29	28	27	26	25	24	23	22	21	20	19	18	17	16	15	14	13	12	11	10	9	8	7	6	5	4	3	2	1	0
R	IRQ3							IRQ2							IRQ1							IRQ0										
W	0	0	0	0	0	0	0	0	0	0	0	0	0	0	0	0	0	0	0	0	0	0	0	0	0	0	0	0	0	0	0	

8.2.2 Non-maskable interrupt

The non-maskable interrupt request to the NVIC is controlled by the external $\overline{\text{NMI}}$ signal. The pin the $\overline{\text{NMI}}$ signal is multiplexed on, must be configured for the $\overline{\text{NMI}}$ function to generate the non-maskable interrupt request. See IO Signal Description Input Multiplexing sheet(s) attached to the Reference Manual for details on NMI pad.

8.2.3 Determining the bitfield and register location for configuring a particular interrupt

Suppose you need to configure the SPI0 interrupt. The following table is an excerpt of the FlexCAN row from the file 'S32K1xx_DMA_INT_mapping.xlsm' attached to this Reference Manual.

Table 8-3. Interrupt vector assignments

Address	Vector	IRQ ¹	NVIC IPR register number ²	Source module
0x0000_006C	27	11	2	FlexCAN

1. Indicates the NVIC's interrupt source number.

2. Indicates the NVIC's IPR register number used for this IRQ. The equation to calculate this value is: $\text{IRQ} \div 4$.

- The NVIC registers you would use to configure the interrupt are:
 - NVICIPR2
- To determine the particular IRQ's field location within these particular registers:
 - NVICIPR2 field starting location = $8 * (\text{IRQ} \bmod 4) + 6 = 22$

Since the NVICIPR fields are 2-bit wide (4 priority levels), the NVICIPR2 field range is 22–23.

Therefore, the following field locations are used to configure the FlexCAN interrupts:

- NVICIPR2[23:22]

8.3 AWIC introduction

The primary function of the AWIC block is to detect asynchronous wake-up events in stop modes and signal to clock control logic to resume system clocking. After clock restart, the NVIC observes the pending interrupt and performs the normal interrupt or event processing.

Table 8-4. Reference links to related information

Topic	Related module	Reference
System memory map	—	Refer to the S32K1xx_memory_map.xlsx attached to Reference Manual for details.
Clocking	—	Clock distribution
Power management	—	Power management
Nested Vectored Interrupt Controller (NVIC)	—	NVIC
Wake-up requests	—	AWIC wake-up sources

8.3.1 Wake-up sources

The device uses the following internal and external inputs to the AWIC module.

Table 8-5. AWIC stop and VLPS wake-up sources

Wake-up source	Description
Available system resets	RESET pin, WDOG, JTAG
Pin interrupts	Port Control Module - Any enabled pin interrupt is capable of waking the system
ADCx	(1) Sync Interrupt in STOP2
CMP	(1) Async Interrupt in STOP1 (2) Sync Interrupt in STOP2 (3) Functional in VLPS modes and will cause async Interrupt for wake up
LPI2C0	(1) Async Interrupt in STOP1 (2) Sync Interrupt in STOP2 (3) Functional in VLPS mode with SIRC as clock source
LPUART	(1) Async Interrupt in STOP1 (2) Sync Interrupt in STOP2 (3) Functional in VLPS mode with SIRC as clock source

Table continues on the next page...

Table 8-5. AWIC stop and VLPS wake-up sources (continued)

Wake-up source	Description
LPSPi	(1) Async Interrupt in STOP1 (2) Sync Interrupt in STOP2 (3) Functional in VLPS mode with SIRC as clock source
LPTMR0	(1) Async Interrupt in STOP1 (2) Sync Interrupt in STOP2 (3) Functional in VLPS modes and will cause async Interrupt for wake up
RTC	(1) Async Interrupt in STOP1 (2) Sync Interrupt in STOP2 (3) RTC running in VLPS from either LPO or RTC_CLKIN. Wakeup from alarm interrupt
CAN	PNET is supported in STOP1/2 modes and will cause wake up. Only CAN0 supports PNET feature.
NMI	Non-maskable interrupt
WDOG	(1) Async Interrupt in STOP1 (2) Sync Interrupt in STOP2 (3) Functional in VLPS modes and will cause async Interrupt for wake up
FlexIO	(1) Async Interrupt in STOP1 (2) Sync Interrupt in STOP2
LPiT	(1) Async Interrupt in STOP1 (2) Sync Interrupt in STOP2 (3) Functional in VLPS mode with SIRC as clock source
CRC	Module off in STOP1 and VLPS. Can cause wakeup through sync Interrupt in STOP2.
SCG	(1) Async Interrupt in STOP1 (2) Sync Interrupt in STOP2

Chapter 9

Micro Trace Buffer (MTB)

9.1 Introduction

Microcontrollers using the Cortex-M0+ processor core include support for a CoreSight Micro Trace Buffer to provide program trace capabilities.

The proper name for this function is the CoreSight Micro Trace Buffer for the Cortex-M0+ Processor; in this document, it is simply abbreviated as the MTB.

The simple program trace function creates instruction address change-of-flow data packets in a user-defined region of the system RAM. Accordingly, the system RAM controller manages requests from two sources:

- AMBA-AHB reads and writes from the system bus
- program trace packet writes from the processor

As part of the MTB functionality, there is a MTB_DWT (Data Watchpoint and Trace) module that allows the user to define watchpoint addresses, or optionally, an address and data value, that when triggered, can be used to start or stop the program trace recording.

9.1.1 Overview

As shown in the main block diagram, the platform RAM (PRAM) controller connects to two input buses:

- the crossbar slave port for system bus accesses
- a "private execution MTB port" from the core

The logical paths from the crossbar master input ports to the PRAM controller are highlighted along with the private execution trace port from the processor core. The private MTB port signals the instruction address information needed for the 64-bit program trace packets written into the system RAM. The PRAM controller output interfaces to the attached RAM array. In this document, the PRAM controller is the MTB_RAM controller.

The following information is taken from the ARM CoreSight Micro Trace Buffer documentation.

"The execution trace packet consists of a pair of 32-bit words that the MTB generates when it detects the processor PC value changes non-sequentially. A non-sequential PC change can occur during branch instructions or during exception entry.

The processor can cause a trace packet to be generated for any instruction.

The following figure shows how the execution trace information is stored in memory as a sequence of packets.

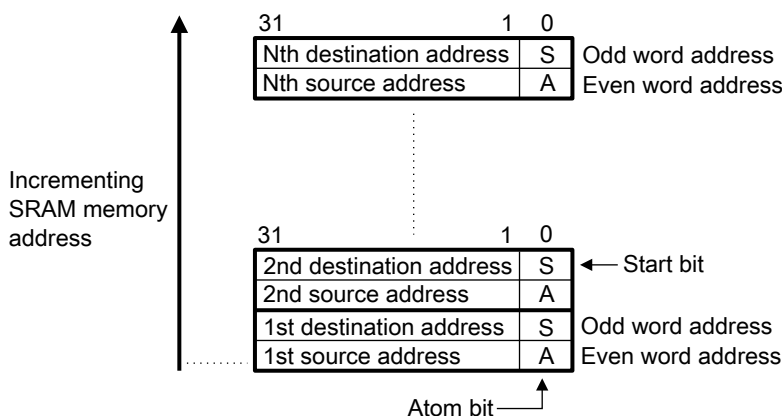

Figure 9-1. MTB execution trace storage format

The first, lower addressed, word contains the source of the branch, the address it branched from. The value stored only records bits[31:1] of the source address, because Thumb instructions are at least halfword aligned. The least significant bit of the value is the A-bit. The A-bit indicates the atomic state of the processor at the time of the branch, and can differentiate whether the branch originated from an instruction in a program, an exception, or a PC update in Debug state. When it is zero the branch originated from an instruction, when it is one the branch originated from an exception or PC update in Debug state. This word is always stored at an even word location.

The second, higher addressed word contains the destination of the branch, the address it branched to. The value stored only records bits[31:1] of the branch address. The least significant bit of the value is the S-bit. The S-bit indicates where the trace started. An S-bit value of 1 indicates where the first packet after the trace started and a value of 0 is used for other packets. Because it is possible to start and stop tracing multiple times in a trace session, the memory might contain several packets with the S-bit set to 1. This word is always stored in the next higher word in memory, an odd word address.

When the A-bit is set to 1, the source address field contains the architecturally-preferred return address for the exception. For example, if an exception was caused by an SVC instruction, then the source address field contains the address of the following instruction. This is different from the case where the A-bit is set to 0. In this case, the source address contains the address of the branch instruction.

For an exception return operation, two packets are generated:

- The first packet has the:
 - Source address field set to the address of the instruction that causes the exception return, BX or POP.
 - Destination address field set to bits[31:1] of the EXC_RETURN value. See the ARM v6-M Architecture Reference Manual.
 - The A-bit set to 0.
- The second packet has the:
 - Source address field set to bits[31:1] of the EXC_RETURN value.
 - Destination address field set to the address of the instruction where execution commences.
 - A-bit set to 1."

Given the recorded change-of-flow trace packets in system RAM and the memory image of the application, a debugger can read out the data and create an instruction-by-instruction program trace. In keeping with the low area and power implementation cost design targets, the MTB trace format is less efficient than other CoreSight trace modules, for example, the ETM (Embedded Trace Macrocell). Since each branch packet is 8 bytes in size, a 1 KB block of system RAM can contain 128 branches. Using the Dhrystone 2.1 benchmark's dynamic runtime as an example, this corresponds to about 875 instructions per KB of trace RAM, or with a zero wait state memory, this corresponds to approximately 1600 processor cycles per KB. This metric is obviously very sensitive to the runtime characteristics of the user code.

The MTB_DWT function (not shown in the core platform block diagram) monitors the processor address and data buses so that configurable watchpoints can be detected to trigger the appropriate response in the MTB recording.

9.1.2 Features

The key features of the MTB_RAM and MTB_DWT include:

- Memory controller for system RAM and Micro Trace Buffer for program trace packets
- Read/write capabilities for system RAM accesses, write-only for program trace packets

- Supports zero wait state response to system bus accesses when no trace data is being written
- Can buffer two AHB address phases and one data write for system RAM accesses
- Supports 64-bit program trace packets including source and destination instruction addresses
- Program trace information in RAM available to MCU's application code or external debugger
- Program trace watchpoint configuration accessible by MCU's application code or debugger
- Location and size of RAM trace buffer is configured by software
- Two DWT comparators (addresses or address + data) provide programmable start/stop recording
- CoreSight compliant debug functionality

9.1.3 Modes of operation

The MTB_RAM and MTB_DWT functions do not support any special modes of operation. The MTB_RAM controller, as a memory-mapped device located on the platform's slave AHB system bus, responds strictly on the basis of memory addresses for accesses to its attached RAM array. The MTB private execution bus provides program trace packet write information to the RAM controller. Both the MTB_RAM and MTB_DWT modules are memory-mapped, so their programming models can be accessed.

All functionality associated with the MTB_RAM and MTB_DWT modules resides in the core platform's clock domain; this includes its connections with the RAM array.

9.2 Memory map and register definition

The MTB_RAM and MTB_DWT modules each support a sparsely-populated 4 KB address space for their programming models. For each address space, there are a variety of control and configurable registers near the base address, followed by a large unused address space and finally a set of CoreSight registers to support dynamic determination of the debug configuration for the device.

Accesses to the programming model follow standard ARM conventions. Taken from the ARM CoreSight Micro Trace Buffer documentation, these are:

- Do not attempt to access reserved or unused address locations. Attempting to access these locations can result in UNPREDICTABLE behavior.

- The behavior of the MTB is UNPREDICTABLE if the registers with UNKNOWN reset values are not programmed prior to enabling trace.
- Unless otherwise stated in the accompanying text:
 - Do not modify reserved register bits
 - Ignore reserved register bits on reads
 - All register bits are reset to a logic 0 by a system or power-on reset
 - Use only word size, 32-bit, transactions to access all registers
 - DWT registers are not accessible by the processor. Access by DAP interface is allowed.

9.2.1 MTB_DWT Memory Map

The MTB_DWT programming model supports a very simplified subset of the v7M debug architecture and follows the standard ARM DWT definition.

MTB_DWT memory map

Address offset (hex)	Register name	Width (in bits)	Access	Reset value	Section/page
0	MTB DWT Control Register (MTB_DWT_CTRL)	32	R	2F00_0000h	9.2.1.1/132
20	MTB_DWT Comparator Register (MTB_DWT_COMP0)	32	R/W	0000_0000h	9.2.1.2/133
24	MTB_DWT Comparator Mask Register (MTB_DWT_MASK0)	32	R/W	0000_0000h	9.2.1.3/133
28	MTB_DWT Comparator Function Register 0 (MTB_DWT_FCT0)	32	R/W	0000_0000h	9.2.1.4/135
30	MTB_DWT Comparator Register (MTB_DWT_COMP1)	32	R/W	0000_0000h	9.2.1.2/133
34	MTB_DWT Comparator Mask Register (MTB_DWT_MASK1)	32	R/W	0000_0000h	9.2.1.3/133
38	MTB_DWT Comparator Function Register 1 (MTB_DWT_FCT1)	32	R/W	0000_0000h	9.2.1.5/137
200	MTB_DWT Trace Buffer Control Register (MTB_DWT_TBCTRL)	32	R/W	2000_0000h	9.2.1.6/138
FC8	Device Configuration Register (MTB_DWT_DEVICECFG)	32	R	0000_0000h	9.2.1.7/140
FCC	Device Type Identifier Register (MTB_DWT_DEVICETYPEID)	32	R	0000_0004h	9.2.1.8/140
FD0	Peripheral ID Register (MTB_DWT_PERIPHID4)	32	R	Undefined	9.2.1.9/141
FD4	Peripheral ID Register (MTB_DWT_PERIPHID5)	32	R	Undefined	9.2.1.9/141
FD8	Peripheral ID Register (MTB_DWT_PERIPHID6)	32	R	Undefined	9.2.1.9/141
FDC	Peripheral ID Register (MTB_DWT_PERIPHID7)	32	R	Undefined	9.2.1.9/141
FE0	Peripheral ID Register (MTB_DWT_PERIPHID0)	32	R	Undefined	9.2.1.9/141
FE4	Peripheral ID Register (MTB_DWT_PERIPHID1)	32	R	Undefined	9.2.1.9/141
FE8	Peripheral ID Register (MTB_DWT_PERIPHID2)	32	R	Undefined	9.2.1.9/141
FEC	Peripheral ID Register (MTB_DWT_PERIPHID3)	32	R	Undefined	9.2.1.9/141

Table continues on the next page...

MTB_DWT memory map (continued)

Address offset (hex)	Register name	Width (in bits)	Access	Reset value	Section/page
FF0	Component ID Register (MTB_DWT_COMPID0)	32	R	Undefined	9.2.1.10/ 141
FF4	Component ID Register (MTB_DWT_COMPID1)	32	R	Undefined	9.2.1.10/ 141
FF8	Component ID Register (MTB_DWT_COMPID2)	32	R	Undefined	9.2.1.10/ 141
FFC	Component ID Register (MTB_DWT_COMPID3)	32	R	Undefined	9.2.1.10/ 141

9.2.1.1 MTB DWT Control Register (MTB_DWT_CTRL)

The MTBDWT_CTRL register provides read-only information on the watchpoint configuration for the MTB_DWT.

Address: 0h base + 0h offset = 0h

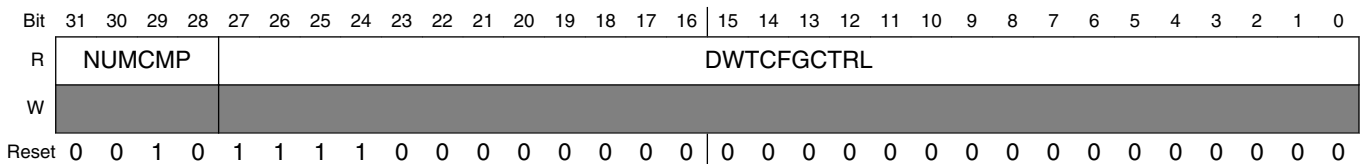

MTB_DWT_CTRL field descriptions

Field	Description
31–28 NUMCMP	Number of comparators The MTB_DWT implements two comparators.
DWTCFGCTRL	DWT configuration controls This field is hardwired to 0xF00_0000, disabling all the remaining DWT functionality. The specific fields and their state are: MTBDWT_CTRL[27] = NOTRCPKT = 1, trace sample and exception trace is not supported MTBDWT_CTRL[26] = NOEXTTRIG = 1, external match signals are not supported MTBDWT_CTRL[25] = NOCYCCNT = 1, cycle counter is not supported MTBDWT_CTRL[24] = NOPRFCNT = 1, profiling counters are not supported MTBDWT_CTRL[22] = CYCEBTENA = 0, no POSTCNT underflow packets generated MTBDWT_CTRL[21] = FOLDEVTENA = 0, no folded instruction counter overflow events MTBDWT_CTRL[20] = LSUEVTENA = 0, no LSU counter overflow events MTBDWT_CTRL[19] = SLEEPEVTENA = 0, no sleep counter overflow events MTBDWT_CTRL[18] = EXCEVTENA = 0, no exception overhead counter events MTBDWT_CTRL[17] = CPIEVTENA = 0, no CPI counter overflow events MTBDWT_CTRL[16] = EXCTRCENA = 0, generation of exception trace disabled

Table continues on the next page...

MTB_DWT_CTRL field descriptions (continued)

Field	Description
	MTBDWT_CTRL[12] = PCSAMPLENA = 0, no periodic PC sample packets generated
	MTBDWT_CTRL[11:10] = SYNCTAP = 0, no synchronization packets
	MTBDWT_CTRL[9] = CYCTAP = 0, cycle counter is not supported
	MTBDWT_CTRL[8:5] = POSTINIT = 0, cycle counter is not supported
	MTBDWT_CTRL[4:1] = POSTPRESET = 0, cycle counter is not supported
	MTBDWT_CTRL[0] = CYCCNTENA = 0, cycle counter is not supported

9.2.1.2 MTB_DWT Comparator Register (MTB_DWT_COMPn)

The MTBDWT_COMPn registers provide the reference value for comparator n.

Address: 0h base + 20h offset + (16d × i), where i=0d to 1d

Bit	31	30	29	28	27	26	25	24	23	22	21	20	19	18	17	16	15	14	13	12	11	10	9	8	7	6	5	4	3	2	1	0
R																	COMP															
W																																
Reset	0	0	0	0	0	0	0	0	0	0	0	0	0	0	0	0	0	0	0	0	0	0	0	0	0	0	0	0	0	0	0	0

MTB_DWT_COMPn field descriptions

Field	Description
COMP	Reference value for comparison If MTBDWT_COMP0 is used for a data value comparator and the access size is byte or halfword, the data value must be replicated across all appropriate byte lanes of this register. For example, if the data is a byte-sized "x" value, then COMP[31:24] = COMP[23:16] = COMP[15:8] = COMP[7:0] = "x". Likewise, if the data is a halfword-size "y" value, then COMP[31:16] = COMP[15:0] = "y".

9.2.1.3 MTB_DWT Comparator Mask Register (MTB_DWT_MASKn)

The MTBDWT_MASKn registers define the size of the ignore mask applied to the reference address for address range matching by comparator n. Note the format of this mask field is different than the MTB_MASTER[MASK].

Address: 0h base + 24h offset + (16d × i), where i=0d to 1d

Bit	31	30	29	28	27	26	25	24	23	22	21	20	19	18	17	16	15	14	13	12	11	10	9	8	7	6	5	4	3	2	1	0
R	0																MASK															
W																																
Reset	0	0	0	0	0	0	0	0	0	0	0	0	0	0	0	0	0	0	0	0	0	0	0	0	0	0	0	0	0	0	0	0

MTB_DWT_MASK n field descriptions

Field	Description
31–5 Reserved	This field is reserved. This read-only field is reserved and always has the value 0.
MASK	<p data-bbox="350 317 418 339">MASK</p> <p data-bbox="350 368 1466 509">The value of the ignore mask, 0-31 bits, is applied to address range matching. MASK = 0 is used to include all bits of the address in the comparison, except if MASK = 0 and the comparator is configured to watch instruction fetch addresses, address bit [0] is ignored by the hardware since all fetches must be at least halfword aligned. For MASK != 0 and regardless of watch type, address bits [x-1:0] are ignored in the address comparison.</p> <p data-bbox="350 530 1466 613">Using a mask means the comparator matches on a range of addresses, defined by the unmasked most significant bits of the address, bits [31:x]. The maximum MASK value is 24, producing a 16 Mbyte mask. An attempted write of a MASK value > 24 is limited by the MTBDWT hardware to 24.</p> <p data-bbox="350 634 1466 685">If MTBDWT_COMP0 is used as a data value comparator, then MTBDWT_MASK0 should be programmed to zero.</p>

9.2.1.4 MTB_DWT Comparator Function Register 0 (MTB_DWT_FCT0)

The MTBDWT_FCTn registers control the operation of comparator n.

Address: 0h base + 28h offset = 28h

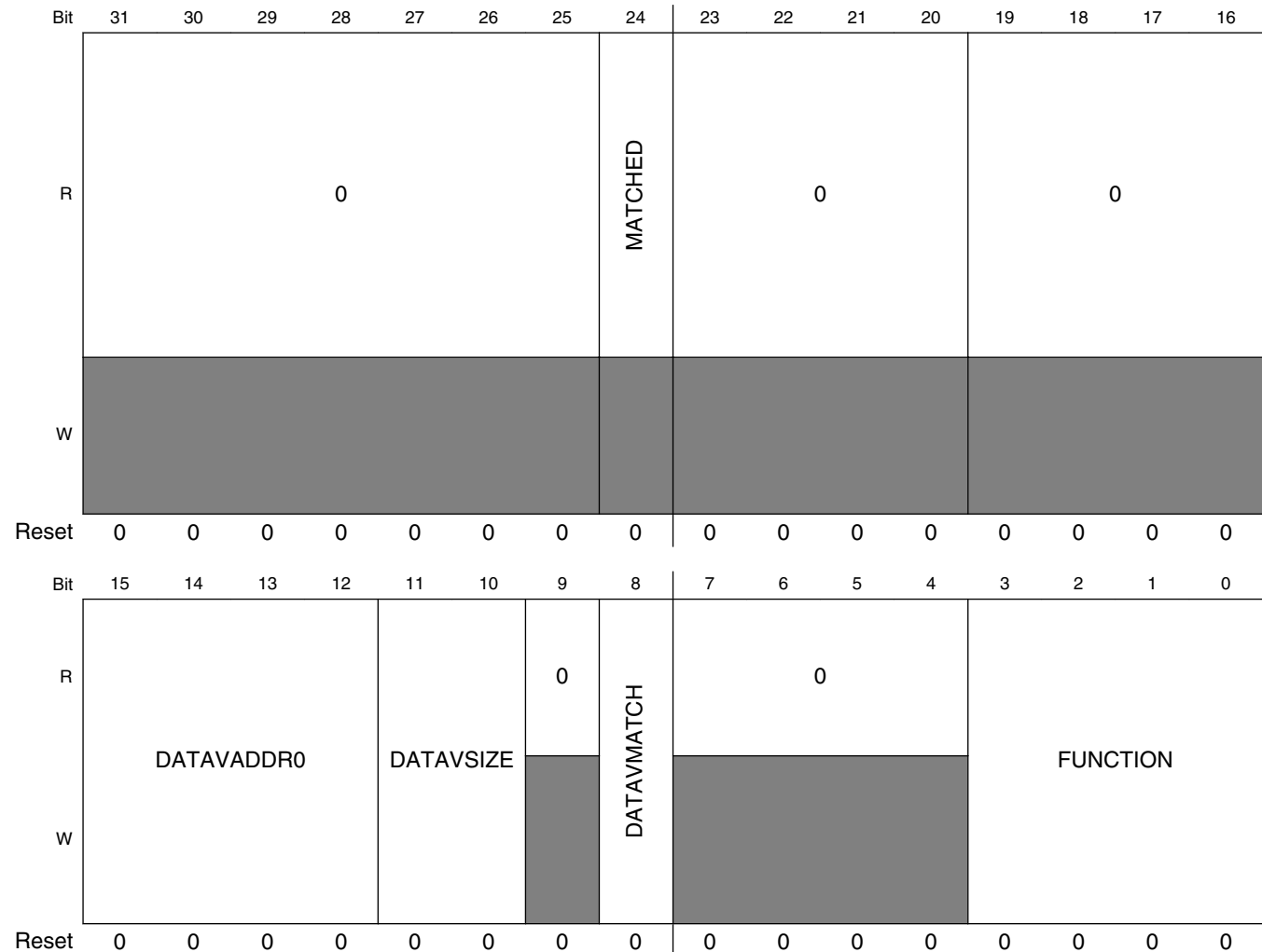

MTB_DWT_FCT0 field descriptions

Field	Description
31–25 Reserved	This field is reserved. This read-only field is reserved and always has the value 0.
24 MATCHED	Comparator match If this read-only flag is asserted, it indicates the operation defined by the FUNCTION field occurred since the last read of the register. Reading the register clears this bit. 0 No match. 1 Match occurred.

Table continues on the next page...

MTB_DWT_FCT0 field descriptions (continued)

Field	Description
23–20 Reserved	This field is reserved. This read-only field is reserved and always has the value 0.
19–16 Reserved	This field is reserved. This read-only field is reserved and always has the value 0.
15–12 DATAVADDR0	Data Value Address 0 Since the MTB_DWT implements two comparators, the DATAVADDR0 field is restricted to values {0,1}. When the DATAVMATCH bit is asserted, this field defines the comparator number to use for linked address comparison. If MTBDWT_COMP0 is used as a data watchpoint and MTBDWT_COMP1 as an address watchpoint, DATAVADDR0 must be set.
11–10 DATAVSIZE	Data Value Size For data value matching, this field defines the size of the required data comparison. 00 Byte. 01 Halfword. 10 Word. 11 Reserved. Any attempts to use this value results in UNPREDICTABLE behavior.
9 Reserved	This field is reserved. This read-only field is reserved and always has the value 0.
8 DATAVMATCH	Data Value Match When this field is 1, it enables data value comparison. For this implementation, MTBDWT_COMP0 supports address or data value comparisons; MTBDWT_COMP1 only supports address comparisons. 0 Perform address comparison. 1 Perform data value comparison.
7–4 Reserved	This field is reserved. This read-only field is reserved and always has the value 0.
FUNCTION	Function Selects the action taken on a comparator match. If MTBDWT_COMP0 is used for a data value and MTBDWT_COMP1 for an address value, then MTBDWT_FCT1[FUNCTION] must be set to zero. For this configuration, MTBDWT_MASK1 can be set to a non-zero value, so the combined comparators match on a range of addresses. 0000 Disabled. 0100 Instruction fetch. 0101 Data operand read. 0110 Data operand write. 0111 Data operand (read + write). others Reserved. Any attempts to use this value results in UNPREDICTABLE behavior.

9.2.1.5 MTB_DWT Comparator Function Register 1 (MTB_DWT_FCT1)

The MTBDWT_FCTn registers control the operation of comparator n. Since the MTB_DWT only supports data value comparisons on comparator 0, there are several fields in the MTBDWT_FCT1 register that are RAZ/WI (bits 12, 11:10, 8).

Address: 0h base + 38h offset = 38h

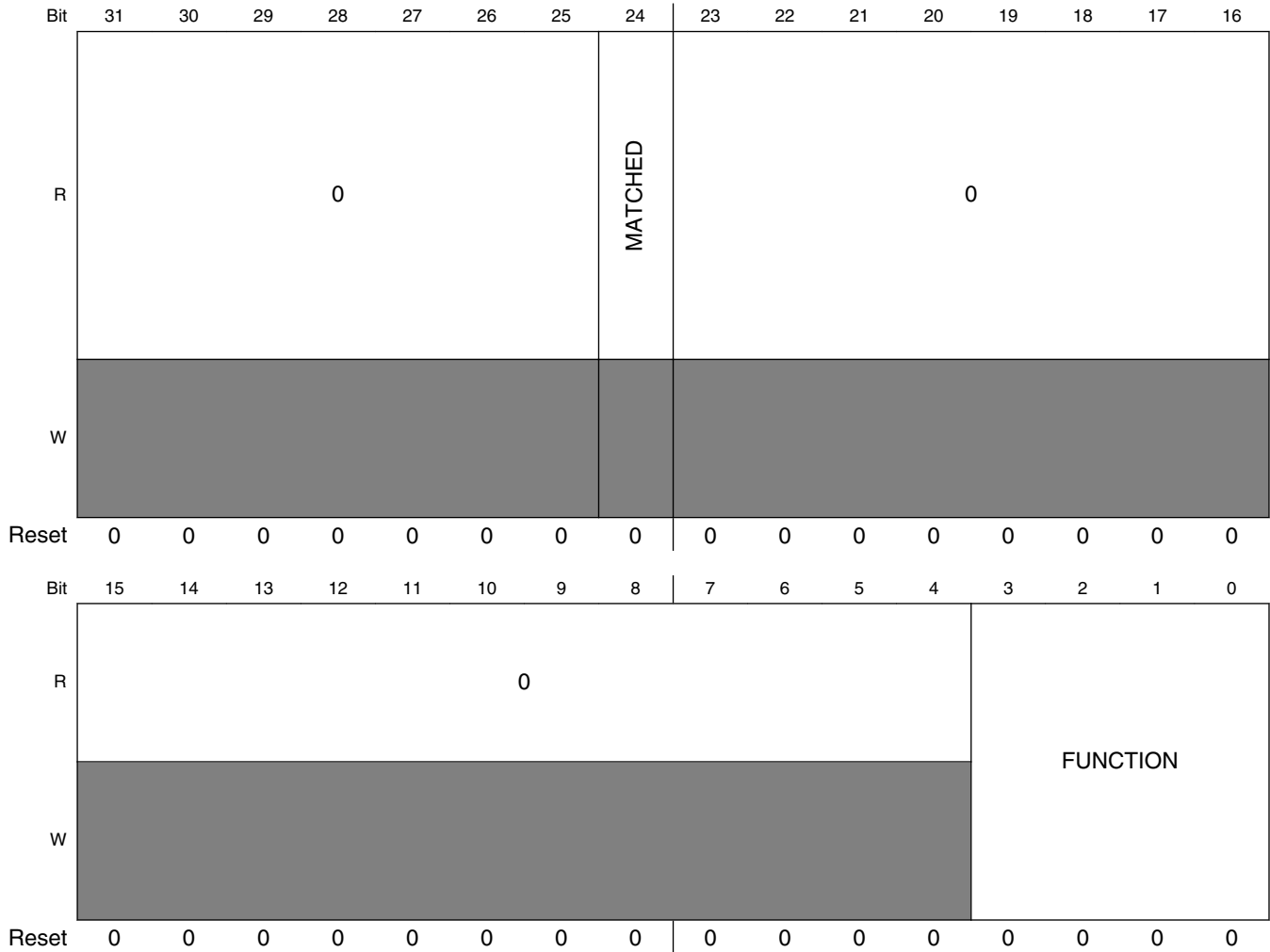

MTB_DWT_FCT1 field descriptions

Field	Description
31–25 Reserved	This field is reserved. This read-only field is reserved and always has the value 0.
24 MATCHED	Comparator match If this read-only flag is asserted, it indicates the operation defined by the FUNCTION field occurred since the last read of the register. Reading the register clears this bit.

Table continues on the next page...

MTB_DWT_FCT1 field descriptions (continued)

Field	Description
	0 No match. 1 Match occurred.
23–4 Reserved	This field is reserved. This read-only field is reserved and always has the value 0.
FUNCTION	<p>Function</p> <p>Selects the action taken on a comparator match. If MTBDWT_COMP0 is used for a data value and MTBDWT_COMP1 for an address value, then MTBDWT_FCT1[FUNCTION] must be set to zero. For this configuration, MTBDWT_MASK1 can be set to a non-zero value, so the combined comparators match on a range of addresses.</p> <p>0000 Disabled. 0100 Instruction fetch. 0101 Data operand read. 0110 Data operand write. 0111 Data operand (read + write). others Reserved. Any attempts to use this value results in UNPREDICTABLE behavior.</p>

9.2.1.6 MTB_DWT Trace Buffer Control Register (MTB_DWT_TBCTRL)

The MTBDWT_TBCTRL register defines how the watchpoint comparisons control the actual trace buffer operation.

Recall the MTB supports starting and stopping the program trace based on the watchpoint comparisons signaled via TSTART and TSTOP. The watchpoint comparison signals are enabled in the MTB's control logic by setting the appropriate enable bits, MTB_MASTER[TSTARTEN, TSTOPEN]. In the event of simultaneous assertion of both TSTART and TSTOP, TSTART takes priority. There are two signals formed by the MTB_DWT module and driven to the MTB_RAM controller: TSTART (trace start) and TSTOP (trace stop). These signals can be configured using the trace watchpoints to define programmable addresses and data values to affect the program trace recording state.

Address: 0h base + 200h offset = 200h

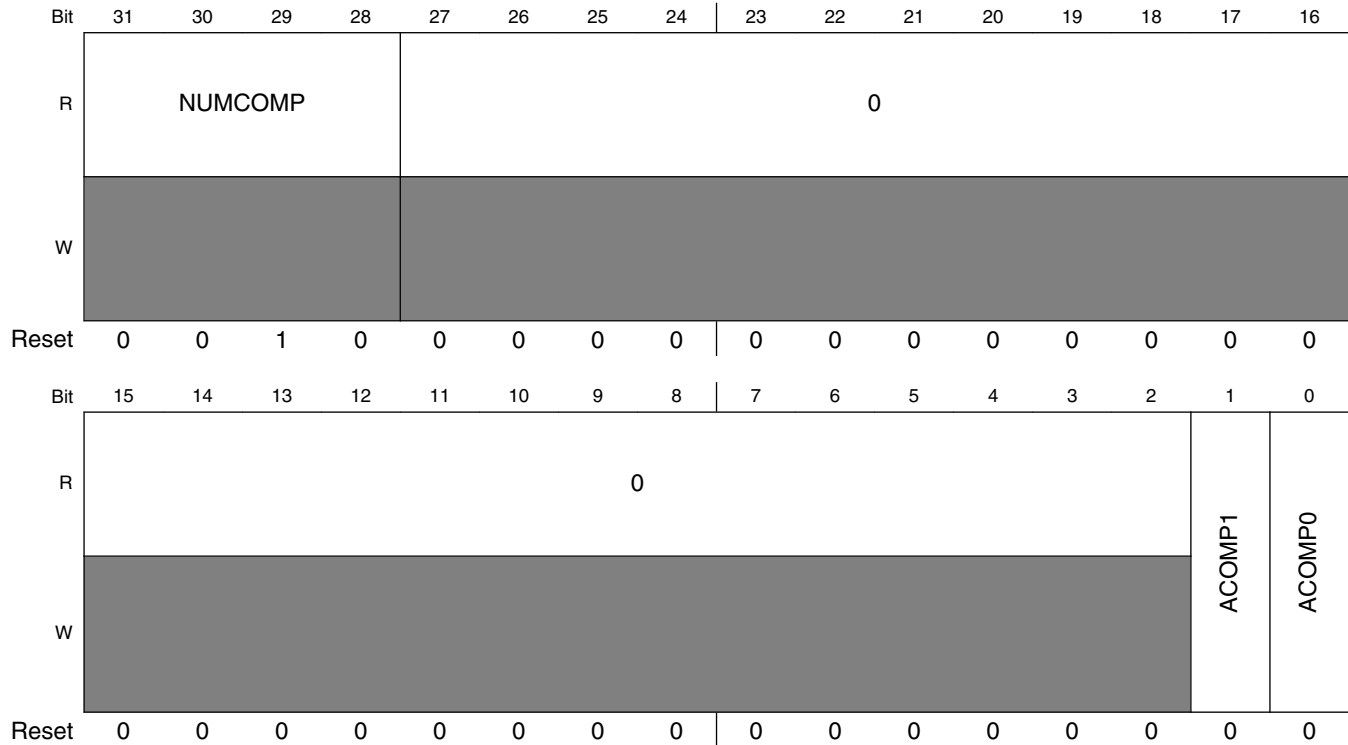

MTB_DWT_TBCTRL field descriptions

Field	Description
31–28 NUMCOMP	Number of Comparators This read-only field specifies the number of comparators in the MTB_DWT. This implementation includes two registers.
27–2 Reserved	This field is reserved. This read-only field is reserved and always has the value 0.
1 ACOMP1	Action based on Comparator 1 match When the MTBDWT_FCT1[MATCHED] is set, it indicates MTBDWT_COMP1 address compare has triggered and the trace buffer's recording state is changed. 0 Trigger TSTOP based on the assertion of MTBDWT_FCT1[MATCHED]. 1 Trigger TSTART based on the assertion of MTBDWT_FCT1[MATCHED].
0 ACOMP0	Action based on Comparator 0 match When the MTBDWT_FCT0[MATCHED] is set, it indicates MTBDWT_COMP0 address compare has triggered and the trace buffer's recording state is changed. The assertion of MTBDWT_FCT0[MATCHED] is caused by the following conditions: <ul style="list-style-type: none"> • Address match in MTBDWT_COMP0 when MTBDWT_FCT0[DATAVMATCH] = 0 • Data match in MTBDWT_COMP0 when MTBDWT_FCT0[DATAVMATCH, DATAVADDR0] = {1,0} • Data match in MTBDWT_COMP0 and address match in MTBDWT_COMP1 when MTBDWT_FCT0[DATAVMATCH, DATAVADDR0] = {1,1} 0 Trigger TSTOP based on the assertion of MTBDWT_FCT0[MATCHED]. 1 Trigger TSTART based on the assertion of MTBDWT_FCT0[MATCHED].

9.2.1.7 Device Configuration Register (MTB_DWT_DEVICECFG)

This register indicates the device configuration. It is hardwired to specific values used during the auto-discovery process by an external debug agent.

Address: 0h base + FC8h offset = FC8h

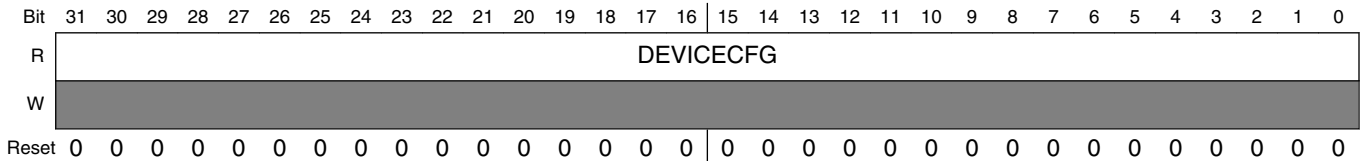

MTB_DWT_DEVICECFG field descriptions

Field	Description
DEVICECFG	DEVICECFG Hardwired to 0x0000_0000.

9.2.1.8 Device Type Identifier Register (MTB_DWT_DEVICETYPID)

This register indicates the device type ID. It is hardwired to specific values used during the auto-discovery process by an external debug agent.

Address: 0h base + FCCh offset = FCCh

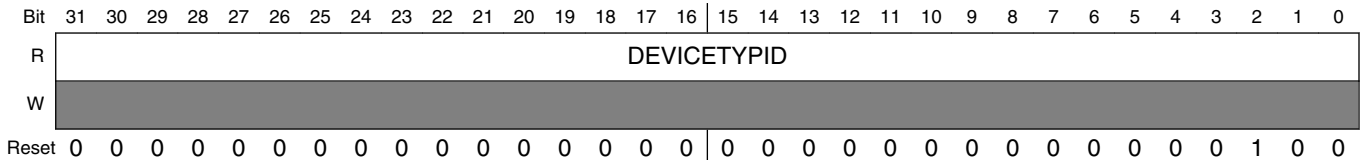

MTB_DWT_DEVICETYPID field descriptions

Field	Description
DEVICETYPID	DEVICETYPID Hardwired to 0x0000_0004.

9.2.1.9 Peripheral ID Register (MTB_DWT_PERIPHID_n)

These registers indicate the peripheral IDs. They are hardwired to specific values used during the auto-discovery process by an external debug agent. See bit field descriptions for the reset values.

Address: 0h base + FD0h offset + (4d × i), where i=0d to 7d

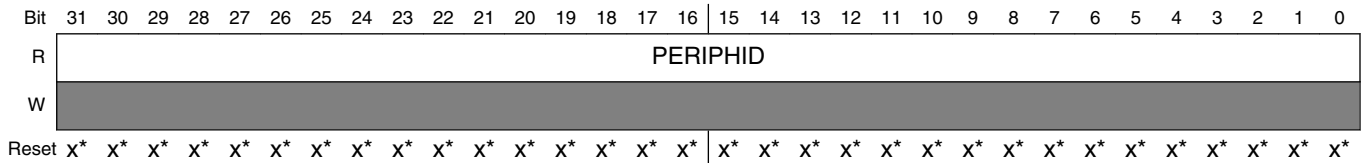

* Notes:

- x = Undefined at reset.

MTB_DWT_PERIPHID_n field descriptions

Field	Description
PERIPHID	PERIPHID Peripheral ID1 is hardwired to 0x0000_00E0; ID2 to 0x0000_0008; and all the others to 0x0000_0000.

9.2.1.10 Component ID Register (MTB_DWT_COMPID_n)

These registers indicate the component IDs. They are hardwired to specific values used during the auto-discovery process by an external debug agent. See bit field descriptions for the reset values.

Address: 0h base + FF0h offset + (4d × i), where i=0d to 3d

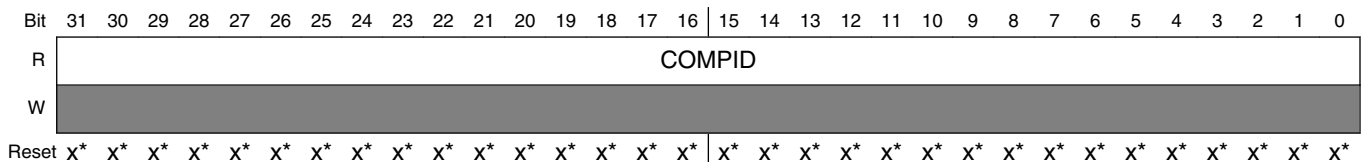

* Notes:

- x = Undefined at reset.

MTB_DWT_COMPID_n field descriptions

Field	Description
COMPID	Component ID Component ID0 is hardwired to 0x0000_000D; ID1 to 0x0000_0090; ID2 to 0x0000_0005; ID3 to 0x0000_00B1.

MTB_DWT_COMPID n field descriptions (continued)

Field	Description
-------	-------------

Chapter 10

Miscellaneous Control Module (MCM)

10.1 Chip-specific MCM information

The following table summarizes the chip-specific register reset values of this module for each chip in the product series.

Table 10-1. MCM register reset values

Register	S32K116	S32K118	S32K142	S32K144	S32K14xW	S32K146	S32K148
MCM_LMDR0	8104_0000	8104_0000	8504_0003	8604_0003	8604_0003	8704_0003	8804_0003
MCM_LMDR1	8504_2003	9604_2003	8504_2003	8604_2003	8604_2003	8704_2003	8804_2003
MCM_LMDR2	NA	NA	8424_40A0	8424_40A0	8424_40A0	8424_40A0	8424_40A0
MCM_PLASC	0007	0007	0007	0007	0007	0007	000F
MCM_PLAMC	0005	0005	0007	0007	0007	0007	000F

NOTE

- For S32K11x , LMDR information can be inferred for SRAM size as below:
 - S32K116: LMDR1[LMSZH]=0, LMDR1[LMSZH]=0x5 , so SRAM_U size $1*(16)$ KB = 16 KB. Actual size is 16 KB – 2 KB = 14 KB
 - S32K118: LMDR1[LMSZH]=1, LMDR1[LMSZH]=0x6 , so SRAM_U size $0.75*(32)$ KB = 24 KB. Actual size is 24 KB – 2 KB = 22 KB
- For S32K14x and S32K14xW variants SRAM is the tightly coupled SRAM (TCM), while for S32K11x variants SRAM is at the crossbar slave side.

Address offset of LMPEIR register varies between S32K14x, S32K14xW, and S32K11x as given below.

Table 10-2. MCM register offset

Register	S32K14x offset	S32K14xW offset	S32K11x offset
MCM_LMPEIR	0x488	0x488	0x484

10.2 Introduction

The Miscellaneous Control Module (MCM) provides miscellaneous control functions.

NOTE

- Cache write buffer is not supported on S32K1xx and S32K14xW variants.
- ECC on SRAML/MTB, FPU, and Cache is not supported on S32K11x.

10.2.1 Features

The MCM includes the following feature:

- Program-visible information on the platform configuration and revision

10.3 Memory map/register descriptions

The memory map and register descriptions below describe the Miscellaneous Control Module registers.

NOTE

- All registers are accessible only in Supervisor mode. User mode accesses will generate an error.
- Writing to read-only MCM_PLASC and MCM_PLAMC registers, would generate a bus error.

MCM memory map

Address offset (hex)	Register name	Width (in bits)	Access	Reset value	Section/page
8	Crossbar Switch (AXBS) Slave Configuration (MCM_PLASC)	16	R	0007h	10.3.1/145
A	Crossbar Switch (AXBS) Master Configuration (MCM_PLAMC)	16	R	0007h	10.3.2/146
C	Core Platform Control Register (MCM_CPCR)	32	R/W	See section	10.3.3/147
10	Interrupt Status and Control Register (MCM_ISCR)	32	R	0002_0000h	10.3.4/150
30	Process ID Register (MCM_PID)	32	R/W	0000_0000h	10.3.5/153
40	Compute Operation Control Register (MCM_CPO)	32	R/W	0000_0000h	10.3.6/154
400	Local Memory Descriptor Register (MCM_LMDR0)	32	R/W	See section	10.3.7/155
404	Local Memory Descriptor Register (MCM_LMDR1)	32	R/W	See section	10.3.7/155
408	Local Memory Descriptor Register2 (MCM_LMDR2)	32	R/W	8424_40A0h	10.3.8/158
480	LMEM Parity and ECC Control Register (MCM_LMPECR)	32	R/W	0000_0000h	10.3.9/162
488	LMEM Parity and ECC Interrupt Register (MCM_LMPEIR)	32	R/W	0000_0000h	10.3.10/163
490	LMEM Fault Address Register (MCM_LMFAR)	32	R	0000_0000h	10.3.11/164
494	LMEM Fault Attribute Register (MCM_LMFATR)	32	R	0000_0000h	10.3.12/165
4A0	LMEM Fault Data High Register (MCM_LMFDHR)	32	R	0000_0000h	10.3.13/166
4A4	LMEM Fault Data Low Register (MCM_LMFDLR)	32	R	0000_0000h	10.3.14/166

10.3.1 Crossbar Switch (AXBS) Slave Configuration (MCM_PLASC)

PLASC is a 16-bit read-only register identifying the presence/absence of bus slave connections to the device's crossbar switch.

Address: 0h base + 8h offset = 8h

Bit	15	14	13	12	11	10	9	8	7	6	5	4	3	2	1	0	
Read	0								ASC								
Write																	
Reset	0	0	0	0	0	0	0	0	0	0	0	0	0	0	1	1	1

MCM_PLASC field descriptions

Field	Description
15–8 Reserved	This field is reserved. This read-only field is reserved and always has the value 0.
ASC	Each bit in the ASC field indicates whether there is a corresponding connection to the crossbar switch's slave input port. 0 A bus slave connection to AXBS input port <i>n</i> is absent 1 A bus slave connection to AXBS input port <i>n</i> is present

10.3.2 Crossbar Switch (AXBS) Master Configuration (MCM_PLAMC)

PLAMC is a 16-bit read-only register identifying the presence/absence of bus master connections to the device's crossbar switch.

Address: 0h base + Ah offset = Ah

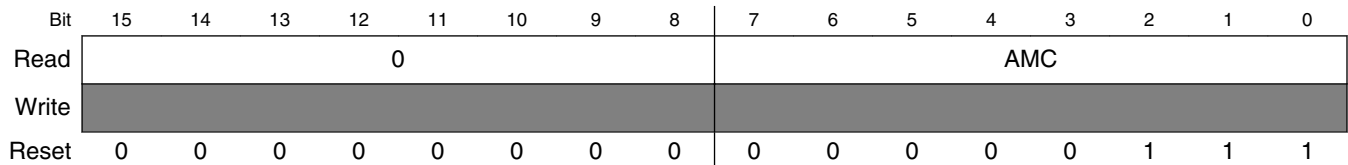

MCM_PLAMC field descriptions

Field	Description
15–8 Reserved	This field is reserved. This read-only field is reserved and always has the value 0.
AMC	Each bit in the AMC field indicates whether there is a corresponding connection to the AXBS master input port. 0 A bus master connection to AXBS input port <i>n</i> is absent 1 A bus master connection to AXBS input port <i>n</i> is present

10.3.3 Core Platform Control Register (MCM_CPCR)

CPCR defines the arbitration and protection schemes for the two system RAM arrays.

Address: 0h base + Ch offset = Ch

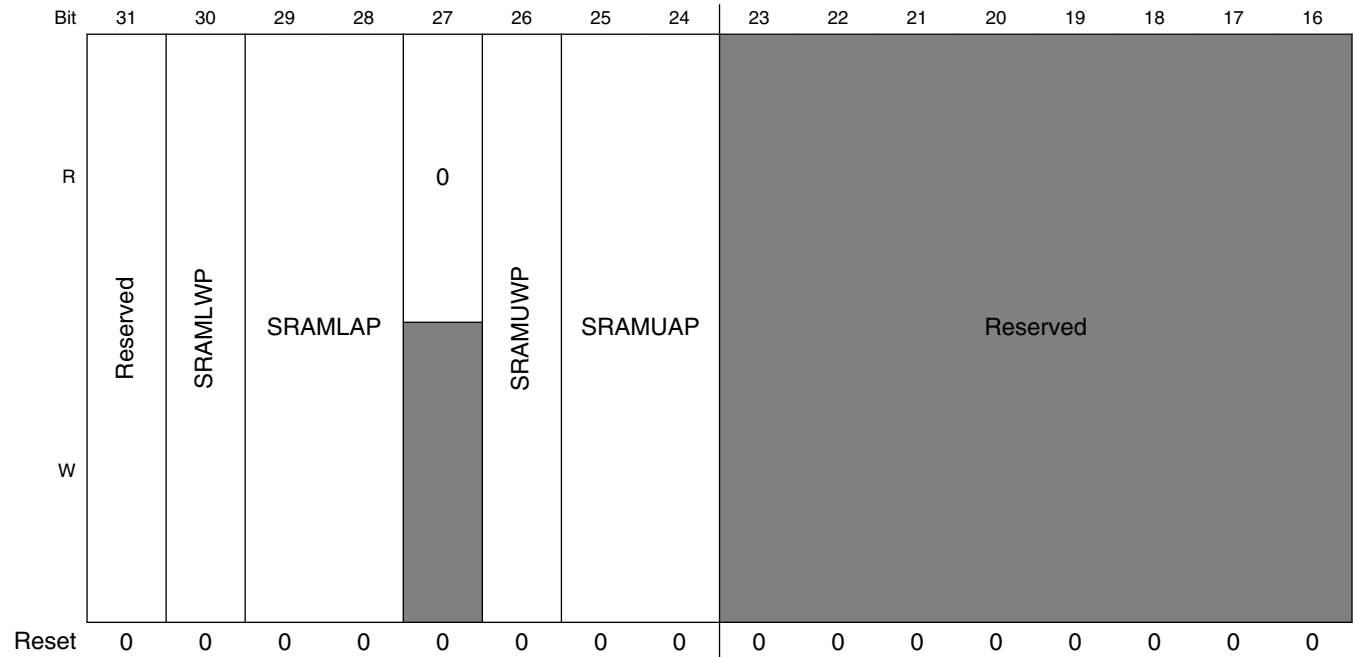

Memory map/register descriptions

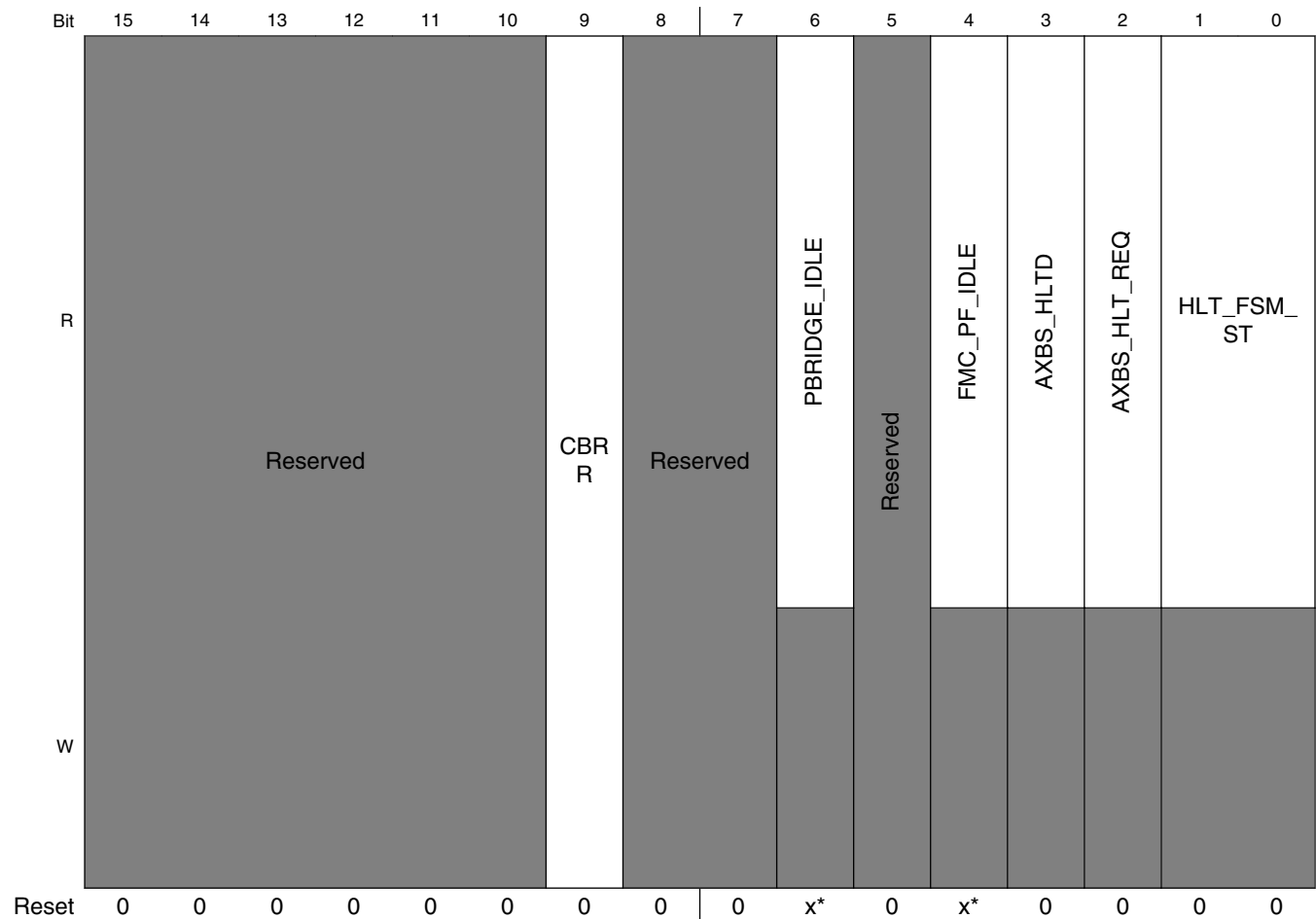

* Notes:

- x = Undefined at reset.

MCM_CPCR field descriptions

Field	Description
31 Reserved	This field is reserved.
30 SRAMLWP	SRAM_L Write Protect When this field is set, writes to SRAM_L array generate a bus error. NOTE: This bit field is Reserved and Read-Only 0 for S32K11x variants.
29–28 SRAMLAP	SRAM_L Arbitration Priority Defines the arbitration scheme and priority for the processor and SRAM backdoor accesses to the SRAM_L array. NOTE: This bit field is Reserved and Read-Only 0 for S32K11x variants. 00 Round robin 01 Special round robin (favors SRAM backdoor accesses over the processor) 10 Fixed priority. Processor has highest, backdoor has lowest 11 Fixed priority. Backdoor has highest, processor has lowest

Table continues on the next page...

MCM_CPCR field descriptions (continued)

Field	Description
27 Reserved	This field is reserved. This read-only field is reserved and always has the value 0.
26 SRAMUWP	SRAM_U Write Protect When this field is set, writes to SRAM_U array generate a bus error. NOTE: This bit field is Reserved and Read-Only 0 for S32K11x variants.
25–24 SRAMUAP	SRAM_U Arbitration Priority Defines the arbitration scheme and priority for the processor and SRAM backdoor accesses to the SRAM_U array. NOTE: This bit field is Reserved and Read-Only 0 for S32K11x variants. 00 Round robin 01 Special round robin (favors SRAM backdoor accesses over the processor) 10 Fixed priority. Processor has highest, backdoor has lowest 11 Fixed priority. Backdoor has highest, processor has lowest
23–10 Reserved	This field is reserved.
9 CBRR	Crossbar Round-robin Arbitration Enable Configures the crossbar slave ports to fixed-priority or round-robin arbitration. NOTE: Highly recommended to configure this bit field to round-robin mode before configuring any other master, for example: DMA, ENET etc., as fixed arbitration may generate stalls or under runs on low priority master. 0 Fixed-priority arbitration 1 Round-robin arbitration
8–7 Reserved	This field is reserved.
6 PBRIDGE_IDLE	Peripheral Bridge Idle This field indicates if the Peripheral Bridge is idle. 0 PBRIDGE is not idle 1 PBRIDGE is currently idle
5 Reserved	This field is reserved.
4 FMC_PF_IDLE	Flash Memory Controller Program Flash Idle This field indicates if the program portion of the flash memory is idle. 0 FMC program flash is not idle 1 FMC program flash is currently idle
3 AXBS_HLTD	AXBS Halted This field indicates if AXBS is in a halted state. 0 AXBS is not currently halted 1 AXBS is currently halted

Table continues on the next page...

MCM_CPCR field descriptions (continued)

Field	Description
2 AXBS_HLT_REQ	<p>AXBS Halt Request</p> <p>This field indicates if AXBS has received a halt request.</p> <p>0 AXBS is not receiving halt request 1 AXBS is receiving halt request</p>
HLT_FSM_ST	<p>AXBS Halt State Machine Status</p> <p>This field indicates the state of an AXBS halt.</p> <p>00 Waiting for request 01 Waiting for platform idle 11 Platform stalled 10 Unused state</p>

10.3.4 Interrupt Status and Control Register (MCM_ISCR)

ISCR defines the configuration and reports status for a number of core-related interrupt exception conditions. It includes the enable and status fields associated with the core’s floating-point exceptions and the bus errors associated with the core’s cache write buffer. The individual event indicators are first qualified with their exception enables and then logically summed to form an interrupt request sent to the core’s NVIC.

Bits 15-8 are read-only indicator flags based on the processor’s FPSCR. Attempted writes to these fields are ignored. After the flags are set, they remain asserted until software clears the corresponding FPSCR field.

NOTE

This register is Reserved for S32K11x variants.

Address: 0h base + 10h offset = 10h

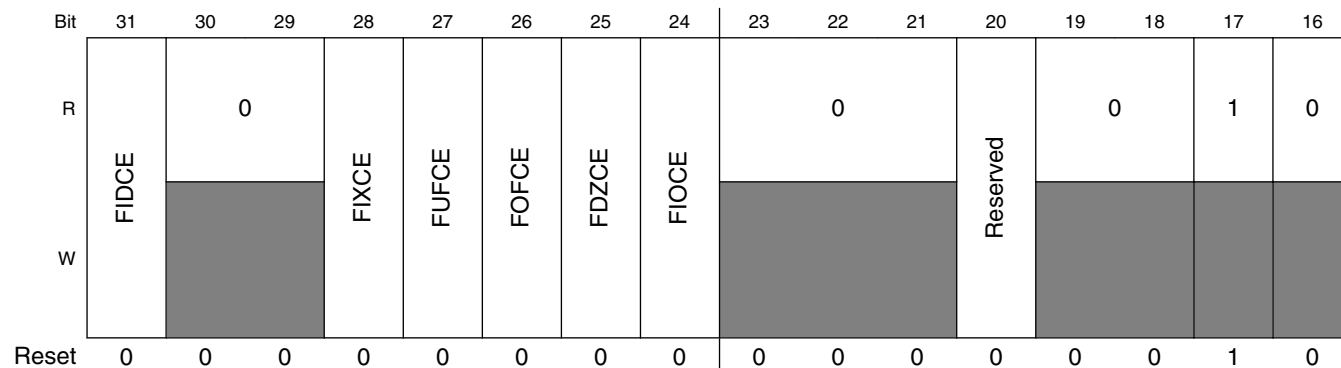

Bit	15	14	13	12	11	10	9	8	7	6	5	4	3	2	1	0
R	FIDC	0	FIXC	FUFC	FOFC	FDZC	FIOC	0	Reserved	0	0	0	0	0	0	0
W												w1c				
Reset	0	0	0	0	0	0	0	0	0	0	0	0	0	0	0	0

MCM_ISCR field descriptions

Field	Description
31 FIDCE	FPU Input Denormal Interrupt Enable 0 Disable interrupt 1 Enable interrupt
30–29 Reserved	This field is reserved. This read-only field is reserved and always has the value 0.
28 FIXCE	FPU Inexact Interrupt Enable 0 Disable interrupt 1 Enable interrupt
27 FUFCE	FPU Underflow Interrupt Enable 0 Disable interrupt 1 Enable interrupt
26 FOFCE	FPU Overflow Interrupt Enable 0 Disable interrupt 1 Enable interrupt
25 FDZCE	FPU Divide-by-Zero Interrupt Enable 0 Disable interrupt 1 Enable interrupt
24 FIOCE	FPU Invalid Operation Interrupt Enable 0 Disable interrupt 1 Enable interrupt
23–21 Reserved	This field is reserved. This read-only field is reserved and always has the value 0.
20 Reserved	This field is reserved.
19–18 Reserved	This field is reserved. This read-only field is reserved and always has the value 0.

Table continues on the next page...

MCM_ISCR field descriptions (continued)

Field	Description
17 Reserved	This field is reserved. This read-only field is reserved and always has the value 1.
16 Reserved	This field is reserved. This read-only field is reserved and always has the value 0.
15 FIDC	FPU Input Denormal Interrupt Status This field is a copy of the core's FPSCR[IDC] field and signals input denormalized number has been detected in the processor's FPU. After the field is set, it remains set until software clears FPSCR[IDC]. 0 No interrupt 1 Interrupt occurred
14–13 Reserved	This field is reserved. This read-only field is reserved and always has the value 0.
12 FIXC	FPU Inexact Interrupt Status This field is a copy of the core's FPSCR[IXC] field and signals an inexact number has been detected in the processor's FPU. Once set, this field remains set until software clears FPSCR[IXC]. 0 No interrupt 1 Interrupt occurred
11 FUFC	FPU Underflow Interrupt Status This field is a copy of the core's FPSCR[UFC] field and signals an underflow has been detected in the processor's FPU. After this field is set, it remains set until software clears FPSCR[UFC]. 0 No interrupt 1 Interrupt occurred
10 FOFC	FPU Overflow Interrupt Status This field is a copy of the core's FPSCR[OFC] field and signals an overflow has been detected in the processor's FPU. After this field is set, it remains set until software clears FPSCR[OFC]. 0 No interrupt 1 Interrupt occurred
9 FDZC	FPU Divide-by-Zero Interrupt Status This field is a copy of the core's FPSCR[DZC] field and signals a divide by zero has been detected in the processor's FPU. After this field is set, it remains set until software clears FPSCR[DZC]. 0 No interrupt 1 Interrupt occurred
8 FIOC	FPU Invalid Operation Interrupt Status This field is a copy of the core's FPSCR[IOC] field and signals an illegal operation has been detected in the processor's FPU. After this field is set, it remains set until software clears FPSCR[IOC]. 0 No interrupt 1 Interrupt occurred
7–5 Reserved	This field is reserved. This read-only field is reserved and always has the value 0.

Table continues on the next page...

MCM_ISCR field descriptions (continued)

Field	Description
4 Reserved	This field is reserved.
Reserved	This field is reserved. This read-only field is reserved and always has the value 0.

10.3.5 Process ID Register (MCM_PID)

This register drives the M0_PID and M1_PID values in the Memory Protection Unit (MPU). System software loads this register before passing control to a given user mode process. If the PID of the process does not match the value in this register, a bus error occurs. See the MPU chapter for more details.

Address: 0h base + 30h offset = 30h

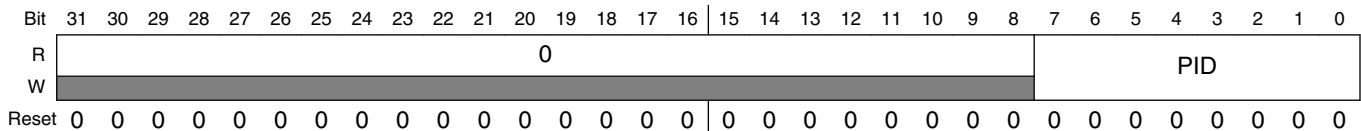
**MCM_PID field descriptions**

Field	Description
31–8 Reserved	This field is reserved. This read-only field is reserved and always has the value 0.
PID	M0_PID and M1_PID for MPU Drives the M0_PID and M1_PID values in the MPU.

10.3.6 Compute Operation Control Register (MCM_CPO)

This register controls the compute operation.

Address: 0h base + 40h offset = 40h

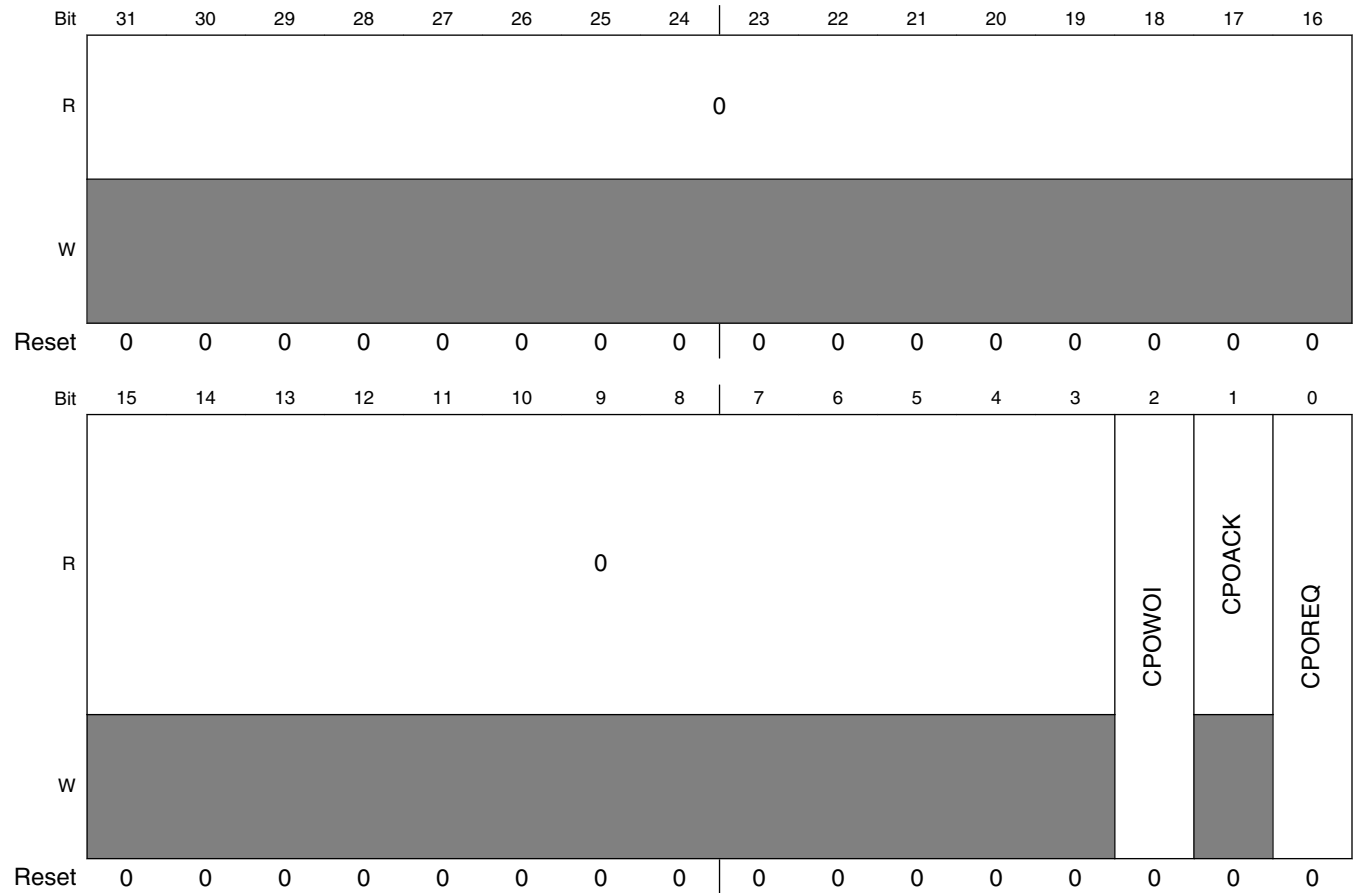

MCM_CPO field descriptions

Field	Description
31–3 Reserved	This field is reserved. This read-only field is reserved and always has the value 0.
2 CPOWOI	Compute Operation Wakeup On Interrupt 0 No effect. 1 When set, the CPOREQ is cleared on any interrupt or exception vector fetch.
1 CPOACK	Compute Operation Acknowledge 0 Compute operation entry has not completed or compute operation exit has completed. 1 Compute operation entry has completed or compute operation exit has not completed.
0 CPOREQ	Compute Operation Request This field is auto-cleared by vector fetching if CPOWOI = 1.

Table continues on the next page...

MCM_CPO field descriptions (continued)

Field	Description
0	Request is cleared.
1	Request Compute Operation.

10.3.7 Local Memory Descriptor Register (MCM_LMDR_n)

The LMDR_n registers mapping to the LMEMs is as follows:

- LMDR0: SRAM_L
- LMDR1: SRAM_U

This section of the programming model is an array of 32-bit generic on-chip memory descriptor registers that provide static information on the attached memories as well as configurable controls (where appropriate).

Privileged 32-bit reads from a processor core or the debugger return the appropriate processor information. Reads from any other bus master return all zeroes. Privileged writes from a processor core or the debugger to writeable registers update the appropriate fields. Privileged writes from other bus masters are ignored. Attempted user mode accesses or any access with a size other than 32 bits are terminated with an error.

Memory map/register descriptions

Address: 0h base + 400h offset + (4d × i), where i=0d to 1d

Bit	31	30	29	28	27	26	25	24	23	22	21	20	19	18	17	16
R	V	Reserved	Reserved	LMSZH	LMSZ				WY				DPW			LOCK
W	Reserved			Reserved	Reserved				Reserved				Reserved			Reserved
Reset	x*	x*	x*	x*	x*	x*	x*	x*	x*	x*	x*	x*	x*	x*	x*	x*
Bit	15	14	13	12	11	10	9	8	7	6	5	4	3	2	1	0
R	MT			Reserved	Reserved				Reserved				CF0			
W	Reserved			Reserved	Reserved				Reserved				Reserved			
Reset	x*	x*	x*	x*	x*	x*	x*	x*	x*	x*	x*	x*	x*	x*	x*	x*

* Notes:

- The reset values are different for the individual LMDR registers. LMDR0: 0x8804_0003; LMDR1: 0x8804_2003. x = Undefined at reset.

MCM_LMDRn field descriptions

Field	Description
31 V	Local Memory Valid This field defines the validity (presence) of the local memory. 0 LMEMn is not present. 1 LMEMn is present.
30 Reserved	This field is reserved.
29 Reserved	This field is reserved.
28 LMSZH	LMEM Size Hole For local memories that are not fully populated, that is, include a memory hole in the upper 25% of the address range, this field is used. 0 LMEMn is a power-of-2 capacity. 1 LMEMn is not a power-of-2, with a capacity is $0.75 \times \text{LMSZ}$.
27–24 LMSZ	LMEM Size This field provides an encoded value of the local memory size. The capacity of the memory is expressed as $\text{Size [bytes]} = 2^{(9+\text{LMSZ})}$ where LMSZ is non-zero; a LMSZ = 0 indicates the memory is not present. 0000 no LMEMn (0 KB) 0001 1 KB LMEMn 0010 2 KB LMEMn 0011 4 KB LMEMn 0100 8 KB LMEMn 0101 16 KB LMEMn 0110 32 KB LMEMn 0111 64 KB LMEMn 1000 128 KB LMEMn 1001 256 KB LMEMn 1010 512 KB LMEMn 1011 1024 KB LMEMn 1100 2048 KB LMEMn 1101 4096 KB LMEMn 1110 8192 KB LMEMn 1111 16384 KB LMEMn
23–20 WY	Level 1 Cache Ways 0000 No Cache 0010 2-Way Set Associative 0100 4-Way Set Associative
19–17 DPW	LMEM Data Path Width. This field defines the width of the local memory. 000-001 Reserved

Table continues on the next page...

MCM_LMDR_n field descriptions (continued)

Field	Description
	010 LMEM _n 32-bits wide 011 LMEM _n 64-bits wide 100-111 Reserved
16 LOCK	<p>LOCK</p> <p>Lock bit.</p> <p>This field provides a mechanism to lock the configuration state defined by LMDR_n[7:0]. Once asserted, attempted writes to the LMDR_n[7:0] register are ignored until the next reset clears the flag. Along with LMDR_n[7:0], this bit locks itself. Once locked, only reset can clear this bit.</p> <p>NOTE: This bit field is Reserved and Read-Only 0 for S32K11x variants.</p> <p>0 Writes to the LMDR_n[7:0] are allowed. 1 Writes to the LMDR_n[7:0] are ignored.</p>
15–13 MT	<p>Memory Type</p> <p>This field defines the type of the local memory.</p> <p>000 SRAM_L 001 SRAM_U</p>
12 Reserved	This field is reserved.
11–8 Reserved	This field is reserved.
7–4 Reserved	This field is reserved.
CF0	<p>Control Field 0</p> <p style="text-align: center;">NOTE</p> <p style="text-align: center;">LMDR0[CF0] bit field is Reserved and Read-Only 0 for S32K11x variants.</p> <p>This field is used for TCM ECC control functions.</p> <ul style="list-style-type: none"> • CF0[3] - Reserved • CF0[2] - Reserved • CF0[1] - EERC = ECC Enable Read Check • CF0[0] - EEWG = ECC Enable Write Generation

10.3.8 Local Memory Descriptor Register2 (MCM_LMDR2)

The LMDR2 registers mapping to the LMEMs representing PC CACHE.

NOTE

This value represents the maximum available cache within the entire family. See [Figure 2-3](#) to view the specific amount of cache for a particular device.

This section of the programming model is an array of 32-bit generic on-chip memory descriptor registers that provide static information on the attached memories as well as configurable controls (where appropriate).

Privileged 32-bit reads from a processor core or the debugger return the appropriate processor information. Reads from any other bus master return all zeroes. Privileged writes from a processor core or the debugger to writeable registers update the appropriate fields. Privileged writes from other bus masters are ignored. Attempted user mode accesses or any access with a size other than 32 bits are terminated with an error.

Address: 0h base + 408h offset = 408h

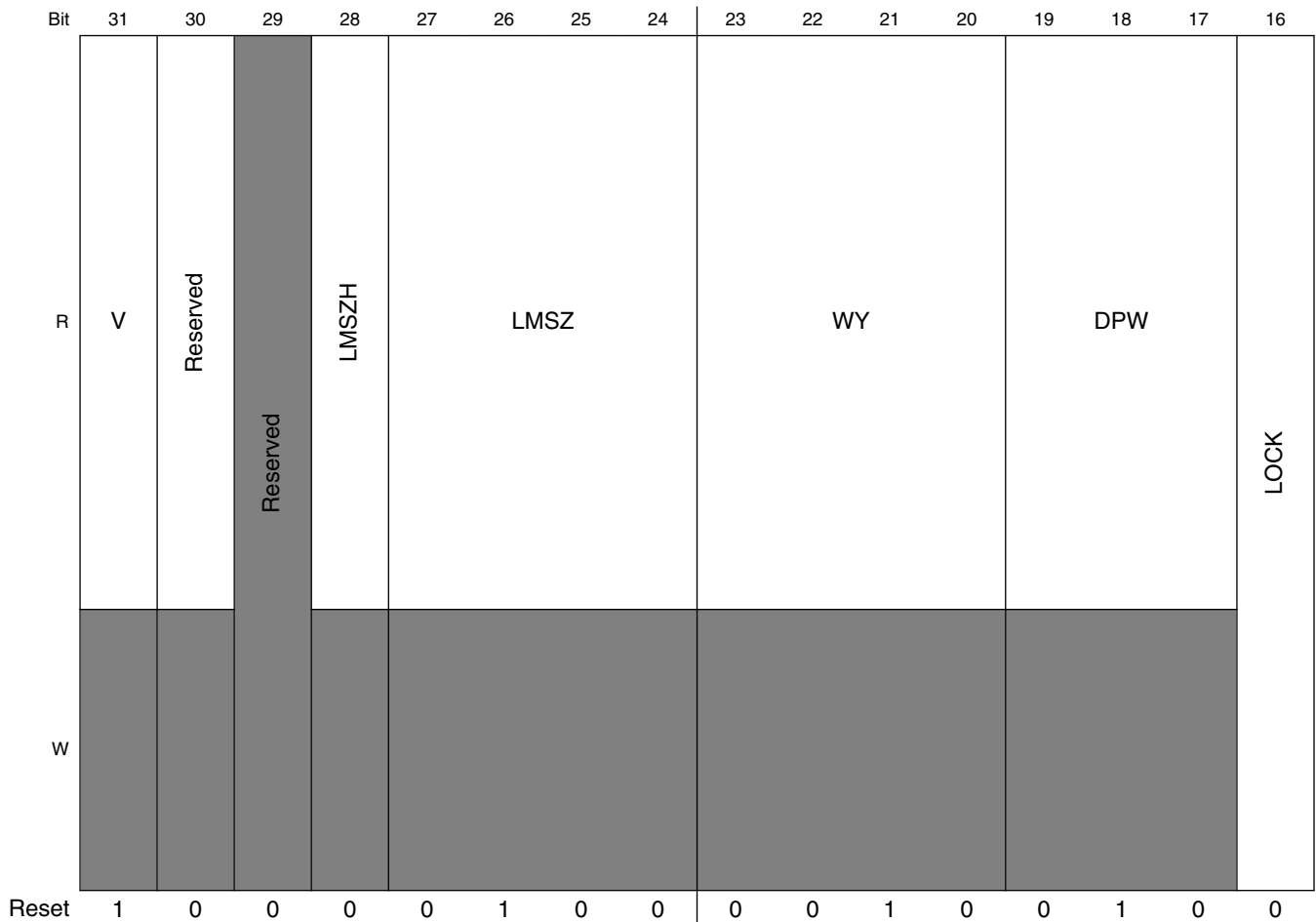

Memory map/register descriptions

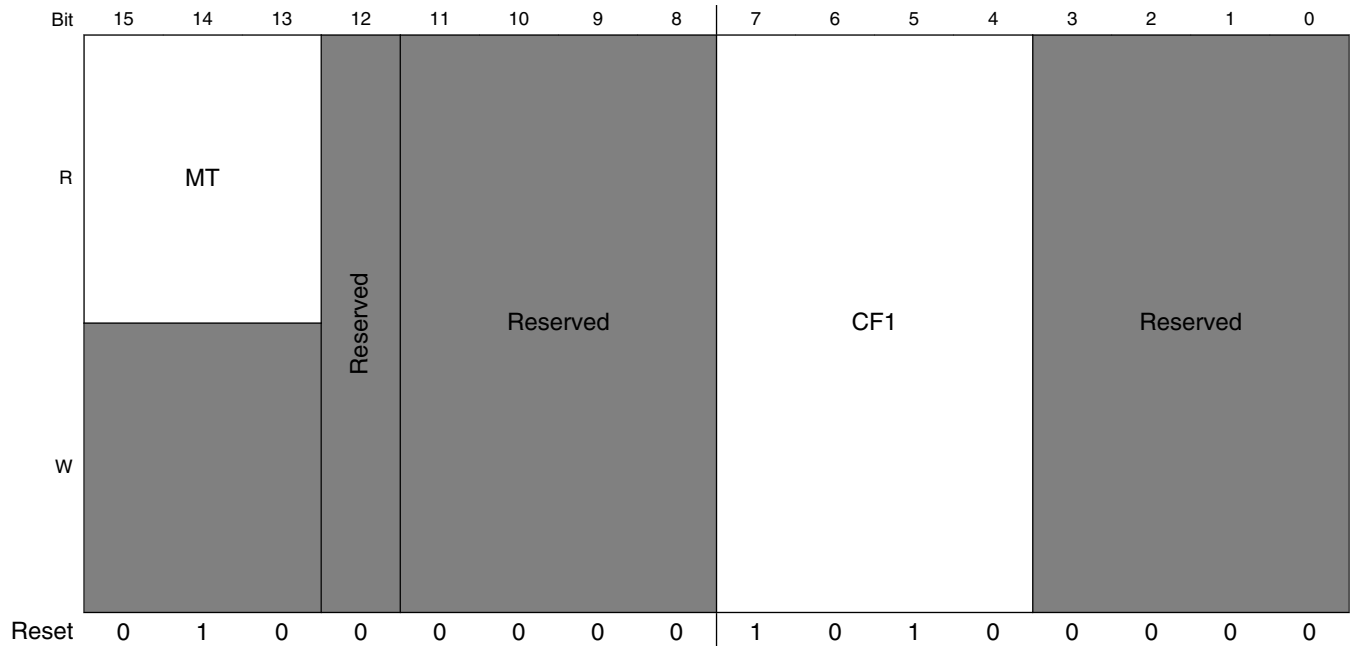

MCM_LMDR2 field descriptions

Field	Description
31 V	Local Memory Valid This field defines the validity (presence) of the local memory. 0 LMEMn is not present. 1 LMEMn is present.
30 Reserved	This field is reserved.
29 Reserved	This field is reserved.
28 LMSZH	LMEM Size Hole For local memories that are not fully populated, that is, include a memory hole in the upper 25% of the address range, this field is used. 0 LMEMn is a power-of-2 capacity. 1 LMEMn is not a power-of-2, with a capacity is $0.75 \times \text{LMSZ}$.
27–24 LMSZ	LMEM Size This field provides an encoded value of the local memory size; a LMSZ = 0 indicates the memory is not present. 0100 4 KB LMEMn
23–20 WY	Level 1 Cache Ways 0000 No Cache 0010 2-Way Set Associative 0100 4-Way Set Associative

Table continues on the next page...

MCM_LMDR2 field descriptions (continued)

Field	Description
19–17 DPW	LMEM Data Path Width. This field defines the width of the local memory. 000-001 Reserved 010 LMEMn 32-bits wide 011 LMEMn 64-bits wide 100-111 Reserved
16 LOCK	LOCK Lock bit This field provides a mechanism to lock the configuration state defined by LMDRn[7:0]. Once asserted, attempted writes to the LMDRn[7:0] register are ignored until the next reset clears the flag. Along with LMDRn[7:0], this bit locks itself. Once locked, only reset can clear this bit. NOTE: This bit field is Reserved and Read-Only 0 for S32K11x variants. 0 Writes to the LMDRn[7:0] are allowed. 1 Writes to the LMDRn[7:0] are ignored.
15–13 MT	Memory Type This field defines the type of the local memory. 010 PC Cache
12 Reserved	This field is reserved.
11–8 Reserved	This field is reserved.
7–4 CF1	Control Field 1 This field is used for cache parity control functions. <ul style="list-style-type: none"> • CF1[3]-PCPFE = PC Parity Fault Enable • CF1[2]-Reserved • CF1[1]-PCPME = PC Parity Miss Enable • CF1[0]-Reserved
Reserved	This field is reserved.

10.3.9 LMEM Parity and ECC Control Register (MCM_LMPECR)

Address: 0h base + 480h offset = 480h

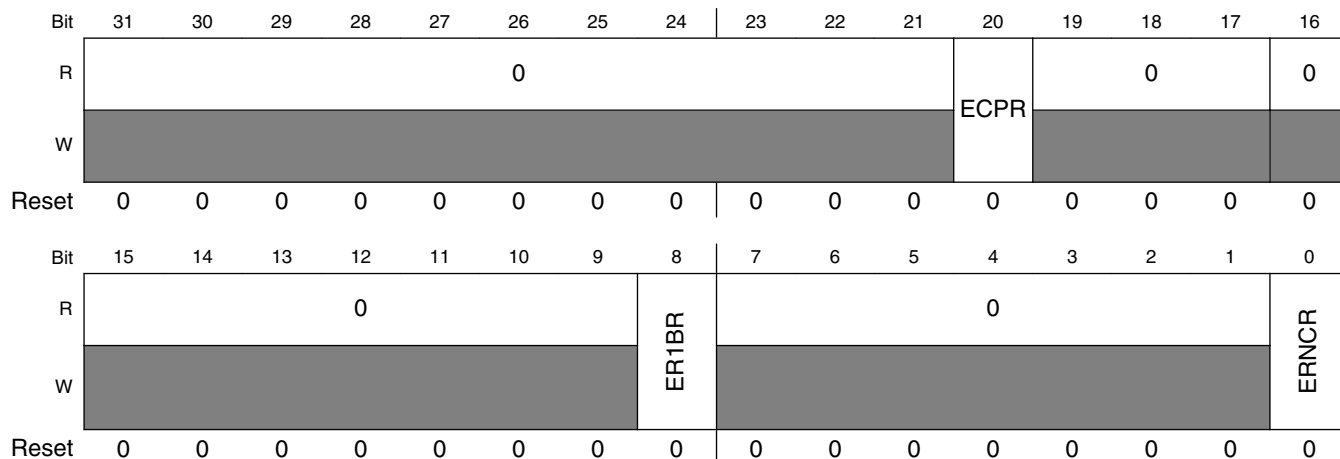

MCM_LMPECR field descriptions

Field	Description
31–21 Reserved	This field is reserved. This read-only field is reserved and always has the value 0.
20 ECPR	Enable Cache Parity Reporting NOTE: This bit field is Reserved and Read-Only 0 for S32K11x variants. 0 Reporting disabled 1 Reporting enabled
19–17 Reserved	This field is reserved. This read-only field is reserved and always has the value 0.
16 Reserved	This field is reserved. This read-only field is reserved and always has the value 0.
15–9 Reserved	This field is reserved. This read-only field is reserved and always has the value 0.
8 ER1BR	Enable RAM ECC 1 Bit Reporting NOTE This bit field is Reserved and Read-Only 0 for S32K11x variants. This bit field cannot mask ECC reporting, as a result the ECC would always be reported. 0 Reporting disabled 1 Reporting enabled
7–1 Reserved	This field is reserved. This read-only field is reserved and always has the value 0.

Table continues on the next page...

MCM_LMPECR field descriptions (continued)

Field	Description
0 ERNCR	<p>Enable RAM ECC Noncorrectable Reporting</p> <p style="text-align: center;">NOTE</p> <p style="text-align: center;">This bit field is Reserved and Read-Only 0 for S32K11x variants. This bit field cannot mask ECC reporting, as a result the ECC would always be reported.</p> <p>0 Reporting disabled 1 Reporting enabled</p>

10.3.10 LMEM Parity and ECC Interrupt Register (MCM_LMPEIR)

NOTE

Writes of 1 to the error bit in LMPEIR[23:0] can clear the interrupt flag. For S32K11x variants, MCM interrupt for ECC is not supported and this register only captures the event.

Address: 0h base + 488h offset = 488h

Bit	31	30	29	28	27	26	25	24	23	22	21	20	19	18	17	16
R	V	0		PEELOC					PE							
W									w1c							
Reset	0	0	0	0	0	0	0	0	0	0	0	0	0	0	0	0
Bit	15	14	13	12	11	10	9	8	7	6	5	4	3	2	1	0
R	E1B								ENC							
W	w1c								w1c							
Reset	0	0	0	0	0	0	0	0	0	0	0	0	0	0	0	0

MCM_LMPEIR field descriptions

Field	Description
31 V	Valid Bit
30–29 Reserved	This field is reserved. This read-only field is reserved and always has the value 0.
28–24 PEELOC	<p>Parity or ECC Error Location</p> <p>00 Non-correctable ECC event from SRAM_L 01 Non-correctable ECC event from SRAM_U 08 1-bit correctable ECC event from SRAM_L 09 1-bit correctable ECC event from SRAM_U</p>

Table continues on the next page...

MCM_LMPEIR field descriptions (continued)

Field	Description
	14 PC tag parity error 15 PC data parity error
23–16 PE	Cache Parity Error <ul style="list-style-type: none"> • [21] - PC Data Parity Error • [20] - PC Tag Parity Error • [19] - Reserved • [18] - Reserved <p>NOTE: This bit field is Reserved and Read-Only 0 for S32K11x variants.</p>
15–8 E1B	E1Bn = ECC 1-bit Error n <ul style="list-style-type: none"> • PEIR[15:10] - Reserved • PEIR[9] - 1-bit Error detected on SRAM_U • PEIR[8] - 1-bit Error detected on SRAM_L. (This is Reserved for S32K11x variants.)
ENC	ENCN = ECC Noncorrectable Error n <ul style="list-style-type: none"> • PEIR[7:2] - Reserved • PEIR[1] - Noncorrectable Error detected on SRAM_U • PEIR[0] - Noncorrectable Error detected on SRAM_L (This is Reserved for S32K11x variants.)

10.3.11 LMEM Fault Address Register (MCM_LMFAR)

Address: 0h base + 490h offset = 490h

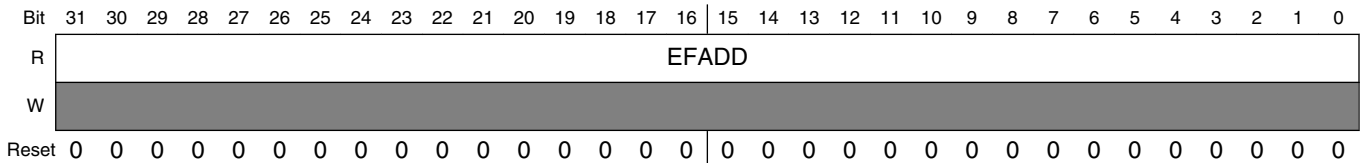

MCM_LMFAR field descriptions

Field	Description
EFADD	ECC Fault Address

10.3.12 LMEM Fault Attribute Register (MCM_LMFATR)

Address: 0h base + 494h offset = 494h

Bit	31	30	29	28	27	26	25	24	23	22	21	20	19	18	17	16	
R	OVR	0	0						0								
W	[Reserved]																
Reset	0	0	0	0	0	0	0	0	0	0	0	0	0	0	0	0	
Bit	15	14	13	12	11	10	9	8	7	6	5	4	3	2	1	0	
R	PEFMST								PEFW	PEFSIZE				PEFPRT			
W	[Reserved]																
Reset	0	0	0	0	0	0	0	0	0	0	0	0	0	0	0	0	

MCM_LMFATR field descriptions

Field	Description
31 OVR	Overflow
30 Reserved	This field is reserved. This read-only field is reserved and always has the value 0.
29–24 Reserved	This field is reserved. This read-only field is reserved and always has the value 0.
23–16 Reserved	This field is reserved. This read-only field is reserved and always has the value 0.
15–8 PEFMST	Parity/ECC Fault Master Number
7 PEFW	Parity/ECC Fault Write

Table continues on the next page...

MCM_LMFATR field descriptions (continued)

Field	Description
6-4 PEFSIZE	Parity/ECC Fault Master Size 000 8-bit access 001 16-bit access 010 32-bit access 011 64-bit access 1xx Reserved
PEFPRT	Parity/ECC Fault Protection <ul style="list-style-type: none"> FATR[3] - Cacheable: 0=Non-cacheable, 1=Cacheable FATR[2] - Bufferable: 0=Non-bufferable, 1=Bufferable FATR[1] - Mode: 0=User mode, 1=Supervisor mode FATR[0] - Type: 0=I-Fetch, 1=Data

10.3.13 LMEM Fault Data High Register (MCM_LMFDHR)

Address: 0h base + 4A0h offset = 4A0h

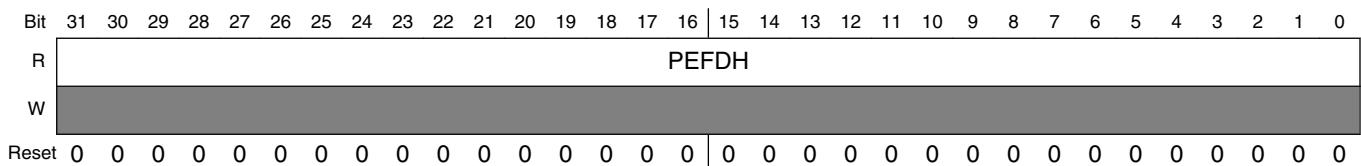

MCM_LMFDHR field descriptions

Field	Description
PEFDH	Parity or ECC Fault Data High

10.3.14 LMEM Fault Data Low Register (MCM_LMFDLR)

Address: 0h base + 4A4h offset = 4A4h

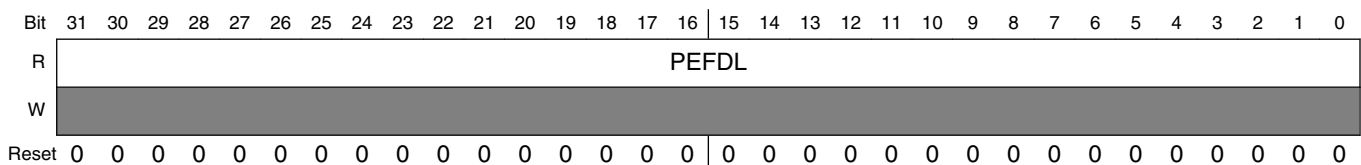

MCM_LMFDLR field descriptions

Field	Description
PEFDL	Parity or ECC Fault Data Low

10.4 Functional description

This section describes the functional description of MCM module.

10.4.1 Interrupts

The MCM interrupt is generated if any of the following is true:

- FPU input denormal interrupt is enabled (FIDCE) and an input is denormalized (FIDC)
- FPU inexact interrupt is enabled (FIXCE) and a number is inexact (FIXC)
- FPU underflow interrupt is enabled (FUFCE) and an underflow occurs (FUFC)
- FPU overflow interrupt is enabled (FOFCE) and an overflow occurs (FOFC)
- FPU divide-by-zero interrupt is enabled (FDZCE) and a divide-by-zero occurs (FDZC)
- FPU invalid operation interrupt is enabled (FIOCE) and an invalid occurs (FIOC)
- SRAM_L correctable (1-bit) ECC error
- SRAM_L uncorrectable ECC error
- SRAM_U correctable (1-bit) ECC error
- SRAM_U uncorrectable ECC error
- PC data parity error
- PC tag parity error
- Cache write buffer error

NOTE

The above interrupt is not applicable for S32K11x variants.

10.4.1.1 Determining source of the interrupt

These steps can be used to determine the exact source of the interrupt:

1. Logical AND the interrupt status flags with the corresponding interrupt enable bits: ISCR[31:16] and ISCR[15:0].
2. Search the result for asserted bits which indicate the exact interrupt sources.

NOTE

ECC and Parity interrupts are determined by LMPECR (interrupt enable) and LMPEIR (interrupt source).

Chapter 11

System Integration Module (SIM)

11.1 Chip-specific SIM information

Some aspects of the SIM vary across the products in the series. See following sections for details.

11.1.1 SIM register/bitfield implementation

Not all register bitfields shown in the SIM memory map are implemented in every S32K1xx and S32K14xW variants. Register/ register bit field availability vary accordingly to the availability of a module/the number of module instances present in a variant. See [Figure 2-3](#) for details on module and instance information. The notes below describes the availability. See following sections for details.

NOTE

- CHIPCTL[PDB_BB_SEL_1] and CHIPCTL[PDB_BB_SEL_2] bit fields at position 22 and 23 respectively are for PDB back to back select. These bit fields are available in S32K14xW variants only.
- MISCTRL0[ECC_EEERAM_STAT] and MISCTRL0[ECC_MGRAM_STAT] bit fields at position 11 and 12 respectively are for ECC double bit fault. These bit fields are available in S32K14xW variants only.
- PLATCGC[CGCGPIO] bit field at position 5 for GPIO Clock Gating Control. This bit is available in S32K11x variants only.
- The read of the SIM registers is affected during EEERAM commands. For more information see note 'During execution of the SetRAM 0xFF' in [Chip-specific FTFC information](#).

11.1.1.1 Chip Control register (CHIPCTL)

11.1.1.1.1 Offset

Register	Offset
CHIPCTL	4h

11.1.1.1.2 Function

SIM_CHIPCTL contains the controls for selecting ADC COCO trigger, trace clock, clock out source, PDB back-to-back mode, and ADC interleave channel.

NOTE

Bits 31:16 are reset on POR.

11.1.1.1.3 Diagram

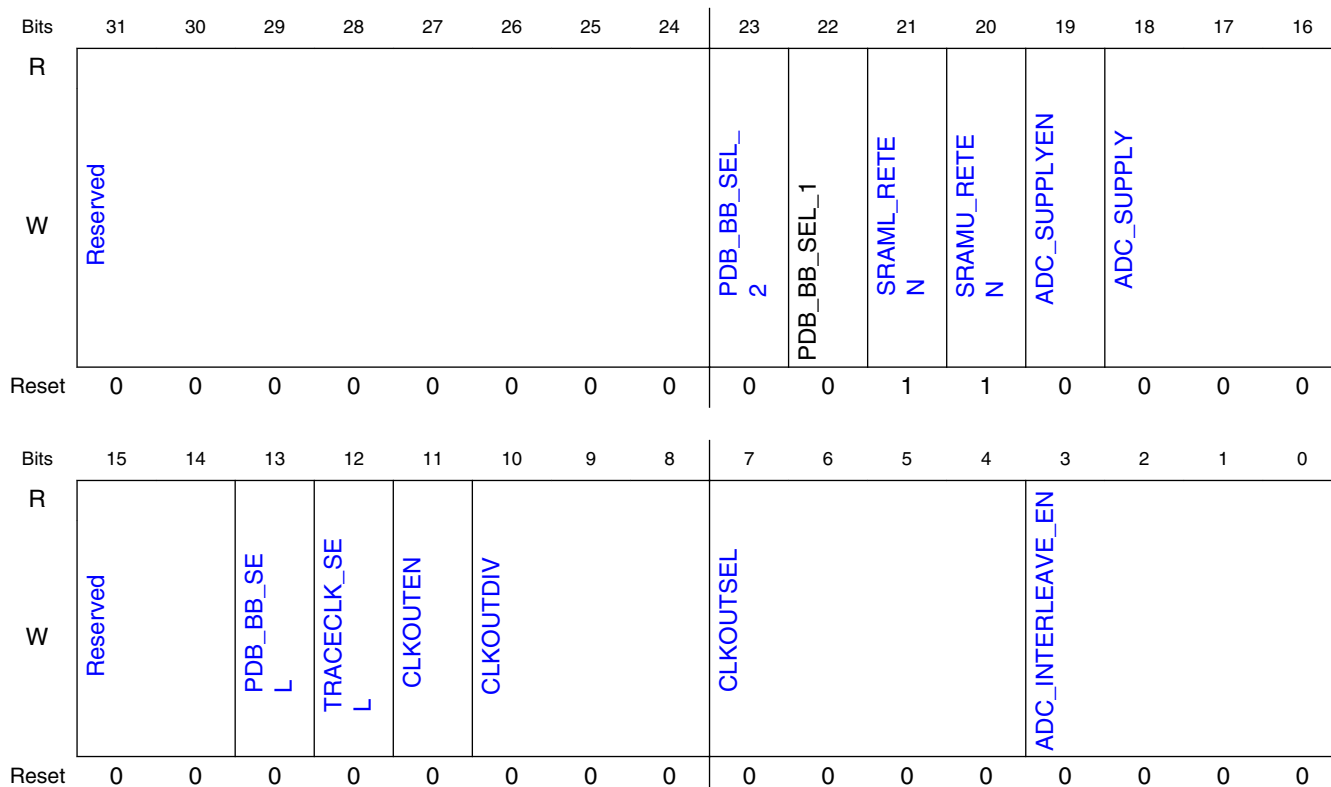

11.1.1.1.4 Fields

Field	Function
31-24 —	Reserved
23 PDB_BB_SEL_2	PDB back-to-back select 2 The PDB back to back select 0, 1 and 2, PDB_BB_SEL[2:0] select ADC COCO source as PDB back-to-back mode, see section Back-to-back acknowledgment connections for details. NOTE: This bit field is only available in S32K14xW variants, and is Reserved and Read-Only Zero for S32K14x and S32K11x variants.
22 PDB_BB_SEL_1	PDB back-to-back select 1 The PDB back to back select 0, 1 and 2, PDB_BB_SEL[2:0] select ADC COCO source as PDB back-to-back mode, see section Back-to-back acknowledgment connections for details. NOTE: This bit field is only available in S32K14xW variants, and is Reserved and Read-Only Zero for S32K14x and S32K11x variants.
21 SRAML_RETEN	SRAML_RETEN SRAML retention NOTE: For S32K11x devices, SRAML refers to MTB RAM. 0b - SRAML contents are retained across resets 1b - No SRAML retention
20 SRAMU_RETE N	SRAMU_RETEN SRAMU retention 0b - SRAMU contents are retained across resets 1b - No SRAMU retention
19 ADC_SUPPLYE N	ADC_SUPPLYEN Enable for internal supply monitoring on ADC0 internal channel 0 (configured by selecting ADC0_SC1n[ADCH] as 010101b). 0b - Disable internal supply monitoring 1b - Enable internal supply monitoring
18-16 ADC_SUPPLY	ADC_SUPPLY Internal supplies monitored on ADC0 internal channel 0 (configured by selecting ADC0_SC1n[ADCH] as 010101b) 000b - 5 V input VDD supply (VDD) 001b - 5 V input analog supply (VDDA) 010b - ADC Reference Supply (VREFH) 011b - 3.3 V Oscillator Regulator Output (VDD_3V) 100b - 3.3 V flash regulator output (VDD_flash_3V) 101b - 1.2 V core regulator output (VDD_LV) 110b - Reserved 111b - Reserved
15-14 —	Reserved
13 PDB_BB_SEL	PDB back-to-back select Selects ADC COCO source as PDB back-to-back mode, see section Back-to-back acknowledgment connections for details. NOTE: This bit field is only available in S32K14x/S32K14xW variants, and is Reserved and Read-Only Zero for S32K11x variants.

Table continues on the next page...

Chip-specific SIM information

Field	Function
	0b - PDB0 channel 0 back-to-back operation with ADC0 COCO[7:0] and PDB1 channel 0 back-to-back operation with ADC1 COCO[7:0] 1b - Channel 0 of PDB0 and PDB1 back-to-back operation with COCO[7:0] of ADC0 and ADC1.
12 TRACECLK_SE L	Debug trace clock select Selects core clock or platform clock as the trace clock source. NOTE: This bit field is only available in S32K14x/S32K14xW variants, and is Reserved and Read-Only Zero for S32K11x variants. 0b - Core clock 1b - Reserved
11 CLKOUTEN	CLKOUT enable NOTE: The below sequence should be followed while CLKOUT configuration: <ol style="list-style-type: none"> 1. Configure SIM_CHIPCTL[CLKOUTSEL] 2. Configure SIM_CHIPCTL[CLKOUTDIV] 3. Enable SIM_CHIPCTL[CLKOUTEN] (While switching, CLKOUTEN should be first cleared and then the above sequence should be followed) 0b - Clockout disable 1b - Clockout enable
10-8 CLKOUTDIV	CLKOUT Divide Ratio NOTE: The below sequence should be followed while CLKOUT configuration: <ol style="list-style-type: none"> 1. Configure SIM_CHIPCTL[CLKOUTSEL] 2. Configure SIM_CHIPCTL[CLKOUTDIV] 3. Enable SIM_CHIPCTL[CLKOUTEN] (While switching, CLKOUTEN should be first cleared and then the above sequence should be followed) 000b - Divide by 1 001b - Divide by 2 010b - Divide by 3 011b - Divide by 4 100b - Divide by 5 101b - Divide by 6 110b - Divide by 7 111b - Divide by 8
7-4 CLKOUTSEL	CLKOUT Select NOTE: The below sequence should be followed while CLKOUT configuration: <ol style="list-style-type: none"> 1. Configure SIM_CHIPCTL[CLKOUTSEL] 2. Configure SIM_CHIPCTL[CLKOUTDIV] 3. Enable SIM_CHIPCTL[CLKOUTEN] (While switching, CLKOUTEN should be first cleared and then the above sequence should be followed) NOTE: For QuadSPI clocks, see QuadSPI clocking diagram in table 'Peripheral module clocking' Selects the clock to output on the CLKOUT pin. 0000b - SCG CLKOUT 0001b - Reserved 0010b - SOSC DIV2 CLK 0011b - Reserved 0100b - SIRC DIV2 CLK 0101b - For S32K148: QSPI_SFIF_CLK_HYP_PREMUX: Divide by 2 clock (configured through SCLKCONFIG[5]) for HyperRAM going to sfif clock to QSPI; For others: Reserved 0110b - FIRC DIV2 CLK

Table continues on the next page...

Field	Function
	0111b - HCLK 1000b - For S32K14x: SPLL DIV2 CLK For S32K11x: Reserved 1001b - BUS_CLK 1010b - LPO128K_CLK 1011b - For S32K148: QSPI_Module clock; For others: Reserved 1100b - LPO_CLK as selected by SIM_LPOCLKS[LPOCLKSEL] 1101b - For S32K148: QSPI_SFIF_CLK; For others: Reserved 1110b - RTC_CLK as selected by SIM_LPOCLKS[RTCCLKSEL] 1111b - For S32K148: QSPI_2xSFIF_CLK; For others: Reserved
3-0 ADC_INTERLEAVE_EN	ADC interleave channel enable Select ADC interleave pins. See section ADC Hardware Interleaved Channels for more information. NOTE: This bit field is only available in S32K14x/S32K14xW variants, and is Reserved and Read-Only Zero for S32K11x variants. 0000b - Interleaving disabled. No channel pair interleaved. Interleaved channels are individually connected to pins. PTC0 is connected to ADC0_SE8. PTC1 is connected to ADC0_SE9. PTB15 is connected to ADC1_SE14. PTB16 is connected to ADC1_SE15. PTB0 is connected to ADC0_SE4. PTB1 is connected to ADC0_SE5. PTB13 is connected to ADC1_SE8. PTB14 is connected to ADC1_SE9. 1xxb - PTB14 to ADC1_SE9 and ADC0_SE9 x1xb - PTB13 to ADC1_SE8 and ADC0_SE8 xx1b - PTB1 to ADC0_SE5 and ADC1_SE15 xxx1b - PTB0 to ADC0_SE4 and ADC1_SE14

11.1.1.2 Miscellaneous control register 0 (MISCTRL0)

11.1.1.2.1 Offset

Register	Offset
MISCTRL0	20h

11.1.1.2.2 Diagram

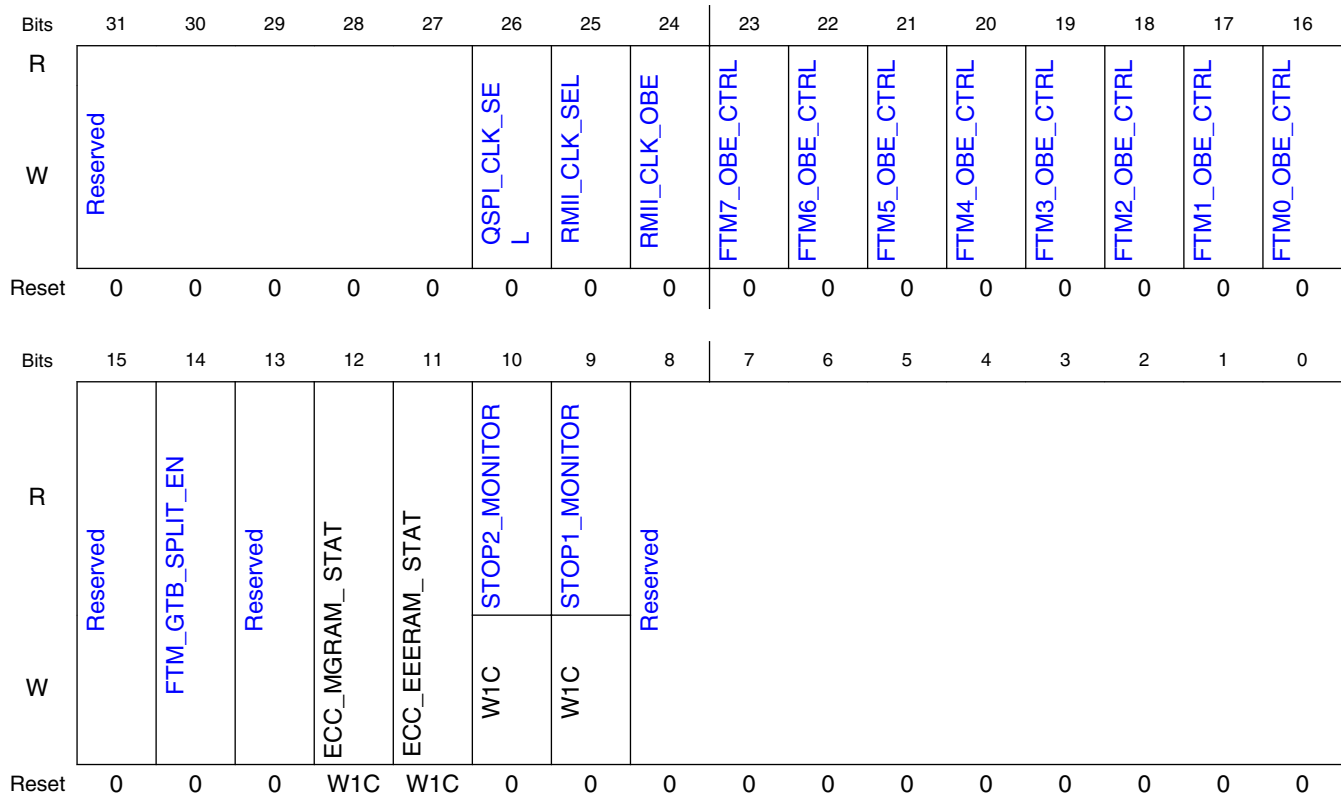

11.1.1.2.3 Fields

Field	Function
31-27 —	Reserved
26 QSPI_CLK_SEL	QSPI CLK Select bit QSPI asynchronous clock gating enable 0b - QuadSPI internal reference clock is gated. 1b - QuadSPI internal reference clock is enabled.
25 RMII_CLK_SEL	RMII CLK Select bit Set this bit to enable SOSCDIV1_CLK as ENET RMII clock in Internal loopback mode.
24 RMII_CLK_OBE	RMII CLK OBE bit Output Buffer Enable for ENET RMII clock in internal loopback mode
23 FTM7_OBE_CTRL	FTM7 OBE CTRL bit 0b - The FTM channel output is put to safe state when the FTM counter is enabled and the FTM channel output is enabled by Fault Control (FTM_MODE[FAULTM] != 2'b00 and FTM_FLTCTRL[FSTATE] = 1'b0) and PWM is enabled (FTM_SC[PWMENn] = 1'b1). Otherwise the channel output is tristated. 1b - The FTM channel output state is retained when the channel is in output mode. The output channel is tristated when the channel is in input capture [DECAPEN=1'b0, COMBINE=1'b0, MSnB:MSnA=2'b00] or dual edge capture mode [DECAPEN=1'b1].

Table continues on the next page...

Field	Function
22 FTM6_OBE_CTRL	FTM6 OBE CTRL bit 0b - The FTM channel output is put to safe state when the FTM counter is enabled and the FTM channel output is enabled by Fault Control (FTM_MODE[FAULTM]! \neq 2'b00 and FTM_FLTCTRL[FSTATE]=1'b0) and PWM is enabled (FTM_SC[PWMENn] = 1'b1). Otherwise the channel output is tristated. 1b - The FTM channel output state is retained when the channel is in output mode. The output channel is tristated when the channel is in input capture [DECAPEN=1'b0, COMBINE=1'b0, MSnB:MSnA=2'b00] or dual edge capture mode [DECAPEN=1'b1].
21 FTM5_OBE_CTRL	FTM5 OBE CTRL bit 0b - The FTM channel output is put to safe state when the FTM counter is enabled and the FTM channel output is enabled by Fault Control (FTM_MODE[FAULTM]! \neq 2'b00 and FTM_FLTCTRL[FSTATE]=1'b0) and PWM is enabled (FTM_SC[PWMENn] = 1'b1). Otherwise the channel output is tristated. 1b - The FTM channel output state is retained when the channel is in output mode. The output channel is tristated when the channel is in input capture [DECAPEN=1'b0, COMBINE=1'b0, MSnB:MSnA=2'b00] or dual edge capture mode [DECAPEN=1'b1].
20 FTM4_OBE_CTRL	FTM4 OBE CTRL bit 0b - The FTM channel output is put to safe state when the FTM counter is enabled and the FTM channel output is enabled by Fault Control (FTM_MODE[FAULTM]! \neq 2'b00 and FTM_FLTCTRL[FSTATE]=1'b0) and PWM is enabled (FTM_SC[PWMENn] = 1'b1). Otherwise the channel output is tristated. 1b - The FTM channel output state is retained when the channel is in output mode. The output channel is tristated when the channel is in input capture [DECAPEN=1'b0, COMBINE=1'b0, MSnB:MSnA=2'b00] or dual edge capture mode [DECAPEN=1'b1].
19 FTM3_OBE_CTRL	FTM3 OBE CTRL bit 0b - The FTM channel output is put to safe state when the FTM counter is enabled and the FTM channel output is enabled by Fault Control (FTM_MODE[FAULTM]! \neq 2'b00 and FTM_FLTCTRL[FSTATE]=1'b0) and PWM is enabled (FTM_SC[PWMENn] = 1'b1). Otherwise the channel output is tristated. 1b - The FTM channel output state is retained when the channel is in output mode. The output channel is tristated when the channel is in input capture [DECAPEN=1'b0, COMBINE=1'b0, MSnB:MSnA=2'b00] or dual edge capture mode [DECAPEN=1'b1].
18 FTM2_OBE_CTRL	FTM2 OBE CTRL bit 0b - The FTM channel output is put to safe state when the FTM counter is enabled and the FTM channel output is enabled by Fault Control (FTM_MODE[FAULTM]! \neq 2'b00 and FTM_FLTCTRL[FSTATE]=1'b0) and PWM is enabled (FTM_SC[PWMENn] = 1'b1). Otherwise the channel output is tristated. 1b - The FTM channel output state is retained when the channel is in output mode. The output channel is tristated when the channel is in input capture [DECAPEN=1'b0, COMBINE=1'b0, MSnB:MSnA=2'b00] or dual edge capture mode [DECAPEN=1'b1].
17 FTM1_OBE_CTRL	FTM1 OBE CTRL bit 0b - The FTM channel output is put to safe state when the FTM counter is enabled and the FTM channel output is enabled by Fault Control (FTM_MODE[FAULTM]! \neq 2'b00 and FTM_FLTCTRL[FSTATE]=1'b0) and PWM is enabled (FTM_SC[PWMENn] = 1'b1). Otherwise the channel output is tristated. 1b - The FTM channel output state is retained when the channel is in output mode. The output channel is tristated when the channel is in input capture [DECAPEN=1'b0, COMBINE=1'b0, MSnB:MSnA=2'b00] or dual edge capture mode [DECAPEN=1'b1].
16 FTM0_OBE_CTRL	FTM0 OBE CTRL bit 0b - The FTM channel output is put to safe state when the FTM counter is enabled and the FTM channel output is enabled by Fault Control (FTM_MODE[FAULTM]! \neq 2'b00 and FTM_FLTCTRL[FSTATE]=1'b0) and PWM is enabled (FTM_SC[PWMENn] = 1'b1). Otherwise the channel output is tristated.

Table continues on the next page...

Chip-specific SIM information

Field	Function
	1b - The FTM channel output state is retained when the channel is in output mode. The output channel is tristated when the channel is in input capture [DECAPEN=1'b0, COMBINE=1'b0, MSnB:MSnA=2'b00] or dual edge capture mode [DECAPEN=1'b1].
15 —	Reserved
14 FTM_GTB_SPLIT_EN	FTM GTB split enable/disable bit Split time base enable/disable. 0b - All the FTMs have a single global time-base 1b - FTM0-3 have a common time-base and others have a different common time-base. Please refer 'FTM global time base' in FTM chapter for implementation details.
13 —	Reserved
12 ECC_MGRAM_STAT	ECC_MGRAM_STAT ECC double-bit fault detected during flash internal access to Flash firmware or Internal scratch RAM (This is an internal RAM, accessible only within flash and not by any master). This bit retains the status across functional reset to identify if ECC double-bit fault causes a reset while device reset sequence. NOTE: This bit is reset on POR.
11 ECC_EEERAM_STAT	ECC_EEERAM_STAT ECC double-bit fault detected during flash internal access to FlexRAM or PRAM This bit retains the status across functional reset to identify if ECC double-bit fault causes a reset while device reset sequence. NOTE: <ul style="list-style-type: none"> This bit is reset on POR. This bit field is only available in S32K14xW variants, and is Reserved and Read-Only Zero for S32K1xx variants.
10 STOP2_MONITOR	STOP2 monitor bit This status bit monitors system clock status on STOP2 mode entry and can be used for monitoring whether STOP2 entry was successful or aborted (In STOP2, system clock is disabled and bus clock is enabled). This bit needs to be W1C after wakeup from STOP2 mode. NOTE: This bit is reset on POR. 0b - System clock enabled or STOP2 entry aborted 1b - STOP2 entry successful
9 STOP1_MONITOR	STOP1 monitor bit This status bit monitors bus clock status on STOP1 mode entry and can be used for monitoring whether STOP1 entry was successful or aborted (In STOP1, both system and bus clocks are disabled). This bit needs to be W1C after wakeup from STOP1 mode. NOTE: This bit is reset on POR. 0b - Bus clock enabled or STOP1 entry aborted 1b - STOP1 entry successful
8-0 —	Reserved

11.1.1.3 Platform Clock Gating Control Register (PLATCGC)

11.1.1.3.1 Offset

Register	Offset
PLATCGC	40h

11.1.1.3.2 Diagram

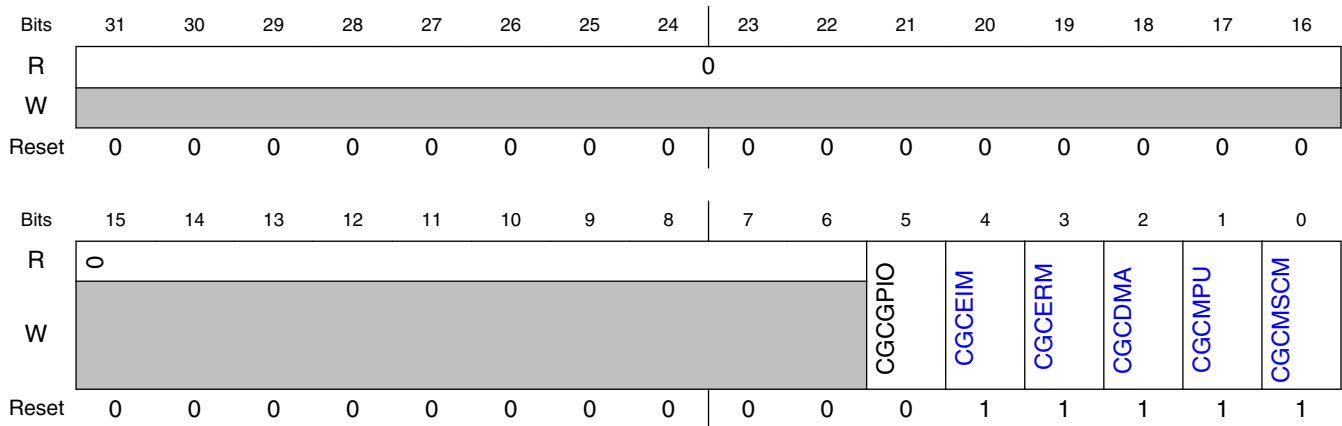

11.1.1.3.3 Fields

Field	Function
31-6 —	Reserved
5 CGCGPIO	EIM Clock Gating Control Controls the clock gating to the GPIO. 0b - Clock disabled 1b - Clock enabled NOTE: This bit field is only available in S32K11x variants, and is Reserved and Read-Only Zero for S32K14x and S32K14xW variants.
4 CGCEIM	EIM Clock Gating Control Controls the clock gating to the EIM. 0b - Clock disabled 1b - Clock enabled
3 CGCERM	ERM Clock Gating Control Controls the clock gating to the ERM. 0b - Clock disabled 1b - Clock enabled

Table continues on the next page...

Introduction

Field	Function
2 CGCDMA	DMA Clock Gating Control Controls the clock gating to the DMA module. 0b - Clock disabled 1b - Clock enabled
1 CGCMPU	MPU Clock Gating Control Controls the clock gating to the MPU module. 0b - Clock disabled 1b - Clock enabled
0 CGCMSCM	MSCM Clock Gating Control Controls the clock gating to the MSCM. 0b - Clock disabled 1b - Clock enabled

11.2 Introduction

The System Integration Module (SIM) provides system control and chip configuration registers.

11.2.1 Features

Features of the SIM include:

- System clocking configuration
- Flash memory and system RAM size configuration
- FlexTimer clock channel and configuration
- ADC trigger selection
- LPO clock source selection
- ENET clock control
- Flash memory configuration
- System device identification (ID)

11.3 Memory map and register definition

The SIM contains many fields for selecting the clock source and dividers for various module clocks. See section: Clock Distribution chapter for more information, including block diagrams and clock definitions.

NOTE

The SIM registers can only be written in supervisor mode. In user mode, write accesses are blocked and will result in a bus error.

NOTE

Writing to Read-Only registers may /may not generate Transfer error.

11.3.1 SIM register descriptions

11.3.1.1 SIM memory map

SIM base address: 4004_8000h

Offset	Register	Width (In bits)	Access	Reset value
4h	Chip Control register (CHIPCTL)	32	RW	0030_0000h
Ch	FTM Option Register 0 (FTMOPT0)	32	RW	0000_0000h
10h	LPO Clock Select Register (LPOCLKS)	32	RW	0000_0003h
18h	ADC Options Register (ADCOPT)	32	RW	0000_0000h
1Ch	FTM Option Register 1 (FTMOPT1)	32	RW	0000_0000h
20h	Miscellaneous control register 0 (MISCTRL0)	32	RW	0000_0000h
24h	System Device Identification Register (SDID)	32	RO	Table 11-
40h	Platform Clock Gating Control Register (PLATCGC)	32	RW	0000_001Fh
4Ch	Flash Configuration Register 1 (FCFG1)	32	RW	Table 11-
54h	Unique Identification Register High (UIDH)	32	RO	Table 11-
58h	Unique Identification Register Mid-High (UIDMH)	32	RO	Table 11-
5Ch	Unique Identification Register Mid Low (UIDML)	32	RO	Table 11-
60h	Unique Identification Register Low (UIDL)	32	RO	Table 11-
68h	System Clock Divider Register 4 (CLKDIV4)	32	RW	1000_0000h
6Ch	Miscellaneous Control register 1 (MISCTRL1)	32	RW	0000_0000h

11.3.1.2 Chip Control register (CHIPCTL)

11.3.1.2.1 Offset

Register	Offset
CHIPCTL	4h

11.3.1.2.2 Function

SIM_CHIPCTL contains the controls for selecting ADC COCO trigger, trace clock, clock out source, PDB back-to-back mode, and ADC interleave channel.

NOTE

Bits 31:16 are reset on POR.

11.3.1.2.3 Diagram

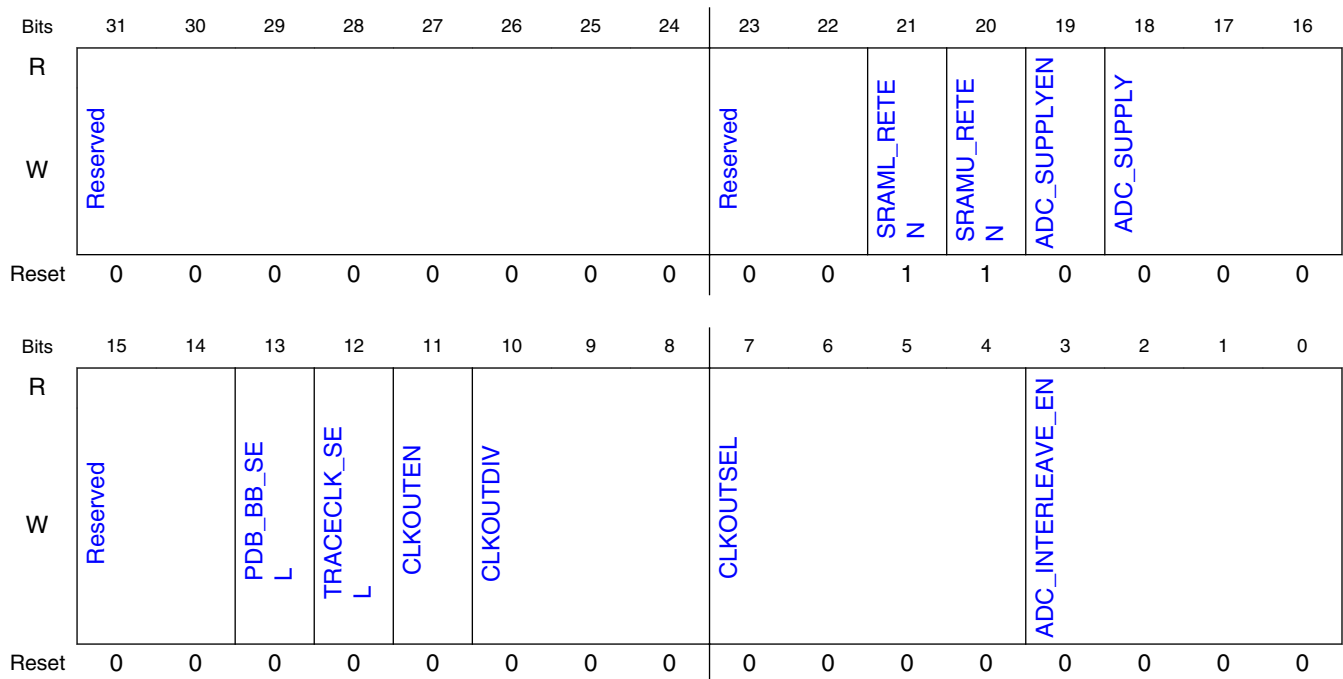

11.3.1.2.4 Fields

Field	Function
31-24 —	Reserved
23-22 —	Reserved

Table continues on the next page...

Field	Function
21 SRAML_RETEN	SRAML_RETEN SRAML retention NOTE: For S32K11x devices, SRAML refers to MTB RAM. 0b - SRAML contents are retained across resets 1b - No SRAML retention
20 SRAMU_RETE N	SRAMU_RETEN SRAMU retention 0b - SRAMU contents are retained across resets 1b - No SRAMU retention
19 ADC_SUPPLYE N	ADC_SUPPLYEN Enable for internal supply monitoring on ADC0 internal channel 0 (configured by selecting ADC0_SC1n[ADCH] as 010101b). 0b - Disable internal supply monitoring 1b - Enable internal supply monitoring
18-16 ADC_SUPPLY	ADC_SUPPLY Internal supplies monitored on ADC0 internal channel 0 (configured by selecting ADC0_SC1n[ADCH] as 010101b) 000b - 5 V input VDD supply (VDD) 001b - 5 V input analog supply (VDDA) 010b - ADC Reference Supply (VREFH) 011b - 3.3 V Oscillator Regulator Output (VDD_3V) 100b - 3.3 V flash regulator output (VDD_flash_3V) 101b - 1.2 V core regulator output (VDD_LV) 110b - Reserved 111b - Reserved
15-14 —	Reserved
13 PDB_BB_SEL	PDB back-to-back select Selects ADC COCO source as PDB back-to-back mode, see section Back-to-back acknowledgment connections for details. NOTE: This bit field is only available in S32K14x/S32K14xW variants, and is Reserved and Read-Only Zero for S32K11x variants. 0b - PDB0 channel 0 back-to-back operation with ADC0 COCO[7:0] and PDB1 channel 0 back-to-back operation with ADC1 COCO[7:0] 1b - Channel 0 of PDB0 and PDB1 back-to-back operation with COCO[7:0] of ADC0 and ADC1.
12 TRACECLK_SE L	Debug trace clock select Selects core clock or platform clock as the trace clock source. NOTE: This bit field is only available in S32K14x/S32K14xW variants, and is Reserved and Read-Only Zero for S32K11x variants. 0b - Core clock 1b - Reserved
11 CLKOUTEN	CLKOUT enable NOTE: The below sequence should be followed while CLKOUT configuration: 1. Configure SIM_CHIPCTL[CLKOUTSEL] 2. Configure SIM_CHIPCTL[CLKOUTDIV] 3. Enable SIM_CHIPCTL[CLKOUTEN]

Table continues on the next page...

Memory map and register definition

Field	Function
	<p>(While switching, CLKOUTEN should be first cleared and then the above sequence should be followed)</p> <p>0b - Clockout disable 1b - Clockout enable</p>
10-8 CLKOUTDIV	<p>CLKOUT Divide Ratio</p> <p>NOTE: The below sequence should be followed while CLKOUT configuration:</p> <ol style="list-style-type: none"> 1. Configure SIM_CHIPCTL[CLKOUTSEL] 2. Configure SIM_CHIPCTL[CLKOUTDIV] 3. Enable SIM_CHIPCTL[CLKOUTEN] <p>(While switching, CLKOUTEN should be first cleared and then the above sequence should be followed)</p> <p>000b - Divide by 1 001b - Divide by 2 010b - Divide by 3 011b - Divide by 4 100b - Divide by 5 101b - Divide by 6 110b - Divide by 7 111b - Divide by 8</p>
7-4 CLKOUTSEL	<p>CLKOUT Select</p> <p>NOTE: The below sequence should be followed while CLKOUT configuration:</p> <ol style="list-style-type: none"> 1. Configure SIM_CHIPCTL[CLKOUTSEL] 2. Configure SIM_CHIPCTL[CLKOUTDIV] 3. Enable SIM_CHIPCTL[CLKOUTEN] <p>(While switching, CLKOUTEN should be first cleared and then the above sequence should be followed)</p> <p>NOTE: For QuadSPI clocks, see QuadSPI clocking diagram in table 'Peripheral module clocking'</p> <p>Selects the clock to output on the CLKOUT pin.</p> <p>0000b - SCG CLKOUT 0001b - Reserved 0010b - SOSC DIV2 CLK 0011b - Reserved 0100b - SIRC DIV2 CLK 0101b - For S32K148: QSPI_SFIF_CLK_HYP_PREMUX: Divide by 2 clock (configured through SCLKCONFIG[5]) for HyperRAM going to sfif clock to QSPI; For others: Reserved 0110b - FIRC DIV2 CLK 0111b - HCLK 1000b - For S32K14x: SPLL DIV2 CLK For S32K11x: Reserved 1001b - BUS_CLK 1010b - LPO128K_CLK 1011b - For S32K148: QSPI_Module clock; For others: Reserved 1100b - LPO_CLK as selected by SIM_LPOCLKS[LPOCLKSEL] 1101b - For S32K148: QSPI_SFIF_CLK; For others: Reserved 1110b - RTC_CLK as selected by SIM_LPOCLKS[RTCCLKSEL] 1111b - For S32K148: QSPI_2xSFIF_CLK; For others: Reserved</p>
3-0 ADC_INTERLEAVE_EN	<p>ADC interleave channel enable</p> <p>Select ADC interleave pins. See section ADC Hardware Interleaved Channels for more information.</p> <p>NOTE: This bit field is only available in S32K14x/S32K14xW variants, and is Reserved and Read-Only Zero for S32K11x variants.</p> <p>0000b - Interleaving disabled. No channel pair interleaved. Interleaved channels are individually connected to pins. PTC0 is connected to ADC0_SE8. PTC1 is connected to ADC0_SE9. PTB15 is connected to ADC1_SE14. PTB16 is connected to ADC1_SE15. PTB0 is connected to ADC0_SE4.</p>

Field	Function
	PTB1 is connected to ADC0_SE5. PTB13 is connected to ADC1_SE8. PTB14 is connected to ADC1_SE9. 1xxxb - PTB14 to ADC1_SE9 and ADC0_SE9 x1xxb - PTB13 to ADC1_SE8 and ADC0_SE8 xx1xb - PTB1 to ADC0_SE5 and ADC1_SE15 xxx1b - PTB0 to ADC0_SE4 and ADC1_SE14

11.3.1.3 FTM Option Register 0 (FTMOPT0)

11.3.1.3.1 Offset

Register	Offset
FTMOPT0	Ch

11.3.1.3.2 Diagram

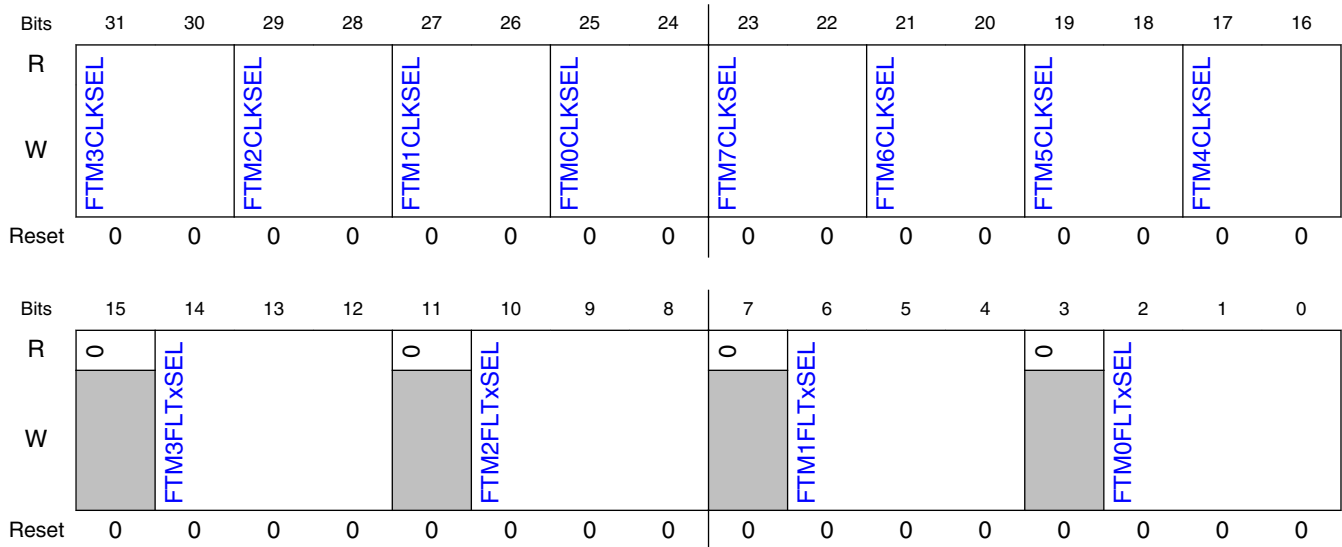

11.3.1.3.3 Fields

Field	Function
31-30 FTM3CLKSEL	FTM3 External Clock Pin Select Selects the external pin used to drive the FTM3 module clock. NOTE: The selected pin must also be configured for the FTM3 external clock function through the appropriate Pin Control Register in the Port Control module.

Table continues on the next page...

Memory map and register definition

Field	Function
	00b - FTM3 external clock driven by TCLK0 pin. 01b - FTM3 external clock driven by TCLK1 pin. 10b - FTM3 external clock driven by TCLK2 pin. 11b - No clock input
29-28 FTM2CLKSEL	FTM2 External Clock Pin Select Selects the external pin used to drive the FTM2 module clock. NOTE: The selected pin must also be configured for the FTM2 external clock function through the appropriate Pin Control Register in the Port Control module. 00b - FTM2 external clock driven by TCLK0 pin. 01b - FTM2 external clock driven by TCLK1 pin. 10b - FTM2 external clock driven by TCLK2 pin. 11b - No clock input
27-26 FTM1CLKSEL	FTM1 External Clock Pin Select Selects the external pin used to drive the FTM1 module clock. NOTE: The selected pin must also be configured for the FTM1 external clock function through the appropriate Pin Control Register in the Port Control module. 00b - FTM1 external clock driven by TCLK0 pin. 01b - FTM1 external clock driven by TCLK1 pin. 10b - FTM1 external clock driven by TCLK2 pin. 11b - No clock input
25-24 FTM0CLKSEL	FTM0 External Clock Pin Select Selects the external pin used to drive the FTM0 module clock. NOTE: The selected pin must also be configured for the FTM0 external clock function through the appropriate Pin Control Register in the Port Control module. 00b - FTM0 external clock driven by TCLK0 pin. 01b - FTM0 external clock driven by TCLK1 pin. 10b - FTM0 external clock driven by TCLK2 pin. 11b - No clock input
23-22 FTM7CLKSEL	FTM7 External Clock Pin Select Selects the external pin used to drive the FTM7 module clock. NOTE: The selected pin must also be configured for the FTM7 external clock function through the appropriate Pin Control Register in the Port Control module. 00b - FTM7 external clock driven by TCLK0 pin. 01b - FTM7 external clock driven by TCLK1 pin. 10b - FTM7 external clock driven by TCLK2 pin. 11b - No clock input
21-20 FTM6CLKSEL	FTM6 External Clock Pin Select Selects the external pin used to drive the FTM6 module clock. NOTE: The selected pin must also be configured for the FTM6 external clock function through the appropriate Pin Control Register in the Port Control module. 00b - FTM6 external clock driven by TCLK0 pin. 01b - FTM6 external clock driven by TCLK1 pin. 10b - FTM6 external clock driven by TCLK2 pin. 11b - No clock input
19-18 FTM5CLKSEL	FTM5 External Clock Pin Select Selects the external pin used to drive the FTM5 module clock.

Table continues on the next page...

Field	Function
	<p>NOTE: The selected pin must also be configured for the FTM5 external clock function through the appropriate Pin Control Register in the Port Control module.</p> <p>00b - FTM5 external clock driven by TCLK0 pin. 01b - FTM5 external clock driven by TCLK1 pin. 10b - FTM5 external clock driven by TCLK2 pin. 11b - No clock input</p>
17-16 FTM4CLKSEL	<p>FTM4 External Clock Pin Select</p> <p>Selects the external pin used to drive the FTM4 module clock.</p> <p>NOTE: The selected pin must also be configured for the FTM4 external clock function through the appropriate Pin Control Register in the Port Control module.</p> <p>00b - FTM4 external clock driven by TCLK0 pin. 01b - FTM4 external clock driven by TCLK1 pin. 10b - FTM4 external clock driven by TCLK2 pin. 11b - No clock input</p>
15 —	Reserved
14-12 FTM3FLT _x SEL	<p>FTM3 Fault X Select</p> <p>Selects the source of the FTM3 fault. Every bit means one fault input, respectively.</p> <p>NOTE: The pin source of the fault must be configured for FTM3 fault function through the appropriate PORT_PCR_n field when the fault comes from an external pin. TRGMUX_FTM3 SEL_x corresponds to the FTM3 Fault x input.</p> <p>000b - FTM3_FLT_x pin 001b - TRGMUX_FTM3 out</p>
11 —	Reserved
10-8 FTM2FLT _x SEL	<p>FTM2 Fault X Select</p> <p>Selects the source of the FTM2 fault. Every bit means one fault input, respectively.</p> <p>NOTE: The pin source of the fault must be configured for FTM2 fault function through the appropriate PORT_PCR_n field when the fault comes from an external pin. TRGMUX_FTM2 SEL_x corresponds to the FTM2 Fault x input.</p> <p>000b - FTM2_FLT_x pin 001b - TRGMUX_FTM2 out</p>
7 —	Reserved
6-4 FTM1FLT _x SEL	<p>FTM1 Fault X Select</p> <p>Selects the source of the FTM1 fault. Every bit means one fault input, respectively.</p> <p>NOTE: The pin source of the fault must be configured for FTM1 fault function through the appropriate PORT_PCR_n field when the fault comes from an external pin. TRGMUX_FTM1 SEL_x corresponds to the FTM1 Fault x input.</p> <p>000b - FTM1_FLT_x pin 001b - TRGMUX_FTM1 out</p>
3 —	Reserved
2-0 FTM0FLT _x SEL	<p>FTM0 Fault X Select</p> <p>Selects the source of the FTM0 fault. Every bit means one fault input, respectively.</p>

Memory map and register definition

Field	Function
	<p>NOTE: The pin source of the fault must be configured for FTM0 fault function through the appropriate PORT_PCRn field when the fault comes from an external pin. TRGMUX_FTM0 SELx corresponds to the FTM0 Fault x input.</p> <p>000b - FTM0_FLTx pin 001b - TRGMUX_FTM0 out</p>

11.3.1.4 LPO Clock Select Register (LPOCLKS)

11.3.1.4.1 Offset

Register	Offset
LPOCLKS	10h

11.3.1.4.2 Function

NOTE

The LPOCLKS register is a write-once register, and is reset only on POR or LVD.

11.3.1.4.3 Diagram

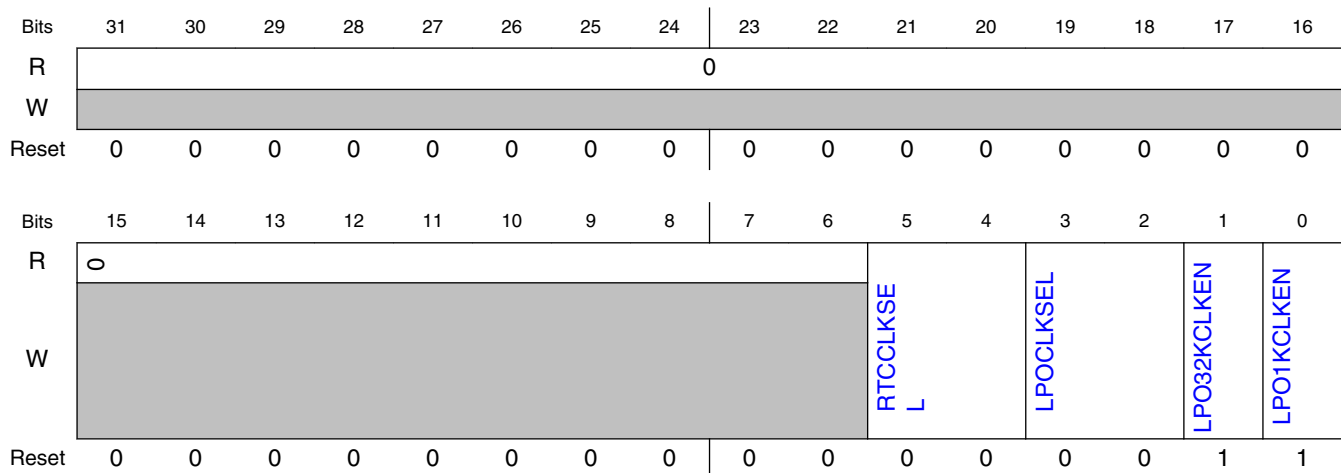

11.3.1.4.4 Fields

Field	Function
31-6 —	Reserved
5-4 RTCCLKSEL	32 kHz clock source select Selects 32 kHz clock source for peripherals 00b - SOSCDIV1_CLK 01b - 32 kHz LPO_CLK 10b - 32 kHz RTC_CLKIN clock 11b - FIRCDIV1_CLK
3-2 LPOCLKSEL	LPO clock source select Selects LPO clock source for peripherals 00b - 128 kHz LPO_CLK 01b - No clock 10b - 32 kHz LPO_CLK which is derived from the 128 kHz LPO_CLK 11b - 1 kHz LPO_CLK which is derived from the 128 kHz LPO_CLK
1 LPO32KCLKEN	32 kHz LPO_CLK enable 0b - Disable 32 kHz LPO_CLK output 1b - Enable 32 kHz LPO_CLK output
0 LPO1KCLKEN	1 kHz LPO_CLK enable 0b - Disable 1 kHz LPO_CLK output 1b - Enable 1 kHz LPO_CLK output

11.3.1.5 ADC Options Register (ADCOPT)

11.3.1.5.1 Offset

Register	Offset
ADCOPT	18h

11.3.1.5.2 Diagram

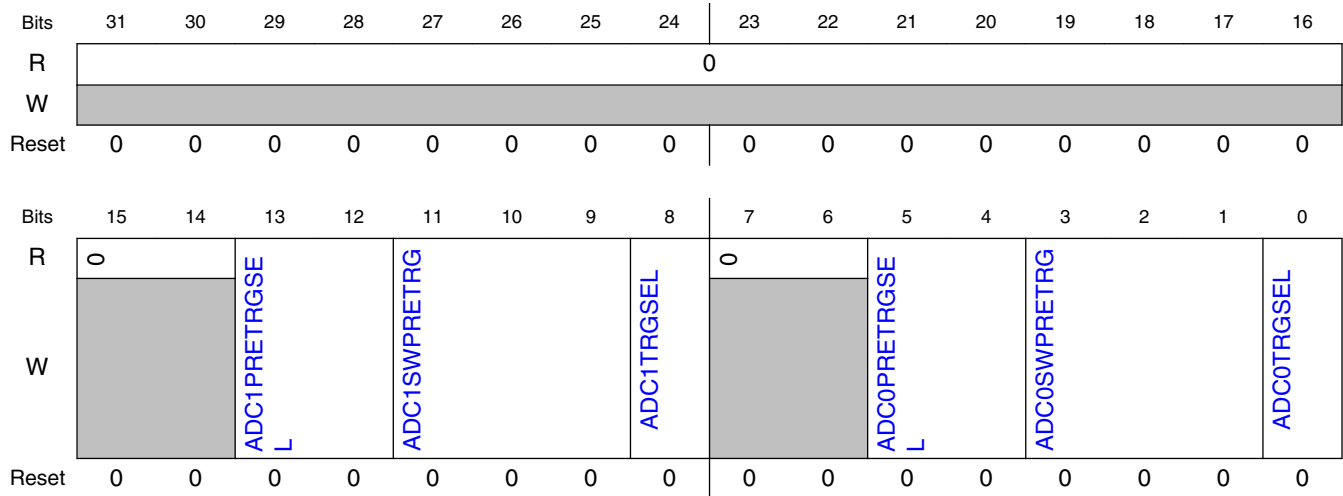

11.3.1.5.3 Fields

Field	Function
31-16 —	Reserved
15-14 —	Reserved
13-12 ADC1PRETRGSEL	ADC1 pretrigger source select Selects pretrigger source for ADC1. 00b - PDB pretrigger (default) 01b - TRGMUX pretrigger 10b - Software pretrigger 11b - Reserved
11-9 ADC1SWPRETRG	ADC1 software pretrigger sources 000b - Software pretrigger disabled 001b - Reserved (do not use) 010b - Reserved (do not use) 011b - Reserved (do not use) 100b - Software pretrigger 0 101b - Software pretrigger 1 110b - Software pretrigger 2 111b - Software pretrigger 3
8 ADC1TRGSEL	ADC1 trigger source select Selects trigger source for ADC1. NOTE: Each PDB supports two ADC channels, and each channel has 8 pretriggers. If needed, the trigger of two ADC channels are OR'ed together to support up to 16 pretriggers. 0b - PDB output 1b - TRGMUX output
7-6 —	Reserved

Table continues on the next page...

Field	Function
5-4 ADC0PRETRG SEL	ADC0 pretrigger source select Selects pretrigger source for ADC0. 00b - PDB pretrigger (default) 01b - TRGMUX pretrigger 10b - Software pretrigger 11b - Reserved
3-1 ADC0SWPRET RG	ADC0 software pretrigger sources 000b - Software pretrigger disabled 001b - Reserved (do not use) 010b - Reserved (do not use) 011b - Reserved (do not use) 100b - Software pretrigger 0 101b - Software pretrigger 1 110b - Software pretrigger 2 111b - Software pretrigger 3
0 ADC0TRGSEL	ADC0 trigger source select Selects trigger source for ADC0. NOTE: Each PDB supports two ADC channels, and each channel has 8 pretriggers. If needed, the trigger of two ADC channels are OR'ed together to support up to 16 pretriggers. 0b - PDB output 1b - TRGMUX output

11.3.1.6 FTM Option Register 1 (FTMOPT1)

11.3.1.6.1 Offset

Register	Offset
FTMOPT1	1Ch

11.3.1.6.2 Diagram

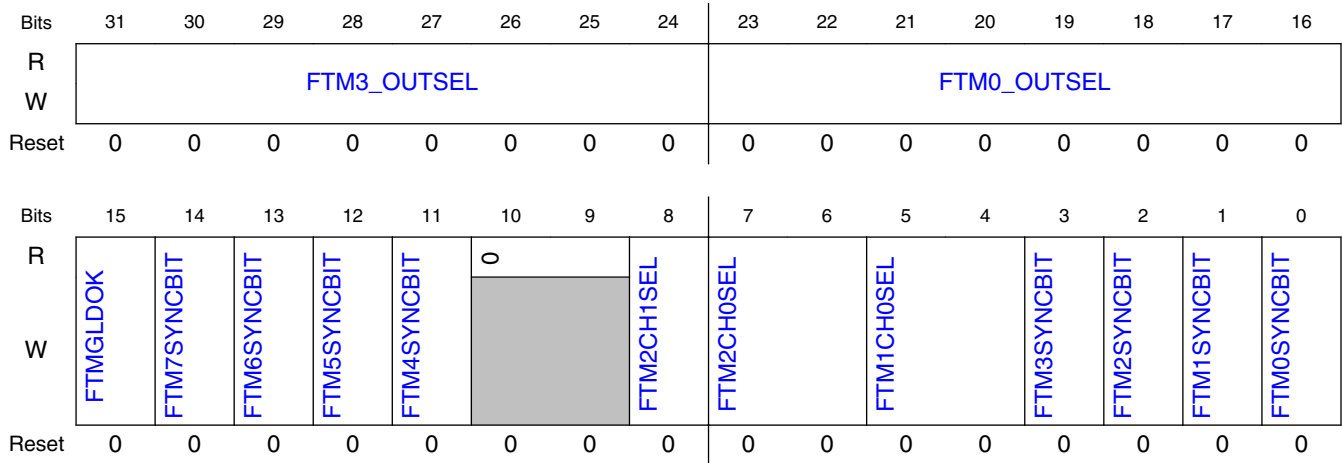

11.3.1.6.3 Fields

Field	Function
31-24 FTM3_OUTSEL	FTM3 channel modulation select with FTM2_CH1 Bits 7 to 0 of this field are for channel 7 to 0, respectively. 0000000b - No modulation with FTM2_CH1 0000001b - Modulation with FTM2_CH1
23-16 FTM0_OUTSEL	FTM0 channel modulation select with FTM1_CH1 Bits 7 to 0 of this field are for channel 7 to 0, respectively. 0000000b - No modulation with FTM1_CH1 0000001b - Modulation with FTM1_CH1
15 FTMGLDOK	FTM global load enable This bit is not self-clearing. For subsequent reload operations, it should be cleared and then set. 0b - FTM Global load mechanism disabled. 1b - FTM Global load mechanism enabled
14 FTM7SYNCSBIT	FTM7 Sync Bit This is used as trigger source for FTM7. See section FTM Hardware Triggers and Synchronization for details on FTM hardware triggering.
13 FTM6SYNCSBIT	FTM6 Sync Bit This is used as trigger source for FTM6. See section FTM Hardware Triggers and Synchronization for details on FTM hardware triggering.
12 FTM5SYNCSBIT	FTM5 Sync Bit This is used as trigger source for FTM5. See section FTM Hardware Triggers and Synchronization for details on FTM hardware triggering.
11 FTM4SYNCSBIT	FTM4 Sync Bit This is used as trigger source for FTM4. See section FTM Hardware Triggers and Synchronization for details on FTM hardware triggering.
10-9 —	Reserved

Table continues on the next page...

Field	Function
8 FTM2CH1SEL	FTM2 CH1 Select Selects FTM2 CH1 input 0b - FTM2_CH1 input 1b - exclusive OR of FTM2_CH0,FTM2_CH1,and FTM1_CH1
7-6 FTM2CH0SEL	FTM2 CH0 Select Selects FTM2 CH0 input 00b - FTM2_CH0 input 01b - CMP0 output 10b - Reserved 11b - Reserved
5-4 FTM1CH0SEL	FTM1 CH0 Select Selects FTM1 CH0 input 00b - FTM1_CH0 input 01b - CMP0 output 10b - Reserved 11b - Reserved
3 FTM3SYNCBIT	FTM3 Sync Bit This is used as trigger source for FTM3. See section FTM Hardware Triggers and Synchronization for details on FTM hardware triggering.
2 FTM2SYNCBIT	FTM2 Sync Bit This is used as trigger source for FTM2. See section FTM Hardware Triggers and Synchronization for details on FTM hardware triggering.
1 FTM1SYNCBIT	FTM1 Sync Bit This is used as trigger source for FTM1. See section FTM Hardware Triggers and Synchronization for details on FTM hardware triggering.
0 FTM0SYNCBIT	FTM0 Sync Bit This is used as trigger source for FTM0. See section FTM Hardware Triggers and Synchronization for details on FTM hardware triggering.

11.3.1.7 Miscellaneous control register 0 (MISCTRL0)

11.3.1.7.1 Offset

Register	Offset
MISCTRL0	20h

11.3.1.7.2 Diagram

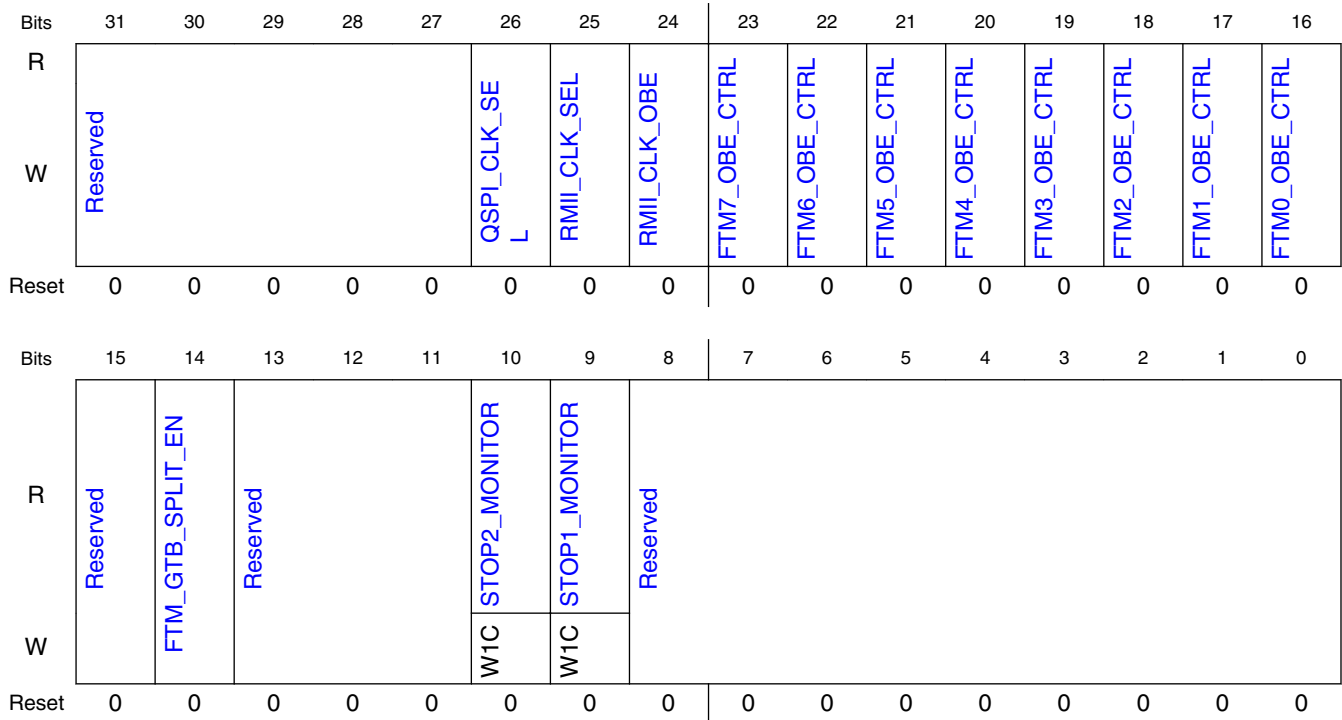

11.3.1.7.3 Fields

Field	Function
31-27 —	Reserved
26 QSPI_CLK_SEL	QSPI CLK Select bit QSPI asynchronous clock gating enable 0b - QuadSPI internal reference clock is gated. 1b - QuadSPI internal reference clock is enabled.
25 RMII_CLK_SEL	RMII CLK Select bit Set this bit to enable SOSCDIV1_CLK as ENET RMII clock in Internal loopback mode.
24 RMII_CLK_OBE	RMII CLK OBE bit Output Buffer Enable for ENET RMII clock in internal loopback mode
23 FTM7_OBE_CTRL	FTM7 OBE CTRL bit 0b - The FTM channel output is put to safe state when the FTM counter is enabled and the FTM channel output is enabled by Fault Control (FTM_MODE[FAULTM]! = 2'b00 and FTM_FLTCTRL[FSTATE] = 1'b0) and PWM is enabled (FTM_SC[PWMENn] = 1'b1). Otherwise the channel output is tristated. 1b - The FTM channel output state is retained when the channel is in output mode. The output channel is tristated when the channel is in input capture [DECAPEN = 1'b0, COMBINE = 1'b0, MSnB:MSnA = 2'b00] or dual edge capture mode [DECAPEN = 1'b1].
22	FTM6 OBE CTRL bit

Table continues on the next page...

Field	Function
FTM6_OBE_CTRL	<p>0b - The FTM channel output is put to safe state when the FTM counter is enabled and the FTM channel output is enabled by Fault Control (FTM_MODE[FAULTM]!\neq2'b00 and FTM_FLTCTRL[FSTATE]=1'b0) and PWM is enabled (FTM_SC[PWMENn] = 1'b1). Otherwise the channel output is tristated.</p> <p>1b - The FTM channel output state is retained when the channel is in output mode. The output channel is tristated when the channel is in input capture [DECAPEN=1'b0, COMBINE=1'b0, MSnB:MSnA=2'b00] or dual edge capture mode [DECAPEN=1'b1].</p>
21 FTM5_OBE_CTRL	<p>FTM5 OBE CTRL bit</p> <p>0b - The FTM channel output is put to safe state when the FTM counter is enabled and the FTM channel output is enabled by Fault Control (FTM_MODE[FAULTM]!\neq2'b00 and FTM_FLTCTRL[FSTATE]=1'b0) and PWM is enabled (FTM_SC[PWMENn] = 1'b1). Otherwise the channel output is tristated.</p> <p>1b - The FTM channel output state is retained when the channel is in output mode. The output channel is tristated when the channel is in input capture [DECAPEN=1'b0, COMBINE=1'b0, MSnB:MSnA=2'b00] or dual edge capture mode [DECAPEN=1'b1].</p>
20 FTM4_OBE_CTRL	<p>FTM4 OBE CTRL bit</p> <p>0b - The FTM channel output is put to safe state when the FTM counter is enabled and the FTM channel output is enabled by Fault Control (FTM_MODE[FAULTM]!\neq2'b00 and FTM_FLTCTRL[FSTATE]=1'b0) and PWM is enabled (FTM_SC[PWMENn] = 1'b1). Otherwise the channel output is tristated.</p> <p>1b - The FTM channel output state is retained when the channel is in output mode. The output channel is tristated when the channel is in input capture [DECAPEN=1'b0, COMBINE=1'b0, MSnB:MSnA=2'b00] or dual edge capture mode [DECAPEN=1'b1].</p>
19 FTM3_OBE_CTRL	<p>FTM3 OBE CTRL bit</p> <p>0b - The FTM channel output is put to safe state when the FTM counter is enabled and the FTM channel output is enabled by Fault Control (FTM_MODE[FAULTM]!\neq2'b00 and FTM_FLTCTRL[FSTATE]=1'b0) and PWM is enabled (FTM_SC[PWMENn] = 1'b1). Otherwise the channel output is tristated.</p> <p>1b - The FTM channel output state is retained when the channel is in output mode. The output channel is tristated when the channel is in input capture [DECAPEN=1'b0, COMBINE=1'b0, MSnB:MSnA=2'b00] or dual edge capture mode [DECAPEN=1'b1].</p>
18 FTM2_OBE_CTRL	<p>FTM2 OBE CTRL bit</p> <p>0b - The FTM channel output is put to safe state when the FTM counter is enabled and the FTM channel output is enabled by Fault Control (FTM_MODE[FAULTM]!\neq2'b00 and FTM_FLTCTRL[FSTATE]=1'b0) and PWM is enabled (FTM_SC[PWMENn] = 1'b1). Otherwise the channel output is tristated.</p> <p>1b - The FTM channel output state is retained when the channel is in output mode. The output channel is tristated when the channel is in input capture [DECAPEN=1'b0, COMBINE=1'b0, MSnB:MSnA=2'b00] or dual edge capture mode [DECAPEN=1'b1].</p>
17 FTM1_OBE_CTRL	<p>FTM1 OBE CTRL bit</p> <p>0b - The FTM channel output is put to safe state when the FTM counter is enabled and the FTM channel output is enabled by Fault Control (FTM_MODE[FAULTM]!\neq2'b00 and FTM_FLTCTRL[FSTATE]=1'b0) and PWM is enabled (FTM_SC[PWMENn] = 1'b1). Otherwise the channel output is tristated.</p> <p>1b - The FTM channel output state is retained when the channel is in output mode. The output channel is tristated when the channel is in input capture [DECAPEN=1'b0, COMBINE=1'b0, MSnB:MSnA=2'b00] or dual edge capture mode [DECAPEN=1'b1].</p>
16 FTM0_OBE_CTRL	<p>FTM0 OBE CTRL bit</p> <p>0b - The FTM channel output is put to safe state when the FTM counter is enabled and the FTM channel output is enabled by Fault Control (FTM_MODE[FAULTM]!\neq2'b00 and FTM_FLTCTRL[FSTATE]=1'b0) and PWM is enabled (FTM_SC[PWMENn] = 1'b1). Otherwise the channel output is tristated.</p> <p>1b - The FTM channel output state is retained when the channel is in output mode. The output channel is tristated when the channel is in input capture [DECAPEN=1'b0, COMBINE=1'b0, MSnB:MSnA=2'b00] or dual edge capture mode [DECAPEN=1'b1].</p>

Table continues on the next page...

Memory map and register definition

Field	Function
15 —	Reserved
14 FTM_GTB_SPLIT_EN	FTM GTB split enable/disable bit Split time base enable/disable. 0b - All the FTM0s have a single global time-base 1b - FTM0-3 have a common time-base and others have a different common time-base. Please refer 'FTM global time base' in FTM chapter for implementation details.
13-11 —	Reserved
10 STOP2_MONITOR	STOP2 monitor bit This status bit monitors system clock status on STOP2 mode entry and can be used for monitoring whether STOP2 entry was successful or aborted (In STOP2, system clock is disabled and bus clock is enabled). This bit needs to be W1C after wakeup from STOP2 mode. NOTE: This bit is reset on POR. 0b - System clock enabled or STOP2 entry aborted 1b - STOP2 entry successful
9 STOP1_MONITOR	STOP1 monitor bit This status bit monitors bus clock status on STOP1 mode entry and can be used for monitoring whether STOP1 entry was successful or aborted (In STOP1, both system and bus clocks are disabled). This bit needs to be W1C after wakeup from STOP1 mode. NOTE: This bit is reset on POR. 0b - Bus clock enabled or STOP1 entry aborted 1b - STOP1 entry successful
8-0 —	Reserved

11.3.1.8 System Device Identification Register (SDID)

11.3.1.8.1 Offset

Register	Offset
SDID	24h

11.3.1.8.2 Function

NOTE

This register's reset value is loaded during system reset from flash memory IFR.

11.3.1.8.3 Diagram

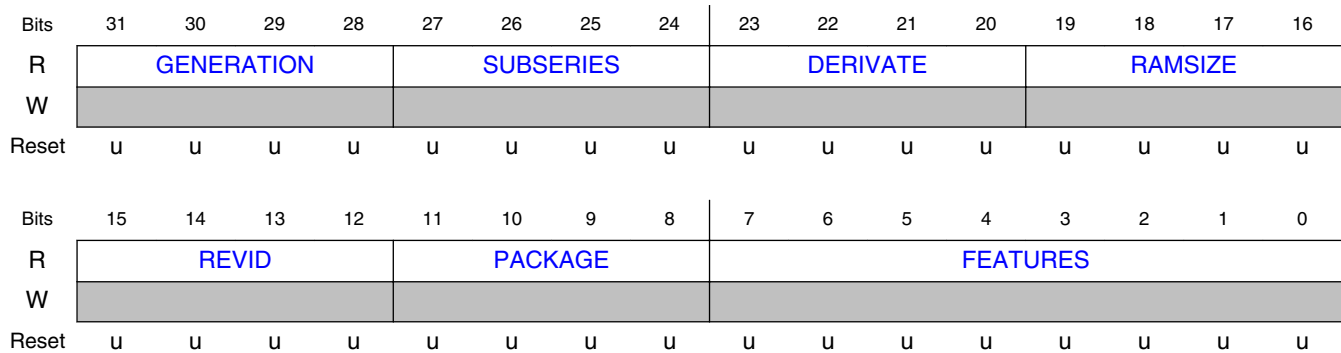

11.3.1.8.4 Fields

Field	Function
31-28 GENERATION	S32K product series generation Specifies the generation of the S32K product series of chips. Generation for this chip is 1.
27-24 SUBSERIES	Subseries Specifies the sub-series of the chip. The value is 4 (S32K14x and S32K14xW chip) or 1 (S32K11x chip).
23-20 DERIVATE	Derivate Specifies the derivate of the chip. The value is 8 (S32K148), 6 (S32K146), 4 (S32K144), 5 (S32K144W), 2 (S32K142), 3 (S32K142W) 8 (S32118), or 6 (S32K116).
19-16 RAMSIZE	RAM size This field specifies the total amount of system RAM available on the chip, including FlexRAM.
15-12 REVID	Device revision number Specifies the silicon implementation number for the chip. The value is 0 (for S32K148, S32K146, S32K142, S32K118, and S32K116) and 1 (for S32K144).
11-8 PACKAGE	Package Specifies the available package options for the chip. 0000b - Reserved 0001b - Reserved 0010b - 48 LQFP 0011b - 64 LQFP 0100b - 100 LQFP 0101b - Reserved 0110b - 144 LQFP 0111b - 176 LQFP 1000b - 100 MAP BGA 1001b - Reserved 1010b - Reserved 1011b - Reserved 1100b - Reserved 1101b - Reserved 1110b - Reserved 1111b - Reserved
7-0	Features

Memory map and register definition

Field	Function
FEATURES	<p>Specifies the supported features of the chip.</p> <p>NOTE:</p> <ul style="list-style-type: none"> While trying to access memory map region of un-available feature with corresponding module clock enabled through PCC CGC bit, there will not be any transfer error termination. This bit field overrides the PCC.PR status for the chip. <p>1 Feature is present 0 Feature is not present</p> <p>Each bit in this field represents the following:</p> <ul style="list-style-type: none"> Bit 7: Security Bit 6: Reserved Bit 5: Reserved Bit 4: Reserved Bit 3: Reserved Bit 2: Reserved Bit 1: Reserved Bit 0: Reserved

11.3.1.9 Platform Clock Gating Control Register (PLATCGC)

11.3.1.9.1 Offset

Register	Offset
PLATCGC	40h

11.3.1.9.2 Diagram

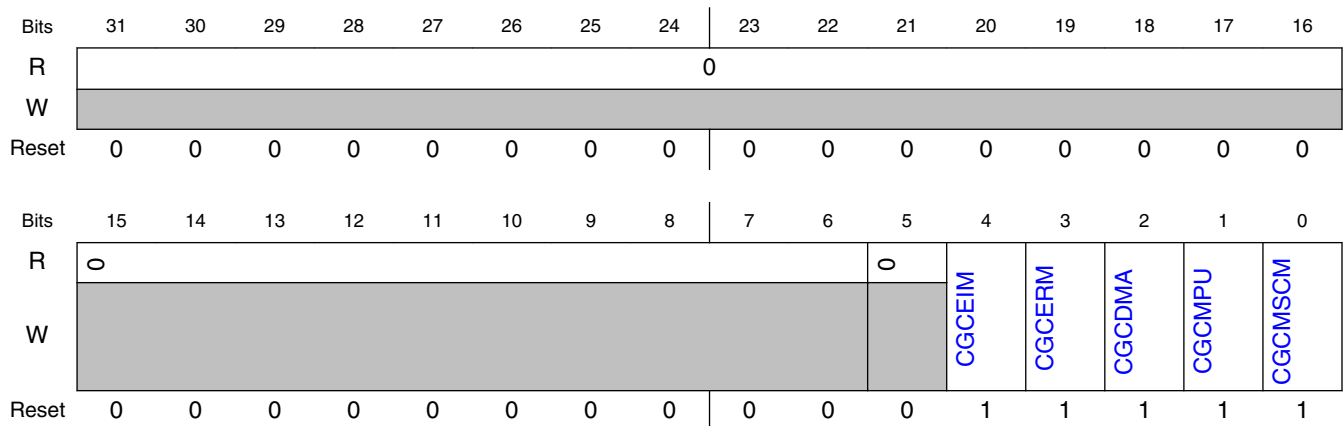

11.3.1.9.3 Fields

Field	Function
31-6 —	Reserved
5 —	Reserved
4 CGCEIM	EIM Clock Gating Control Controls the clock gating to the EIM. 0b - Clock disabled 1b - Clock enabled
3 CGCERM	ERM Clock Gating Control Controls the clock gating to the ERM. 0b - Clock disabled 1b - Clock enabled
2 CGCDMA	DMA Clock Gating Control Controls the clock gating to the DMA module. 0b - Clock disabled 1b - Clock enabled
1 CGCMPU	MPU Clock Gating Control Controls the clock gating to the MPU module. 0b - Clock disabled 1b - Clock enabled
0 CGCMSCM	MSCM Clock Gating Control Controls the clock gating to the MSCM. 0b - Clock disabled 1b - Clock enabled

11.3.1.10 Flash Configuration Register 1 (FCFG1)

11.3.1.10.1 Offset

Register	Offset
FCFG1	4Ch

11.3.1.10.2 Function

NOTE

The reset value of DEPART field of this register is loaded during system reset from flash memory IFR.

NOTE

Attempted writes to this register may result in unpredictable behavior.

11.3.1.10.3 Diagram

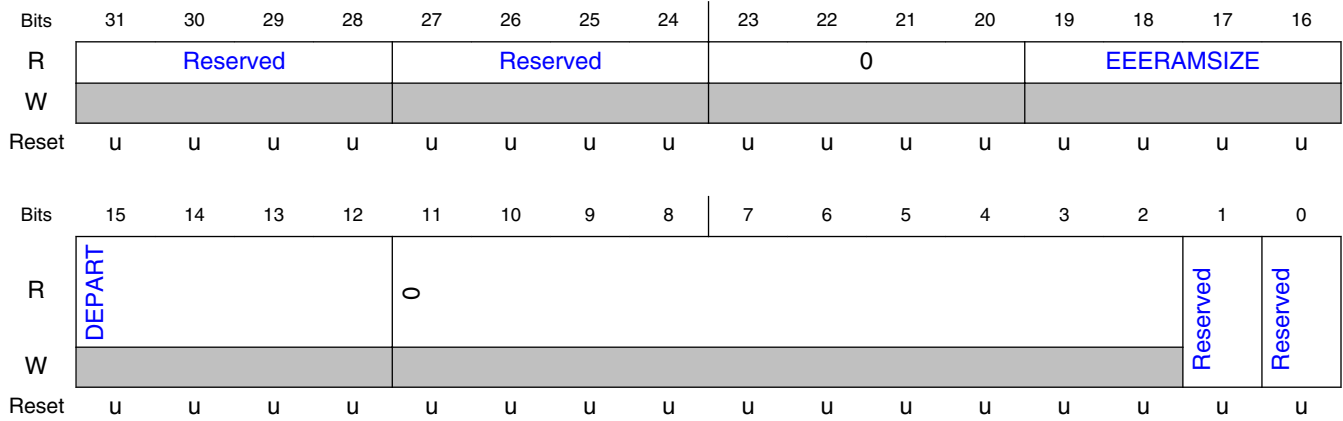

11.3.1.10.4 Fields

Field	Function
31-28 —	Reserved
27-24 —	Reserved
23-20 —	Reserved
19-16 EEERAMSIZE	EEE SRAM SIZE EEE SRAM data size. 0000b - Reserved 0001b - Reserved 0010b - 4 KB 0011b - 2 KB 0100b - 1 KB 0101b - 512 Bytes 0110b - 256 Bytes 0111b - 128 Bytes 1000b - 64 Bytes 1001b - 32 Bytes 1111b - 0 Bytes
15-12 DEPART	FlexNVM partition Data flash memory / emulated EEPROM backup split. See DEPART field description in FTFC chapter.
11-2 —	Reserved

Table continues on the next page...

Field	Function
1 —	Reserved
0 —	Reserved

11.3.1.11 Unique Identification Register High (UIDH)

11.3.1.11.1 Offset

Register	Offset
UIDH	54h

11.3.1.11.2 Function

NOTE

- UID127_96, UID95_64, UID63_32, and UID31_0 together represents 128-bit unique identification number for this device.
- This register's reset value is loaded during system reset from flash memory IFR.

11.3.1.11.3 Diagram

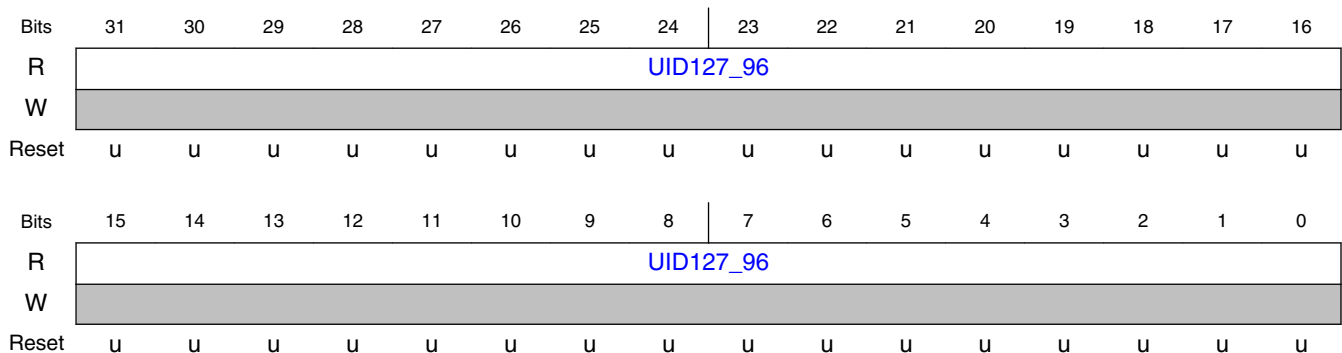

11.3.1.11.4 Fields

Field	Function
31-0	Unique Identification
UID127_96	Unique identification for the chip.

11.3.1.12 Unique Identification Register Mid-High (UIDMH)

11.3.1.12.1 Offset

Register	Offset
UIDMH	58h

11.3.1.12.2 Function

NOTE

This register's reset value is loaded during system reset from flash memory IFR.

11.3.1.12.3 Diagram

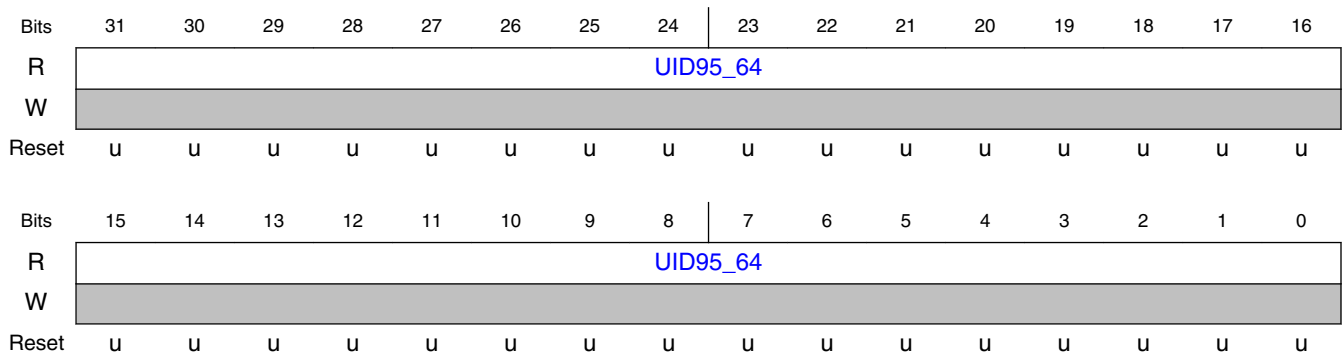

11.3.1.12.4 Fields

Field	Function
31-0	Unique Identification
UID95_64	Unique identification for the chip.

11.3.1.13 Unique Identification Register Mid Low (UIDML)

11.3.1.13.1 Offset

Register	Offset
UIDML	5Ch

11.3.1.13.2 Function

NOTE

This register's reset value is loaded during system reset from flash memory IFR.

11.3.1.13.3 Diagram

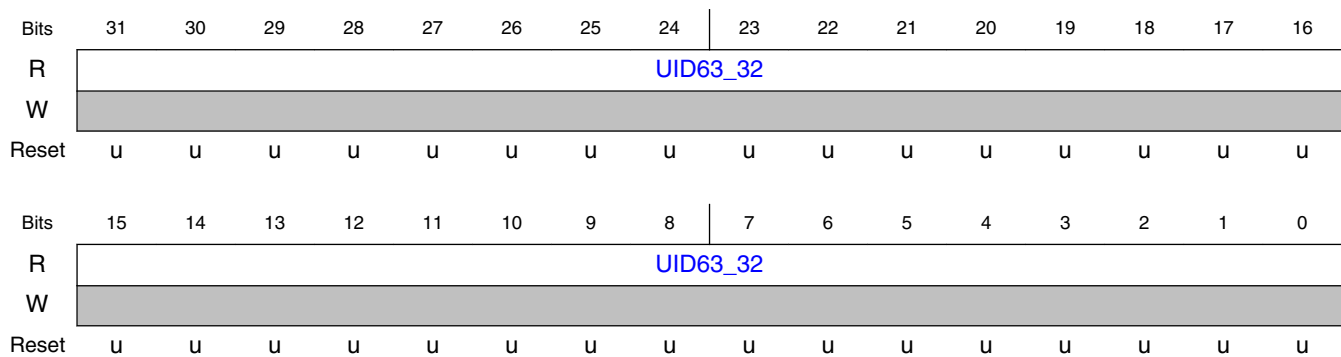

11.3.1.13.4 Fields

Field	Function
31-0	Unique Identification
UID63_32	Unique identification for the chip.

11.3.1.14 Unique Identification Register Low (UIDL)

11.3.1.14.1 Offset

Register	Offset
UIDL	60h

11.3.1.14.2 Function

NOTE

This register's reset value is loaded during system reset from flash memory IFR.

11.3.1.14.3 Diagram

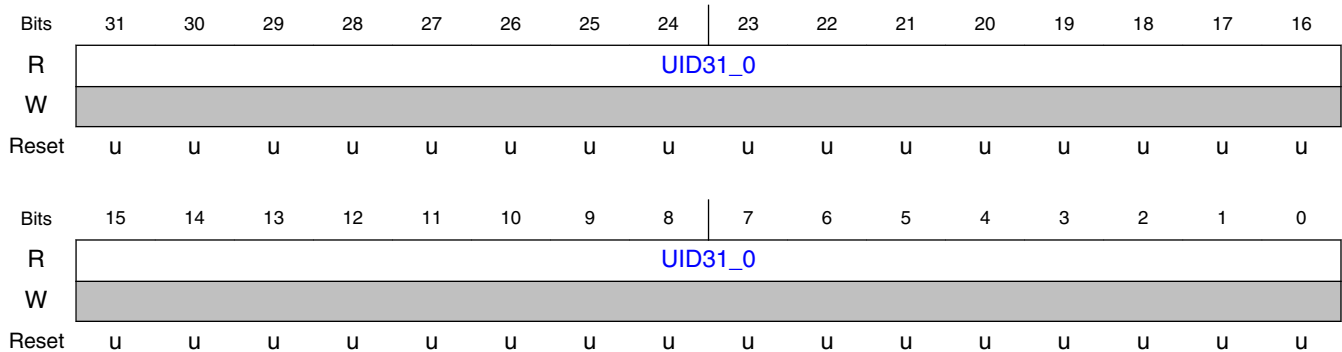

11.3.1.14.4 Fields

Field	Function
31-0	Unique Identification
UID31_0	Unique identification for the chip.

11.3.1.15 System Clock Divider Register 4 (CLKDIV4)

11.3.1.15.1 Offset

Register	Offset
CLKDIV4	68h

11.3.1.15.2 Function

NOTE

This register is Reserved for S32K11x variants.

11.3.1.15.3 Diagram

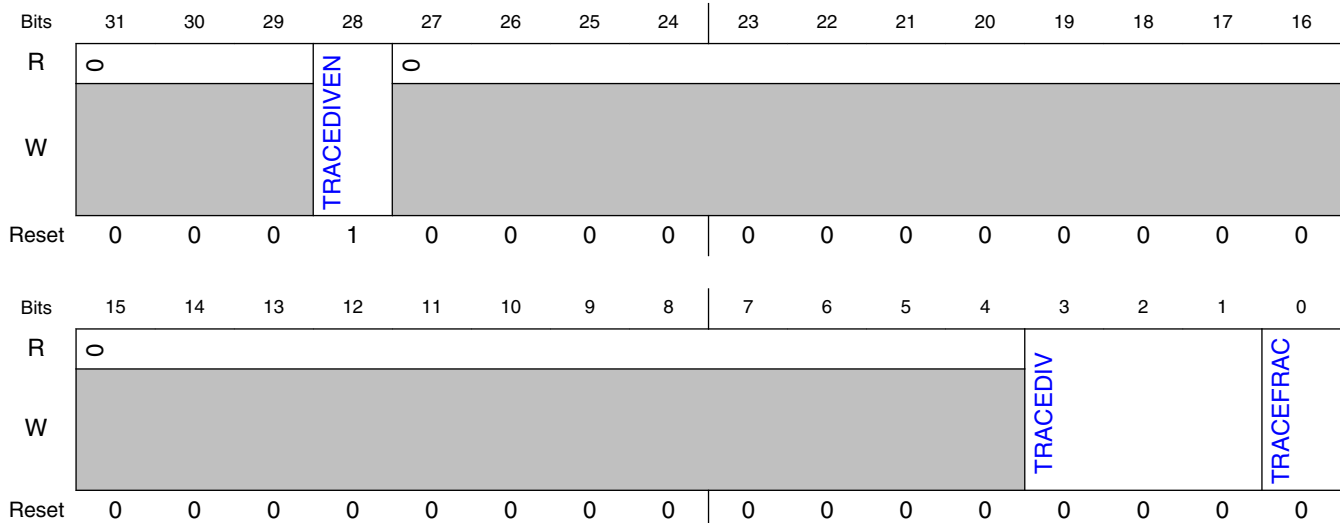

11.3.1.15.4 Fields

Field	Function
31-29 —	Reserved
28 TRACEDIVEN	Debug Trace Divider control This field controls the Debug Trace Divider. 0b - Debug trace divider disabled 1b - Debug trace divider enabled
27-4 —	Reserved
3-1 TRACEDIV	Trace Clock Divider value To configure TRACEDIV, you must first disable TRACEDIVEN, then enable it after setting TRACEDIV. This field sets the divide value for the fractional clock divider used as a source for trace clock. The source clock for the trace clock is set by the SIM_CHIPCTL[TRACECLK_SEL]. Divider output clock = Divider input clock * [(TRACEFRAC+1)/(TRACEDIV+1)]. NOTE: TRACEFRAC should be \leq TRACEDIV
0 TRACEFRAC	Trace Clock Divider fraction To configure TRACEDIV and TRACEFRAC, you must first clear TRACEDIVEN to disable the trace clock divide function. This field sets the divide value for the fractional clock divider used as a source for trace clock. The source clock for the trace clock is set by the SIM_CHIPCTL[TRACECLK_SEL]. Divider output clock = Divider input clock * [(TRACEFRAC+1)/(TRACEDIV+1)].

Memory map and register definition

Field	Function
	NOTE: TRACEFRAC should be \leq TRACEDIV

11.3.1.16 Miscellaneous Control register 1 (MISCTRL1)

11.3.1.16.1 Offset

Register	Offset
MISCTRL1	6Ch

11.3.1.16.2 Diagram

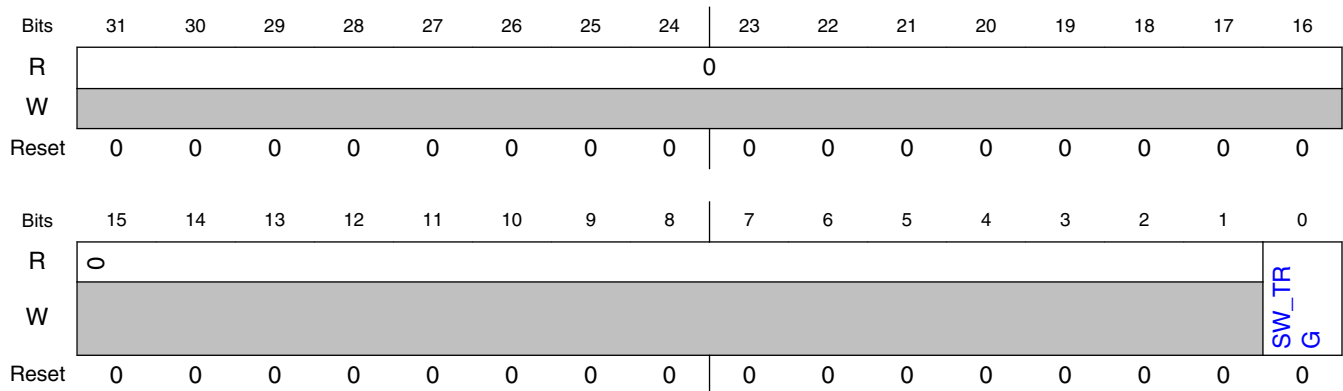

11.3.1.16.3 Fields

Field	Function
31-1 —	Reserved
0 SW_TRG	Software trigger to TRGMUX. Writing to this bit generates software trigger to peripherals through TRGMUX (Refer to Figure: Trigger interconnectivity).

Chapter 12

Port Control and Interrupts (PORT)

12.1 Chip-specific PORT information

Not all pin control settings mentioned in PORT_PCRn register are configurable for all pins. Refer 'Bits Configurable' field in 'IO Signal Table' tab of IO Signal Description Input Multiplexing sheet(s) attached to the Reference Manual. The bits apart from 'Bit Configurable' fields are reserved and should not be varied from the reset values.

PCR bits corresponding to reset pad are non-sticky bits and on a functional reset, reset functionality on this pin will be resumed. Prior to entering any ALT functionality, PCR of corresponding pad should be properly configured.

On this chip, the pullup and pulldown enables are controllable in analog or disabled pin muxing mode (corresponding to PORT_PCRn[MUX]=3'b000). Before entering Analog mode (ALT0 corresponding to PORT_PCRn[MUX]=3'b000 for corresponding pads for which Analog functionality is available), PUE and PUS should be configured as 0 in corresponding PCR register.

PORT_PCRn[PFE] is configurable for only PTA5 and PTD3. See IO Signal Description Input Multiplexing sheet(s) attached to the Reference Manual. PFE for these should be configured in ALT7 mode only. For other modes, PFE should be kept 0.

The corresponding PAD should be configured for disabled mode(ALT0) prior to configuring PORT_DFER register.

Any pad configuration done in RUN/VLPR mode is retained in low power modes(STOP1,STOP2/VLPS).

Wait mode is not supported on this device.

See [Module operation in available power modes](#) for details on available power modes.

12.1.1 Number of PCRs

The number of PCRs for each PORT varies across the products in the S32K1xx and S32K14xW series. The following table shows the number of PCRs for each PORT on each product. [Memory map and register definition](#) documents the superset number of implemented ports. PCR registers corresponding to ports which are not present in a particular device are read only 0. See the RM attachments IO Signal Description Input Multiplexing sheet(s) for details on the count of PCRs on each product.

Table 12-1. PCRs on each product

PORT	Number of PCRs ¹						
	S32K116	S32K118	S32K142	S32K144	S32K144W	S32K146	S32K148
PORT A	11	12	18	18	18	25	32
PORT B	9	10	18	18	18	27	32
PORT C	12	14	18	18	18	25	32
PORT D	7	10	18	18	18	27	32
PORT E	4	12	17	17	17	24	28

1. See the attachments IO Signal Description Input Multiplexing sheet(s) for details.

12.1.2 Finding address for PORTx_PCRn

For example, in order to write to the PORT register of PTC3 (PTxn), the corresponding mapped register is PORTC_PCR3 (PORTx_PCRn):

- To find PORTC base address, look up the 'Start address' of "Port C" in "Peripheral Memory Map" tab in the attached S32K1xx_Memory_Map.xls. This is referred henceforth as PORTC_Base_address.
- To reach PCRn, refer to address 'PORTx_Base_address + n*4d'. For PCR3 of PORTC, this refers to 'PORTC_Base_address + 3*4d'. The attached IO Signal Description Input Muxing sheet(s) for each device provides the fields available in PCR per PORTx_PCRn (For each PTxn pin) in the tab IO Signal Table.

12.1.3 I/O configuration sequence

1. Ensure pins for the peripheral are in tristate state (default out of reset).
2. Initialize peripheral clock in the Peripheral Clock Controller register(PCC) and peripheral specific clocking configurations.
3. Configure the peripheral
4. Initialize port clock for the peripheral pins in the Peripheral Clock Controller register (PCC_PORTx).

5. Configure the peripheral pins mux and features in the Port Control and Interrupts register (PORTx_PCRn).
6. Start communication

12.1.4 Digital input filter configuration sequence

1. Configure digital pin filtering controls for the corresponding pin using PORTx_DFCR and PORTx_DFWR
2. Enable PORTx_DFER[DFE]
3. Configure PORTx_PCRn[MUX] for GPIO mode
4. Wait for delay equivalent to PORTx_DFWR for filter enabling glitches to propagate
5. Enable the corresponding function of the pin by configuring PORTx_PCRn[MUX]

12.1.4.1 Digital input filter configuration sequence while using GPIO interrupt

1. Configure digital pin filtering controls for the corresponding pin using PORTx_DFCR and PORTx_DFWR
2. Enable PORTx_DFER[DFE]
3. Configure PORTx_PCRn[MUX] for GPIO mode
4. Wait for delay equivalent to PORTx_DFWR for filter enabling glitches to propagate
5. Enable the interrupt on the corresponding pin by configuring PORTx_PCRn[IRQC]

12.1.4.2 Digital input filter configuration sequence while using NMI

1. Configure digital pin filtering controls for NMI pin using PORTD_DFCR and PORTD_DFWR
2. Enable PORTD_DFER[3]
3. Configure PORTD_PCR3[MUX] for GPIO mode
4. Wait for delay equivalent to PORTD_DFWR for filter enabling glitches to propagate
5. Configure the pin for NMI mode using PORTD_PCR3[MUX]

Before entering STOP/VLPS modes, filter clock should be configured as LPO128K_CLK and reconfigured on wakeup, if required.

If filtering is not required in STOP/VLPS modes, filtering should be disabled using PORTx_DFER and reconfigured on wakeup, if required. If filtering is not required in STOP/VLPS modes and is required wakeup onwards without reconfiguring PORTx_DFER (with bus clock as filter clock), it should be ensured that:

$$\text{cycles_tISR} \gg (\text{PORTx_DFWR} + 3) * (\text{SCG_xCCR}[\text{DIVBUS}] + 1)$$

where *cycles_tISR*: Core clock cycles in Interrupt Service Routine (ISR) from system entering RUN mode till PORTx_PCRn[ISF] clearing for corresponding pin.

(Sufficient delay should be added in ISR, if required, to achieve the above)

12.1.5 Reset pin configuration

The reset pin on device can be configured for alternative functionalities via PORTA_PCR5[SSS] (see IO Signal Description Input Multiplexing sheet(s) attached to the Reference Manual). Before configuring alternative functionality for Reset Pin, set the [FOPT\[3\]](#) (RESET_PIN_CFG bit) to 0 in Flash memory configuration field and reflash your device. The FOPT field of flash memory configuration field will be loaded to FTFC_FOPT read-only register at RESET. See table 'FTFC_FOPT definition' in [FOPT boot options](#) for details.

NOTE

External Reset functionality will be disabled after writing FOPT[3] (RESET_PIN_CFG bit) to 0.

12.2 Introduction

12.2.1 Overview

The Port Control and Interrupt (PORT) module provides support for port control, digital filtering, and external interrupt functions.

Most functions can be configured independently for each pin in the 32-bit port and affect the pin regardless of its pin muxing state.

There is one instance of the PORT module for each port. Not all pins within each port are implemented on a specific device.

12.2.2 Features

The PORT module has the following features:

- Pin interrupt
 - Interrupt flag and enable registers for each pin
 - Support for edge sensitive (rising, falling, both) or level sensitive (low, high) configured per pin
 - Support for interrupt or DMA request configured per pin

- Asynchronous wake-up in low-power modes
- Pin interrupt is functional in all digital pin muxing modes
- Digital input filter
 - Digital input filter for each pin, usable by any digital peripheral muxed onto the pin
 - Individual enable or bypass control field per pin
 - Selectable clock source for digital input filter with a five bit resolution on filter size
 - Functional in all digital pin multiplexing modes
- Port control
 - Individual pull control fields with pullup, pulldown, and pull-disable support
 - Individual drive strength field supporting high and low drive strength
 - Individual input passive filter field supporting enable and disable of the individual input passive filter
 - Individual mux control field supporting analog or pin disabled, GPIO, and up to six chip-specific digital functions
 - Pad configuration fields are functional in all digital pin muxing modes.

12.2.3 Modes of operation

12.2.3.1 Run mode

In Run mode, the PORT operates normally.

12.2.3.2 Wait mode

In Wait mode, PORT continues to operate normally and may be configured to exit the Low-Power mode if an enabled interrupt is detected. DMA requests are still generated during the Wait mode, but do not cause an exit from the Low-Power mode.

12.2.3.3 Stop mode

In Stop mode, the PORT can be configured to exit the Low-Power mode via an asynchronous wake-up signal if an enabled interrupt is detected.

In Stop mode, the digital input filters are bypassed unless they are configured to run from the LPO clock source.

12.2.3.4 Debug mode

In Debug mode, PORT operates normally.

12.3 External signal description

The table found here describes the PORT external signal.

Table 12-2. Signal properties

Name	Function	I/O	Reset	Pull
PORTx[31:0]	External interrupt	I/O	0	-

NOTE

Not all pins within each port are implemented on each device.

12.4 Detailed signal description

The table found here contains the detailed signal description for the PORT interface.

Table 12-3. PORT interface—detailed signal description

Signal	I/O	Description	
PORTx[31:0]	I/O	External interrupt.	
		State meaning	Asserted—pin is logic 1. Negated—pin is logic 0.
		Timing	Assertion—may occur at any time and can assert asynchronously to the system clock. Negation—may occur at any time and can assert asynchronously to the system clock.

12.5 Memory map and register definition

Any read or write access to the PORT memory space that is outside the valid memory map results in a bus error. All register accesses complete with zero wait states.

PORT memory map

Address offset (hex)	Register name	Width (in bits)	Access	Reset value	Section/page
0	Pin Control Register n (PORT_PCR0)	32	R/W	See section	12.5.1/213
4	Pin Control Register n (PORT_PCR1)	32	R/W	See section	12.5.1/213
8	Pin Control Register n (PORT_PCR2)	32	R/W	See section	12.5.1/213
C	Pin Control Register n (PORT_PCR3)	32	R/W	See section	12.5.1/213
10	Pin Control Register n (PORT_PCR4)	32	R/W	See section	12.5.1/213
14	Pin Control Register n (PORT_PCR5)	32	R/W	See section	12.5.1/213
18	Pin Control Register n (PORT_PCR6)	32	R/W	See section	12.5.1/213
1C	Pin Control Register n (PORT_PCR7)	32	R/W	See section	12.5.1/213
20	Pin Control Register n (PORT_PCR8)	32	R/W	See section	12.5.1/213
24	Pin Control Register n (PORT_PCR9)	32	R/W	See section	12.5.1/213
28	Pin Control Register n (PORT_PCR10)	32	R/W	See section	12.5.1/213
2C	Pin Control Register n (PORT_PCR11)	32	R/W	See section	12.5.1/213
30	Pin Control Register n (PORT_PCR12)	32	R/W	See section	12.5.1/213
34	Pin Control Register n (PORT_PCR13)	32	R/W	See section	12.5.1/213
38	Pin Control Register n (PORT_PCR14)	32	R/W	See section	12.5.1/213
3C	Pin Control Register n (PORT_PCR15)	32	R/W	See section	12.5.1/213
40	Pin Control Register n (PORT_PCR16)	32	R/W	See section	12.5.1/213
44	Pin Control Register n (PORT_PCR17)	32	R/W	See section	12.5.1/213
48	Pin Control Register n (PORT_PCR18)	32	R/W	See section	12.5.1/213
4C	Pin Control Register n (PORT_PCR19)	32	R/W	See section	12.5.1/213
50	Pin Control Register n (PORT_PCR20)	32	R/W	See section	12.5.1/213
54	Pin Control Register n (PORT_PCR21)	32	R/W	See section	12.5.1/213
58	Pin Control Register n (PORT_PCR22)	32	R/W	See section	12.5.1/213
5C	Pin Control Register n (PORT_PCR23)	32	R/W	See section	12.5.1/213
60	Pin Control Register n (PORT_PCR24)	32	R/W	See section	12.5.1/213
64	Pin Control Register n (PORT_PCR25)	32	R/W	See section	12.5.1/213
68	Pin Control Register n (PORT_PCR26)	32	R/W	See section	12.5.1/213
6C	Pin Control Register n (PORT_PCR27)	32	R/W	See section	12.5.1/213
70	Pin Control Register n (PORT_PCR28)	32	R/W	See section	12.5.1/213
74	Pin Control Register n (PORT_PCR29)	32	R/W	See section	12.5.1/213
78	Pin Control Register n (PORT_PCR30)	32	R/W	See section	12.5.1/213
7C	Pin Control Register n (PORT_PCR31)	32	R/W	See section	12.5.1/213
80	Global Pin Control Low Register (PORT_GPCLR)	32	W (always reads 0)	0000_0000h	12.5.2/216
84	Global Pin Control High Register (PORT_GPCHR)	32	W (always reads 0)	0000_0000h	12.5.3/216

Table continues on the next page...

PORT memory map (continued)

Address offset (hex)	Register name	Width (in bits)	Access	Reset value	Section/page
88	Global Interrupt Control Low Register (PORT_GICLR)	32	W (always reads 0)	0000_0000h	12.5.4/217
8C	Global Interrupt Control High Register (PORT_GICHR)	32	W (always reads 0)	0000_0000h	12.5.5/217
A0	Interrupt Status Flag Register (PORT_ISFR)	32	w1c	0000_0000h	12.5.6/218
C0	Digital Filter Enable Register (PORT_DFER)	32	R/W	0000_0000h	12.5.7/219
C4	Digital Filter Clock Register (PORT_DFCL)	32	R/W	0000_0000h	12.5.8/219
C8	Digital Filter Width Register (PORT_DFWR)	32	R/W	0000_0000h	12.5.9/220

12.5.1 Pin Control Register n (PORT_PCRn)

NOTE

See the GPIO Configuration section for details on the available functions for each pin.

Do not modify pin configuration registers associated with pins that are not available in a reduced-pin package offering. Unbonded pins not available in a package are disabled by default to prevent them from consuming power.

Address: 0h base + 0h offset + (4d × i), where i=0d to 31d

Bit	31	30	29	28	27	26	25	24	23	22	21	20	19	18	17	16	
R	0							ISF	0				IRQC				
W	w1c																
Reset	0	0	0	0	0	0	0	0	0	0	0	0	0	0	0	0	
Bit	15	14	13	12	11	10	9	8	7	6	5	4	3	2	1	0	
R	0					MUX			0				0				
W	LK									DSE	Reserved	PFE		Reserved	PE	PS	
Reset	0	0	0	0	0	*	*	*	0	*	0	*	0	0	*	*	

* Notes:

- MUX field: Varies by port. See Signal Multiplexing and Signal Descriptions chapter for reset values per port.
- DSE field: Varies by port. See Signal Multiplexing and Signal Descriptions chapter for reset values per port.
- PFE field: Varies by port. See Signal Multiplexing and Signal Descriptions chapter for reset values per port.
- PE field: Varies by port. See Signal Multiplexing and Signal Descriptions chapter for reset values per port.
- PS field: Varies by port. See Signal Multiplexing and Signal Descriptions chapter for reset values per port.

PORT_PCR_n field descriptions

Field	Description
31–25 Reserved	This field is reserved. This read-only field is reserved and always has the value 0.
24 ISF	Interrupt Status Flag The pin interrupt configuration is valid in all digital pin muxing modes. 0 Configured interrupt is not detected. 1 Configured interrupt is detected. If the pin is configured to generate a DMA request, then the corresponding flag will be cleared automatically at the completion of the requested DMA transfer. Otherwise, the flag remains set until a logic 1 is written to the flag. If the pin is configured for a level sensitive interrupt and the pin remains asserted, then the flag is set again immediately after it is cleared.
23–20 Reserved	This field is reserved. This read-only field is reserved and always has the value 0.
19–16 IRQC	Interrupt Configuration The pin interrupt configuration is valid in all digital pin muxing modes. The corresponding pin is configured to generate interrupt/DMA request as follows: 0000 Interrupt Status Flag (ISF) is disabled. 0001 ISF flag and DMA request on rising edge. 0010 ISF flag and DMA request on falling edge. 0011 ISF flag and DMA request on either edge. 0100 Reserved. 0101 Reserved. 0110 Reserved. 0111 Reserved. 1000 ISF flag and Interrupt when logic 0. 1001 ISF flag and Interrupt on rising-edge. 1010 ISF flag and Interrupt on falling-edge. 1011 ISF flag and Interrupt on either edge. 1100 ISF flag and Interrupt when logic 1. 1101 Reserved. 1110 Reserved. 1111 Reserved.
15 LK	Lock Register 0 Pin Control Register fields [15:0] are not locked. 1 Pin Control Register fields [15:0] are locked and cannot be updated until the next system reset.
14–11 Reserved	This field is reserved. This read-only field is reserved and always has the value 0.
10–8 MUX	Pin Mux Control Not all pins support all pin muxing slots. Unimplemented pin muxing slots are reserved and may result in configuring the pin for a different pin muxing slot. The corresponding pin is configured in the following pin muxing slot as follows: 000 Pin disabled (Alternative 0) (analog). 001 Alternative 1 (GPIO). 010 Alternative 2 (chip-specific).

Table continues on the next page...

PORT_PCR n field descriptions (continued)

Field	Description
	011 Alternative 3 (chip-specific). 100 Alternative 4 (chip-specific). 101 Alternative 5 (chip-specific). 110 Alternative 6 (chip-specific). 111 Alternative 7 (chip-specific).
7 Reserved	This field is reserved. This read-only field is reserved and always has the value 0.
6 DSE	Drive Strength Enable Drive strength configuration is valid in all digital pin muxing modes. 0 Low drive strength is configured on the corresponding pin, if pin is configured as a digital output. 1 High drive strength is configured on the corresponding pin, if pin is configured as a digital output.
5 Reserved	This field is reserved.
4 PFE	Passive Filter Enable Passive filter configuration is valid in all digital pin muxing modes. 0 Passive input filter is disabled on the corresponding pin. 1 Passive input filter is enabled on the corresponding pin, if the pin is configured as a digital input. Refer to the device data sheet for filter characteristics.
3 Reserved	This field is reserved. This read-only field is reserved and always has the value 0.
2 Reserved	This field is reserved.
1 PE	Pull Enable Pull configuration is valid in all digital pin muxing modes. 0 Internal pullup or pulldown resistor is not enabled on the corresponding pin. 1 Internal pullup or pulldown resistor is enabled on the corresponding pin, if the pin is configured as a digital input.
0 PS	Pull Select Pull configuration is valid in all digital pin muxing modes. 0 Internal pulldown resistor is enabled on the corresponding pin, if the corresponding PE field is set. 1 Internal pullup resistor is enabled on the corresponding pin, if the corresponding PE field is set.

12.5.2 Global Pin Control Low Register (PORT_GPCLR)

Only 32-bit writes are supported to this register.

Address: 0h base + 80h offset = 80h

Bit	31	30	29	28	27	26	25	24	23	22	21	20	19	18	17	16	15	14	13	12	11	10	9	8	7	6	5	4	3	2	1	0
R	0																0															
W	GPWE																GPWD															
Reset	0	0	0	0	0	0	0	0	0	0	0	0	0	0	0	0	0	0	0	0	0	0	0	0	0	0	0	0	0	0	0	0

PORT_GPCLR field descriptions

Field	Description
31–16 GPWE	<p>Global Pin Write Enable</p> <p>Selects which Pin Control Registers (15 through 0) bits [15:0] update with the value in GPWD. If a selected Pin Control Register is locked then the write to that register is ignored.</p> <p>0 Corresponding Pin Control Register is not updated with the value in GPWD. 1 Corresponding Pin Control Register is updated with the value in GPWD.</p>
GPWD	<p>Global Pin Write Data</p> <p>Write value that is written to all Pin Control Registers bits [15:0] that are selected by GPWE.</p>

12.5.3 Global Pin Control High Register (PORT_GPCHR)

Only 32-bit writes are supported to this register.

Address: 0h base + 84h offset = 84h

Bit	31	30	29	28	27	26	25	24	23	22	21	20	19	18	17	16	15	14	13	12	11	10	9	8	7	6	5	4	3	2	1	0
R	0																0															
W	GPWE																GPWD															
Reset	0	0	0	0	0	0	0	0	0	0	0	0	0	0	0	0	0	0	0	0	0	0	0	0	0	0	0	0	0	0	0	0

PORT_GPCHR field descriptions

Field	Description
31–16 GPWE	<p>Global Pin Write Enable</p> <p>Selects which Pin Control Registers (31 through 16) bits [15:0] update with the value in GPWD. If a selected Pin Control Register is locked then the write to that register is ignored.</p> <p>0 Corresponding Pin Control Register is not updated with the value in GPWD. 1 Corresponding Pin Control Register is updated with the value in GPWD.</p>
GPWD	<p>Global Pin Write Data</p>

Table continues on the next page...

PORT_GPCHR field descriptions (continued)

Field	Description
	Write value that is written to all Pin Control Registers bits [15:0] that are selected by GPWE.

12.5.4 Global Interrupt Control Low Register (PORT_GICLR)

Only 32-bit writes are supported to this register.

Address: 0h base + 88h offset = 88h

Bit	31	30	29	28	27	26	25	24	23	22	21	20	19	18	17	16	15	14	13	12	11	10	9	8	7	6	5	4	3	2	1	0
R	0																0															
W	GIWD																GIWE															
Reset	0	0	0	0	0	0	0	0	0	0	0	0	0	0	0	0	0	0	0	0	0	0	0	0	0	0	0	0	0	0	0	

PORT_GICLR field descriptions

Field	Description
31–16 GIWD	Global Interrupt Write Data Write value that is written to all Pin Control Registers bits [31:16] that are selected by GIWE.
GIWE	Global Interrupt Write Enable Selects which Pin Control Registers (15 through 0) bits [31:16] update with the value in GIWD. 0 Corresponding Pin Control Register is not updated with the value in GPWD. 1 Corresponding Pin Control Register is updated with the value in GPWD.

12.5.5 Global Interrupt Control High Register (PORT_GICHR)

Only 32-bit writes are supported to this register.

Address: 0h base + 8Ch offset = 8Ch

Bit	31	30	29	28	27	26	25	24	23	22	21	20	19	18	17	16	15	14	13	12	11	10	9	8	7	6	5	4	3	2	1	0
R	0																0															
W	GIWD																GIWE															
Reset	0	0	0	0	0	0	0	0	0	0	0	0	0	0	0	0	0	0	0	0	0	0	0	0	0	0	0	0	0	0	0	

PORT_GICHR field descriptions

Field	Description
31–16 GIWD	Global Interrupt Write Data Write value that is written to all Pin Control Registers bits [31:16] that are selected by GIWE.

Table continues on the next page...

PORT_GICHR field descriptions (continued)

Field	Description
GIWE	<p>Global Interrupt Write Enable</p> <p>Selects which Pin Control Registers (31 through 16) bits [31:16] update with the value in GIWD.</p> <p>0 Corresponding Pin Control Register is not updated with the value in GPWD. 1 Corresponding Pin Control Register is updated with the value in GPWD.</p>

12.5.6 Interrupt Status Flag Register (PORT_ISFR)

The pin interrupt configuration is valid in all digital pin muxing modes. The Interrupt Status Flag for each pin is also visible in the corresponding Pin Control Register, and each flag can be cleared in either location.

Address: 0h base + A0h offset = A0h

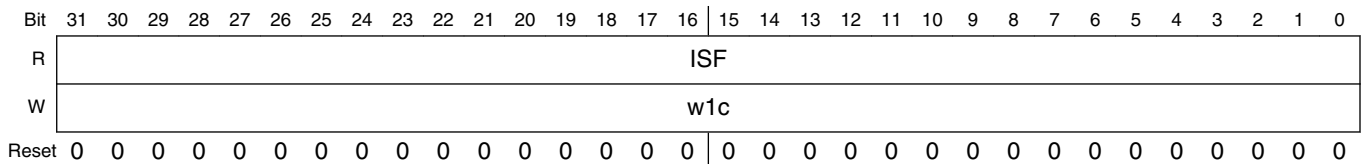

PORT_ISFR field descriptions

Field	Description
ISF	<p>Interrupt Status Flag</p> <p>Each bit in the field indicates the detection of the configured interrupt of the same number as the field.</p> <p>0 Configured interrupt is not detected. 1 Configured interrupt is detected. If the pin is configured to generate a DMA request, then the corresponding flag will be cleared automatically at the completion of the requested DMA transfer. Otherwise, the flag remains set until a logic 1 is written to the flag. If the pin is configured for a level sensitive interrupt and the pin remains asserted, then the flag is set again immediately after it is cleared.</p>

12.5.7 Digital Filter Enable Register (PORT_DFER)

The digital filter configuration is valid in all digital pin muxing modes.

Address: 0h base + C0h offset = C0h

Bit	31	30	29	28	27	26	25	24	23	22	21	20	19	18	17	16	15	14	13	12	11	10	9	8	7	6	5	4	3	2	1	0
R																	DFE															
W																																
Reset	0	0	0	0	0	0	0	0	0	0	0	0	0	0	0	0	0	0	0	0	0	0	0	0	0	0	0	0	0	0	0	0

PORT_DFER field descriptions

Field	Description
DFE	<p>Digital Filter Enable</p> <p>The digital filter configuration is valid in all digital pin muxing modes. The output of each digital filter is reset to zero at system reset and whenever the digital filter is disabled. Each bit in the field enables the digital filter of the same number as the field.</p> <p>0 Digital filter is disabled on the corresponding pin and output of the digital filter is reset to zero.</p> <p>1 Digital filter is enabled on the corresponding pin, if the pin is configured as a digital input.</p>

12.5.8 Digital Filter Clock Register (PORT_DF CR)

The digital filter configuration is valid in all digital pin muxing modes.

Address: 0h base + C4h offset = C4h

Bit	31	30	29	28	27	26	25	24	23	22	21	20	19	18	17	16
R	0															
W																
Reset	0	0	0	0	0	0	0	0	0	0	0	0	0	0	0	0
Bit	15	14	13	12	11	10	9	8	7	6	5	4	3	2	1	0
R	0															CS
W																
Reset	0	0	0	0	0	0	0	0	0	0	0	0	0	0	0	0

PORT_DF CR field descriptions

Field	Description
31–1 Reserved	This field is reserved. This read-only field is reserved and always has the value 0.
0 CS	Clock Source

Table continues on the next page...

PORT_DFCR field descriptions (continued)

Field	Description
	The digital filter configuration is valid in all digital pin muxing modes. Configures the clock source for the digital input filters. Changing the filter clock source must be done only when all digital filters are disabled.
0	Digital filters are clocked by the bus clock.
1	Digital filters are clocked by the LPO clock.

12.5.9 Digital Filter Width Register (PORT_DFWR)

The digital filter configuration is valid in all digital pin muxing modes.

Address: 0h base + C8h offset = C8h

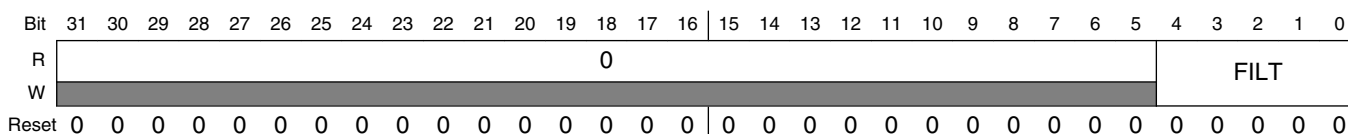

PORT_DFWR field descriptions

Field	Description
31–5 Reserved	This field is reserved. This read-only field is reserved and always has the value 0.
FILT	Filter Length The digital filter configuration is valid in all digital pin muxing modes. Configures the maximum size of the glitches, in clock cycles, that the digital filter absorbs for the enabled digital filters. Glitches that are longer than this register setting will pass through the digital filter, and glitches that are equal to or less than this register setting are filtered. Changing the filter length must be done only after all filters are disabled.

12.6 Functional description

12.6.1 Pin control

Each port pin has a corresponding Pin Control register, PORT_PCRn, associated with it.

The upper half of the Pin Control register configures the pin's capability to either interrupt the CPU or request a DMA transfer, on a rising/falling edge or both edges as well as a logic level occurring on the port pin. It also includes a flag to indicate that an interrupt has occurred.

The lower half of the Pin Control register configures the following functions for each pin within the 32-bit port.

- Pullup or pulldown enable
- Drive strength
- Passive input filter enable
- Pin Muxing mode

The functions apply across all digital pin muxing modes and individual peripherals do not override the configuration in the Pin Control register. For example, if an I²C function is enabled on a pin, that does not override the pullup configuration for that pin.

When the Pin Muxing mode is configured for analog or is disabled, all the digital functions on that pin are disabled. This includes the pullup and pulldown enables, output buffer enable, input buffer enable, and passive filter enable.

The LK bit (bit 15 of Pin Control Register PCR_{*n*}) allows the configuration for each pin to be locked until the next system reset. When locked, writes to the lower half of that pin control register are ignored, although a bus error is not generated on an attempted write to a locked register.

The configuration of each Pin Control register is retained when the PORT module is disabled.

Whenever a pin is configured in any digital pin muxing mode, the input buffer for that pin is enabled allowing the pin state to be read via the corresponding GPIO Port Data Input Register (GPIO_PDIR) or allowing a pin interrupt or DMA request to be generated. If a pin is ever floating when its input buffer is enabled, then this can cause an increase in power consumption and must be avoided. A pin can be floating due to an input pin that is not connected or an output pin that has tri-stated (output buffer is disabled).

Enabling the internal pull resistor (or implementing an external pull resistor) will ensure a pin does not float when its input buffer is enabled; note that the internal pull resistor is automatically disabled whenever the output buffer is enabled allowing the Pull Enable bit to remain set. Configuring the Pin Muxing mode to disabled or analog will disable the pin's input buffer and results in the lowest power consumption.

12.6.2 Global pin control

The two global pin control registers allow a single register write to update the lower half of the pin control register on up to 16 pins, all with the same value. Registers that are locked cannot be written using the global pin control registers.

The global pin control registers are designed to enable software to quickly configure multiple pins within the one port for the same peripheral function. However, the interrupt functions cannot be configured using the global pin control registers.

The global pin control registers are write-only registers, that always read as 0.

12.6.3 Global interrupt control

The two global interrupt control registers allow a single register write to update the upper half of the pin control register on up to 16 pins, all with the same value.

The global interrupt control registers are designed to enable software to quickly configure multiple pins within the one port for the same interrupt configuration. However, the pin control functions cannot be configured using the global interrupt control registers.

The global interrupt control registers are write-only registers and always read as 0.

12.6.4 External interrupts

The external interrupt capability of the PORT module is available in all digital pin muxing modes provided the PORT module is enabled.

Each pin can be individually configured for any of the following external interrupt modes:

- Interrupt disabled, default out of reset
- Active high level sensitive interrupt
- Active low level sensitive interrupt
- Rising edge sensitive interrupt
- Falling edge sensitive interrupt
- Rising and falling edge sensitive interrupt
- Rising edge sensitive DMA request
- Falling edge sensitive DMA request
- Rising and falling edge sensitive DMA request

The interrupt status flag is set when the configured edge or level is detected on the pin or at the output of the digital input filter, if the digital input digital filter is enabled. When not in Stop mode, the input is first synchronized to the bus clock to detect the configured level or edge transition.

The PORT module generates a single interrupt that asserts when the interrupt status flag is set for any enabled interrupt for that port. The interrupt negates after the interrupt status flags for all enabled interrupts have been cleared by writing a logic 1 to the ISF flag in either the PORT_ISFR or PORT_PCRn registers.

The PORT module generates a single DMA request that asserts when the interrupt status flag is set for any enabled DMA request in that port. The DMA request negates after the DMA transfer is completed, because that clears the interrupt status flags for all enabled DMA requests.

During Stop mode, the interrupt status flag for any enabled interrupt is asynchronously set if the required level or edge is detected. This also generates an asynchronous wake-up signal to exit the Low-Power mode.

12.6.5 Digital filter

The digital filter capabilities of the PORT module are available in all digital Pin Muxing modes if the PORT module is enabled.

The clock used for all digital filters within one port can be configured between the bus clock or the LPO clock. This selection must be changed only when all digital filters for that port are disabled. If the digital filters for a port are configured to use the bus clock, then the digital filters are bypassed for the duration of Stop mode. While the digital filters are bypassed, the output of each digital filter always equals the input pin, but the internal state of the digital filters remains static and does not update due to any change on the input pin.

The filter width in clock size is the same for all enabled digital filters within one port and must be changed only when all digital filters for that port are disabled.

The output of each digital filter is logic zero after system reset and whenever a digital filter is disabled. After a digital filter is enabled, the input is synchronized to the filter clock, either the bus clock or the LPO clock. If the synchronized input and the output of the digital filter remain different for a number of filter clock cycles equal to the filter width register configuration, then the output of the digital filter updates to equal the synchronized filter input.

The maximum latency through a digital filter equals three filter clock cycles plus the filter width configuration register.

Chapter 13

General-Purpose Input/Output (GPIO)

13.1 Chip-specific GPIO information

13.1.1 Instantiation information

Port control and interrupt module features are supported, each 32-pin port will support a single interrupt. Not all pins are available on each package supported. See IO Signal Description Input Multiplexing sheet(s) attached to the Reference Manual for the details on which pins are supported in different packages. See [Port Control and Interrupts \(PORT\)](#) for details of how to control the ports.

See [Module operation in available power modes](#) for details on available power modes.

13.1.2 GPIO ports memory map

This chip implements five instances of GPIOs GPIOA to GPIOE. The [GPIO register descriptions](#) in this chapter are generic. Refer to the table below to see how addresses are allocated to every instance of GPIO in the device memory map.

Table 13-1. GPIO ports memory map

Start address	Port
Base + 0h	Port A
Base + 40h	Port B
Base + 80h	Port C
Base + C0h	Port D
Base + 100h	Port E

NOTE

- In S32K14x, GPIO can only be accessed by the core through the cross bar interface at 0x400F_F000.

- In S32K11x, GPIO is multi-ported and can be accessed directly by the core with zero wait states at base address $[0xF800_0000 + 0x40*n]$ (n: 0 to 4). It can also be accessed by the core through the cross bar/AIPS interface at $[0x400F_F000 + 0x40*n]$ (n: 0 to 4) and at an aliased slot (15) at address $[0x4000_F000 + 0x40*n]$ (n: 0 to 4).
- In S32K11x, when in GPIO mode (PORT_PCRn[MUX] programmed to 0x1), the register PIDR cannot be written to 0x1. This programming helps to disable the input mode and this is not possible to achieve in S32K11x. The implication of this is that when the GPIO is configured in output mode (PDDR[n] programmed to 1), the data written on PDOR register would be reflected on PDIR after some delay if the output does not toggle to often. If the pad needs to be tri-stated, the PORT_PCRn[MUX] needs to be 00.

	GPIO at 0x400FF000	GPIO at 0x4000F000	GPIO at 0xF8000000
S32K14x	Accessible in CPO mode	NA	NA
S32K11x	Not accessible in CPO mode	Not accessible in CPO mode	Accessible in CPO mode

13.1.3 GPIO register reset values

Following table defines the chip-specific register reset value.

Table 13-2. GPIO register reset values

Register	Reset value
PDIR	0000_0020

13.2 Introduction

The general-purpose input and output (GPIO) module communicates to the processor core via a zero wait state interface for maximum pin performance. The GPIO registers support 8-bit, 16-bit or 32-bit accesses.

The GPIO data direction and output data registers control the direction and output data of each pin when the pin is configured for the GPIO function. The GPIO input data register displays the logic value on each pin when the pin is configured for any digital function, provided the corresponding Port Control and Interrupt module for that pin is enabled.

Efficient bit manipulation of the general-purpose outputs is supported through the addition of set, clear, and toggle write-only registers for each port output data register.

13.2.1 Features

Features of the GPIO module include:

- Port Data Input register visible in all digital pin-multiplexing modes
- Port Data Output register with corresponding set/clear/toggle registers
- Port Data Direction register

NOTE

The GPIO module is clocked by system clock.

13.2.2 Modes of operation

The following table depicts different modes of operation and the behavior of the GPIO module in these modes.

Table 13-3. Modes of operation

Modes of operation	Description
Run	The GPIO module operates normally.
Stop	The GPIO module is disabled.
Debug	The GPIO module operates normally.

13.2.3 GPIO signal descriptions

Table 13-4. GPIO signal descriptions

GPIO signal descriptions	Description	I/O
PORTA31–PORTA0	General-purpose input/output	I/O
PORTB31–PORTB0	General-purpose input/output	I/O
PORTC31–PORTC0	General-purpose input/output	I/O
PORTD31–PORTD0	General-purpose input/output	I/O
PORTE31–PORTE0	General-purpose input/output	I/O

NOTE

Not all pins within each port are implemented on each device. See the chapter on signal multiplexing for the number of GPIO ports available in the device.

13.2.3.1 Detailed signal description

Table 13-5. GPIO interface-detailed signal descriptions

Signal	I/O	Description	
PORTA31–PORTA0	I/O	General-purpose input/output	
PORTB31–PORTB0		State meaning	Asserted: The pin is logic 1. Deasserted: The pin is logic 0.
PORTC31–PORTC0		Timing	Assertion: When output, this signal occurs on the rising-edge of the system clock. For input, it may occur at any time and input may be asserted asynchronously to the system clock. Deassertion: When output, this signal occurs on the rising-edge of the system clock. For input, it may occur at any time and input may be asserted asynchronously to the system clock.
PORTD31–PORTD0			
PORTE31–PORTE0			

NOTE

Not all pins within each port are implemented on each device. See the chapter on signal multiplexing for the number of GPIO ports available in the device.

13.3 Memory map and register definition

The registers for each GPIO port occupy 64-byte of the memory map. Any read or write access to the GPIO slot outside this space results in a bus error.

NOTE

For simplicity, each GPIO port's registers appear with the same width of 32 bits, corresponding to 32 pins. The actual number of pins per port (and therefore the number of usable control bits per port register) is chip-specific. Refer to the chip-specific GPIO information to see the exact control bits for each port.

13.3.1 GPIO register descriptions

13.3.1.1 GPIO memory map

GPIOA base address: 400F_F000h

GPIOB base address: 400F_F040h

GPIOC base address: 400F_F080h

GIOD base address: 400F_F0C0h

GPIOE base address: 400F_F100h

Offset	Register	Width (In bits)	Access	Reset value
0h	Port Data Output Register (PDOR)	32	RW	0000_0000h
4h	Port Set Output Register (PSOR)	32	WORZ	0000_0000h
8h	Port Clear Output Register (PCOR)	32	WORZ	0000_0000h
Ch	Port Toggle Output Register (PTOR)	32	WORZ	0000_0000h
10h	Port Data Input Register (PDIR)	32	RO	0000_0000h
14h	Port Data Direction Register (PDDR)	32	RW	0000_0000h
18h	Port Input Disable Register (PIDR)	32	RW	0000_0000h

13.3.1.2 Port Data Output Register (PDOR)

13.3.1.2.1 Offset

Register	Offset
PDOR	0h

13.3.1.2.2 Function

This register configures the logic levels that are driven on each general-purpose output pin.

NOTE

Do not modify pin configuration registers associated with pins not available in your selected package. All unbonded pins not available in your package will default to DISABLE state for lowest power consumption.

13.3.1.2.3 Diagram

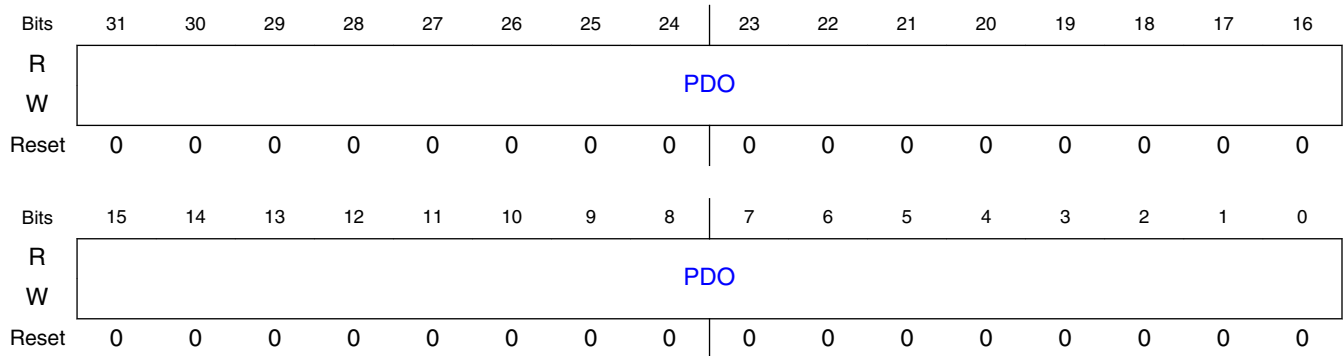

13.3.1.2.4 Fields

Field	Function
31-0	Port Data Output
PDO	Register bits for unbonded pins return an undefined value when read. 0b - Logic level 0 is driven on pin, provided pin is configured for general-purpose output. 1b - Logic level 1 is driven on pin, provided pin is configured for general-purpose output.

13.3.1.3 Port Set Output Register (PSOR)

13.3.1.3.1 Offset

Register	Offset
PSOR	4h

13.3.1.3.2 Function

This register configures whether to set the fields of the PDOR.

13.3.1.3.3 Diagram

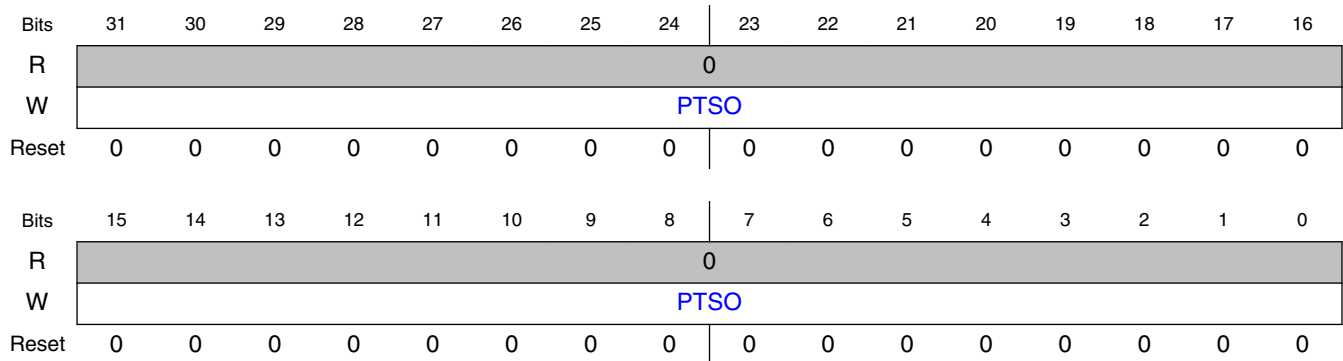

13.3.1.3.4 Fields

Field	Function
31-0	Port Set Output
PTSO	Writing to this register updates the contents of the corresponding bit in the PDOR as follows: 0b - Corresponding bit in PDORn does not change. 1b - Corresponding bit in PDORn is set to logic 1.

13.3.1.4 Port Clear Output Register (PCOR)

13.3.1.4.1 Offset

Register	Offset
PCOR	8h

13.3.1.4.2 Function

This register configures whether to clear the fields of PDOR.

13.3.1.4.3 Diagram

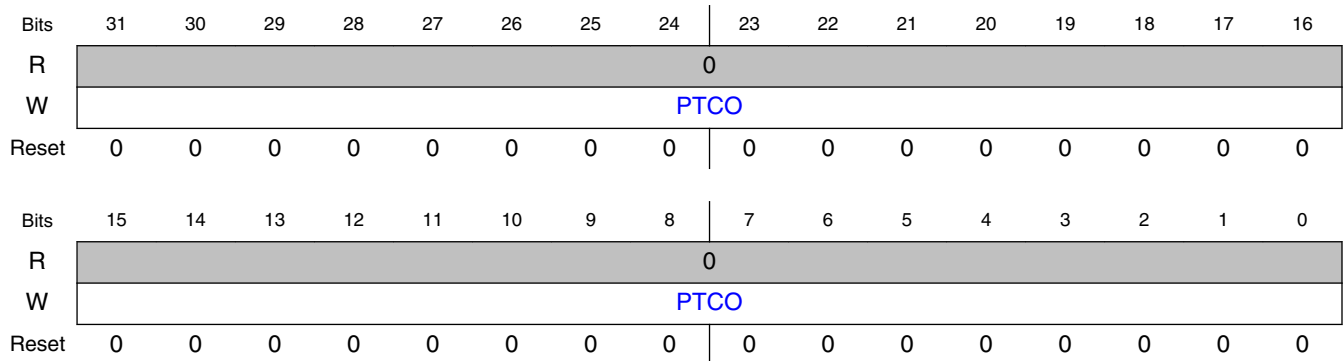

13.3.1.4.4 Fields

Field	Function
31-0	Port Clear Output
PTCO	Writing to this register updates the contents of the corresponding bit in the Port Data Output Register (PDOR) as follows: 0b - Corresponding bit in PDORn does not change. 1b - Corresponding bit in PDORn is cleared to logic 0.

13.3.1.5 Port Toggle Output Register (PTOR)

13.3.1.5.1 Offset

Register	Offset
PTOR	Ch

13.3.1.5.2 Function

This register toggles the logic levels that are driven on each general-purpose output pin.

13.3.1.5.3 Diagram

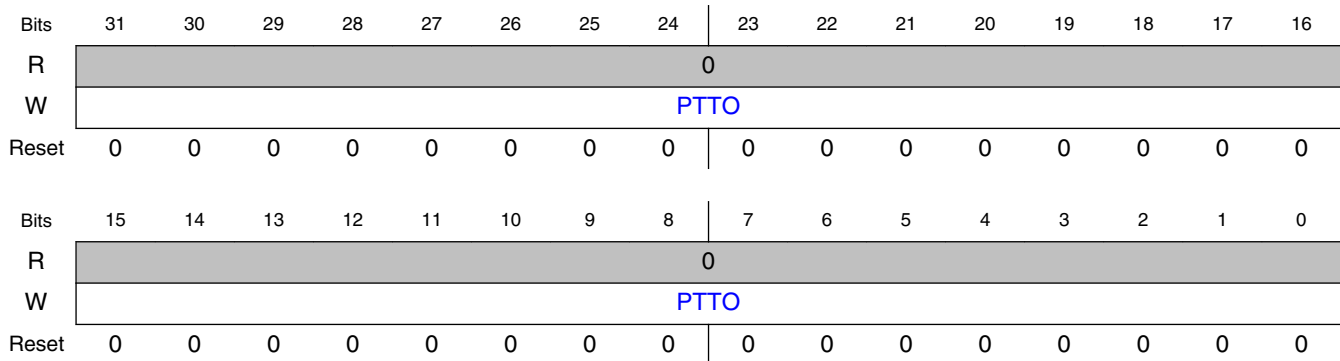

13.3.1.5.4 Fields

Field	Function
31-0	Port Toggle Output
PTTO	Writing to this register updates the contents of the corresponding bit in the PDOR as follows: 0b - Corresponding bit in PDORn does not change. 1b - Corresponding bit in PDORn is set to the inverse of its existing logic state.

13.3.1.6 Port Data Input Register (PDIR)

13.3.1.6.1 Offset

Register	Offset
PDIR	10h

13.3.1.6.2 Function

This register captures the logic levels that are driven into each general-purpose input pin.

NOTE

Do not modify pin configuration registers associated with pins not available in your selected package. All unbonded pins not available in your package will default to DISABLE state for lowest power consumption.

13.3.1.6.3 Diagram

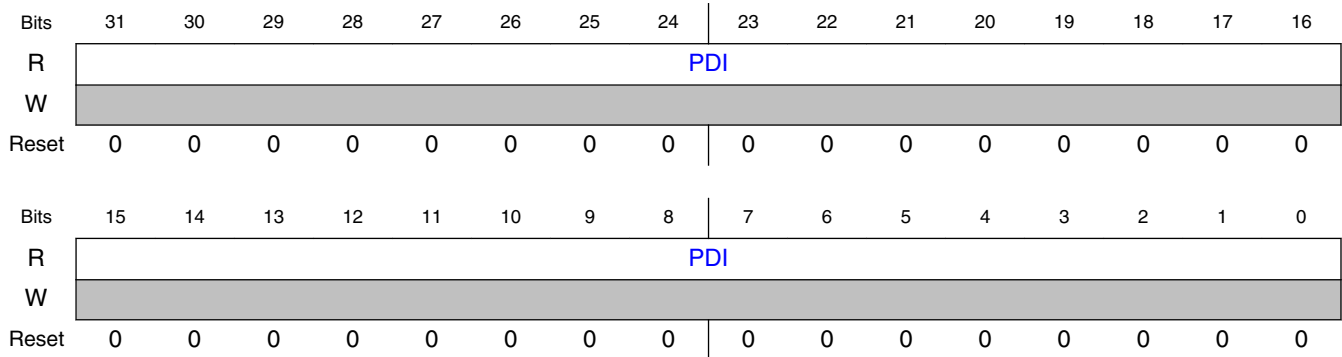

13.3.1.6.4 Fields

Field	Function
31-0 PDI	Port Data Input Reads 0 at the unimplemented pins for a particular device. Pins that are not configured for a digital function read 0. If the Port Control and Interrupt module is disabled, then the corresponding bit in PDIR does not update. 0b - Pin logic level is logic 0, or is not configured for use by digital function. 1b - Pin logic level is logic 1.

13.3.1.7 Port Data Direction Register (PDDR)

13.3.1.7.1 Offset

Register	Offset
PDDR	14h

13.3.1.7.2 Function

The PDDR configures the individual port pins for input or output.

13.3.1.7.3 Diagram

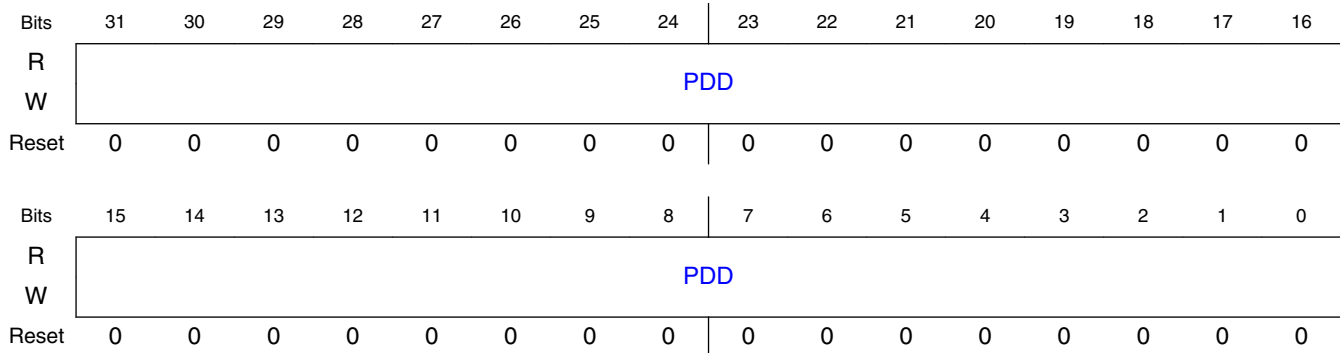

13.3.1.7.4 Fields

Field	Function
31-0 PDD	Port Data Direction Configures individual port pins for input or output. 0b - Pin is configured as general-purpose input, for the GPIO function. The pin will be high-Z if the port input is disabled in GPIOx_PIDR register. 1b - Pin is configured as general-purpose output, for the GPIO function.

13.3.1.8 Port Input Disable Register (PIDR)

13.3.1.8.1 Offset

Register	Offset
PIDR	18h

13.3.1.8.2 Function

This register disables each general-purpose pin from acting as an input.

13.3.1.8.3 Diagram

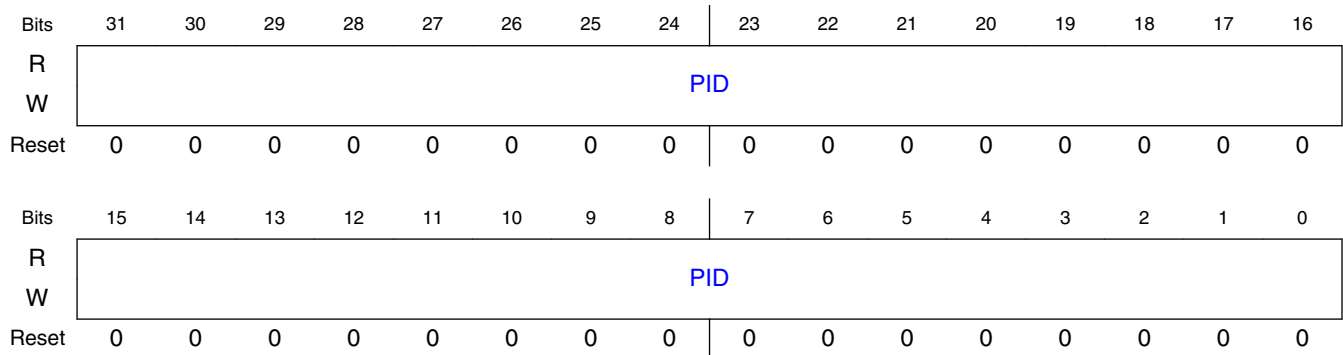

13.3.1.8.4 Fields

Field	Function
31-0	Port Input Disable
PID	0b - Pin is configured for General Purpose Input, provided the pin is configured for any digital function. 1b - Pin is not configured as General Purpose Input. Corresponding Port Data Input Register bit will read zero.

13.4 Functional description

13.4.1 General-purpose input

The logic state of each pin is available via the Port Data Input registers, provided the corresponding bit in the port input enable register is set, the pin is configured for a digital function and the corresponding Port Control and Interrupt module is enabled.

The input pin synchronizers are shared with the Port Control and Interrupt module, so that if the corresponding Port Control and Interrupt module is disabled, then synchronizers are also disabled. This reduces power consumption when a port is not required for general-purpose input functionality.

13.4.2 General-purpose output

The logic state of each pin can be controlled via the port data output registers and port data direction registers, provided the pin is configured for the GPIO function. The following table depicts the conditions for a pin to be configured as input/output.

If	Then
A pin is configured for the GPIO function and the corresponding port data direction register bit is clear.	The pin is configured as an input.
A pin is configured for the GPIO function and the corresponding port data direction register bit is set.	The pin is configured as an output and the logic state of the pin is equal to the corresponding port data output register.

To facilitate efficient bit manipulation on the general-purpose outputs, pin data set, pin data clear, and pin data toggle registers exist to allow one or more outputs within one port to be set, cleared, or toggled from a single register write.

The corresponding Port Control and Interrupt module does not need to be enabled to update the state of the port data direction registers and port data output registers including the set/clear/toggle registers.

Chapter 14

Crossbar Switch Lite (AXBS-Lite)

14.1 Chip-specific AXBS-Lite information

14.1.1 Crossbar Switch master assignments

The following table identifies the masters connected to the Crossbar Switch and their priority order in fixed-priority mode.

Table 14-1. Master port assignments and priority order for fixed-priority arbitration

Chips	Master port number 0	Master port number 1	Master port number 2	Master port number 3
	Priority 3 ¹	Priority 2 ¹	Priority 1 ¹	Priority 4 ¹
S32K148	Arm core code bus	Arm core system bus	DMA	ENET
S32K146	Arm core code bus	Arm core system bus	DMA	-
S32K144	Arm core code bus	Arm core system bus	DMA	
S32K144W	Arm core code bus	Arm core system bus	DMA	
S32K142	Arm core code bus	Arm core system bus	DMA	
S32K116	Arm core master bus	-	DMA	
S32K118	Arm core master bus	-	DMA	

1. Priority in fixed-priority mode. MCM controls mode selection for global slave port arbitration. For fixed priority, set MCM_CPCR[CBRR] to 0. For round robin, set MCM_CPCR[CBRR] to 1. The arbitration setting applies to all slave ports.

NOTE

For configuring the bit field MCM_CPCR[CBRR], see the note present in the [CBRR](#).

14.1.2 Crossbar Switch slave assignments

The following table identifies the slaves connected to the Crossbar Switch and whether the system MPU protects them.

Table 14-2. Slave port assignments and system MPU protection

Chips	Slave port number 0	Slave port number 1	Slave port number 2	Slave port number 3
S32K148	Flash memory controller ¹	SRAM controllers ¹	Peripheral Bridge 0/ GPIO ²	QuadSPI ¹
S32K146	Flash memory controller ¹	SRAM controllers ¹	Peripheral Bridge 0/ GPIO ²	-
S32K144	Flash memory controller ¹	SRAM controllers ¹	Peripheral Bridge 0/ GPIO ²	
S32K144W	Flash memory controller ¹	SRAM controllers ¹	Peripheral Bridge 0/ GPIO ²	
S32K142	Flash memory controller ¹	SRAM controllers ¹	Peripheral Bridge 0/ GPIO ²	
S32K116	Flash memory controller ¹	SRAM controllers ¹	Peripheral Bridge 0/ GPIO ²	
S32K118	Flash memory controller ¹	SRAM controllers ¹	Peripheral Bridge 0/ GPIO ²	

1. Protected by system MPU

2. Not protected by system MPU: System MPU does not protect access to peripheral registers, including system MPU's own registers. Protection is built into Peripheral Bridge (AIPS-Lite).

14.2 Introduction

The information found here provides information on the layout, configuration, and programming of the crossbar switch.

The crossbar switch connects bus masters and bus slaves using a crossbar switch structure. This structure allows up to four bus masters to access different bus slaves simultaneously, while providing arbitration among the bus masters when they access the same slave.

14.2.1 Features

The crossbar switch includes these features:

- Symmetric crossbar bus switch implementation
 - Allows concurrent accesses from different masters to different slaves
- Up to single-clock 32-bit transfer
- Programmable configuration for fixed-priority or round-robin slave port arbitration (see the chip-specific information).

14.3 Functional Description

Information about general operation and arbitration can be found here.

14.3.1 General operation

When a master accesses the crossbar switch, the access is immediately taken. If the targeted slave port of the access is available, then the access is immediately presented on the slave port. Single-clock or zero-wait-state accesses are possible through the crossbar. If the targeted slave port of the access is busy or parked on a different master port, the requesting master simply sees wait states inserted until the targeted slave port can service the master's request. The latency in servicing the request depends on each master's priority level and the responding slave's access time.

Because the crossbar switch appears to be just another slave to the master device, the master device has no knowledge of whether it actually owns the slave port it is targeting. While the master does not have control of the slave port it is targeting, it simply waits.

After the master has control of the slave port it is targeting, the master remains in control of the slave port until it relinquishes the slave port by running an IDLE cycle or by targeting a different slave port for its next access.

The master can also lose control of the slave port if another higher-priority master makes a request to the slave port.

The crossbar terminates all master IDLE transfers, as opposed to allowing the termination to come from one of the slave buses. Additionally, when no master is requesting access to a slave port, the crossbar drives IDLE transfers onto the slave bus, even though a default master may be granted access to the slave port.

When a slave bus is being idled by the crossbar, it remains parked with the last master to use the slave port. This is done to save the initial clock of arbitration delay that otherwise would be seen if the same master had to arbitrate to gain control of the slave port.

14.3.2 Arbitration

The crossbar switch supports two arbitration algorithms:

- Fixed priority
- Round-robin

The selection of the global slave port arbitration algorithm is described in the crossbar switch chip-specific information.

14.3.2.1 Arbitration during undefined length bursts

Undefined length bursts can be interrupted.

14.3.2.2 Fixed-priority operation

When operating in fixed-priority mode, each master is assigned a unique priority level with the highest numbered master having the highest priority (for example, in a system with 5 masters, master 1 has lower priority than master 3). If two masters request access to the same slave port, the master with the highest priority gains control over the slave port.

NOTE

In this arbitration mode, a higher-priority master can monopolize a slave port, preventing accesses from any lower-priority master to the port.

When a master makes a request to a slave port, the slave port checks whether the new requesting master's priority level is higher than that of the master that currently has control over the slave port, unless the slave port is in a parked state. The slave port performs an arbitration check at every clock edge to ensure that the proper master, if any, has control of the slave port.

The following table describes possible scenarios based on the requesting master port:

Table 14-3. How the Crossbar Switch grants control of a slave port to a master

When	Then the Crossbar Switch grants control to the requesting master
Both of the following are true: <ul style="list-style-type: none"> The current master is not running a transfer. The new requesting master's priority level is higher than that of the current master. 	At the next clock edge
Both of the following are true: <ul style="list-style-type: none"> The current master is running an undefined length burst transfer. The requesting master's priority level is higher than that of the current master. 	At the next arbitration point for the undefined length burst transfer
The requesting master's priority level is lower than the current master.	At the conclusion of one of the following cycles: <ul style="list-style-type: none"> An IDLE cycle A non-IDLE cycle to a location other than the current slave port

14.3.2.3 Round-robin priority operation

When operating in round-robin mode, each master is assigned a relative priority based on the master port number. This relative priority is compared to the master port number (ID) of the last master to perform a transfer on the slave bus. The highest priority requesting master becomes owner of the slave bus at the next transfer boundary. Priority is based on how far ahead the ID of the requesting master is to the ID of the last master.

After granted access to a slave port, a master may perform as many transfers as desired to that port until another master makes a request to the same slave port. The next master in line is granted access to the slave port at the next transfer boundary, or possibly on the next clock cycle if the current master has no pending access request.

As an example of arbitration in round-robin mode, assume the crossbar is implemented with master ports 0, 1, 4, and 5. If the last master of the slave port was master 1, and master 0, 4, and 5 make simultaneous requests, they are serviced in the order: 4 then 5 then 0.

The round-robin arbitration mode generally provides a more fair allocation of the available slave-port bandwidth (compared to fixed priority) as the fixed master priority does not affect the master selection.

14.4 Initialization/application information

No initialization is required for the crossbar switch.

Chapter 15

Memory Protection Unit (MPU)

15.1 Chip-specific MPU information

On this device, NXP's system MPU implements the safety mechanisms to prevent masters from accessing restricted memory regions. This system MPU provides memory protection at the level of the Crossbar Switch. Each Crossbar master (Core, DMA, Ethernet) can be assigned different access rights to each protected memory region. The Arm M4 and M0+ core version in this family does not integrate the Arm Core MPU, which would concurrently monitor only core-initiated memory accesses. In this document, the term MPU refers to NXP's system MPU.

NOTE

RGD0_WORD2[M1PE] bit field is not used in S32K116 and S31K118.

15.1.1 MPU Slave Port Assignments

The memory-mapped resources protected by the MPU are:

Table 15-1. MPU Slave Port Assignments For S32K14x and S32K14xW series

Source	MPU Slave Port Assignment	Destination
Crossbar slave port 0	MPU slave port 0	Flash Controller
Crossbar slave port 1	MPU slave port 1	SRAM backdoor
Code Bus	MPU slave port 2	SRAM_L frontdoor
System Bus	MPU slave port 3	SRAM_U frontdoor
Crossbar slave port 3	MPU Slave port 4	QuadSPI

Table 15-2. MPU Slave Port Assignments for S32K11x series

Source	MPU Slave Port Assignment	Destination
Crossbar slave port 0	MPU slave port 0	Flash Controller
Crossbar slave port 1	MPU slave port 1	SRAM controller/MTB_RAM/MCM

15.1.2 MPU Logical Bus Master Assignments

The logical bus master assignments for the MPU are:

Table 15-3. MPU Logical Bus Master Assignments

MPU Logical Bus Master ID	Bus Master	Possible access types							PID available
		User	Supervisor	Data	Instruction	Read	Write	Execute	
0	Core	✓	✓	✓	✓	✓	✓	✓	✓
1	Debugger	✓	✓	✓	✓	✓	✓	✓	✓
2	DMA	-	✓	✓	-	✓	✓	-	-
3	ENET	✓	-	✓	-	✓	✓	-	-
4-7	Not implemented. The region descriptor register fields for these master IDs are Reserved.								

15.1.3 Current PID

Current PID is configured at Miscellaneous Control Module Process ID register (MCM_PID).

15.1.4 Region descriptors and slave port configuration

For each chip in the product series, the following table shows the numbers of region descriptors and slave ports as well as the reset value of [Control/Error Status Register \(CESR\)](#) that reflects those numbers.

Table 15-4. MPU configurations

Chips	Region descriptors	Slave ports	CESR reset value
S32K116	8	2	0081_2001
S32K118	8	2	0081_2001
S32K142	8	4	0081_4001h

Table continues on the next page...

Table 15-4. MPU configurations (continued)

Chips	Region descriptors	Slave ports	CESR reset value
S32K144	8	4	0081_4001h
S32K144W	8	4	0081_4001h
S32K146	8	4	0081_4001h
S32K148	16	5	0081_5201h

15.2 Introduction

The memory protection unit (MPU) provides hardware access control for all memory references generated in the device.

15.3 Overview

The MPU concurrently monitors all system bus transactions and evaluates their appropriateness using pre-programmed region descriptors that define memory spaces and their access rights. Memory references that have sufficient access control rights are allowed to complete, while references that are not mapped to any region descriptor or have insufficient rights are terminated with a protection error response.

15.3.1 Block diagram

A simplified block diagram of the MPU module is shown in the following figure.

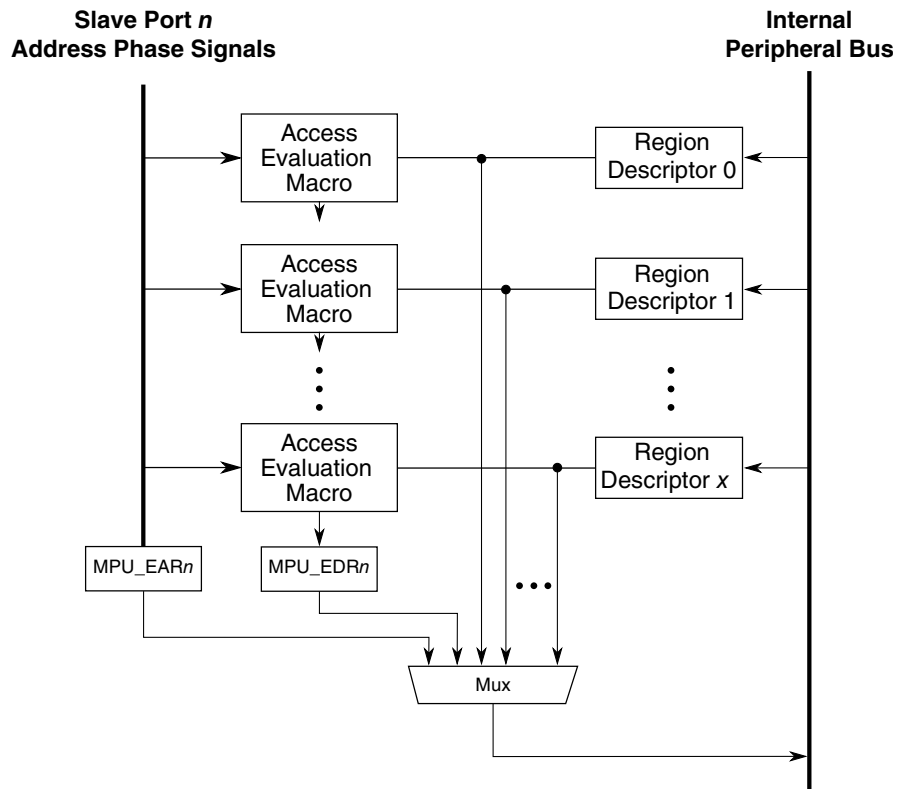

Figure 15-1. MPU block diagram

The hardware's two-dimensional connection matrix is clearly visible with the basic access evaluation macro shown as the replicated submodule block. The crossbar switch slave ports are shown on the left, the region descriptor registers in the middle, and the peripheral bus interface on the right side. The evaluation macro contains two magnitude comparators connected to the start and end address registers from each region descriptor as well as the combinational logic blocks to determine the region hit and the access protection error. For details of the access evaluation macro, see [Access evaluation macro](#).

15.3.2 Features

The MPU implements a two-dimensional hardware array of memory region descriptors and the crossbar slave ports to continuously monitor the legality of every memory reference generated by each bus master in the system.

The feature set includes:

- 16 program-visible 128-bit region descriptors, accessible by four 32-bit words each
 - Each region descriptor defines a modulo-32 byte space, aligned anywhere in memory

- Region sizes can vary from 32 bytes to 4 Gbytes
- Two access control permissions defined in a single descriptor word
 - Masters 0–3: read, write, and execute attributes for supervisor and user accesses
 - Masters 4–7: read and write attributes
- Hardware-assisted maintenance of the descriptor valid bit minimizes coherency issues
- Alternate programming model view of the access control permissions word
- Priority given to granting permission over denying access for overlapping region descriptors
- Detects access protection errors if a memory reference does not hit in any memory region, or if the reference is illegal in all hit memory regions. If an access error occurs, the reference is terminated with an error response, and the MPU inhibits the bus cycle being sent to the targeted slave device.
- Error registers, per slave port, capture the last faulting address, attributes, and other information
- Global MPU enable/disable control bit

15.4 MPU register descriptions

The programming model is partitioned into three groups:

- Control/status registers
- The data structure containing the region descriptors
- The alternate view of the region descriptor access control values

The programming model can be referenced using only 32-bit accesses. The programming model can be accessed only in supervisor mode.

Attempted references of the following types generate an error termination:

- Non-32-bit references
- Accesses in user mode

MPU register descriptions

- References to undefined—that is, reserved—addresses
- References with a non-supported access type, such as a write access to a read-only register or a read access of a write-only register

15.4.1 MPU memory map

MPU base address: 4000_D000h

Offset	Register	Width (In bits)	Access	Reset value
0h	Control/Error Status Register (CESR)	32	RW	0081_5201h
10h	Error Address Register, slave port 0 (EAR0)	32	RO	0000_0000h
14h	Error Detail Register, slave port 0 (EDR0)	32	RO	0000_0000h
18h	Error Address Register, slave port 1 (EAR1)	32	RO	0000_0000h
1Ch	Error Detail Register, slave port 1 (EDR1)	32	RO	0000_0000h
20h	Error Address Register, slave port 2 (EAR2)	32	RO	0000_0000h
24h	Error Detail Register, slave port 2 (EDR2)	32	RO	0000_0000h
28h	Error Address Register, slave port 3 (EAR3)	32	RO	0000_0000h
2Ch	Error Detail Register, slave port 3 (EDR3)	32	RO	0000_0000h
30h	Error Address Register, slave port 4 (EAR4)	32	RO	0000_0000h
34h	Error Detail Register, slave port 4 (EDR4)	32	RO	0000_0000h
400h	Region Descriptor 0, Word 0 (RGD0_WORD0)	32	RW	0000_0000h
404h	Region Descriptor 0, Word 1 (RGD0_WORD1)	32	RW	FFFF_FFFFh
408h	Region Descriptor 0, Word 2 (RGD0_WORD2)	32	RW	0061_F7DFh
40Ch	Region Descriptor 0, Word 3 (RGD0_WORD3)	32	RW	0000_0001h
410h	Region Descriptor 1, Word 0 (RGD1_WORD0)	32	RW	0000_0000h
414h	Region Descriptor 1, Word 1 (RGD1_WORD1)	32	RW	0000_001Fh
418h	Region Descriptor 1, Word 2 (RGD1_WORD2)	32	RW	0000_0000h
41Ch	Region Descriptor 1, Word 3 (RGD1_WORD3)	32	RW	0000_0000h
420h	Region Descriptor 2, Word 0 (RGD2_WORD0)	32	RW	0000_0000h
424h	Region Descriptor 2, Word 1 (RGD2_WORD1)	32	RW	0000_001Fh
428h	Region Descriptor 2, Word 2 (RGD2_WORD2)	32	RW	0000_0000h
42Ch	Region Descriptor 2, Word 3 (RGD2_WORD3)	32	RW	0000_0000h
430h	Region Descriptor 3, Word 0 (RGD3_WORD0)	32	RW	0000_0000h
434h	Region Descriptor 3, Word 1 (RGD3_WORD1)	32	RW	0000_001Fh
438h	Region Descriptor 3, Word 2 (RGD3_WORD2)	32	RW	0000_0000h
43Ch	Region Descriptor 3, Word 3 (RGD3_WORD3)	32	RW	0000_0000h
440h	Region Descriptor 4, Word 0 (RGD4_WORD0)	32	RW	0000_0000h
444h	Region Descriptor 4, Word 1 (RGD4_WORD1)	32	RW	0000_001Fh
448h	Region Descriptor 4, Word 2 (RGD4_WORD2)	32	RW	0000_0000h

Table continues on the next page...

Offset	Register	Width (In bits)	Access	Reset value
44Ch	Region Descriptor 4, Word 3 (RGD4_WORD3)	32	RW	0000_0000h
450h	Region Descriptor 5, Word 0 (RGD5_WORD0)	32	RW	0000_0000h
454h	Region Descriptor 5, Word 1 (RGD5_WORD1)	32	RW	0000_001Fh
458h	Region Descriptor 5, Word 2 (RGD5_WORD2)	32	RW	0000_0000h
45Ch	Region Descriptor 5, Word 3 (RGD5_WORD3)	32	RW	0000_0000h
460h	Region Descriptor 6, Word 0 (RGD6_WORD0)	32	RW	0000_0000h
464h	Region Descriptor 6, Word 1 (RGD6_WORD1)	32	RW	0000_001Fh
468h	Region Descriptor 6, Word 2 (RGD6_WORD2)	32	RW	0000_0000h
46Ch	Region Descriptor 6, Word 3 (RGD6_WORD3)	32	RW	0000_0000h
470h	Region Descriptor 7, Word 0 (RGD7_WORD0)	32	RW	0000_0000h
474h	Region Descriptor 7, Word 1 (RGD7_WORD1)	32	RW	0000_001Fh
478h	Region Descriptor 7, Word 2 (RGD7_WORD2)	32	RW	0000_0000h
47Ch	Region Descriptor 7, Word 3 (RGD7_WORD3)	32	RW	0000_0000h
480h	Region Descriptor 8, Word 0 (RGD8_WORD0)	32	RW	0000_0000h
484h	Region Descriptor 8, Word 1 (RGD8_WORD1)	32	RW	0000_001Fh
488h	Region Descriptor 8, Word 2 (RGD8_WORD2)	32	RW	0000_0000h
48Ch	Region Descriptor 8, Word 3 (RGD8_WORD3)	32	RW	0000_0000h
490h	Region Descriptor 9, Word 0 (RGD9_WORD0)	32	RW	0000_0000h
494h	Region Descriptor 9, Word 1 (RGD9_WORD1)	32	RW	0000_001Fh
498h	Region Descriptor 9, Word 2 (RGD9_WORD2)	32	RW	0000_0000h
49Ch	Region Descriptor 9, Word 3 (RGD9_WORD3)	32	RW	0000_0000h
4A0h	Region Descriptor 10, Word 0 (RGD10_WORD0)	32	RW	0000_0000h
4A4h	Region Descriptor 10, Word 1 (RGD10_WORD1)	32	RW	0000_001Fh
4A8h	Region Descriptor 10, Word 2 (RGD10_WORD2)	32	RW	0000_0000h
4ACh	Region Descriptor 10, Word 3 (RGD10_WORD3)	32	RW	0000_0000h
4B0h	Region Descriptor 11, Word 0 (RGD11_WORD0)	32	RW	0000_0000h
4B4h	Region Descriptor 11, Word 1 (RGD11_WORD1)	32	RW	0000_001Fh
4B8h	Region Descriptor 11, Word 2 (RGD11_WORD2)	32	RW	0000_0000h
4BCh	Region Descriptor 11, Word 3 (RGD11_WORD3)	32	RW	0000_0000h
4C0h	Region Descriptor 12, Word 0 (RGD12_WORD0)	32	RW	0000_0000h
4C4h	Region Descriptor 12, Word 1 (RGD12_WORD1)	32	RW	0000_001Fh
4C8h	Region Descriptor 12, Word 2 (RGD12_WORD2)	32	RW	0000_0000h
4CCh	Region Descriptor 12, Word 3 (RGD12_WORD3)	32	RW	0000_0000h
4D0h	Region Descriptor 13, Word 0 (RGD13_WORD0)	32	RW	0000_0000h
4D4h	Region Descriptor 13, Word 1 (RGD13_WORD1)	32	RW	0000_001Fh
4D8h	Region Descriptor 13, Word 2 (RGD13_WORD2)	32	RW	0000_0000h
4DCh	Region Descriptor 13, Word 3 (RGD13_WORD3)	32	RW	0000_0000h
4E0h	Region Descriptor 14, Word 0 (RGD14_WORD0)	32	RW	0000_0000h
4E4h	Region Descriptor 14, Word 1 (RGD14_WORD1)	32	RW	0000_001Fh
4E8h	Region Descriptor 14, Word 2 (RGD14_WORD2)	32	RW	0000_0000h

Table continues on the next page...

MPU register descriptions

Offset	Register	Width (In bits)	Access	Reset value
4ECh	Region Descriptor 14, Word 3 (RGD14_WORD3)	32	RW	0000_0000h
4F0h	Region Descriptor 15, Word 0 (RGD15_WORD0)	32	RW	0000_0000h
4F4h	Region Descriptor 15, Word 1 (RGD15_WORD1)	32	RW	0000_001Fh
4F8h	Region Descriptor 15, Word 2 (RGD15_WORD2)	32	RW	0000_0000h
4FCh	Region Descriptor 15, Word 3 (RGD15_WORD3)	32	RW	0000_0000h
800h	Region Descriptor Alternate Access Control 0 (RGDAAC0)	32	RW	0061_F7DFh
804h	Region Descriptor Alternate Access Control 1 (RGDAAC1)	32	RW	0000_0000h
808h	Region Descriptor Alternate Access Control 2 (RGDAAC2)	32	RW	0000_0000h
80Ch	Region Descriptor Alternate Access Control 3 (RGDAAC3)	32	RW	0000_0000h
810h	Region Descriptor Alternate Access Control 4 (RGDAAC4)	32	RW	0000_0000h
814h	Region Descriptor Alternate Access Control 5 (RGDAAC5)	32	RW	0000_0000h
818h	Region Descriptor Alternate Access Control 6 (RGDAAC6)	32	RW	0000_0000h
81Ch	Region Descriptor Alternate Access Control 7 (RGDAAC7)	32	RW	0000_0000h
820h	Region Descriptor Alternate Access Control 8 (RGDAAC8)	32	RW	0000_0000h
824h	Region Descriptor Alternate Access Control 9 (RGDAAC9)	32	RW	0000_0000h
828h	Region Descriptor Alternate Access Control 10 (RGDAAC10)	32	RW	0000_0000h
82Ch	Region Descriptor Alternate Access Control 11 (RGDAAC11)	32	RW	0000_0000h
830h	Region Descriptor Alternate Access Control 12 (RGDAAC12)	32	RW	0000_0000h
834h	Region Descriptor Alternate Access Control 13 (RGDAAC13)	32	RW	0000_0000h
838h	Region Descriptor Alternate Access Control 14 (RGDAAC14)	32	RW	0000_0000h
83Ch	Region Descriptor Alternate Access Control 15 (RGDAAC15)	32	RW	0000_0000h

15.4.2 Control/Error Status Register (CESR)

15.4.2.1 Offset

Register	Offset
CESR	0h

15.4.2.2 Diagram

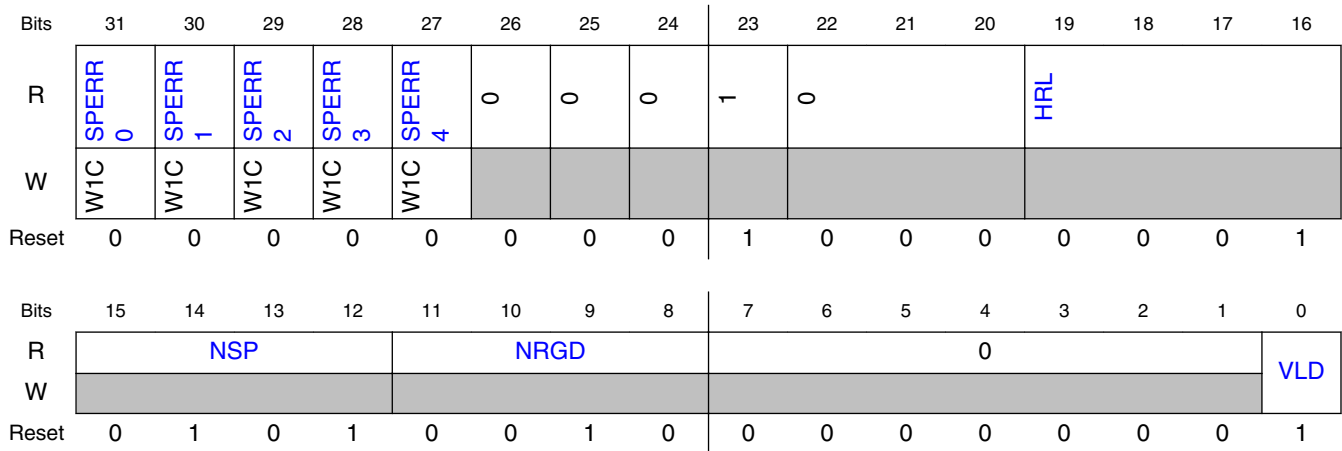

15.4.2.3 Fields

Field	Function
31 SPERR0	<p>Slave Port 0 Error</p> <p>Indicates a captured error in EAR0 and EDR0. This bit is set when the hardware detects an error and records the faulting address and attributes. It is cleared by writing one to it. If another error is captured at the exact same cycle as the write, the flag remains set. A find-first-one instruction or equivalent can detect the presence of a captured error.</p> <p>0b - No error has occurred for slave port 0. 1b - An error has occurred for slave port 0.</p>
30 SPERR1	<p>Slave Port 1 Error</p> <p>Indicates a captured error in EAR1 and EDR1. This bit is set when the hardware detects an error and records the faulting address and attributes. It is cleared by writing one to it. If another error is captured at the exact same cycle as the write, the flag remains set. A find-first-one instruction or equivalent can detect the presence of a captured error.</p> <p>0b - No error has occurred for slave port 1. 1b - An error has occurred for slave port 1.</p>
29 SPERR2	<p>Slave Port 2 Error</p> <p>Indicates a captured error in EAR2 and EDR2. This bit is set when the hardware detects an error and records the faulting address and attributes. It is cleared by writing one to it. If another error is captured at the exact same cycle as the write, the flag remains set. A find-first-one instruction or equivalent can detect the presence of a captured error.</p> <p>0b - No error has occurred for slave port 2. 1b - An error has occurred for slave port 2.</p>
28 SPERR3	<p>Slave Port 3 Error</p> <p>Indicates a captured error in EAR3 and EDR3. This bit is set when the hardware detects an error and records the faulting address and attributes. It is cleared by writing one to it. If another error is captured at the exact same cycle as the write, the flag remains set. A find-first-one instruction or equivalent can detect the presence of a captured error.</p>

Table continues on the next page...

MPU register descriptions

Field	Function
	0b - No error has occurred for slave port 3. 1b - An error has occurred for slave port 3.
27 SPERR4	Slave Port 4 Error Indicates a captured error in EAR4 and EDR4. This bit is set when the hardware detects an error and records the faulting address and attributes. It is cleared by writing one to it. If another error is captured at the exact same cycle as the write, the flag remains set. A find-first-one instruction or equivalent can detect the presence of a captured error. 0b - No error has occurred for slave port 4. 1b - An error has occurred for slave port 4.
26 —	Reserved
25 —	Reserved
24 —	Reserved
23 —	Reserved
22-20 —	Reserved
19-16 HRL	Hardware Revision Level Specifies the MPU's hardware and definition revision level. It can be read by software to determine the functional definition of the module.
15-12 NSP	Number Of Slave Ports Specifies the number of slave ports connected to the MPU.
11-8 NRGD	Number Of Region Descriptors Indicates the number of region descriptors implemented in the MPU. 0000b - 8 region descriptors 0001b - 12 region descriptors 0010b - 16 region descriptors
7-1 —	Reserved
0 VLD	Valid Global enable/disable for the MPU. 0b - MPU is disabled. All accesses from all bus masters are allowed. 1b - MPU is enabled

15.4.3 Error Address Register, slave port n (EAR0 - EAR4)

15.4.3.1 Offset

Register	Offset
EAR0	10h
EAR1	18h
EAR2	20h
EAR3	28h
EAR4	30h

15.4.3.2 Function

When the MPU detects an access error on slave port n, the 32-bit reference address is captured in this read-only register and the corresponding bit in CESR[SPERRn] is set. Additional information about the faulting access is captured in the corresponding EDRn at the same time. This register and the corresponding EDRn contain the most recent access error; there are no hardware interlocks with CESR[SPERRn], as the error registers are always loaded upon the occurrence of each protection violation.

15.4.3.3 Diagram

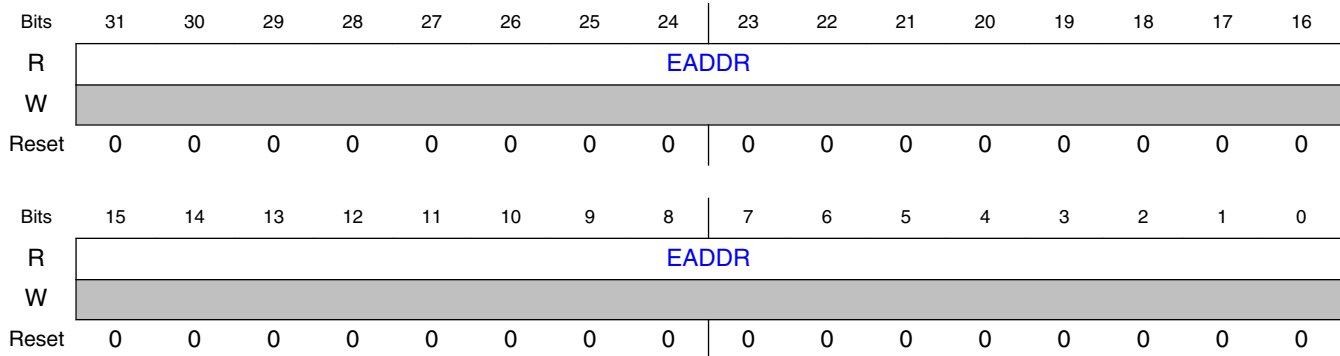

15.4.3.4 Fields

Field	Function
31-0	Error Address
EADDR	Indicates the reference address from slave port n that generated the access error

15.4.4 Error Detail Register, slave port n (EDR0 - EDR4)

15.4.4.1 Offset

Register	Offset
EDR0	14h
EDR1	1Ch
EDR2	24h
EDR3	2Ch
EDR4	34h

15.4.4.2 Function

When the MPU detects an access error on slave port n, 32 bits of error detail are captured in this read-only register and the corresponding bit in CESR[SPERRn] is set. Information on the faulting address is captured in the corresponding EARn register at the same time. This register and the corresponding EARn register contain the most recent access error; there are no hardware interlocks with CESR[SPERRn] as the error registers are always loaded upon the occurrence of each protection violation.

15.4.4.3 Diagram

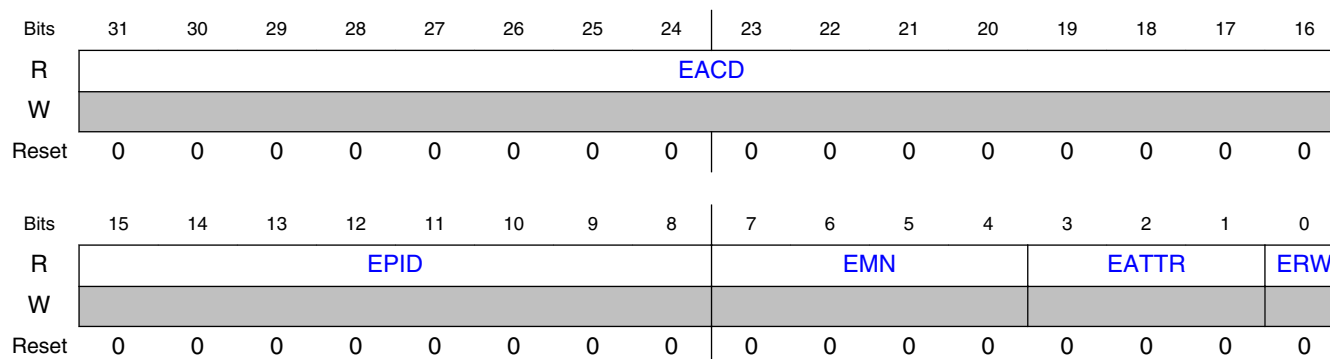

15.4.4.4 Fields

Field	Function
31-16 EACD	<p>Error Access Control Detail</p> <p>Indicates the region descriptor with the access error.</p> <ul style="list-style-type: none"> • If EDR_n contains a captured error and EACD is cleared, an access did not hit in any region descriptor. • If only a single EACD bit is set, the protection error was caused by a single non-overlapping region descriptor. • If two or more EACD bits are set, the protection error was caused by an overlapping set of region descriptors.
15-8 EPID	<p>Error Process Identification</p> <p>Records the process identifier of the faulting reference. The process identifier is typically driven only by processor cores; for other bus masters, this field is cleared.</p>
7-4 EMN	<p>Error Master Number</p> <p>Indicates the bus master that generated the access error.</p>
3-1 EATTR	<p>Error Attributes</p> <p>Indicates attribute information about the faulting reference.</p> <p>NOTE: All other encodings are reserved.</p> <p>000b - User mode, instruction access 001b - User mode, data access 010b - Supervisor mode, instruction access 011b - Supervisor mode, data access</p>
0 ERW	<p>Error Read/Write</p> <p>Indicates the access type of the faulting reference.</p> <p>0b - Read 1b - Write</p>

15.4.5 Region Descriptor n, Word 0 (RGD0_WORD0 - RGD15_WORD0)

15.4.5.1 Offset

For n = 0 to 15:

Register	Offset
RGD _n _WORD0	400h + (n × 10h)

15.4.5.2 Function

The first word of the region descriptor defines the 0-modulo-32 byte start address of the memory region. Writes to this register clear the region descriptor's valid bit (RGDn_WORD3[VLD]).

15.4.5.3 Diagram

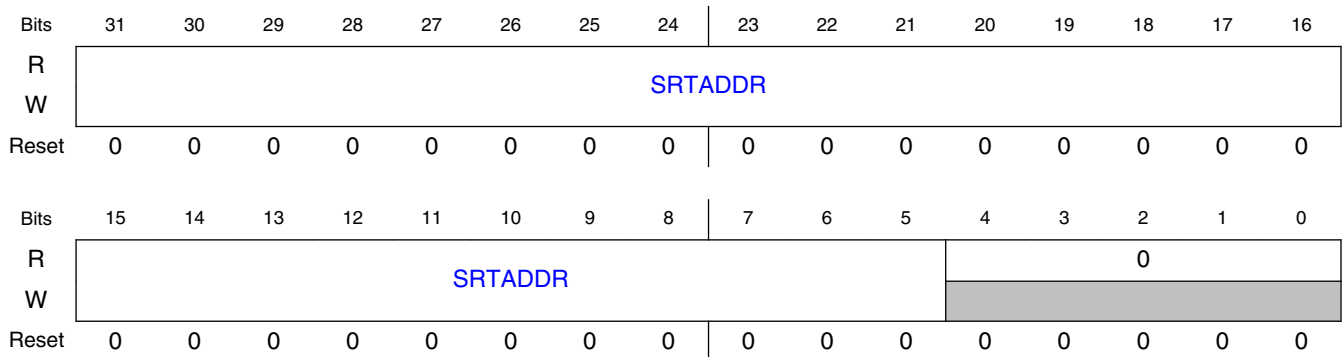

15.4.5.4 Fields

Field	Function
31-5	Start Address
SRTADDR	Defines the most significant bits of the 0-modulo-32 byte start address of the memory region.
4-0	Reserved
—	

15.4.6 Region Descriptor 0, Word 1 (RGD0_WORD1)

15.4.6.1 Offset

Register	Offset
RGD0_WORD1	404h

15.4.6.2 Function

The second word of the region descriptor defines the 31-modulo-32 byte end address of the memory region. Writes to this register clear the region descriptor's valid bit (RGDn_WORD3[VLD]).

15.4.6.3 Diagram

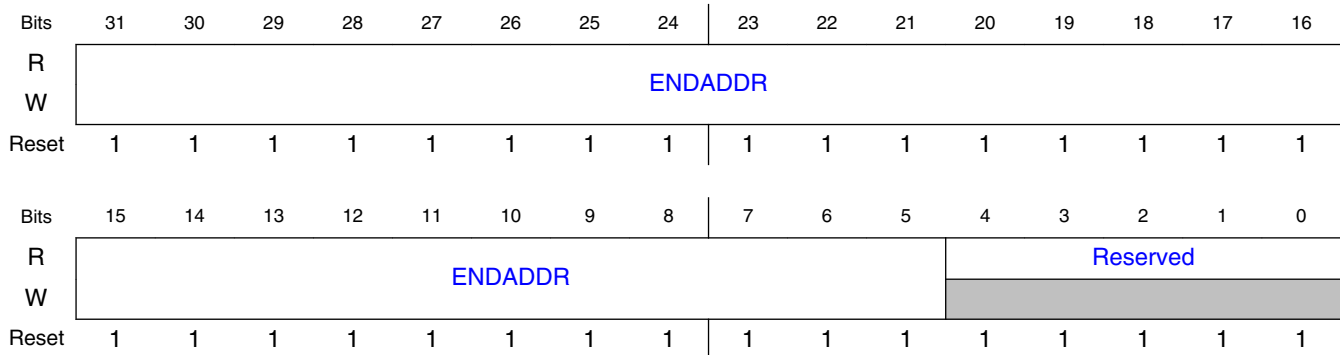

15.4.6.4 Fields

Field	Function
31-5 ENDADDR	End Address Defines the most significant bits of the 31-modulo-32 byte end address of the memory region. NOTE: The MPU does not verify that ENDADDR \geq SRTADDR.
4-0 —	Reserved

15.4.7 Region Descriptor 0, Word 2 (RGD0_WORD2)

15.4.7.1 Offset

Register	Offset
RGD0_WORD2	408h

15.4.7.2 Function

The third word of the region descriptor defines the access control rights of the memory region. The access control privileges depend on two broad classifications of bus masters:

- Bus masters 0–3 have a 5-bit field defining separate privilege rights for user and supervisor mode accesses. Each of these bus masters optionally includes a process identification field (if implemented for the master) within the definition.
- Bus masters 4–7 are limited to separate read and write permissions.

For the privilege rights of bus masters 0–3, there are three flags associated with this function:

- Read (r) refers to accessing the referenced memory address using an operand (data) fetch
- Write (w) refers to updating the referenced memory address using a store (data) instruction
- Execute (x) refers to reading the referenced memory address using an instruction fetch

Writes to RGDn_WORD2 clear the region descriptor’s valid bit (RGDn_WORD3[VLD]). If only updating the access controls, write to RGDAACn instead because stores to these locations do not affect the descriptor’s valid bit.

15.4.7.3 Diagram

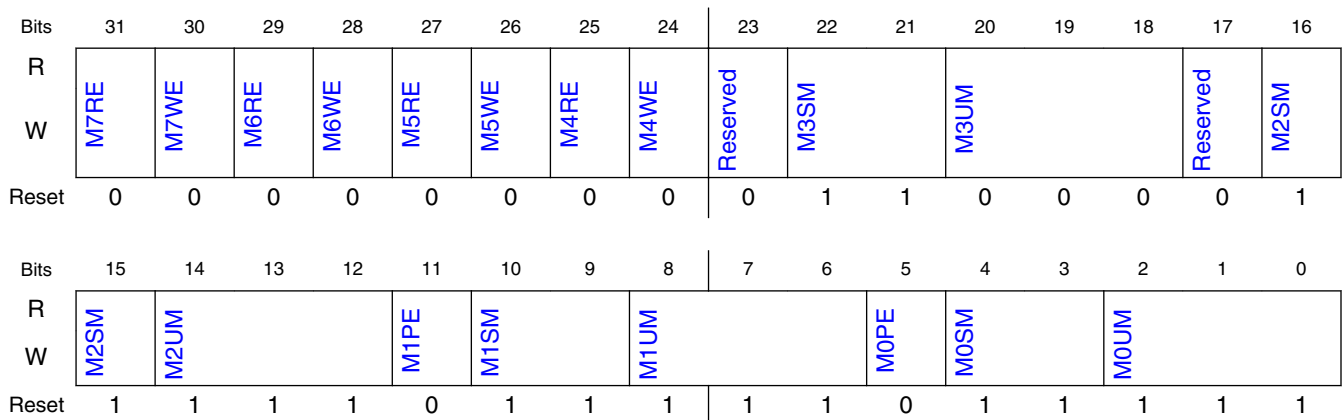

15.4.7.4 Fields

Field	Function
31 M7RE	Bus Master 7 Read Enable 0b - Bus master 7 reads terminate with an access error and the read is not performed 1b - Bus master 7 reads allowed
30 M7WE	Bus Master 7 Write Enable 0b - Bus master 7 writes terminate with an access error and the write is not performed 1b - Bus master 7 writes allowed
29 M6RE	Bus Master 6 Read Enable 0b - Bus master 6 reads terminate with an access error and the read is not performed 1b - Bus master 6 reads allowed
28 M6WE	Bus Master 6 Write Enable 0b - Bus master 6 writes terminate with an access error and the write is not performed 1b - Bus master 6 writes allowed
27 M5RE	Bus Master 5 Read Enable 0b - Bus master 5 reads terminate with an access error and the read is not performed 1b - Bus master 5 reads allowed
26 M5WE	Bus Master 5 Write Enable 0b - Bus master 5 writes terminate with an access error and the write is not performed 1b - Bus master 5 writes allowed
25 M4RE	Bus Master 4 Read Enable 0b - Bus master 4 reads terminate with an access error and the read is not performed 1b - Bus master 4 reads allowed
24 M4WE	Bus Master 4 Write Enable 0b - Bus master 4 writes terminate with an access error and the write is not performed 1b - Bus master 4 writes allowed
23 —	Reserved This bit must be written with a zero.
22-21 M3SM	Bus Master 3 Supervisor Mode Access Control Defines the access controls for bus master 3 in Supervisor mode. 00b - r/w/x; read, write and execute allowed 01b - r/x; read and execute allowed, but no write 10b - r/w; read and write allowed, but no execute 11b - Same as User mode defined in M3UM
20-18 M3UM	Bus Master 3 User Mode Access Control Defines the access controls for bus master 3 in User mode. M3UM consists of three independent bits, enabling read (r), write (w), and execute (x) permissions. In M3UM[2:0]: M3UM[2] controls read permissions, M3UM[1] controls write permissions, and M3UM[0] controls execute permissions. For each bit: 0b - An attempted access of that mode may be terminated with an access error (if not allowed by another descriptor) and the access not performed 1b - Allows the given access type to occur
17 —	Reserved This bit must be written with a zero.
16-15 M2SM	Bus Master 2 Supervisor Mode Access Control Defines the access controls for bus master 2 in Supervisor mode. 00b - r/w/x; read, write and execute allowed 01b - r/x; read and execute allowed, but no write

Table continues on the next page...

MPU register descriptions

Field	Function
	10b - r/w; read and write allowed, but no execute 11b - Same as User mode defined in M2UM
14-12 M2UM	Bus Master 2 User Mode Access control Defines the access controls for bus master 2 in User mode. M2UM consists of three independent bits, enabling read (r), write (w), and execute (x) permissions. In M2UM[2:0]: M2UM[2] controls read permissions, M2UM[1] controls write permissions, and M2UM[0] controls execute permissions. For each bit: 0b - An attempted access of that mode may be terminated with an access error (if not allowed by another descriptor) and the access not performed 1b - Allows the given access type to occur
11 M1PE	Bus Master 1 Process Identifier enable 0b - Do not include the process identifier in the evaluation 1b - Include the process identifier and mask (RGDn.RGDAAc) in the region hit evaluation
10-9 M1SM	Bus Master 1 Supervisor Mode Access Control Defines the access controls for bus master 1 in Supervisor mode. 00b - r/w/x; read, write and execute allowed 01b - r/x; read and execute allowed, but no write 10b - r/w; read and write allowed, but no execute 11b - Same as User mode defined in M1UM
8-6 M1UM	Bus Master 1 User Mode Access Control Defines the access controls for bus master 1 in User mode. M1UM consists of three independent bits, enabling read (r), write (w), and execute (x) permissions. In M1UM[2:0]: M1UM[2] controls read permissions, M1UM[1] controls write permissions, and M1UM[0] controls execute permissions. For each bit: 0b - An attempted access of that mode may be terminated with an access error (if not allowed by another descriptor) and the access not performed 1b - Allows the given access type to occur
5 M0PE	Bus Master 0 Process Identifier enable 0b - Do not include the process identifier in the evaluation 1b - Include the process identifier and mask (RGDn.RGDAAc) in the region hit evaluation
4-3 M0SM	Bus Master 0 Supervisor Mode Access Control Defines the access controls for bus master 0 in Supervisor mode. 00b - r/w/x; read, write and execute allowed 01b - r/x; read and execute allowed, but no write 10b - r/w; read and write allowed, but no execute 11b - Same as User mode defined in M0UM
2-0 M0UM	Bus Master 0 User Mode Access Control Defines the access controls for bus master 0 in User mode. M0UM consists of three independent bits, enabling read (r), write (w), and execute (x) permissions. In M0UM[2:0]: M0UM[2] controls read permissions, M0UM[1] controls write permissions, and M0UM[0] controls execute permissions. For each bit: 0b - An attempted access of that mode may be terminated with an access error (if not allowed by another descriptor) and the access not performed 1b - Allows the given access type to occur

15.4.8 Region Descriptor 0, Word 3 (RGD0_WORD3)

15.4.8.1 Offset

Register	Offset
RGD0_WORD3	40Ch

15.4.8.2 Function

The fourth word of the region descriptor contains the optional process identifier and mask, plus the region descriptor's valid bit.

15.4.8.3 Diagram

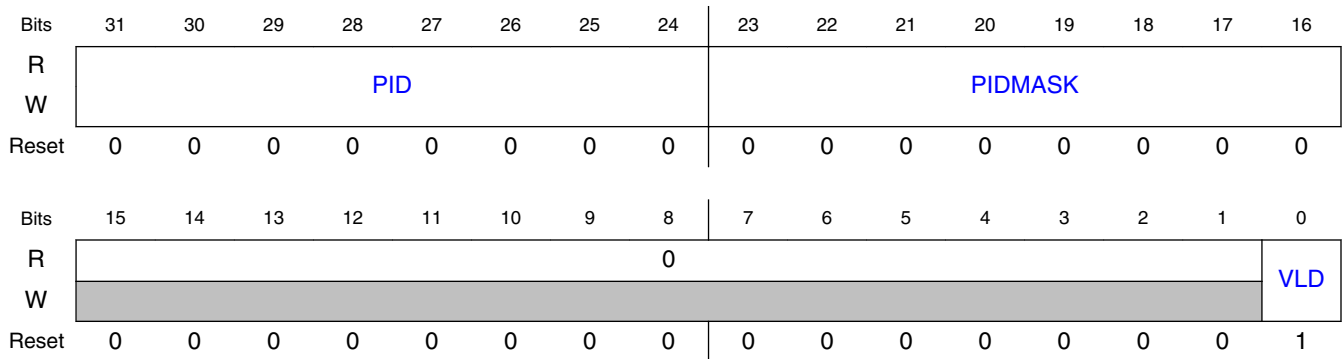

15.4.8.4 Fields

Field	Function
31-24 PID	Process Identifier Specifies the process identifier that is included in the region hit determination if RGDn_WORD2[MxPE] is set. PIDMASK can mask individual bits in this field.
23-16 PIDMASK	Process Identifier Mask Provides a masking capability so that multiple process identifiers can be included as part of the region hit determination. If a bit in PIDMASK is set, then the corresponding PID bit is ignored in the comparison. This field and PID are included in the region hit determination if RGDn_WORD2[MxPE] is set. For more information on the handling of the PID and PIDMASK, see "Access Evaluation - Hit Determination."
15-1 —	Reserved
0 VLD	Valid Signals the region descriptor is valid. Any write to RGDn_WORD0–2 clears this bit.

MPU register descriptions

Field	Function
	0b - Region descriptor is invalid 1b - Region descriptor is valid

15.4.9 Region Descriptor n, Word 1 (RGD1_WORD1 - RGD15_WORD1)

15.4.9.1 Offset

For n = 1 to 15:

Register	Offset
RGDn_WORD1	404h + (n × 10h)

15.4.9.2 Function

The second word of the region descriptor defines the 31-modulo-32 byte end address of the memory region. Writes to this register clear the region descriptor's valid bit (RGDn_WORD3[VLD]).

15.4.9.3 Diagram

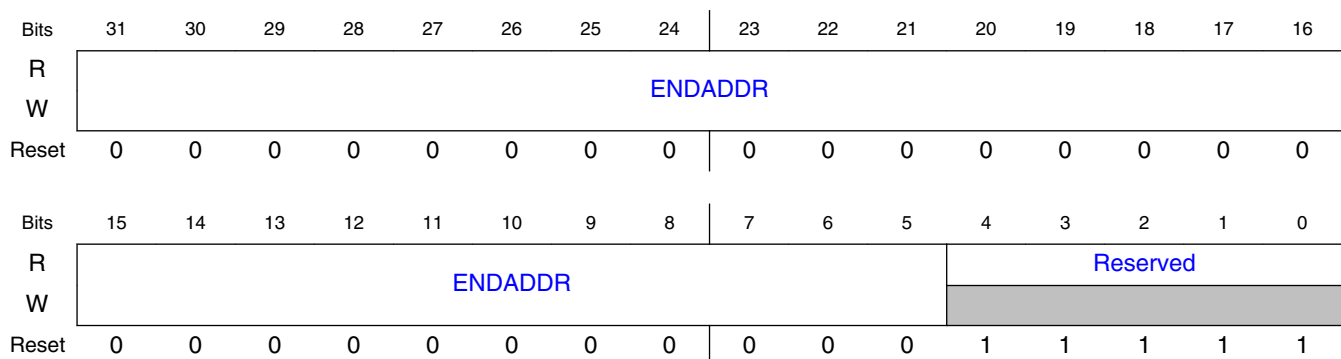

15.4.9.4 Fields

Field	Function
31-5 ENDADDR	End Address Defines the most significant bits of the 31-modulo-32 byte end address of the memory region. NOTE: The MPU does not verify that ENDADDR \geq SRTADDR.
4-0 —	Reserved

15.4.10 Region Descriptor n, Word 2 (RGD1_WORD2 - RGD15_WORD2)

15.4.10.1 Offset

For n = 1 to 15:

Register	Offset
RGDn_WORD2	408h + (n × 10h)

15.4.10.2 Function

The third word of the region descriptor defines the access control rights of the memory region. The access control privileges depend on two broad classifications of bus masters:

- Bus masters 0–3 have a 5-bit field defining separate privilege rights for user and supervisor mode accesses. Each of these bus masters optionally includes a process identification field (if implemented for the master) within the definition.
- Bus masters 4–7 are limited to separate read and write permissions.

For the privilege rights of bus masters 0–3, there are three flags associated with this function:

- Read (r) refers to accessing the referenced memory address using an operand (data) fetch

MPU register descriptions

- Write (w) refers to updating the referenced memory address using a store (data) instruction
- Execute (x) refers to reading the referenced memory address using an instruction fetch

Writes to RGDn_WORD2 clear the region descriptor's valid bit (RGDn_WORD3[VLD]). If only updating the access controls, write to RGDAACn instead because stores to these locations do not affect the descriptor's valid bit.

15.4.10.3 Diagram

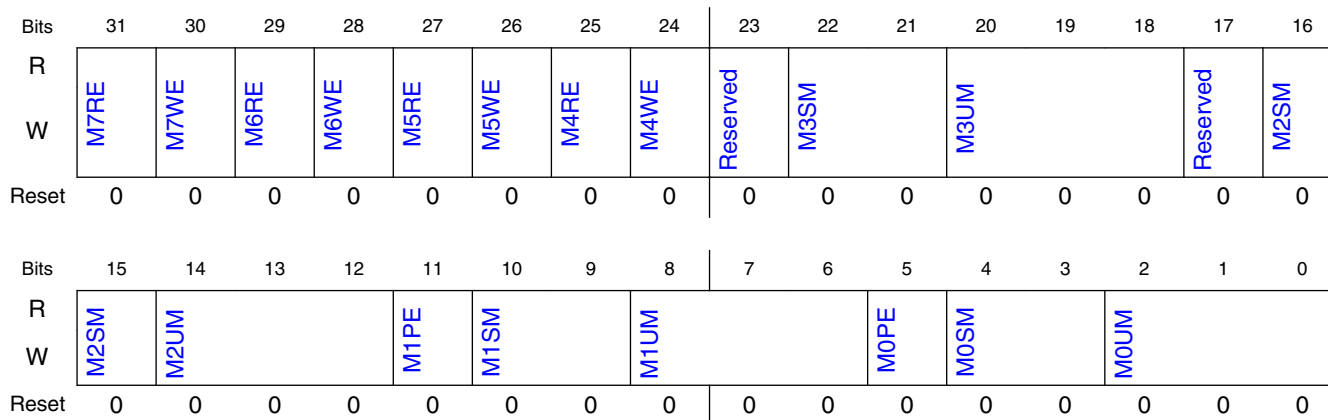

15.4.10.4 Fields

Field	Function
31 M7RE	Bus Master 7 Read Enable 0b - Bus master 7 reads terminate with an access error and the read is not performed 1b - Bus master 7 reads allowed
30 M7WE	Bus Master 7 Write Enable 0b - Bus master 7 writes terminate with an access error and the write is not performed 1b - Bus master 7 writes allowed
29 M6RE	Bus Master 6 Read Enable 0b - Bus master 6 reads terminate with an access error and the read is not performed 1b - Bus master 6 reads allowed
28 M6WE	Bus Master 6 Write Enable 0b - Bus master 6 writes terminate with an access error and the write is not performed 1b - Bus master 6 writes allowed
27 M5RE	Bus Master 5 Read Enable 0b - Bus master 5 reads terminate with an access error and the read is not performed 1b - Bus master 5 reads allowed
26	Bus Master 5 Write Enable 0b - Bus master 5 writes terminate with an access error and the write is not performed

Table continues on the next page...

Field	Function
M5WE	1b - Bus master 5 writes allowed
25 M4RE	Bus Master 4 Read Enable 0b - Bus master 4 reads terminate with an access error and the read is not performed 1b - Bus master 4 reads allowed
24 M4WE	Bus Master 4 Write Enable 0b - Bus master 4 writes terminate with an access error and the write is not performed 1b - Bus master 4 writes allowed
23 —	Reserved This bit must be written with a zero.
22-21 M3SM	Bus Master 3 Supervisor Mode Access Control Defines the access controls for bus master 3 in Supervisor mode. 00b - r/w/x; read, write and execute allowed 01b - r/x; read and execute allowed, but no write 10b - r/w; read and write allowed, but no execute 11b - Same as User mode defined in M3UM
20-18 M3UM	Bus Master 3 User Mode Access Control Defines the access controls for bus master 3 in User mode. M3UM consists of three independent bits, enabling read (r), write (w), and execute (x) permissions. In M3UM[2:0]: M3UM[2] controls read permissions, M3UM[1] controls write permissions, and M3UM[0] controls execute permissions. For each bit: 0b - An attempted access of that mode may be terminated with an access error (if not allowed by another descriptor) and the access not performed 1b - Allows the given access type to occur
17 —	Reserved This bit must be written with a zero.
16-15 M2SM	Bus Master 2 Supervisor Mode Access Control Defines the access controls for bus master 2 in Supervisor mode. 00b - r/w/x; read, write and execute allowed 01b - r/x; read and execute allowed, but no write 10b - r/w; read and write allowed, but no execute 11b - Same as User mode defined in M2UM
14-12 M2UM	Bus Master 2 User Mode Access control Defines the access controls for bus master 2 in User mode. M2UM consists of three independent bits, enabling read (r), write (w), and execute (x) permissions. In M2UM[2:0]: M2UM[2] controls read permissions, M2UM[1] controls write permissions, and M2UM[0] controls execute permissions. For each bit: 0b - An attempted access of that mode may be terminated with an access error (if not allowed by another descriptor) and the access not performed 1b - Allows the given access type to occur
11 M1PE	Bus Master 1 Process Identifier enable 0b - Do not include the process identifier in the evaluation 1b - Include the process identifier and mask (RGDn.RGDAAC) in the region hit evaluation
10-9 M1SM	Bus Master 1 Supervisor Mode Access Control Defines the access controls for bus master 1 in Supervisor mode. 00b - r/w/x; read, write and execute allowed 01b - r/x; read and execute allowed, but no write 10b - r/w; read and write allowed, but no execute 11b - Same as User mode defined in M1UM
8-6	Bus Master 1 User Mode Access Control

Table continues on the next page...

MPU register descriptions

Field	Function
M1UM	Defines the access controls for bus master 1 in User mode. M1UM consists of three independent bits, enabling read (r), write (w), and execute (x) permissions. In M1UM[2:0]: M1UM[2] controls read permissions, M1UM[1] controls write permissions, and M1UM[0] controls execute permissions. For each bit: 0b - An attempted access of that mode may be terminated with an access error (if not allowed by another descriptor) and the access not performed 1b - Allows the given access type to occur
5 M0PE	Bus Master 0 Process Identifier enable 0b - Do not include the process identifier in the evaluation 1b - Include the process identifier and mask (RGDn.RGDAAC) in the region hit evaluation
4-3 M0SM	Bus Master 0 Supervisor Mode Access Control Defines the access controls for bus master 0 in Supervisor mode. 00b - r/w/x; read, write and execute allowed 01b - r/x; read and execute allowed, but no write 10b - r/w; read and write allowed, but no execute 11b - Same as User mode defined in M0UM
2-0 M0UM	Bus Master 0 User Mode Access Control Defines the access controls for bus master 0 in User mode. M0UM consists of three independent bits, enabling read (r), write (w), and execute (x) permissions. In M0UM[2:0]: M0UM[2] controls read permissions, M0UM[1] controls write permissions, and M0UM[0] controls execute permissions. For each bit: 0b - An attempted access of that mode may be terminated with an access error (if not allowed by another descriptor) and the access not performed 1b - Allows the given access type to occur

15.4.11 Region Descriptor n, Word 3 (RGD1_WORD3 - RGD15_WORD3)

15.4.11.1 Offset

For n = 1 to 15:

Register	Offset
RGDn_WORD3	40Ch + (n × 10h)

15.4.11.2 Function

The fourth word of the region descriptor contains the optional process identifier and mask, plus the region descriptor's valid bit.

15.4.11.3 Diagram

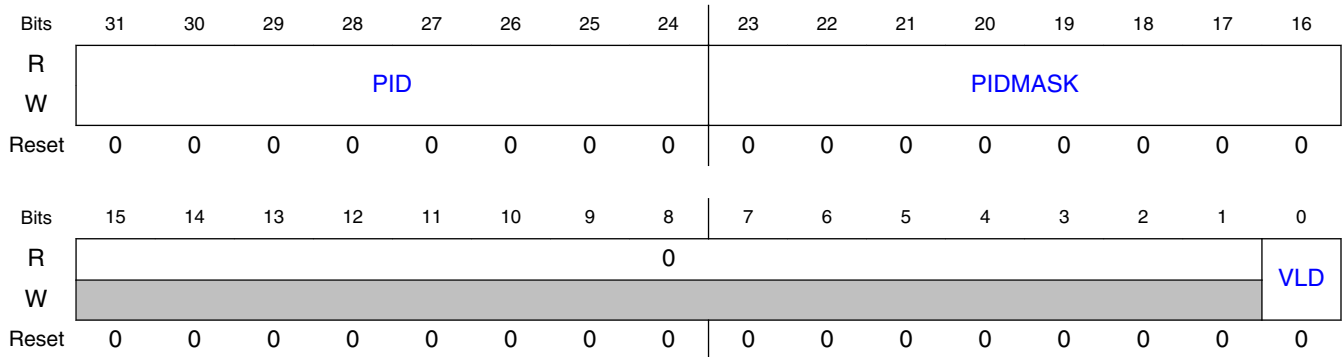

15.4.11.4 Fields

Field	Function
31-24 PID	Process Identifier Specifies the process identifier that is included in the region hit determination if RGDn_WORD2[MxPE] is set. PIDMASK can mask individual bits in this field.
23-16 PIDMASK	Process Identifier Mask Provides a masking capability so that multiple process identifiers can be included as part of the region hit determination. If a bit in PIDMASK is set, then the corresponding PID bit is ignored in the comparison. This field and PID are included in the region hit determination if RGDn_WORD2[MxPE] is set. For more information on the handling of the PID and PIDMASK, see “Access Evaluation - Hit Determination.”
15-1 —	Reserved
0 VLD	Valid Signals the region descriptor is valid. Any write to RGDn_WORD0–2 clears this bit. 0b - Region descriptor is invalid 1b - Region descriptor is valid

15.4.12 Region Descriptor Alternate Access Control 0 (RGDAAC0)

15.4.12.1 Offset

Register	Offset
RGDAAC0	800h

15.4.12.2 Function

Because software may adjust only the access controls within a region descriptor (RGDn_WORD2) as different tasks execute, an alternate programming view of this 32-bit entity is available. Writing to this register does not affect the descriptor’s valid bit.

15.4.12.3 Diagram

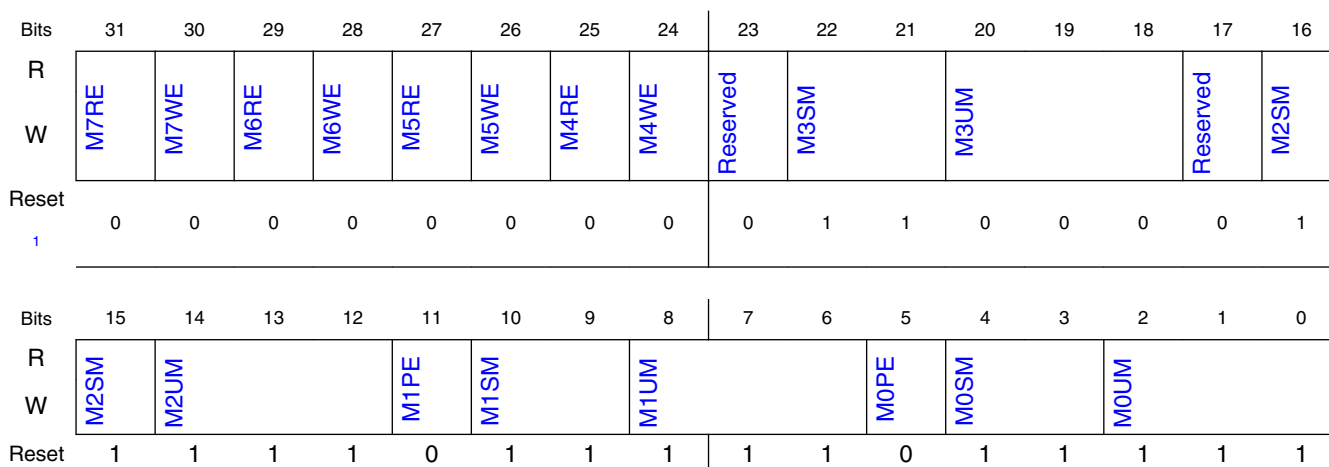

1. RGDAAC0 resets to 61F7DFh. Other RGDAACn registers reset to 0h.

15.4.12.4 Fields

Field	Function
31 M7RE	Bus Master 7 Read Enable 0b - Bus master 7 reads terminate with an access error and the read is not performed 1b - Bus master 7 reads allowed
30 M7WE	Bus Master 7 Write Enable 0b - Bus master 7 writes terminate with an access error and the write is not performed 1b - Bus master 7 writes allowed
29 M6RE	Bus Master 6 Read Enable 0b - Bus master 6 reads terminate with an access error and the read is not performed 1b - Bus master 6 reads allowed
28 M6WE	Bus Master 6 Write Enable 0b - Bus master 6 writes terminate with an access error and the write is not performed 1b - Bus master 6 writes allowed
27 M5RE	Bus Master 5 Read Enable 0b - Bus master 5 reads terminate with an access error and the read is not performed 1b - Bus master 5 reads allowed
26	Bus Master 5 Write Enable

Table continues on the next page...

Field	Function
M5WE	0b - Bus master 5 writes terminate with an access error and the write is not performed 1b - Bus master 5 writes allowed
25 M4RE	Bus Master 4 Read Enable 0b - Bus master 4 reads terminate with an access error and the read is not performed 1b - Bus master 4 reads allowed
24 M4WE	Bus Master 4 Write Enable 0b - Bus master 4 writes terminate with an access error and the write is not performed 1b - Bus master 4 writes allowed
23 —	Reserved This bit must be written with a zero.
22-21 M3SM	Bus Master 3 Supervisor Mode Access Control Defines the access controls for bus master 3 in Supervisor mode. 00b - r/w/x; read, write and execute allowed 01b - r/x; read and execute allowed, but no write 10b - r/w; read and write allowed, but no execute 11b - Same as User mode defined in M3UM
20-18 M3UM	Bus Master 3 User Mode Access Control Defines the access controls for bus master 3 in User mode. M3UM consists of three independent bits, enabling read (r), write (w), and execute (x) permissions. In M3UM[2:0]: M3UM[2] controls read permissions, M3UM[1] controls write permissions, and M3UM[0] controls execute permissions. For each bit: 0b - An attempted access of that mode may be terminated with an access error (if not allowed by another descriptor) and the access not performed 1b - Allows the given access type to occur
17 —	Reserved This bit must be written with a zero.
16-15 M2SM	Bus Master 2 Supervisor Mode Access Control Defines the access controls for bus master 2 in Supervisor mode. 00b - r/w/x; read, write and execute allowed 01b - r/x; read and execute allowed, but no write 10b - r/w; read and write allowed, but no execute 11b - Same as User mode defined in M2UM
14-12 M2UM	Bus Master 2 User Mode Access Control Defines the access controls for bus master 2 in User mode. M2UM consists of three independent bits, enabling read (r), write (w), and execute (x) permissions. In M2UM[2:0]: M2UM[2] controls read permissions, M2UM[1] controls write permissions, and M2UM[0] controls execute permissions. For each bit: 0b - An attempted access of that mode may be terminated with an access error (if not allowed by another descriptor) and the access not performed 1b - Allows the given access type to occur
11 M1PE	Bus Master 1 Process Identifier Enable NOTE: For RGDAAC0: Only bus master 1 can write to M1PE. 0b - Do not include the process identifier in the evaluation 1b - Include the process identifier and mask (RGDn.RGDAAC) in the region hit evaluation
10-9 M1SM	Bus Master 1 Supervisor Mode Access Control Defines the access controls for bus master 1 in Supervisor mode. NOTE: For RGDAAC0: Only bus master 1 can write to M1SM. 00b - r/w/x; read, write and execute allowed

Table continues on the next page...

MPU register descriptions

Field	Function
	01b - r/x; read and execute allowed, but no write 10b - r/w; read and write allowed, but no execute 11b - Same as User mode defined in M1UM
8-6 M1UM	Bus Master 1 User Mode Access Control Defines the access controls for bus master 1 in User mode. M1UM consists of three independent bits, enabling read (r), write (w), and execute (x) permissions. In M1UM[2:0]: M1UM[2] controls read permissions, M1UM[1] controls write permissions, and M1UM[0] controls execute permissions. NOTE: For RGDAAC0: Only bus master 1 can write to M1UM. For each bit: 0b - An attempted access of that mode may be terminated with an access error (if not allowed by another descriptor) and the access not performed 1b - Allows the given access type to occur
5 M0PE	Bus Master 0 Process Identifier Enable 0b - Do not include the process identifier in the evaluation 1b - Include the process identifier and mask (RGDn.RGDAAC) in the region hit evaluation
4-3 M0SM	Bus Master 0 Supervisor Mode Access Control Defines the access controls for bus master 0 in Supervisor mode. 00b - r/w/x; read, write and execute allowed 01b - r/x; read and execute allowed, but no write 10b - r/w; read and write allowed, but no execute 11b - Same as User mode defined in M0UM
2-0 M0UM	Bus Master 0 User Mode Access Control Defines the access controls for bus master 0 in User mode. M0UM consists of three independent bits, enabling read (r), write (w), and execute (x) permissions. In M0UM[2:0]: M0UM[2] controls read permissions, M0UM[1] controls write permissions, and M0UM[0] controls execute permissions. For each bit: 0b - An attempted access of that mode may be terminated with an access error (if not allowed by another descriptor) and the access not performed 1b - Allows the given access type to occur

15.4.13 Region Descriptor Alternate Access Control n (RGDAAC1 - RGDAAC15)

15.4.13.1 Offset

For n = 1 to 15:

Register	Offset
RGDAACn	800h + (n × 4h)

15.4.13.2 Function

Because software may adjust only the access controls within a region descriptor (RGDn_WORD2) as different tasks execute, an alternate programming view of this 32-bit entity is available. Writing to this register does not affect the descriptor's valid bit.

15.4.13.3 Diagram

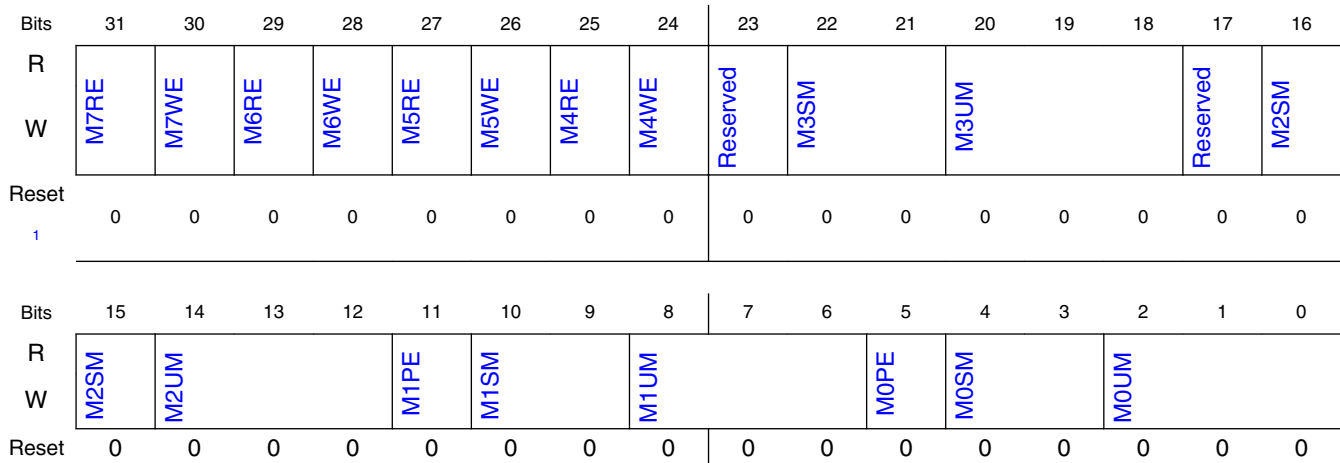

1. RGDAAC0 resets to 61F7DFh. Other RGDAACn registers reset to 0h.

15.4.13.4 Fields

Field	Function
31 M7RE	Bus Master 7 Read Enable 0b - Bus master 7 reads terminate with an access error and the read is not performed 1b - Bus master 7 reads allowed
30 M7WE	Bus Master 7 Write Enable 0b - Bus master 7 writes terminate with an access error and the write is not performed 1b - Bus master 7 writes allowed
29 M6RE	Bus Master 6 Read Enable 0b - Bus master 6 reads terminate with an access error and the read is not performed 1b - Bus master 6 reads allowed
28 M6WE	Bus Master 6 Write Enable 0b - Bus master 6 writes terminate with an access error and the write is not performed 1b - Bus master 6 writes allowed
27 M5RE	Bus Master 5 Read Enable 0b - Bus master 5 reads terminate with an access error and the read is not performed 1b - Bus master 5 reads allowed
26 M5WE	Bus Master 5 Write Enable 0b - Bus master 5 writes terminate with an access error and the write is not performed 1b - Bus master 5 writes allowed

Table continues on the next page...

MPU register descriptions

Field	Function
25 M4RE	Bus Master 4 Read Enable 0b - Bus master 4 reads terminate with an access error and the read is not performed 1b - Bus master 4 reads allowed
24 M4WE	Bus Master 4 Write Enable 0b - Bus master 4 writes terminate with an access error and the write is not performed 1b - Bus master 4 writes allowed
23 —	Reserved This bit must be written with a zero.
22-21 M3SM	Bus Master 3 Supervisor Mode Access Control Defines the access controls for bus master 3 in Supervisor mode. 00b - r/w/x; read, write and execute allowed 01b - r/x; read and execute allowed, but no write 10b - r/w; read and write allowed, but no execute 11b - Same as User mode defined in M3UM
20-18 M3UM	Bus Master 3 User Mode Access Control Defines the access controls for bus master 3 in User mode. M3UM consists of three independent bits, enabling read (r), write (w), and execute (x) permissions. In M3UM[2:0]: M3UM[2] controls read permissions, M3UM[1] controls write permissions, and M3UM[0] controls execute permissions. For each bit: 0b - An attempted access of that mode may be terminated with an access error (if not allowed by another descriptor) and the access not performed 1b - Allows the given access type to occur
17 —	Reserved This bit must be written with a zero.
16-15 M2SM	Bus Master 2 Supervisor Mode Access Control Defines the access controls for bus master 2 in Supervisor mode. 00b - r/w/x; read, write and execute allowed 01b - r/x; read and execute allowed, but no write 10b - r/w; read and write allowed, but no execute 11b - Same as User mode defined in M2UM
14-12 M2UM	Bus Master 2 User Mode Access Control Defines the access controls for bus master 2 in User mode. M2UM consists of three independent bits, enabling read (r), write (w), and execute (x) permissions. In M2UM[2:0]: M2UM[2] controls read permissions, M2UM[1] controls write permissions, and M2UM[0] controls execute permissions. For each bit: 0b - An attempted access of that mode may be terminated with an access error (if not allowed by another descriptor) and the access not performed 1b - Allows the given access type to occur
11 M1PE	Bus Master 1 Process Identifier Enable NOTE: For RGDAAC0: Only bus master 1 can write to M1PE. 0b - Do not include the process identifier in the evaluation 1b - Include the process identifier and mask (RGDn.RGDAAC) in the region hit evaluation
10-9 M1SM	Bus Master 1 Supervisor Mode Access Control Defines the access controls for bus master 1 in Supervisor mode. NOTE: For RGDAAC0: Only bus master 1 can write to M1SM. 00b - r/w/x; read, write and execute allowed 01b - r/x; read and execute allowed, but no write 10b - r/w; read and write allowed, but no execute 11b - Same as User mode defined in M1UM

Table continues on the next page...

Field	Function
8-6 M1UM	<p>Bus Master 1 User Mode Access Control</p> <p>Defines the access controls for bus master 1 in User mode. M1UM consists of three independent bits, enabling read (r), write (w), and execute (x) permissions. In M1UM[2:0]: M1UM[2] controls read permissions, M1UM[1] controls write permissions, and M1UM[0] controls execute permissions.</p> <p>NOTE: For RGDAAC0: Only bus master 1 can write to M1UM. For each bit: 0b - An attempted access of that mode may be terminated with an access error (if not allowed by another descriptor) and the access not performed 1b - Allows the given access type to occur</p>
5 M0PE	<p>Bus Master 0 Process Identifier Enable</p> <p>0b - Do not include the process identifier in the evaluation 1b - Include the process identifier and mask (RGDn.RGDAAC) in the region hit evaluation</p>
4-3 M0SM	<p>Bus Master 0 Supervisor Mode Access Control</p> <p>Defines the access controls for bus master 0 in Supervisor mode.</p> <p>00b - r/w/x; read, write and execute allowed 01b - r/x; read and execute allowed, but no write 10b - r/w; read and write allowed, but no execute 11b - Same as User mode defined in M0UM</p>
2-0 M0UM	<p>Bus Master 0 User Mode Access Control</p> <p>Defines the access controls for bus master 0 in User mode. M0UM consists of three independent bits, enabling read (r), write (w), and execute (x) permissions. In M0UM[2:0]: M0UM[2] controls read permissions, M0UM[1] controls write permissions, and M0UM[0] controls execute permissions. For each bit: 0b - An attempted access of that mode may be terminated with an access error (if not allowed by another descriptor) and the access not performed 1b - Allows the given access type to occur</p>

15.5 Functional description

In this section, the functional operation of the MPU is detailed, including the operation of the access evaluation macro and the handling of error-terminated bus cycles.

15.5.1 Access evaluation macro

The basic operation of the MPU is performed in the access evaluation macro, a hardware structure replicated in the two-dimensional connection matrix. As shown in the following figure, the access evaluation macro inputs the crossbar bus address phase signals and the contents of a region descriptor (RGDn) and performs two major functions:

- Region hit determination
- Detection of an access protection violation

The following figure shows a functional block diagram.

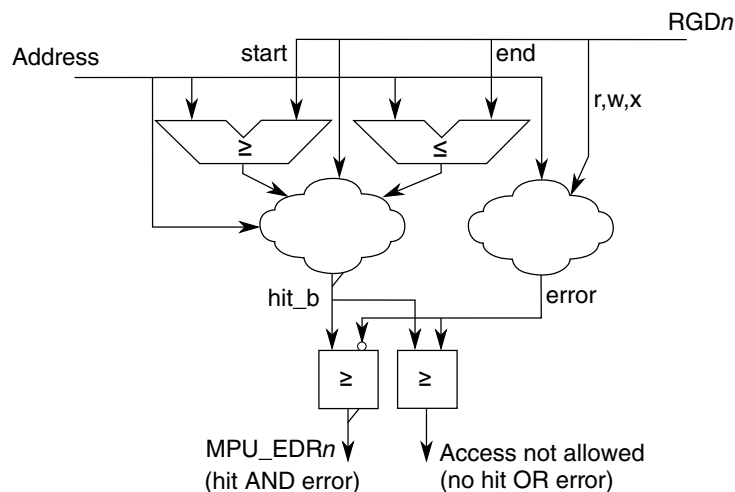

Figure 15-2. MPU access evaluation macro

15.5.1.1 Hit determination

To determine whether the current reference hits in the given region, two magnitude comparators are used with the region's start and end addresses. The boolean equation for this portion of the hit determination is:

```
region_hit = ((addr[31:5] >= RGDn_Word0[SRTADDR]) & (addr[31:5] <= RGDn_Word1[ENDADDR])) & RGDn_Word3[VLD]
```

where *addr* is the current reference address, *RGDn_Word0[SRTADDR]* and *RGDn_Word1[ENDADDR]* are the start and end addresses, and *RGDn_Word3[VLD]* is the valid bit.

NOTE

The MPU does not verify that *ENDADDR* ≥ *SRTADDR*.

In addition to the comparison of the reference address versus the region descriptor's start and end addresses, the optional process identifier is examined against the region descriptor's PID and PIDMASK fields. A process identifier hit term is formed as follows:

```
pid_hit = ~RGDn_Word2[MxPE] | ((current_pid | RGDn_Word3[PIDMASK]) == (RGDn_Word3[PID] | RGDn_Word3[PIDMASK]))
```

where the *current_pid* is the selected process identifier from the current bus master, and *RGDn_Word3[PID]* and *RGDn_Word3[PIDMASK]* are the process identifier fields from region descriptor *n*. For bus masters that do not output a process identifier, the MPU forces the *pid_hit* term to assert.

15.5.1.2 Privilege violation determination

While the access evaluation macro is determining region hit, the logic is also evaluating if the current access is allowed by the permissions defined in the region descriptor. Using the master and supervisor/user mode signals, a set of effective permissions is generated from the appropriate fields in the region descriptor. The protection violation logic then evaluates the access against the effective permissions as shown in the following table.

Table 15-5. Protection violation definition

Description	MxUM			Protection violation?
	r	w	x	
Instruction fetch read	—	—	0	Yes, no execute permission
	—	—	1	No, access is allowed
Data read	0	—	—	Yes, no read permission
	1	—	—	No, access is allowed
Data write	—	0	—	Yes, no write permission
	—	1	—	No, access is allowed

15.5.2 Putting it all together and error terminations

For each slave port monitored, the MPU performs a reduction-AND of all the individual terms from each access evaluation macro. This expression then terminates the bus cycle with an error and reports a protection error for three conditions:

- If the access does not hit in any region descriptor, a protection error is reported.
- If the access hits in a single region descriptor and that region signals a protection violation, a protection error is reported.
- If the access hits in multiple (overlapping) regions and all regions signal protection violations, a protection error is reported.

As shown in the third condition, granting permission is a higher priority than denying access for overlapping regions. This approach is more flexible to system software in region descriptor assignments. For an example of the use of overlapping region descriptors, see [Application information](#).

15.5.3 Power management

Disabling the MPU by clearing CESR[VLD] minimizes power dissipation. To minimize the power dissipation of an enabled MPU, invalidate unused region descriptors by clearing the associated RGDn_Word3[VLD] bits.

15.6 Initialization information

At system startup, load the appropriate number of region descriptors, including setting RGDn_Word3[VLD]. Setting CESR[VLD] enables the module.

If the system requires that all the loaded region descriptors be enabled simultaneously, first ensure that the entire MPU is disabled (CESR[VLD]=0).

Note

If the MPU registers are protected by the MPU, a region descriptor must be set to allow access to the MPU registers if further changes are needed.

15.7 Application information

In an operational system, interfacing with the MPU is generally classified into the following activities:

- Creating a new memory region—Load the appropriate region descriptor into an available RGDn, using four sequential 32-bit writes. The hardware assists in the maintenance of the valid bit, so if this approach is followed, there are no coherency issues with the multi-cycle descriptor writes. (Clearing RGDn_Word3[VLD] deletes/removes an existing memory region.)
- Altering only access privileges—To not affect the valid bit, write to the alternate version of the access control word (RGDAACn), so there are no coherency issues involved with the update. When the write completes, the memory region's access rights switch instantaneously to the new value.
- Changing a region's start and end addresses—Write a minimum of three words to the region descriptor (RGDn_Word{0,1,3}). Word 0 and 1 redefine the start and end addresses, respectively. Word 3 re-enables the region descriptor valid bit. In most situations, all four words of the region descriptor are rewritten.

- Accessing the MPU—Allocate a region descriptor to restrict MPU access to supervisor mode from a specific master.
- Detecting an access error—The current bus cycle is terminated with an error response and $EARN$ and $EDRn$ capture information on the faulting reference. The error-terminated bus cycle typically initiates an error response in the originating bus master. For example, a processor core may respond with a bus error exception, while a data movement bus master may respond with an error interrupt. The processor can retrieve the captured error address and detail information simply by reading $E\{A,D\}Rn$. $CESR[SPERR]$ signals which error registers contain captured fault data.
- Overlapping region descriptors—Applying overlapping regions often reduces the number of descriptors required for a given set of access controls. In the overlapping memory space, the protection rights of the corresponding region descriptors are logically summed together (the boolean OR operator).

The following dual-core system example contains four bus masters:

- The two processors: CP0, CP1
- Two DMA engines: DMA1, a traditional data movement engine transferring data between RAM and peripherals and DMA2, a second engine transferring data to/from the RAM only

Consider the following region descriptor assignments:

Table 15-6. Overlapping region descriptor example

Region description	RGDn	CP0	CP1	DMA1	DMA2	
CP0 code	0	rwx	r--	—	—	Flash
CP1 code	1	r--	rwx	—	—	
CP0 data & stack	2	rw-	—	—	—	RAM
CP0 → CP1 shared data	2	3	r--	—	—	
CP1 → CP0 shared data	4					
CP1 data & stack	4	—	rw-	—	—	
Shared DMA data	5	rw-	rw-	rw	rw	
MPU	6	rw-	rw-	—	—	Peripheral space
Peripherals	7	rw-	rw-	rw	—	

In this example, there are eight descriptors used to span nine regions in the three main spaces of the system memory map: flash, RAM, and peripheral space. Each region indicates the specific permissions for each of the four bus masters and this definition provides an appropriate set of shared, private and executable memory spaces.

Of particular interest are the two overlapping spaces: region descriptors 2 & 3 and 3 & 4.

Application information

The space defined by RGD2 with no overlap is a private data and stack area that provides read/write access to CP0 only. The overlapping space between RGD2 and RGD3 defines a shared data space for passing data from CP0 to CP1 and the access controls are defined by the logical OR of the two region descriptors. Thus, CP0 has $(rw- \mid r--)$ = $(rw-)$ permissions, while CP1 has $(--- \mid r--)$ = $(r--)$ permission in this space. Both DMA engines are excluded from this shared processor data region. The overlapping spaces between RGD3 and RGD4 defines another shared data space, this one for passing data from CP1 to CP0. For this overlapping space, CP0 has $(r-- \mid ---)$ = $(r--)$ permission, while CP1 has $(rw- \mid r--)$ = $(rw-)$ permission. The non-overlapped space of RGD4 defines a private data and stack area for CP1 only.

The space defined by RGD5 is a shared data region, accessible by all four bus masters. Finally, the slave peripheral space mapped onto the IPS bus is partitioned into two regions:

- One containing the MPU's programming model accessible only to the two processor cores
- The remaining peripheral region accessible to both processors and the traditional DMA1 master

This example shows one possible application of the capabilities of the MPU in a typical system.

Chapter 16

Peripheral Bridge (AIPS-Lite)

16.1 Chip-specific AIPS information

16.1.1 Instantiation information

This device contains one peripheral bridge. The peripheral access protection is supported by AIPS. The MPU will not cover peripheral access protection.

16.1.2 Memory maps

The peripheral bridge is used to access the registers of most of the modules on this device. See S32K1xx_memory_map.xlsx attached to Reference Manual for the memory slot assignment.

AIPS_PACR0 – PACR31 refer to on platform peripherals with corresponding AIPS Peripheral bridge slot numbers from 0 -31. AIPS_OPACR0 – OPACR95 refer to off platform peripherals with corresponding AIPS Peripheral bridge slot numbers from 32 -127. For logical master ID assignments see [MPU Logical Bus Master Assignments](#).

16.1.2.1 Register reset values

The following table shows chip-specific reset values for AIPS registers:

Table 16-1. Register reset values

Register	S32K116	S32K118	S32K142	S32K144	S32K144W	S32K146	S32K148
MPRA	7770_0000	7770_0000	7770_0000	7770_0000	7770_0000	7770_0000	7777_0000
PACRA	5400_0000	5400_0000	5400_0000	5400_0000	5400_0000	5400_0000	5400_0000
PACRB	4400_0404	4400_0404	4400_0400	4400_0400	4400_0400	4400_0400	4400_0400
PACRD	4400_0000	4400_0000	4400_0000	4400_0000	4400_0000	4400_0000	4400_0000

Table continues on the next page...

Table 16-1. Register reset values (continued)

Register	S32K116	S32K118	S32K142	S32K144	S32K144W	S32K146	S32K148
OPACRA	4400_4000	4400_4000	4400_4444	4400_4444	4400_4444	4400_4444	4400_4444
OPACRB	0000_4000	0000_4400	0000_4400	0000_4400	0000_4400	0000_4400	0004_4440
OPACRC	0040_0044	0040_0044	0440_0044	0440_0044	0440_0044	0440_0044	0440_0044
OPACRD	4404_0444	4404_0444	4444_0400	4444_0400	4444_0400	4444_0400	4444_0400
OPACRE	4000_0040	4000_0040	4000_0040	4000_0040	4000_0040	4000_0040	4000_0040
OPACRF	4444_4400	4444_4400	4444_4400	4444_4400	4444_4400	4444_4400	4444_4400
OPACRG	0040_0000	0040_0000	0040_0000	0040_0000	0040_0000	0040_0000	0040_4400
OPACRH	0040_0000	0040_0000	0040_0000	0040_0000	0040_0000	0040_0000	0040_0000
OPACRI	0004_4440	0004_4440	0404_4440	0404_4440	0404_4440	0404_4440	0404_4444
OPACRJ	0044_0000	0044_0000	0044_0000	0044_0000	0044_0000	0044_4044	0044_4044
OPACRK	0004_0000	0004_0000	0004_0000	0004_0000	0004_0000	0004_0000	4404_0040
OPACRL	0000_0444	0000_0444	0000_0444	0000_0444	0000_0444	0000_0444	0400_0444

16.1.2.2 Register information

In S32K11x, CMU0 and CMU1 reside on Off-platform slots 30 and 31 respectively, and access of the same is controlled by bits OPACRD[0:7] shown below. In S32K14x and S32K14xW variants, these bits are Reserved as show in [AIPS register descriptions](#).

Table 16-2. OPARCD register

Bit fields	S32K14x	S32K11x
Bitfiled[0:7]	Reserved	Bit 0: TP7 (Trusted Protect 7)
		Bit 1: WP7 (Write Protect 7)
		Bit 2: SP7 (Supervisor Protect 7)
		Bit 3: Reserved
		Bit 4: TP6 (Trusted Protect 6)
		Bit 5: WP6 (Write Protect 6)
		Bit 6: SP6 (Supervisor Protect 6)
		Bit 7: Reserved

Similarly, CMU0 and CMU1 reside on on-platform slots 30 and 31 respectively, and access of the same is controlled by bits PACRB[0:3] shown below. In S32K14x and S32K14xW variants, these bits are Reserved as show in [AIPS register descriptions](#).

Table 16-3. PARCB register

Bit fields	S32K14x	S32K11x
Bitfiled[0:3]	Reserved	Bit 0: TP7 (Trusted Protect 7)

Table continues on the next page...

Table 16-3. PARCB register (continued)

Bit fields	S32K14x	S32K11x
		Bit 1: WP7 (Write Protect 7)
		Bit 2: SP7 (Supervisor Protect 7)
		Bit 3: Reserved

16.2 Introduction

The peripheral bridge converts the crossbar switch interface to an interface that can access most of the slave peripherals on this chip.

The peripheral bridge occupies 64 MB of the address space, which is divided into peripheral slots of 4 KB. (It might be possible that all the peripheral slots are not used. See the memory map chapter for details on slot assignments.) The bridge includes separate clock enable inputs for each of the slots to accommodate slower peripherals.

16.2.1 Features

Key features of the peripheral bridge are:

- Supports peripheral slots with 8-, 16-, and 32-bit datapath width
- Programming model provides memory protection functionality

16.2.2 General operation

The slave devices connected to the peripheral bridge are modules which contain a programming model of control and status registers. The system masters read and write these registers through the peripheral bridge.

The register maps of the peripherals are located on 4-KB boundaries. Each peripheral is allocated one or more 4-KB block(s) of the memory map.

16.3 Memory map/register definition

The 32-bit peripheral bridge registers can be accessed only in supervisor mode by trusted bus masters. Additionally, these registers must be read from or written to only by a 32-bit aligned access. The peripheral bridge registers are mapped into the Peripheral Access Control Register A PACRA[PACR0] address space.

16.3.1 AIPS register descriptions

16.3.1.1 AIPS memory map

AIPS_Lite base address: 4000_0000h

Offset	Register	Width (In bits)	Access	Reset value
0h	Master Privilege Register A (MPRA)	32	RW	2C36_0000h
20h	Peripheral Access Control Register (PACRA)	32	RW	5400_0000h
24h	Peripheral Access Control Register (PACRB)	32	RW	4400_0400h
2Ch	Peripheral Access Control Register (PACRD)	32	RW	4400_0000h
40h	Off-Platform Peripheral Access Control Register (OPACRA)	32	RW	4400_4444h
44h	Off-Platform Peripheral Access Control Register (OPACRB)	32	RW	0004_4440h
48h	Off-Platform Peripheral Access Control Register (OPACRC)	32	RW	0440_0044h
4Ch	Off-Platform Peripheral Access Control Register (OPACRD)	32	RW	4444_0400h
50h	Off-Platform Peripheral Access Control Register (OPACRE)	32	RW	4000_0040h
54h	Off-Platform Peripheral Access Control Register (OPACRF)	32	RW	4444_4400h
58h	Off-Platform Peripheral Access Control Register (OPACRG)	32	RW	0040_4400h
5Ch	Off-Platform Peripheral Access Control Register (OPACRH)	32	RW	0040_0000h
60h	Off-Platform Peripheral Access Control Register (OPACRI)	32	RW	0404_4444h
64h	Off-Platform Peripheral Access Control Register (OPACRJ)	32	RW	0044_4044h
68h	Off-Platform Peripheral Access Control Register (OPACRK)	32	RW	4404_0040h
6Ch	Off-Platform Peripheral Access Control Register (OPACRL)	32	RW	0400_0444h

16.3.1.2 Master Privilege Register A (MPRA)

16.3.1.2.1 Offset

Register	Offset
MPRA	0h

16.3.1.2.2 Function

The MPRA specifies identical 4-bit fields defining the access-privilege level associated with a bus master to various peripherals on the chip. The register provides one field per bus master.

A register field that maps to an unimplemented master or peripheral behaves as read-only-zero.

Each master is assigned a logical ID from 0 to 15. See the master logical ID assignment table in the chip-specific AIPS information.

16.3.1.2.3 Diagram

Bits	31	30	29	28	27	26	25	24	23	22	21	20	19	18	17	16
R	0	MTR0	MTW0	MPL0	0	MTR1	MTW1	MPL1	0	MTR2	MTW2	MPL2	0	MTR3	MTW3	MPL3
W																
Reset	0	0	1	0	1	1	0	0	0	0	1	1	0	1	1	0
Bits	15	14	13	12	11	10	9	8	7	6	5	4	3	2	1	0
R	0	Reserved				0	Reserved				0	Reserved				
W																
Reset	0	0	0	0	0	0	0	0	0	0	0	0	0	0	0	0

16.3.1.2.4 Fields

Field	Function
31	Reserved
—	
30 MTR0	Master 0 Trusted For Read Determines whether the master is trusted for read accesses. 0b - This master is not trusted for read accesses. 1b - This master is trusted for read accesses.
29 MTW0	Master 0 Trusted For Writes Determines whether the master is trusted for write accesses.

Table continues on the next page...

Memory map/register definition

Field	Function
	0b - This master is not trusted for write accesses. 1b - This master is trusted for write accesses.
28 MPL0	Master 0 Privilege Level Specifies how the privilege level of the master is determined. 0b - Accesses from this master are forced to user-mode. 1b - Accesses from this master are not forced to user-mode.
27 —	Reserved
26 MTR1	Master 1 Trusted for Read Determines whether the master is trusted for read accesses. 0b - This master is not trusted for read accesses. 1b - This master is trusted for read accesses.
25 MTW1	Master 1 Trusted for Writes Determines whether the master is trusted for write accesses. 0b - This master is not trusted for write accesses. 1b - This master is trusted for write accesses.
24 MPL1	Master 1 Privilege Level Specifies how the privilege level of the master is determined. 0b - Accesses from this master are forced to user-mode. 1b - Accesses from this master are not forced to user-mode.
23 —	Reserved
22 MTR2	Master 2 Trusted For Read Determines whether the master is trusted for read accesses. 0b - This master is not trusted for read accesses. 1b - This master is trusted for read accesses.
21 MTW2	Master 2 Trusted For Writes Determines whether the master is trusted for write accesses. 0b - This master is not trusted for write accesses. 1b - This master is trusted for write accesses.
20 MPL2	Master 2 Privilege Level Specifies how the privilege level of the master is determined. 0b - Accesses from this master are forced to user-mode. 1b - Accesses from this master are not forced to user-mode.
19 —	Reserved
18 MTR3	Master 3 Trusted For Read Determines whether the master is trusted for read accesses. 0b - This master is not trusted for read accesses. 1b - This master is trusted for read accesses.
17 MTW3	Master 3 Trusted For Writes Determines whether the master is trusted for write accesses. 0b - This master is not trusted for write accesses. 1b - This master is trusted for write accesses.
16	Master 3 Privilege Level

Table continues on the next page...

Field	Function
MPL3	Specifies how the privilege level of the master is determined. 0b - Accesses from this master are forced to user-mode. 1b - Accesses from this master are not forced to user-mode.
15 —	Reserved
14-12 —	Reserved
11 —	Reserved
10-8 —	Reserved
7 —	Reserved
6-4 —	Reserved
3 —	Reserved
2-0 —	Reserved

16.3.1.3 Peripheral Access Control Register (PACRA)

16.3.1.3.1 Offset

Register	Offset
PACRA	20h

16.3.1.3.2 Function

Each PACR register consists of eight 4-bit PACR fields. Each PACR field defines the access levels for a particular on-platform peripheral. The peripheral assignment to each PACR field is defined by the memory map slot of the peripheral. See the chip-specific AIPS information for the field assignment of a particular peripheral.

Every PACR field to which no peripheral is assigned is reserved. Reads to reserved locations return zeros, and writes are ignored.

16.3.1.3.3 Diagram

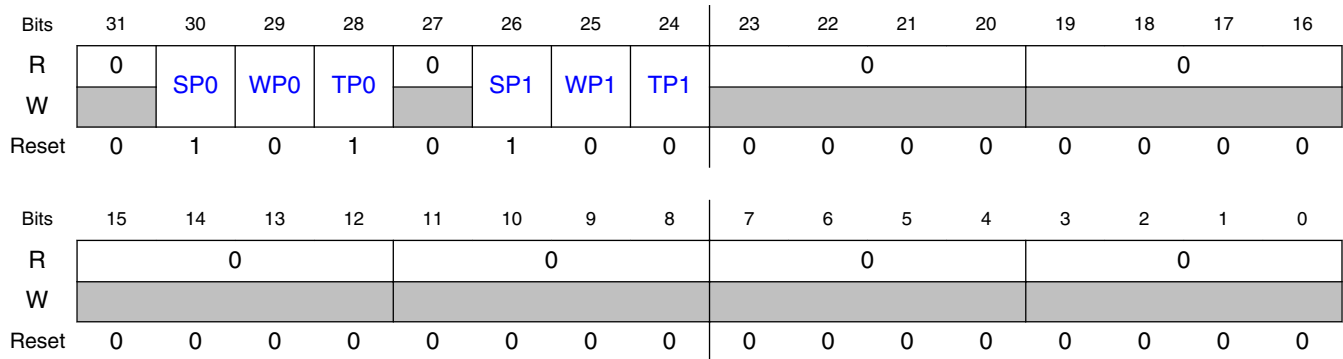

16.3.1.3.4 Fields

Field	Function
31 —	Reserved
30 SP0	<p>Supervisor Protect</p> <p>Determines whether the peripheral requires supervisor privilege level for accesses. When this field is set, the master privilege level must indicate the supervisor access attribute, and the MPRx[MPLn] control field for the master must be set. If not, access terminates with an error response and no peripheral access initiates.</p> <p>0b - This peripheral does not require supervisor privilege level for accesses. 1b - This peripheral requires supervisor privilege level for accesses.</p>
29 WP0	<p>Write Protect</p> <p>Determines whether the peripheral allows write accesses. When this field is set and a write access is attempted, access terminates with an error response and no peripheral access initiates.</p> <p>0b - This peripheral allows write accesses. 1b - This peripheral is write protected.</p>
28 TP0	<p>Trusted Protect</p> <p>Determines whether the peripheral allows accesses from an untrusted master. When this field is set and an access is attempted by an untrusted master, the access terminates with an error response and no peripheral access initiates.</p> <p>0b - Accesses from an untrusted master are allowed. 1b - Accesses from an untrusted master are not allowed.</p>
27 —	Reserved
26 SP1	<p>Supervisor Protect</p> <p>Determines whether the peripheral requires supervisor privilege level for accesses. When this field is set, the master privilege level must indicate the supervisor access attribute, and the MPRx[MPLn] control field for the master must be set. If not, access terminates with an error response and no peripheral access initiates.</p> <p>0b - This peripheral does not require supervisor privilege level for accesses. 1b - This peripheral requires supervisor privilege level for accesses.</p>
25	Write Protect

Table continues on the next page...

Field	Function
WP1	Determines whether the peripheral allows write accesses. When this field is set and a write access is attempted, access terminates with an error response and no peripheral access initiates. 0b - This peripheral allows write accesses. 1b - This peripheral is write protected.
24 TP1	Trusted Protect Determines whether the peripheral allows accesses from an untrusted master. When this field is set and an access is attempted by an untrusted master, the access terminates with an error response and no peripheral access initiates. 0b - Accesses from an untrusted master are allowed. 1b - Accesses from an untrusted master are not allowed.
23-20 —	Reserved
19-16 —	Reserved
15-12 —	Reserved
11-8 —	Reserved
7-4 —	Reserved
3-0 —	Reserved

16.3.1.4 Peripheral Access Control Register (PACRB)

16.3.1.4.1 Offset

Register	Offset
PACRB	24h

16.3.1.4.2 Function

Each PACR register consists of eight 4-bit PACR fields. Each PACR field defines the access levels for a particular on-platform peripheral. The peripheral assignment to each PACR field is defined by the memory map slot of the peripheral. See the chip-specific AIPS information for the field assignment of a particular peripheral.

Every PACR field to which no peripheral is assigned is reserved. Reads to reserved locations return zeros, and writes are ignored.

16.3.1.4.3 Diagram

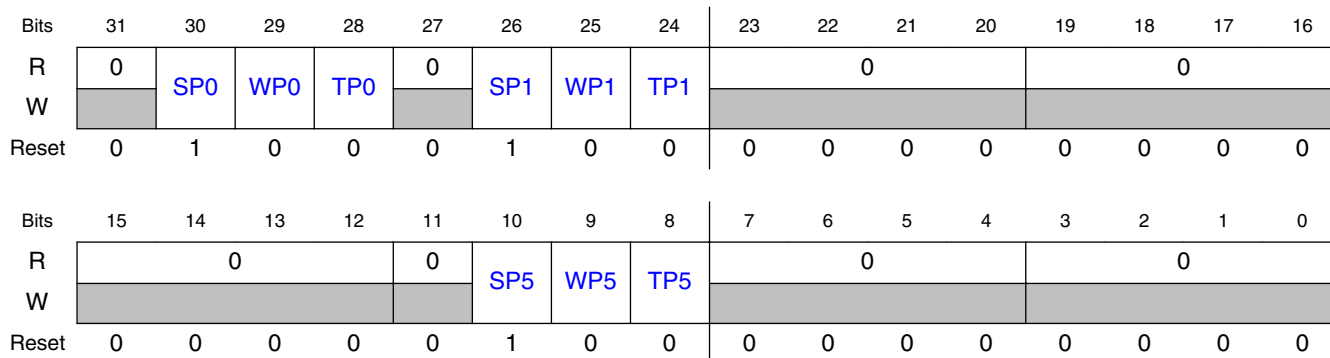

16.3.1.4.4 Fields

Field	Function
31 —	Reserved
30 SP0	<p>Supervisor Protect</p> <p>Determines whether the peripheral requires supervisor privilege level for accesses. When this field is set, the master privilege level must indicate the supervisor access attribute, and the MPRx[MPLn] control field for the master must be set. If not, access terminates with an error response and no peripheral access initiates.</p> <p>0b - This peripheral does not require supervisor privilege level for accesses. 1b - This peripheral requires supervisor privilege level for accesses.</p>
29 WP0	<p>Write Protect</p> <p>Determines whether the peripheral allows write accesses. When this field is set and a write access is attempted, access terminates with an error response and no peripheral access initiates.</p> <p>0b - This peripheral allows write accesses. 1b - This peripheral is write protected.</p>
28 TP0	<p>Trusted Protect</p> <p>Determines whether the peripheral allows accesses from an untrusted master. When this field is set and an access is attempted by an untrusted master, the access terminates with an error response and no peripheral access initiates.</p> <p>0b - Accesses from an untrusted master are allowed. 1b - Accesses from an untrusted master are not allowed.</p>
27 —	Reserved
26 SP1	<p>Supervisor Protect</p> <p>Determines whether the peripheral requires supervisor privilege level for accesses. When this field is set, the master privilege level must indicate the supervisor access attribute, and the MPRx[MPLn] control field for the master must be set. If not, access terminates with an error response and no peripheral access initiates.</p> <p>0b - This peripheral does not require supervisor privilege level for accesses. 1b - This peripheral requires supervisor privilege level for accesses.</p>

Table continues on the next page...

Field	Function
25 WP1	Write Protect Determines whether the peripheral allows write accesses. When this field is set and a write access is attempted, access terminates with an error response and no peripheral access initiates. 0b - This peripheral allows write accesses. 1b - This peripheral is write protected.
24 TP1	Trusted Protect Determines whether the peripheral allows accesses from an untrusted master. When this field is set and an access is attempted by an untrusted master, the access terminates with an error response and no peripheral access initiates. 0b - Accesses from an untrusted master are allowed. 1b - Accesses from an untrusted master are not allowed.
23-20 —	Reserved
19-16 —	Reserved
15-12 —	Reserved
11 —	Reserved
10 SP5	Supervisor Protect Determines whether the peripheral requires supervisor privilege level for accesses. When this field is set, the master privilege level must indicate the supervisor access attribute, and the MPRx[MPLn] control field for the master must be set. If not, access terminates with an error response and no peripheral access initiates. 0b - This peripheral does not require supervisor privilege level for accesses. 1b - This peripheral requires supervisor privilege level for accesses.
9 WP5	Write Protect Determines whether the peripheral allows write accesses. When this field is set and a write access is attempted, access terminates with an error response and no peripheral access initiates. 0b - This peripheral allows write accesses. 1b - This peripheral is write protected.
8 TP5	Trusted Protect Determines whether the peripheral allows accesses from an untrusted master. When this field is set and an access is attempted by an untrusted master, the access terminates with an error response and no peripheral access initiates. 0b - Accesses from an untrusted master are allowed. 1b - Accesses from an untrusted master are not allowed.
7-4 —	Reserved
3-0 —	Reserved

16.3.1.5 Peripheral Access Control Register (PACRD)

16.3.1.5.1 Offset

Register	Offset
PACRD	2Ch

16.3.1.5.2 Function

Each PACR register consists of eight 4-bit PACR fields. Each PACR field defines the access levels for a particular on-platform peripheral. The peripheral assignment to each PACR field is defined by the memory map slot of the peripheral. See the chip-specific AIPS information for the field assignment of a particular peripheral.

Every PACR field to which no peripheral is assigned is reserved. Reads to reserved locations return zeros, and writes are ignored.

16.3.1.5.3 Diagram

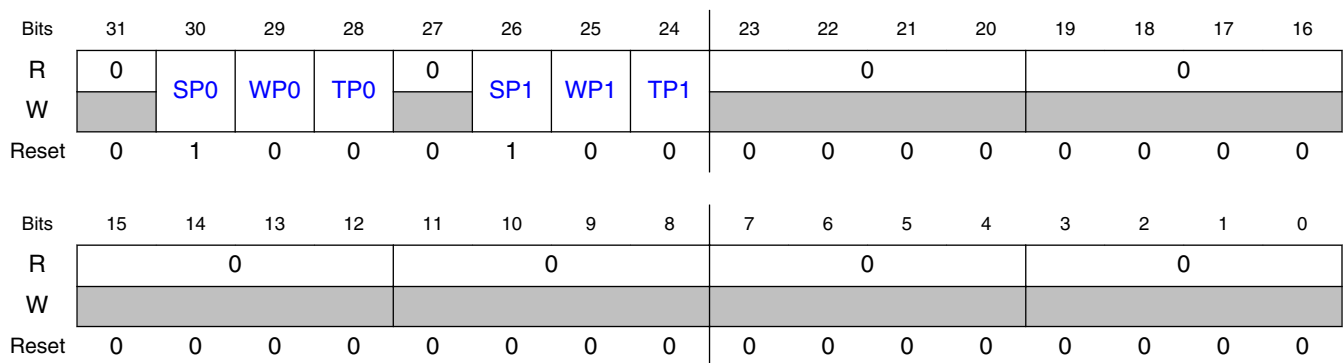

16.3.1.5.4 Fields

Field	Function
31	Reserved
—	
30 SP0	<p>Supervisor Protect</p> <p>Determines whether the peripheral requires supervisor privilege level for accesses. When this field is set, the master privilege level must indicate the supervisor access attribute, and the MPRx[MPLn] control field for the master must be set. If not, access terminates with an error response and no peripheral access initiates.</p> <p>0b - This peripheral does not require supervisor privilege level for accesses.</p>

Table continues on the next page...

Field	Function
	1b - This peripheral requires supervisor privilege level for accesses.
29 WP0	Write Protect Determines whether the peripheral allows write accesses. When this field is set and a write access is attempted, access terminates with an error response and no peripheral access initiates. 0b - This peripheral allows write accesses. 1b - This peripheral is write protected.
28 TP0	Trusted Protect Determines whether the peripheral allows accesses from an untrusted master. When this field is set and an access is attempted by an untrusted master, the access terminates with an error response and no peripheral access initiates. 0b - Accesses from an untrusted master are allowed. 1b - Accesses from an untrusted master are not allowed.
27 —	Reserved
26 SP1	Supervisor Protect Determines whether the peripheral requires supervisor privilege level for accesses. When this field is set, the master privilege level must indicate the supervisor access attribute, and the MPRx[MPLn] control field for the master must be set. If not, access terminates with an error response and no peripheral access initiates. 0b - This peripheral does not require supervisor privilege level for accesses. 1b - This peripheral requires supervisor privilege level for accesses.
25 WP1	Write Protect Determines whether the peripheral allows write accesses. When this field is set and a write access is attempted, access terminates with an error response and no peripheral access initiates. 0b - This peripheral allows write accesses. 1b - This peripheral is write protected.
24 TP1	Trusted Protect Determines whether the peripheral allows accesses from an untrusted master. When this field is set and an access is attempted by an untrusted master, the access terminates with an error response and no peripheral access initiates. 0b - Accesses from an untrusted master are allowed. 1b - Accesses from an untrusted master are not allowed.
23-20 —	Reserved
19-16 —	Reserved
15-12 —	Reserved
11-8 —	Reserved
7-4 —	Reserved
3-0 —	Reserved

16.3.1.6 Off-Platform Peripheral Access Control Register (OPACRA)

16.3.1.6.1 Offset

Register	Offset
OPACRA	40h

16.3.1.6.2 Function

Each OPACR register consists of eight 4-bit OPACR fields. Each OPACR field defines the access levels for a particular off-platform peripheral. The peripheral assignment to each OPACR field is defined by the memory map slot of the peripheral. See the chip-specific AIPS information for the field assignment of a particular peripheral.

16.3.1.6.3 Diagram

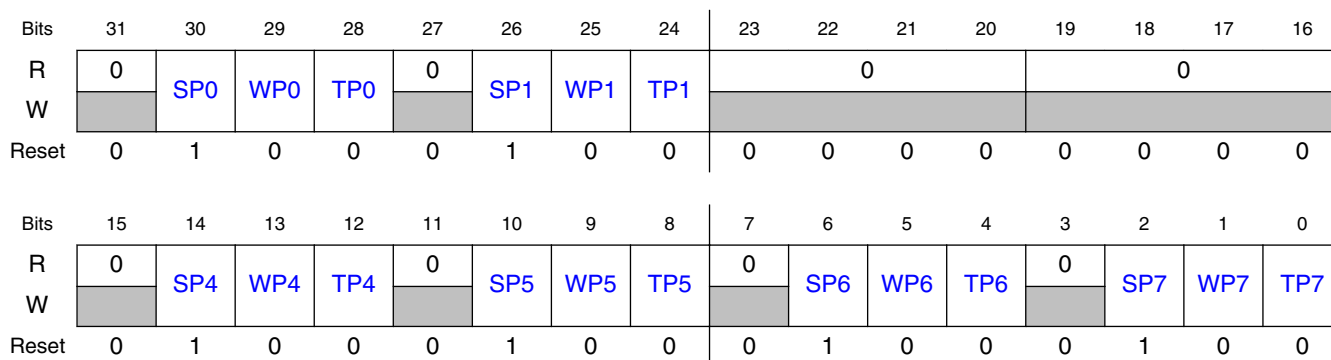

16.3.1.6.4 Fields

Field	Function
31	Reserved
—	
30 SP0	Supervisor Protect Determines whether the peripheral requires supervisor privilege level for accesses. When this field is set, the master privilege level must indicate the supervisor access attribute, and the MPRx[MPLn] control field for the master must be set. If not, access terminates with an error response and no peripheral access initiates. 0b - This peripheral does not require supervisor privilege level for accesses. 1b - This peripheral requires supervisor privilege level for accesses.

Table continues on the next page...

Field	Function
29 WP0	Write Protect Determines whether the peripheral allows write accesses. When this field is set and a write access is attempted, access terminates with an error response and no peripheral access initiates. 0b - This peripheral allows write accesses. 1b - This peripheral is write protected.
28 TP0	Trusted Protect Determines whether the peripheral allows accesses from an untrusted master. When this bit is set and an access is attempted by an untrusted master, the access terminates with an error response and no peripheral access initiates. 0b - Accesses from an untrusted master are allowed. 1b - Accesses from an untrusted master are not allowed.
27 —	Reserved
26 SP1	Supervisor Protect Determines whether the peripheral requires supervisor privilege level for access. When this field is set, the master privilege level must indicate the supervisor access attribute, and the MPRx[MPLn] control field for the master must be set. If not, access terminates with an error response and no peripheral access initiates. 0b - This peripheral does not require supervisor privilege level for accesses. 1b - This peripheral requires supervisor privilege level for accesses.
25 WP1	Write Protect Determines whether the peripheral allows write accesses. When this field is set and a write access is attempted, access terminates with an error response and no peripheral access initiates. 0b - This peripheral allows write accesses. 1b - This peripheral is write protected.
24 TP1	Trusted Protect Determines whether the peripheral allows accesses from an untrusted master. When this field is set and an access is attempted by an untrusted master, the access terminates with an error response and no peripheral access initiates. 0b - Accesses from an untrusted master are allowed. 1b - Accesses from an untrusted master are not allowed.
23-20 —	Reserved
19-16 —	Reserved
15 —	Reserved
14 SP4	Supervisor Protect Determines whether the peripheral requires supervisor privilege level for access. When this bit is set, the master privilege level must indicate the supervisor access attribute, and the MPRx[MPLn] control bit for the master must be set. If not, access terminates with an error response and no peripheral access initiates. 0b - This peripheral does not require supervisor privilege level for accesses. 1b - This peripheral requires supervisor privilege level for accesses.
13 WP4	Write Protect Determines whether the peripheral allows write accesses. When this field is set and a write access is attempted, access terminates with an error response and no peripheral access initiates.

Table continues on the next page...

Memory map/register definition

Field	Function
	<p>0b - This peripheral allows write accesses. 1b - This peripheral is write protected.</p>
12 TP4	<p>Trusted Protect</p> <p>Determines whether the peripheral allows accesses from an untrusted master. When this bit is set and an access is attempted by an untrusted master, the access terminates with an error response and no peripheral access initiates.</p> <p>0b - Accesses from an untrusted master are allowed. 1b - Accesses from an untrusted master are not allowed.</p>
11 —	Reserved
10 SP5	<p>Supervisor Protect</p> <p>Determines whether the peripheral requires supervisor privilege level for accesses. When this field is set, the master privilege level must indicate the supervisor access attribute, and the MPRx[MPLn] control field for the master must be set. If not, access terminates with an error response and no peripheral access initiates.</p> <p>0b - This peripheral does not require supervisor privilege level for accesses. 1b - This peripheral requires supervisor privilege level for accesses.</p>
9 WP5	<p>Write Protect</p> <p>Determines whether the peripheral allows write accesses. When this field is set and a write access is attempted, access terminates with an error response and no peripheral access initiates.</p> <p>0b - This peripheral allows write accesses. 1b - This peripheral is write protected.</p>
8 TP5	<p>Trusted Protect</p> <p>Determines whether the peripheral allows accesses from an untrusted master. When this field is set and an access is attempted by an untrusted master, the access terminates with an error response and no peripheral access initiates.</p> <p>0b - Accesses from an untrusted master are allowed. 1b - Accesses from an untrusted master are not allowed.</p>
7 —	Reserved
6 SP6	<p>Supervisor Protect</p> <p>Determines whether the peripheral requires supervisor privilege level for accesses. When this field is set, the master privilege level must indicate the supervisor access attribute, and the MPRx[MPLn] control field for the master must be set. If not, access terminates with an error response and no peripheral access initiates.</p> <p>0b - This peripheral does not require supervisor privilege level for accesses. 1b - This peripheral requires supervisor privilege level for accesses.</p>
5 WP6	<p>Write Protect</p> <p>Determines whether the peripheral allows write accesses. When this field is set and a write access is attempted, access terminates with an error response and no peripheral access initiates.</p> <p>0b - This peripheral allows write accesses. 1b - This peripheral is write protected.</p>
4 TP6	<p>Trusted Protect</p> <p>Determines whether the peripheral allows accesses from an untrusted master. When this field is set and an access is attempted by an untrusted master, the access terminates with an error response and no peripheral access initiates.</p> <p>0b - Accesses from an untrusted master are allowed. 1b - Accesses from an untrusted master are not allowed.</p>

Table continues on the next page...

Field	Function
3 —	Reserved
2 SP7	<p>Supervisor Protect</p> <p>Determines whether the peripheral requires supervisor privilege level for accesses. When this field is set, the master privilege level must indicate the supervisor access attribute, and the MPRx[MPLn] control field for the master must be set. If not, access terminates with an error response and no peripheral access initiates.</p> <p>0b - This peripheral does not require supervisor privilege level for accesses. 1b - This peripheral requires supervisor privilege level for accesses.</p>
1 WP7	<p>Write Protect</p> <p>Determines whether the peripheral allows accesses from an untrusted master. When this field is set and an access is attempted by an untrusted master, the access terminates with an error response and no peripheral access initiates.</p> <p>0b - This peripheral allows write accesses. 1b - This peripheral is write protected.</p>
0 TP7	<p>Trusted Protect</p> <p>Determines whether the peripheral allows accesses from an untrusted master. When this field is set and an access is attempted by an untrusted master, the access terminates with an error response and no peripheral access initiates.</p> <p>0b - Accesses from an untrusted master are allowed. 1b - Accesses from an untrusted master are not allowed.</p>

16.3.1.7 Off-Platform Peripheral Access Control Register (OPACRB)

16.3.1.7.1 Offset

Register	Offset
OPACRB	44h

16.3.1.7.2 Function

Each OPACR register consists of eight 4-bit OPACR fields. Each OPACR field defines the access levels for a particular off-platform peripheral. The peripheral assignment to each OPACR field is defined by the memory map slot of the peripheral. See the chip-specific AIPS information for the field assignment of a particular peripheral.

16.3.1.7.3 Diagram

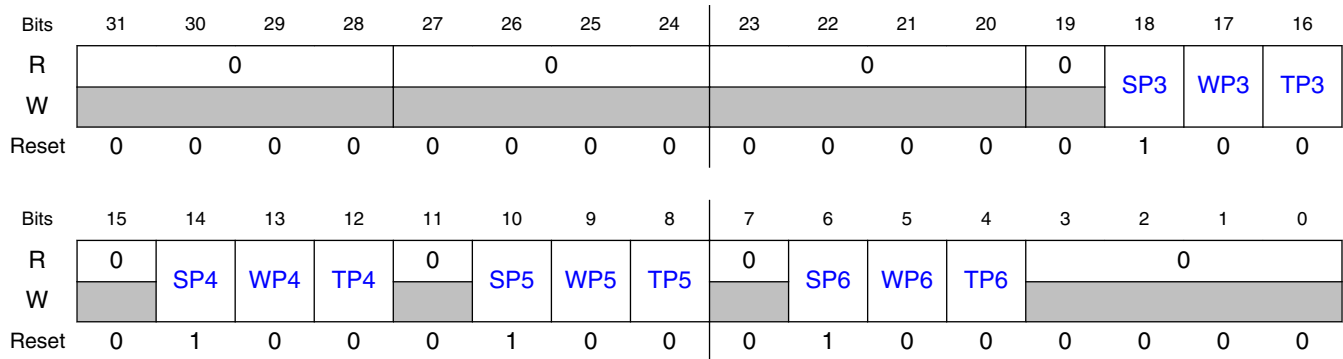

16.3.1.7.4 Fields

Field	Function
31-28 —	Reserved
27-24 —	Reserved
23-20 —	Reserved
19 —	Reserved
18 SP3	Supervisor Protect Determines whether the peripheral requires supervisor privilege level for accesses. When this field is set, the master privilege level must indicate the supervisor access attribute, and the MPRx[MPLn] control field for the master must be set. If not, access terminates with an error response and no peripheral access initiates. 0b - This peripheral does not require supervisor privilege level for accesses. 1b - This peripheral requires supervisor privilege level for accesses.
17 WP3	Write Protect Determines whether the peripheral allows write access. When this bit is set and a write access is attempted, access terminates with an error response and no peripheral access initiates. 0b - This peripheral allows write accesses. 1b - This peripheral is write protected.
16 TP3	Trusted Protect Determines whether the peripheral allows accesses from an untrusted master. When this field is set and an access is attempted by an untrusted master, the access terminates with an error response and no peripheral access initiates. 0b - Accesses from an untrusted master are allowed. 1b - Accesses from an untrusted master are not allowed.
15 —	Reserved
14	Supervisor Protect

Table continues on the next page...

Field	Function
SP4	Determines whether the peripheral requires supervisor privilege level for access. When this bit is set, the master privilege level must indicate the supervisor access attribute, and the MPRx[MPLn] control bit for the master must be set. If not, access terminates with an error response and no peripheral access initiates. 0b - This peripheral does not require supervisor privilege level for accesses. 1b - This peripheral requires supervisor privilege level for accesses.
13 WP4	Write Protect Determines whether the peripheral allows write accesses. When this field is set and a write access is attempted, access terminates with an error response and no peripheral access initiates. 0b - This peripheral allows write accesses. 1b - This peripheral is write protected.
12 TP4	Trusted Protect Determines whether the peripheral allows accesses from an untrusted master. When this bit is set and an access is attempted by an untrusted master, the access terminates with an error response and no peripheral access initiates. 0b - Accesses from an untrusted master are allowed. 1b - Accesses from an untrusted master are not allowed.
11 —	Reserved
10 SP5	Supervisor Protect Determines whether the peripheral requires supervisor privilege level for accesses. When this field is set, the master privilege level must indicate the supervisor access attribute, and the MPRx[MPLn] control field for the master must be set. If not, access terminates with an error response and no peripheral access initiates. 0b - This peripheral does not require supervisor privilege level for accesses. 1b - This peripheral requires supervisor privilege level for accesses.
9 WP5	Write Protect Determines whether the peripheral allows write accesses. When this field is set and a write access is attempted, access terminates with an error response and no peripheral access initiates. 0b - This peripheral allows write accesses. 1b - This peripheral is write protected.
8 TP5	Trusted Protect Determines whether the peripheral allows accesses from an untrusted master. When this field is set and an access is attempted by an untrusted master, the access terminates with an error response and no peripheral access initiates. 0b - Accesses from an untrusted master are allowed. 1b - Accesses from an untrusted master are not allowed.
7 —	Reserved
6 SP6	Supervisor Protect Determines whether the peripheral requires supervisor privilege level for accesses. When this field is set, the master privilege level must indicate the supervisor access attribute, and the MPRx[MPLn] control field for the master must be set. If not, access terminates with an error response and no peripheral access initiates. 0b - This peripheral does not require supervisor privilege level for accesses. 1b - This peripheral requires supervisor privilege level for accesses.
5 WP6	Write Protect

Table continues on the next page...

Memory map/register definition

Field	Function
	Determines whether the peripheral allows write accesses. When this field is set and a write access is attempted, access terminates with an error response and no peripheral access initiates. 0b - This peripheral allows write accesses. 1b - This peripheral is write protected.
4 TP6	Trusted Protect Determines whether the peripheral allows accesses from an untrusted master. When this field is set and an access is attempted by an untrusted master, the access terminates with an error response and no peripheral access initiates. 0b - Accesses from an untrusted master are allowed. 1b - Accesses from an untrusted master are not allowed.
3-0 —	Reserved

16.3.1.8 Off-Platform Peripheral Access Control Register (OPACRC)

16.3.1.8.1 Offset

Register	Offset
OPACRC	48h

16.3.1.8.2 Function

Each OPACR register consists of eight 4-bit OPACR fields. Each OPACR field defines the access levels for a particular off-platform peripheral. The peripheral assignment to each OPACR field is defined by the memory map slot of the peripheral. See the chip-specific AIPS information for the field assignment of a particular peripheral.

16.3.1.8.3 Diagram

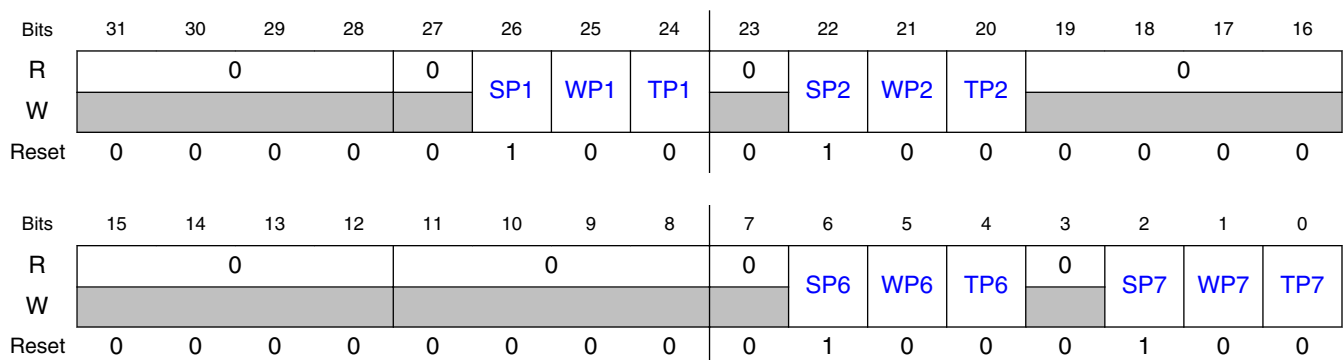

16.3.1.8.4 Fields

Field	Function
31-28 —	Reserved
27 —	Reserved
26 SP1	<p>Supervisor Protect</p> <p>Determines whether the peripheral requires supervisor privilege level for access. When this field is set, the master privilege level must indicate the supervisor access attribute, and the MPRx[MPLn] control field for the master must be set. If not, access terminates with an error response and no peripheral access initiates.</p> <p>0b - This peripheral does not require supervisor privilege level for accesses. 1b - This peripheral requires supervisor privilege level for accesses.</p>
25 WP1	<p>Write Protect</p> <p>Determines whether the peripheral allows write accesses. When this field is set and a write access is attempted, access terminates with an error response and no peripheral access initiates.</p> <p>0b - This peripheral allows write accesses. 1b - This peripheral is write protected.</p>
24 TP1	<p>Trusted Protect</p> <p>Determines whether the peripheral allows accesses from an untrusted master. When this field is set and an access is attempted by an untrusted master, the access terminates with an error response and no peripheral access initiates.</p> <p>0b - Accesses from an untrusted master are allowed. 1b - Accesses from an untrusted master are not allowed.</p>
23 —	Reserved
22 SP2	<p>Supervisor Protect</p> <p>Determines whether the peripheral requires supervisor privilege level for access. When this bit is set, the master privilege level must indicate the supervisor access attribute, and the MPRx[MPLn] control bit for the master must be set. If not, access terminates with an error response and no peripheral access initiates.</p> <p>0b - This peripheral does not require supervisor privilege level for accesses. 1b - This peripheral requires supervisor privilege level for accesses.</p>
21 WP2	<p>Write Protect</p> <p>Determines whether the peripheral allows write accesses. When this field is set and a write access is attempted, access terminates with an error response and no peripheral access initiates.</p> <p>0b - This peripheral allows write accesses. 1b - This peripheral is write protected.</p>
20 TP2	<p>Trusted Protect</p> <p>Determines whether the peripheral allows accesses from an untrusted master. When this bit is set and an access is attempted by an untrusted master, the access terminates with an error response and no peripheral access initiates.</p> <p>0b - Accesses from an untrusted master are allowed. 1b - Accesses from an untrusted master are not allowed.</p>
19-16 —	Reserved

Table continues on the next page...

Memory map/register definition

Field	Function
15-12 —	Reserved
11-8 —	Reserved
7 —	Reserved
6 SP6	<p>Supervisor Protect</p> <p>Determines whether the peripheral requires supervisor privilege level for accesses. When this field is set, the master privilege level must indicate the supervisor access attribute, and the MPRx[MPLn] control field for the master must be set. If not, access terminates with an error response and no peripheral access initiates.</p> <p>0b - This peripheral does not require supervisor privilege level for accesses. 1b - This peripheral requires supervisor privilege level for accesses.</p>
5 WP6	<p>Write Protect</p> <p>Determines whether the peripheral allows write accesses. When this field is set and a write access is attempted, access terminates with an error response and no peripheral access initiates.</p> <p>0b - This peripheral allows write accesses. 1b - This peripheral is write protected.</p>
4 TP6	<p>Trusted Protect</p> <p>Determines whether the peripheral allows accesses from an untrusted master. When this field is set and an access is attempted by an untrusted master, the access terminates with an error response and no peripheral access initiates.</p> <p>0b - Accesses from an untrusted master are allowed. 1b - Accesses from an untrusted master are not allowed.</p>
3 —	Reserved
2 SP7	<p>Supervisor Protect</p> <p>Determines whether the peripheral requires supervisor privilege level for accesses. When this field is set, the master privilege level must indicate the supervisor access attribute, and the MPRx[MPLn] control field for the master must be set. If not, access terminates with an error response and no peripheral access initiates.</p> <p>0b - This peripheral does not require supervisor privilege level for accesses. 1b - This peripheral requires supervisor privilege level for accesses.</p>
1 WP7	<p>Write Protect</p> <p>Determines whether the peripheral allows accesses from an untrusted master. When this field is set and an access is attempted by an untrusted master, the access terminates with an error response and no peripheral access initiates.</p> <p>0b - This peripheral allows write accesses. 1b - This peripheral is write protected.</p>
0 TP7	<p>Trusted Protect</p> <p>Determines whether the peripheral allows accesses from an untrusted master. When this field is set and an access is attempted by an untrusted master, the access terminates with an error response and no peripheral access initiates.</p> <p>0b - Accesses from an untrusted master are allowed. 1b - Accesses from an untrusted master are not allowed.</p>

16.3.1.9 Off-Platform Peripheral Access Control Register (OPACRD)

16.3.1.9.1 Offset

Register	Offset
OPACRD	4Ch

16.3.1.9.2 Function

Each OPACR register consists of eight 4-bit OPACR fields. Each OPACR field defines the access levels for a particular off-platform peripheral. The peripheral assignment to each OPACR field is defined by the memory map slot of the peripheral. See the chip-specific AIPS information for the field assignment of a particular peripheral.

16.3.1.9.3 Diagram

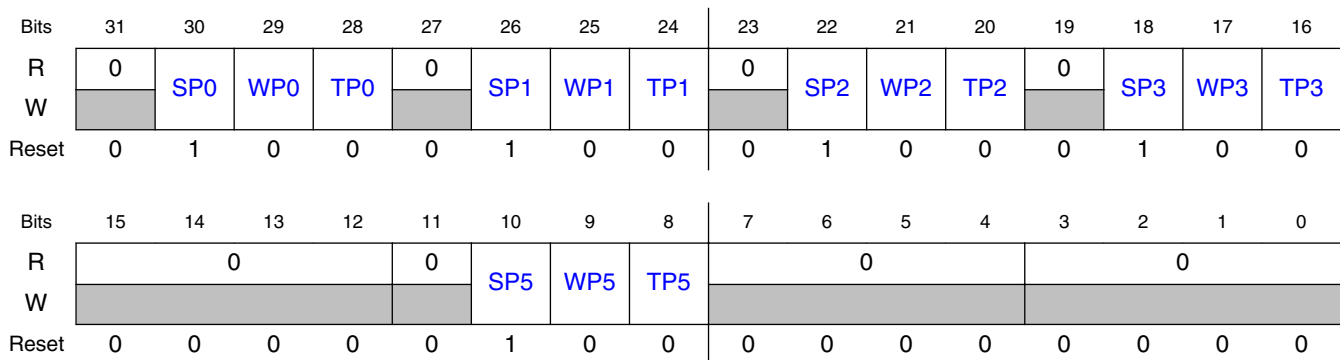

16.3.1.9.4 Fields

Field	Function
31	Reserved
—	
30 SP0	<p>Supervisor Protect</p> <p>Determines whether the peripheral requires supervisor privilege level for accesses. When this field is set, the master privilege level must indicate the supervisor access attribute, and the MPRx[MPLn] control field for the master must be set. If not, access terminates with an error response and no peripheral access initiates.</p> <p>0b - This peripheral does not require supervisor privilege level for accesses. 1b - This peripheral requires supervisor privilege level for accesses.</p>

Table continues on the next page...

Memory map/register definition

Field	Function
29 WP0	Write Protect Determines whether the peripheral allows write accesses. When this field is set and a write access is attempted, access terminates with an error response and no peripheral access initiates. 0b - This peripheral allows write accesses. 1b - This peripheral is write protected.
28 TP0	Trusted Protect Determines whether the peripheral allows accesses from an untrusted master. When this bit is set and an access is attempted by an untrusted master, the access terminates with an error response and no peripheral access initiates. 0b - Accesses from an untrusted master are allowed. 1b - Accesses from an untrusted master are not allowed.
27 —	Reserved
26 SP1	Supervisor Protect Determines whether the peripheral requires supervisor privilege level for access. When this field is set, the master privilege level must indicate the supervisor access attribute, and the MPRx[MPLn] control field for the master must be set. If not, access terminates with an error response and no peripheral access initiates. 0b - This peripheral does not require supervisor privilege level for accesses. 1b - This peripheral requires supervisor privilege level for accesses.
25 WP1	Write Protect Determines whether the peripheral allows write accesses. When this field is set and a write access is attempted, access terminates with an error response and no peripheral access initiates. 0b - This peripheral allows write accesses. 1b - This peripheral is write protected.
24 TP1	Trusted Protect Determines whether the peripheral allows accesses from an untrusted master. When this field is set and an access is attempted by an untrusted master, the access terminates with an error response and no peripheral access initiates. 0b - Accesses from an untrusted master are allowed. 1b - Accesses from an untrusted master are not allowed.
23 —	Reserved
22 SP2	Supervisor Protect Determines whether the peripheral requires supervisor privilege level for access. When this bit is set, the master privilege level must indicate the supervisor access attribute, and the MPRx[MPLn] control bit for the master must be set. If not, access terminates with an error response and no peripheral access initiates. 0b - This peripheral does not require supervisor privilege level for accesses. 1b - This peripheral requires supervisor privilege level for accesses.
21 WP2	Write Protect Determines whether the peripheral allows write accesses. When this field is set and a write access is attempted, access terminates with an error response and no peripheral access initiates. 0b - This peripheral allows write accesses. 1b - This peripheral is write protected.
20 TP2	Trusted Protect

Table continues on the next page...

Field	Function
	Determines whether the peripheral allows accesses from an untrusted master. When this bit is set and an access is attempted by an untrusted master, the access terminates with an error response and no peripheral access initiates. 0b - Accesses from an untrusted master are allowed. 1b - Accesses from an untrusted master are not allowed.
19 —	Reserved
18 SP3	Supervisor Protect Determines whether the peripheral requires supervisor privilege level for accesses. When this field is set, the master privilege level must indicate the supervisor access attribute, and the MPRx[MPLn] control field for the master must be set. If not, access terminates with an error response and no peripheral access initiates. 0b - This peripheral does not require supervisor privilege level for accesses. 1b - This peripheral requires supervisor privilege level for accesses.
17 WP3	Write Protect Determines whether the peripheral allows write access. When this bit is set and a write access is attempted, access terminates with an error response and no peripheral access initiates. 0b - This peripheral allows write accesses. 1b - This peripheral is write protected.
16 TP3	Trusted Protect Determines whether the peripheral allows accesses from an untrusted master. When this field is set and an access is attempted by an untrusted master, the access terminates with an error response and no peripheral access initiates. 0b - Accesses from an untrusted master are allowed. 1b - Accesses from an untrusted master are not allowed.
15-12 —	Reserved
11 —	Reserved
10 SP5	Supervisor Protect Determines whether the peripheral requires supervisor privilege level for accesses. When this field is set, the master privilege level must indicate the supervisor access attribute, and the MPRx[MPLn] control field for the master must be set. If not, access terminates with an error response and no peripheral access initiates. 0b - This peripheral does not require supervisor privilege level for accesses. 1b - This peripheral requires supervisor privilege level for accesses.
9 WP5	Write Protect Determines whether the peripheral allows write accesses. When this field is set and a write access is attempted, access terminates with an error response and no peripheral access initiates. 0b - This peripheral allows write accesses. 1b - This peripheral is write protected.
8 TP5	Trusted Protect Determines whether the peripheral allows accesses from an untrusted master. When this field is set and an access is attempted by an untrusted master, the access terminates with an error response and no peripheral access initiates. 0b - Accesses from an untrusted master are allowed. 1b - Accesses from an untrusted master are not allowed.
7-4	Reserved

Table continues on the next page...

Memory map/register definition

Field	Function
—	
3-0	Reserved
—	

16.3.1.10 Off-Platform Peripheral Access Control Register (OPACRE)

16.3.1.10.1 Offset

Register	Offset
OPACRE	50h

16.3.1.10.2 Function

Each OPACR register consists of eight 4-bit OPACR fields. Each OPACR field defines the access levels for a particular off-platform peripheral. The peripheral assignment to each OPACR field is defined by the memory map slot of the peripheral. See the chip-specific AIPS information for the field assignment of a particular peripheral.

16.3.1.10.3 Diagram

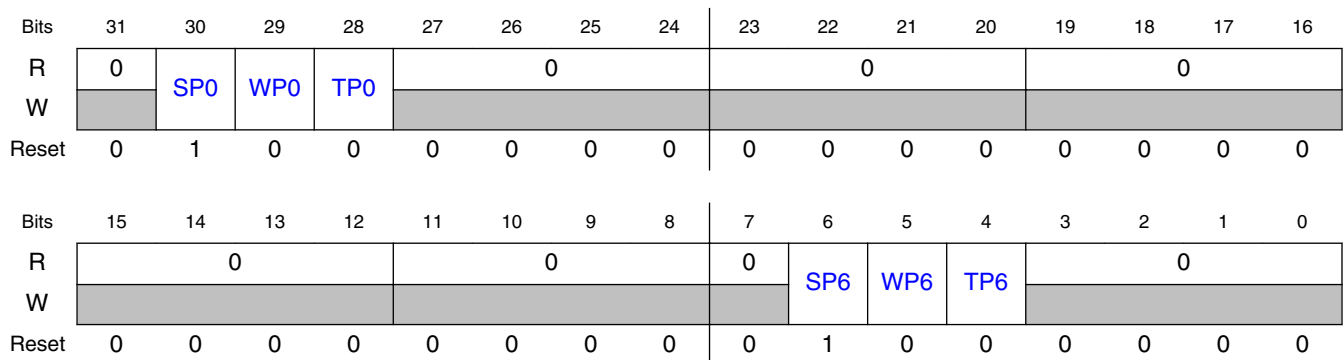

16.3.1.10.4 Fields

Field	Function
31	Reserved
—	

Table continues on the next page...

Field	Function
30 SP0	Supervisor Protect Determines whether the peripheral requires supervisor privilege level for accesses. When this field is set, the master privilege level must indicate the supervisor access attribute, and the MPRx[MPLn] control field for the master must be set. If not, access terminates with an error response and no peripheral access initiates. 0b - This peripheral does not require supervisor privilege level for accesses. 1b - This peripheral requires supervisor privilege level for accesses.
29 WP0	Write Protect Determines whether the peripheral allows write accesses. When this field is set and a write access is attempted, access terminates with an error response and no peripheral access initiates. 0b - This peripheral allows write accesses. 1b - This peripheral is write protected.
28 TP0	Trusted Protect Determines whether the peripheral allows accesses from an untrusted master. When this bit is set and an access is attempted by an untrusted master, the access terminates with an error response and no peripheral access initiates. 0b - Accesses from an untrusted master are allowed. 1b - Accesses from an untrusted master are not allowed.
27-24 —	Reserved
23-20 —	Reserved
19-16 —	Reserved
15-12 —	Reserved
11-8 —	Reserved
7 —	Reserved
6 SP6	Supervisor Protect Determines whether the peripheral requires supervisor privilege level for accesses. When this field is set, the master privilege level must indicate the supervisor access attribute, and the MPRx[MPLn] control field for the master must be set. If not, access terminates with an error response and no peripheral access initiates. 0b - This peripheral does not require supervisor privilege level for accesses. 1b - This peripheral requires supervisor privilege level for accesses.
5 WP6	Write Protect Determines whether the peripheral allows write accesses. When this field is set and a write access is attempted, access terminates with an error response and no peripheral access initiates. 0b - This peripheral allows write accesses. 1b - This peripheral is write protected.
4 TP6	Trusted Protect Determines whether the peripheral allows accesses from an untrusted master. When this field is set and an access is attempted by an untrusted master, the access terminates with an error response and no peripheral access initiates.

Table continues on the next page...

Memory map/register definition

Field	Function
	0b - Accesses from an untrusted master are allowed. 1b - Accesses from an untrusted master are not allowed.
3-0 —	Reserved

16.3.1.11 Off-Platform Peripheral Access Control Register (OPACRF)

16.3.1.11.1 Offset

Register	Offset
OPACRF	54h

16.3.1.11.2 Function

Each OPACR register consists of eight 4-bit OPACR fields. Each OPACR field defines the access levels for a particular off-platform peripheral. The peripheral assignment to each OPACR field is defined by the memory map slot of the peripheral. See the chip-specific AIPS information for the field assignment of a particular peripheral.

16.3.1.11.3 Diagram

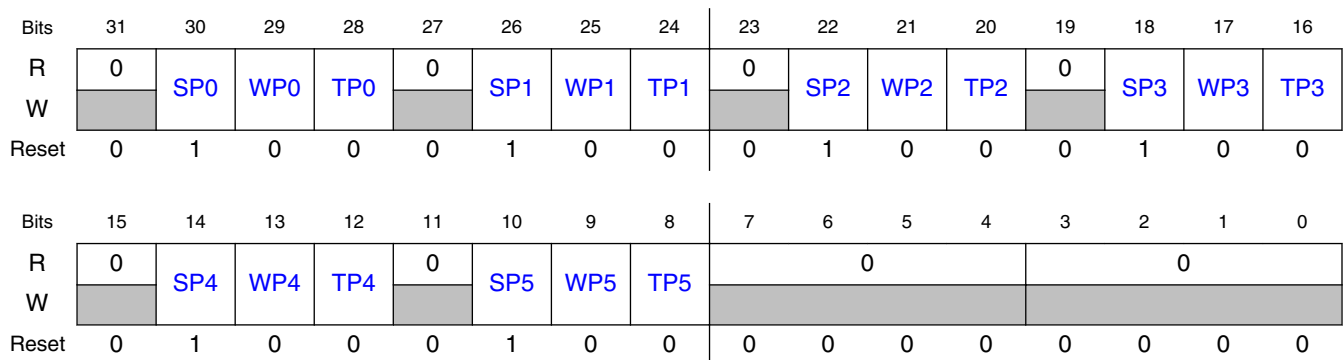

16.3.1.11.4 Fields

Field	Function
31	Reserved

Table continues on the next page...

Field	Function
—	
30 SP0	<p>Supervisor Protect</p> <p>Determines whether the peripheral requires supervisor privilege level for accesses. When this field is set, the master privilege level must indicate the supervisor access attribute, and the MPRx[MPLn] control field for the master must be set. If not, access terminates with an error response and no peripheral access initiates.</p> <p>0b - This peripheral does not require supervisor privilege level for accesses. 1b - This peripheral requires supervisor privilege level for accesses.</p>
29 WP0	<p>Write Protect</p> <p>Determines whether the peripheral allows write accesses. When this field is set and a write access is attempted, access terminates with an error response and no peripheral access initiates.</p> <p>0b - This peripheral allows write accesses. 1b - This peripheral is write protected.</p>
28 TP0	<p>Trusted Protect</p> <p>Determines whether the peripheral allows accesses from an untrusted master. When this bit is set and an access is attempted by an untrusted master, the access terminates with an error response and no peripheral access initiates.</p> <p>0b - Accesses from an untrusted master are allowed. 1b - Accesses from an untrusted master are not allowed.</p>
27 —	Reserved
26 SP1	<p>Supervisor Protect</p> <p>Determines whether the peripheral requires supervisor privilege level for access. When this field is set, the master privilege level must indicate the supervisor access attribute, and the MPRx[MPLn] control field for the master must be set. If not, access terminates with an error response and no peripheral access initiates.</p> <p>0b - This peripheral does not require supervisor privilege level for accesses. 1b - This peripheral requires supervisor privilege level for accesses.</p>
25 WP1	<p>Write Protect</p> <p>Determines whether the peripheral allows write accesses. When this field is set and a write access is attempted, access terminates with an error response and no peripheral access initiates.</p> <p>0b - This peripheral allows write accesses. 1b - This peripheral is write protected.</p>
24 TP1	<p>Trusted Protect</p> <p>Determines whether the peripheral allows accesses from an untrusted master. When this field is set and an access is attempted by an untrusted master, the access terminates with an error response and no peripheral access initiates.</p> <p>0b - Accesses from an untrusted master are allowed. 1b - Accesses from an untrusted master are not allowed.</p>
23 —	Reserved
22 SP2	<p>Supervisor Protect</p> <p>Determines whether the peripheral requires supervisor privilege level for access. When this bit is set, the master privilege level must indicate the supervisor access attribute, and the MPRx[MPLn] control bit for the master must be set. If not, access terminates with an error response and no peripheral access initiates.</p> <p>0b - This peripheral does not require supervisor privilege level for accesses. 1b - This peripheral requires supervisor privilege level for accesses.</p>

Table continues on the next page...

Memory map/register definition

Field	Function
21 WP2	Write Protect Determines whether the peripheral allows write accesses. When this field is set and a write access is attempted, access terminates with an error response and no peripheral access initiates. 0b - This peripheral allows write accesses. 1b - This peripheral is write protected.
20 TP2	Trusted Protect Determines whether the peripheral allows accesses from an untrusted master. When this bit is set and an access is attempted by an untrusted master, the access terminates with an error response and no peripheral access initiates. 0b - Accesses from an untrusted master are allowed. 1b - Accesses from an untrusted master are not allowed.
19 —	Reserved
18 SP3	Supervisor Protect Determines whether the peripheral requires supervisor privilege level for accesses. When this field is set, the master privilege level must indicate the supervisor access attribute, and the MPRx[MPLn] control field for the master must be set. If not, access terminates with an error response and no peripheral access initiates. 0b - This peripheral does not require supervisor privilege level for accesses. 1b - This peripheral requires supervisor privilege level for accesses.
17 WP3	Write Protect Determines whether the peripheral allows write access. When this bit is set and a write access is attempted, access terminates with an error response and no peripheral access initiates. 0b - This peripheral allows write accesses. 1b - This peripheral is write protected.
16 TP3	Trusted Protect Determines whether the peripheral allows accesses from an untrusted master. When this field is set and an access is attempted by an untrusted master, the access terminates with an error response and no peripheral access initiates. 0b - Accesses from an untrusted master are allowed. 1b - Accesses from an untrusted master are not allowed.
15 —	Reserved
14 SP4	Supervisor Protect Determines whether the peripheral requires supervisor privilege level for access. When this bit is set, the master privilege level must indicate the supervisor access attribute, and the MPRx[MPLn] control bit for the master must be set. If not, access terminates with an error response and no peripheral access initiates. 0b - This peripheral does not require supervisor privilege level for accesses. 1b - This peripheral requires supervisor privilege level for accesses.
13 WP4	Write Protect Determines whether the peripheral allows write accesses. When this field is set and a write access is attempted, access terminates with an error response and no peripheral access initiates. 0b - This peripheral allows write accesses. 1b - This peripheral is write protected.
12 TP4	Trusted Protect

Table continues on the next page...

Field	Function
	Determines whether the peripheral allows accesses from an untrusted master. When this bit is set and an access is attempted by an untrusted master, the access terminates with an error response and no peripheral access initiates. 0b - Accesses from an untrusted master are allowed. 1b - Accesses from an untrusted master are not allowed.
11 —	Reserved
10 SP5	Supervisor Protect Determines whether the peripheral requires supervisor privilege level for accesses. When this field is set, the master privilege level must indicate the supervisor access attribute, and the MPRx[MPLn] control field for the master must be set. If not, access terminates with an error response and no peripheral access initiates. 0b - This peripheral does not require supervisor privilege level for accesses. 1b - This peripheral requires supervisor privilege level for accesses.
9 WP5	Write Protect Determines whether the peripheral allows write accesses. When this field is set and a write access is attempted, access terminates with an error response and no peripheral access initiates. 0b - This peripheral allows write accesses. 1b - This peripheral is write protected.
8 TP5	Trusted Protect Determines whether the peripheral allows accesses from an untrusted master. When this field is set and an access is attempted by an untrusted master, the access terminates with an error response and no peripheral access initiates. 0b - Accesses from an untrusted master are allowed. 1b - Accesses from an untrusted master are not allowed.
7-4 —	Reserved
3-0 —	Reserved

16.3.1.12 Off-Platform Peripheral Access Control Register (OPACRG)

16.3.1.12.1 Offset

Register	Offset
OPACRG	58h

16.3.1.12.2 Function

Each OPACR register consists of eight 4-bit OPACR fields. Each OPACR field defines the access levels for a particular off-platform peripheral. The peripheral assignment to each OPACR field is defined by the memory map slot of the peripheral. See the chip-specific AIPS information for the field assignment of a particular peripheral.

16.3.1.12.3 Diagram

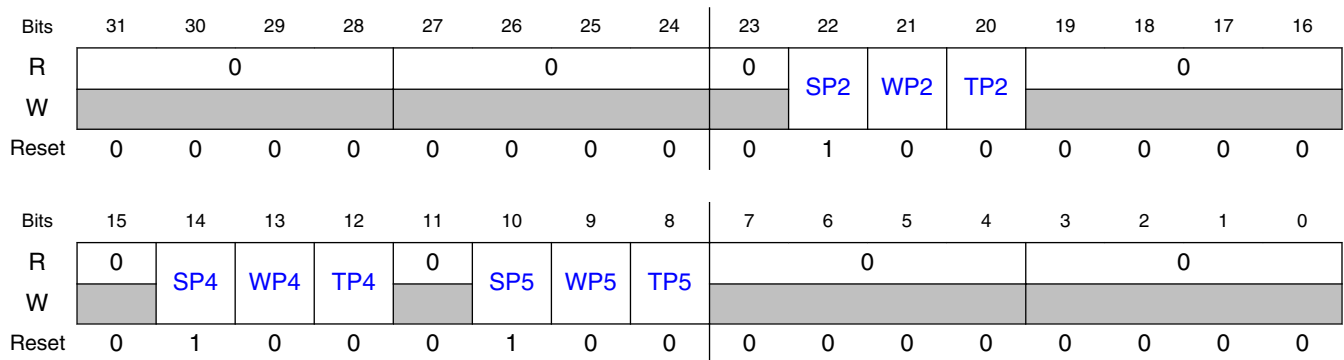

16.3.1.12.4 Fields

Field	Function
31-28 —	Reserved
27-24 —	Reserved
23 —	Reserved
22 SP2	Supervisor Protect Determines whether the peripheral requires supervisor privilege level for access. When this bit is set, the master privilege level must indicate the supervisor access attribute, and the MPRx[MPLn] control bit for the master must be set. If not, access terminates with an error response and no peripheral access initiates. 0b - This peripheral does not require supervisor privilege level for accesses. 1b - This peripheral requires supervisor privilege level for accesses.
21 WP2	Write Protect Determines whether the peripheral allows write accesses. When this field is set and a write access is attempted, access terminates with an error response and no peripheral access initiates. 0b - This peripheral allows write accesses. 1b - This peripheral is write protected.
20 TP2	Trusted Protect

Table continues on the next page...

Field	Function
	Determines whether the peripheral allows accesses from an untrusted master. When this bit is set and an access is attempted by an untrusted master, the access terminates with an error response and no peripheral access initiates. 0b - Accesses from an untrusted master are allowed. 1b - Accesses from an untrusted master are not allowed.
19-16 —	Reserved
15 —	Reserved
14 SP4	Supervisor Protect Determines whether the peripheral requires supervisor privilege level for access. When this bit is set, the master privilege level must indicate the supervisor access attribute, and the MPR _x [MPL _n] control bit for the master must be set. If not, access terminates with an error response and no peripheral access initiates. 0b - This peripheral does not require supervisor privilege level for accesses. 1b - This peripheral requires supervisor privilege level for accesses.
13 WP4	Write Protect Determines whether the peripheral allows write accesses. When this field is set and a write access is attempted, access terminates with an error response and no peripheral access initiates. 0b - This peripheral allows write accesses. 1b - This peripheral is write protected.
12 TP4	Trusted Protect Determines whether the peripheral allows accesses from an untrusted master. When this bit is set and an access is attempted by an untrusted master, the access terminates with an error response and no peripheral access initiates. 0b - Accesses from an untrusted master are allowed. 1b - Accesses from an untrusted master are not allowed.
11 —	Reserved
10 SP5	Supervisor Protect Determines whether the peripheral requires supervisor privilege level for accesses. When this field is set, the master privilege level must indicate the supervisor access attribute, and the MPR _x [MPL _n] control field for the master must be set. If not, access terminates with an error response and no peripheral access initiates. 0b - This peripheral does not require supervisor privilege level for accesses. 1b - This peripheral requires supervisor privilege level for accesses.
9 WP5	Write Protect Determines whether the peripheral allows write accesses. When this field is set and a write access is attempted, access terminates with an error response and no peripheral access initiates. 0b - This peripheral allows write accesses. 1b - This peripheral is write protected.
8 TP5	Trusted Protect Determines whether the peripheral allows accesses from an untrusted master. When this field is set and an access is attempted by an untrusted master, the access terminates with an error response and no peripheral access initiates. 0b - Accesses from an untrusted master are allowed. 1b - Accesses from an untrusted master are not allowed.
7-4	Reserved

Table continues on the next page...

Memory map/register definition

Field	Function
—	
3-0	Reserved
—	

16.3.1.13 Off-Platform Peripheral Access Control Register (OPACRH)

16.3.1.13.1 Offset

Register	Offset
OPACRH	5Ch

16.3.1.13.2 Function

Each OPACR register consists of eight 4-bit OPACR fields. Each OPACR field defines the access levels for a particular off-platform peripheral. The peripheral assignment to each OPACR field is defined by the memory map slot of the peripheral. See the chip-specific AIPS information for the field assignment of a particular peripheral.

16.3.1.13.3 Diagram

Bits	31	30	29	28	27	26	25	24	23	22	21	20	19	18	17	16
R	0				0				0	SP2	WP2	TP2	0			
W	[Shaded]															
Reset	0	0	0	0	0	0	0	0	0	1	0	0	0	0	0	0
Bits	15	14	13	12	11	10	9	8	7	6	5	4	3	2	1	0
R	0				0				0				0			
W	[Shaded]															
Reset	0	0	0	0	0	0	0	0	0	0	0	0	0	0	0	0

16.3.1.13.4 Fields

Field	Function
31-28	Reserved
—	

Table continues on the next page...

Field	Function
27-24 —	Reserved
23 —	Reserved
22 SP2	Supervisor Protect Determines whether the peripheral requires supervisor privilege level for access. When this bit is set, the master privilege level must indicate the supervisor access attribute, and the MPRx[MPLn] control bit for the master must be set. If not, access terminates with an error response and no peripheral access initiates. 0b - This peripheral does not require supervisor privilege level for accesses. 1b - This peripheral requires supervisor privilege level for accesses.
21 WP2	Write Protect Determines whether the peripheral allows write accesses. When this field is set and a write access is attempted, access terminates with an error response and no peripheral access initiates. 0b - This peripheral allows write accesses. 1b - This peripheral is write protected.
20 TP2	Trusted Protect Determines whether the peripheral allows accesses from an untrusted master. When this bit is set and an access is attempted by an untrusted master, the access terminates with an error response and no peripheral access initiates. 0b - Accesses from an untrusted master are allowed. 1b - Accesses from an untrusted master are not allowed.
19-16 —	Reserved
15-12 —	Reserved
11-8 —	Reserved
7-4 —	Reserved
3-0 —	Reserved

16.3.1.14 Off-Platform Peripheral Access Control Register (OPACRI)

16.3.1.14.1 Offset

Register	Offset
OPACRI	60h

16.3.1.14.2 Function

Each OPACR register consists of eight 4-bit OPACR fields. Each OPACR field defines the access levels for a particular off-platform peripheral. The peripheral assignment to each OPACR field is defined by the memory map slot of the peripheral. See the chip-specific AIPS information for the field assignment of a particular peripheral.

16.3.1.14.3 Diagram

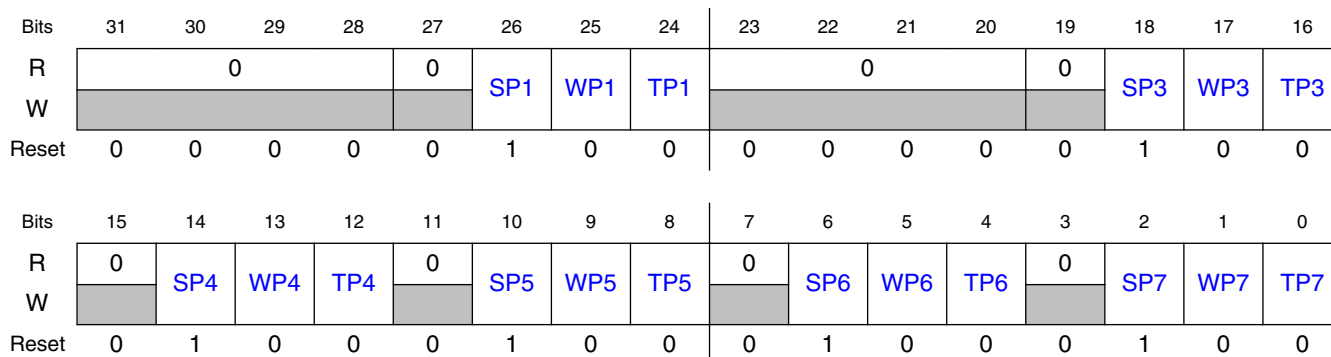

16.3.1.14.4 Fields

Field	Function
31-28 —	Reserved
27 —	Reserved
26 SP1	Supervisor Protect Determines whether the peripheral requires supervisor privilege level for access. When this field is set, the master privilege level must indicate the supervisor access attribute, and the MPRx[MPLn] control field for the master must be set. If not, access terminates with an error response and no peripheral access initiates. 0b - This peripheral does not require supervisor privilege level for accesses. 1b - This peripheral requires supervisor privilege level for accesses.
25 WP1	Write Protect Determines whether the peripheral allows write accesses. When this field is set and a write access is attempted, access terminates with an error response and no peripheral access initiates. 0b - This peripheral allows write accesses. 1b - This peripheral is write protected.
24 TP1	Trusted Protect Determines whether the peripheral allows accesses from an untrusted master. When this field is set and an access is attempted by an untrusted master, the access terminates with an error response and no peripheral access initiates.

Table continues on the next page...

Field	Function
	0b - Accesses from an untrusted master are allowed. 1b - Accesses from an untrusted master are not allowed.
23-20 —	Reserved
19 —	Reserved
18 SP3	Supervisor Protect Determines whether the peripheral requires supervisor privilege level for accesses. When this field is set, the master privilege level must indicate the supervisor access attribute, and the MPRx[MPLn] control field for the master must be set. If not, access terminates with an error response and no peripheral access initiates. 0b - This peripheral does not require supervisor privilege level for accesses. 1b - This peripheral requires supervisor privilege level for accesses.
17 WP3	Write Protect Determines whether the peripheral allows write access. When this bit is set and a write access is attempted, access terminates with an error response and no peripheral access initiates. 0b - This peripheral allows write accesses. 1b - This peripheral is write protected.
16 TP3	Trusted Protect Determines whether the peripheral allows accesses from an untrusted master. When this field is set and an access is attempted by an untrusted master, the access terminates with an error response and no peripheral access initiates. 0b - Accesses from an untrusted master are allowed. 1b - Accesses from an untrusted master are not allowed.
15 —	Reserved
14 SP4	Supervisor Protect Determines whether the peripheral requires supervisor privilege level for access. When this bit is set, the master privilege level must indicate the supervisor access attribute, and the MPRx[MPLn] control bit for the master must be set. If not, access terminates with an error response and no peripheral access initiates. 0b - This peripheral does not require supervisor privilege level for accesses. 1b - This peripheral requires supervisor privilege level for accesses.
13 WP4	Write Protect Determines whether the peripheral allows write accesses. When this field is set and a write access is attempted, access terminates with an error response and no peripheral access initiates. 0b - This peripheral allows write accesses. 1b - This peripheral is write protected.
12 TP4	Trusted Protect Determines whether the peripheral allows accesses from an untrusted master. When this bit is set and an access is attempted by an untrusted master, the access terminates with an error response and no peripheral access initiates. 0b - Accesses from an untrusted master are allowed. 1b - Accesses from an untrusted master are not allowed.
11 —	Reserved
10	Supervisor Protect

Table continues on the next page...

Memory map/register definition

Field	Function
SP5	Determines whether the peripheral requires supervisor privilege level for accesses. When this field is set, the master privilege level must indicate the supervisor access attribute, and the MPRx[MPLn] control field for the master must be set. If not, access terminates with an error response and no peripheral access initiates. 0b - This peripheral does not require supervisor privilege level for accesses. 1b - This peripheral requires supervisor privilege level for accesses.
9 WP5	Write Protect Determines whether the peripheral allows write accesses. When this field is set and a write access is attempted, access terminates with an error response and no peripheral access initiates. 0b - This peripheral allows write accesses. 1b - This peripheral is write protected.
8 TP5	Trusted Protect Determines whether the peripheral allows accesses from an untrusted master. When this field is set and an access is attempted by an untrusted master, the access terminates with an error response and no peripheral access initiates. 0b - Accesses from an untrusted master are allowed. 1b - Accesses from an untrusted master are not allowed.
7 —	Reserved
6 SP6	Supervisor Protect Determines whether the peripheral requires supervisor privilege level for accesses. When this field is set, the master privilege level must indicate the supervisor access attribute, and the MPRx[MPLn] control field for the master must be set. If not, access terminates with an error response and no peripheral access initiates. 0b - This peripheral does not require supervisor privilege level for accesses. 1b - This peripheral requires supervisor privilege level for accesses.
5 WP6	Write Protect Determines whether the peripheral allows write accesses. When this field is set and a write access is attempted, access terminates with an error response and no peripheral access initiates. 0b - This peripheral allows write accesses. 1b - This peripheral is write protected.
4 TP6	Trusted Protect Determines whether the peripheral allows accesses from an untrusted master. When this field is set and an access is attempted by an untrusted master, the access terminates with an error response and no peripheral access initiates. 0b - Accesses from an untrusted master are allowed. 1b - Accesses from an untrusted master are not allowed.
3 —	Reserved
2 SP7	Supervisor Protect Determines whether the peripheral requires supervisor privilege level for accesses. When this field is set, the master privilege level must indicate the supervisor access attribute, and the MPRx[MPLn] control field for the master must be set. If not, access terminates with an error response and no peripheral access initiates. 0b - This peripheral does not require supervisor privilege level for accesses. 1b - This peripheral requires supervisor privilege level for accesses.
1 WP7	Write Protect

Table continues on the next page...

Field	Function
	Determines whether the peripheral allows accesses from an untrusted master. When this field is set and an access is attempted by an untrusted master, the access terminates with an error response and no peripheral access initiates. 0b - This peripheral allows write accesses. 1b - This peripheral is write protected.
0 TP7	Trusted Protect Determines whether the peripheral allows accesses from an untrusted master. When this field is set and an access is attempted by an untrusted master, the access terminates with an error response and no peripheral access initiates. 0b - Accesses from an untrusted master are allowed. 1b - Accesses from an untrusted master are not allowed.

16.3.1.15 Off-Platform Peripheral Access Control Register (OPACRJ)

16.3.1.15.1 Offset

Register	Offset
OPACRJ	64h

16.3.1.15.2 Function

Each OPACR register consists of eight 4-bit OPACR fields. Each OPACR field defines the access levels for a particular off-platform peripheral. The peripheral assignment to each OPACR field is defined by the memory map slot of the peripheral. See the chip-specific AIPS information for the field assignment of a particular peripheral.

16.3.1.15.3 Diagram

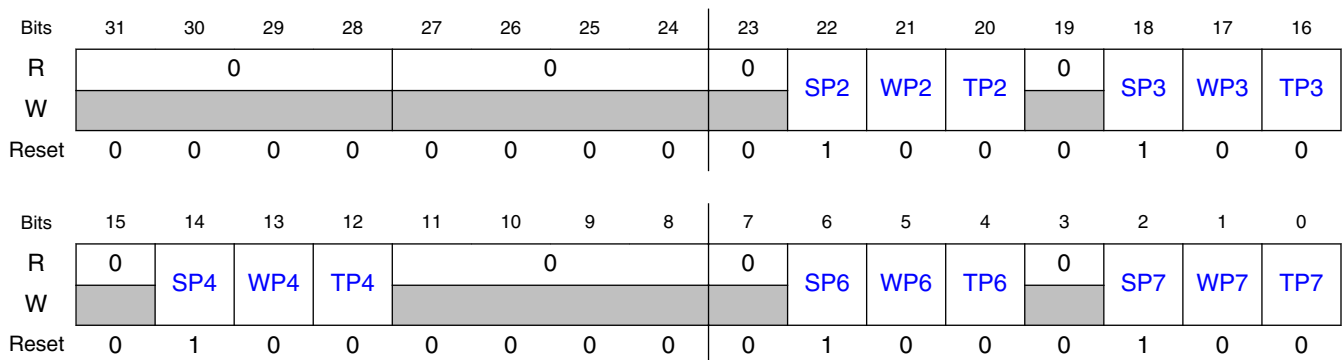

16.3.1.15.4 Fields

Field	Function
31-28 —	Reserved
27-24 —	Reserved
23 —	Reserved
22 SP2	<p>Supervisor Protect</p> <p>Determines whether the peripheral requires supervisor privilege level for access. When this bit is set, the master privilege level must indicate the supervisor access attribute, and the MPRx[MPLn] control bit for the master must be set. If not, access terminates with an error response and no peripheral access initiates.</p> <p>0b - This peripheral does not require supervisor privilege level for accesses. 1b - This peripheral requires supervisor privilege level for accesses.</p>
21 WP2	<p>Write Protect</p> <p>Determines whether the peripheral allows write accesses. When this field is set and a write access is attempted, access terminates with an error response and no peripheral access initiates.</p> <p>0b - This peripheral allows write accesses. 1b - This peripheral is write protected.</p>
20 TP2	<p>Trusted Protect</p> <p>Determines whether the peripheral allows accesses from an untrusted master. When this bit is set and an access is attempted by an untrusted master, the access terminates with an error response and no peripheral access initiates.</p> <p>0b - Accesses from an untrusted master are allowed. 1b - Accesses from an untrusted master are not allowed.</p>
19 —	Reserved
18 SP3	<p>Supervisor Protect</p> <p>Determines whether the peripheral requires supervisor privilege level for accesses. When this field is set, the master privilege level must indicate the supervisor access attribute, and the MPRx[MPLn] control field for the master must be set. If not, access terminates with an error response and no peripheral access initiates.</p> <p>0b - This peripheral does not require supervisor privilege level for accesses. 1b - This peripheral requires supervisor privilege level for accesses.</p>
17 WP3	<p>Write Protect</p> <p>Determines whether the peripheral allows write access. When this bit is set and a write access is attempted, access terminates with an error response and no peripheral access initiates.</p> <p>0b - This peripheral allows write accesses. 1b - This peripheral is write protected.</p>
16 TP3	<p>Trusted Protect</p> <p>Determines whether the peripheral allows accesses from an untrusted master. When this field is set and an access is attempted by an untrusted master, the access terminates with an error response and no peripheral access initiates.</p> <p>0b - Accesses from an untrusted master are allowed. 1b - Accesses from an untrusted master are not allowed.</p>
15	Reserved

Table continues on the next page...

Field	Function
—	
14 SP4	<p>Supervisor Protect</p> <p>Determines whether the peripheral requires supervisor privilege level for access. When this bit is set, the master privilege level must indicate the supervisor access attribute, and the MPRx[MPLn] control bit for the master must be set. If not, access terminates with an error response and no peripheral access initiates.</p> <p>0b - This peripheral does not require supervisor privilege level for accesses. 1b - This peripheral requires supervisor privilege level for accesses.</p>
13 WP4	<p>Write Protect</p> <p>Determines whether the peripheral allows write accesses. When this field is set and a write access is attempted, access terminates with an error response and no peripheral access initiates.</p> <p>0b - This peripheral allows write accesses. 1b - This peripheral is write protected.</p>
12 TP4	<p>Trusted Protect</p> <p>Determines whether the peripheral allows accesses from an untrusted master. When this bit is set and an access is attempted by an untrusted master, the access terminates with an error response and no peripheral access initiates.</p> <p>0b - Accesses from an untrusted master are allowed. 1b - Accesses from an untrusted master are not allowed.</p>
11-8 —	Reserved
7 —	Reserved
6 SP6	<p>Supervisor Protect</p> <p>Determines whether the peripheral requires supervisor privilege level for accesses. When this field is set, the master privilege level must indicate the supervisor access attribute, and the MPRx[MPLn] control field for the master must be set. If not, access terminates with an error response and no peripheral access initiates.</p> <p>0b - This peripheral does not require supervisor privilege level for accesses. 1b - This peripheral requires supervisor privilege level for accesses.</p>
5 WP6	<p>Write Protect</p> <p>Determines whether the peripheral allows write accesses. When this field is set and a write access is attempted, access terminates with an error response and no peripheral access initiates.</p> <p>0b - This peripheral allows write accesses. 1b - This peripheral is write protected.</p>
4 TP6	<p>Trusted Protect</p> <p>Determines whether the peripheral allows accesses from an untrusted master. When this field is set and an access is attempted by an untrusted master, the access terminates with an error response and no peripheral access initiates.</p> <p>0b - Accesses from an untrusted master are allowed. 1b - Accesses from an untrusted master are not allowed.</p>
3 —	Reserved
2 SP7	Supervisor Protect

Table continues on the next page...

Memory map/register definition

Field	Function
	<p>Determines whether the peripheral requires supervisor privilege level for accesses. When this field is set, the master privilege level must indicate the supervisor access attribute, and the MPRx[MPLn] control field for the master must be set. If not, access terminates with an error response and no peripheral access initiates.</p> <p>0b - This peripheral does not require supervisor privilege level for accesses. 1b - This peripheral requires supervisor privilege level for accesses.</p>
1 WP7	<p>Write Protect</p> <p>Determines whether the peripheral allows accesses from an untrusted master. When this field is set and an access is attempted by an untrusted master, the access terminates with an error response and no peripheral access initiates.</p> <p>0b - This peripheral allows write accesses. 1b - This peripheral is write protected.</p>
0 TP7	<p>Trusted Protect</p> <p>Determines whether the peripheral allows accesses from an untrusted master. When this field is set and an access is attempted by an untrusted master, the access terminates with an error response and no peripheral access initiates.</p> <p>0b - Accesses from an untrusted master are allowed. 1b - Accesses from an untrusted master are not allowed.</p>

16.3.1.16 Off-Platform Peripheral Access Control Register (OPACRK)

16.3.1.16.1 Offset

Register	Offset
OPACRK	68h

16.3.1.16.2 Function

Each OPACR register consists of eight 4-bit OPACR fields. Each OPACR field defines the access levels for a particular off-platform peripheral. The peripheral assignment to each OPACR field is defined by the memory map slot of the peripheral. See the chip-specific AIPS information for the field assignment of a particular peripheral.

16.3.1.16.3 Diagram

Bits	31	30	29	28	27	26	25	24	23	22	21	20	19	18	17	16
R	0	SP0	WP0	TP0	0	SP1	WP1	TP1	0				0	SP3	WP3	TP3
W																
Reset	0	1	0	0	0	1	0	0	0	0	0	0	0	1	0	0
Bits	15	14	13	12	11	10	9	8	7	6	5	4	3	2	1	0
R	0				0				0	SP6	WP6	TP6	0			
W																
Reset	0	0	0	0	0	0	0	0	0	1	0	0	0	0	0	0

16.3.1.16.4 Fields

Field	Function
31 —	Reserved
30 SP0	<p>Supervisor Protect</p> <p>Determines whether the peripheral requires supervisor privilege level for accesses. When this field is set, the master privilege level must indicate the supervisor access attribute, and the MPRx[MPLn] control field for the master must be set. If not, access terminates with an error response and no peripheral access initiates.</p> <p>0b - This peripheral does not require supervisor privilege level for accesses. 1b - This peripheral requires supervisor privilege level for accesses.</p>
29 WP0	<p>Write Protect</p> <p>Determines whether the peripheral allows write accesses. When this field is set and a write access is attempted, access terminates with an error response and no peripheral access initiates.</p> <p>0b - This peripheral allows write accesses. 1b - This peripheral is write protected.</p>
28 TP0	<p>Trusted Protect</p> <p>Determines whether the peripheral allows accesses from an untrusted master. When this bit is set and an access is attempted by an untrusted master, the access terminates with an error response and no peripheral access initiates.</p> <p>0b - Accesses from an untrusted master are allowed. 1b - Accesses from an untrusted master are not allowed.</p>
27 —	Reserved
26 SP1	<p>Supervisor Protect</p> <p>Determines whether the peripheral requires supervisor privilege level for access. When this field is set, the master privilege level must indicate the supervisor access attribute, and the MPRx[MPLn] control field for the master must be set. If not, access terminates with an error response and no peripheral access initiates.</p> <p>0b - This peripheral does not require supervisor privilege level for accesses. 1b - This peripheral requires supervisor privilege level for accesses.</p>
25	Write Protect

Table continues on the next page...

Memory map/register definition

Field	Function
WP1	Determines whether the peripheral allows write accesses. When this field is set and a write access is attempted, access terminates with an error response and no peripheral access initiates. 0b - This peripheral allows write accesses. 1b - This peripheral is write protected.
24 TP1	Trusted Protect Determines whether the peripheral allows accesses from an untrusted master. When this field is set and an access is attempted by an untrusted master, the access terminates with an error response and no peripheral access initiates. 0b - Accesses from an untrusted master are allowed. 1b - Accesses from an untrusted master are not allowed.
23-20 —	Reserved
19 —	Reserved
18 SP3	Supervisor Protect Determines whether the peripheral requires supervisor privilege level for accesses. When this field is set, the master privilege level must indicate the supervisor access attribute, and the MPRx[MPLn] control field for the master must be set. If not, access terminates with an error response and no peripheral access initiates. 0b - This peripheral does not require supervisor privilege level for accesses. 1b - This peripheral requires supervisor privilege level for accesses.
17 WP3	Write Protect Determines whether the peripheral allows write access. When this bit is set and a write access is attempted, access terminates with an error response and no peripheral access initiates. 0b - This peripheral allows write accesses. 1b - This peripheral is write protected.
16 TP3	Trusted Protect Determines whether the peripheral allows accesses from an untrusted master. When this field is set and an access is attempted by an untrusted master, the access terminates with an error response and no peripheral access initiates. 0b - Accesses from an untrusted master are allowed. 1b - Accesses from an untrusted master are not allowed.
15-12 —	Reserved
11-8 —	Reserved
7 —	Reserved
6 SP6	Supervisor Protect Determines whether the peripheral requires supervisor privilege level for accesses. When this field is set, the master privilege level must indicate the supervisor access attribute, and the MPRx[MPLn] control field for the master must be set. If not, access terminates with an error response and no peripheral access initiates. 0b - This peripheral does not require supervisor privilege level for accesses. 1b - This peripheral requires supervisor privilege level for accesses.
5	Write Protect

Table continues on the next page...

Field	Function
WP6	Determines whether the peripheral allows write accesses. When this field is set and a write access is attempted, access terminates with an error response and no peripheral access initiates. 0b - This peripheral allows write accesses. 1b - This peripheral is write protected.
4 TP6	Trusted Protect Determines whether the peripheral allows accesses from an untrusted master. When this field is set and an access is attempted by an untrusted master, the access terminates with an error response and no peripheral access initiates. 0b - Accesses from an untrusted master are allowed. 1b - Accesses from an untrusted master are not allowed.
3-0 —	Reserved

16.3.1.17 Off-Platform Peripheral Access Control Register (OPACRL)

16.3.1.17.1 Offset

Register	Offset
OPACRL	6Ch

16.3.1.17.2 Function

Each OPACR register consists of eight 4-bit OPACR fields. Each OPACR field defines the access levels for a particular off-platform peripheral. The peripheral assignment to each OPACR field is defined by the memory map slot of the peripheral. See the chip-specific AIPS information for the field assignment of a particular peripheral.

16.3.1.17.3 Diagram

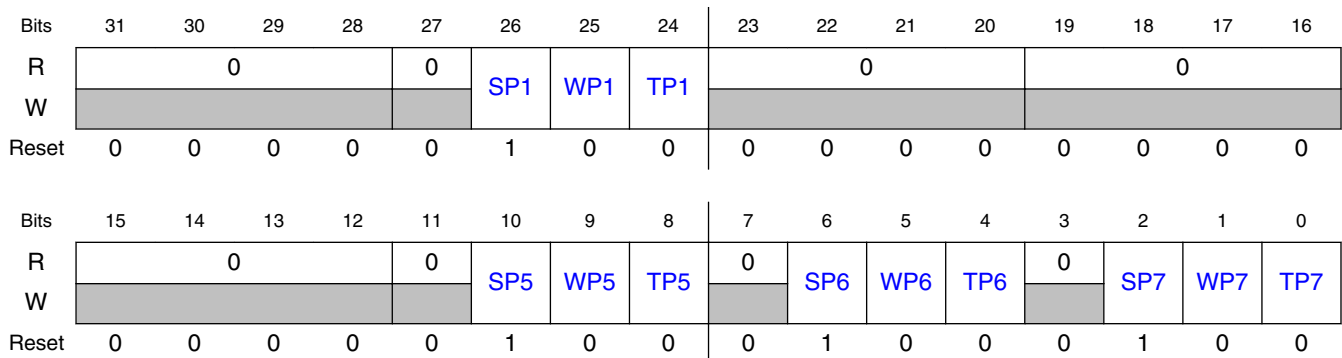

16.3.1.17.4 Fields

Field	Function
31-28 —	Reserved
27 —	Reserved
26 SP1	<p>Supervisor Protect</p> <p>Determines whether the peripheral requires supervisor privilege level for access. When this field is set, the master privilege level must indicate the supervisor access attribute, and the MPRx[MPLn] control field for the master must be set. If not, access terminates with an error response and no peripheral access initiates.</p> <p>0b - This peripheral does not require supervisor privilege level for accesses. 1b - This peripheral requires supervisor privilege level for accesses.</p>
25 WP1	<p>Write Protect</p> <p>Determines whether the peripheral allows write accesses. When this field is set and a write access is attempted, access terminates with an error response and no peripheral access initiates.</p> <p>0b - This peripheral allows write accesses. 1b - This peripheral is write protected.</p>
24 TP1	<p>Trusted Protect</p> <p>Determines whether the peripheral allows accesses from an untrusted master. When this field is set and an access is attempted by an untrusted master, the access terminates with an error response and no peripheral access initiates.</p> <p>0b - Accesses from an untrusted master are allowed. 1b - Accesses from an untrusted master are not allowed.</p>
23-20 —	Reserved
19-16 —	Reserved
15-12 —	Reserved
11 —	Reserved
10 SP5	<p>Supervisor Protect</p> <p>Determines whether the peripheral requires supervisor privilege level for accesses. When this field is set, the master privilege level must indicate the supervisor access attribute, and the MPRx[MPLn] control field for the master must be set. If not, access terminates with an error response and no peripheral access initiates.</p> <p>0b - This peripheral does not require supervisor privilege level for accesses. 1b - This peripheral requires supervisor privilege level for accesses.</p>
9 WP5	<p>Write Protect</p> <p>Determines whether the peripheral allows write accesses. When this field is set and a write access is attempted, access terminates with an error response and no peripheral access initiates.</p> <p>0b - This peripheral allows write accesses. 1b - This peripheral is write protected.</p>

Table continues on the next page...

Field	Function
8 TP5	Trusted Protect Determines whether the peripheral allows accesses from an untrusted master. When this field is set and an access is attempted by an untrusted master, the access terminates with an error response and no peripheral access initiates. 0b - Accesses from an untrusted master are allowed. 1b - Accesses from an untrusted master are not allowed.
7 —	Reserved
6 SP6	Supervisor Protect Determines whether the peripheral requires supervisor privilege level for accesses. When this field is set, the master privilege level must indicate the supervisor access attribute, and the MPRx[MPLn] control field for the master must be set. If not, access terminates with an error response and no peripheral access initiates. 0b - This peripheral does not require supervisor privilege level for accesses. 1b - This peripheral requires supervisor privilege level for accesses.
5 WP6	Write Protect Determines whether the peripheral allows write accesses. When this field is set and a write access is attempted, access terminates with an error response and no peripheral access initiates. 0b - This peripheral allows write accesses. 1b - This peripheral is write protected.
4 TP6	Trusted Protect Determines whether the peripheral allows accesses from an untrusted master. When this field is set and an access is attempted by an untrusted master, the access terminates with an error response and no peripheral access initiates. 0b - Accesses from an untrusted master are allowed. 1b - Accesses from an untrusted master are not allowed.
3 —	Reserved
2 SP7	Supervisor Protect Determines whether the peripheral requires supervisor privilege level for accesses. When this field is set, the master privilege level must indicate the supervisor access attribute, and the MPRx[MPLn] control field for the master must be set. If not, access terminates with an error response and no peripheral access initiates. 0b - This peripheral does not require supervisor privilege level for accesses. 1b - This peripheral requires supervisor privilege level for accesses.
1 WP7	Write Protect Determines whether the peripheral allows accesses from an untrusted master. When this field is set and an access is attempted by an untrusted master, the access terminates with an error response and no peripheral access initiates. 0b - This peripheral allows write accesses. 1b - This peripheral is write protected.
0 TP7	Trusted Protect Determines whether the peripheral allows accesses from an untrusted master. When this field is set and an access is attempted by an untrusted master, the access terminates with an error response and no peripheral access initiates. 0b - Accesses from an untrusted master are allowed. 1b - Accesses from an untrusted master are not allowed.

16.4 Functional description

The peripheral bridge functions as a bus protocol translator between the crossbar switch and the slave peripheral bus.

The peripheral bridge manages all transactions destined for the attached slave devices and generates select signals for modules on the peripheral bus by decoding accesses within the attached address space.

16.4.1 Access support

Aligned and misaligned 32-bit, 16-bit, and byte accesses are supported for 32-bit peripherals. Misaligned accesses are supported to allow memory to be placed on the slave peripheral bus. Peripheral registers must not be misaligned, although no explicit checking is performed by the peripheral bridge. All accesses are performed with a single transfer.

All accesses to the peripheral slots must be sized less than or equal to the designated peripheral slot size. If an access is attempted that is larger than the targeted port, an error response is generated.

Chapter 17

Direct Memory Access Multiplexer (DMAMUX)

17.1 Chip-specific DMAMUX information

17.1.1 Number of channels

The number of channels across S32K1xx and S32K14xW series varies across variants. See below table for the same.

Table 17-1. Number of channles

Chips	Number of channels
S32K116	4
S32K118	4
S32K142	16
S32K142W	16
S32K144	16
S32K144W	16
S32K146	16
S32K148	16

17.1.2 DMA transfers via TRGMUX trigger

The triggers from TRGMUX module can trigger a DMA transfer on the first four DMA channels, for example, the LPIT can trigger DMA via TRGMUX. See [Figure 19-2](#) for module interconnectivity details. The LPIT/DMA periodic trigger assignments are detailed at [LPIT/DMA Periodic Trigger Assignments](#).

Asynchronous DMA operation does not support trigger options.

In cases where multiple DMA request are routed to DMAMUX source, software needs to make sure that only one DMA request is enabled at a time. For example DMA request of one Ethernet timer can be enabled at a particular time, while others can enable interrupt during that time.

17.2 Introduction

17.2.1 Overview

The Direct Memory Access Multiplexer (DMAMUX) routes DMA sources, called slots, to any of the 16 DMA channels. See the chip-specific information to know the detailed source numbers. This process is illustrated in the following figure.

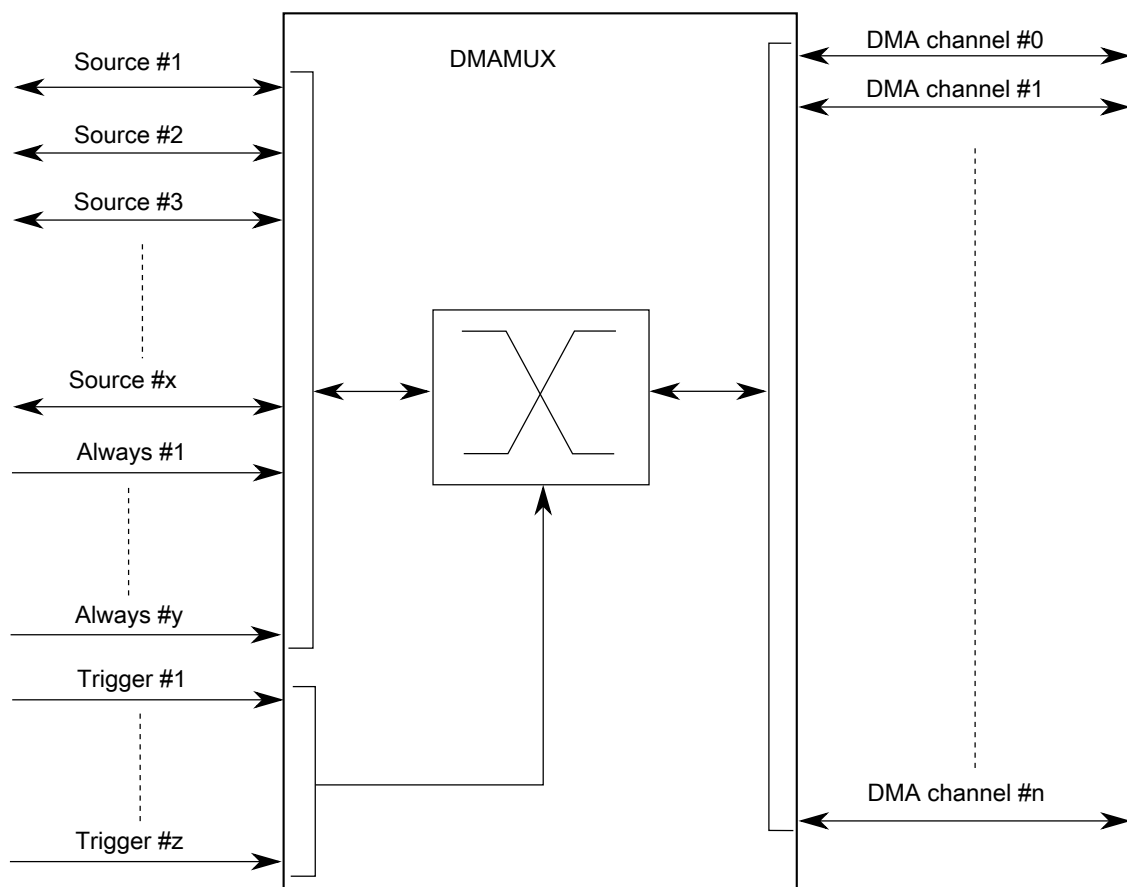

Figure 17-1. DMAMUX block diagram

17.2.2 Features

The DMAMUX module provides these features:

- Up to 61 peripheral slots and up to 2 always-on slots can be routed to 16 channels.
- 16 independently selectable DMA channel routers.
 - The first 4 channels additionally provide a trigger functionality.
- Each channel router can be assigned to one of the possible peripheral DMA slots or to one of the always-on slots.

17.2.3 Modes of operation

The following operating modes are available:

- Disabled mode

In this mode, the DMA channel is disabled. Because disabling and enabling of DMA channels is done primarily via the DMA configuration registers, this mode is used mainly as the reset state for a DMA channel in the DMA channel MUX. It may also be used to temporarily suspend a DMA channel while reconfiguration of the system takes place, for example, changing the period of a DMA trigger.

- Normal mode

In this mode, a DMA source is routed directly to the specified DMA channel. The operation of the DMAMUX in this mode is completely transparent to the system.

- Periodic Trigger mode

In this mode, a DMA source may only request a DMA transfer, such as when a transmit buffer becomes empty or a receive buffer becomes full, periodically.

Configuration of the period is done by an external periodic interrupt timer (for example, PIT). This mode is available only for channels 0–3.

17.3 Memory map/register definition

This section provides a detailed description of all memory-mapped registers in the DMAMUX.

17.3.1 DMAMUX register descriptions

17.3.1.1 DMAMUX memory map

DMAMUX base address: 4002_1000h

Offset	Register	Width (In bits)	Access	Reset value
0h - Fh	Channel Configuration register (CHCFG0 - CHCFG15)	8	RW	00h

17.3.1.2 Channel Configuration register (CHCFG0 - CHCFG15)

17.3.1.2.1 Offset

For a = 0 to 15:

Register	Offset
CHCFGa	0h + (a × 1h)

17.3.1.2.2 Function

Each of the DMA channels can be independently enabled/disabled and associated with one of the DMA slots (peripheral slots or always-on slots) in the system.

NOTE

Setting multiple CHCFG registers with the same source value will result in unpredictable behavior. This is true, even if a channel is disabled (ENBL==0).

Before changing the trigger or source settings, a DMA channel must be disabled via CHCFGn[ENBL].

17.3.1.2.3 Diagram

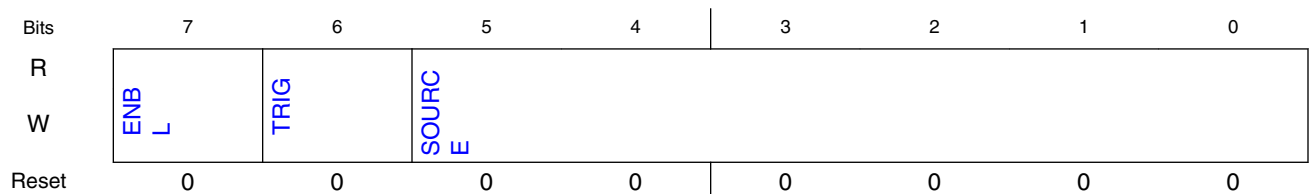

17.3.1.2.4 Fields

Field	Function
7 ENBL	<p>DMA Channel Enable</p> <p>Enables the DMA channel.</p> <p>0b - DMA channel is disabled. This mode is primarily used during configuration of the DMAMux. The DMA has separate channel enables/disables, which should be used to disable or reconfigure a DMA channel.</p> <p>1b - DMA channel is enabled</p>
6 TRIG	<p>DMA Channel Trigger Enable</p> <p>Enables the periodic trigger capability for the triggered DMA channel.</p> <p>0b - Triggering is disabled. If triggering is disabled and ENBL is set, the DMA Channel will simply route the specified source to the DMA channel. (Normal mode)</p> <p>1b - Triggering is enabled. If triggering is enabled and ENBL is set, the DMAMUX is in Periodic Trigger mode.</p>
5-0 SOURCE	<p>DMA Channel Source (Slot)</p> <p>Specifies which DMA source, if any, is routed to a particular DMA channel. See the chip-specific DMAMUX information for details about the peripherals and their slot numbers.</p>

17.4 Functional description

The primary purpose of the DMAMUX is to provide flexibility in the system's use of the available DMA channels.

As such, configuration of the DMAMUX is intended to be a static procedure done during execution of the system boot code. However, if the procedure outlined in [Enabling and configuring sources](#) is followed, the configuration of the DMAMUX may be changed during the normal operation of the system.

Functionally, the DMAMUX channels may be divided into two classes:

- Channels that implement the normal routing functionality plus periodic triggering capability
- Channels that implement only the normal routing functionality

17.4.1 DMA channels with periodic triggering capability

Besides the normal routing functionality, the first 4 channels of the DMAMUX provide a special periodic triggering capability that can be used to provide an automatic mechanism to transmit bytes, frames, or packets at fixed intervals without the need for processor intervention.

Functional description

The trigger is generated by an external periodic interrupt timer (for example, PIT); as such, the configuration of the periodic triggering interval is done via configuring the external periodic timer.

Note

Because of the dynamic nature of the system (due to DMA channel priorities, bus arbitration, interrupt service routine lengths, etc.), the number of clock cycles between a trigger and the actual DMA transfer cannot be guaranteed.

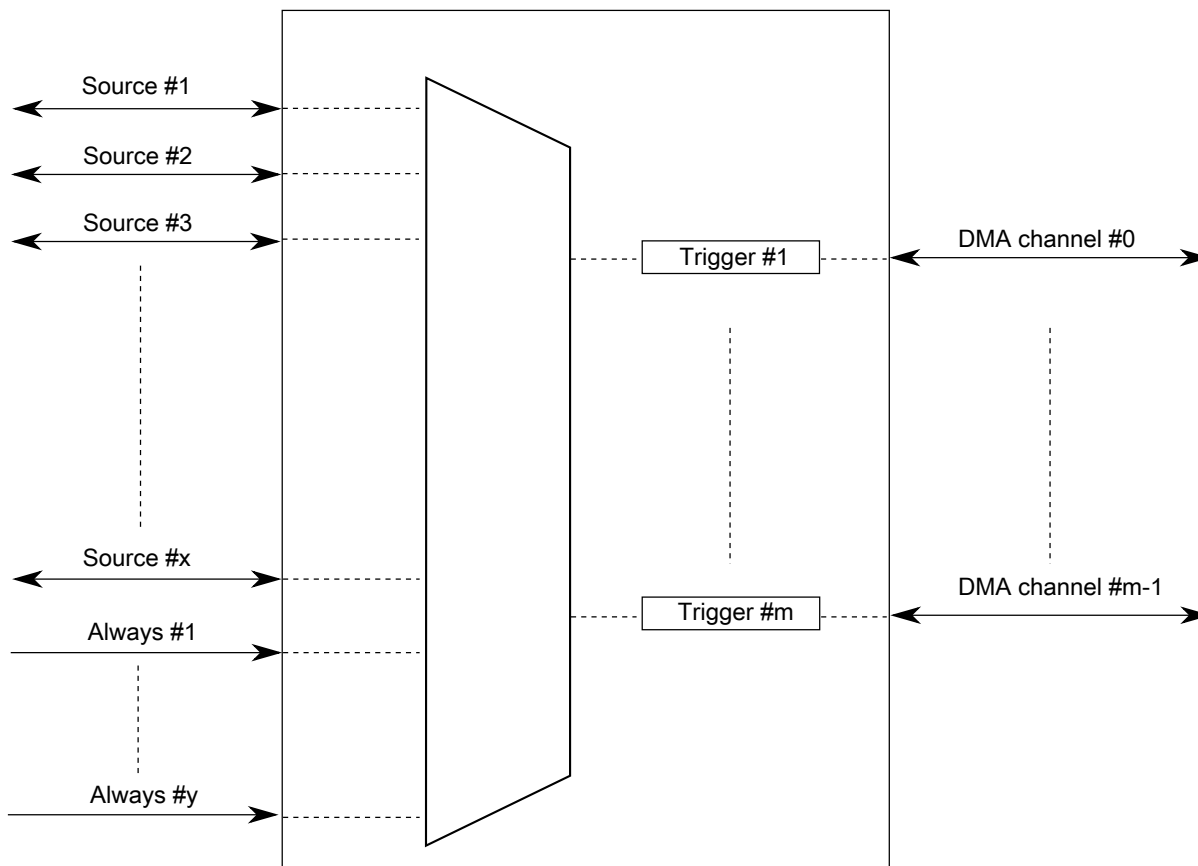

Figure 17-2. DMAMUX triggered channels

The DMA channel triggering capability allows the system to schedule regular DMA transfers, usually on the transmit side of certain peripherals, without the intervention of the processor. This trigger works by gating the request from the peripheral to the DMA until a trigger event has been seen. This is illustrated in the following figure.

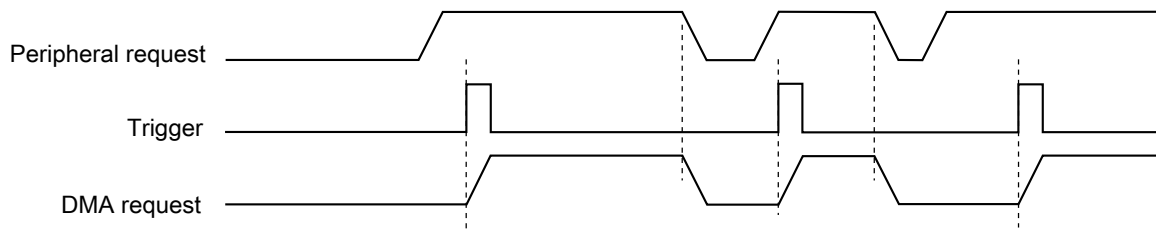

Figure 17-3. DMAMUX channel triggering: normal operation

After the DMA request has been serviced, the peripheral will negate its request, effectively resetting the gating mechanism until the peripheral reasserts its request and the next trigger event is seen. This means that if a trigger is seen, but the peripheral is not requesting a transfer, then that trigger will be ignored. This situation is illustrated in the following figure.

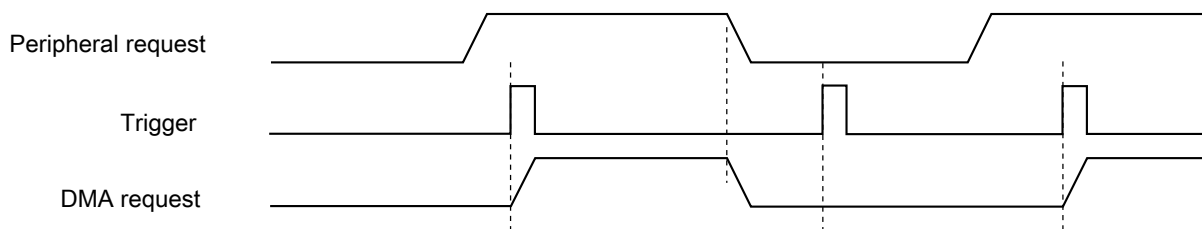

Figure 17-4. DMAMUX channel triggering: ignored trigger

This triggering capability may be used with any peripheral that supports DMA transfers, and is most useful for two types of situations:

- Periodically polling external devices on a particular bus

As an example, the transmit side of an SPI is assigned to a DMA channel with a trigger, as described above. After it has been set up, the SPI will request DMA transfers, presumably from memory, as long as its transmit buffer is empty. By using a trigger on this channel, the SPI transfers can be automatically performed every 5 μ s (as an example). On the receive side of the SPI, the SPI and DMA can be configured to transfer receive data into memory, effectively implementing a method to periodically read data from external devices and transfer the results into memory without processor intervention.

- Using the GPIO ports to drive or sample waveforms

By configuring the DMA to transfer data to one or more GPIO ports, it is possible to create complex waveforms using tabular data stored in on-chip memory. Conversely, using the DMA to periodically transfer data from one or more GPIO ports, it is possible to sample complex waveforms and store the results in tabular form in on-chip memory.

17.4.2 DMA channels with no triggering capability

The other channels of the DMAMUX provide the normal routing functionality as described in [Modes of operation](#).

17.4.3 Always-enabled DMA sources

In addition to the peripherals that can be used as DMA sources, there are 2 additional DMA sources that are always enabled. Unlike the peripheral DMA sources, where the peripheral controls the flow of data during DMA transfers, the sources that are always enabled provide no such "throttling" of the data transfers. These sources are most useful in the following cases:

- Performing DMA transfers to/from GPIO—Moving data from/to one or more GPIO pins, either unthrottled (that is, as fast as possible), or periodically (using the DMA triggering capability).
- Performing DMA transfers from memory to memory—Moving data from memory to memory, typically as fast as possible, sometimes with software activation.
- Performing DMA transfers from memory to the external bus, or vice-versa—Similar to memory to memory transfers, this is typically done as quickly as possible.
- Any DMA transfer that requires software activation—Any DMA transfer that should be explicitly started by software.

In cases where software should initiate the start of a DMA transfer, an always-enabled DMA source can be used to provide maximum flexibility. When activating a DMA channel via software, subsequent executions of the minor loop require that a new start event be sent. This can either be a new software activation, or a transfer request from the DMA channel MUX. The options for doing this are:

- Transfer all data in a single minor loop.

By configuring the DMA to transfer all of the data in a single minor loop (that is, major loop counter = 1), no reactivation of the channel is necessary. The disadvantage to this option is the reduced granularity in determining the load that the DMA transfer will impose on the system. For this option, the DMA channel must be disabled in the DMA channel MUX.

- Use explicit software reactivation.

In this option, the DMA is configured to transfer the data using both minor and major loops, but the processor is required to reactivate the channel by writing to the DMA registers *after every minor loop*. For this option, the DMA channel must be disabled in the DMA channel MUX.

- Use an always-enabled DMA source.

In this option, the DMA is configured to transfer the data using both minor and major loops, and the DMA channel MUX does the channel reactivation. For this option, the DMA channel should be enabled and pointing to an "always enabled" source. Note that the reactivation of the channel can be continuous (DMA triggering is disabled) or can use the DMA triggering capability. In this manner, it is possible to execute periodic transfers of packets of data from one source to another, without processor intervention.

17.5 Initialization/application information

This section provides instructions for initializing the DMA channel MUX.

17.5.1 Reset

The reset state of each individual bit is shown in [Memory map/register definition](#). In summary, after reset, all channels are disabled and must be explicitly enabled before use.

17.5.2 Enabling and configuring sources

To enable a source with periodic triggering:

1. Determine with which DMA channel the source will be associated. Note that only the first 4 DMA channels have periodic triggering capability.
2. Clear the CHCFG[ENBL] and CHCFG[TRIG] fields of the DMA channel.
3. Ensure that the DMA channel is properly configured in the DMA. The DMA channel may be enabled at this point.
4. Configure the corresponding timer.
5. Select the source to be routed to the DMA channel. Write to the corresponding CHCFG register, ensuring that the CHCFG[ENBL] and CHCFG[TRIG] fields are set.

NOTE

The following is an example. See the chip-specific information for the number of this device's DMA channels that have triggering capability.

To configure source #5 transmit for use with DMA channel 1, with periodic triggering capability:

1. Write 0x00 to CHCFG1.
2. Configure channel 1 in the DMA, including enabling the channel.
3. Configure a timer for the desired trigger interval.
4. Write 0xC5 to CHCFG1.

The following code example illustrates steps 1 and 4 above:

```
void DMAMUX_Init(uint8_t DMA_CH, uint8_t DMAMUX_SOURCE)
{
    DMAMUX_0.CHCFG[DMA_CH].B.SOURCE = DMAMUX_SOURCE;
    DMAMUX_0.CHCFG[DMA_CH].B.ENBL   = 1;
    DMAMUX_0.CHCFG[DMA_CH].B.TRIG   = 1;
}
```

To enable a source, without periodic triggering:

1. Determine with which DMA channel the source will be associated. Note that only the first 4 DMA channels have periodic triggering capability.
2. Clear the CHCFG[ENBL] and CHCFG[TRIG] fields of the DMA channel.
3. Ensure that the DMA channel is properly configured in the DMA. The DMA channel may be enabled at this point.
4. Select the source to be routed to the DMA channel. Write to the corresponding CHCFG register, ensuring that CHCFG[ENBL] is set while CHCFG[TRIG] is cleared.

NOTE

The following is an example. See the chip configuration details for the number of this device's DMA channels that have triggering capability.

To configure source #5 transmit for use with DMA channel 1, with no periodic triggering capability:

1. Write 0x00 to CHCFG1.
2. Configure channel 1 in the DMA, including enabling the channel.
3. Write 0x85 to CHCFG1.

The following code example illustrates steps 1 and 3 above:

```
In File registers.h:
#define DMAMUX_BASE_ADDR    0x40021000/* Example only ! */
/* Following example assumes char is 8-bits */
volatile unsigned char *CHCFG0 = (volatile unsigned char *) (DMAMUX_BASE_ADDR+0x0000);
```

```
volatile unsigned char *CHCFG1 = (volatile unsigned char *) (DMAMUX_BASE_ADDR+0x0001);
volatile unsigned char *CHCFG2 = (volatile unsigned char *) (DMAMUX_BASE_ADDR+0x0002);
volatile unsigned char *CHCFG3 = (volatile unsigned char *) (DMAMUX_BASE_ADDR+0x0003);
volatile unsigned char *CHCFG4 = (volatile unsigned char *) (DMAMUX_BASE_ADDR+0x0004);
volatile unsigned char *CHCFG5 = (volatile unsigned char *) (DMAMUX_BASE_ADDR+0x0005);
volatile unsigned char *CHCFG6 = (volatile unsigned char *) (DMAMUX_BASE_ADDR+0x0006);
volatile unsigned char *CHCFG7 = (volatile unsigned char *) (DMAMUX_BASE_ADDR+0x0007);
volatile unsigned char *CHCFG8 = (volatile unsigned char *) (DMAMUX_BASE_ADDR+0x0008);
volatile unsigned char *CHCFG9 = (volatile unsigned char *) (DMAMUX_BASE_ADDR+0x0009);
volatile unsigned char *CHCFG10= (volatile unsigned char *) (DMAMUX_BASE_ADDR+0x000A);
volatile unsigned char *CHCFG11= (volatile unsigned char *) (DMAMUX_BASE_ADDR+0x000B);
volatile unsigned char *CHCFG12= (volatile unsigned char *) (DMAMUX_BASE_ADDR+0x000C);
volatile unsigned char *CHCFG13= (volatile unsigned char *) (DMAMUX_BASE_ADDR+0x000D);
volatile unsigned char *CHCFG14= (volatile unsigned char *) (DMAMUX_BASE_ADDR+0x000E);
volatile unsigned char *CHCFG15= (volatile unsigned char *) (DMAMUX_BASE_ADDR+0x000F);
```

```
In File main.c:
#include "registers.h"
:
:
*CHCFG1 = 0x00;
*CHCFG1 = 0x85;
```

To disable a source:

A particular DMA source may be disabled by not writing the corresponding source value into any of the CHCFG registers. Additionally, some module-specific configuration may be necessary. See the appropriate section for more details.

To switch the source of a DMA channel:

1. Disable the DMA channel in the DMA and reconfigure the channel for the new source.
2. Clear the CHCFG[ENBL] and CHCFG[TRIG] bits of the DMA channel.
3. Select the source to be routed to the DMA channel. Write to the corresponding CHCFG register, ensuring that the CHCFG[ENBL] and CHCFG[TRIG] fields are set.

To switch DMA channel 8 from source #5 transmit to source #7 transmit:

1. In the DMA configuration registers, disable DMA channel 8 and reconfigure it to handle the transfers to peripheral slot 7. This example assumes channel 8 doesn't have triggering capability.
2. Write 0x00 to CHCFG8.
3. Write 0x87 to CHCFG8. (In this example, setting CHCFG[TRIG] would have no effect due to the assumption that channel 8 does not support the periodic triggering functionality.)

The following code example illustrates steps 2 and 3 above:

```
In File registers.h:
#define DMAMUX_BASE_ADDR    0x40021000/* Example only ! */
/* Following example assumes char is 8-bits */
volatile unsigned char *CHCFG0 = (volatile unsigned char *) (DMAMUX_BASE_ADDR+0x0000);
volatile unsigned char *CHCFG1 = (volatile unsigned char *) (DMAMUX_BASE_ADDR+0x0001);
volatile unsigned char *CHCFG2 = (volatile unsigned char *) (DMAMUX_BASE_ADDR+0x0002);
volatile unsigned char *CHCFG3 = (volatile unsigned char *) (DMAMUX_BASE_ADDR+0x0003);
```

Initialization/application information

```
volatile unsigned char *CHCFG4 = (volatile unsigned char *) (DMAMUX_BASE_ADDR+0x0004);
volatile unsigned char *CHCFG5 = (volatile unsigned char *) (DMAMUX_BASE_ADDR+0x0005);
volatile unsigned char *CHCFG6 = (volatile unsigned char *) (DMAMUX_BASE_ADDR+0x0006);
volatile unsigned char *CHCFG7 = (volatile unsigned char *) (DMAMUX_BASE_ADDR+0x0007);
volatile unsigned char *CHCFG8 = (volatile unsigned char *) (DMAMUX_BASE_ADDR+0x0008);
volatile unsigned char *CHCFG9 = (volatile unsigned char *) (DMAMUX_BASE_ADDR+0x0009);
volatile unsigned char *CHCFG10= (volatile unsigned char *) (DMAMUX_BASE_ADDR+0x000A);
volatile unsigned char *CHCFG11= (volatile unsigned char *) (DMAMUX_BASE_ADDR+0x000B);
volatile unsigned char *CHCFG12= (volatile unsigned char *) (DMAMUX_BASE_ADDR+0x000C);
volatile unsigned char *CHCFG13= (volatile unsigned char *) (DMAMUX_BASE_ADDR+0x000D);
volatile unsigned char *CHCFG14= (volatile unsigned char *) (DMAMUX_BASE_ADDR+0x000E);
volatile unsigned char *CHCFG15= (volatile unsigned char *) (DMAMUX_BASE_ADDR+0x000F);
```

```
In File main.c:
#include "registers.h"
:
:
*CHCFG8 = 0x00;
*CHCFG8 = 0x87;
```

Chapter 18

Enhanced Direct Memory Access (eDMA)

18.1 Chip-specific eDMA information

Wait mode is not supported. See [Module operation in available low power modes](#) for details on available power modes.

16-byte burst and 32-byte burst is not supported on S32K11x variants.

18.1.1 Seamless eDMA transfer

For S32K11x variants, there are two options to make DMA transfers seamless:

Option 1: When executing a large, zero wait-stated memory-to-memory transfer (as an example transfers greater than 16 MB of transfer size), insert bandwidth control using the TCD_CSR[BWC] bits to avoid:

- Starvation of another master accessing the memory
- Any delay in writing a TCD during the transfer

NOTE

- This option always adds wait states for every DMA transfer.
- Without following this option, the software code working properly on S32K14x and S32K14xW devices might fail on S32K11x devices.

Option 2: For S32K11x devices, crossbar must be programmed to round-robin arbitration (configuring [MCM_CPCR\[CBRR\]](#) as '1') for seamless DMA transfers. This option affects all master configurations on the crossbar.

NOTE

- No bandwidth control insertion is needed in this option.
- This option works seamlessly for S32K14x and S32K14xW devices also.

18.1.2 Number of channels

The number of channels across the series varies across variants. See below table for the same.

Table 18-1. Number of channles

Chips	Number of channels
S32K116	4
S32K118	4
S32K142	16
S32K142W	16
S32K144	16
S32K144W	16
S32K146	16
S32K148	16

18.2 Overview

The enhanced direct memory access (eDMA) controller is a second-generation module capable of performing complex data transfers with minimal intervention from a host processor. The hardware microarchitecture includes:

- A DMA engine that performs:
 - Source address and destination address calculations
 - Data-movement operations
- Local memory containing transfer control descriptors for each of the 16 channels

18.2.1 Block diagram

The following figure illustrates the components of the eDMA system, including the eDMA module ("engine").

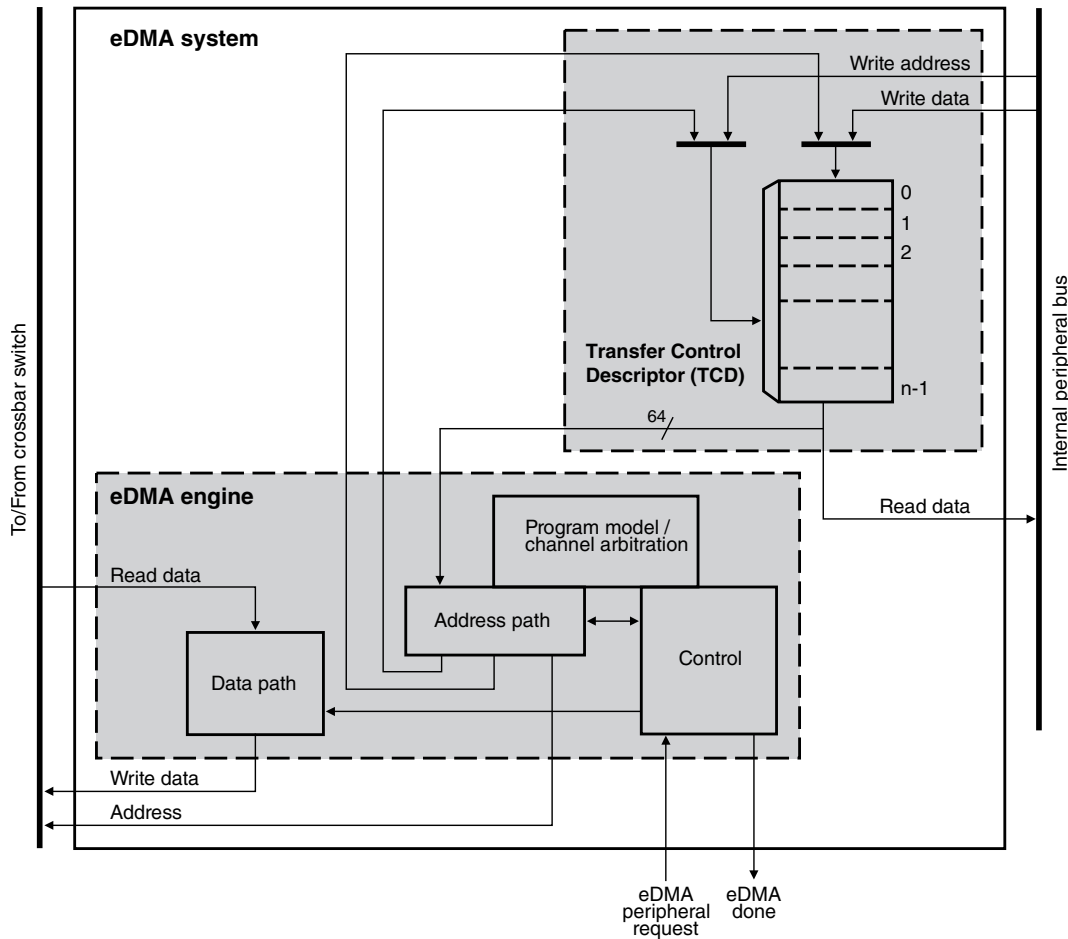

Figure 18-1. Block diagram

18.2.2 Block parts

The eDMA module comprises two major modules: the eDMA engine and the transfer-control descriptor local memory.

Table 18-2 describes the eDMA engine submodules.

Table 18-2. eDMA engine submodules

Submodule	Function
Address path	<p>The address path block:</p> <ul style="list-style-type: none"> Provides registered versions of two channel Transfer Control Descriptors (TCDs)—channel x (normal start) and channel y (preemption start) Manages all master bus-address calculations <p>All channels provide the same functionality. This structure enables preemption of data transfers associated with an active channel (after completion of a read/write sequence) if the eDMA engine asserts a higher priority channel activation.</p>

Table continues on the next page...

Table 18-2. eDMA engine submodules (continued)

Submodule	Function
	<p>After eDMA activates a channel, it runs until the minor loop completes, unless preempted by a higher priority channel. This provides a mechanism (enabled by DCHPRI_n[ECP]) in which the eDMA engine can preempt a large data move operation to minimize the time another channel stalls.</p> <p>When the eDMA engine selects a channel to execute, it reads the contents of the channel TCD from local memory and loads it into one of the following:</p> <ul style="list-style-type: none"> • The address path channel x registers (normal start) • The address path channel y registers (preemption start) <p>After the minor loop execution completes, the address path hardware writes the new values for the TCD_n{SADDR, DADDR, CITER} back to local memory. If the major iteration count completes, the eDMA engine performs additional processing, including:</p> <ul style="list-style-type: none"> • Final address pointer updates • Reloading the TCD_n_CITER field • A possible fetch of the next TCD_n from memory as part of a scatter/gather operation.
Data path	<p>The data path block implements the bus master read/write data path. It includes a data buffer and the necessary multiplex logic to support any required data alignment. The internal read data bus is the primary input, and the internal write data bus is the primary output.</p> <p>The address and data path modules directly support the two-stage pipelined internal bus. The address path module represents the first stage of the bus pipeline (address phase). The data path module implements the second stage of the pipeline (data phase).</p>
Programming model/ channel arbitration	<p>This block implements:</p> <ul style="list-style-type: none"> • The first section of the eDMA programming model • Channel arbitration logic <p>The programming model registers connect to the chip's internal peripheral bus. The eDMA peripheral request inputs and interrupt request outputs also connect to this block (via control logic).</p>
Control	<p>The control block provides all control functions for the eDMA engine. For data transfers in which the source size (SSIZE) and destination size (DSIZE) are equal, the eDMA engine performs a series of source read/destination write operations until it has transferred the number of bytes specified in the minor loop byte count (NBYTES). For TCDs in which the source and destination sizes are not equal, the eDMA engine executes multiple accesses of the smaller size data for each reference of the larger size. For example, if the source size (SSIZE) references 16-bit data and the destination size (DSIZE) is 32-bit data, eDMA performs two reads, then one 32-bit write.</p>

[Table 18-3](#) explains the partitioning of the TCD local memory.

Table 18-3. Transfer control descriptor memory

Submodule	Description
Memory controller	The Memory controller logic implements the required dual-ported controller, managing accesses from the eDMA engine as well as references from the internal peripheral bus. If simultaneous accesses occur, the eDMA engine receives priority and the peripheral transaction stalls.
Memory array	The Memory array provides TCD storage for the transfer profile for each channel.

18.2.3 Features

The eDMA module is a highly programmable data-transfer engine optimized to minimize any required intervention from the host processor. Use it for applications where you statically know the size of the data to be transferred and do not define the size within the transferred data itself. The eDMA module features:

- All data movement via dual-address transfers: read from source, write to destination
 - Programmable source and destination addresses and transfer size
 - Support for enhanced addressing modes
- 16-channel implementation performs complex data transfers with minimal intervention from a host processor
 - Internal data buffer, used as temporary storage to support 16- and 32-byte transfers
 - Connections to the crossbar switch (AXBS) for bus mastering the data movement
- TCD supports two-deep, nested transfer operations
 - 32-byte TCD stored in local memory for each channel
 - An inner data transfer loop defined by a minor byte transfer count
 - An outer data transfer loop defined by a major iteration count
- Channel activation via one of three methods:
 - Explicit software initiation
 - Initiation via a channel-to-channel linking mechanism for continuous transfers
 - Peripheral-paced hardware requests, one per channel
- Fixed-priority and round-robin channel arbitration
- Channel completion notification via programmable interrupt requests
 - One interrupt per channel. eDMA engine can generate an interrupt when major iteration count completes
 - Programmable error terminations per channel and logically summed together to form one error interrupt to the interrupt controller
- Programmable support for scatter/gather DMA processing
- Support for complex data structures

NOTE

In the discussion of this module, n is the channel number.

18.3 Memory map/register definition

The eDMA programming model consists of registers that provide:

- Control and status functions
- Channel configuration functions
- TCD definition functions

18.3.1 TCD memory

Each channel requires a 32-byte TCD to define the desired data movement operation. The channel descriptors are in local memory in sequential order: channel 0, channel 1, ... channel 15. Each TCD n definition comprises 11 registers of 16 or 32 bits.

18.3.2 TCD initialization

Before activating a channel, you must initialize its TCD with the appropriate transfer profile.

18.3.3 TCD structure

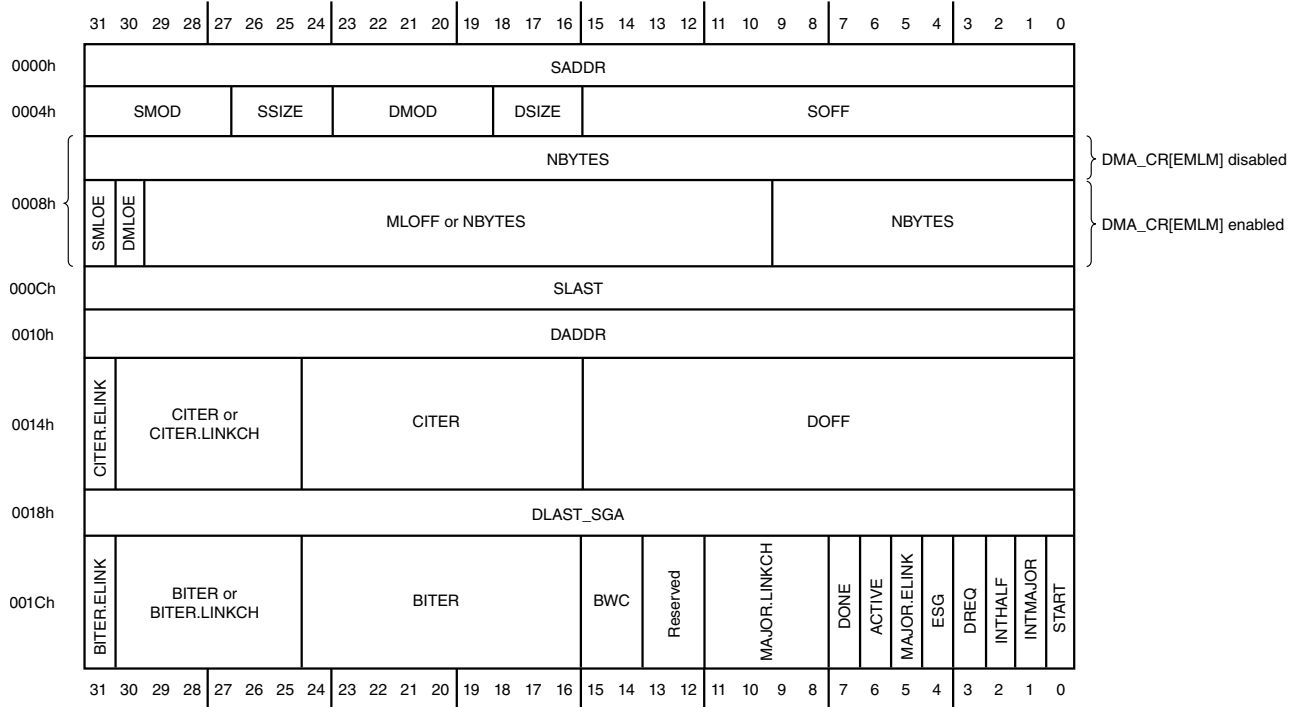

18.3.4 Reserved memory and fields

- Reading reserved fields in a register returns the value of zero.
- The eDMA ignores writes to reserved bits in a register.
- Reading or writing a reserved memory location generates a bus error.

18.3.5 DMA register descriptions

18.3.5.1 DMA memory map

DMA base address: 4000_8000h

Offset	Register	Width (In bits)	Access	Reset value
0h	Control (CR)	32	RW	Table 18-3
4h	Error Status (ES)	32	RO	0000_0000h
Ch	Enable Request (ERQ)	32	RW	0000_0000h

Table continues on the next page...

Memory map/register definition

Offset	Register	Width (In bits)	Access	Reset value
14h	Enable Error Interrupt (EEI)	32	RW	0000_0000h
18h	Clear Enable Error Interrupt (CEEI)	8	WORZ	00h
19h	Set Enable Error Interrupt (SEEI)	8	WORZ	00h
1Ah	Clear Enable Request (CERQ)	8	WORZ	00h
1Bh	Set Enable Request (SERQ)	8	WORZ	00h
1Ch	Clear DONE Status Bit (CDNE)	8	WORZ	00h
1Dh	Set START Bit (SSRT)	8	WORZ	00h
1Eh	Clear Error (CERR)	8	WORZ	00h
1Fh	Clear Interrupt Request (CINT)	8	WORZ	00h
24h	Interrupt Request (INT)	32	W1C	0000_0000h
2Ch	Error (ERR)	32	W1C	0000_0000h
34h	Hardware Request Status (HRS)	32	RO	0000_0000h
44h	Enable Asynchronous Request in Stop (EARS)	32	RW	0000_0000h
100h	Channel Priority (DCHPRI3)	8	RW	03h
101h	Channel Priority (DCHPRI2)	8	RW	02h
102h	Channel Priority (DCHPRI1)	8	RW	01h
103h	Channel Priority (DCHPRI0)	8	RW	00h
104h	Channel Priority (DCHPRI7)	8	RW	07h
105h	Channel Priority (DCHPRI6)	8	RW	06h
106h	Channel Priority (DCHPRI5)	8	RW	05h
107h	Channel Priority (DCHPRI4)	8	RW	04h
108h	Channel Priority (DCHPRI11)	8	RW	0Bh
109h	Channel Priority (DCHPRI10)	8	RW	0Ah
10Ah	Channel Priority (DCHPRI9)	8	RW	09h
10Bh	Channel Priority (DCHPRI8)	8	RW	08h
10Ch	Channel Priority (DCHPRI15)	8	RW	0Fh
10Dh	Channel Priority (DCHPRI14)	8	RW	0Eh
10Eh	Channel Priority (DCHPRI13)	8	RW	0Dh
10Fh	Channel Priority (DCHPRI12)	8	RW	0Ch
1000h - 11E0h	TCD Source Address (TCD0_SADDR - TCD15_SADDR)	32	RW	Table 18-3
1004h - 11E4h	TCD Signed Source Address Offset (TCD0_SOFF - TCD15_SOFF)	16	RW	Table 18-3
1006h - 11E6h	TCD Transfer Attributes (TCD0_ATTR - TCD15_ATTR)	16	RW	Table 18-3
1008h - 11E8h	TCD Minor Byte Count (Minor Loop Mapping Disabled) (TCD0_NBYTES_MLNO - TCD15_NBYTES_MLNO)	32	RW	Table 18-3
1008h - 11E8h	TCD Signed Minor Loop Offset (Minor Loop Mapping Enabled and Offset Disabled) (TCD0_NBYTES_MLOFFNO - TCD15_NBYTES_MLOFFNO)	32	RW	Table 18-3

Table continues on the next page...

Offset	Register	Width (In bits)	Access	Reset value
1008h - 11E8h	TCD Signed Minor Loop Offset (Minor Loop Mapping and Offset Enabled) (TCD0_NBYTES_MLOFFYES - TCD15_NBYTES_MLOFFYES)	32	RW	Table 18-3
100Ch - 11ECh	TCD Last Source Address Adjustment (TCD0_SLAST - TCD15_SLAST)	32	RW	Table 18-3
1010h - 11F0h	TCD Destination Address (TCD0_DADDR - TCD15_DADDR)	32	RW	Table 18-3
1014h - 11F4h	TCD Signed Destination Address Offset (TCD0_DOFF - TCD15_DOFF)	16	RW	Table 18-3
1016h - 11F6h	TCD Current Minor Loop Link, Major Loop Count (Channel Linking Disabled) (TCD0_CITER_ELINKNO - TCD15_CITER_ELINKNO)	16	RW	Table 18-3
1016h - 11F6h	TCD Current Minor Loop Link, Major Loop Count (Channel Linking Enabled) (TCD0_CITER_ELINKYES - TCD15_CITER_ELINKYES)	16	RW	Table 18-3
1018h - 11F8h	TCD Last Destination Address Adjustment/Scatter Gather Address (TCD0_DLASTSGA - TCD15_DLASTSGA)	32	RW	Table 18-3
101Ch - 11FCh	TCD Control and Status (TCD0_CSR - TCD15_CSR)	16	RW	Table 18-3
101Eh - 11FEh	TCD Beginning Minor Loop Link, Major Loop Count (Channel Linking Disabled) (TCD0_BITER_ELINKNO - TCD15_BITER_ELINKNO)	16	RW	Table 18-3
101Eh - 11FEh	TCD Beginning Minor Loop Link, Major Loop Count (Channel Linking Enabled) (TCD0_BITER_ELINKYES - TCD15_BITER_ELINKYES)	16	RW	Table 18-3

18.3.5.2 Control (CR)

18.3.5.2.1 Offset

Register	Offset
CR	0h

18.3.5.2.2 Function

This register defines the basic operating configuration of the eDMA module.

You can configure arbitration to use either a fixed-priority or a round-robin scheme. For fixed-priority arbitration, eDMA selects and executes the highest-priority channel that requests service. The channel priority registers assign the priorities (see the [Channel Priority \(DCHPRI0 - DCHPRI15\)](#) registers). For round-robin arbitration, the eDMA engine ignores channel priorities and cycles through channels from high to low channel number without regard to priority.

NOTE

For correct operation, you must write to this register only when the eDMA channels are inactive—that is, when $TCDn_CSR[ACTIVE] = 0$.

Minor loop offsets are address-offset values to be added to the final source address ($TCDn_SADDR$) or destination address ($TCDn_DADDR$) when the minor loop completes. When you enable minor loop offsets, eDMA adds the minor loop offset (MLOFF) value to the final source address ($TCDn_SADDR$), to the final destination address ($TCDn_DADDR$), or to both, before it writes the addresses back into the TCD. If the major loop is complete, eDMA ignores the minor loop offset, and uses the major loop address offsets ($TCDn_SLAST$ and $TCDn_DLAST_SGA$) to compute the next $TCDn_SADDR$ and $TCDn_DADDR$ values.

Enabling minor loop mapping ($EMLM = 1$) redefines $TCDn$ word2. eDMA uses a portion of $TCDn$ word2 for multiple fields:

- A source enable field (SMLOE) to specify the minor loop offset is to be applied to the source address ($TCDn_SADDR$) when the minor loop completes
- A destination enable field (DMLOE) to specify the minor loop offset to be applied to the destination address ($TCDn_DADDR$) when the minor loop completes
- The sign extended minor loop offset value (MLOFF).

eDMA uses the same offset value (MLOFF) for both source and destination minor loop offsets. When you enable either minor loop offset ($SMLOE = 1$ or $DMLOE = 1$), the NBYTES field reduces in size to 10 bits. When you disable both minor loop offsets ($SMLOE = 0$ and $DMLOE = 0$), the NBYTES field is a 30-bit vector.

When you disable minor loop mapping ($EMLM = 0$), the NBYTES field contains all 32 bits of $TCDn$ word2.

18.3.5.2.3 Diagram

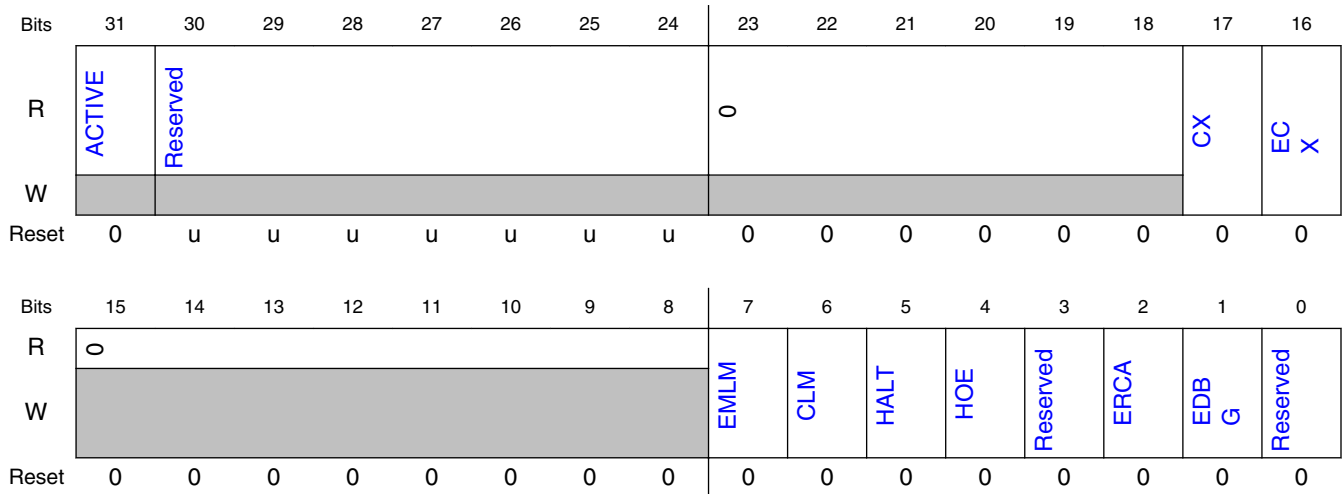

18.3.5.2.4 Fields

Field	Function
31 ACTIVE	eDMA Active Status 0b - eDMA is idle 1b - eDMA is executing a channel
30-24 —	Reserved
23-18 —	Reserved
17 CX	<p>Cancel Transfer</p> <p>When you write 1 to this field, the following actions take place:</p> <ul style="list-style-type: none"> Stop the executing channel Force the minor loop to finish. <p>The cancellation takes effect after the last write of the current read/write sequence. This field is automatically written with 0 after the cancellation completes. The cancellation retires the channel normally as if the minor loop completed.</p> <p>0b - Normal operation 1b - Cancel the remaining data transfer</p>
16 ECX	<p>Error Cancel Transfer</p> <p>When you write a 1 to this field, the following actions take place:</p> <ul style="list-style-type: none"> Stop the executing channel Force the minor loop to finish. <p>The cancellation takes effect after the last write of the current read/write sequence. This field is automatically reset to 0 after the cancellation completes. In addition to cancelling the transfer, eDMA:</p> <ul style="list-style-type: none"> Treats the cancel as an error condition Updates the Error Status register (DMAx_ES) Optionally generates an error interrupt. <p>0b - Normal operation</p>

Table continues on the next page...

Memory map/register definition

Field	Function
	1b - Cancel the remaining data transfer
15-8 —	Reserved
7 EMLM	<p>Enable Minor Loop Mapping</p> <p>When the value of this field is 0, TCDn.word2 is a 32-bit NBYTES field. When the value of this field is 1, TCDn.word2 includes:</p> <ul style="list-style-type: none"> • Individual enable fields • An offset field • The NBYTES field. <p>The individual enable fields allow the minor loop offset to be applied to the source address, the destination address, or both. The NBYTES field reduces in size when either offset is enabled.</p> <p>0b - Disabled 1b - Enabled</p>
6 CLM	<p>Continuous Link Mode</p> <p>When the value of this field is 0, a minor loop channel link made to itself goes through channel arbitration before being activated again. When the value of this field is 1, a minor loop channel link made to itself does not go through channel arbitration before being activated again. When the minor loop completes, the channel activates again if that channel has a minor loop channel link enabled and the link channel is itself. This effectively applies the minor loop offsets and restarts the next minor loop.</p> <p>NOTE: Do not use continuous link mode with a channel linking to itself if there is only one minor loop iteration per service request, for example, if the channel's NBYTES value is the same as either the source or destination size. The same data transfer profile can be achieved by simply increasing the NBYTES value, which provides more efficient, faster processing.</p> <p>0b - Continuous link mode is off 1b - Continuous link mode is on</p>
5 HALT	<p>Halt eDMA Operations</p> <p>When this field is 1 the following actions take place:</p> <ul style="list-style-type: none"> • eDMA stalls the start of any new channels • Executing channels are allowed to complete. <p>When you write 0 to this field, channel execution resumes.</p> <p>0b - Normal operation 1b - eDMA operations halted</p>
4 HOE	<p>Halt On Error</p> <p>When this field is 1, any error causes the eDMA engine to write 1 to the HALT field. Subsequently, the eDMA engine ignores all service requests until you write 0 to the HALT field.</p> <p>0b - Normal operation 1b - Error causes HALT field to be automatically set to 1</p>
3 —	Reserved
2 ERCA	<p>Enable Round Robin Channel Arbitration</p> <p>When you write 1 to this field, eDMA uses round robin arbitration for channel selection. Otherwise, eDMA uses fixed priority arbitration for channel selection.</p> <p>0b - Fixed priority arbitration 1b - Round robin arbitration</p>
1 EDBG	<p>Enable Debug</p> <p>When this field is 0 and the chip enters Debug mode, eDMA continues operation. When this field is 1, entry of the chip into Debug mode causes the eDMA to stall the start of a new channel. Executing</p>

Table continues on the next page...

Field	Function
	channels are allowed to complete. Channel execution resumes when the chip exits Debug mode or you write 0 to this field. 0b - When the chip is in Debug mode, the eDMA continues to operate. 1b - When the chip is in debug mode, the DMA stalls the start of a new channel. Executing channels are allowed to complete.
0 —	Reserved

18.3.5.3 Error Status (ES)

18.3.5.3.1 Offset

Register	Offset
ES	4h

18.3.5.3.2 Function

The ES register provides information concerning the most-recently recorded channel error. Channel errors can be caused by:

- A configuration error, that is:
 - An illegal setting in the transfer-control descriptor
 - An illegal priority register setting in fixed arbitration
- An error termination to a bus master read or write cycle
- A cancel transfer with error field that is 1 when a transfer is canceled via the corresponding cancel transfer control field

See [Fault reporting and handling](#) for more details.

18.3.5.3.3 Diagram

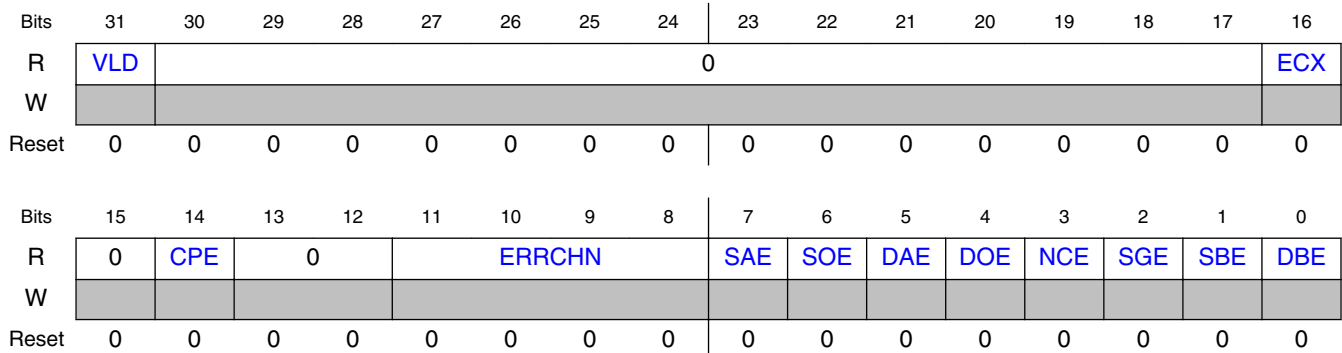

18.3.5.3.4 Fields

Field	Function
31 VLD	Logical OR of all ERR status fields 0b - No ERR fields are 1 1b - At least one ERR field has a value of 1, indicating a valid error exists that has not been cleared
30-17 —	Reserved
16 ECX	Transfer Canceled 0b - No canceled transfers 1b - The most-recently recorded entry was a canceled transfer initiated by the error cancel transfer field
15 —	Reserved
14 CPE	Channel Priority Error 0b - No channel priority error. 1b - The most-recently recorded error was a configuration error in the channel priorities. Channel priorities are not unique.
13-12 —	Reserved
11-8 ERRCHN	Error Channel Number or Canceled Channel Number The channel number of the most-recently recorded error, excluding CPE errors or most-recently recorded error canceled transfer.
7 SAE	Source Address Error 0b - No source address configuration error. 1b - The most-recently recorded error was a configuration error detected in the TCDn_SADDR field. TCDn_SADDR is inconsistent with TCDn_ATTR[SSIZE].
6 SOE	Source Offset Error 0b - No source offset configuration error. 1b - The most-recently recorded error was a configuration error detected in the TCDn_SOFF field. TCDn_SOFF is inconsistent with TCDn_ATTR[SSIZE].
5 DAE	Destination Address Error 0b - No destination address configuration error. 1b - The most-recently recorded error was a configuration error detected in the TCDn_DADDR field. TCDn_DADDR is inconsistent with TCDn_ATTR[DSIZE].
4 DOE	Destination Offset Error 0b - No destination offset configuration error. 1b - The most-recently recorded error was a configuration error detected in the TCDn_DOFF field. TCDn_DOFF is inconsistent with TCDn_ATTR[DSIZE].
3 NCE	NBYTES/CITER Configuration Error 0b - No NBYTES/CITER configuration error. 1b - The most-recently recorded error was a configuration error detected in the TCDn_NBYTES or TCDn_CITER fields. TCDn_NBYTES is not a multiple of TCDn_ATTR[SSIZE] and TCDn_ATTR[DSIZE], or TCDn_CITER[CITER] = 0, or TCDn_CITER[ELINK] is not equal to TCDn_BITER[ELINK].
2 SGE	Scatter/Gather Configuration Error

Table continues on the next page...

Field	Function
	When 1, this field indicates the most-recently recorded error was a configuration error detected in the TCDn_DLASTSGA field. eDMA checks This field at the beginning of a scatter/gather operation after major loop completion if TCDn_CSR[ESG] is enabled. TCDn_DLASTSGA is not on a 32-byte boundary. 0b - No scatter/gather configuration error. 1b - The most-recently recorded error was a configuration error detected in the TCDn_DLASTSGA field.
1 SBE	Source Bus Error 0b - No source bus error. 1b - The most-recently recorded error was a bus error on a source read.
0 DBE	Destination Bus Error 0b - No destination bus error. 1b - The most-recently recorded error was a bus error on a destination write.

18.3.5.4 Enable Request (ERQ)

18.3.5.4.1 Offset

Register	Offset
ERQ	Ch

18.3.5.4.2 Function

The ERQ register provides a bit map for the 16 channels to enable the request signal for each channel. The state of any given channel enable is directly affected by writes to this register; it is also affected by writes to the SERQ and CERQ registers. These registers are provided so the request enable for a single channel can easily be modified without needing to perform a read-modify-write sequence to this register.

DMA request input signals and this enable request field must be set to 1 before a channel's hardware service request is accepted. The state of the DMA enable request field does not affect a channel service request made explicitly through software or a linked channel request.

NOTE

Disable a channel's hardware service request at the source before writing 0 to the channel's ERQ field.

18.3.5.4.3 Diagram

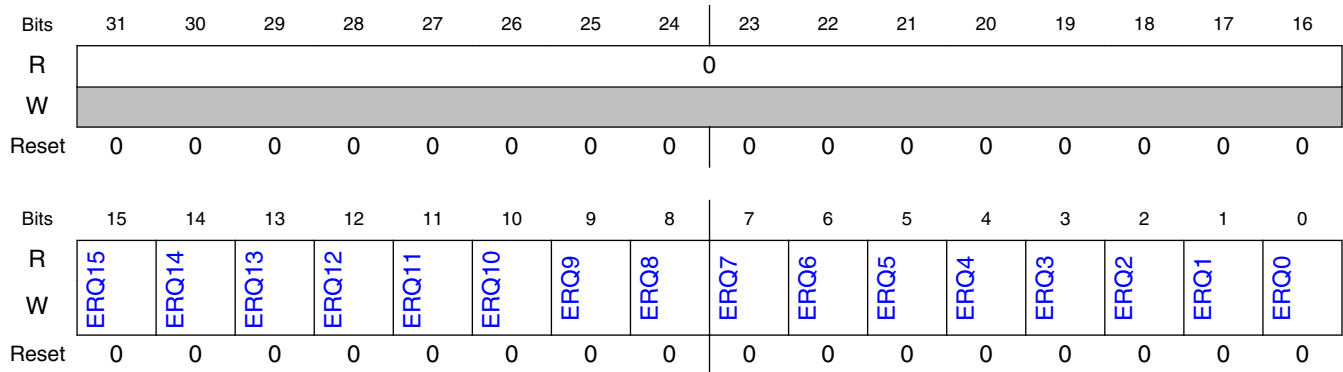

18.3.5.4.4 Fields

Field	Function
31-16 —	Reserved
15 ERQ15	Enable DMA Request 15 0b - The DMA request signal for channel 15 is disabled 1b - The DMA request signal for channel 15 is enabled
14 ERQ14	Enable DMA Request 14 0b - The DMA request signal for channel 14 is disabled 1b - The DMA request signal for channel 14 is enabled
13 ERQ13	Enable DMA Request 13 0b - The DMA request signal for channel 13 is disabled 1b - The DMA request signal for channel 13 is enabled
12 ERQ12	Enable DMA Request 12 0b - The DMA request signal for channel 12 is disabled 1b - The DMA request signal for channel 12 is enabled
11 ERQ11	Enable DMA Request 11 0b - The DMA request signal for channel 11 is disabled 1b - The DMA request signal for channel 11 is enabled
10 ERQ10	Enable DMA Request 10 0b - The DMA request signal for channel 10 is disabled 1b - The DMA request signal for channel 10 is enabled
9 ERQ9	Enable DMA Request 9 0b - The DMA request signal for channel 9 is disabled 1b - The DMA request signal for channel 9 is enabled
8 ERQ8	Enable DMA Request 8 0b - The DMA request signal for channel 8 is disabled 1b - The DMA request signal for channel 8 is enabled
7 ERQ7	Enable DMA Request 7 0b - The DMA request signal for channel 7 is disabled 1b - The DMA request signal for channel 7 is enabled
6	Enable DMA Request 6 0b - The DMA request signal for channel 6 is disabled

Table continues on the next page...

Field	Function
ERQ6	1b - The DMA request signal for channel 6 is enabled
5 ERQ5	Enable DMA Request 5 0b - The DMA request signal for channel 5 is disabled 1b - The DMA request signal for channel 5 is enabled
4 ERQ4	Enable DMA Request 4 0b - The DMA request signal for channel 4 is disabled 1b - The DMA request signal for channel 4 is enabled
3 ERQ3	Enable DMA Request 3 0b - The DMA request signal for channel 3 is disabled 1b - The DMA request signal for channel 3 is enabled
2 ERQ2	Enable DMA Request 2 0b - The DMA request signal for channel 2 is disabled 1b - The DMA request signal for channel 2 is enabled
1 ERQ1	Enable DMA Request 1 0b - The DMA request signal for channel 1 is disabled 1b - The DMA request signal for channel 1 is enabled
0 ERQ0	Enable DMA Request 0 0b - The DMA request signal for channel 0 is disabled 1b - The DMA request signal for channel 0 is enabled

18.3.5.5 Enable Error Interrupt (EEI)

18.3.5.5.1 Offset

Register	Offset
EEI	14h

18.3.5.5.2 Function

The EEI register provides a bit map for the 16 channels to enable the error interrupt signal for each channel. The state of any given channel's error interrupt enable is directly affected by writes to this register; it is also affected by writes to the SEEI and CEEI registers. These registers are provided so that the error interrupt enable for a single channel can easily be modified without the need to perform a read-modify-write sequence to the EEI register.

The DMA error indicator and the error interrupt enable field must be set to 1 before an error interrupt request for a given channel is sent to the interrupt controller.

18.3.5.5.3 Diagram

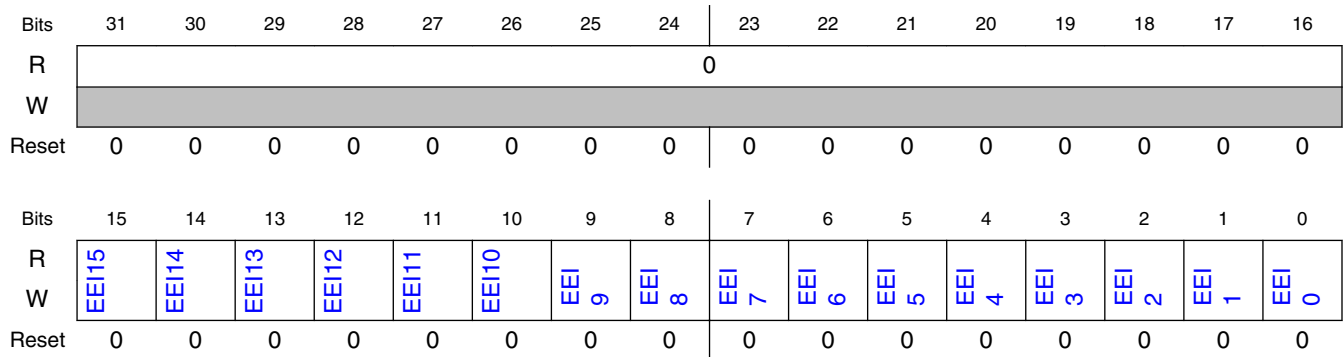

18.3.5.5.4 Fields

Field	Function
31-16 —	Reserved
15 EEI15	Enable Error Interrupt 15 0b - An error on channel 15 does not generate an error interrupt 1b - An error on channel 15 generates an error interrupt request
14 EEI14	Enable Error Interrupt 14 0b - An error on channel 14 does not generate an error interrupt 1b - An error on channel 14 generates an error interrupt request
13 EEI13	Enable Error Interrupt 13 0b - An error on channel 13 does not generate an error interrupt 1b - An error on channel 13 generates an error interrupt request
12 EEI12	Enable Error Interrupt 12 0b - An error on channel 12 does not generate an error interrupt 1b - An error on channel 12 generates an error interrupt request
11 EEI11	Enable Error Interrupt 11 0b - An error on channel 11 does not generate an error interrupt 1b - An error on channel 11 generates an error interrupt request
10 EEI10	Enable Error Interrupt 10 0b - An error on channel 10 does not generate an error interrupt 1b - An error on channel 10 generates an error interrupt request
9 EEI9	Enable Error Interrupt 9 0b - An error on channel 9 does not generate an error interrupt 1b - An error on channel 9 generates an error interrupt request
8 EEI8	Enable Error Interrupt 8 0b - An error on channel 8 does not generate an error interrupt 1b - An error on channel 8 generates an error interrupt request
7 EEI7	Enable Error Interrupt 7 0b - An error on channel 7 does not generate an error interrupt 1b - An error on channel 7 generates an error interrupt request
6 EEI6	Enable Error Interrupt 6 0b - An error on channel 6 does not generate an error interrupt 1b - An error on channel 6 generates an error interrupt request

Table continues on the next page...

Field	Function
5 EEI5	Enable Error Interrupt 5 0b - An error on channel 5 does not generate an error interrupt 1b - An error on channel 5 generates an error interrupt request
4 EEI4	Enable Error Interrupt 4 0b - An error on channel 4 does not generate an error interrupt 1b - An error on channel 4 generates an error interrupt request
3 EEI3	Enable Error Interrupt 3 0b - An error on channel 3 does not generate an error interrupt 1b - An error on channel 3 generates an error interrupt request
2 EEI2	Enable Error Interrupt 2 0b - An error on channel 2 does not generate an error interrupt 1b - An error on channel 2 generates an error interrupt request
1 EEI1	Enable Error Interrupt 1 0b - An error on channel 1 does not generate an error interrupt 1b - An error on channel 1 generates an error interrupt request
0 EEI0	Enable Error Interrupt 0 0b - An error on channel 0 does not generate an error interrupt 1b - An error on channel 0 generates an error interrupt request

18.3.5.6 Clear Enable Error Interrupt (CEEI)

18.3.5.6.1 Offset

Register	Offset
CEEI	18h

18.3.5.6.2 Function

The CEEI provides a simple memory-mapped mechanism to write 0 to a given field in the EEI register to disable the error interrupt for a given channel. The data value on a register write causes the corresponding field in the EEI register to be written to 0. Writing 1 to the CAEE field provides a global clear to 0 function, forcing the EEI contents to be written to 0, disabling all DMA request inputs.

If the NOP field is written with 1, the command is ignored. This enables you to write 1 to a single, byte-wide register with a 32-bit write that does not affect the other registers addressed in the write. In such a case the other three bytes of the word must all have their NOP field set to 1 so that these registers are not affected by the write.

Reads of this register return all zeroes.

18.3.5.6.3 Diagram

Bits	7	6	5	4	3	2	1	0
R	0	0			0			
W	NOP	CAEE	0		CEE			
Reset	0	0	0	0	0	0	0	0

18.3.5.6.4 Fields

Field	Function
7 NOP	No Op Enable 0b - Normal operation 1b - No operation, ignore the other fields in this register
6 CAEE	Clear All Enable Error Interrupts 0b - Write 0 only to the EEI field specified in the CEEI field 1b - Write 0 to all fields in EEI
5-4 —	Reserved
3-0 CEEI	Clear Enable Error Interrupt Writes 0 to the corresponding field in EEI

18.3.5.7 Set Enable Error Interrupt (SEEI)

18.3.5.7.1 Offset

Register	Offset
SEEI	19h

18.3.5.7.2 Function

The SEEI register provides a simple memory-mapped mechanism to write 1 to a given field in the EEI register to enable the error interrupt for a given channel. The data value on a register write causes the corresponding field in the EEI to be written to 1. Writing 1 to the SAEE field provides a global set to 1 function, forcing the entire EEI register contents to be written with 1.

If the NOP field is 1, the command is ignored. This enables you to write 1 to a single, byte-wide register with a 32-bit write that does not affect the other registers addressed in the write. In such a case the other three bytes of the word must all have their NOP field set to 1 so that these registers are not affected by the write.

Reads of this register return all zeroes.

18.3.5.7.3 Diagram

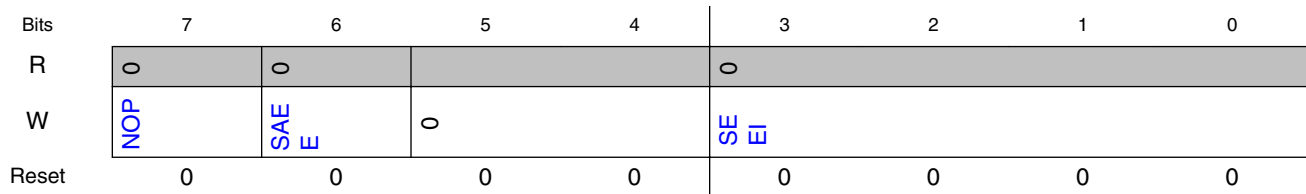

18.3.5.7.4 Fields

Field	Function
7 NOP	No Op Enable 0b - Normal operation 1b - No operation, ignore the other fields in this register
6 SAEE	Set All Enable Error Interrupts 0b - Write 1 only to the EEI field specified in the SEEI field 1b - Writes 1 to all fields in EEI
5-4 —	Reserved
3-0 SEEI	Set Enable Error Interrupt Writes 1 to the corresponding field in EEI

18.3.5.8 Clear Enable Request (CERQ)

18.3.5.8.1 Offset

Register	Offset
CERQ	1Ah

18.3.5.8.2 Function

The CERQ provides a simple memory-mapped mechanism to write 0 to a given field in the ERQ register to disable the DMA request for a given channel. The data value on a register write causes the corresponding field in the ERQ register to be written with 0. Setting the CAER field provides a global clear to 0 function, forcing the entire contents of the ERQ register to be written with 0, disabling all DMA request inputs.

If the NOP field is 1, the command is ignored. This enables you to write 1 to a single, byte-wide register with a 32-bit write that does not affect the other registers addressed in the write. In such a case the other three bytes of the word must all have their NOP field written with 1 so that these registers are not affected by the write.

Reads of this register return all zeroes.

NOTE

Disable a channel's hardware service request at the source before writing 0 to the channel's ERQ field.

18.3.5.8.3 Diagram

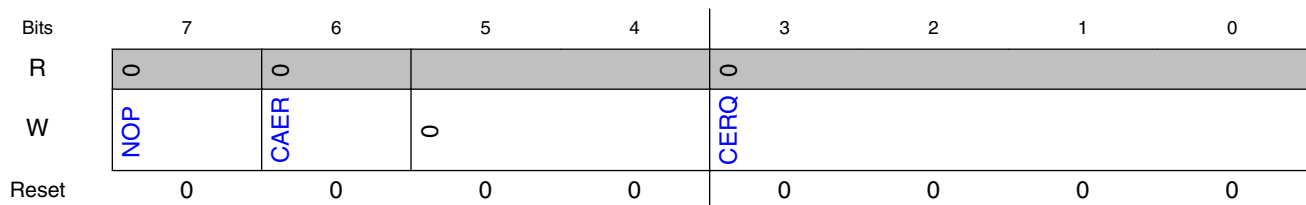

18.3.5.8.4 Fields

Field	Function
7 NOP	No Op Enable 0b - Normal operation 1b - No operation, ignore the other fields in this register
6 CAER	Clear All Enable Requests 0b - Write 0 to only the ERQ field specified in the CERQ field 1b - Write 0 to all fields in ERQ
5-4 —	Reserved
3-0 CERQ	Clear Enable Request Writes 0 to the corresponding field in ERQ.

18.3.5.9 Set Enable Request (SERQ)

18.3.5.9.1 Offset

Register	Offset
SERQ	1Bh

18.3.5.9.2 Function

The SERQ provides a simple memory-mapped mechanism to write 1 to a given field in the ERQ register to enable the DMA request for a given channel. The data value on a register write causes the corresponding field in the ERQ register to be set. Writing 1 to the SAER field provides a global set to 1 function, forcing the entire contents of ERQ register to be 1.

If the NOP field is 1, the command is ignored. This enables you to write 1 to a single, byte-wide register with a 32-bit write that does not affect the other registers addressed in the write. In such a case the other three bytes of the word must all have their NOP field written with 1 so that these registers are not affected by the write.

Reads of this register returns all zeroes.

18.3.5.9.3 Diagram

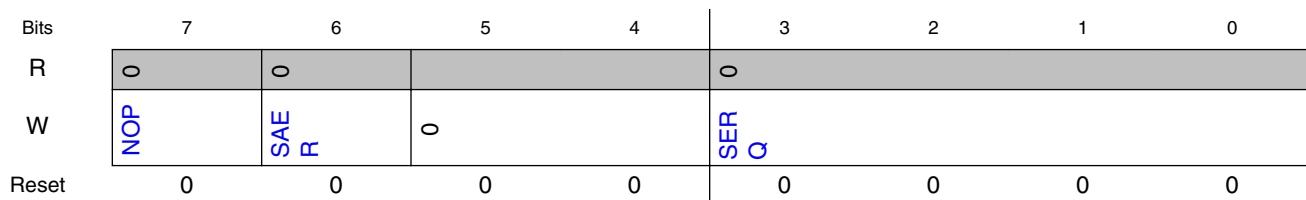

18.3.5.9.4 Fields

Field	Function
7 NOP	No Op Enable 0b - Normal operation 1b - No operation, ignore the other fields in this register
6 SAER	Set All Enable Requests 0b - Write 1 to only the ERQ field specified in the SERQ field 1b - Write 1 to all fields in ERQ
5-4	Reserved

Table continues on the next page...

Memory map/register definition

Field	Function
—	
3-0 SERQ	Set Enable Request Writes 1 to the corresponding field in ERQ.

18.3.5.10 Clear DONE Status Bit (CDNE)

18.3.5.10.1 Offset

Register	Offset
CDNE	1Ch

18.3.5.10.2 Function

The CDNE provides a simple memory-mapped mechanism to write 0 to the DONE field in the TCD of the given channel. The data value on a register write causes the DONE field in the corresponding TCD to be written with 0. Writing 1 to the CADN field provides a global clear function, forcing all DONE fields to be written with 0.

If the NOP field is 1, the command is ignored. This enables you to write 1 to a single, byte-wide register with a 32-bit write that does not affect the other registers addressed in the write. In such a case the other three bytes of the word must all have their NOP field written with 1 so that these registers are not affected by the write.

Reads of this register return all zeroes.

18.3.5.10.3 Diagram

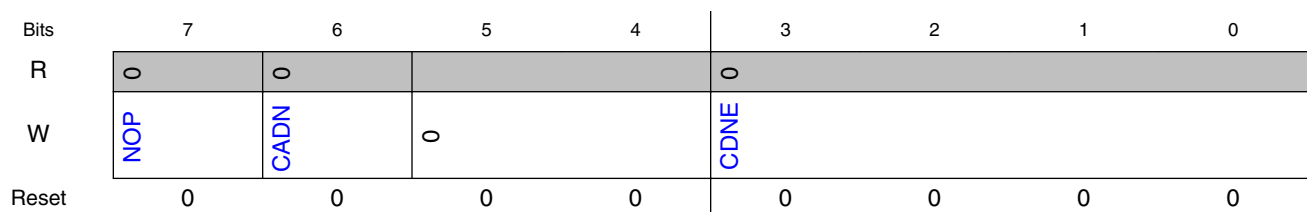

18.3.5.10.4 Fields

Field	Function
7 NOP	No Op Enable 0b - Normal operation 1b - No operation; all other fields in this register are ignored.
6 CADN	Clears All DONE fields 0b - Writes 0 to only the TCDn_CSR[DONE] field specified in the CDNE field 1b - Writes 0 to all bits in TCDn_CSR[DONE]
5-4 —	Reserved
3-0 CDNE	Clear DONE field Writes 0 to the corresponding field in TCDn_CSR[DONE]

18.3.5.11 Set START Bit (SSRT)

18.3.5.11.1 Offset

Register	Offset
SSRT	1Dh

18.3.5.11.2 Function

The SSRT register provides a simple memory-mapped mechanism to write 1 to the START field in the TCD of the given channel. The data value on a register write causes the START field in the corresponding TCD to be written with 1. Writing 1 to the SAST field provides a global set to 1 function, forcing all START fields to be written with 1.

If the NOP field is 1, the command is ignored. This enables you to write 1 to a single, byte-wide register with a 32-bit write that does not affect the other registers addressed in the write. In such a case the other three bytes of the word must all have their NOP field written with 1 so that these registers are not affected by the write.

Reads of this register return all zeroes.

18.3.5.11.3 Diagram

Bits	7	6	5	4	3	2	1	0
R	0	0			0			
W	NOP	SAS T	0		SSR T			
Reset	0	0	0	0	0	0	0	0

18.3.5.11.4 Fields

Field	Function
7 NOP	No Op Enable 0b - Normal operation 1b - No operation; all other fields in this register are ignored.
6 SAST	Set All START fields (activates all channels) 0b - Write 1 to only the TCDn_CSR[START] field specified in the SSRT field 1b - Write 1 to all bits in TCDn_CSR[START]
5-4 —	Reserved
3-0 SSRT	Set START field Sets the corresponding field in TCDn_CSR[START]

18.3.5.12 Clear Error (CERR)

18.3.5.12.1 Offset

Register	Offset
CERR	1Eh

18.3.5.12.2 Function

The CERR provides a simple memory-mapped mechanism to write 0 to a given field in the ERR register to disable the error condition field for a given channel. The given value on a register write causes the corresponding field in the ERR register to be written with 0. Writing 1 to the CAEI field provides a global clear to 0 function, forcing the ERR register contents to be written with 0, clearing all channel error indicators. If the NOP field is 1, the command is ignored. This enables you to write multiple-byte registers as a 32-bit word. Reads of this register return all zeroes.

18.3.5.12.3 Diagram

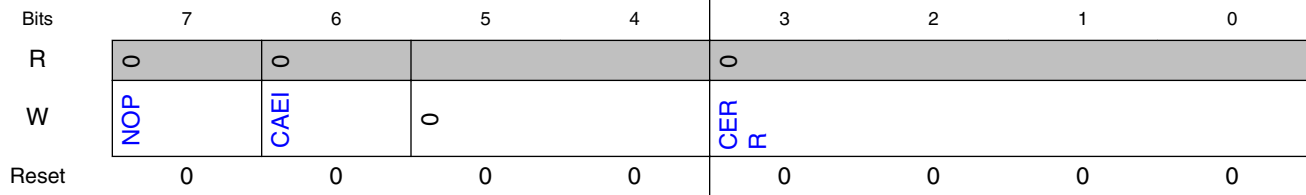

18.3.5.12.4 Fields

Field	Function
7 NOP	No Op Enable 0b - Normal operation 1b - No operation; all other fields in this register are ignored.
6 CAEI	Clear All Error Indicators 0b - Write 0 to only the ERR field specified in the CERR field 1b - Write 0 to all fields in ERR
5-4 —	Reserved
3-0 CERR	Clear Error Indicator Writes 0 to the corresponding field in ERR

18.3.5.13 Clear Interrupt Request (CINT)

18.3.5.13.1 Offset

Register	Offset
CINT	1Fh

18.3.5.13.2 Function

The CINT register provides a simple, memory-mapped mechanism to clear a given field in the INT register to disable the interrupt request for a given channel. The given value on a register write causes the corresponding field in the INT register to be cleared. Setting the CAIR field provides a global clear function, forcing the entire contents of the INT to be cleared, disabling all DMA interrupt requests.

Memory map/register definition

If the NOP field is 1, the command is ignored. This enables you to set a single, byte-wide register with a 32-bit write that does not affect the other registers addressed in the write. In such a case the other three bytes of the word would all have their NOP field set to 1 so that these registers are not affected by the write.

Reads of this register return all zeroes.

18.3.5.13.3 Diagram

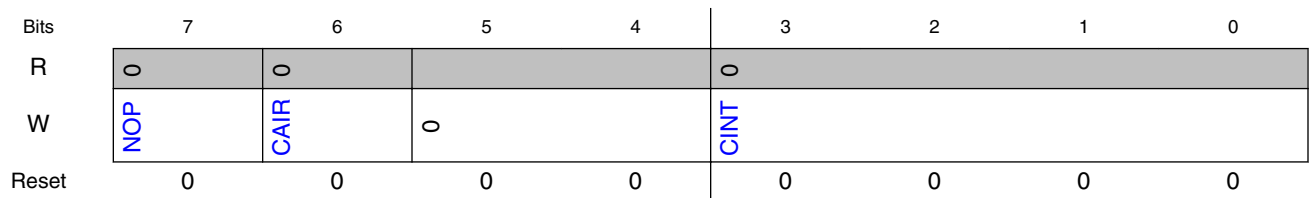

18.3.5.13.4 Fields

Field	Function
7 NOP	No Op Enable 0b - Normal operation 1b - No operation; all other fields in this register are ignored.
6 CAIR	Clear All Interrupt Requests 0b - Clear only the INT field specified in the CINT field 1b - Clear all bits in INT
5-4 —	Reserved
3-0 CINT	Clear Interrupt Request Clears the corresponding field in INT

18.3.5.14 Interrupt Request (INT)

18.3.5.14.1 Offset

Register	Offset
INT	24h

18.3.5.14.2 Function

The INT register provides a bit map for the 16 channels signaling the presence of an interrupt request for each channel. Depending on the appropriate bit setting in the transfer-control descriptors, the eDMA engine generates an interrupt on data transfer completion. The outputs of this register are directly routed to the interrupt controller. During the interrupt-service routine associated with any given channel, it is the software's responsibility to write 0 to the appropriate bit, negating the interrupt request. Typically, a write to the CINT register in the interrupt service routine is used for this purpose.

The state of any given channel's interrupt request is directly affected by writes to this register; it is also affected by writes to the CINT register. On writes to INT, a 1 in any bit position clears the corresponding channel's interrupt request. A 0 in any bit position has no effect on the corresponding channel's current interrupt status. The CINT register is provided so the interrupt request for a single channel can easily be cleared without the need to perform a read-modify-write sequence to the INT register.

18.3.5.14.3 Diagram

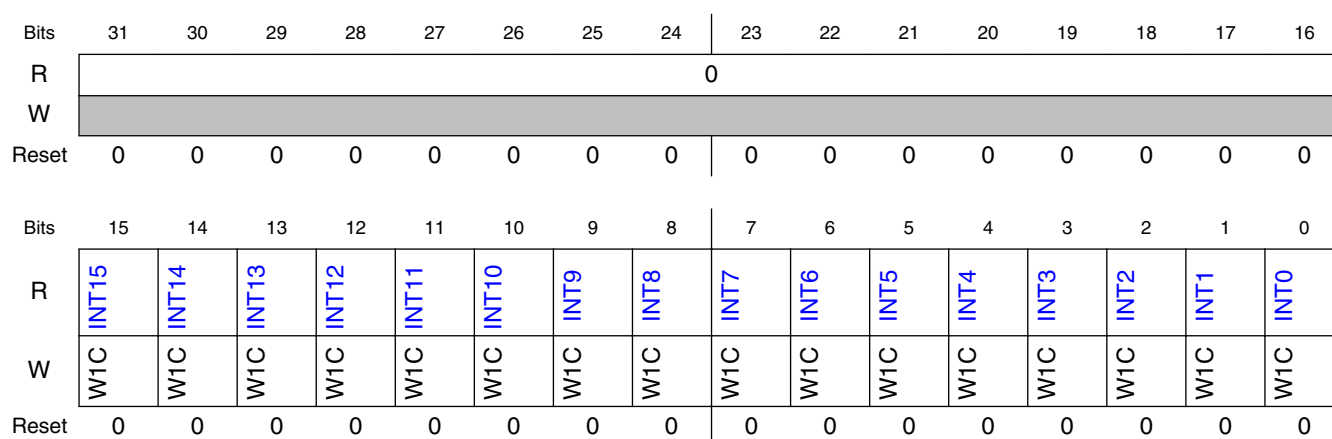

18.3.5.14.4 Fields

Field	Function
31-16 —	Reserved
15 INT15	Interrupt Request 15 0b - The interrupt request for channel 15 is cleared 1b - The interrupt request for channel 15 is active
14 INT14	Interrupt Request 14 0b - The interrupt request for channel 14 is cleared 1b - The interrupt request for channel 14 is active

Table continues on the next page...

Memory map/register definition

Field	Function
13 INT13	Interrupt Request 13 0b - The interrupt request for channel 13 is cleared 1b - The interrupt request for channel 13 is active
12 INT12	Interrupt Request 12 0b - The interrupt request for channel 12 is cleared 1b - The interrupt request for channel 12 is active
11 INT11	Interrupt Request 11 0b - The interrupt request for channel 11 is cleared 1b - The interrupt request for channel 11 is active
10 INT10	Interrupt Request 10 0b - The interrupt request for channel 10 is cleared 1b - The interrupt request for channel 10 is active
9 INT9	Interrupt Request 9 0b - The interrupt request for channel 9 is cleared 1b - The interrupt request for channel 9 is active
8 INT8	Interrupt Request 8 0b - The interrupt request for channel 8 is cleared 1b - The interrupt request for channel 8 is active
7 INT7	Interrupt Request 7 0b - The interrupt request for channel 7 is cleared 1b - The interrupt request for channel 7 is active
6 INT6	Interrupt Request 6 0b - The interrupt request for channel 6 is cleared 1b - The interrupt request for channel 6 is active
5 INT5	Interrupt Request 5 0b - The interrupt request for channel 5 is cleared 1b - The interrupt request for channel 5 is active
4 INT4	Interrupt Request 4 0b - The interrupt request for channel 4 is cleared 1b - The interrupt request for channel 4 is active
3 INT3	Interrupt Request 3 0b - The interrupt request for channel 3 is cleared 1b - The interrupt request for channel 3 is active
2 INT2	Interrupt Request 2 0b - The interrupt request for channel 2 is cleared 1b - The interrupt request for channel 2 is active
1 INT1	Interrupt Request 1 0b - The interrupt request for channel 1 is cleared 1b - The interrupt request for channel 1 is active
0 INT0	Interrupt Request 0 0b - The interrupt request for channel 0 is cleared 1b - The interrupt request for channel 0 is active

18.3.5.15 Error (ERR)

18.3.5.15.1 Offset

Register	Offset
ERR	2Ch

18.3.5.15.2 Function

The ERR register provides a bit map for the 16 channels, signaling the presence of an error for each channel. The eDMA engine signals the occurrence of an error condition by setting the appropriate field in this register. The outputs of this register are enabled by the contents of the EEI register, and then routed to the interrupt controller. During the execution of the interrupt service routine associated with any DMA errors, it is software's responsibility to reset the appropriate bit to 0, negating the error-interrupt request. Typically, a write to the CERR in the interrupt service routine is used for this purpose. The normal DMA channel completion indicators (setting the TCD DONE field to 1 and the possible generation of an interrupt request) are not affected when an error is detected.

The contents of this register can also be polled because a non-zero value indicates the presence of a channel error regardless of the state of the EEI fields. The state of any given channel's error indicators is affected by writes to this register; it is also affected by writes to the CERR. On writes to the ERR, a 1 in any bit position clears the corresponding channel's error status. A 0 in any bit position has no effect on the corresponding channel's current error status. The CERR is provided so the error indicator for a single channel can easily be reset to 0.

18.3.5.15.3 Diagram

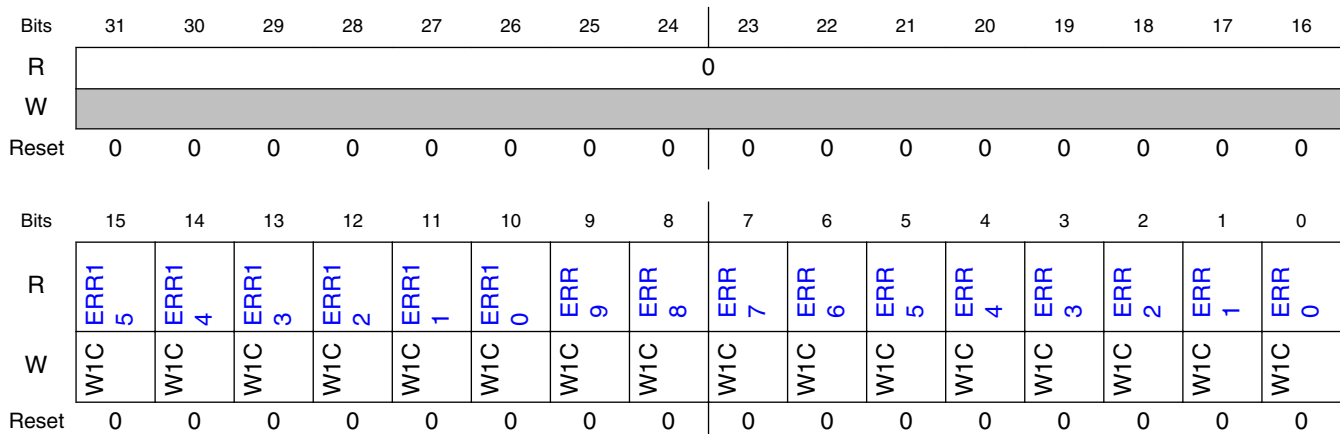

18.3.5.15.4 Fields

Field	Function
31-16 —	Reserved
15 ERR15	Error In Channel 15 0b - No error in this channel has occurred 1b - An error in this channel has occurred
14 ERR14	Error In Channel 14 0b - No error in this channel has occurred 1b - An error in this channel has occurred
13 ERR13	Error In Channel 13 0b - No error in this channel has occurred 1b - An error in this channel has occurred
12 ERR12	Error In Channel 12 0b - No error in this channel has occurred 1b - An error in this channel has occurred
11 ERR11	Error In Channel 11 0b - No error in this channel has occurred 1b - An error in this channel has occurred
10 ERR10	Error In Channel 10 0b - No error in this channel has occurred 1b - An error in this channel has occurred
9 ERR9	Error In Channel 9 0b - No error in this channel has occurred 1b - An error in this channel has occurred
8 ERR8	Error In Channel 8 0b - No error in this channel has occurred 1b - An error in this channel has occurred
7 ERR7	Error In Channel 7 0b - No error in this channel has occurred 1b - An error in this channel has occurred
6 ERR6	Error In Channel 6 0b - No error in this channel has occurred 1b - An error in this channel has occurred
5 ERR5	Error In Channel 5 0b - No error in this channel has occurred 1b - An error in this channel has occurred
4 ERR4	Error In Channel 4 0b - No error in this channel has occurred 1b - An error in this channel has occurred
3 ERR3	Error In Channel 3 0b - No error in this channel has occurred 1b - An error in this channel has occurred
2 ERR2	Error In Channel 2 0b - No error in this channel has occurred 1b - An error in this channel has occurred
1 ERR1	Error In Channel 1 0b - No error in this channel has occurred 1b - An error in this channel has occurred
0	Error In Channel 0

Field	Function
ERR0	0b - No error in this channel has occurred 1b - An error in this channel has occurred

18.3.5.16 Hardware Request Status (HRS)

18.3.5.16.1 Offset

Register	Offset
HRS	34h

18.3.5.16.2 Function

The HRS register provides a bit map for the DMA channels, signaling the presence of a hardware request for each channel. The hardware request status bits reflect the current state of the register and qualified (via the ERQ fields) DMA request signals, as seen by the DMA's arbitration logic. This view into the hardware request signals may be used for debug purposes.

NOTE

These bits reflect the state of the request as seen by the arbitration logic. Therefore, this status is affected by the ERQ bits.

Each HRS field for its respective channel is 1 when a hardware request is present on the channel. After the request is completed and channel is free, the HRS field is automatically changed to 0 by hardware.

18.3.5.16.3 Diagram

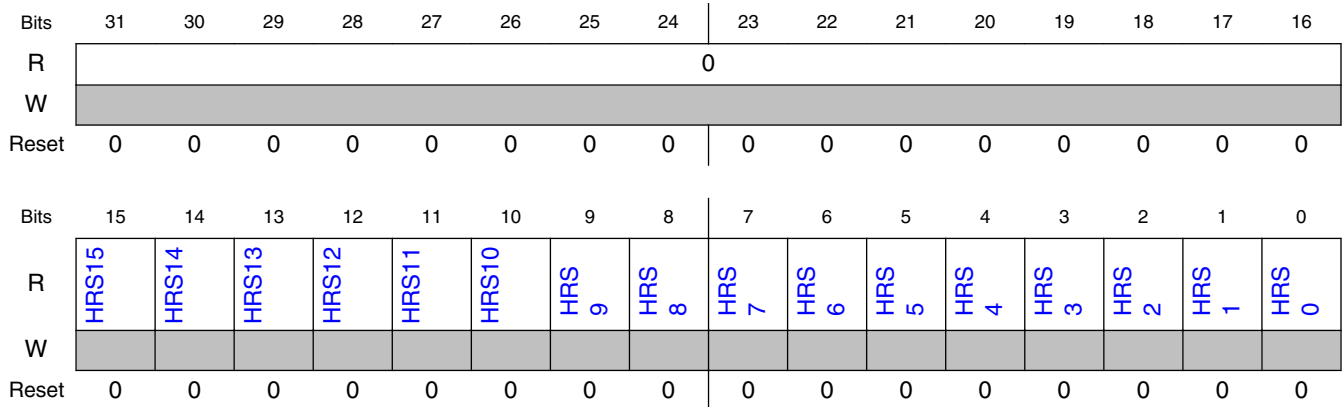

18.3.5.16.4 Fields

Field	Function
31-16 —	Reserved
15 HRS15	Hardware Request Status Channel 15 0b - A hardware service request for channel 15 is not present 1b - A hardware service request for channel 15 is present
14 HRS14	Hardware Request Status Channel 14 0b - A hardware service request for channel 14 is not present 1b - A hardware service request for channel 14 is present
13 HRS13	Hardware Request Status Channel 13 0b - A hardware service request for channel 13 is not present 1b - A hardware service request for channel 13 is present
12 HRS12	Hardware Request Status Channel 12 0b - A hardware service request for channel 12 is not present 1b - A hardware service request for channel 12 is present
11 HRS11	Hardware Request Status Channel 11 0b - A hardware service request for channel 11 is not present 1b - A hardware service request for channel 11 is present
10 HRS10	Hardware Request Status Channel 10 0b - A hardware service request for channel 10 is not present 1b - A hardware service request for channel 10 is present
9 HRS9	Hardware Request Status Channel 9 0b - A hardware service request for channel 9 is not present 1b - A hardware service request for channel 9 is present
8 HRS8	Hardware Request Status Channel 8 0b - A hardware service request for channel 8 is not present 1b - A hardware service request for channel 8 is present
7 HRS7	Hardware Request Status Channel 7 0b - A hardware service request for channel 7 is not present 1b - A hardware service request for channel 7 is present
6	Hardware Request Status Channel 6

Table continues on the next page...

Field	Function
HRS6	0b - A hardware service request for channel 6 is not present 1b - A hardware service request for channel 6 is present
5 HRS5	Hardware Request Status Channel 5 0b - A hardware service request for channel 5 is not present 1b - A hardware service request for channel 5 is present
4 HRS4	Hardware Request Status Channel 4 0b - A hardware service request for channel 4 is not present 1b - A hardware service request for channel 4 is present
3 HRS3	Hardware Request Status Channel 3 0b - A hardware service request for channel 3 is not present 1b - A hardware service request for channel 3 is present
2 HRS2	Hardware Request Status Channel 2 0b - A hardware service request for channel 2 is not present 1b - A hardware service request for channel 2 is present
1 HRS1	Hardware Request Status Channel 1 0b - A hardware service request for channel 1 is not present 1b - A hardware service request for channel 1 is present
0 HRS0	Hardware Request Status Channel 0 0b - A hardware service request for channel 0 is not present 1b - A hardware service request for channel 0 is present

18.3.5.17 Enable Asynchronous Request in Stop (EARS)

18.3.5.17.1 Offset

Register	Offset
EARS	44h

18.3.5.17.2 Function

The EARS register is used to enable or disable the DMA requests in [Enable Request \(ERQ\)](#) by AND'ing the bits of these two registers.

18.3.5.17.3 Diagram

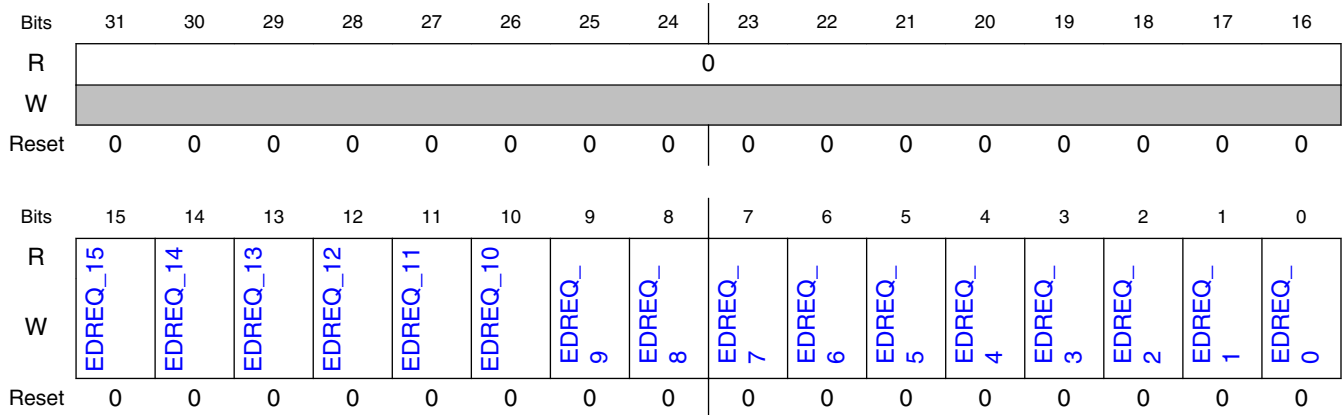

18.3.5.17.4 Fields

Field	Function
31-16 —	Reserved
15 EDREQ_15	Enable asynchronous DMA request in stop mode for channel 15. 0b - Disable asynchronous DMA request for channel 15 1b - Enable asynchronous DMA request for channel 15
14 EDREQ_14	Enable asynchronous DMA request in stop mode for channel 14. 0b - Disable asynchronous DMA request for channel 14 1b - Enable asynchronous DMA request for channel 14
13 EDREQ_13	Enable asynchronous DMA request in stop mode for channel 13. 0b - Disable asynchronous DMA request for channel 13 1b - Enable asynchronous DMA request for channel 13
12 EDREQ_12	Enable asynchronous DMA request in stop mode for channel 12. 0b - Disable asynchronous DMA request for channel 12 1b - Enable asynchronous DMA request for channel 12
11 EDREQ_11	Enable asynchronous DMA request in stop mode for channel 11. 0b - Disable asynchronous DMA request for channel 11 1b - Enable asynchronous DMA request for channel 11
10 EDREQ_10	Enable asynchronous DMA request in stop mode for channel 10. 0b - Disable asynchronous DMA request for channel 10 1b - Enable asynchronous DMA request for channel 10
9 EDREQ_9	Enable asynchronous DMA request in stop mode for channel 9. 0b - Disable asynchronous DMA request for channel 9 1b - Enable asynchronous DMA request for channel 9
8 EDREQ_8	Enable asynchronous DMA request in stop mode for channel 8. 0b - Disable asynchronous DMA request for channel 8 1b - Enable asynchronous DMA request for channel 8
7 EDREQ_7	Enable asynchronous DMA request in stop mode for channel 7. 0b - Disable asynchronous DMA request for channel 7 1b - Enable asynchronous DMA request for channel 7
6	Enable asynchronous DMA request in stop mode for channel 6.

Table continues on the next page...

Field	Function
EDREQ_6	0b - Disable asynchronous DMA request for channel 6 1b - Enable asynchronous DMA request for channel 6
5 EDREQ_5	Enable asynchronous DMA request in stop mode for channel 5. 0b - Disable asynchronous DMA request for channel 5 1b - Enable asynchronous DMA request for channel 5
4 EDREQ_4	Enable asynchronous DMA request in stop mode for channel 4. 0b - Disable asynchronous DMA request for channel 4 1b - Enable asynchronous DMA request for channel 4
3 EDREQ_3	Enable asynchronous DMA request in stop mode for channel 3. 0b - Disable asynchronous DMA request for channel 3 1b - Enable asynchronous DMA request for channel 3
2 EDREQ_2	Enable asynchronous DMA request in stop mode for channel 2. 0b - Disable asynchronous DMA request for channel 2 1b - Enable asynchronous DMA request for channel 2
1 EDREQ_1	Enable asynchronous DMA request in stop mode for channel 1. 0b - Disable asynchronous DMA request for channel 1 1b - Enable asynchronous DMA request for channel 1
0 EDREQ_0	Enable asynchronous DMA request in stop mode for channel 0. 0b - Disable asynchronous DMA request for channel 0 1b - Enable asynchronous DMA request for channel 0

18.3.5.18 Channel Priority (DCHPRI0 - DCHPRI15)

18.3.5.18.1 Offset

For $n = 0$ to 15:

Register	Offset
DCHPRI n	$100h + (n + 3 - 2 \times (n \bmod 4))$

18.3.5.18.2 Function

When fixed-priority channel arbitration is enabled ($CR[ERCA] = 0$), the contents of these registers define the unique priorities associated with each channel. The channel priorities are evaluated by numeric value; for example, 0 is the lowest priority, 1 is the next higher priority, then 2, 3, and so on. Software must program the channel priorities with unique values; otherwise, a configuration error is reported. The range of the priority value is limited to the values of 0 through 15.

18.3.5.18.3 Diagram

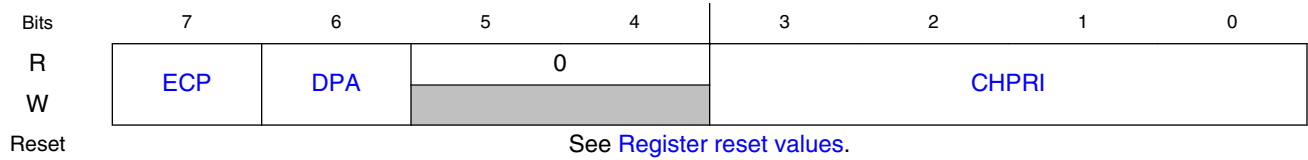

18.3.5.18.4 Register reset values

Register	Reset value
DCHPRI0	00h
DCHPRI1	01h
DCHPRI2	02h
DCHPRI3	03h
DCHPRI4	04h
DCHPRI5	05h
DCHPRI6	06h
DCHPRI7	07h
DCHPRI8	08h
DCHPRI9	09h
DCHPRI10	0Ah
DCHPRI11	0Bh
DCHPRI12	0Ch
DCHPRI13	0Dh
DCHPRI14	0Eh
DCHPRI15	0Fh

18.3.5.18.5 Fields

Field	Function
7 ECP	Enable Channel Preemption. This field resets to 0. 0b - Channel n cannot be suspended by a higher priority channel's service request 1b - Channel n can be temporarily suspended by the service request of a higher priority channel
6 DPA	Disable Preempt Ability. This field resets to 0. 0b - Channel n can suspend a lower priority channel 1b - Channel n cannot suspend any channel, regardless of channel priority
5-4 —	Reserved
3-0 CHPRI	Channel n Arbitration Priority Channel priority when fixed-priority arbitration is enabled.

18.3.5.19 TCD Source Address (TCD0_SADDR - TCD15_SADDR)

18.3.5.19.1 Offset

For $n = 0$ to 15:

Register	Offset
TCDn_SADDR	1000h + (n × 20h)

18.3.5.19.2 Function

This register contains the source address of the transfer.

18.3.5.19.3 Diagram

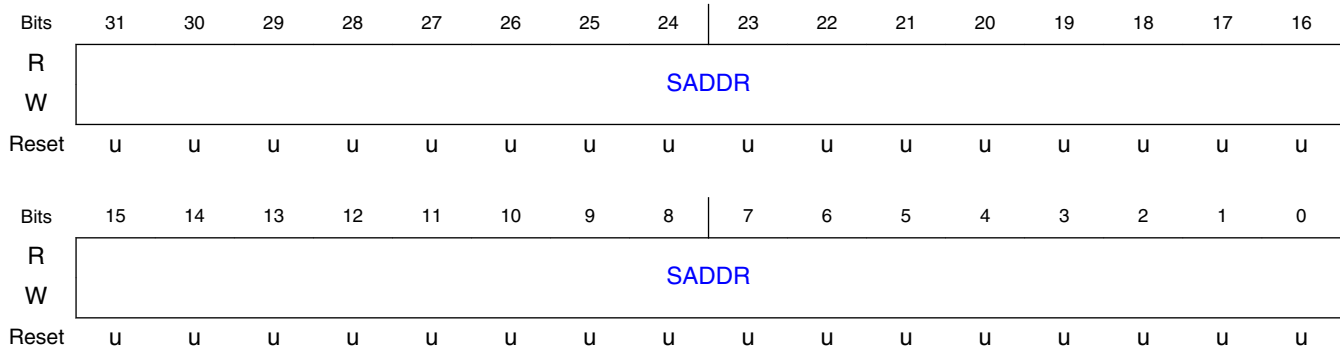

18.3.5.19.4 Fields

Field	Function
31-0	Source Address
SADDR	Memory address pointing to the source data.

18.3.5.20 TCD Signed Source Address Offset (TCD0_SOFF - TCD15_SOFF)

18.3.5.20.1 Offset

For n = 0 to 15:

Register	Offset
TCDn_SOFF	1004h + (n × 20h)

18.3.5.20.2 Diagram

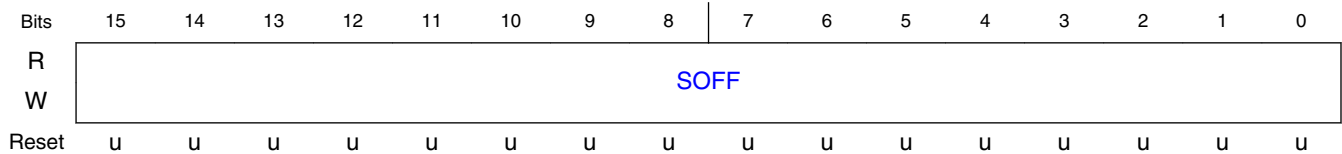

18.3.5.20.3 Fields

Field	Function
15-0	Source address signed offset
SOFF	Sign-extended offset applied to the current source address to form the next-state value as each source read is completed.

18.3.5.21 TCD Transfer Attributes (TCD0_ATTR - TCD15_ATTR)

18.3.5.21.1 Offset

For n = 0 to 15:

Register	Offset
TCDn_ATTR	1006h + (n × 20h)

18.3.5.21.2 Diagram



18.3.5.21.3 Fields

Field	Function
15-11 SMOD	<p>Source Address Modulo</p> <p>Any non-zero value in this field defines a specific address range specified to be the value after SADDR + SOFF calculation is performed on the original register value. Setting this field provides the ability to implement a circular data queue easily. For data queues requiring power-of-2 size bytes, the queue should start at a 0-modulo-size address and the SMOD field should be set to the appropriate value for the queue, freezing the desired number of upper address bits. The value programmed into this field specifies the number of lower address bits allowed to change. For a circular queue application, the SOFF is typically set to the transfer size to implement post-increment addressing with the SMOD function constraining the addresses to a 0-modulo-size range.</p> <p>00000b - Source address modulo feature is disabled 00001-11111b - Value defines address range used to set up circular data queue</p>
10-8 SSIZE	<p>Source data transfer size</p> <p>NOTE:</p> <ol style="list-style-type: none"> Using a reserved value causes a configuration error. The eDMA defaults to privileged data access for all transactions. <p>000b - 8-bit 001b - 16-bit 010b - 32-bit 011b - Reserved 100b - 16-byte burst 101b - 32-byte burst 110b - Reserved 111b - Reserved</p>
7-3 DMOD	<p>Destination Address Modulo</p> <p>See the SMOD definition.</p>
2-0 DSIZE	<p>Destination data transfer size</p> <p>See the SSIZE definition.</p>

18.3.5.22 TCD Minor Byte Count (Minor Loop Mapping Disabled) (TCD0_NBYTES_MLNO - TCD15_NBYTES_MLNO)

18.3.5.22.1 Offset

For n = 0 to 15:

Register	Offset
TCDn_NBYTES_MLNO	1008h + (n × 20h)

18.3.5.22.2 Function

This register, or one of the next two registers (TCD_NBYTES_MLOFFNO, TCD_NBYTES_MLOFFYES), that defines the number of bytes to transfer per request. Which register to use depends on whether minor loop mapping is disabled, is enabled but not used for this channel, or is enabled and used.

TCD word 2 is defined as follows if minor loop mapping is disabled ($CR[EMLM] = 0$).

If minor loop mapping is enabled, see the TCD_NBYTES_MLOFFNO and TCD_NBYTES_MLOFFYES register descriptions for the definition of TCD word 2.

18.3.5.22.3 Diagram

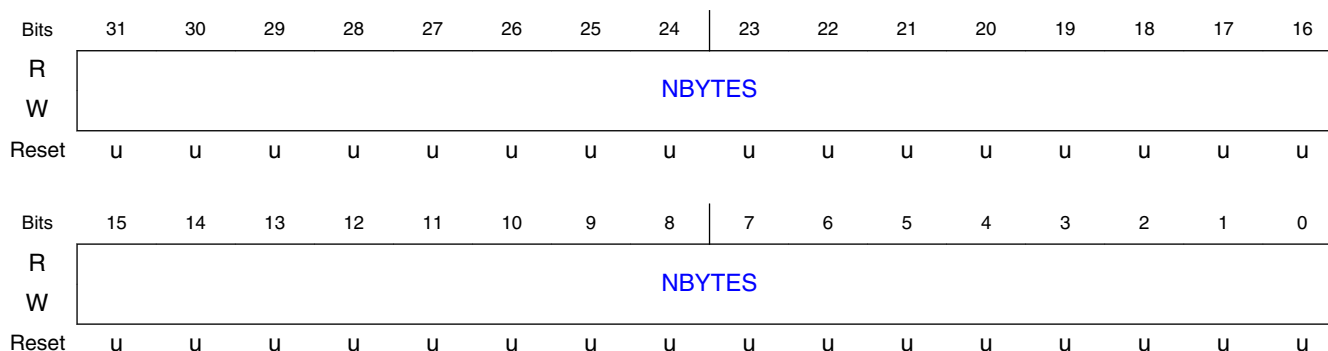

18.3.5.22.4 Fields

Field	Function
31-0	Minor Byte Transfer Count
NBYTES	<p>Number of bytes to be transferred in each service request of the channel. As a channel activates, the appropriate TCD contents load into the eDMA engine, and the appropriate reads and writes are performed until the minor byte transfer count has transferred. This is an indivisible operation and cannot be halted. It can, however, be stalled by using the bandwidth control field, or via preemption.</p> <p>After the minor count is exhausted, the SADDR and DADDR values are written back into the TCD memory, and the major iteration count is decremented and restored to the TCD memory. If the major iteration count is completed, additional processing is performed.</p> <p>NOTE: An NBYTES value of 0x0000_0000 is interpreted as a 4 GB transfer.</p>

18.3.5.23 TCD Signed Minor Loop Offset (Minor Loop Mapping Enabled and Offset Disabled) (TCD0_NBYTES_MLOFFNO - TCD15_NBYTES_MLOFFNO)

18.3.5.23.1 Offset

For $n = 0$ to 15:

Register	Offset
TCDn_NBYTES_MLOFFNO	1008h + (n × 20h)

18.3.5.23.2 Function

One of three registers (this register, TCD_NBYTES_MLNO, or TCD_NBYTES_MLOFFYES), that defines the number of bytes to transfer per request. Which register to use depends on whether minor loop mapping is disabled, is enabled but not used for this channel, or is enabled and used.

TCD word 2 is defined as follows if:

- Minor loop mapping is enabled ($CR[EMLM] = 1$) and
- $SMLOE = 0$ and $DMLOE = 0$

If minor loop mapping is enabled and $SMLOE = 1$ or $DMLOE = 1$, refer to the TCD_NBYTES_MLOFFYES register description. If minor loop mapping is disabled, refer to the TCD_NBYTES_MLNO register description.

18.3.5.23.3 Diagram

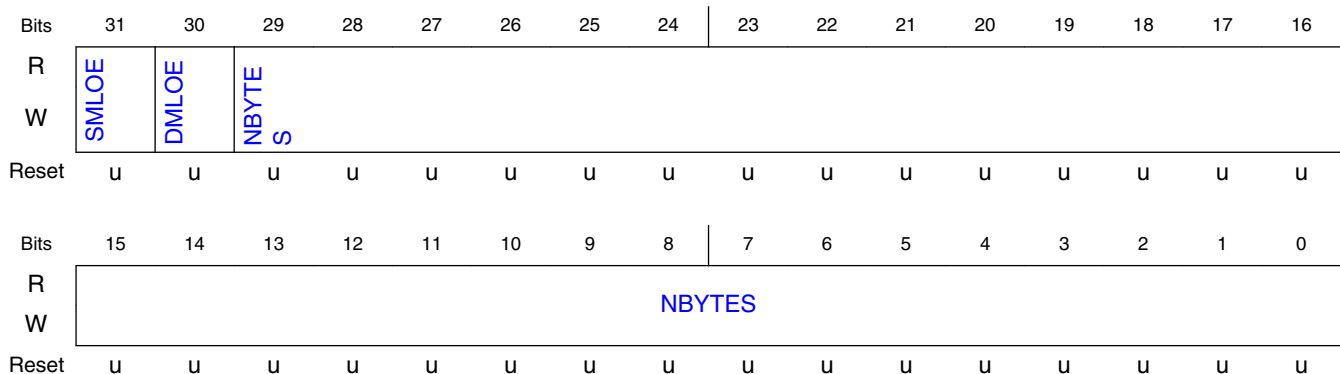

18.3.5.23.4 Fields

Field	Function
31	Source Minor Loop Offset Enable
SMLOE	Specifies whether the minor loop offset is applied to the source address when the minor loop completes.

Table continues on the next page...

Memory map/register definition

Field	Function
	0b - The minor loop offset is not applied to the SADDR 1b - The minor loop offset is applied to the SADDR
30 DMLOE	Destination Minor Loop Offset Enable Specifies whether the minor loop offset is applied to the destination address when the minor loop completes. 0b - The minor loop offset is not applied to the DADDR 1b - The minor loop offset is applied to the DADDR
29-0 NBYTES	Minor Byte Transfer Count Number of bytes to be transferred in each service request of the channel. As a channel activates, the appropriate TCD contents load into the eDMA engine, and the appropriate reads and writes are performed until the minor byte transfer count has transferred. This is an indivisible operation and cannot be halted. It can, however, be stalled by using the bandwidth control field, or via preemption. After the minor count is exhausted, the SADDR and DADDR values are written back into the TCD memory, and the major iteration count is decremented and restored to the TCD memory. If the major iteration count is completed, additional processing is performed.

18.3.5.24 TCD Signed Minor Loop Offset (Minor Loop Mapping and Offset Enabled) (TCD0_NBYTES_MLOFFYES - TCD15_NBYTES_MLOFFYES)

18.3.5.24.1 Offset

For n = 0 to 15:

Register	Offset
TCDn_NBYTES_MLOFFYES	1008h + (n × 20h)

18.3.5.24.2 Function

One of three registers (this register, TCD_NBYTES_MLNO, or TCD_NBYTES_MLOFFNO), that defines the number of bytes to transfer per request. Which register to use depends on whether minor loop mapping is disabled, is enabled but not used for this channel, or is enabled and used.

TCD word 2 is defined as follows if:

- Minor loop mapping is enabled ([CR\[EMLM\]](#) = 1) and
- Minor loop offset is enabled (SMLOE or DMLOE = 1)

If minor loop mapping is enabled and SMLOE = 0 and DMLOE = 0, refer to the TCD_NBYTES_MLOFFNO register description. If minor loop mapping is disabled, refer to the TCD_NBYTES_MLNO register description.

18.3.5.24.3 Diagram

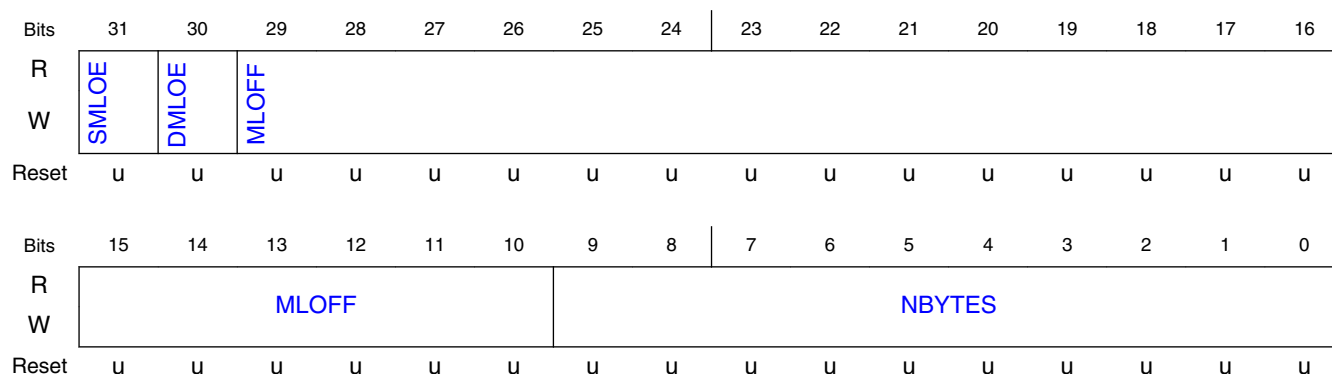

18.3.5.24.4 Fields

Field	Function
31 SMLOE	Source Minor Loop Offset Enable Specifies whether the minor loop offset is applied to the source address when the minor loop completes. 0b - The minor loop offset is not applied to the SADDR 1b - The minor loop offset is applied to the SADDR
30 DMLOE	Destination Minor Loop Offset Enable Specifies whether the minor loop offset is applied to the destination address when the minor loop completes. 0b - The minor loop offset is not applied to the DADDR 1b - The minor loop offset is applied to the DADDR
29-10 MLOFF	If SMLOE = 1 or DMLOE = 1, this field represents a sign-extended offset applied to the source or destination address to form the next-state value after the minor loop completes.
9-0 NBYTES	Minor Byte Transfer Count Number of bytes to be transferred in each service request of the channel. As a channel activates, the appropriate TCD contents load into the eDMA engine, and the appropriate reads and writes are performed until the minor byte transfer count has transferred. This is an indivisible operation and cannot be halted. It can, however, be stalled by using the bandwidth control field, or via preemption. After the minor count is exhausted, the SADDR and DADDR values are written back into the TCD memory, and the major iteration count is decremented and restored to the TCD memory. If the major iteration count is completed, additional processing is performed.

18.3.5.25 TCD Last Source Address Adjustment (TCD0_SLAST - TCD15_SLAST)

18.3.5.25.1 Offset

For n = 0 to 15:

Register	Offset
TCDn_SLAST	100Ch + (n × 20h)

18.3.5.25.2 Diagram

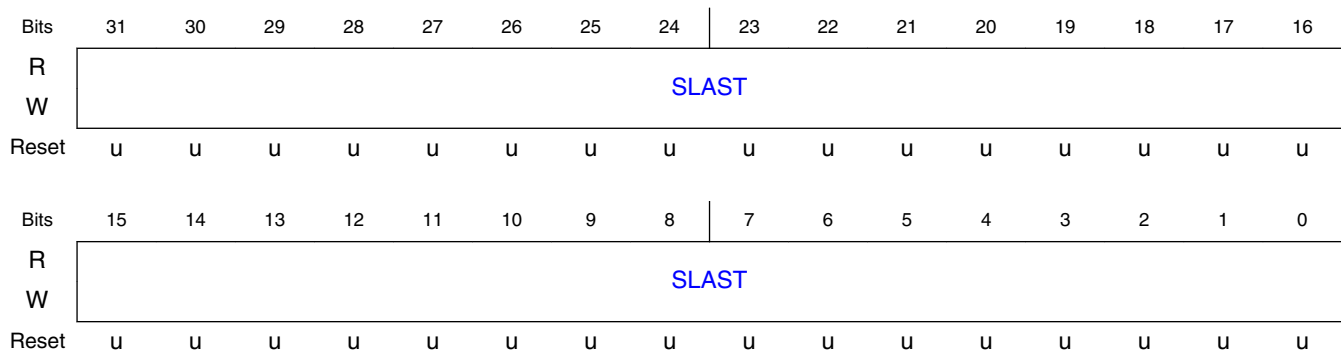

18.3.5.25.3 Fields

Field	Function
31-0	Last Source Address Adjustment
SLAST	Adjustment value added to the source address at the completion of the major iteration count. This value can be applied to restore the source address to the initial value, or adjust the address to reference the next data structure. This register uses two's complement notation; the overflow bit is discarded.

18.3.5.26 TCD Destination Address (TCD0_DADDR - TCD15_DADDR)

18.3.5.26.1 Offset

For n = 0 to 15:

Register	Offset
TCDn_DADDR	1010h + (n × 20h)

18.3.5.26.2 Function

This register contains the destination address of the transfer.

18.3.5.26.3 Diagram

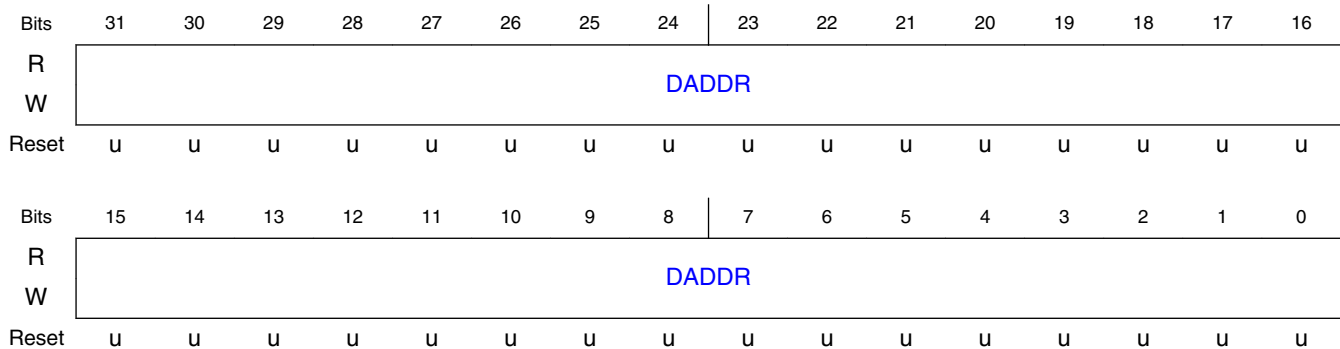

18.3.5.26.4 Fields

Field	Function
31-0	Destination Address
DADDR	Memory address pointing to the destination data.

18.3.5.27 TCD Signed Destination Address Offset (TCD0_DOFF - TCD15_DOFF)

18.3.5.27.1 Offset

For n = 0 to 15:

Register	Offset
TCDn_DOFF	1014h + (n × 20h)

18.3.5.27.2 Diagram

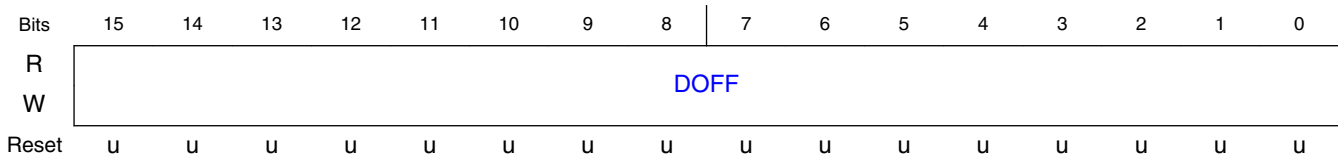

18.3.5.27.3 Fields

Field	Function
15-0	Destination Address Signed Offset
DOFF	Sign-extended offset applied to the current destination address to form the next-state value as each destination write is completed.

18.3.5.28 TCD Current Minor Loop Link, Major Loop Count (Channel Linking Disabled) (TCD0_CITER_ELINKNO - TCD15_CITER_ELINKNO)

18.3.5.28.1 Offset

For n = 0 to 15:

Register	Offset
TCDn_CITER_ELINKNO	1016h + (n × 20h)

18.3.5.28.2 Function

This register contains the minor-loop channel-linking configuration and the channel's current iteration count. It is the same register as [TCD Current Minor Loop Link, Major Loop Count \(Channel Linking Enabled\) \(TCD0_CITER_ELINKYES - TCD15_CITER_ELINKYES\)](#), but its fields are defined differently based on the state of the ELINK field. If the ELINK field is 0, this register is defined as follows.

18.3.5.28.3 Diagram



18.3.5.28.4 Fields

Field	Function
15 ELINK	<p>Enable channel-to-channel linking on minor-loop complete</p> <p>As the channel completes the minor loop, this field enables linking to another channel, defined by the LINKCH field. The link target channel initiates a channel service request via an internal mechanism that sets TCDn_CSR[START] of the specified channel.</p> <p>If channel linking is disabled, the CITER value is extended to 15 bits in place of a link channel number. If the major loop is exhausted, this link mechanism is suppressed in favor of the MAJORELINK channel linking.</p> <p>NOTE: This field must be equal to BITER[ELINK]; otherwise, a configuration error is reported. 0b - Channel-to-channel linking is disabled 1b - Channel-to-channel linking is enabled</p>
14-0 CITER	<p>Current Major Iteration Count</p> <p>This field is the current major loop count for the channel. It is decremented each time the minor loop is completed and updated in the transfer control descriptor memory. After the major iteration count is exhausted, the channel performs a number of operations, for example, final source and destination address calculations. It optionally generates an interrupt to signal channel completion before reloading the CITER field from the Beginning Iteration Count (BITER) field.</p> <p>NOTE:</p> <ol style="list-style-type: none"> When the CITER field is initially loaded by software, it must be set to the same value as that contained in the BITER field. If the channel is configured to execute a single service request, the initial values of BITER and CITER should be 0x0001.

18.3.5.29 TCD Current Minor Loop Link, Major Loop Count (Channel Linking Enabled) (TCD0_CITER_ELINKYES - TCD15_CITER_ELINKYES)

18.3.5.29.1 Offset

For n = 0 to 15:

Register	Offset
TCDn_CITER_ELINKYES	1016h + (n × 20h)

18.3.5.29.2 Function

This register contains the minor-loop channel-linking configuration and the channel's current iteration count. It is the same register as [TCD Current Minor Loop Link, Major Loop Count \(Channel Linking Disabled\) \(TCD0_CITER_ELINKNO - TCD15_CITER_ELINKNO\)](#), but its fields are defined differently based on the state of the ELINK field. If the ELINK field is 1, this register is defined as follows.

18.3.5.29.3 Diagram

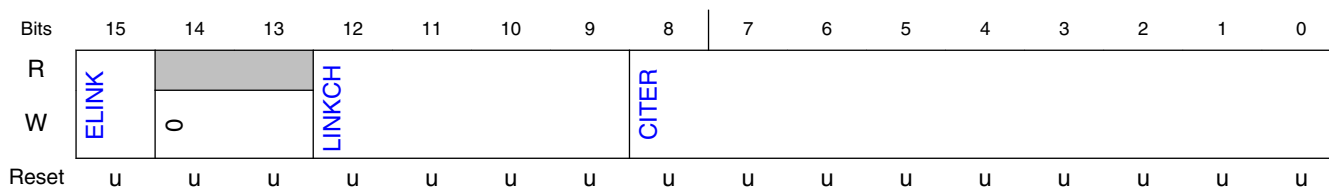

18.3.5.29.4 Fields

Field	Function
15 ELINK	<p>Enable channel-to-channel linking on minor-loop complete</p> <p>As the channel completes the minor loop, this field enables linking to another channel, defined by the LINKCH field. The link target channel initiates a channel service request via an internal mechanism that sets TCDn_CSR[START] of the specified channel.</p> <p>If channel linking is disabled, the CITER value is extended to 15 bits in place of a link channel number. If the major loop is exhausted, this link mechanism is suppressed in favor of the MAJORELINK channel linking.</p> <p>NOTE: This field must be equal to BITER[ELINK]; otherwise, a configuration error is reported.</p> <p>0b - Channel-to-channel linking is disabled 1b - Channel-to-channel linking is enabled</p>
14-13 —	Reserved
12-9 LINKCH	<p>Minor Loop Link Channel Number</p> <p>If channel-to-channel linking is enabled (ELINK = 1), then after the minor loop is exhausted, the eDMA engine initiates a channel service request to the channel defined by this field, by setting that channel's TCDn_CSR[START].</p>
8-0 CITER	<p>Current Major Iteration Count</p> <p>This field is the current major loop count for the channel. It is decremented each time the minor loop is completed and updated in the transfer control descriptor memory. After the major iteration count is exhausted, the channel performs a number of operations, for example, final source and destination address calculations. It optionally generates an interrupt to signal channel completion before reloading the CITER field from the Beginning Iteration Count (BITER) field.</p> <p>NOTE: 1. When the CITER field is initially loaded by software, it must be set to the same value as that contained in the BITER field.</p>

Field	Function
	2. If the channel is configured to execute a single service request, the initial values of BITER and CITER should be 0x0001.

18.3.5.30 TCD Last Destination Address Adjustment/Scatter Gather Address (TCDn_DLASTSGA - TCD15_DLASTSGA)

18.3.5.30.1 Offset

For n = 0 to 15:

Register	Offset
TCDn_DLASTSGA	1018h + (n × 20h)

18.3.5.30.2 Diagram

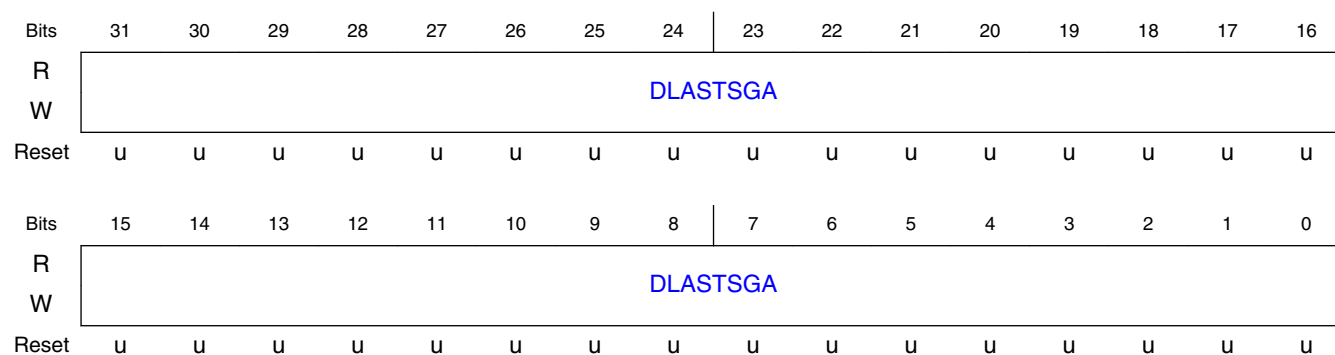

18.3.5.30.3 Fields

Field	Function
31-0 DLASTSGA	<p>Destination last address adjustment, or next memory address TCD for channel (scatter/gather)</p> <p>If (TCDn_CSR[ESG] = 0) then:</p> <ul style="list-style-type: none"> This is the adjustment value added to the destination address at the completion of the major iteration count. This value can apply to restore the destination address to the initial value or adjust the address to reference the next data structure. This field uses two's complement notation for the final destination address adjustment. <p>Otherwise:</p> <ul style="list-style-type: none"> This address points to the beginning of a 0-modulo 32-byte region containing the next TCD to be loaded into this channel. This channel reload is performed as the major iteration count completes. The scatter/gather address must be 0-modulo 32-byte; otherwise a configuration error is reported.

18.3.5.31 TCD Control and Status (TCD0_CSR - TCD15_CSR)

18.3.5.31.1 Offset

For n = 0 to 15:

Register	Offset
TCDn_CSR	101Ch + (n × 20h)

18.3.5.31.2 Diagram

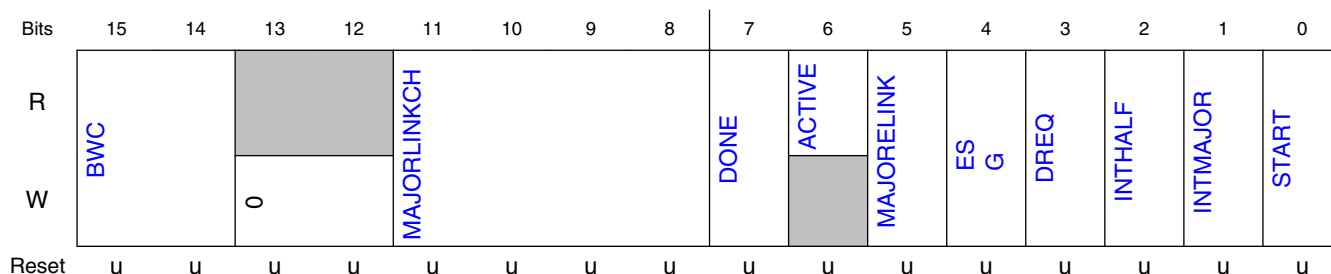

18.3.5.31.3 Fields

Field	Function
15-14 BWC	Bandwidth Control Throttles the amount of bus bandwidth consumed by the eDMA. Generally, as the eDMA processes the minor loop, it continuously generates read/write sequences until the minor count is exhausted. This field forces the eDMA to stall after the completion of each read/write access to control the bus request bandwidth seen by the crossbar switch. NOTE: If the source and destination sizes are equal, this field is ignored between the first and second transfers and after the last write of each minor loop. This behavior is a side effect of reducing start-up latency. 00b - No eDMA engine stalls 01b - Reserved 10b - eDMA engine stalls for 4 cycles after each R/W 11b - eDMA engine stalls for 8 cycles after each R/W
13-12 —	Reserved
11-8 MAJORLINKCH	Major Loop Link Channel Number If (MAJORELINK = 0) then: <ul style="list-style-type: none"> No channel-to-channel linking, or chaining, is performed after the major loop counter is exhausted.

Table continues on the next page...

Field	Function
	<p>Otherwise:</p> <ul style="list-style-type: none"> After the major loop counter is exhausted, the eDMA engine initiates a channel service request at the channel defined by this field by setting that channel's START bit.
7 DONE	<p>Channel Done</p> <p>This field indicates whether the eDMA has completed the major loop. The eDMA engine sets the value of this field to 1 when the CITER count reaches zero. The value of this field is reset to 0 by the hardware (when the channel is activated) or by software.</p> <p>NOTE: This field must be 0 to write the MAJORELINK or ESG fields.</p>
6 ACTIVE	<p>Channel Active</p> <p>This field indicates whether the channel is currently in execution. The eDMA sets the value of this field to 1 when channel service begins, and resets it to 0 as the minor loop completes or when any error condition is detected.</p>
5 MAJORELINK	<p>Enable channel-to-channel linking on major loop complete</p> <p>As the channel completes the major loop, this field controls linking to another channel, defined by MAJORLINKCH. The link target channel initiates a channel service request via an internal mechanism that sets TCDn_CSR[START] of the specified channel.</p> <p>NOTE: To support the dynamic linking coherency model, this field is forced to zero when written to when TCDn_CSR[DONE] is set.</p> <p>0b - Channel-to-channel linking is disabled 1b - Channel-to-channel linking is enabled</p>
4 ESG	<p>Enable Scatter/Gather Processing</p> <p>As the channel completes the major loop, this field controls scatter/gather processing in the current channel. If enabled, the eDMA engine uses DLASTSGA as a memory pointer to a 0-modulo 32-bit address containing a 32-byte data structure loaded as the TCD into local memory.</p> <p>NOTE: To support the dynamic scatter/gather coherency model, this field is forced to zero when written to when TCDn_CSR[DONE] is set.</p> <p>0b - The current channel's TCD is normal format 1b - The current channel's TCD specifies a scatter gather format</p>
3 DREQ	<p>Disable Request</p> <p>If the value of this field is 1, eDMA hardware automatically writes 0 to the corresponding ERQ field when the current major iteration count reaches zero.</p> <p>0b - The channel's ERQ field is not affected 1b - The channel's ERQ field value changes to 0 when the major loop is complete</p>
2 INTHALF	<p>Enable an interrupt when major counter is half complete.</p> <p>If the value of this field is 1, the channel generates an interrupt request by setting the appropriate field in the INT register when the current major iteration count reaches the halfway point. Specifically, the comparison performed by the eDMA engine is (CITER == (BITER >> 1)). This halfway point interrupt request is provided to support double-buffered, also known as ping-pong, schemes or other types of data movement where the processor needs an early indication of the transfer's progress.</p> <p>NOTE: If BITER = 1, do not use INTHALF. Use INTMAJOR instead.</p> <p>0b - Half-point interrupt is disabled 1b - Half-point interrupt is enabled</p>
1 INTMAJOR	<p>Enable an interrupt when major iteration count completes.</p> <p>If the value of this field is 1, the channel generates an interrupt request by setting the appropriate field in the INT when the current major iteration count reaches zero.</p> <p>0b - End of major loop interrupt is disabled 1b - End of major loop interrupt is enabled</p>

Table continues on the next page...

Memory map/register definition

Field	Function
0 START	Channel Start If the value of this field is 1, the channel is requesting service. eDMA hardware automatically writes 0 to this field after the channel begins execution. 0b - Channel is not explicitly started 1b - Channel is explicitly started via a software initiated service request

18.3.5.32 TCD Beginning Minor Loop Link, Major Loop Count (Channel Linking Disabled) (TCD0_BITER_ELINKNO - TCD15_BITER_ELINKNO)

18.3.5.32.1 Offset

For n = 0 to 15:

Register	Offset
TCDn_BITER_ELINKNO	101Eh + (n × 20h)

18.3.5.32.2 Function

If TCDn_BITER[ELINK] is 0, the TCDn_BITER register is defined as follows.

18.3.5.32.3 Diagram

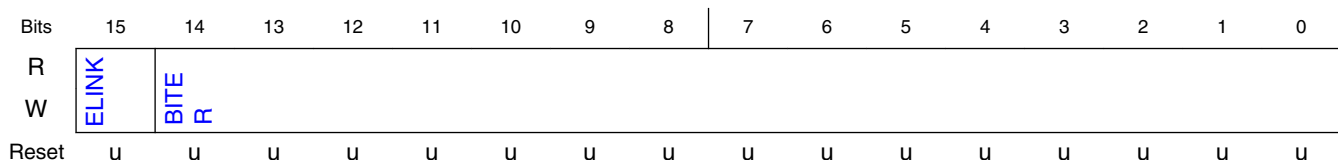

18.3.5.32.4 Fields

Field	Function
15 ELINK	Enables channel-to-channel linking on minor loop complete As the channel completes the minor loop, this field enables linking to another channel, defined by BITER[LINKCH]. The link target channel initiates a channel service request via an internal mechanism that sets TCDn_CSR[START] of the specified channel. If channel linking is disabled, the BITER value extends to 15 bits in place of a link channel number. If the major loop is exhausted, this link mechanism is suppressed in favor of the MAJORELINK channel linking.

Table continues on the next page...

Field	Function
	<p>NOTE: When the software loads the TCD, this field must be set equal to the corresponding CITER field; otherwise, a configuration error is reported. As the major iteration count is exhausted, the contents of this field are reloaded into the CITER field.</p> <p>0b - Channel-to-channel linking is disabled 1b - Channel-to-channel linking is enabled</p>
14-0 BITER	<p>Starting Major Iteration Count</p> <p>As the TCD is first loaded by software, this 9-bit (ELINK = 1) or 15-bit (ELINK = 0) field must be equal to the value in the CITER field. As the major iteration count is exhausted, the contents of this field are reloaded into the CITER field.</p> <p>NOTE: When the software loads the TCD, this field must be set equal to the corresponding CITER field. As the major iteration count is exhausted, the contents of this field are reloaded into the CITER field. If the channel is configured to execute a single service request, the initial values of BITER and CITER should be 0x0001.</p>

18.3.5.33 TCD Beginning Minor Loop Link, Major Loop Count (Channel Linking Enabled) (TCD0_BITER_ELINKYES - TCD15_BITER_ELINKYES)

18.3.5.33.1 Offset

For n = 0 to 15:

Register	Offset
TCDn_BITER_ELINKYES	101Eh + (n × 20h)

18.3.5.33.2 Function

If TCDn_BITER[ELINK] is 1, the TCDn_BITER register is defined as follows.

18.3.5.33.3 Diagram

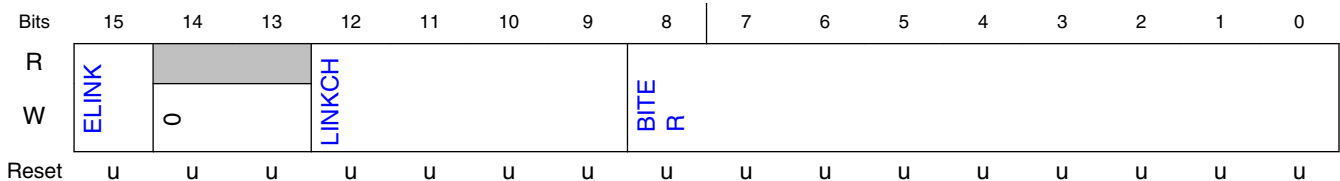

18.3.5.33.4 Fields

Field	Function
15 ELINK	<p>Enables channel-to-channel linking on minor loop complete</p> <p>As the channel completes the minor loop, this field enables linking to another channel, defined by BITER[LINKCH]. The link target channel initiates a channel service request via an internal mechanism that sets TCDn_CSR[START] of the specified channel. If channel linking disables, the BITER value extends to 15 bits in place of a link channel number. If the major loop is exhausted, this link mechanism is suppressed in favor of the MAJORELINK channel linking.</p> <p>NOTE: When the software loads the TCD, this field must be set equal to the corresponding CITER field; otherwise, a configuration error is reported. As the major iteration count is exhausted, the contents of this field are reloaded into the CITER field.</p> <p>0b - Channel-to-channel linking is disabled 1b - Channel-to-channel linking is enabled</p>
14-13 —	Reserved
12-9 LINKCH	<p>Link Channel Number</p> <p>If channel-to-channel linking is enabled (ELINK = 1), then after the minor loop is exhausted, the eDMA engine initiates a channel service request at the channel defined by this field, by setting that channel's TCDn_CSR[START].</p> <p>NOTE: When the software loads the TCD, this field must be set equal to the corresponding CITER field; otherwise, a configuration error is reported. As the major iteration count is exhausted, the contents of this field are reloaded into the CITER field.</p>
8-0 BITER	<p>Starting major iteration count</p> <p>As the TCD is first loaded by software, this 9-bit (ELINK = 1) or 15-bit (ELINK = 0) field must be equal to the value in the CITER field. As the major iteration count is exhausted, the contents of this field are reloaded into the CITER field.</p> <p>NOTE: When the software loads the TCD, this field must be set equal to the corresponding CITER field. As the major iteration count is exhausted, the contents of this field are reloaded into the CITER field. If the channel is configured to execute a single service request, the initial values of BITER and CITER should be 0x0001.</p>

18.4 Functional description

The operation of the eDMA is described in the following subsections.

18.4.1 Modes of operation

eDMA operates in the following modes:

Table 18-4. Modes of operation

Mode	Description
Normal	In Normal mode, eDMA transfers data from a source to a destination. The source and destination can be a memory block or an I/O block capable of operation with eDMA.

Table continues on the next page...

Table 18-4. Modes of operation (continued)

Mode	Description
	<p>A <i>service request</i> initiates a transfer of a specific number of bytes (NBYTES) as specified in the TCD.</p> <ul style="list-style-type: none"> • The <i>minor loop</i> is the sequence of read and write operations that transfers the NBYTES of data for a service request. • Each service request executes one iteration of the major loop, transferring NBYTES of data.
Debug	<p>DMA operation is configurable in Debug mode via Control (CR)</p> <ul style="list-style-type: none"> • If CR[EDBG] = 0, eDMA continues to operate normally when the chip is in debug mode. • If CR[EDBG] = 1, eDMA stops transferring data when the chip enters debug mode. If a channel is active when eDMA enters Debug mode, eDMA continues operation until the channel retires.
Wait	<p>Before entering Wait mode, eDMA attempts to complete any transfer that is in progress. After the transfer completes, the chip enters Wait mode.</p>

18.4.2 eDMA basic data flow

The basic flow of a data transfer can be partitioned into three segments.

As shown in the following diagram, the first segment involves the channel activation:

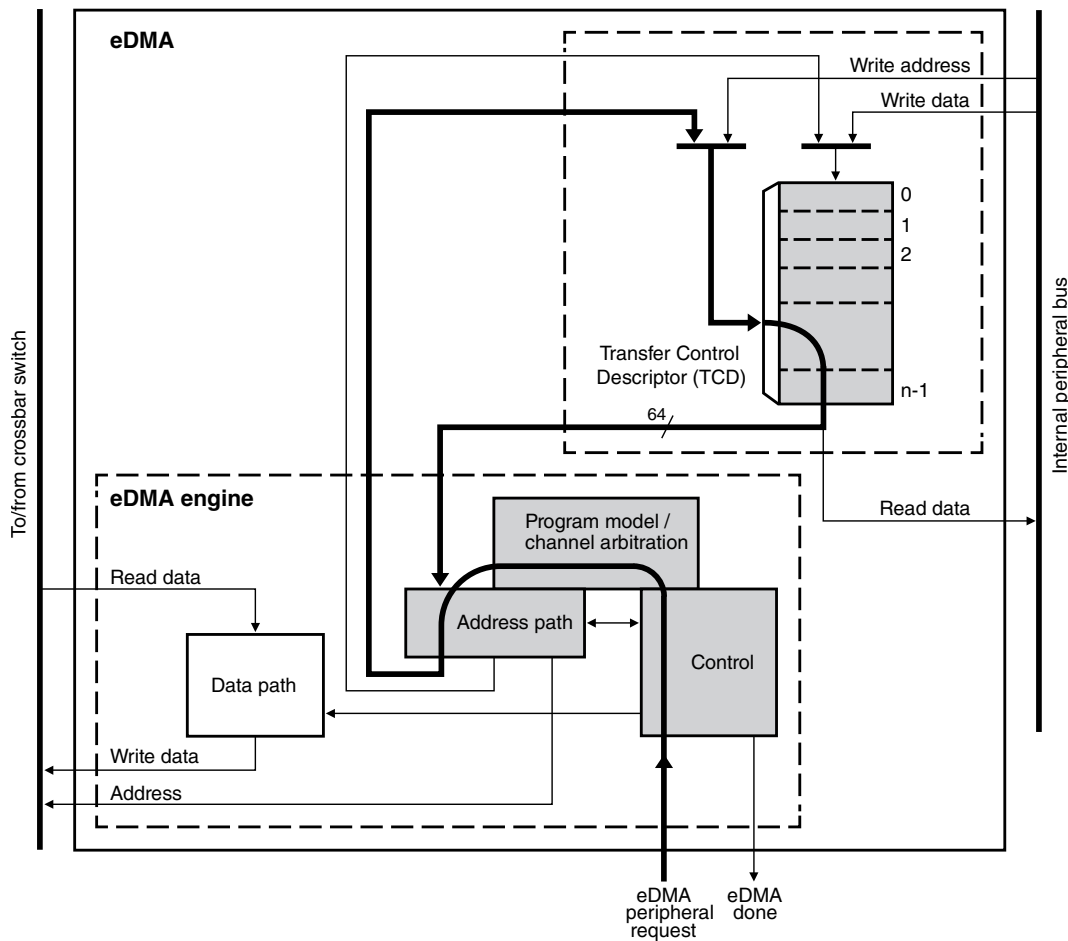

Figure 18-2. eDMA operation, part 1

This example uses the assertion of the eDMA peripheral request signal to request service for channel n . Channel activation via software and the $TCD_n_CSR[START]$ bit follows the same basic flow as peripheral requests. The eDMA request input signal is registered internally and then routed through the eDMA engine: first through the control module, then into the program model and channel arbitration. In the next cycle, the channel arbitration executes, using either the fixed-priority or round-robin algorithm. After arbitration is complete, the activated channel number is sent through the address path and converted into the required address to access the local memory for TCD_n . Next, the TCD memory is accessed and the required descriptor read from the local memory and loaded into the eDMA engine's internal register file. The TCD memory is 64 bits wide to minimize the time needed to fetch the activated channel descriptor and load it into the internal register file.

The following diagram illustrates the second part of the basic data flow:

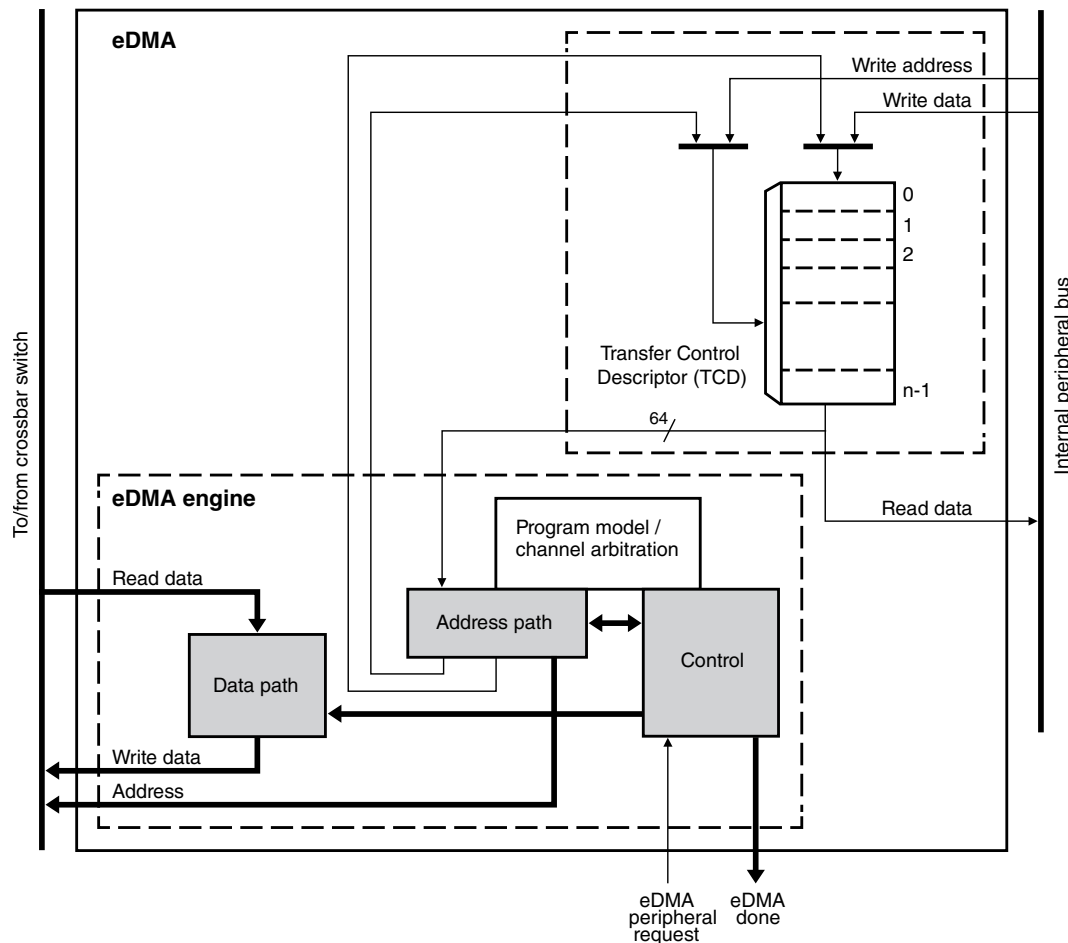

Figure 18-3. eDMA operation, part 2

The modules associated with the data transfer (address path, data path, and control) execute sequentially through the required source reads and destination writes to perform the data movement. The source reads are initiated and the fetched data is temporarily stored in the data path block until it is gated onto the internal bus during the destination write. This source read/destination write processing continues until the minor byte count has transferred.

After the minor byte count has moved, the final phase of the basic data flow is performed. In this segment, the address path logic performs the required updates to certain fields in the appropriate TCD, for example, SADDR, DADDR, CITER. If the major iteration count is exhausted, additional operations are performed. These include the final address adjustments and reloading of the BITER field into the CITER. Assertion of an optional interrupt request also occurs at this time, as does a possible fetch of a new TCD from memory using the scatter/gather address pointer included in the descriptor (if scatter/gather is enabled). The updates to the TCD memory and the assertion of an interrupt request are shown in the following diagram.

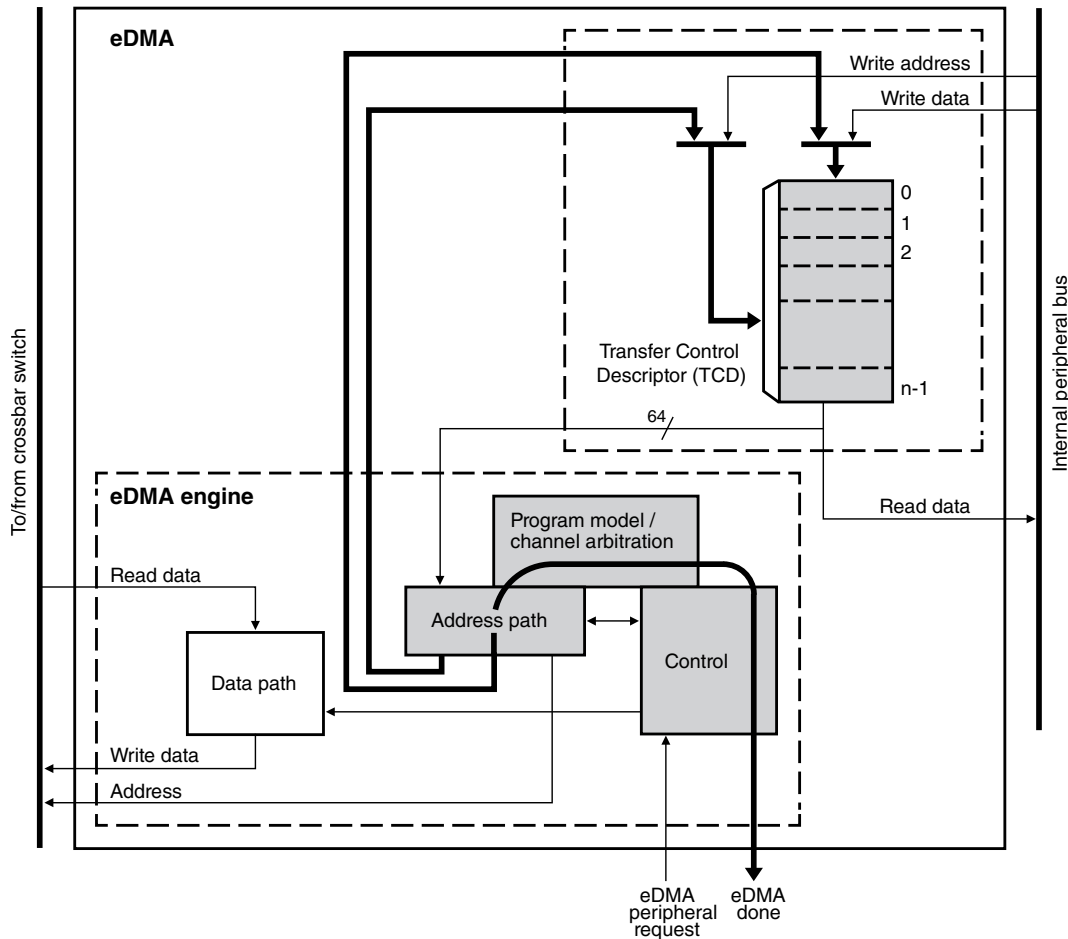

Figure 18-4. eDMA operation, part 3

18.4.3 Fault reporting and handling

Channel errors are reported in the Error Status register (DMAx_ES) and can be caused by:

- A configuration error, which is an illegal setting in the transfer-control descriptor or an illegal priority register setting in Fixed-Arbitration mode, or
- An error termination to a bus master read or write cycle

A configuration error is reported when the starting source or destination address, source or destination offsets, minor loop byte count, or the transfer size represent an inconsistent state. Each of these possible causes is detailed below:

- The addresses and offsets must be aligned on 0-modulo transfer size boundaries.
- The minor loop byte count must be a multiple of the source and destination transfer sizes.

- All source reads and destination writes must be configured to the natural boundary of the programmed transfer size respectively.
- In fixed arbitration mode, a configuration error is caused by any two channel priorities being equal. All channel priority levels must be unique when fixed arbitration mode is enabled.

NOTE

When two channels have the same priority, a channel priority error exists and is reported in the Error Status register. However, the channel number is not reported in the Error Status register. When all of the channel priorities within a group are not unique, the channel number selected by arbitration is undetermined.

To aid in Channel Priority Error (CPE) debug, set the Halt On Error bit in the DMA's Control register. If all channel priorities within a group are not unique, the DMA is halted after the CPE error is recorded. The DMA remains halted and does not process any channel service requests. After all of the channel priorities are set to unique numbers, the DMA may be enabled again by clearing the HALT bit.

- If a scatter/gather operation is enabled upon channel completion, a configuration error is reported if the scatter/gather address (DLAST_SGA) is not aligned on a 32-byte boundary.
- If minor loop channel linking is enabled upon channel completion, a configuration error is reported when the link is attempted if the TCDn_CITER[ELINK] bit does not equal the TCDn_BITER[ELINK] bit.

If enabled, all configuration error conditions, except the scatter/gather and minor-loop link errors, report as the channel activates and asserts an error interrupt request. A scatter/gather configuration error is reported when the scatter/gather operation begins at major loop completion, when properly enabled. A minor loop channel link configuration error is reported when the link operation is serviced at minor loop completion.

If a system bus read or write is terminated with an error, the data transfer is stopped and the appropriate bus error flag set. In this case, the state of the channel's transfer control descriptor is updated by the eDMA engine with the current source address, destination address, and current iteration count at the point of the fault. When a system bus error occurs, the channel terminates after the next transfer. Due to pipeline effect, the next transfer is already in progress when the bus error is received by the eDMA. If a bus error occurs on the last read prior to beginning the write sequence, the write executes using the

data captured during the bus error. If a bus error occurs on the last write prior to switching to the next read sequence, the read sequence executes before the channel terminates due to the destination bus error.

A transfer may be canceled by software with the CR[CX] bit. When a cancel transfer request is recognized, the DMA engine stops processing the channel. The current read-write sequence is allowed to finish. If the cancel occurs on the last read-write sequence of a major or minor loop, the cancel request is discarded and the channel retires normally.

The error cancel transfer is the same as a cancel transfer except the Error Status register (DMAx_ES) is updated with the canceled channel number and ECX is set. The TCD of a canceled channel contains the source and destination addresses of the last transfer saved in the TCD. If the channel needs to be restarted, you must re-initialize the TCD because the aforementioned fields no longer represent the original parameters. When a transfer is canceled by the error cancel transfer mechanism, the channel number is loaded into DMA_ES[ERRCHN] and ECX and VLD are set. In addition, an error interrupt may be generated if enabled.

NOTE

The cancel transfer request enables you to stop a large data transfer when the full data transfer is no longer needed. The cancel transfer bit does not abort the channel. It simply stops the transferring of data and then retires the channel through its normal shutdown sequence. The application software must manage the context of the cancel. If an interrupt is desired (or not), then the interrupt should be enabled (or disabled) before the cancel request. The application software must clean up the transfer control descriptor because the full transfer did not occur.

The occurrence of any error causes the eDMA engine to stop normal processing of the active channel immediately (it goes to its error processing states and the transaction to the system bus still has pipeline effect), and the appropriate channel bit in the eDMA error register is asserted. At the same time, the details of the error condition are loaded into the Error Status register (DMAx_ES). The major loop complete indicators, setting the transfer control descriptor DONE flag and the possible assertion of an interrupt request, are not affected when an error is detected. After the error status has been updated, the eDMA engine continues operating by servicing the next appropriate channel. A channel that experiences an error condition is not automatically disabled. If a channel is terminated by an error and then issues another service request before the error is fixed, that channel executes and terminates with the same error condition.

18.4.4 Channel preemption

Channel preemption is enabled on a per-channel basis by setting DCHPRIn[ECP]. Channel preemption enables the executing channel's data transfers to temporarily be suspended in favor of starting a higher priority channel. After the preempting channel has completed its minor loop data transfers, the preempted channel is restored and resumes execution. After the restored channel completes one read/write sequence, it is again eligible for preemption. If any higher priority channel is requesting service, the restored channel is suspended and the higher priority channel is serviced. Nested preemption, that is, attempting to preempt a preempting channel, is not supported. After a preempting channel begins execution, it cannot be preempted. Preemption is available only when fixed arbitration is selected.

A channel's ability to preempt another channel can be disabled by setting DCHPRIn[DPA]. When a channel's preemption ability is disabled, that channel cannot suspend a lower priority channel's data transfer, regardless of the lower priority channel's ECP setting. This enables a pool of low priority, large data-moving channels to be defined. These low priority channels can be configured to not preempt each other, thus preventing a low priority channel from consuming the preempt slot normally available to a true, high priority channel.

18.5 Initialization/application information

The following sections discuss initialization of the eDMA and programming considerations.

18.5.1 eDMA initialization

To initialize the eDMA:

1. Write to the CR if a configuration other than the default is desired.
2. Write the channel priority levels to the DCHPRIn registers if a configuration other than the default is desired.
3. Enable error interrupts in the EEI register if desired.
4. Write the 32-byte TCD for each channel that may request service.
5. Enable any hardware service requests via the ERQ register.
6. Request channel service via either:
 - Software: setting TCDn_CSR[START]
 - Hardware: slave device asserting its eDMA peripheral request signal

After any channel requests service, a channel is selected for execution based on the arbitration and priority levels in the programming model. The eDMA engine reads the entire TCD, including the TCD control and status fields, as shown in [Table 18-5](#), for the selected channel into its internal address path module.

As the TCD is read, the first transfer is initiated on the system bus, unless a configuration error is detected. Transfers from the source, as defined by `TCDn_SADDR`, to the destination, as defined by `TCDn_DADDR`, continue until the number of bytes specified by `TCDn_NBYTES` have been transferred.

When the transfer is complete, the eDMA engine's local `TCDn_SADDR`, `TCDn_DADDR`, and `TCDn_CITER` are written back to the main TCD memory and any minor loop channel linking is performed, if enabled. If the major loop is exhausted, further post-processing executes, such as interrupts, major loop channel linking, and scatter/gather operations, if enabled.

Table 18-5. TCD control and status fields

TCDn_CSR field name	Description
START	Control bit to start channel explicitly when using a software-initiated DMA service (automatically cleared by hardware)
ACTIVE	Status bit indicating the channel is currently in execution
DONE	Status bit indicating major loop completion (cleared by software when using a software-initiated DMA service)
DREQ	Control bit to disable DMA request at end of major loop completion when using a hardware-initiated DMA service
BWC	Control bits for throttling bandwidth control of a channel
ESG	Control bit to enable scatter/gather feature
INTHALF	Control bit to enable interrupt when major loop is half complete
INTMAJOR	Control bit to enable interrupt when major loop completes

The following figure shows how each DMA request initiates one minor-loop transfer, or iteration, without CPU intervention. DMA arbitration can occur after each minor loop, and one level of minor loop DMA preemption is allowed. The number of minor loops in a major loop is specified by the beginning iteration count (BITER).

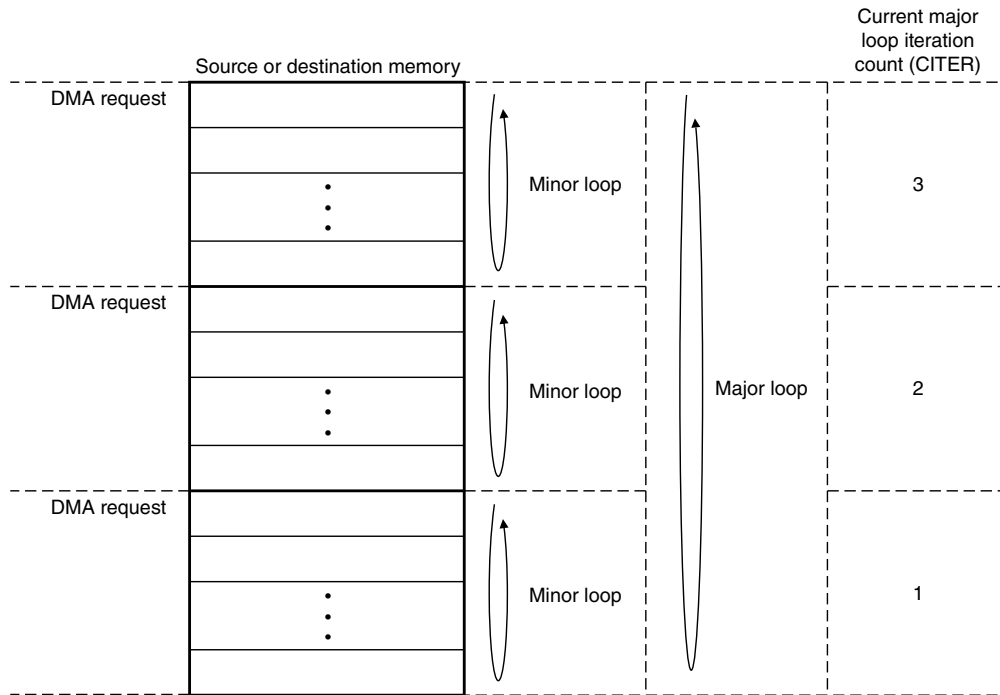

Figure 18-5. Example of multiple loop iterations

The following figure lists the memory array terms and how the TCD settings interrelate.

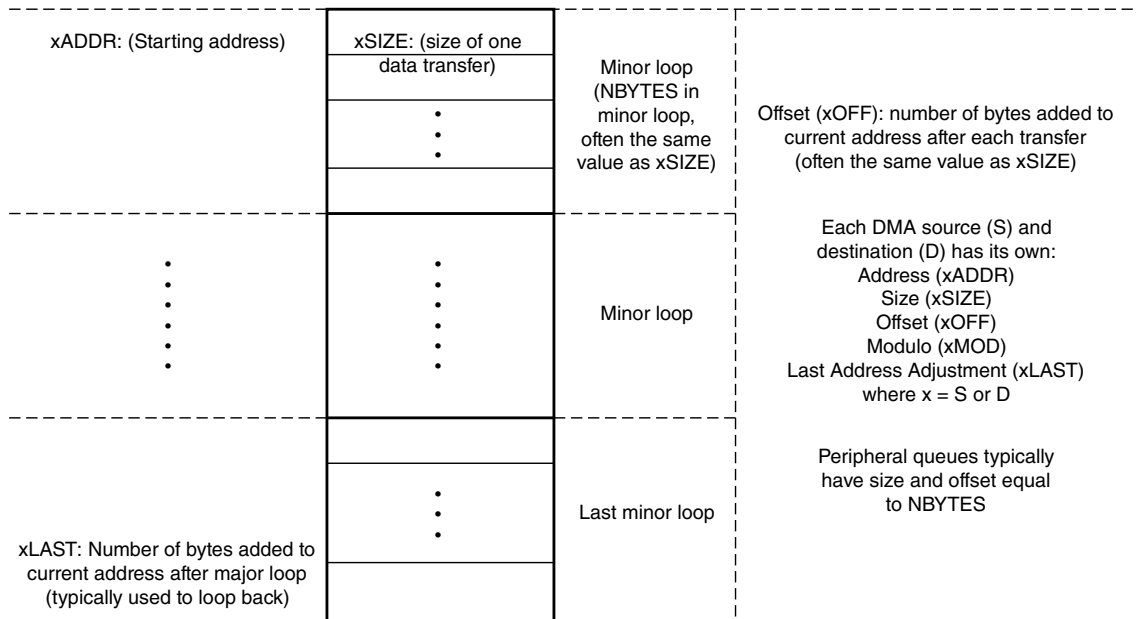

Figure 18-6. Memory array terms

18.5.2 Programming errors

The eDMA performs various tests on the transfer control descriptor to verify consistency in the descriptor data. Most programming errors are reported on a per-channel basis with the exception of channel priority error (ES[CPE]).

For all error types other than channel priority error, the channel number causing the error is recorded in the Error Status register (DMAx_ES). If the error source is not removed before the next activation of the problem channel, the error is detected and recorded again.

If priority levels are not unique, when any channel requests service, a channel priority error is reported. The highest channel priority with an active request is selected, but the lowest numbered channel with that priority is selected by arbitration and executed by the eDMA engine. The hardware service request handshake signals, error interrupts, and error reporting are associated with the selected channel.

18.5.3 Arbitration mode considerations

This section discusses arbitration considerations for the eDMA.

18.5.3.1 Fixed channel arbitration

In this mode, the channel service request from the highest priority channel is selected to execute.

18.5.3.2 Round-robin channel arbitration

Channels are serviced starting with the highest channel number and rotating through to the lowest channel number without regard to the channel priority levels.

18.5.4 DMA transfer examples

This section presents examples of how to perform DMA transfers with the eDMA.

18.5.4.1 Single request

To perform a simple transfer of n bytes of data with one activation, set the major loop to one ($TCDn_CITER = TCDn_BITER = 1$). The data transfer begins after the channel service request is acknowledged and the channel is selected to execute. After the transfer is complete, $TCDn_CSR[DONE]$ is set and an interrupt generates if properly enabled.

For example, the following TCD entry is configured to transfer 16 bytes of data. The eDMA is programmed for one iteration of the major loop transferring 16 bytes per iteration. The source memory has an 8-bit memory port located at 0x1000. The destination memory has a 32-bit port located at 0x2000. The address offsets are programmed in increments to match the transfer size: one byte for the source and four bytes for the destination. The final source and destination addresses are adjusted to return to their beginning values.

```
TCDn_CITER = TCDn_BITER = 1
TCDn_NBYTES = 16
TCDn_SADDR = 0x1000
TCDn_SOFF = 1
TCDn_ATTR[SSIZE] = 0
TCDn_SLAST = -16
TCDn_DADDR = 0x2000
TCDn_DOFF = 4
TCDn_ATTR[DSIZE] = 2
TCDn_DLAST_SGA = -16
TCDn_CSR[INTMAJOR] = 1
TCDn_CSR[START] = 1 (Should be written last after all other fields have been initialized)
All other TCDn fields = 0
```

This generates the following event sequence:

1. User write to the $TCDn_CSR[START]$ bit requests channel service.
2. The channel is selected by arbitration for servicing.
3. eDMA engine writes: $TCDn_CSR[DONE] = 0$, $TCDn_CSR[START] = 0$, $TCDn_CSR[ACTIVE] = 1$.
4. eDMA engine reads: channel TCD data from local memory to internal register file.
5. The source-to-destination transfers are executed as follows:
 - a. Read byte from location 0x1000, read byte from location 0x1001, read byte from 0x1002, read byte from 0x1003.
 - b. Write 32 bits to location 0x2000 → first iteration of the minor loop.
 - c. Read byte from location 0x1004, read byte from location 0x1005, read byte from 0x1006, read byte from 0x1007.
 - d. Write 32 bits to location 0x2004 → second iteration of the minor loop.
 - e. Read byte from location 0x1008, read byte from location 0x1009, read byte from 0x100A, read byte from 0x100B.
 - f. Write 32 bits to location 0x2008 → third iteration of the minor loop.
 - g. Read byte from location 0x100C, read byte from location 0x100D, read byte from 0x100E, read byte from 0x100F.

- h. Write 32 bits to location 0x200C → last iteration of the minor loop → major loop complete.
6. The eDMA engine writes: TCD_n_SADDR = 0x1000, TCD_n_DADDR = 0x2000, TCD_n_CITER = 1 (TCD_n_BITER).
7. The eDMA engine writes: TCD_n_CSR[ACTIVE] = 0, TCD_n_CSR[DONE] = 1, INT[n] = 1.
8. The channel retires and the eDMA goes idle or services the next channel.

18.5.4.2 Multiple requests

The following example transfers 32 bytes via two hardware requests, but is otherwise the same as the previous example. The only fields that change are the major loop iteration count and the final address offsets. The eDMA is programmed for two iterations of the major loop, transferring 16 bytes per iteration. After the channel's hardware requests are enabled in the ERQ register, the slave device initiates channel service requests.

```
TCDn_CITER = TCDn_BITER = 2
TCDn_SLAST = -32
TCDn_DLAST_SGA = -32
```

This would generate the following sequence of events:

1. First hardware, that is, the eDMA peripheral, requests channel service.
2. The channel is selected by arbitration for servicing.
3. eDMA engine writes: TCD_n_CSR[DONE] = 0, TCD_n_CSR[START] = 0, TCD_n_CSR[ACTIVE] = 1.
4. eDMA engine reads: channel TCD_n data from local memory to internal register file.
5. The source to destination transfers are executed as follows:
 - a. Read byte from location 0x1000, read byte from location 0x1001, read byte from 0x1002, read byte from 0x1003.
 - b. Write 32 bits to location 0x2000 → first iteration of the minor loop.
 - c. Read byte from location 0x1004, read byte from location 0x1005, read byte from 0x1006, read byte from 0x1007.
 - d. Write 32 bits to location 0x2004 → second iteration of the minor loop.
 - e. Read byte from location 0x1008, read byte from location 0x1009, read byte from 0x100A, read byte from 0x100B.
 - f. Write 32 bits to location 0x2008 → third iteration of the minor loop.
 - g. Read byte from location 0x100C, read byte from location 0x100D, read byte from 0x100E, read byte from 0x100F.
 - h. Write 32 bits to location 0x200C → last iteration of the minor loop.
6. eDMA engine writes: TCD_n_SADDR = 0x1010, TCD_n_DADDR = 0x2010, TCD_n_CITER = 1.
7. eDMA engine writes: TCD_n_CSR[ACTIVE] = 0.

8. The channel retires → one iteration of the major loop. The eDMA goes idle or services the next channel.
9. Second hardware, that is, eDMA peripheral, requests channel service.
10. The channel is selected by arbitration for servicing.
11. eDMA engine writes: $TCDn_CSR[DONE] = 0$, $TCDn_CSR[START] = 0$, $TCDn_CSR[ACTIVE] = 1$.
12. eDMA engine reads channel TCD data from local memory to internal register file.
13. The source to destination transfers are executed as follows:
 - a. Read byte from location 0x1010, read byte from location 0x1011, read byte from 0x1012, read byte from 0x1013.
 - b. Write 32 bits to location 0x2010 → first iteration of the minor loop.
 - c. Read byte from location 0x1014, read byte from location 0x1015, read byte from 0x1016, read byte from 0x1017.
 - d. Write 32 bits to location 0x2014 → second iteration of the minor loop.
 - e. Read byte from location 0x1018, read byte from location 0x1019, read byte from 0x101A, read byte from 0x101B.
 - f. Write 32 bits to location 0x2018 → third iteration of the minor loop.
 - g. Read byte from location 0x101C, read byte from location 0x101D, read byte from 0x101E, read byte from 0x101F.
 - h. Write 32 bits to location 0x201C → last iteration of the minor loop → major loop complete.
14. eDMA engine writes: $TCDn_SADDR = 0x1000$, $TCDn_DADDR = 0x2000$, $TCDn_CITER = 2$ ($TCDn_BITER$).
15. eDMA engine writes: $TCDn_CSR[ACTIVE] = 0$, $TCDn_CSR[DONE] = 1$, $INT[n] = 1$.
16. The channel retires → major loop complete. The eDMA goes idle or services the next channel.

18.5.4.3 Using the modulo feature

The modulo feature of the eDMA provides the ability to implement a circular data queue in which the size of the queue is a power of 2. MOD is a 5-bit field for the source and destination in the TCD, and it specifies which lower address bits increment from their original value after the address+offset calculation. All upper address bits remain the same as in the original value. A setting of zero for this field disables the modulo feature.

The following table shows how the transfer addresses are specified based on the setting of the MOD field. Here a circular buffer is created where the address wraps to the original value while the 28 upper address bits (0x1234567x) retain their original value. In this example the source address is set to 0x12345670, the offset is set to 4 bytes, and the MOD field is set to 4, allowing for a 2^4 byte (16-byte) size queue.

Table 18-6. Modulo example

Transfer number	Address
1	0x12345670
2	0x12345674
3	0x12345678
4	0x1234567C
5	0x12345670
6	0x12345674

18.5.5 Monitoring transfer descriptor status

This section discusses how to monitor eDMA status.

18.5.5.1 Testing for minor loop completion

There are two methods to test for minor loop completion when using software-initiated service requests. The first is to read the `TCDn_CITER` field and test for a change. Another method may be extracted from the sequence shown below. The second method is to test `TCDn_CSR[START]` and `TCDn_CSR[ACTIVE]`. The minor-loop-complete condition is indicated by both bits reading zero after `TCDn_CSR[START]` was set. Polling the `TCDn_CSR[ACTIVE]` bit may be inconclusive, because the active status may be missed if the channel execution is short in duration.

The TCD status bits execute the following sequence for a software activated channel:

Stage	TCDn_CSR bits			State
	START	ACTIVE	DONE	
1	1	0	0	Channel service request via software
2	0	1	0	Channel is executing
3a	0	0	0	Channel has completed the minor loop and is idle
3b	0	0	1	Channel has completed the major loop and is idle

The best method to test for minor-loop completion when using service requests initiated by hardware, that is, peripherals, is to read the `TCDn_CITER` field and test for a change. The hardware request and acknowledge handshake signals are not visible in the programmer's model.

The TCD status bits execute the following sequence for a hardware-activated channel:

Stage	TCD _n _CSR bits			State
	START	ACTIVE	DONE	
1	0	0	0	Channel service request via hardware (peripheral request asserted)
2	0	1	0	Channel is executing
3a	0	0	0	Channel has completed the minor loop and is idle
3b	0	0	1	Channel has completed the major loop and is idle

For both activation types, the major-loop-complete status is explicitly indicated via the TCD_n_CSR[DONE] bit.

The TCD_n_CSR[START] bit is cleared automatically when the channel begins execution regardless of how the channel activates.

18.5.5.2 Reading the transfer descriptors of active channels

The eDMA reads back the true TCD_n_SADDR, TCD_n_DADDR, and TCD_n_NBYTES values if read when a channel executes. The true values of SADDR, DADDR, and NBYTES are the values the eDMA engine currently uses in its internal register file and not the values in the TCD local memory for that channel. The addresses, SADDR and DADDR, and NBYTES, which decrement to zero as the transfer progresses, can give an indication of the progress of the transfer. All other values are read back from the TCD local memory.

18.5.5.3 Checking channel preemption status

Preemption is available only when fixed arbitration is selected as the channel arbitration mode. A preemptive situation is one in which a preempt-enabled channel runs and a higher priority request becomes active. When the eDMA engine is not operating in fixed channel arbitration mode, determination of the actively running relative priority outstanding requests become undefined. Channel priorities are treated as equal, that is, constantly rotating, when Round-Robin Arbitration mode is selected.

The TCD_n_CSR[ACTIVE] bit for the preempted channel remains asserted throughout the preemption. The preempted channel is temporarily suspended while the preempting channel executes one major loop iteration. If two TCD_n_CSR[ACTIVE] bits are set simultaneously in the global TCD map, a higher priority channel is actively preempting a lower priority channel.

18.5.6 Channel linking

Channel linking (or chaining) is a mechanism where one channel sets the TCD_n_CSR[START] bit of another channel (or itself), thus initiating a service request for that channel. When properly enabled, the EDMA engine automatically performs this operation at the major or minor loop completion.

The minor loop channel linking occurs at the completion of the minor loop (or one iteration of the major loop). The TCD_n_CITER[ELINK] field determines whether a minor loop link is requested. When enabled, the channel link is made after each iteration of the major loop except for the last. When the major loop is exhausted, only the major loop channel link fields are used to determine if a channel link should be made. For example, the initial fields of:

```
TCDn_CITER[ELINK] = 1
TCDn_CITER[LINKCH] = 0xC
TCDn_CITER[CITER] value = 0x4
TCDn_CSR[MAJOR_ELINK] = 1
TCDn_CSR[MAJOR_LINKCH] = 0x3
```

executes as:

1. Minor loop done → set TCD2_CSR[START] bit.
2. Minor loop done → set TCD2_CSR[START] bit.
3. Minor loop done → set TCD2_CSR[START] bit.
4. Minor loop done, major loop done → set TCD3_CSR[START] bit.

When minor loop linking is enabled (TCD_n_CITER[ELINK] = 1), the TCD_n_CITER[CITER] field uses a nine-bit vector to form the current iteration count. When minor loop linking is disabled (TCD_n_CITER[ELINK] = 0), the TCD_n_CITER[CITER] field uses a 15-bit vector to form the current iteration count. The bits associated with the TCD_n_CITER[LINKCH] field are concatenated onto the CITER value to increase the range of the CITER.

Note

The TCD_n_CITER[ELINK] bit and the TCD_n_BITER[ELINK] bit must be equal or a configuration error is reported. The CITER and BITER vector widths must be equal to calculate the major loop, half-way done interrupt point.

The following table summarizes how a DMA channel can link to another DMA channel, that is, use another channel's TCD, at the end of a loop.

Table 18-7. Channel linking parameters

Desired link behavior	TCD control field name	Description
Link at end of minor loop	CITER[ELINK]	Enable channel-to-channel linking on minor loop completion (current iteration)
	CITER[LINKCH]	Link channel number when linking at end of minor loop (current iteration)
Link at end of major loop	CSR[MAJOR_ELINK]	Enable channel-to-channel linking on major loop completion
	CSR[MAJOR_LINKCH]	Link channel number when linking at end of major loop

18.5.7 Dynamic programming

This section provides recommended methods to change the programming model during channel execution.

18.5.7.1 Dynamically changing the channel priority

The following two options are recommended for dynamically changing channel priority levels:

1. Switch to Round-Robin Channel Arbitration mode, change the channel priorities, then switch back to Fixed Arbitration mode
2. Disable all the channels, change the channel priorities, then enable the appropriate channels.

18.5.7.2 Dynamic channel linking

Dynamic channel linking is the process of setting [TCDn_CSR\[MAJORELINK\]](#) during channel execution (see the diagram in [TCD structure](#)). This field is read from the TCD local memory at the end of channel execution, thus enabling you to enable the feature during channel execution.

Because you can change the configuration during execution, a coherency model is needed. Consider the scenario where you attempt to execute a dynamic channel link by enabling [TCDn_CSR\[MAJORELINK\]](#) at the same time the eDMA engine is retiring the channel. [TCDn_CSR\[MAJORELINK\]](#) would be set in the programmer's model, but it would be unclear whether the actual link was made before the channel retired.

The following coherency model is recommended when executing a dynamic channel link request.

1. Write one to TCDn_CSR[MAJORELINK].
2. Read back TCDn_CSR[MAJORELINK].
3. Test the TCDn_CSR[MAJORELINK] request status:
 - If TCDn_CSR[MAJORELINK] = 1, the dynamic link attempt was successful.
 - If TCDn_CSR[MAJORELINK] = 0, the attempted dynamic link did not succeed (the channel was already retiring).

For this request, the TCD local memory controller forces TCDn_CSR[MAJORELINK] to zero on any writes to a channel's TCD.word7 after that channel's TCD.done bit is set, indicating the major loop is complete.

NOTE

You must clear [TCDn_CSR\[DONE\]](#) before writing TCDn_CSR[MAJORELINK]. The eDMA engine automatically clears TCDn_CSR[DONE] after a channel begins execution.

18.5.7.3 Dynamic scatter/gather

Scatter/gather is the process of automatically loading a new TCD into a channel. It enables a DMA channel to use multiple TCDs; this enables a DMA channel to scatter the DMA data to multiple destinations or gather it from multiple sources. When scatter/gather is enabled and the channel has finished its major loop, a new TCD is fetched from system memory and loaded into that channel's descriptor location in eDMA programmer's model, thus replacing the current descriptor.

Because you are able to change the configuration during execution, a coherency model is needed. Consider the scenario where you attempt to execute a dynamic scatter/gather operation by enabling the [TCDn_CSR\[ESG\]](#) bit at the same time the eDMA engine is retiring the channel. The ESG bit would be set in the programmer's model, but it would be unclear whether the actual scatter/gather request was honored before the channel retired.

Two methods for this coherency model are shown in the following subsections. Method 1 has the advantage of reading the MAJORLINKCH field and the ESG bit with a single read. For both dynamic channel linking and scatter/gather requests, the TCD local memory controller forces the TCD MAJOR[ELINK] and ESG bits to zero on any writes to a channel's TCD word 7 if that channel's TCD[DONE] bit is set, indicating the major loop is complete.

NOTE

The user must clear the `TCDn_CSR[DONE]` bit before writing the MAJORELINK or ESG bits. The `TCDn_CSR[DONE]` bit is cleared automatically by the eDMA engine after a channel begins execution.

18.5.7.3.1 Method 1 (channel not using major loop channel linking)

For a channel not using major loop channel linking, the coherency model described here may be used for a dynamic scatter/gather request.

When `TCDn_CSR[MAJORELINK]` is zero, `TCDn_CSR[MAJORLINKCH]` is not used by the eDMA. In this case, MAJORLINKCH may be used for other purposes. This method uses the MAJORLINKCH field as a TCD identification (ID).

1. When the descriptors are built, write a unique TCD ID in `TCDn_CSR[MAJORLINKCH]` for each TCD associated with a channel using dynamic scatter/gather.
2. Write one to `TCDn_CSR[DREQ]`.

Should a dynamic scatter/gather attempt fail, setting the DREQ bit prevents a future hardware activation of the channel. This stops the channel from executing with a destination address (DADDR) that was calculated using a scatter/gather address (written in the next step) instead of a `DLAST_SGA` final offset value.

3. Write the `TCDn_DLASTSGA` register with the scatter/gather address.
4. Write one to `TCDn_CSR[ESG]`.
5. Read back the 16-bit TCD control/status field.
6. Test the ESG request status and MAJORLINKCH value in the `TCDn_CSR` register:

If $ESG = 1$, the dynamic link attempt was successful.

If $ESG = 0$ and MAJORLINKCH (ID) did not change, the attempted dynamic link did not succeed (the channel was already retiring).

If $ESG = 0$ and MAJORLINKCH (ID) changed, the dynamic link attempt was successful (the new TCD's ESG value cleared the ESG bit).

18.5.7.3.2 Method 2 (channel using major loop channel linking)

For a channel using major loop channel linking, the coherency model described here may be used for a dynamic scatter/gather request. This method uses the `TCD[DLAST_SGA]` field as a TCD identification (ID).

1. Write one to `TCDn_CSR[DREQ]`.

Should a dynamic scatter/gather attempt fail, setting TCDn_CSR[DREQ] prevents a future hardware activation of the channel. This stops the channel from executing with a destination address (DADDR) that was calculated using a scatter/gather address (written in the next step) instead of a DLAST_SGA final offset value.

2. Write the **TCDn_DLAST_SGA** register with the scatter/gather address.
3. Write one to TCDn_CSR[ESG].
4. Read back TCDn_CSR[ESG].
5. Test the ESG request status:

If ESG = 1, the dynamic link attempt was successful.

If ESG = 0, read the 32-bit TCDn_DLAST_SGA field.

If ESG = 0 and TCDn_DLAST_SGA did not change, the attempted dynamic link did not succeed (the channel was already retiring).

If ESG = 0 and TCDn_DLAST_SGA changed, the dynamic link attempt was successful (the new TCD's ESG value cleared the ESG bit).

18.5.8 Suspend/resume a DMA channel with active hardware service requests

The DMA enables you to move data from memory or peripheral registers to another location in memory or peripheral registers without CPU interaction. After the DMA and peripherals have been configured and are active, it is rare to suspend a peripheral's service request dynamically. In this scenario, there are certain restrictions to disabling a DMA hardware service request. For coherency, a specific procedure must be followed. This section provides guidance on how to coherently suspend and resume a Direct Memory Access (DMA) channel when the DMA is triggered by a slave module such as the Serial Peripheral Interface (SPI), ADC, or other module.

18.5.8.1 Suspend an active DMA channel

To suspend an active DMA channel:

1. Stop the DMA service request at the peripheral first. Confirm it has been disabled by reading back the appropriate register in the peripheral.
2. Check the DMA's Hardware Request Status register (DMA_HRSn) to ensure there is no service request to the DMA channel being suspended. Then disable the hardware service request by clearing the ERQ bit on appropriate DMA channel.

18.5.8.2 Resume a DMA channel

To resume a DMA channel:

1. Enable the DMA service request on the appropriate channel by setting the relevant ERQ bit.
2. Enable the DMA service request at the peripheral.

For example, assume the SPI is set as a master for transmitting data via a DMA service request when the SPI_TXFIFO has an empty slot. The DMA transfers the next command and data to the TXFIFO upon the request. You must suspend the DMA/SPI transfer loop and perform the following steps:

1. Disable the DMA service request at the source by writing zero to SPI_RSER[TFFF_RE]. Confirm that SPI_RSER[TFFF_RE] is zero.
2. Ensure there is no DMA service request from the SPI by verifying that DMA_HRS[HRS n] is zero for the appropriate channel. If no service request is present, disable the DMA channel by clearing the channel's ERQ bit. If a service request is present, wait until the request has been processed and the HRS bit reads zero.

Chapter 19

Trigger MUX Control (TRGMUX)

19.1 Chip-specific TRGMUX information

19.1.1 Module interconnectivity

The TRGMUX provides an extremely flexible mechanism for connecting various trigger sources to multiple pins/peripherals.

See [Figure 19-2](#) and [Figure 19-3](#) for available input triggers.

With the TRGMUX, each peripheral that accepts external triggers usually has one specific 32-bit trigger control register. Each control register supports up to four triggers, and each trigger can be selected from the available input triggers.

The following figure shows the main structure of TRGMUX, using Module_A as an example.

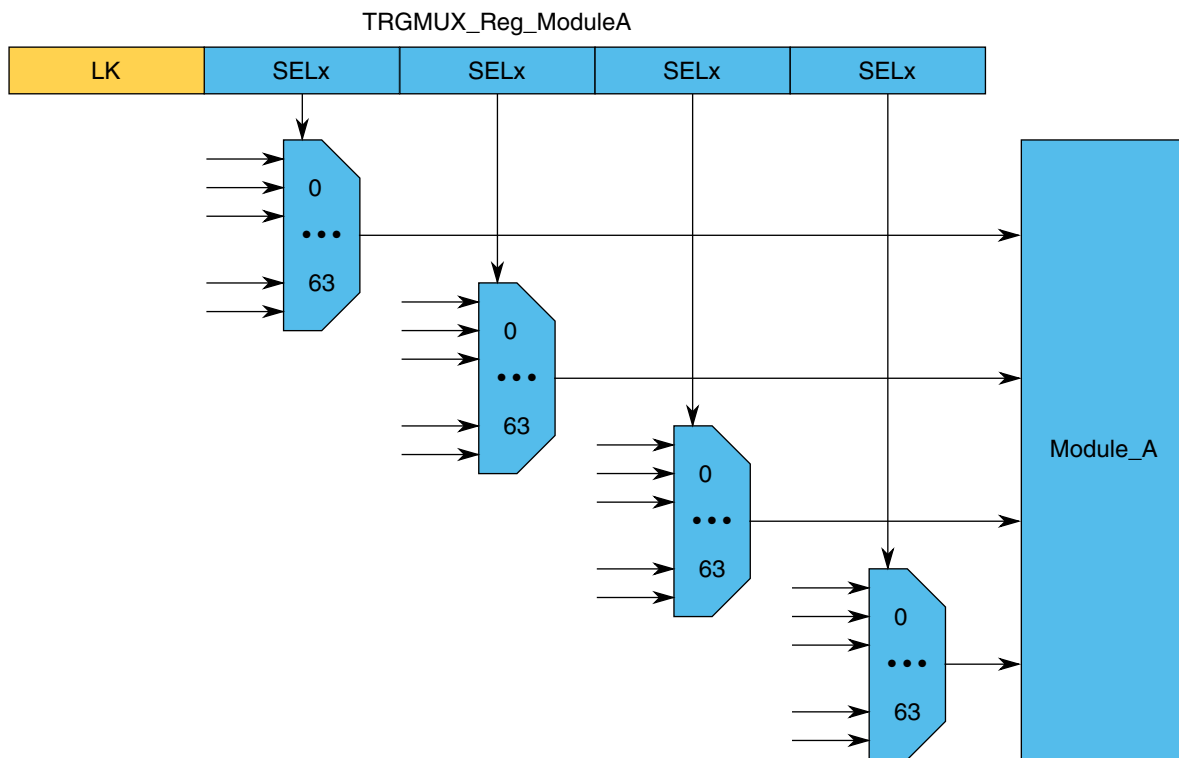

Figure 19-1. TRGMUX structure example (64 inputs)

NOTE

Each TRGMUX control register supports up to four trigger channels, but each module does not necessarily implement all four triggers. Modules that need more than four trigger inputs (such as for external output) have multiple control registers.

The following figures show the superset of trigger inputs, outputs, and control registers for the S32K1xx series. See attached S32K1xx_Trigger_Muxing.xlsx for details on recommendations which must be adhered while using the triggering scheme.

Trigger Source	TRGMUX					Target Module		
	IN	Pre-TRIG IN	Register	Pre-TRIG OUT	OUT			
1'b0	in0		TRGMUX_DMAMUX0		out0	DMA_CH0		
1'b1	in1				out1	DMA_CH1		
TRGMUX_IN0	in2				out2	DMA_CH2		
TRGMUX_IN1	in3		TRGMUX_EXTOUT0		out3	DMA_CH3		
TRGMUX_IN2	in4				out4	TRGMUX_OUT0		
TRGMUX_IN3	in5				out5	TRGMUX_OUT1		
TRGMUX_IN4	in6				out6	TRGMUX_OUT2		
TRGMUX_IN5	in7				out7	TRGMUX_OUT3		
TRGMUX_IN6	in8				out8	TRGMUX_OUT4		
TRGMUX_IN7	in9			TRGMUX_EXTOUT1		out9	TRGMUX_OUT5	
TRGMUX_IN8	in10				out10	TRGMUX_OUT6		
TRGMUX_IN9	in11				out11	TRGMUX_OUT7		
TRGMUX_IN10	in12		TRGMUX_ADC0		Y	out12	ADC Trigger Latching and Arbitration Unit ¹	
TRGMUX_IN11	in13				out13	ADC0_ADHWT		
CMP0_COUT	in14				out14			ADC1_ADHWT
					out15			
				out16	ADC1_ADHWT			
LPIT_CH0	in17	Y	TRGMUX_ADC1	Y		out17	ADC Trigger Latching and Arbitration Unit ¹	
LPIT_CH1	in18	Y				Y		out18
LPIT_CH2	in19	Y				Y		out19
LPIT_CH3	in20	Y			Y	out20		
LPTMR0	in21				out21	X		
FTM0_INIT_TRIG	in22				out22	X		
FTM0_EXT_TRIG	in23				out23	X		
FTM1_INIT_TRIG	in24				out24	X		
FTM1_EXT_TRIG	in25				out25	X		
FTM2_INIT_TRIG	in26				out26	X		
FTM2_EXT_TRIG	in27				out27	X		
FTM3_INIT_TRIG	in28		TRGMUX_CMP0		out28	CMP0_SAMPLE		
FTM3_EXT_TRIG	in29					out29	X	
ADC0_SC1A(COCO)	in30					out30	X	
ADC0_SC1B(COCO)	in31				out31	X		
ADC1_SC1A(COCO)	in32				out32	X		
ADC1_SC1B(COCO)	in33				out33	X		
PDB0_CH0_TRIG	in34				out34	X		
					out35	X		
PDB0_PULSE_OUT	in36				out36	X		
PDB1_CH0_TRIG	in37				out37	X		
					out38	X		
PDB1_PULSE_OUT	in39				out39	X		
			TRGMUX_FTM0		out40	FTM0_HWTRIG0		
						out41	FTM0_FAULT0	
						out42	FTM0_FAULT1	
						out43	FTM0_FAULT2	
RTC_alarm ²	in43		TRGMUX_FTM1		out44	FTM1_HWTRIG0		
RTC_second ²	in44					out45	FTM1_FAULT0	
FlexIO_TRIG0	in45					out46	FTM1_FAULT1	
FlexIO_TRIG1	in46					out47	FTM1_FAULT2	
FlexIO_TRIG2	in47				out48	FTM2_HWTRIG0		
FlexIO_TRIG3	in48				out49	FTM2_FAULT0		
LPUART0_RX_data	in49		TRGMUX_FTM2		out50	FTM2_FAULT1		
LPUART0_TX_data	in50					out51	FTM2_FAULT2	
LPUART0_RX_idle	in51					out52	FTM3_HWTRIG0	
LPUART1_RX_data	in52		TRGMUX_FTM3		out53	FTM3_FAULT0		
LPUART1_TX_data	in53					out54	FTM3_FAULT1	
LPUART1_RX_idle	in54					out55	FTM3_FAULT2	
LPI2C0_Master_trigger	in55		TRGMUX_PDB0		out56	PDB0_trigger_in0		
LPI2C0_Slave_trigger	in56					out57	X	
						out58	X	
						out59	X	
LPSPi0_Frame	in59		TRGMUX_PDB1		out60	PDB1_trigger_in0		
LPSPi0_RX_data	in60					out61	X	
LPSPi1_Frame	in61					out62	X	
LPSPi1_RX_data	in62					out63	X	
SIM_SW_TRIG	in63							
Reserved	in64							
Reserved	in65							
Reserved	in66							
LPI2C1_Master_TRIG	in67							
LPI2C1_Slave_TRIG	in68							
FTM4_INIT_TRIG	in69							
FTM4_EXT_TRIG	in70							
FTM5_INIT_TRIG	in71							
FTM5_EXT_TRIG	in72							
FTM6_INIT_TRIG	in73							
FTM6_EXT_TRIG	in74							
FTM7_INIT_TRIG	in75							
FTM7_EXT_TRIG	in76							
Reserved	in77							
Reserved	in78							
Reserved	in79							
Reserved	in80							

1 In the ADC Configuration chapter, see the "Trigger Latching and Arbitration" section for details.
 2 Interrupt enable needs to be configured before expecting RTC_alarm and RTC_second trigger from TRGMUX.

Figure 19-2. Trigger interconnectivity (part 1 of 2: outputs 0-63)
 S32K1xx Series Reference Manual, Rev. 14, 09/2021

Chip-specific TRGMUX information

Trigger Source	TRGMUX					Target Module	
	IN	Pre-TRIG IN	Register	Pre-TRIG OUT	OUT		
1'b0	in0				out64	X	
1'b1	in1				out65	X	
TRGMUX_IN0	in2				out66	X	
TRGMUX_IN1	in3				out67	X	
TRGMUX_IN2	in4		TRGMUX_FLEXIO		out68		FlexIO_TRG_TIM0
TRGMUX_IN3	in5				out69		FlexIO_TRG_TIM1
TRGMUX_IN4	in6				out70		FlexIO_TRG_TIM2
TRGMUX_IN5	in7				out71		FlexIO_TRG_TIM3
TRGMUX_IN6	in8		TRGMUX_LPIT0		out72		LPIT_TRG_CH0
TRGMUX_IN7	in9				out73		LPIT_TRG_CH1
TRGMUX_IN8	in10				out74		LPIT_TRG_CH2
TRGMUX_IN9	in11			out75		LPIT_TRG_CH3	
TRGMUX_IN10	in12		TRGMUX_LPUART0		out76		LPUART0_TRG
TRGMUX_IN11	in13				out77	X	
CMP0_COUT	in14			out78	X		
				out79	X		
			TRGMUX_LPUART1		out80		LPUART1_TRG
LPIT_CH0	in17	Y			out81	X	
LPIT_CH1	in18	Y			out82	X	
LPIT_CH2	in19	Y		out83	X		
LPIT_CH3	in20	Y	TRGMUX_LPI2C0		out84		LPI2C0_TRG
LPTMR0	in21				out85	X	
FTM0_INIT_TRIG	in22			out86	X		
FTM0_EXT_TRIG	in23			out87	X		
FTM1_INIT_TRIG	in24			out88	X		
FTM1_EXT_TRIG	in25			out89	X		
FTM2_INIT_TRIG	in26			out90	X		
FTM2_EXT_TRIG	in27			out91	X		
FTM3_INIT_TRIG	in28		TRGMUX_LPSP10		out92		LPSP10_TRG
FTM3_EXT_TRIG	in29				out93	X	
ADC0_SC1A[COCO]	in30			out94	X		
ADC0_SC1B[COCO]	in31			out95	X		
ADC1_SC1A[COCO]	in32		TRGMUX_LPSP11		out96		LPSP11_TRG
ADC1_SC1B[COCO]	in33				out97	X	
PDB0_CH0_TRIG	in34			out98	X		
				out99	X		
PDB0_PULSE_OUT	in36		TRGMUX_LPTMR0		out100		LPTMR0_ALTO
PDB1_CH0_TRIG	in37				out101	X	
					out102	X	
PDB1_PULSE_OUT	in39			out103	X		
				out104	X		
				out105	X		
				out106	X		
				out107	X		
RTC_alarm ¹	in43		TRGMUX_LPI2C1		out108		LPI2C1_TRG
RTC_second ¹	in44				out109	X	
FlexIO_TRIG0	in45				out110	X	
FlexIO_TRIG1	in46			out111	X		
FlexIO_TRIG2	in47			out112			FTM4_HWTRIG0
FlexIO_TRIG3	in48		TRGMUX_FTM4		out113	X	
LPUART0_RX_data	in49				out114	X	
LPUART0_TX_data	in50				out115	X	
LPUART0_RX_idle	in51						
LPUART1_RX_data	in52		TRGMUX_FTM5		out116		FTM5_HWTRIG0
LPUART1_TX_data	in53				out117	X	
LPUART1_RX_idle	in54				out118	X	
LPI2C0_Master_trigger	in55			out119	X		
LPI2C0_Slave_trigger	in56		TRGMUX_FTM6		out120		FTM6_HWTRIG0
					out121	X	
					out122	X	
LPSP10_Frame	in59			out123	X		
LPSP10_RX_data	in60		TRGMUX_FTM7		out124		FTM7_HWTRIG0
LPSP11_Frame	in61				out125	X	
LPSP11_RX_data	in62				out126	X	
SIM_SW_TRIG	in63			out127	X		
Reserved	in64						
Reserved	in65						
Reserved	in66						
LPI2C1_Master_TRIG	in67						
LPI2C1_Slave_TRIG	in68						
FTM4_INIT_TRIG	in69						
FTM4_EXT_TRIG	in70						
FTM5_INIT_TRIG	in71						
FTM5_EXT_TRIG	in72						
FTM6_INIT_TRIG	in73						
FTM6_EXT_TRIG	in74						
FTM7_INIT_TRIG	in75						
FTM7_EXT_TRIG	in76						
Reserved	in77						
Reserved	in78						
Reserved	in79						
Reserved	in80						

¹ Interrupt enable needs to be configured before expecting RTC_alarm and RTC_second trigger from TRGMUX.
 Note: Above figure shows all the connections. Slots for an absent instance in a particular part are Reserved.

Figure 19-3. Trigger interconnectivity (part 2 of 2: outputs 64-127)

NOTE

Additional details about ADC triggers include:

- For each ADC, the four triggers are ORed together to provide a flexible scheme for the hardware trigger of each ADC. The pretriggers are not ORed.
- Only LPIT supports pretriggers.
- If other peripherals require pretriggers, software pretriggers must be used. See `SIM_ADCCOPT[ADCxSWPRETRG]` for configuring software pretriggers.
- See [ADC Trigger Sources](#) for more information about ADC trigger implementation, including a PDB pretrigger scheme that does not involve TRGMUX.

19.1.2 TRGMUX register information

Some TRGMUX registers and input connections are present only on some S32K1xx products. Registers and input connections for instances unavailable in a particular variant are Reserved.

19.2 Introduction

The trigger multiplexer (TRGMUX) module allows software to configure the trigger inputs for various peripherals.

19.3 Features

The TRGMUX module allows software to select the trigger source for peripherals. The block diagram below shows the trigger selection logic of the TRGMUX module.

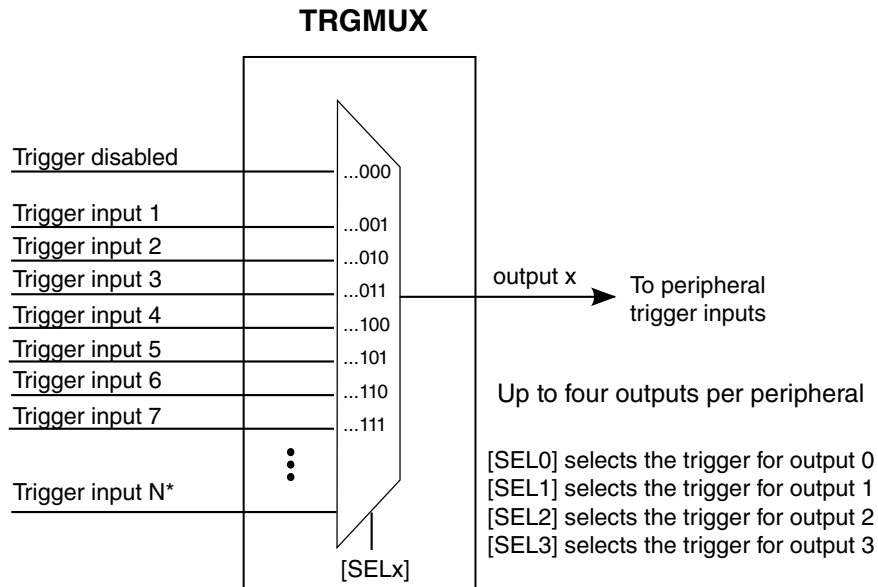

* Up to 255 trigger inputs may be available for SEL0, SEL1, and SEL2. For SEL3, up to 127 trigger inputs may be available. When the number of trigger inputs is 255, SEL3 is not available and becomes reserved. See the chip-specific TRGMUX information for the maximum number of trigger inputs supported on this device.

Figure 19-4. TRGMUX block diagram

Each peripheral has its own dedicated TRGMUX register. See each peripheral's TRGMUX register for details.

19.4 Memory map and register definition

The TRGMUX registers contain fields for selecting trigger sources for peripheral modules.

TRGMUX registers can be written only in supervisor mode.

19.4.1 TRGMUX register descriptions

19.4.1.1 TRGMUX memory map

Table 19-1. Select Bit Fields

Field	Description
SELx	This read/write field is used to configure the MUX select for the peripheral trigger inputs.

Table 19-1. Select Bit Fields

Field	Description
0000_0000 - (0x00) -	
0000_0001 - (0x01) VDD	
0000_0010 - (0x02) TRGMUX_IN0	
0000_0011 - (0x03) TRGMUX_IN1	
0000_0100 - (0x04) TRGMUX_IN2	
0000_0101 - (0x05) TRGMUX_IN3	
0000_0110 - (0x06) TRGMUX_IN4	
0000_0111 - (0x07) TRGMUX_IN5	
0000_1000 - (0x08) TRGMUX_IN6	
0000_1001 - (0x09) TRGMUX_IN7	
0000_1010 - (0x0A) TRGMUX_IN8	
0000_1011 - (0x0B) TRGMUX_IN9	
0000_1100 - (0x0C) TRGMUX_IN10	
0000_1101 - (0x0D) TRGMUX_IN11	
0000_1110 - (0x0E) CMP0_OUT	
0000_1111 - (0x0F) Reserved	
0001_0000 - (0x10) Reserved	
0001_0001 - (0x11) LPIT_CH0	
0001_0010 - (0x12) LPIT_CH1	
0001_0011 - (0x13) LPIT_CH2	
0001_0100 - (0x14) LPIT_CH3	
0001_0101 - (0x15) LPTMR0	
0001_0110 - (0x16) FTM0_INIT_TRIG	
0001_0111 - (0x17) FTM0_EXT_TRIG	
0001_1000 - (0x18) FTM1_INIT_TRIG	
0001_1001 - (0x19) FTM1_EXT_TRIG	
0001_1010 - (0x1A) FTM2_INIT_TRIG	
0001_1011 - (0x1B) FTM2_EXT_TRIG	
0001_1100 - (0x1C) FTM3_INIT_TRIG	
0001_1101 - (0x1D) FTM3_EXT_TRIG	
0001_1110 - (0x1E) ADC0_SC1A[COCO]	
0001_1111 - (0x1F) ADC0_SC1B[COCO]	
0010_0000 - (0x20) ADC1_SC1A[COCO]	
0010_0001 - (0x21) ADC1_SC1B[COCO]	
0010_0010 - (0x22) PDB0_CH0_TRIG	
0010_0011 - (0x23) Reserved	
0010_0100 - (0x24) PDB0_PULSE_OUT	
0010_0101 - (0x25) PDB1_CH0_TRIG	

Table 19-1. Select Bit Fields

Field	Description
0010_0110 - (0x26)	Reserved
0010_0111 - (0x27)	PDB1_PULSE_OUT
0010_1000 - (0x28)	Reserved
0010_1001 - (0x29)	Reserved
0010_1010 - (0x2A)	Reserved
0010_1011 - (0x2B)	RTC_alarm
0010_1100 - (0x2C)	RTC_second
0010_1101 - (0x2D)	FlexIO_TRIG0
0010_1110 - (0x2E)	FlexIO_TRIG1
0010_1111 - (0x2F)	FlexIO_TRIG2
0011_0000 - (0x30)	FlexIO_TRIG3
0011_0001 - (0x31)	LPUART0_RX_data
0011_0010 - (0x32)	LPUART0_TX_data
0011_0011 - (0x33)	LPUART0_RX_idle
0011_0100 - (0x34)	LPUART1_RX_data
0011_0101 - (0x35)	LPUART1_TX_data
0011_0110 - (0x36)	LPUART1_RX_idle
0011_0111 - (0x37)	LPI2C0_Master_trigger
0011_1000 - (0x38)	LPI2C0_Slave_trigger
0011_1001 - (0x39)	Reserved
0011_1010 - (0x3A)	Reserved
0011_1011 - (0x3B)	LPSPi0_Frame
0011_1100 - (0x3C)	LPSPi0_RX_data
0011_1101 - (0x3D)	LPSPi1_Frame
0011_1110 - (0x3E)	LPSPi1_RX_data
0011_1111 - (0x3F)	SIM_SW_TRIG
0100_0000 - (0x40)	Reserved
0100_0001 - (0x41)	Reserved
0100_0010 - (0x42)	Reserved
0100_0011 - (0x43)	LPI2C1_Master_trigger
0100_0100 - (0x44)	LPI2C1_Slave_trigger
0100_0101 - (0x45)	FTM4_INIT_TRIG
0100_0110 - (0x46)	FTM4_EXT_TRIG
0100_0111 - (0x47)	FTM5_INIT_TRIG
0100_1000 - (0x48)	FTM5_EXT_TRIG
0100_1001 - (0x49)	FTM6_INIT_TRIG
0100_1010 - (0x4A)	FTM6_EXT_TRIG
0100_1011 - (0x4B)	FTM7_INIT_TRIG

Table 19-1. Select Bit Fields

Field	Description
	0100_1100 - (0x4C) FTM7_EXT_TRIG
	0100_1101 - (0x4D) Reserved
	0100_1110 - (0x4E) Reserved
	0100_1111 - (0x4F) Reserved
	0101_0000 - (0x50) Reserved
	0101_0001 - (0x51) Reserved
	0101_0010 - (0x52) Reserved
	0101_0011 - (0x53) Reserved
	0101_0100 - (0x54) Reserved
	0101_0101 - (0x55) Reserved
	0101_0110 - (0x56) Reserved
	0101_0111 - (0x57) Reserved
	0101_1000 - (0x58) Reserved
	0101_1001 - (0x59) Reserved
	0101_1010 - (0x5A) Reserved
	0101_1011 - (0x5B) Reserved
	0101_1100 - (0x5C) Reserved
	0101_1101 - (0x5D) Reserved
	0101_1110 - (0x5E) Reserved
	0101_1111 - (0x5F) Reserved
	0110_0000 - (0x60) Reserved
	0110_0001 - (0x61) Reserved
	0110_0010 - (0x62) Reserved
	0110_0011 - (0x63) Reserved
	0110_0100 - (0x64) Reserved
	0110_0101 - (0x65) Reserved
	0110_0110 - (0x66) Reserved
	0110_0111 - (0x67) Reserved
	0110_1000 - (0x68) Reserved
	0110_1001 - (0x69) Reserved
	0110_1010 - (0x6A) Reserved
	0110_1011 - (0x6B) Reserved
	0110_1100 - (0x6C) Reserved
	0110_1101 - (0x6D) Reserved
	0110_1110 - (0x6E) Reserved
	0110_1111 - (0x6F) Reserved
	0111_0000 - (0x70) Reserved
	0111_0001 - (0x71) Reserved

Table 19-1. Select Bit Fields

Field	Description
	0111_0010 - (0x72) Reserved
	0111_0011 - (0x73) Reserved
	0111_0100 - (0x74) Reserved
	0111_0101 - (0x75) Reserved
	0111_0110 - (0x76) Reserved
	0111_0111 - (0x77) Reserved
	0111_1000 - (0x78) Reserved
	0111_1001 - (0x79) Reserved
	0111_1010 - (0x7A) Reserved
	0111_1011 - (0x7B) Reserved
	0111_1100 - (0x7C) Reserved
	0111_1101 - (0x7D) Reserved
	0111_1110 - (0x7E) Reserved
	0111_1111 - (0x7F) Reserved

TRGMUX base address: 4006_3000h

Offset	Register	Width (In bits)	Access	Reset value
0h	TRGMUX DMAMUX0 Register (DMAMUX0)	32	RW	0000_0000h
4h	TRGMUX EXTOUT0 Register (EXTOUT0)	32	RW	0000_0000h
8h	TRGMUX EXTOUT1 Register (EXTOUT1)	32	RW	0000_0000h
Ch	TRGMUX ADC0 Register (ADC0)	32	RW	0000_0000h
10h	TRGMUX ADC1 Register (ADC1)	32	RW	0000_0000h
1Ch	TRGMUX CMP0 Register (CMP0)	32	RW	0000_0000h
28h	TRGMUX FTM0 Register (FTM0)	32	RW	0000_0000h
2Ch	TRGMUX FTM1 Register (FTM1)	32	RW	0000_0000h
30h	TRGMUX FTM2 Register (FTM2)	32	RW	0000_0000h
34h	TRGMUX FTM3 Register (FTM3)	32	RW	0000_0000h
38h	TRGMUX PDB0 Register (PDB0)	32	RW	0000_0000h
3Ch	TRGMUX PDB1 Register (PDB1)	32	RW	0000_0000h
44h	TRGMUX FLEXIO Register (FLEXIO)	32	RW	0000_0000h
48h	TRGMUX LPIT0 Register (LPIT0)	32	RW	0000_0000h
4Ch	TRGMUX LPUART0 Register (LPUART0)	32	RW	0000_0000h
50h	TRGMUX LPUART1 Register (LPUART1)	32	RW	0000_0000h
54h	TRGMUX LPI2C0 Register (LPI2C0)	32	RW	0000_0000h
5Ch	TRGMUX LPSPi0 Register (LPSPi0)	32	RW	0000_0000h
60h	TRGMUX LPSPi1 Register (LPSPi1)	32	RW	0000_0000h

Table continues on the next page...

Offset	Register	Width (In bits)	Access	Reset value
64h	TRGMUX LPTMR0 Register (LPTMR0)	32	RW	0000_0000h
6Ch	TRGMUX LPI2C1 Register (LPI2C1)	32	RW	0000_0000h
70h	TRGMUX FTM4 Register (FTM4)	32	RW	0000_0000h
74h	TRGMUX FTM5 Register (FTM5)	32	RW	0000_0000h
78h	TRGMUX FTM6 Register (FTM6)	32	RW	0000_0000h
7Ch	TRGMUX FTM7 Register (FTM7)	32	RW	0000_0000h

19.4.1.2 TRGMUX DMAMUX0 Register (DMAMUX0)

19.4.1.2.1 Offset

Register	Offset
DMAMUX0	0h

19.4.1.2.2 Function

This register is for the DMAMUX0 module.

19.4.1.2.3 Diagram

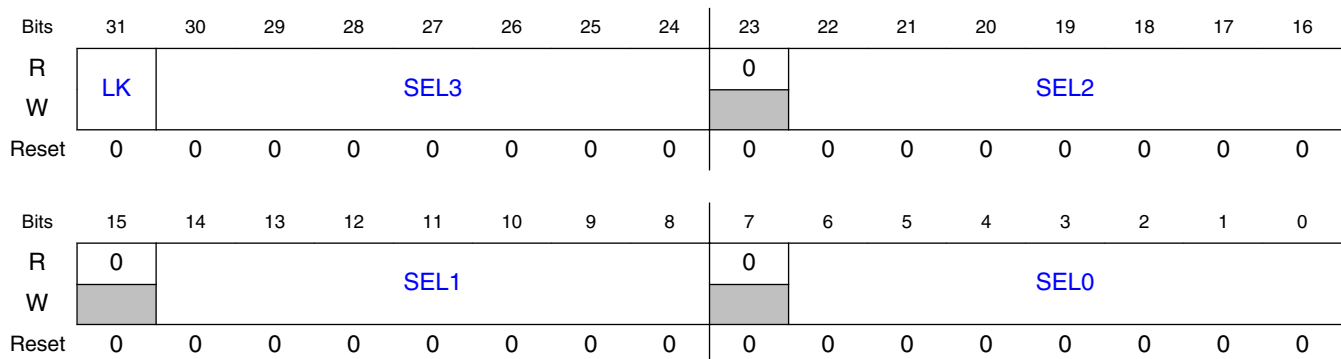

19.4.1.2.4 Fields

Field	Function
31 LK	TRGMUX register lock.

Table continues on the next page...

Memory map and register definition

Field	Function
	This bit shows whether the register can be written or not. The LK bit can only be written once after any system reset. Once LK is set, the SELx bits in this TRGMUX register cannot be changed until the next system reset clears LK. 0b - Register can be written. 1b - Register cannot be written until the next system Reset.
30-24 SEL3	Trigger MUX Input 3 Source Select This read/write bit field is used to configure the MUX select for peripheral trigger input 3. For the field setting definitions, see Memory map and register definition .
23 —	This read-only bit field is reserved and always has the value 0.
22-16 SEL2	Trigger MUX Input 2 Source Select This read/write bit field is used to configure the MUX select for peripheral trigger input 2. For the field setting definitions, see Memory map and register definition .
15 —	This read-only bit field is reserved and always has the value 0.
14-8 SEL1	Trigger MUX Input 1 Source Select This read/write bit field is used to configure the MUX select for peripheral trigger input 1. For the field setting definitions, see Memory map and register definition .
7 —	This read-only bit field is reserved and always has the value 0.
6-0 SEL0	Trigger MUX Input 0 Source Select This read/write bit field is used to configure the MUX select for peripheral trigger input 0. For the field setting definitions, see Memory map and register definition .

19.4.1.3 TRGMUX EXTOUT0 Register (EXTOUT0)

19.4.1.3.1 Offset

Register	Offset
EXTOUT0	4h

19.4.1.3.2 Function

This register is for the EXTOUT0 module.

19.4.1.3.3 Diagram

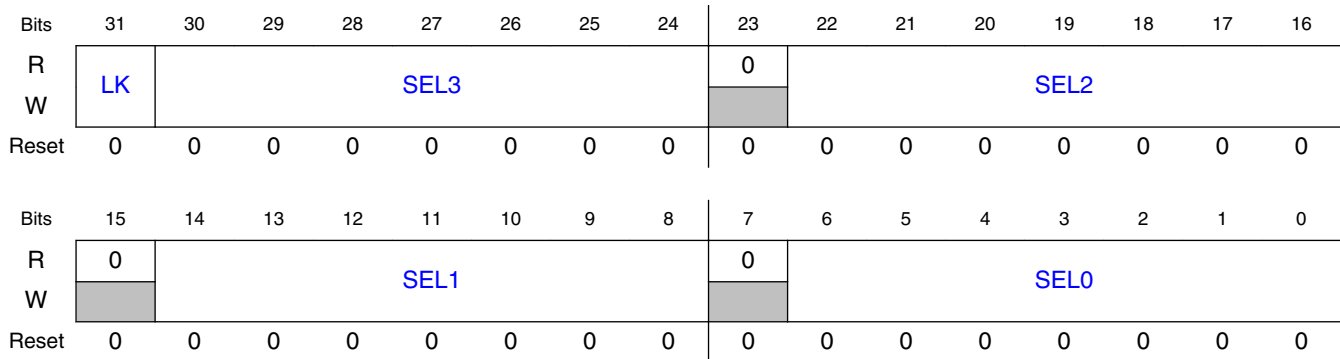

19.4.1.3.4 Fields

Field	Function
31 LK	TRGMUX register lock. This bit shows whether the register can be written or not. The LK bit can only be written once after any system reset. Once LK is set, the SELx bits in this TRGMUX register cannot be changed until the next system reset clears LK. 0b - Register can be written. 1b - Register cannot be written until the next system Reset.
30-24 SEL3	Trigger MUX Input 3 Source Select This read/write bit field is used to configure the MUX select for peripheral trigger input 3. For the field setting definitions, see Memory map and register definition .
23 —	This read-only bit field is reserved and always has the value 0.
22-16 SEL2	Trigger MUX Input 2 Source Select This read/write bit field is used to configure the MUX select for peripheral trigger input 2. For the field setting definitions, see Memory map and register definition .
15 —	This read-only bit field is reserved and always has the value 0.
14-8 SEL1	Trigger MUX Input 1 Source Select This read/write bit field is used to configure the MUX select for peripheral trigger input 1. For the field setting definitions, see Memory map and register definition .
7 —	This read-only bit field is reserved and always has the value 0.
6-0 SEL0	Trigger MUX Input 0 Source Select This read/write bit field is used to configure the MUX select for peripheral trigger input 0. For the field setting definitions, see Memory map and register definition .

19.4.1.4 TRGMUX EXTOUT1 Register (EXTOUT1)

19.4.1.4.1 Offset

Register	Offset
EXTOUT1	8h

19.4.1.4.2 Function

This register is for the EXTOUT1 module.

19.4.1.4.3 Diagram

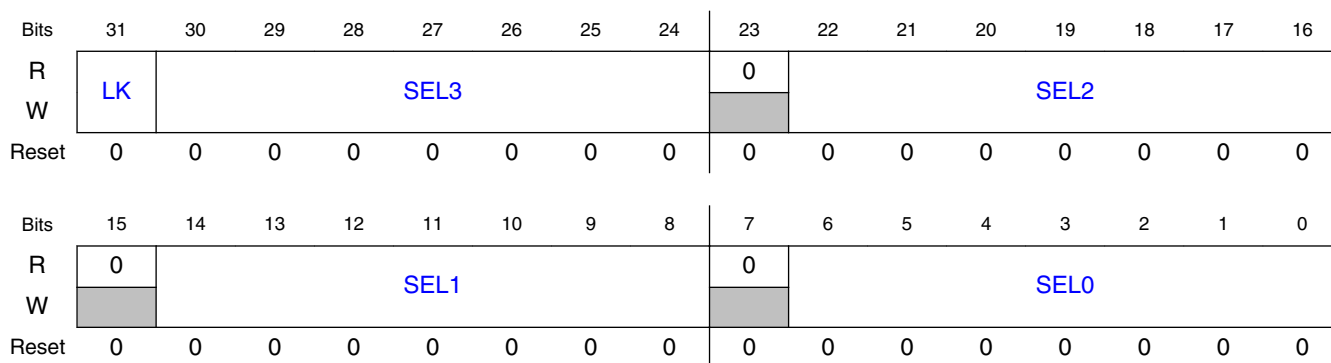

19.4.1.4.4 Fields

Field	Function
31 LK	TRGMUX register lock. This bit shows whether the register can be written or not. The LK bit can only be written once after any system reset. Once LK is set, the SELx bits in this TRGMUX register cannot be changed until the next system reset clears LK. 0b - Register can be written. 1b - Register cannot be written until the next system Reset.
30-24 SEL3	Trigger MUX Input 3 Source Select This read/write bit field is used to configure the MUX select for peripheral trigger input 3. For the field setting definitions, see Memory map and register definition .
23 —	This read-only bit field is reserved and always has the value 0.
22-16 SEL2	Trigger MUX Input 2 Source Select This read/write bit field is used to configure the MUX select for peripheral trigger input 2. For the field setting definitions, see Memory map and register definition .

Table continues on the next page...

Field	Function
15 —	This read-only bit field is reserved and always has the value 0.
14-8 SEL1	Trigger MUX Input 1 Source Select This read/write bit field is used to configure the MUX select for peripheral trigger input 1. For the field setting definitions, see Memory map and register definition .
7 —	This read-only bit field is reserved and always has the value 0.
6-0 SELO	Trigger MUX Input 0 Source Select This read/write bit field is used to configure the MUX select for peripheral trigger input 0. For the field setting definitions, see Memory map and register definition .

19.4.1.5 TRGMUX ADC0 Register (ADC0)

19.4.1.5.1 Offset

Register	Offset
ADC0	Ch

19.4.1.5.2 Function

This register is for the ADC0 module.

19.4.1.5.3 Diagram

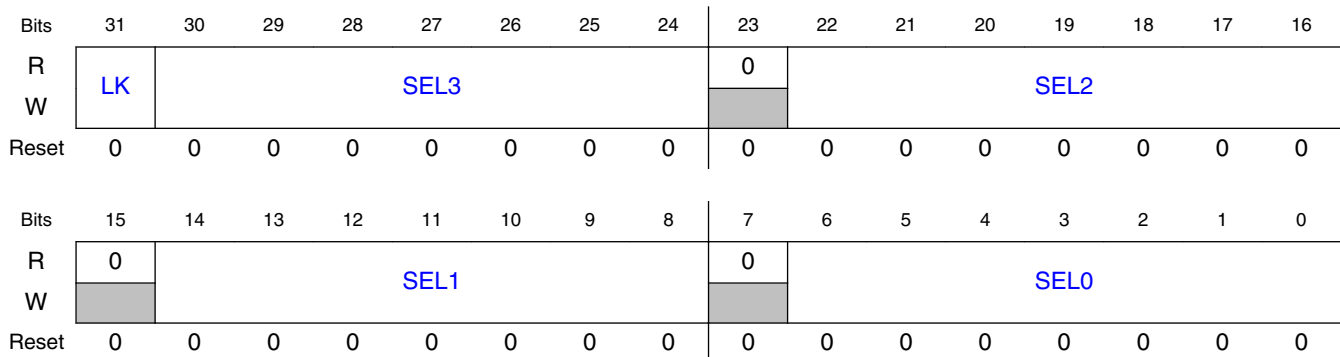

19.4.1.5.4 Fields

Field	Function
31 LK	TRGMUX register lock. This bit shows whether the register can be written or not. The LK bit can only be written once after any system reset. Once LK is set, the SELx bits in this TRGMUX register cannot be changed until the next system reset clears LK. 0b - Register can be written. 1b - Register cannot be written until the next system Reset.
30-24 SEL3	Trigger MUX Input 3 Source Select This read/write bit field is used to configure the MUX select for peripheral trigger input 3. For the field setting definitions, see Memory map and register definition .
23 —	This read-only bit field is reserved and always has the value 0.
22-16 SEL2	Trigger MUX Input 2 Source Select This read/write bit field is used to configure the MUX select for peripheral trigger input 2. For the field setting definitions, see Memory map and register definition .
15 —	This read-only bit field is reserved and always has the value 0.
14-8 SEL1	Trigger MUX Input 1 Source Select This read/write bit field is used to configure the MUX select for peripheral trigger input 1. For the field setting definitions, see Memory map and register definition .
7 —	This read-only bit field is reserved and always has the value 0.
6-0 SEL0	Trigger MUX Input 0 Source Select This read/write bit field is used to configure the MUX select for peripheral trigger input 0. For the field setting definitions, see Memory map and register definition .

19.4.1.6 TRGMUX ADC1 Register (ADC1)

19.4.1.6.1 Offset

Register	Offset
ADC1	10h

19.4.1.6.2 Function

This register is for the ADC1 module.

19.4.1.6.3 Diagram

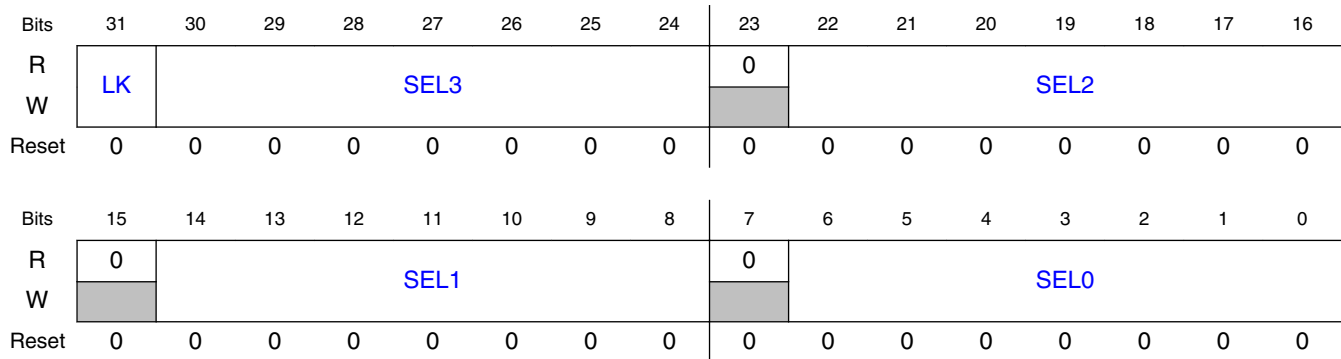

19.4.1.6.4 Fields

Field	Function
31 LK	TRGMUX register lock. This bit shows whether the register can be written or not. The LK bit can only be written once after any system reset. Once LK is set, the SELx bits in this TRGMUX register cannot be changed until the next system reset clears LK. 0b - Register can be written. 1b - Register cannot be written until the next system Reset.
30-24 SEL3	Trigger MUX Input 3 Source Select This read/write bit field is used to configure the MUX select for peripheral trigger input 3. For the field setting definitions, see Memory map and register definition .
23 —	This read-only bit field is reserved and always has the value 0.
22-16 SEL2	Trigger MUX Input 2 Source Select This read/write bit field is used to configure the MUX select for peripheral trigger input 2. For the field setting definitions, see Memory map and register definition .
15 —	This read-only bit field is reserved and always has the value 0.
14-8 SEL1	Trigger MUX Input 1 Source Select This read/write bit field is used to configure the MUX select for peripheral trigger input 1. For the field setting definitions, see Memory map and register definition .
7 —	This read-only bit field is reserved and always has the value 0.
6-0 SEL0	Trigger MUX Input 0 Source Select This read/write bit field is used to configure the MUX select for peripheral trigger input 0. For the field setting definitions, see Memory map and register definition .

19.4.1.7 TRGMUX CMP0 Register (CMP0)

19.4.1.7.1 Offset

Register	Offset
CMP0	1Ch

19.4.1.7.2 Function

This register is for the CMP0 module.

19.4.1.7.3 Diagram

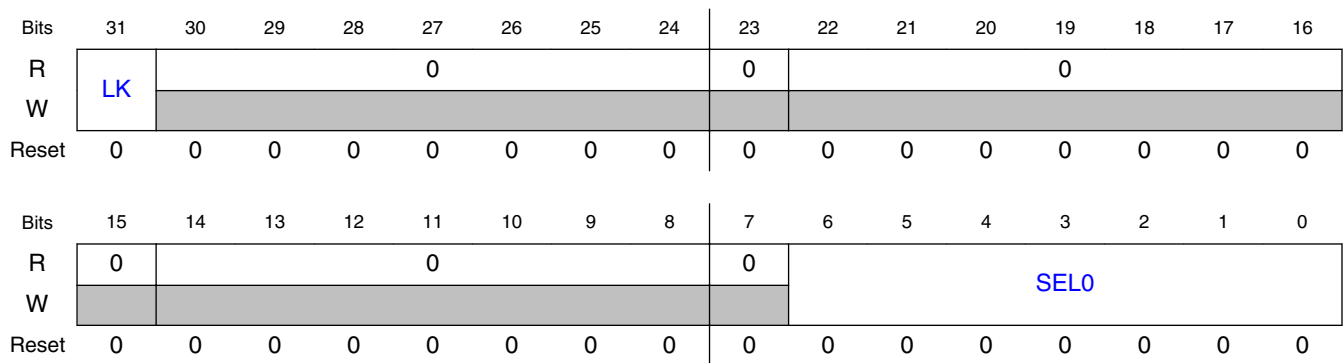

19.4.1.7.4 Fields

Field	Function
31 LK	TRGMUX register lock. This bit shows whether the register can be written or not. The LK bit can only be written once after any system reset. Once LK is set, the SELx bits in this TRGMUX register cannot be changed until the next system reset clears LK. 0b - Register can be written. 1b - Register cannot be written until the next system Reset.
30-24 —	This read-only bit field is reserved and always has the value 0.
23 —	This read-only bit field is reserved and always has the value 0.
22-16 —	This read-only bit field is reserved and always has the value 0.
15 —	This read-only bit field is reserved and always has the value 0.

Table continues on the next page...

Field	Function
14-8 —	This read-only bit field is reserved and always has the value 0.
7 —	This read-only bit field is reserved and always has the value 0.
6-0 SEL0	Trigger MUX Input 0 Source Select This read/write bit field is used to configure the MUX select for peripheral trigger input 0. For the field setting definitions, see Memory map and register definition .

19.4.1.8 TRGMUX FTM0 Register (FTM0)

19.4.1.8.1 Offset

Register	Offset
FTM0	28h

19.4.1.8.2 Function

This register is for the FTM0 module.

19.4.1.8.3 Diagram

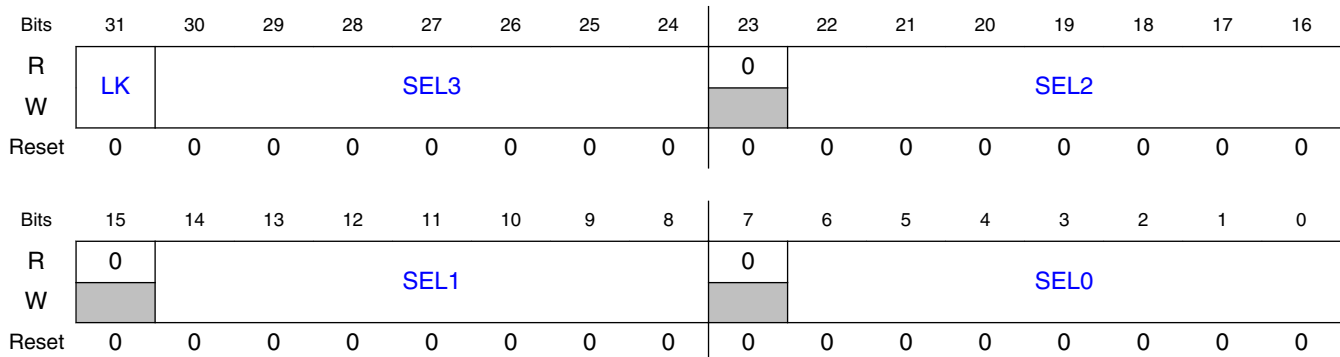

19.4.1.8.4 Fields

Field	Function
31 LK	TRGMUX register lock.

Table continues on the next page...

Memory map and register definition

Field	Function
	This bit shows whether the register can be written or not. The LK bit can only be written once after any system reset. Once LK is set, the SELx bits in this TRGMUX register cannot be changed until the next system reset clears LK. 0b - Register can be written. 1b - Register cannot be written until the next system Reset.
30-24 SEL3	Trigger MUX Input 3 Source Select This read/write bit field is used to configure the MUX select for peripheral trigger input 3. For the field setting definitions, see Memory map and register definition .
23 —	This read-only bit field is reserved and always has the value 0.
22-16 SEL2	Trigger MUX Input 2 Source Select This read/write bit field is used to configure the MUX select for peripheral trigger input 2. For the field setting definitions, see Memory map and register definition .
15 —	This read-only bit field is reserved and always has the value 0.
14-8 SEL1	Trigger MUX Input 1 Source Select This read/write bit field is used to configure the MUX select for peripheral trigger input 1. For the field setting definitions, see Memory map and register definition .
7 —	This read-only bit field is reserved and always has the value 0.
6-0 SEL0	Trigger MUX Input 0 Source Select This read/write bit field is used to configure the MUX select for peripheral trigger input 0. For the field setting definitions, see Memory map and register definition .

19.4.1.9 TRGMUX FTM1 Register (FTM1)

19.4.1.9.1 Offset

Register	Offset
FTM1	2Ch

19.4.1.9.2 Function

This register is for the FTM1 module.

19.4.1.9.3 Diagram

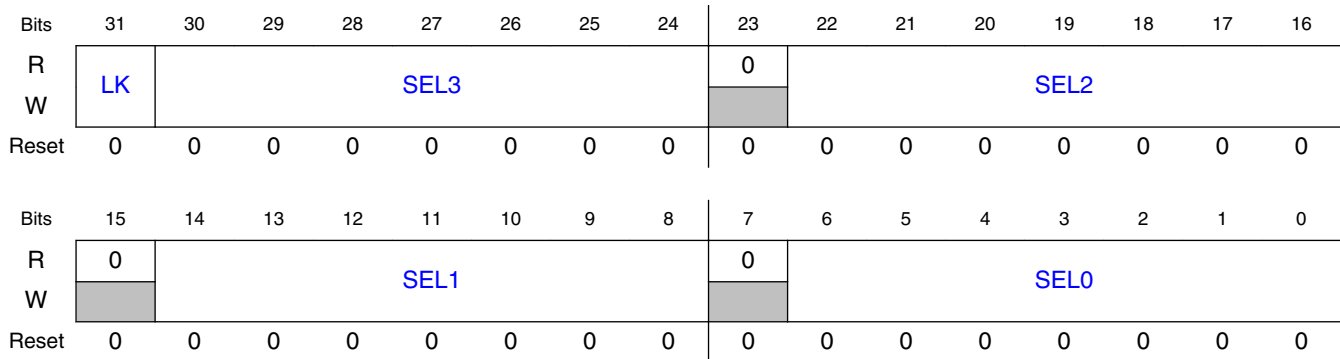

19.4.1.9.4 Fields

Field	Function
31 LK	TRGMUX register lock. This bit shows whether the register can be written or not. The LK bit can only be written once after any system reset. Once LK is set, the SELx bits in this TRGMUX register cannot be changed until the next system reset clears LK. 0b - Register can be written. 1b - Register cannot be written until the next system Reset.
30-24 SEL3	Trigger MUX Input 3 Source Select This read/write bit field is used to configure the MUX select for peripheral trigger input 3. For the field setting definitions, see Memory map and register definition .
23 —	This read-only bit field is reserved and always has the value 0.
22-16 SEL2	Trigger MUX Input 2 Source Select This read/write bit field is used to configure the MUX select for peripheral trigger input 2. For the field setting definitions, see Memory map and register definition .
15 —	This read-only bit field is reserved and always has the value 0.
14-8 SEL1	Trigger MUX Input 1 Source Select This read/write bit field is used to configure the MUX select for peripheral trigger input 1. For the field setting definitions, see Memory map and register definition .
7 —	This read-only bit field is reserved and always has the value 0.
6-0 SEL0	Trigger MUX Input 0 Source Select This read/write bit field is used to configure the MUX select for peripheral trigger input 0. For the field setting definitions, see Memory map and register definition .

19.4.1.10 TRGMUX FTM2 Register (FTM2)

19.4.1.10.1 Offset

Register	Offset
FTM2	30h

19.4.1.10.2 Function

This register is for the FTM2 module.

19.4.1.10.3 Diagram

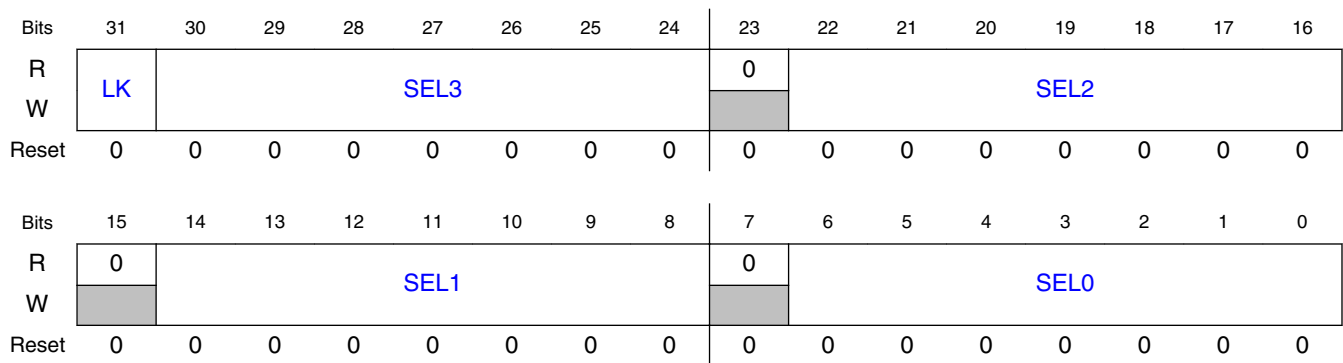

19.4.1.10.4 Fields

Field	Function
31 LK	TRGMUX register lock. This bit shows whether the register can be written or not. The LK bit can only be written once after any system reset. Once LK is set, the SELx bits in this TRGMUX register cannot be changed until the next system reset clears LK. 0b - Register can be written. 1b - Register cannot be written until the next system Reset.
30-24 SEL3	Trigger MUX Input 3 Source Select This read/write bit field is used to configure the MUX select for peripheral trigger input 3. For the field setting definitions, see Memory map and register definition .
23 —	This read-only bit field is reserved and always has the value 0.
22-16 SEL2	Trigger MUX Input 2 Source Select This read/write bit field is used to configure the MUX select for peripheral trigger input 2. For the field setting definitions, see Memory map and register definition .

Table continues on the next page...

Field	Function
15 —	This read-only bit field is reserved and always has the value 0.
14-8 SEL1	Trigger MUX Input 1 Source Select This read/write bit field is used to configure the MUX select for peripheral trigger input 1. For the field setting definitions, see Memory map and register definition .
7 —	This read-only bit field is reserved and always has the value 0.
6-0 SEL0	Trigger MUX Input 0 Source Select This read/write bit field is used to configure the MUX select for peripheral trigger input 0. For the field setting definitions, see Memory map and register definition .

19.4.1.11 TRGMUX FTM3 Register (FTM3)

19.4.1.11.1 Offset

Register	Offset
FTM3	34h

19.4.1.11.2 Function

This register is for the FTM3 module.

19.4.1.11.3 Diagram

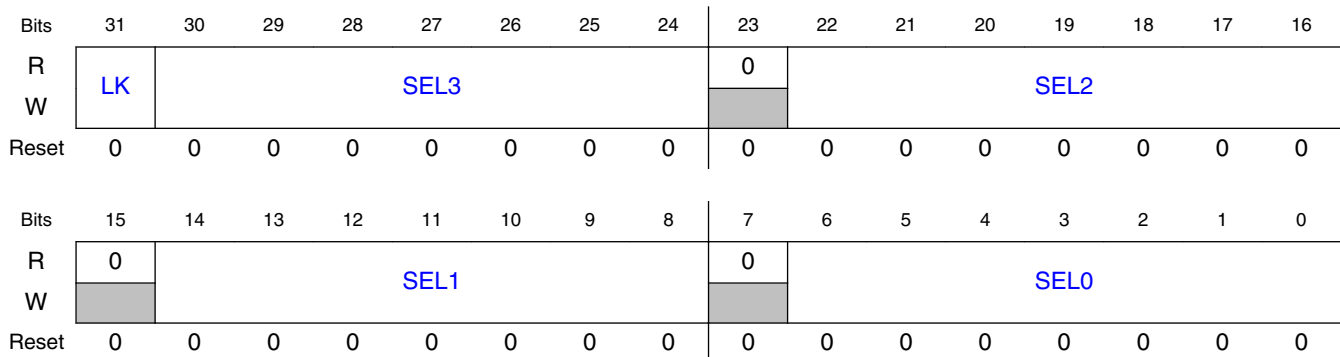

19.4.1.11.4 Fields

Field	Function
31 LK	TRGMUX register lock. This bit shows whether the register can be written or not. The LK bit can only be written once after any system reset. Once LK is set, the SELx bits in this TRGMUX register cannot be changed until the next system reset clears LK. 0b - Register can be written. 1b - Register cannot be written until the next system Reset.
30-24 SEL3	Trigger MUX Input 3 Source Select This read/write bit field is used to configure the MUX select for peripheral trigger input 3. For the field setting definitions, see Memory map and register definition .
23 —	This read-only bit field is reserved and always has the value 0.
22-16 SEL2	Trigger MUX Input 2 Source Select This read/write bit field is used to configure the MUX select for peripheral trigger input 2. For the field setting definitions, see Memory map and register definition .
15 —	This read-only bit field is reserved and always has the value 0.
14-8 SEL1	Trigger MUX Input 1 Source Select This read/write bit field is used to configure the MUX select for peripheral trigger input 1. For the field setting definitions, see Memory map and register definition .
7 —	This read-only bit field is reserved and always has the value 0.
6-0 SEL0	Trigger MUX Input 0 Source Select This read/write bit field is used to configure the MUX select for peripheral trigger input 0. For the field setting definitions, see Memory map and register definition .

19.4.1.12 TRGMUX PDB0 Register (PDB0)

19.4.1.12.1 Offset

Register	Offset
PDB0	38h

19.4.1.12.2 Function

This register is for the PDB0 module.

19.4.1.12.3 Diagram

Bits	31	30	29	28	27	26	25	24	23	22	21	20	19	18	17	16
R	LK	0							0	0						
W																
Reset	0	0	0	0	0	0	0	0	0	0	0	0	0	0	0	0
Bits	15	14	13	12	11	10	9	8	7	6	5	4	3	2	1	0
R	0	0							0	SELO						
W																
Reset	0	0	0	0	0	0	0	0	0	0	0	0	0	0	0	0

19.4.1.12.4 Fields

Field	Function
31 LK	TRGMUX register lock. This bit shows whether the register can be written or not. The LK bit can only be written once after any system reset. Once LK is set, the SELx bits in this TRGMUX register cannot be changed until the next system reset clears LK. 0b - Register can be written. 1b - Register cannot be written until the next system Reset.
30-24 —	This read-only bit field is reserved and always has the value 0.
23 —	This read-only bit field is reserved and always has the value 0.
22-16 —	This read-only bit field is reserved and always has the value 0.
15 —	This read-only bit field is reserved and always has the value 0.
14-8 —	This read-only bit field is reserved and always has the value 0.
7 —	This read-only bit field is reserved and always has the value 0.
6-0 SELO	Trigger MUX Input 0 Source Select This read/write bit field is used to configure the MUX select for peripheral trigger input 0. For the field setting definitions, see Memory map and register definition .

19.4.1.13 TRGMUX PDB1 Register (PDB1)

19.4.1.13.1 Offset

Register	Offset
PDB1	3Ch

19.4.1.13.2 Function

This register is for the PDB1 module.

19.4.1.13.3 Diagram

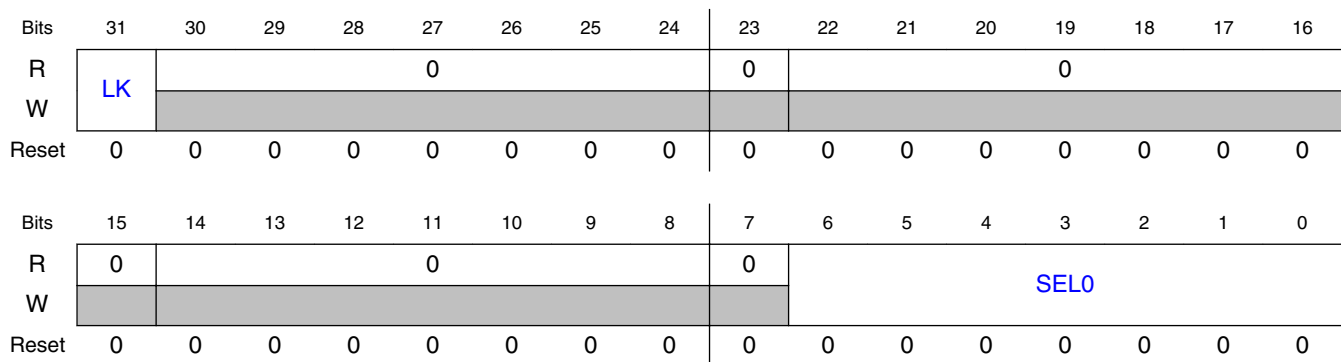

19.4.1.13.4 Fields

Field	Function
31 LK	TRGMUX register lock. This bit shows whether the register can be written or not. The LK bit can only be written once after any system reset. Once LK is set, the SELx bits in this TRGMUX register cannot be changed until the next system reset clears LK. 0b - Register can be written. 1b - Register cannot be written until the next system Reset.
30-24 —	This read-only bit field is reserved and always has the value 0.
23 —	This read-only bit field is reserved and always has the value 0.
22-16 —	This read-only bit field is reserved and always has the value 0.
15 —	This read-only bit field is reserved and always has the value 0.
14-8 —	This read-only bit field is reserved and always has the value 0.

Table continues on the next page...

Field	Function
7 —	This read-only bit field is reserved and always has the value 0.
6-0 SEL0	Trigger MUX Input 0 Source Select This read/write bit field is used to configure the MUX select for peripheral trigger input 0. For the field setting definitions, see Memory map and register definition .

19.4.1.14 TRGMUX FLEXIO Register (FLEXIO)

19.4.1.14.1 Offset

Register	Offset
FLEXIO	44h

19.4.1.14.2 Function

This register is for the FLEXIO module.

19.4.1.14.3 Diagram

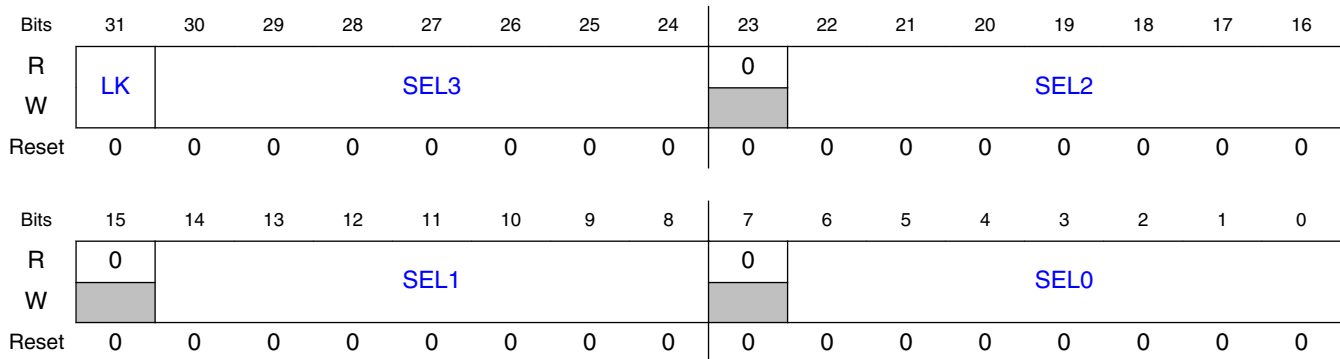

19.4.1.14.4 Fields

Field	Function
31 LK	TRGMUX register lock. This bit shows whether the register can be written or not. The LK bit can only be written once after any system reset. Once LK is set, the SELx bits in this TRGMUX register cannot be changed until the next system reset clears LK. 0b - Register can be written.

Table continues on the next page...

Memory map and register definition

Field	Function
	1b - Register cannot be written until the next system Reset.
30-24 SEL3	Trigger MUX Input 3 Source Select This read/write bit field is used to configure the MUX select for peripheral trigger input 3. For the field setting definitions, see Memory map and register definition .
23 —	This read-only bit field is reserved and always has the value 0.
22-16 SEL2	Trigger MUX Input 2 Source Select This read/write bit field is used to configure the MUX select for peripheral trigger input 2. For the field setting definitions, see Memory map and register definition .
15 —	This read-only bit field is reserved and always has the value 0.
14-8 SEL1	Trigger MUX Input 1 Source Select This read/write bit field is used to configure the MUX select for peripheral trigger input 1. For the field setting definitions, see Memory map and register definition .
7 —	This read-only bit field is reserved and always has the value 0.
6-0 SEL0	Trigger MUX Input 0 Source Select This read/write bit field is used to configure the MUX select for peripheral trigger input 0. For the field setting definitions, see Memory map and register definition .

19.4.1.15 TRGMUX LPIT0 Register (LPIT0)

19.4.1.15.1 Offset

Register	Offset
LPIT0	48h

19.4.1.15.2 Function

This register is for the LPIT0 module.

19.4.1.15.3 Diagram

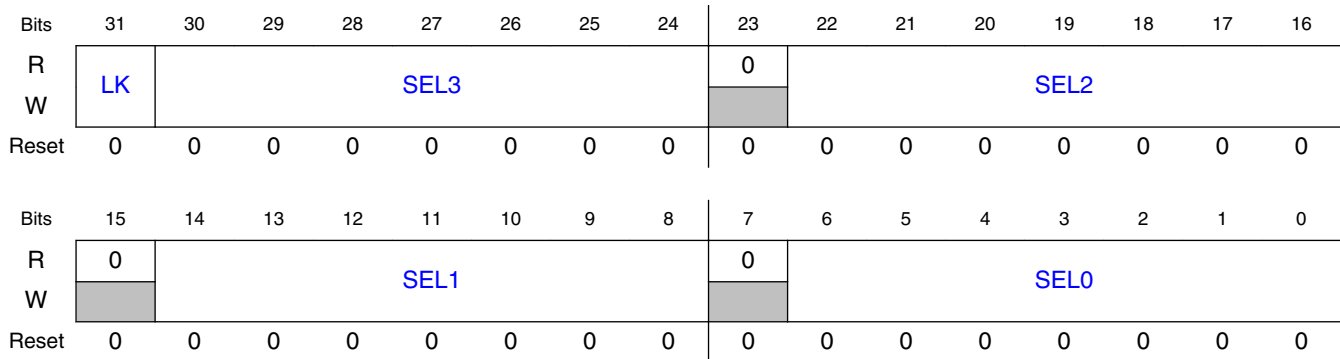

19.4.1.15.4 Fields

Field	Function
31 LK	TRGMUX register lock. This bit shows whether the register can be written or not. The LK bit can only be written once after any system reset. Once LK is set, the SELx bits in this TRGMUX register cannot be changed until the next system reset clears LK. 0b - Register can be written. 1b - Register cannot be written until the next system Reset.
30-24 SEL3	Trigger MUX Input 3 Source Select This read/write bit field is used to configure the MUX select for peripheral trigger input 3. For the field setting definitions, see Memory map and register definition .
23 —	This read-only bit field is reserved and always has the value 0.
22-16 SEL2	Trigger MUX Input 2 Source Select This read/write bit field is used to configure the MUX select for peripheral trigger input 2. For the field setting definitions, see Memory map and register definition .
15 —	This read-only bit field is reserved and always has the value 0.
14-8 SEL1	Trigger MUX Input 1 Source Select This read/write bit field is used to configure the MUX select for peripheral trigger input 1. For the field setting definitions, see Memory map and register definition .
7 —	This read-only bit field is reserved and always has the value 0.
6-0 SEL0	Trigger MUX Input 0 Source Select This read/write bit field is used to configure the MUX select for peripheral trigger input 0. For the field setting definitions, see Memory map and register definition .

19.4.1.16 TRGMUX LPUART0 Register (LPUART0)

19.4.1.16.1 Offset

Register	Offset
LPUART0	4Ch

19.4.1.16.2 Function

This register is for the LPUART0 module.

19.4.1.16.3 Diagram

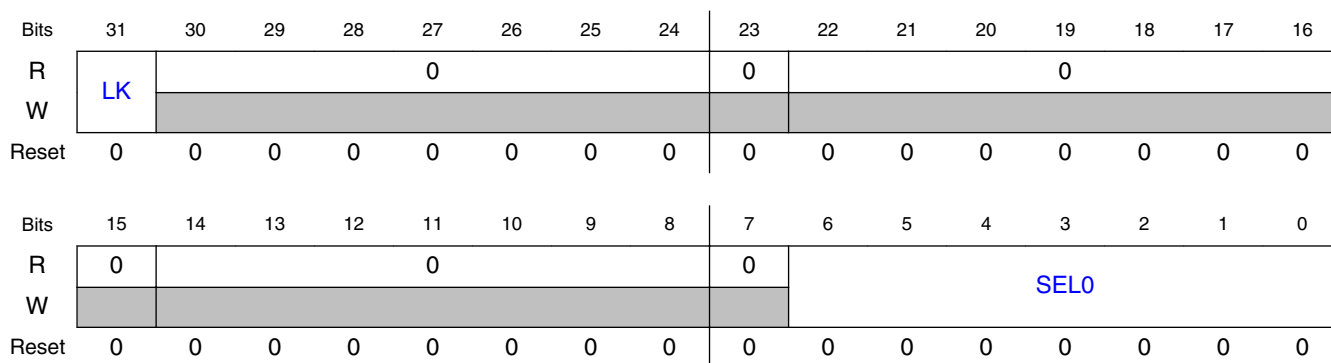

19.4.1.16.4 Fields

Field	Function
31 LK	TRGMUX register lock. This bit shows whether the register can be written or not. The LK bit can only be written once after any system reset. Once LK is set, the SELx bits in this TRGMUX register cannot be changed until the next system reset clears LK. 0b - Register can be written. 1b - Register cannot be written until the next system Reset.
30-24 —	This read-only bit field is reserved and always has the value 0.
23 —	This read-only bit field is reserved and always has the value 0.
22-16 —	This read-only bit field is reserved and always has the value 0.
15 —	This read-only bit field is reserved and always has the value 0.

Table continues on the next page...

Field	Function
14-8 —	This read-only bit field is reserved and always has the value 0.
7 —	This read-only bit field is reserved and always has the value 0.
6-0 SELO	Trigger MUX Input 0 Source Select This read/write bit field is used to configure the MUX select for peripheral trigger input 0. For the field setting definitions, see Memory map and register definition .

19.4.1.17 TRGMUX LPUART1 Register (LPUART1)

19.4.1.17.1 Offset

Register	Offset
LPUART1	50h

19.4.1.17.2 Function

This register is for the LPUART1 module.

19.4.1.17.3 Diagram

Bits	31	30	29	28	27	26	25	24	23	22	21	20	19	18	17	16
R	LK	0							0	0						
W																
Reset	0	0	0	0	0	0	0	0	0	0	0	0	0	0	0	0
Bits	15	14	13	12	11	10	9	8	7	6	5	4	3	2	1	0
R	0	0							0	SELO						
W																
Reset	0	0	0	0	0	0	0	0	0	0	0	0	0	0	0	0

19.4.1.17.4 Fields

Field	Function
31 LK	TRGMUX register lock.

Table continues on the next page...

Memory map and register definition

Field	Function
	This bit shows whether the register can be written or not. The LK bit can only be written once after any system reset. Once LK is set, the SELx bits in this TRGMUX register cannot be changed until the next system reset clears LK. 0b - Register can be written. 1b - Register cannot be written until the next system Reset.
30-24 —	This read-only bit field is reserved and always has the value 0.
23 —	This read-only bit field is reserved and always has the value 0.
22-16 —	This read-only bit field is reserved and always has the value 0.
15 —	This read-only bit field is reserved and always has the value 0.
14-8 —	This read-only bit field is reserved and always has the value 0.
7 —	This read-only bit field is reserved and always has the value 0.
6-0 SEL0	Trigger MUX Input 0 Source Select This read/write bit field is used to configure the MUX select for peripheral trigger input 0. For the field setting definitions, see Memory map and register definition .

19.4.1.18 TRGMUX LPI2C0 Register (LPI2C0)

19.4.1.18.1 Offset

Register	Offset
LPI2C0	54h

19.4.1.18.2 Function

This register is for the LPI2C0 module.

19.4.1.18.3 Diagram

Bits	31	30	29	28	27	26	25	24	23	22	21	20	19	18	17	16
R	LK	0							0	0						
W	—															
Reset	0	0	0	0	0	0	0	0	0	0	0	0	0	0	0	0
Bits	15	14	13	12	11	10	9	8	7	6	5	4	3	2	1	0
R	0	0							0	SELO						
W	—															
Reset	0	0	0	0	0	0	0	0	0	0	0	0	0	0	0	0

19.4.1.18.4 Fields

Field	Function
31 LK	TRGMUX register lock. This bit shows whether the register can be written or not. The LK bit can only be written once after any system reset. Once LK is set, the SELx bits in this TRGMUX register cannot be changed until the next system reset clears LK. 0b - Register can be written. 1b - Register cannot be written until the next system Reset.
30-24 —	This read-only bit field is reserved and always has the value 0.
23 —	This read-only bit field is reserved and always has the value 0.
22-16 —	This read-only bit field is reserved and always has the value 0.
15 —	This read-only bit field is reserved and always has the value 0.
14-8 —	This read-only bit field is reserved and always has the value 0.
7 —	This read-only bit field is reserved and always has the value 0.
6-0 SELO	Trigger MUX Input 0 Source Select This read/write bit field is used to configure the MUX select for peripheral trigger input 0. For the field setting definitions, see Memory map and register definition .

19.4.1.19 TRGMUX LPSPiO Register (LPSPiO)

19.4.1.19.1 Offset

Register	Offset
LPSPiO	5Ch

19.4.1.19.2 Function

This register is for the LPSPiO module.

19.4.1.19.3 Diagram

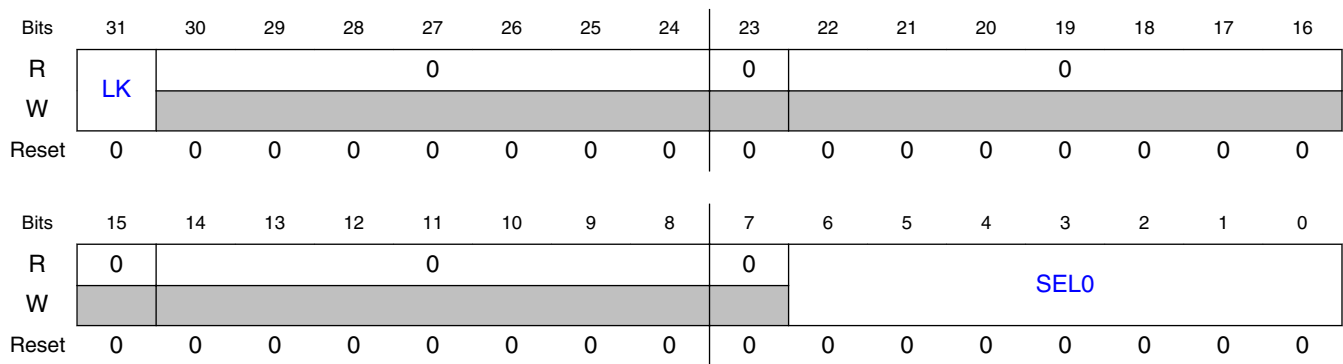

19.4.1.19.4 Fields

Field	Function
31 LK	TRGMUX register lock. This bit shows whether the register can be written or not. The LK bit can only be written once after any system reset. Once LK is set, the SELx bits in this TRGMUX register cannot be changed until the next system reset clears LK. 0b - Register can be written. 1b - Register cannot be written until the next system Reset.
30-24 —	This read-only bit field is reserved and always has the value 0.
23 —	This read-only bit field is reserved and always has the value 0.
22-16 —	This read-only bit field is reserved and always has the value 0.
15 —	This read-only bit field is reserved and always has the value 0.
14-8 —	This read-only bit field is reserved and always has the value 0.

Table continues on the next page...

Field	Function
7 —	This read-only bit field is reserved and always has the value 0.
6-0 SELO	Trigger MUX Input 0 Source Select This read/write bit field is used to configure the MUX select for peripheral trigger input 0. For the field setting definitions, see Memory map and register definition .

19.4.1.20 TRGMUX LPSPI1 Register (LPSPI1)

19.4.1.20.1 Offset

Register	Offset
LPSPI1	60h

19.4.1.20.2 Function

This register is for the LPSPI1 module.

19.4.1.20.3 Diagram

Bits	31	30	29	28	27	26	25	24	23	22	21	20	19	18	17	16
R					0				0				0			
W	LK															
Reset	0	0	0	0	0	0	0	0	0	0	0	0	0	0	0	0
Bits	15	14	13	12	11	10	9	8	7	6	5	4	3	2	1	0
R	0				0				0							
W													SELO			
Reset	0	0	0	0	0	0	0	0	0	0	0	0	0	0	0	0

19.4.1.20.4 Fields

Field	Function
31 LK	TRGMUX register lock. This bit shows whether the register can be written or not. The LK bit can only be written once after any system reset. Once LK is set, the SELx bits in this TRGMUX register cannot be changed until the next system reset clears LK. 0b - Register can be written.

Table continues on the next page...

Memory map and register definition

Field	Function
	1b - Register cannot be written until the next system Reset.
30-24 —	This read-only bit field is reserved and always has the value 0.
23 —	This read-only bit field is reserved and always has the value 0.
22-16 —	This read-only bit field is reserved and always has the value 0.
15 —	This read-only bit field is reserved and always has the value 0.
14-8 —	This read-only bit field is reserved and always has the value 0.
7 —	This read-only bit field is reserved and always has the value 0.
6-0 SEL0	Trigger MUX Input 0 Source Select This read/write bit field is used to configure the MUX select for peripheral trigger input 0. For the field setting definitions, see Memory map and register definition .

19.4.1.21 TRGMUX LPTMR0 Register (LPTMR0)

19.4.1.21.1 Offset

Register	Offset
LPTMR0	64h

19.4.1.21.2 Function

This register is for the LPTMR0 module.

19.4.1.21.3 Diagram

Bits	31	30	29	28	27	26	25	24	23	22	21	20	19	18	17	16
R	LK	0							0	0						
W	—															
Reset	0	0	0	0	0	0	0	0	0	0	0	0	0	0	0	0
Bits	15	14	13	12	11	10	9	8	7	6	5	4	3	2	1	0
R	0	0							0	SELO						
W	—															
Reset	0	0	0	0	0	0	0	0	0	0	0	0	0	0	0	0

19.4.1.21.4 Fields

Field	Function
31 LK	TRGMUX register lock. This bit shows whether the register can be written or not. The LK bit can only be written once after any system reset. Once LK is set, the SELx bits in this TRGMUX register cannot be changed until the next system reset clears LK. 0b - Register can be written. 1b - Register cannot be written until the next system Reset.
30-24 —	This read-only bit field is reserved and always has the value 0.
23 —	This read-only bit field is reserved and always has the value 0.
22-16 —	This read-only bit field is reserved and always has the value 0.
15 —	This read-only bit field is reserved and always has the value 0.
14-8 —	This read-only bit field is reserved and always has the value 0.
7 —	This read-only bit field is reserved and always has the value 0.
6-0 SELO	Trigger MUX Input 0 Source Select This read/write bit field is used to configure the MUX select for peripheral trigger input 0. For the field setting definitions, see Memory map and register definition .

19.4.1.22 TRGMUX LPI2C1 Register (LPI2C1)

19.4.1.22.1 Offset

Register	Offset
LPI2C1	6Ch

19.4.1.22.2 Function

This register is for the LPI2C1 module.

19.4.1.22.3 Diagram

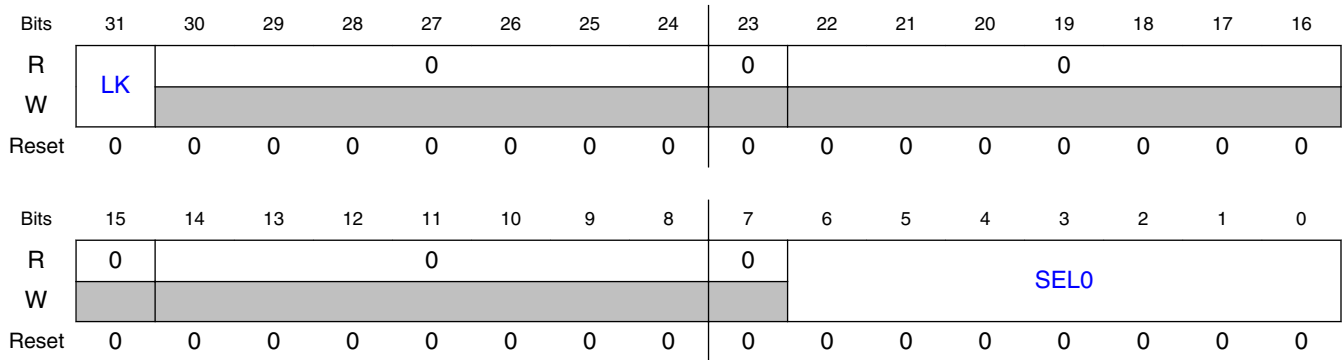

19.4.1.22.4 Fields

Field	Function
31 LK	TRGMUX register lock. This bit shows whether the register can be written or not. The LK bit can only be written once after any system reset. Once LK is set, the SELx bits in this TRGMUX register cannot be changed until the next system reset clears LK. 0b - Register can be written. 1b - Register cannot be written until the next system Reset.
30-24 —	This read-only bit field is reserved and always has the value 0.
23 —	This read-only bit field is reserved and always has the value 0.
22-16 —	This read-only bit field is reserved and always has the value 0.
15 —	This read-only bit field is reserved and always has the value 0.
14-8 —	This read-only bit field is reserved and always has the value 0.

Table continues on the next page...

Field	Function
7 —	This read-only bit field is reserved and always has the value 0.
6-0 SELO	Trigger MUX Input 0 Source Select This read/write bit field is used to configure the MUX select for peripheral trigger input 0. For the field setting definitions, see Memory map and register definition .

19.4.1.23 TRGMUX FTM4 Register (FTM4)

19.4.1.23.1 Offset

Register	Offset
FTM4	70h

19.4.1.23.2 Function

This register is for the FTM4 module.

19.4.1.23.3 Diagram

Bits	31	30	29	28	27	26	25	24	23	22	21	20	19	18	17	16
R					0				0				0			
W	LK															
Reset	0	0	0	0	0	0	0	0	0	0	0	0	0	0	0	0
Bits	15	14	13	12	11	10	9	8	7	6	5	4	3	2	1	0
R	0				0				0							
W													SELO			
Reset	0	0	0	0	0	0	0	0	0	0	0	0	0	0	0	0

19.4.1.23.4 Fields

Field	Function
31 LK	TRGMUX register lock. This bit shows whether the register can be written or not. The LK bit can only be written once after any system reset. Once LK is set, the SELx bits in this TRGMUX register cannot be changed until the next system reset clears LK. 0b - Register can be written.

Table continues on the next page...

Memory map and register definition

Field	Function
	1b - Register cannot be written until the next system Reset.
30-24 —	This read-only bit field is reserved and always has the value 0.
23 —	This read-only bit field is reserved and always has the value 0.
22-16 —	This read-only bit field is reserved and always has the value 0.
15 —	This read-only bit field is reserved and always has the value 0.
14-8 —	This read-only bit field is reserved and always has the value 0.
7 —	This read-only bit field is reserved and always has the value 0.
6-0 SEL0	Trigger MUX Input 0 Source Select This read/write bit field is used to configure the MUX select for peripheral trigger input 0. For the field setting definitions, see Memory map and register definition .

19.4.1.24 TRGMUX FTM5 Register (FTM5)

19.4.1.24.1 Offset

Register	Offset
FTM5	74h

19.4.1.24.2 Function

This register is for the FTM5 module.

19.4.1.24.3 Diagram

Bits	31	30	29	28	27	26	25	24	23	22	21	20	19	18	17	16
R	LK	0							0	0						
W	[Shaded]															
Reset	0	0	0	0	0	0	0	0	0	0	0	0	0	0	0	0
Bits	15	14	13	12	11	10	9	8	7	6	5	4	3	2	1	0
R	0	0							0	SELO						
W	[Shaded]															
Reset	0	0	0	0	0	0	0	0	0	0	0	0	0	0	0	0

19.4.1.24.4 Fields

Field	Function
31 LK	TRGMUX register lock. This bit shows whether the register can be written or not. The LK bit can only be written once after any system reset. Once LK is set, the SELx bits in this TRGMUX register cannot be changed until the next system reset clears LK. 0b - Register can be written. 1b - Register cannot be written until the next system Reset.
30-24 —	This read-only bit field is reserved and always has the value 0.
23 —	This read-only bit field is reserved and always has the value 0.
22-16 —	This read-only bit field is reserved and always has the value 0.
15 —	This read-only bit field is reserved and always has the value 0.
14-8 —	This read-only bit field is reserved and always has the value 0.
7 —	This read-only bit field is reserved and always has the value 0.
6-0 SELO	Trigger MUX Input 0 Source Select This read/write bit field is used to configure the MUX select for peripheral trigger input 0. For the field setting definitions, see Memory map and register definition .

19.4.1.25 TRGMUX FTM6 Register (FTM6)

19.4.1.25.1 Offset

Register	Offset
FTM6	78h

19.4.1.25.2 Function

This register is for the FTM6 module.

19.4.1.25.3 Diagram

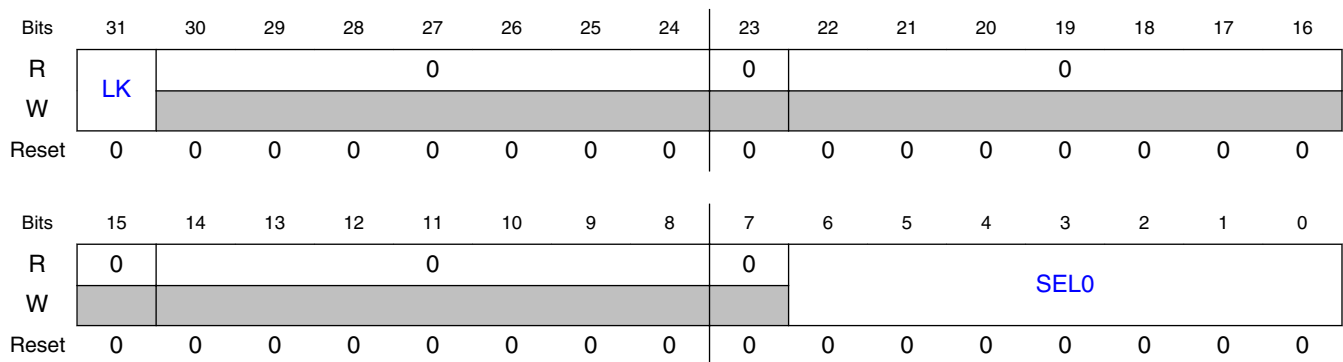

19.4.1.25.4 Fields

Field	Function
31 LK	TRGMUX register lock. This bit shows whether the register can be written or not. The LK bit can only be written once after any system reset. Once LK is set, the SELx bits in this TRGMUX register cannot be changed until the next system reset clears LK. 0b - Register can be written. 1b - Register cannot be written until the next system Reset.
30-24 —	This read-only bit field is reserved and always has the value 0.
23 —	This read-only bit field is reserved and always has the value 0.
22-16 —	This read-only bit field is reserved and always has the value 0.
15 —	This read-only bit field is reserved and always has the value 0.
14-8 —	This read-only bit field is reserved and always has the value 0.

Table continues on the next page...

Field	Function
7 —	This read-only bit field is reserved and always has the value 0.
6-0 SELO	Trigger MUX Input 0 Source Select This read/write bit field is used to configure the MUX select for peripheral trigger input 0. For the field setting definitions, see Memory map and register definition .

19.4.1.26 TRGMUX FTM7 Register (FTM7)

19.4.1.26.1 Offset

Register	Offset
FTM7	7Ch

19.4.1.26.2 Function

This register is for the FTM7 module.

19.4.1.26.3 Diagram

Bits	31	30	29	28	27	26	25	24	23	22	21	20	19	18	17	16
R					0				0				0			
W	LK															
Reset	0	0	0	0	0	0	0	0	0	0	0	0	0	0	0	0
Bits	15	14	13	12	11	10	9	8	7	6	5	4	3	2	1	0
R	0				0				0							
W													SELO			
Reset	0	0	0	0	0	0	0	0	0	0	0	0	0	0	0	0

19.4.1.26.4 Fields

Field	Function
31 LK	TRGMUX register lock. This bit shows whether the register can be written or not. The LK bit can only be written once after any system reset. Once LK is set, the SELx bits in this TRGMUX register cannot be changed until the next system reset clears LK. 0b - Register can be written.

Table continues on the next page...

Memory map and register definition

Field	Function
	1b - Register cannot be written until the next system Reset.
30-24 —	This read-only bit field is reserved and always has the value 0.
23 —	This read-only bit field is reserved and always has the value 0.
22-16 —	This read-only bit field is reserved and always has the value 0.
15 —	This read-only bit field is reserved and always has the value 0.
14-8 —	This read-only bit field is reserved and always has the value 0.
7 —	This read-only bit field is reserved and always has the value 0.
6-0 SEL0	Trigger MUX Input 0 Source Select This read/write bit field is used to configure the MUX select for peripheral trigger input 0. For the field setting definitions, see Memory map and register definition .

Chapter 20

External Watchdog Monitor (EWM)

20.1 Chip-specific EWM information

S32K14x has one instance of EWM. Products in the S32K11x series do not have EWM.

20.1.1 EWM_OUT signal configuration

EWM_out signal shares its pad with other I/Os. To know the default state of that pad, see IO Signal Description Input Multiplexing sheet(s) attached to the Reference Manual.

20.1.2 EWM Memory Map access

Only 8-bit access is supported.

20.1.3 EWM low-power modes

This table shows the EWM low-power modes and the corresponding chip low-power modes.

Wait mode and power down mode is not supported. See [Module operation in available power modes](#) for details on available power modes.

20.2 Introduction

For safety, a redundant watchdog system, External Watchdog Monitor (EWM), is designed to monitor external circuits, as well as the MCU software flow. This provides a back-up mechanism to the internal watchdog that resets the MCU's CPU and peripherals.

The watchdog is generally used to monitor the flow and execution of embedded software within an MCU. The watchdog consists of a counter that if allowed to overflow, forces an internal reset (asynchronous) to all on-chip peripherals and optionally assert the RESET_B pin to reset external devices/circuits. The overflow of the watchdog counter must not occur if the software code works well and services the watchdog to re-start the actual counter.

The EWM differs from the internal watchdog in that it does not reset the MCU's CPU and peripherals. The EWM provides an independent EWM_OUT_b signal that when asserted resets or places an external circuit into a safe mode. The EWM_OUT_b signal is asserted upon the EWM counter time-out. An optional external input EWM_in is provided to allow additional control of the assertion of EWM_OUT_b signal.

20.2.1 Features

Features of EWM module include:

- Independent LPO_CLK clock source
- Programmable time-out period specified in terms of number of EWM LPO_CLK clock cycles.
- Windowed refresh option
 - Provides robust check that program flow is faster than expected.
 - Programmable window.
 - Refresh outside window leads to assertion of EWM_OUT_b.
- Robust refresh mechanism
 - Write values of 0xB4 and 0x2C to EWM Refresh Register within 15 peripheral bus clock cycles.
- One output port, EWM_OUT_b, when asserted is used to reset or place the external circuit into safe mode.
- One Input port, EWM_in, allows an external circuit to control the assertion of the EWM_OUT_b signal.

20.2.2 Modes of Operation

This section describes the module's operating modes.

20.2.2.1 Stop Mode

When the EWM is in stop mode, the CPU refreshes to the EWM cannot occur. On entry to stop mode, the EWM's counter freezes.

There are two possible ways to exit from Stop mode:

- On exit from stop mode through a reset, the EWM remains disabled.
- On exit from stop mode by an interrupt, the EWM is re-enabled, and the counter continues to be clocked from the same value prior to entry to stop mode.

Note the following if the EWM enters the stop mode during CPU refresh mechanism: At the exit from stop mode by an interrupt, refresh mechanism state machine starts from the previous state which means, if first refresh command is written correctly and EWM enters the stop mode immediately, the next command has to be written within the next 15 peripheral bus clocks after exiting from stop mode. User must mask all interrupts prior to executing EWM refresh instructions.

20.2.2.2 Debug Mode

Entry to debug mode has no effect on the EWM.

- If the EWM is enabled prior to entry of debug mode, it remains enabled.
- If the EWM is disabled prior to entry of debug mode, it remains disabled.

20.2.3 Block Diagram

This figure shows the EWM block diagram.

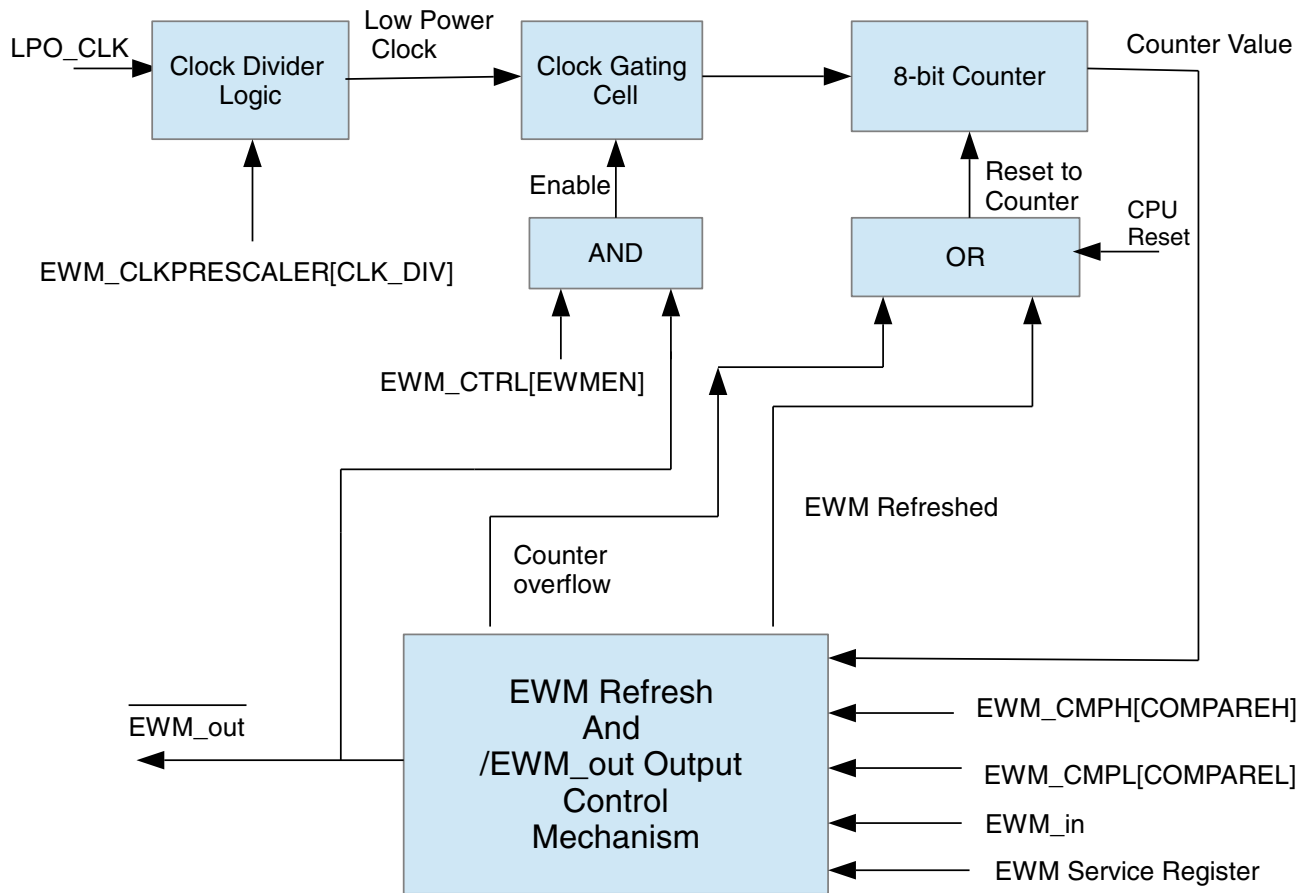

Figure 20-1. EWM Block Diagram

20.3 EWM Signal Descriptions

The EWM has two external signals, as shown in the following table.

NOTE

All active-low signals are now represented with the suffix "_b" throughout the chapter.

Table 20-1. EWM Signal Descriptions

Signal	Description	I/O
EWM_in	EWM input for safety status of external safety circuits. The polarity of EWM_in is programmable using the EWM_CTRL[ASSIN] bit. The default polarity is active low.	I
EWM_OUT_b	EWM reset out signal	O

20.4 Memory Map/Register Definition

This section contains the module memory map and registers.

NOTE

EWM only supports 8-bit register access. 16-bit and 32-bit access are not possible.

20.4.1 EWM register descriptions

20.4.1.1 EWM memory map

EWM base address: 4006_1000h

Offset	Register	Width (In bits)	Access	Reset value
0h	Control Register (CTRL)	8	RW	00h
1h	Service Register (SERV)	8	WORZ	00h
2h	Compare Low Register (CMPL)	8	RWONC E	00h
3h	Compare High Register (CMPH)	8	RWONC E	FFh
5h	Clock Prescaler Register (CLKPRESCALER)	8	RWONC E	00h

20.4.1.2 Control Register (CTRL)

20.4.1.2.1 Offset

Register	Offset
CTRL	0h

20.4.1.2.2 Function

The CTRL register is cleared by any reset.

NOTE

INEN, ASSIN and EWMEN bits can be written once after a CPU reset. Modifying these bits more than once, generates a bus transfer error.

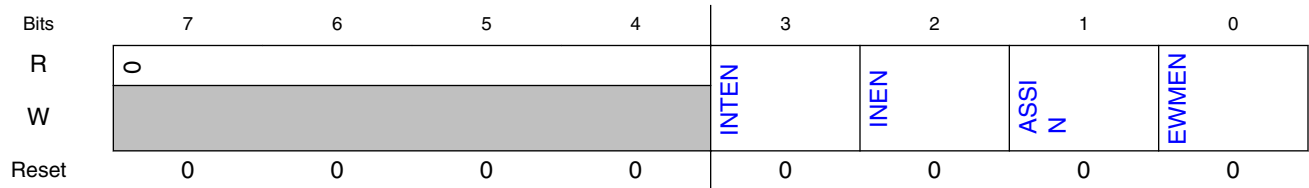
20.4.1.2.3 Diagram**20.4.1.2.4 Fields**

Field	Function
7-4 —	Reserved
3 INTEN	Interrupt Enable. This bit when set and EWM_OUT_b is asserted, an interrupt request is generated. To de-assert interrupt request, user should clear this bit by writing 0.
2 INEN	Input Enable. This bit when set, enables the EWM_in port.
1 ASSIN	EWM_in's Assertion State Select. Default assert state of the EWM_in signal is logic zero. Setting the ASSIN bit inverts the assert state of EWM_in signal to a logic one.
0 EWMEN	EWM enable. This bit when set, enables the EWM module. This resets the EWM counter to zero and deasserts the EWM_OUT_b signal. This bit when unset, keeps the EWM module disabled. It cannot be re-enabled until a next reset, due to the write-once nature of this bit.

20.4.1.3 Service Register (SERV)**20.4.1.3.1 Offset**

Register	Offset
SERV	1h

20.4.1.3.2 Function

The SERV register provides the interface from the CPU to the EWM module. It is write-only and reads of this register return zero.

20.4.1.3.3 Diagram

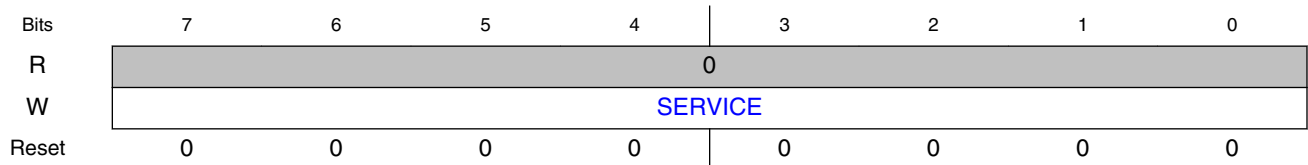

20.4.1.3.4 Fields

Field	Function
7-0 SERVICE	<p>SERVICE</p> <p>The EWM refresh mechanism requires the CPU to write two values to the SERV register: a first data byte of 0xB4, followed by a second data byte of 0x2C. The EWM refresh is invalid if either of the following conditions is true.</p> <ul style="list-style-type: none"> The first or second data byte is not written correctly. The second data byte is not written within a fixed number of peripheral bus cycles of the first data byte. This fixed number of cycles is called <i>EWM_refresh_time</i>. <p>15 peripheral bus clock cycles are required for <i>EWM_refresh_time</i></p>

20.4.1.4 Compare Low Register (CMPL)

20.4.1.4.1 Offset

Register	Offset
CMPL	2h

20.4.1.4.2 Function

The CMPL register is reset to zero after a CPU reset. This provides no minimum time for the CPU to refresh the EWM counter.

NOTE

This register can be written only once after a CPU reset.
Writing this register more than once generates a bus transfer error.

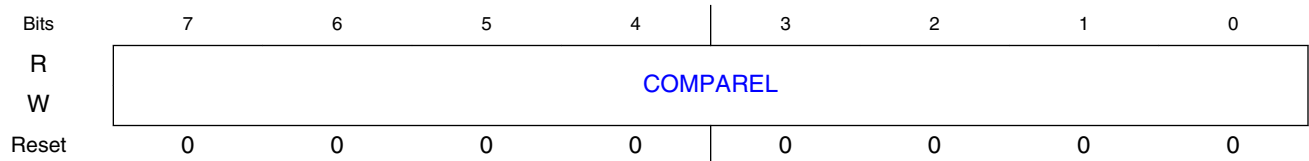
20.4.1.4.3 Diagram**20.4.1.4.4 Fields**

Field	Function
7-0 COMPAREL	COMPAREL To prevent runaway code from changing this field, software should write to this field after a CPU reset even if the (default) minimum refresh time is required.

20.4.1.5 Compare High Register (CMPH)**20.4.1.5.1 Offset**

Register	Offset
CMPH	3h

20.4.1.5.2 Function

The CMPH register is reset to 0xFF after a CPU reset. This provides a maximum of 256 clocks time, for the CPU to refresh the EWM counter.

NOTE

This register can be written only once after a CPU reset.
Writing this register more than once generates a bus transfer error.

NOTE

The valid values for CMPH are up to 0xFE because the EWM counter never expires when CMPH = 0xFF. The expiration happens only if EWM counter is greater than CMPH.

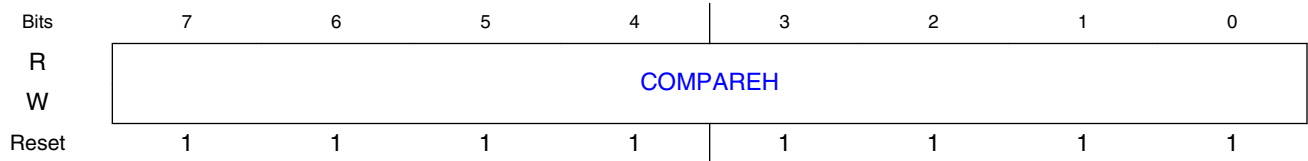
20.4.1.5.3 Diagram**20.4.1.5.4 Fields**

Field	Function
7-0 COMPAREH	COMPAREH To prevent runaway code from changing this field, software should write to this field after a CPU reset even if the (default) maximum refresh time is required.

20.4.1.6 Clock Prescaler Register (CLKPRESCALER)**20.4.1.6.1 Offset**

Register	Offset
CLKPRESCALER	5h

20.4.1.6.2 Function

This CLKPRESCALER register is reset to 0x00 after a CPU reset.

NOTE

This register can be written only once after a CPU reset. Writing this register more than once generates a bus transfer error.

NOTE

Write the required prescaler value before enabling the EWM.

NOTE

The implementation of this register is chip-specific. See the Chip Configuration details.

20.4.1.6.3 Diagram

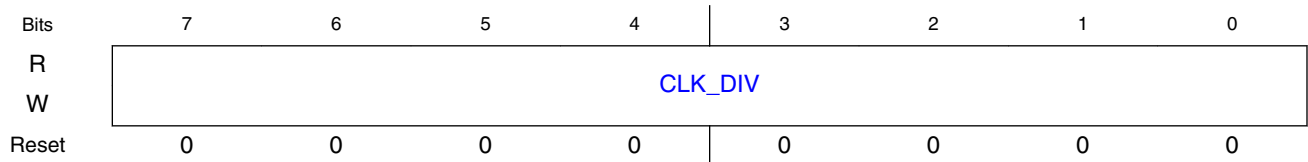

20.4.1.6.4 Fields

Field	Function
7-0 CLK_DIV	CLK_DIV Selected low power clock source for running the EWM counter can be prescaled as below. <ul style="list-style-type: none"> • Prescaled clock frequency = low power clock source frequency / (1 + CLK_DIV)

20.5 Functional Description

The following sections describe functional details of the EWM module.

NOTE

When the BUS_CLK is lost, then EWM module doesn't generate the EWM_OUT_b signal and no refresh operation is possible

20.5.1 The EWM_OUT_b Signal

The EWM_OUT_b is a digital output signal used to gate an external circuit (application specific) that controls critical safety functions. For example, the EWM_OUT_b could be connected to the high voltage transistors circuits that control an AC motor in a large appliance.

The EWM_OUT_b signal remains deasserted when the EWM is being regularly refreshed by the CPU within the programmable refresh window, indicating that the application code is executed as expected.

The EWM_OUT_b signal is asserted in any of the following conditions:

- The EWM refresh occurs when the counter value is less than CMPL value.
- The EWM counter value reaches the CMPH value, and no EWM refresh has occurred.
- If functionality of EWM_in pin is enabled and EWM_in pin is asserted while refreshing the EWM.
- After any reset (by the virtue of the external pull-down mechanism on the EWM_OUT_b pin)

The EWM_OUT_b is asserted after any reset by the virtue of the external pull-down mechanism on the EWM_OUT_b signal. Then, to deassert the EWM_OUT_b signal, set EWMEN bit in the CTRL register to enable the EWM.

If the EWM_OUT_b signal shares its pad with a digital I/O pin, on reset this actual pad defers to being an input signal. The pad state is controlled by the EWM_OUT_b signal only after the EWM is enabled by the EWMEN bit in the CTRL register.

Note

EWM_OUT_b pad must be in pull down state when EWM functionality is used and when EWM is under Reset.

20.5.2 EWM_OUT_b pin state in low power modes

During Wait, Stop, and Power Down modes the EWM_OUT_b pin preserve its state before entering Wait or Stop mode. When the CPU enters a Run mode from Wait or Stop recovery, the pin resumes its previous state before entering Wait or Stop mode. When the CPU enters Run mode from Power Down, the pin returns to its reset state.

20.5.3 The EWM_in Signal

The EWM_in is a digital input signal for safety status of external safety circuits, that allows an external circuit to control the assertion of the EWM_OUT_b signal. For example, in the application, an external circuit monitors a critical safety function, and if there is fault with safety function, the external circuit can then actively initiate the EWM_OUT_b signal that controls the gating circuit.

The EWM_in signal is ignored if the EWM is disabled, or if INEN bit of CTRL register is cleared, as after any reset.

On enabling the EWM (setting the CTRL[EWMEN] bit) and enabling EWM_in functionality (setting the CTRL[INEN] bit), the EWM_in signal must be in the deasserted state prior to the CPU start refreshing the EWM. This ensures that the EWM_OUT_b stays in the deasserted state; otherwise, the EWM_OUT_b output signal is asserted.

Note

The user must update the CMPH and CMPL registers prior to enabling the EWM. After enabling the EWM, the counter resets to zero, therefore the user shall provide a reasonable time after a power-on reset for the external monitoring circuit to stabilize. The user shall also ensure that the EWM_in pin is deasserted.

20.5.4 EWM Counter

It is an 8-bit ripple counter fed from a clock source that is independent of the peripheral bus clock source. As the preferred time-out is between 1 ms and 100 ms the actual clock source should be in the kHz range.

The counter is reset to zero after the CPU reset, or when EWM refresh action completes, or at counter overflow. The counter value is not accessible to the CPU.

20.5.5 EWM Compare Registers

The compare registers CMPL and CMPH are write-once after a CPU reset and cannot be modified until another CPU reset occurs.

The EWM compare registers are used to create a refresh window to refresh the EWM module.

It is illegal to program CMPL and CMPH with same value. In this case, as soon as counter reaches (CMPL + 1), EWM_OUT_b is asserted.

20.5.6 EWM Refresh Mechanism

Other than the initial configuration of the EWM, the CPU can only access the EWM by the EWM Service Register. The CPU must access the EWM service register with correct write of unique data within the windowed time frame as determined by the CMPL and CMPH registers for correct EWM refresh operation. Therefore, three possible conditions can occur:

Table 20-2. EWM Refresh Mechanisms

Condition	Mechanism
An EWM refresh action completes when: CMPL < Counter < CMPH.	The software behaves as expected and the EWM counter is reset to zero. The EWM_OUT_b output signal remains in the deasserted state if, during the EWM refresh action, the EWM_in input has been in deasserted state..
An EWM refresh action completes when Counter < CMPL	The software refreshes the EWM before the windowed time frame, the counter is reset to zero and the EWM_OUT_b output signal is asserted irrespective of the input EWM_in signal.
Counter value reaches CMPH prior to completion of EWM refresh action.	Software has not refreshed the EWM. The EWM counter is reset to zero and the EWM_OUT_b output signal is asserted irrespective of the input EWM_in signal.

20.5.7 EWM Interrupt

When EWM_OUT_b is asserted, an interrupt request is generated to indicate the assertion of the EWM reset out signal. This interrupt is enabled when CTRL[INTEN] is set. Clearing this bit clears the interrupt request but does not affect EWM_OUT_b. The EWM_OUT_b signal can be deasserted only by forcing a system reset.

20.5.8 Counter clock prescaler

The EWM counter clock source can be prescaled by a clock divider, by programming CLKPRESCALER[CLK_DIV]. This divided clock is used to run the EWM counter.

NOTE

The divided clock used to run the EWM counter must be no more than half the frequency of the bus clock.

Chapter 21

Error Injection Module (EIM)

21.1 Chip-specific EIM information

S32K1xx and S32K14xW has one instance of the EIM.

21.1.1 EIM channel assignments

Each EIM channel corresponds to a specific RAM array target. The EIM channel can inject errors on accesses to that specific RAM array. The following table shows the channel assignments.

Table 21-1. RAM array targets of EIM channels

EIM channel	RAM array target		
	S32K14x	S32K14xW	S32K11x
0	SRAM_L	SRAM_L	SRAM_U
1	SRAM_U	SRAM_U	Reserved

21.2 Introduction

The Error Injection module is mainly used for diagnostic purposes. It provides a method for diagnostic coverage of the peripheral memories. See the chip-specific EIM information to determine which peripheral memories are supported by this method.

21.2.1 Overview

The Error Injection Module (EIM) provides support for inducing single-bit and multi-bit inversions on read data when accessing peripheral RAMs. Injecting faults on memory accesses can be used to exercise the Single Error Correct – Dual Error Detect (SEC-DED) ECC function of the related system.

NOTE

The following diagram shows an example of EIM implementation with a 64-bit read data bus and an 8-bit checkbit bus.

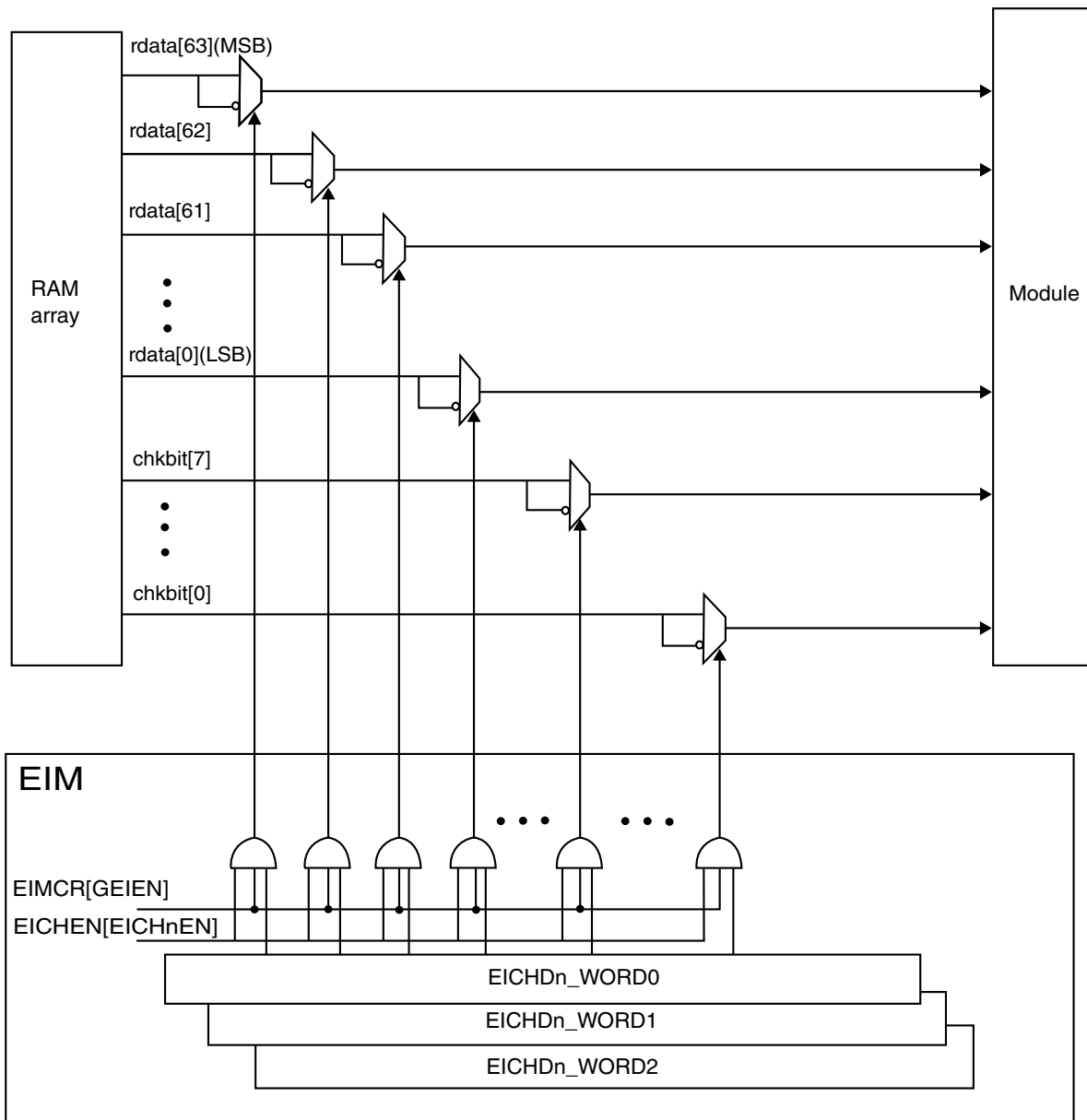

Figure 21-1. EIM functional block diagram (64-bit read data bus and 8-bit check bit bus)

21.2.2 Features

The EIM includes these features:

- Supports 2 error injection channels
- Protection against accidental enable and reconfiguration error injection function via two-stage enable mechanism

21.3 EIM register descriptions

The EIM provides an IPS programming model mapped to an on-platform peripheral slot.

Programming model access

All system bus masters can access the programming model:

- Only in supervisor mode
- Using only 32-bit (word) accesses

Any of the following attempted references to the programming model generates an IPS error termination:

- In user mode
- Using non-32-bit access sizes
- To undefined (reserved) addresses

Attempted updates to the programming model while the EIM is in the midst of an operation result in non-deterministic behavior.

Error injection channel descriptor: function and structure

Each error injection channel descriptor:

- Specifies a mask that defines which bits of the read data and checkbit bus from target RAM are inverted on a read access.
- Consists of a 128-bit (16-byte) structure, composed of four 32-bit words, in the EIM programming model.
 - The first word, Word0 (EICHD n _WORD0), defines the checkbit mask. See [Error Injection Channel Descriptor \$n\$, Word0](#) for details.
 - The remaining words, Word1-3 (EICHD n _WORD1-3), define the data mask. Word2 and Word3 are used only when required by the total width of the

channel's data mask. See Error injection channel descriptor: DATA_MASK details and the individual registers' descriptions.

The multiple channel descriptors are organized sequentially.

Error injection channel descriptor: DATA_MASK details

For each channel: The following table shows the total width of DATA_MASK and the distribution of its bits across the WORD registers.

Channel	DATA_MASK total width (bits)	Specific bits of DATA_MASK in		
		WORD1	WORD2	WORD3
0	32	31-0	—	—
1	32	31-0	—	—

21.3.1 EIM memory map

EIM base address: 4001_9000h

Offset	Register	Width (In bits)	Access	Reset value
0h	Error Injection Module Configuration Register (EIMCR)	32	RW	0000_0000h
4h	Error Injection Channel Enable register (EICHEN)	32	RW	0000_0000h
100h	Error Injection Channel Descriptor n, Word0 (EICHD0_WORD0)	32	RW	0000_0000h
104h	Error Injection Channel Descriptor n, Word1 (EICHD0_WORD1)	32	RW	0000_0000h
200h	Error Injection Channel Descriptor n, Word0 (EICHD1_WORD0)	32	RW	0000_0000h
204h	Error Injection Channel Descriptor n, Word1 (EICHD1_WORD1)	32	RW	0000_0000h

21.3.2 Error Injection Module Configuration Register (EIMCR)

21.3.2.1 Offset

Register	Offset
EIMCR	0h

21.3.2.2 Function

The EIM Configuration Register is used to globally enable/disable the error injection function.

21.3.2.3 Diagram

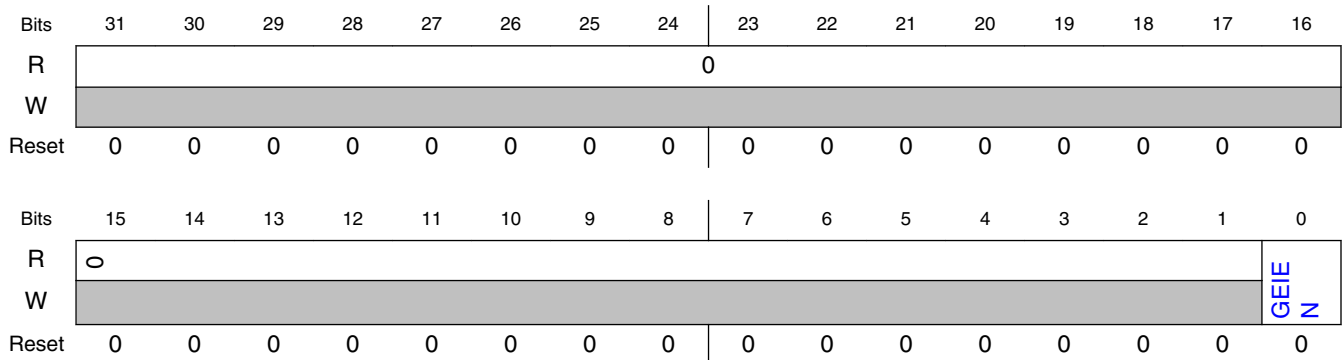

21.3.2.4 Fields

Field	Function
31-1 —	Reserved
0 GEIEN	Global Error Injection Enable This bit globally enables or disables the error injection function of the EIM. This field is initialized by hardware reset. 0b - Disabled 1b - Enabled

21.3.3 Error Injection Channel Enable register (EICHEN)

21.3.3.1 Offset

Register	Offset
EICHEN	4h

21.3.3.2 Function

Each field of the Error Injection Channel Enable register (EICHEN) is used to enable or disable the corresponding error injection channel.

NOTE

To enable an error injection channel, the Global Error Injection Enable (EIMCR[GEIEN]) field must also be asserted.

21.3.3.3 Diagram

Bits	31	30	29	28	27	26	25	24	23	22	21	20	19	18	17	16
R	EICH0EN	EICH1EN	0	0	0	0	0	0	0	0	0	0	0	0	0	0
W																
Reset	0	0	0	0	0	0	0	0	0	0	0	0	0	0	0	0
Bits	15	14	13	12	11	10	9	8	7	6	5	4	3	2	1	0
R	0	0	0	0	0	0	0	0	0	0	0	0	0	0	0	0
W																
Reset	0	0	0	0	0	0	0	0	0	0	0	0	0	0	0	0

21.3.3.4 Fields

Field	Function
31 EICH0EN	<p>Error Injection Channel 0 Enable</p> <p>This field enables the corresponding error injection channel. The Global Error Injection Enable (EIMCR[GEIEN]) field must also be asserted to enable error injection.</p> <p>After error injection is enabled, all subsequent read accesses incur one or more bit inversions as defined in the corresponding EICHn_WORD registers. Error injection remains in effect until the error injection channel is manually disabled via software.</p> <p>Any write to the corresponding EICHn_WORD registers clears the corresponding EICHEN[EICHnEN] field, disabling the error injection channel.</p> <p>0b - Error injection is disabled on Error Injection Channel 0 1b - Error injection is enabled on Error Injection Channel 0</p>
30 EICH1EN	<p>Error Injection Channel 1 Enable</p> <p>This field enables the corresponding error injection channel. The Global Error Injection Enable (EIMCR[GEIEN]) field must also be asserted to enable error injection.</p>

Table continues on the next page...

Field	Function
	<p>After error injection is enabled, all subsequent read accesses incur one or more bit inversions as defined in the corresponding EICHDn_WORD registers. Error injection remains in effect until the error injection channel is manually disabled via software.</p> <p>Any write to the corresponding EICHDn_WORD registers clears the corresponding EICHEN[EICHnEN] field, disabling the error injection channel.</p> <p>0b - Error injection is disabled on Error Injection Channel 1 1b - Error injection is enabled on Error Injection Channel 1</p>
29 —	Reserved
28 —	Reserved
27 —	Reserved
26 —	Reserved
25 —	Reserved
24 —	Reserved
23 —	Reserved
22 —	Reserved
21 —	Reserved
20 —	Reserved
19 —	Reserved
18 —	Reserved
17 —	Reserved
16 —	Reserved
15 —	Reserved
14 —	Reserved
13 —	Reserved

Table continues on the next page...

EIM register descriptions

Field	Function
12 —	Reserved
11 —	Reserved
10 —	Reserved
9 —	Reserved
8 —	Reserved
7 —	Reserved
6 —	Reserved
5 —	Reserved
4 —	Reserved
3 —	Reserved
2 —	Reserved
1 —	Reserved
0 —	Reserved

21.3.4 Error Injection Channel Descriptor n, Word0 (EICHD0_WORD0 - EICHD1_WORD0)

21.3.4.1 Offset

Register	Offset
EICHD0_WORD0	100h
EICHD1_WORD0	200h

21.3.4.2 Function

The first word of the Error Injection Channel Descriptor defines a left-justified mask field: `CHKBIT_MASK`. Each bit of `CHKBIT_MASK` specifies whether the corresponding bit of the checkbit bus from the target RAM should be inverted or remain unmodified on read accesses. Successful write to this field clears the corresponding error injection channel valid bit, `EICHEN[EICH n EN]`.

21.3.4.3 Diagram

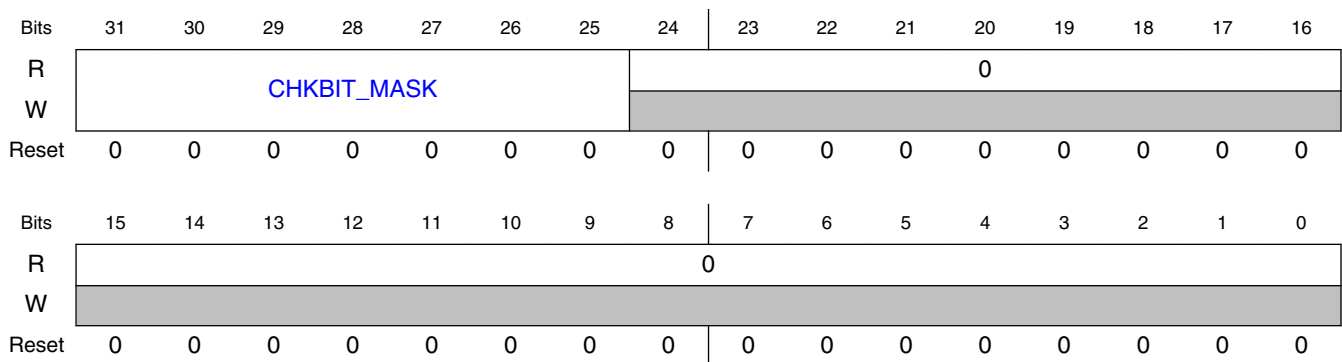

21.3.4.4 Fields

Field	Function									
31-25 CHKBIT_MASK	<p>Checkbit Mask</p> <p>This field defines a bit-mapped mask that specifies whether the corresponding bit of the checkbit bus from the target RAM should be inverted or remain unmodified.</p> <p>For any unique details about the mapping of <code>CHKBIT_MASK</code>'s bits to a channel's target RAM, see the chip-specific EIM information.</p> <p>The following table shows the width and bit range of <code>CHKBIT_MASK</code> for each channel.</p> <table border="1"> <thead> <tr> <th>Channel</th> <th>CHKBIT_MASK width (bits)</th> <th>CHKBIT_MASK bit range</th> </tr> </thead> <tbody> <tr> <td>0</td> <td>7</td> <td>6-0</td> </tr> <tr> <td>1</td> <td>7</td> <td>6-0</td> </tr> </tbody> </table> <p>NOTE: Because <code>CHKBIT_MASK</code> is left-justified, the highest bit in the bit range is always in the position of the most significant bit. For a <code>CHKBIT_MASK</code> that is 7 bits wide, <code>CHKBIT_MASK[6]</code> is in the position of the most significant bit. For any <code>CHKBIT_MASK</code> with a smaller width, the highest bit in that width's bit range is in the position of the most significant bit.</p> <p>0b - The corresponding bit of the checkbit bus remains unmodified.</p>	Channel	CHKBIT_MASK width (bits)	CHKBIT_MASK bit range	0	7	6-0	1	7	6-0
Channel	CHKBIT_MASK width (bits)	CHKBIT_MASK bit range								
0	7	6-0								
1	7	6-0								

Table continues on the next page...

EIM register descriptions

Field	Function
	1b - The corresponding bit of the checkbit bus is inverted.
24-0	Reserved
—	

21.3.5 Error Injection Channel Descriptor n, Word1 (EICHD0_WORD1 - EICHD1_WORD1)

21.3.5.1 Offset

Register	Offset
EICHD0_WORD1	104h
EICHD1_WORD1	204h

21.3.5.2 Function

The second word of the Error Injection Channel Descriptor defines a right-justified mask field. The bits in B0_3DATA_MASK correspond to bytes 0–3 of the read data bus. Each bit specifies whether the corresponding bit of the read data bus from the target RAM should be inverted or remain unmodified on read accesses. A successful write to this field clears the corresponding error injection channel valid field, EICHEN[EICHnEN].

21.3.5.3 Diagram

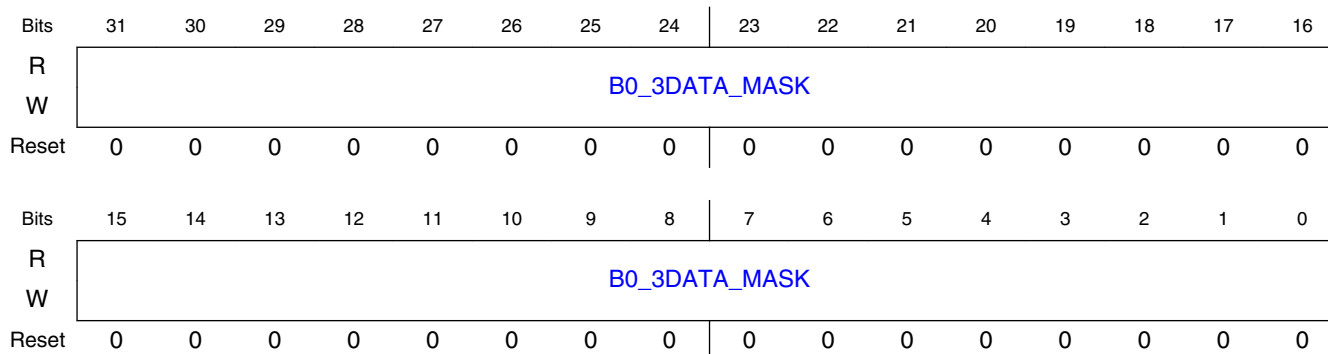

21.3.5.4 Fields

Field	Function
31-0	Data Mask Bytes 0-3
B0_3DATA_MASK	<p>This field defines a bit-mapped mask that specifies whether the corresponding bit of the read data bus from the target RAM should be inverted or remain unmodified.</p> <p>NOTE: For each channel: For the exact width of B0_3DATA_MASK and the specific DATA_MASK bits to which B0_3DATA_MASK corresponds, see Error injection channel descriptor: DATA_MASK details.</p> <p>0b - The corresponding bit of bytes 0-3 on the read data bus remains unmodified. 1b - The corresponding bit of bytes 0-3 on the read data bus is inverted.</p>

21.4 Functional description

The EIM provides protection against accidental enabling and reconfiguration of the error injection function by enforcing a two-stage enablement mechanism. To properly enable the error injection mechanism for a channel:

- Write 1 to the EICHEN[EICH n EN] field, where n denotes the channel number.
- Write 1 to EIMCR[GEIEN].

NOTE

When the use case for a channel requires writing any EICH Dn _WORD register, write the EICH Dn _WORD register before executing the two-stage enablement mechanism. A successful write to any EICH Dn _WORD register clears the corresponding EICHEN[EICH n EN] field.

The EIM supports 2 error injection channels. Each channel:

- Is assigned to a single memory array interface.
- Intercepts the assigned memory read data bus and checkbit bus and injects errors by inverting the value transmitted for selected bits on each bus line.

On a memory read access, the applicable EICH Dn _WORD register defines which bit of the read data and/or checkbit bus to invert.

Figure 21-1 depicts the interception and override of a 64-bit read data bus and an 8-bit checkbit data bus for an example memory array.

21.4.1 Error injection scenarios

The EIM supports these cases of error injection:

- To generate a single-bit error, invert only 1 bit of the CHKBIT_MASK or DATA_MASK in the EICHD n _WORD registers.
- To generate a multi-bit error, invert only 2 bits of the CHKBIT_MASK or DATA_MASK in the EICHD n _WORD registers.

NOTE

An attempt to invert more than 2 bits in one operation might result in undefined behavior.

See below pseudocode:

- Program the one to two bits of the data bus to invert (EICHD x _WORD y)
- Enable the channel to allow data inversions (EICH x EN)
- Enable the EIM module global enable to start error injections (EIMCR)
- Read from the memory being injected to see the error
- Read from the memory being injected to see the error
- In the error handling routine
- Turn off the EIM global module enable (EIMCR)
- Disable the EIM channel (EICH x EN)
- Clear the data inversion register (EICHD x _WORD y)

Chapter 22

Error Reporting Module (ERM)

22.1 Chip-specific ERM information

S32K1xx and S32K14xW has one instance of the ERM.

22.1.1 Sources of memory error events

Each ERM channel n corresponds to a source of potential memory error events. The following table shows the channel assignments.

Table 22-1. Memory error event sources for ERM channels

ERM channel n	Memory n event source ¹		
	S32K14x	S32K14xW	S32K11x
0	SRAM_L	SRAM_L	SRAM_U
1	SRAM_U	SRAM_U	Reserved

1. Throughout this chapter, "Memory n " designates the memory array sourced by ERM channel n .

22.2 Introduction

22.2.1 Overview

The Error Reporting Module (ERM) provides information and optional interrupt notification on memory error events associated with Error Correction Code (ECC). The ERM collects ECC events on memory accesses for platform local memory arrays, such as flash memory, system RAM, or peripheral RAMs. See the chip-specific ERM information for details about supported memory sources and specific memory channel assignments.

22.2.2 Features

The ERM includes these features:

- Capturing of address information on single-bit correction and non-correctable ECC events
- Optional interrupt notification on captured ECC events
- Support for ECC event capturing for memory sources, with individual reporting fields and interrupt configuration per memory channel

22.3 ERM register descriptions

The ERM provides an IPS programming model mapped to an on-platform peripheral slot.

All system bus masters can access the programming model:

- Only in supervisor mode
- Using only 32-bit (word) accesses

Any of the following attempted references to the programming model generates an IPS error termination:

- In user mode
- Using non-32-bit access sizes

Attempted accesses to undefined (reserved) memory regions can result in undefined behavior.

Attempted updates to the programming model when the ERM is in the middle of an operation result in non-deterministic behavior.

22.3.1 ERM memory map

ERM base address: 4001_8000h

Offset	Register	Width (In bits)	Access	Reset value
0h	ERM Configuration Register 0 (CR0)	32	RW	0000_0000h
10h	ERM Status Register 0 (SR0)	32	W1C	0000_0000h

Table continues on the next page...

Offset	Register	Width (In bits)	Access	Reset value
100h	ERM Memory n Error Address Register (EAR0)	32	RO	0000_0000h
110h	ERM Memory n Error Address Register (EAR1)	32	RO	0000_0000h

22.3.2 ERM Configuration Register 0 (CR0)

22.3.2.1 Offset

Register	Offset
CR0	0h

22.3.2.2 Function

This 32-bit control register configures the interrupt notification capability for:

- Channel 0
- Channel 1

22.3.2.3 Diagram

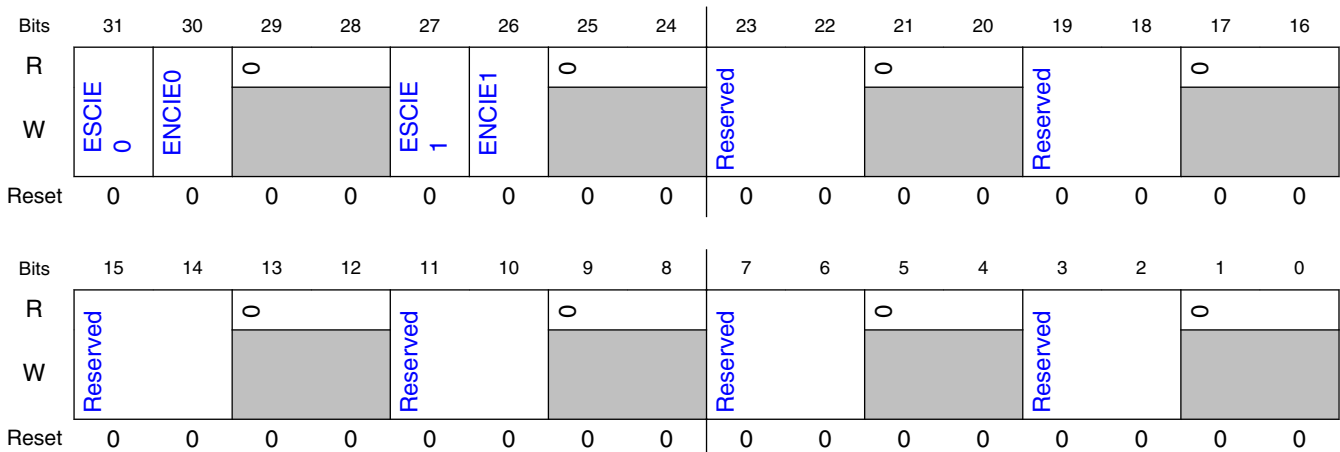

22.3.2.4 Fields

Field	Function
31 ESCIE0	ESCIE0 Enable Memory 0 Single Correction Interrupt Notification This field is initialized by hardware reset. NOTE: See the chip-specific ERM information for details on Memory 0 mapping. 0b - Interrupt notification of Memory 0 single-bit correction events is disabled. 1b - Interrupt notification of Memory 0 single-bit correction events is enabled.
30 ENCIE0	ENCIE0 Enable Memory 0 Non-Correctable Interrupt Notification This field is initialized by hardware reset. NOTE: See the chip-specific ERM information for details on Memory 0 mapping. 0b - Interrupt notification of Memory 0 non-correctable error events is disabled. 1b - Interrupt notification of Memory 0 non-correctable error events is enabled.
29-28 —	Reserved
27 ESCIE1	ESCIE1 Enable Memory 1 Single Correction Interrupt Notification This field is initialized by hardware reset. NOTE: See the chip-specific ERM information for details on Memory 1 mapping. 0b - Interrupt notification of Memory 1 single-bit correction events is disabled. 1b - Interrupt notification of Memory 1 single-bit correction events is enabled.
26 ENCIE1	ENCIE1 Enable Memory 1 Non-Correctable Interrupt Notification This field is initialized by hardware reset. NOTE: See the chip-specific ERM information for details on Memory 1 mapping. 0b - Interrupt notification of Memory 1 non-correctable error events is disabled. 1b - Interrupt notification of Memory 1 non-correctable error events is enabled.
25-24 —	Reserved
23-22 —	Reserved
21-20 —	Reserved
19-18 —	Reserved
17-16 —	Reserved
15-14 —	Reserved
13-12	Reserved

Table continues on the next page...

Field	Function
—	
11-10 —	Reserved
9-8 —	Reserved
7-6 —	Reserved
5-4 —	Reserved
3-2 —	Reserved
1-0 —	Reserved

22.3.3 ERM Status Register 0 (SR0)

22.3.3.1 Offset

Register	Offset
SR0	10h

22.3.3.2 Function

This 32-bit control register configures the interrupt notification capability for:

- Channel 0
- Channel 1

22.3.3.3 Diagram

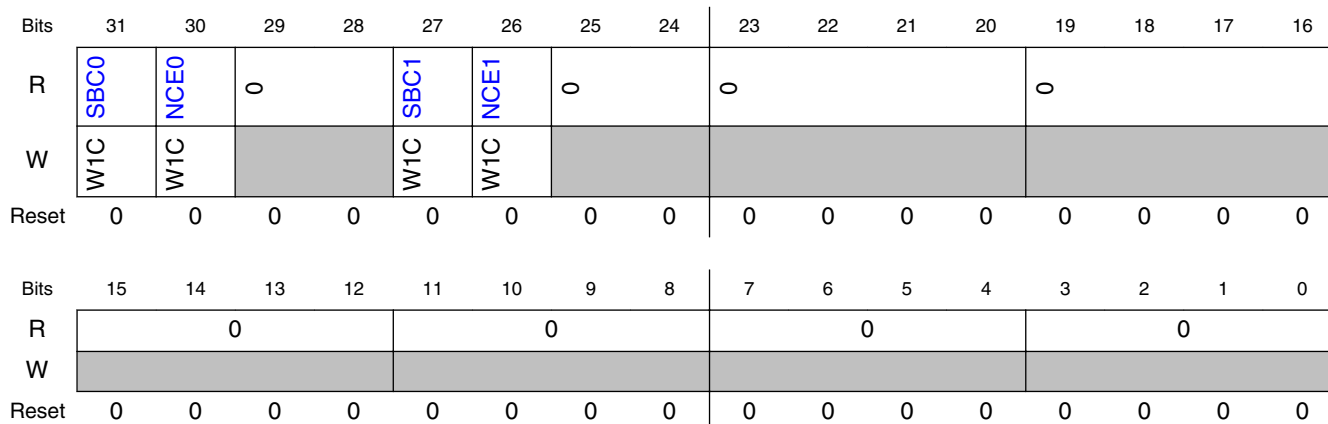

22.3.3.4 Fields

Field	Function
31 SBC0	<p>SBC0 Memory 0 Single-Bit Correction Event</p> <p>This field is initialized by hardware reset.</p> <p>Write 1 to clear this field. This write also clears the corresponding interrupt notification, if CR0[ESCIE0] is enabled.</p> <p>NOTE: See the chip-specific ERM information for details on Memory 0 mapping. 0b - No single-bit correction event on Memory 0 detected. 1b - Single-bit correction event on Memory 0 detected.</p>
30 NCE0	<p>NCE0 Memory 0 Non-Correctable Error Event</p> <p>This field is initialized by hardware reset.</p> <p>Write 1 to clear this field. This write also clears the corresponding interrupt notification, if CR0[ENCIE0] is enabled.</p> <p>NOTE: See the chip-specific ERM information for details on Memory 0 mapping. 0b - No non-correctable error event on Memory 0 detected. 1b - Non-correctable error event on Memory 0 detected.</p>
29-28 —	Reserved
27 SBC1	<p>SBC1 Memory 1 Single-Bit Correction Event</p> <p>This field is initialized by hardware reset.</p> <p>Write 1 to clear this field. This write also clears the corresponding interrupt notification, if CR0[ESCIE1] is enabled.</p> <p>NOTE: See the chip-specific ERM information for details on Memory 1 mapping.</p>

Table continues on the next page...

Field	Function
	0b - No single-bit correction event on Memory 1 detected. 1b - Single-bit correction event on Memory 1 detected.
26 NCE1	NCE1 Memory 1 Non-Correctable Error Event This field is initialized by hardware reset. Write 1 to clear this field. This write also clears the corresponding interrupt notification, if CR0[ENCIE1] is enabled. NOTE: See the chip-specific ERM information for details on Memory 1 mapping. 0b - No non-correctable error event on Memory 1 detected. 1b - Non-correctable error event on Memory 1 detected.
25-24 —	Reserved
23-20 —	Reserved
19-16 —	Reserved
15-12 —	Reserved
11-8 —	Reserved
7-4 —	Reserved
3-0 —	Reserved

22.3.4 ERM Memory n Error Address Register (EAR0 - EAR1)

22.3.4.1 Offset

Register	Offset
EAR0	100h
EAR1	110h

22.3.4.2 Function

Each ERM Memory n Error Address Register is a 32-bit register for capturing the address of the last ECC event in Memory n , where n denotes the memory channel. Any attempted write to EAR_n is ignored.

22.3.4.3 Diagram

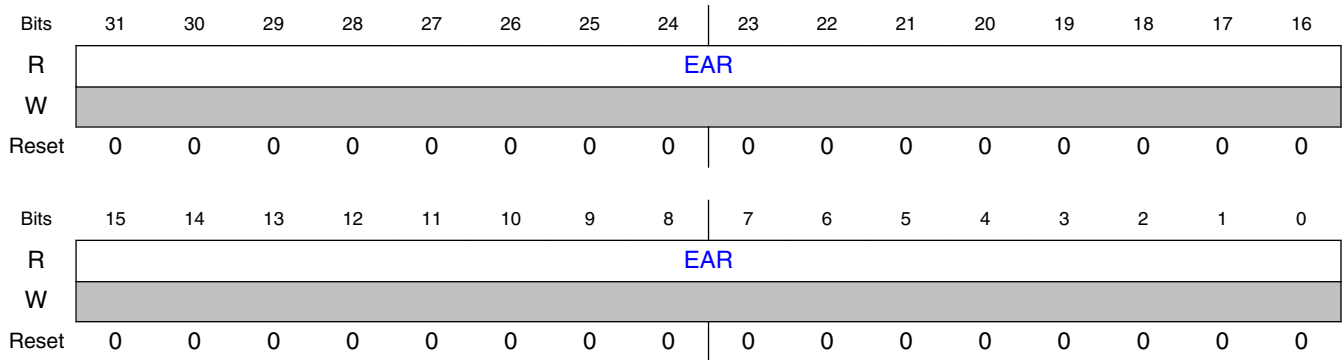

22.3.4.4 Fields

Field	Function
31-0	EAR
EAR	Memory n Error Address — This field contains the faulting system address of the last recorded ECC event on Memory n . NOTE: See the chip-specific ERM information for details on Memory n mapping.

22.4 Functional description

22.4.1 Single-bit correction events

When a single-bit correction event on Memory n is detected, the ERM:

- Records the event by changing the value of the applicable Status Register bit $SRx[SBCn]$ to 1.
- Records the corresponding access address that initiated the event in the Memory n Error Address Register: $EARn$ (if this register is present for the channel).

The ERM holds event information only for the last reported event.

To clear the record of an event, write 1 to $SRx[SBCn]$ to change its value to 0.

22.4.1.1 Optional interrupt notification for single-bit correction events

The ERM provides an option to generate an interrupt notification upon the report of a single-bit correction event. This sequence describes how to use the option:

1. To enable interrupt notification for single-bit correction events on Memory n , set $CRx[ESCIEn]$ to 1.
2. Subsequently, when a single-bit correction event on Memory n is detected, the ERM:
 - Records the event and address, as usual.
 - Additionally sends an interrupt notification corresponding to the event.
3. To clear both the record of an event and the corresponding interrupt notification, write 1 to $SRx[SBCn]$ to change its value to 0.

22.4.2 Non-correctable error events

When a non-correctable ECC error event on Memory n is detected, the ERM:

- Records the event by changing the value of the applicable Status Register bit: $SRx[NCEn]$ to 1.
- Records the corresponding access address that initiated the event in the Memory n Error Address Register: $EARn$ (if this register is present for the channel).

The ERM holds event information only for the last reported event.

To clear the record of an event, write 1 to $SRx[NCEn]$ to change its value to 0.

22.4.2.1 Optional interrupt notification for non-correctable error events

The ERM provides an option to generate an interrupt notification upon the report of a non-correctable ECC event. This sequence describes how to use the option:

1. To enable interrupt notifications for non-correctable error events on Memory n , set $CR_x[ENCIE_n]$ to 1.
2. Subsequently, when a non-correctable error event on Memory n is detected, the ERM:
 - Records the event and address as usual.
 - Additionally sends an interrupt notification corresponding to the event.
3. To clear both the record of an event and the corresponding interrupt notification, write 1 to $SR_x[NCE_n]$ to change its value to 0.

22.5 Initialization

For each ERM channel, prepare the corresponding memory array before enabling ERM interrupts about errors for that memory.

1. Initialize the memory to a known value so that the correct corresponding ECC codeword is stored.
2. During the memory's initialization, if the ERM captures information about any ECC error event, clear the corresponding $SR_x[SBC_n]$ or $SR_x[NCE_n]$ field that stores the record of the event.
3. Program the applicable $CR_x[ESCIEn]$ and $CR_x[ENCIE_n]$ fields to enable ERM interrupts as desired.

Chapter 23

Watchdog timer (WDOG)

23.1 Chip-specific WDOG information

23.1.1 WDOG clocks

The WDOG module has following selectable clock sources:

- Internal low power oscillator (LPO_CLK)
- Internal Slow IRC clock (SIRC)
- System oscillator clock (SOSC)
- Bus clock

NOTE

- For safety applications, WDOG should run on a different clock than CMU.
- WDOG_CNT reset read value can vary depending on timestamp, since it is a default running counter.

23.1.2 WDOG low-power modes

This table shows the WDOG low-power modes and the corresponding chip low-power modes.

Wait mode is not supported in this device. See [Module operation in available power modes](#) for details on available power modes.

23.1.3 Default watchdog timeout

The timeout depends on the watchdog counter clock source. Following initial power on the watchdog is clocked by the LPO128K_CLK and will issue a timeout after 1024 cycles. This results in the Watchdog timeout being generated after approximately 8 ms, which will force a MCU reset. To avoid this condition, please ensure that the watchdog is configured or refreshed before the 1024 cycles have elapsed.

23.1.4 Watchdog Timeout Reaction

The WDOG timeout reaction is by default configured to generate a system reset. It can be alternatively configured for an interrupt reaction followed by a reset event by appropriately configuring WDOG and RCM. When configured as an interrupt, the reset event will be raised by WDOG after some delay (delay configurable within RCM and fixed within WDOG).

The WDG feature is controlled by WDOG.CS whereas RGM feature is controlled by RCM.SRIE. The delay durations are different. For WDOG it is fixed 128 bus clock cycles. For RCM, it is configurable. The RCM IRQ is enabled when both SRIE[WDOG] and SRIE[GIE] are set.

Following table explains the behavior w.r.t. different configurations.

WDOG.CS[INT]	RCM.SRIE[WDOG]	RCM.SRIE[GIE]	Behavior
0	0	0	WDOG reset.
0	0	1	WDOG reset.
0	1	0	No IRQ. RCM delayed WDOG reset.
0	1	1	RCM IRQ. RCM delayed WDOG reset.
1	0	0	WDOG IRQ. WDOG delayed WDOG reset.
1	0	1	WDOG IRQ. WDOG delayed WDOG reset.
1	1	0	WDOG IRQ. WDOG delayed + RCM delayed WDOG reset.
1	1	1	WDOG IRQ ¹ . WDOG delayed + RCM delayed WDOG reset.

1. WDOG IRQ will be executed and RCM IRQ will be pending based on the fact that WDOG has lower number.

23.2 Introduction

The Watchdog Timer (WDOG) module is an independent timer that is available for system use. It provides a safety feature to ensure that software is executing as planned and that the CPU is not stuck in an infinite loop or executing unintended code. If the WDOG module is not serviced (refreshed) within a certain period, it resets the MCU.

23.2.1 Features

Features of the WDOG module include:

- Configurable clock source inputs independent from the bus clock
- Programmable timeout period
 - Programmable 16-bit timeout value
 - Optional fixed 256 clock prescaler when longer timeout periods are needed
- Robust write sequence for counter refresh
 - Refresh sequence of writing 0xA602 and then 0xB480
- Window mode option for the refresh mechanism
 - Programmable 16-bit window value
 - Provides robust check that program flow is faster than expected
 - Early refresh attempts trigger a reset.
- Optional timeout interrupt to allow post-processing diagnostics
 - Interrupt request to CPU with interrupt vector for an interrupt service routine (ISR)
 - Forced reset occurs 128 bus clocks after the interrupt vector fetch.
- Configuration bits are write-once-after-reset to ensure watchdog configuration cannot be mistakenly altered.
- Robust write sequence for unlocking write-once configuration bits

Memory map and register definition

- Unlock sequence of writing 0xC520 and then 0xD928 for allowing updates to write-once configuration bits
- Software must make updates within 128 bus clocks after unlocking and before WDOG closing unlock window.

23.2.2 Block diagram

The following figure shows a block diagram of the WDOG module.

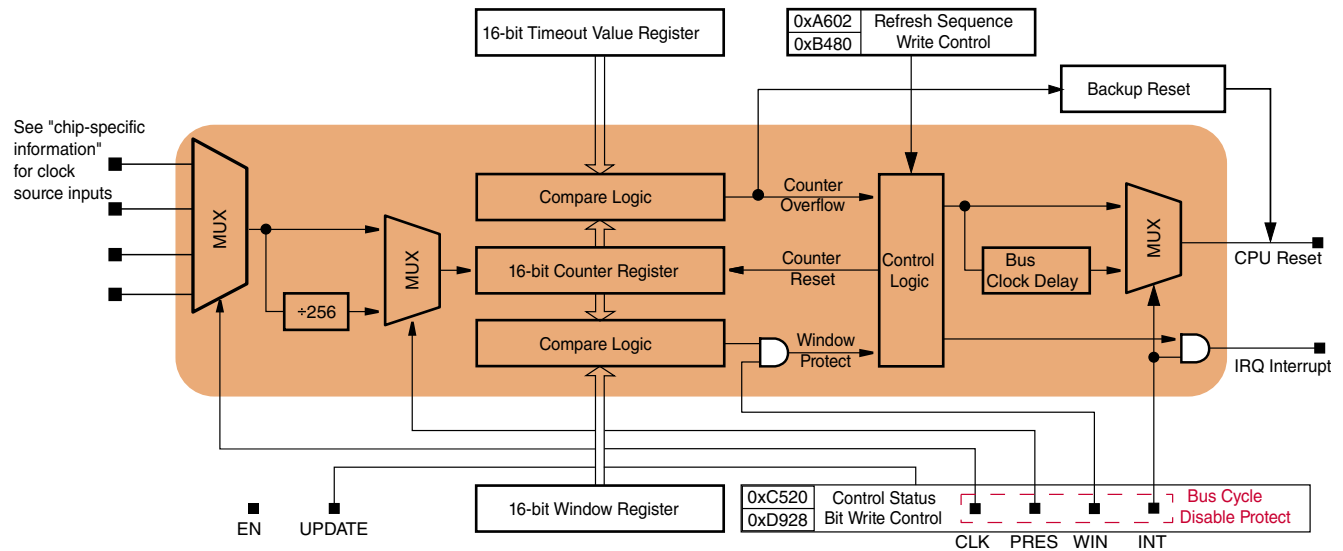

Figure 23-1. WDOG block diagram

23.3 Memory map and register definition

23.3.1 WDOG register descriptions

23.3.1.1 WDOG memory map

WDOG base address: 4005_2000h

Offset	Register	Width (In bits)	Access	Reset value
0h	Watchdog Control and Status Register (CS)	32	RW	0000_2980h
4h	Watchdog Counter Register (CNT)	32	RW	0000_0000h
8h	Watchdog Timeout Value Register (TOVAL)	32	RW	0000_0400h
Ch	Watchdog Window Register (WIN)	32	RW	0000_0000h

23.3.1.2 Watchdog Control and Status Register (CS)

23.3.1.2.1 Offset

Register	Offset
CS	0h

23.3.1.2.2 Function

This section describes the function of Watchdog Control and Status Register.

NOTE

TST is cleared (0:0) on POR only. Any other reset does not affect the value of this field.

23.3.1.2.3 Diagram

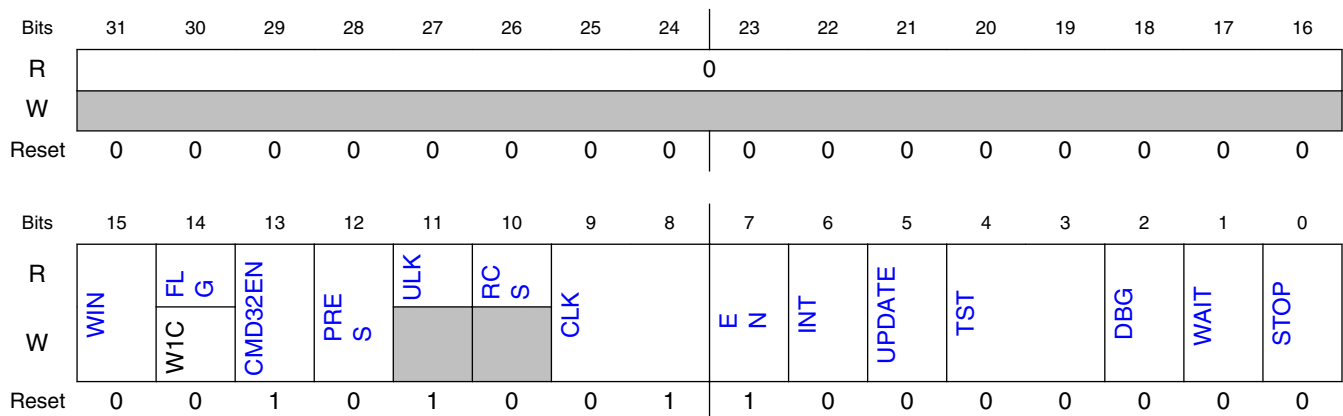

23.3.1.2.4 Fields

Field	Function
31-16 —	Reserved
15 WIN	<p>Watchdog Window</p> <p>This write-once bit enables window mode. See the Window mode section.</p> <p>0b - Window mode disabled. 1b - Window mode enabled.</p>
14 FLG	<p>Watchdog Interrupt Flag</p> <p>This bit is an interrupt indicator when INT is set in control and status register 1. Write 1 to clear it.</p> <p>0b - No interrupt occurred. 1b - An interrupt occurred.</p>
13 CMD32EN	<p>Enables or disables WDOG support for 32-bit (otherwise 16-bit or 8-bit) refresh/unlock command write words</p> <p>This is write-once field, and the user needs to unlock WDOG after writing this field for reconfiguration.</p> <p>0b - Disables support for 32-bit refresh/unlock command write words. Only 16-bit or 8-bit is supported. 1b - Enables support for 32-bit refresh/unlock command write words. 16-bit or 8-bit is NOT supported.</p>
12 PRES	<p>Watchdog prescaler</p> <p>This write-once bit enables a fixed 256 pre-scaling of watchdog counter reference clock. (The block diagram shows this clock divider option.)</p> <p>0b - 256 prescaler disabled. 1b - 256 prescaler enabled.</p>
11 ULK	<p>Unlock status</p> <p>This read-only bit indicates whether WDOG is unlocked or not.</p> <p>0b - WDOG is locked. 1b - WDOG is unlocked.</p>
10 RCS	<p>Reconfiguration Success</p> <p>This read-only bit indicates whether the reconfiguration is successful or not. Default reset value is 0. This bit is set when new configuration takes effect, and is cleared by successful unlock command.</p> <p>0b - Reconfiguring WDOG. 1b - Reconfiguration is successful.</p>
9-8 CLK	<p>Watchdog Clock</p> <p>This write-once field indicates the clock source that feeds the watchdog counter. See the "chip-specific information" section.</p>
7 EN	<p>Watchdog Enable</p> <p>This write-once bit enables the watchdog counter to start counting.</p> <p>0b - Watchdog disabled. 1b - Watchdog enabled.</p>
6 INT	<p>Watchdog Interrupt</p> <p>This write-once bit configures the watchdog to immediately generate an interrupt request upon a reset-triggering event (timeout or illegal write to the watchdog), before forcing a reset. After the interrupt vector fetch (which comes after the reset-triggering event), the reset occurs after a delay of 128 bus clocks.</p> <p>0b - Watchdog interrupts are disabled. Watchdog resets are not delayed. 1b - Watchdog interrupts are enabled. Watchdog resets are delayed by 128 bus clocks from the interrupt vector fetch.</p>

Table continues on the next page...

Field	Function
5 UPDATE	<p>Allow updates</p> <p>This write-once bit allows software to reconfigure the watchdog without a reset.</p> <p>0b - Updates not allowed. After the initial configuration, the watchdog cannot be later modified without forcing a reset.</p> <p>1b - Updates allowed. Software can modify the watchdog configuration registers within 128 bus clocks after performing the unlock write sequence.</p>
4-3 TST	<p>Watchdog Test</p> <p>Enables the fast test mode. The test mode allows software to exercise all bits of the counter to demonstrate that the watchdog is functioning properly. See the Fast testing of the watchdog section.</p> <p>This write-once field is cleared (0:0) on POR only. Any other reset does not affect the value of this field.</p> <p>00b - Watchdog test mode disabled.</p> <p>01b - Watchdog user mode enabled. (Watchdog test mode disabled.) After testing the watchdog, software should use this setting to indicate that the watchdog is functioning normally in user mode.</p> <p>10b - Watchdog test mode enabled, only the low byte is used. CNT[CNLOW] is compared with TOVAL[TOVALLOW].</p> <p>11b - Watchdog test mode enabled, only the high byte is used. CNT[CNTHIGH] is compared with TOVAL[TOVALHIGH].</p>
2 DBG	<p>Debug Enable</p> <p>This write-once bit enables the watchdog to operate when the chip is in debug mode.</p> <p>0b - Watchdog disabled in chip debug mode.</p> <p>1b - Watchdog enabled in chip debug mode.</p>
1 WAIT	<p>Wait Enable</p> <p>This write-once bit enables the watchdog to operate when the chip is in wait mode.</p> <p>0b - Watchdog disabled in chip wait mode.</p> <p>1b - Watchdog enabled in chip wait mode.</p>
0 STOP	<p>Stop Enable</p> <p>This write-once bit enables the watchdog to operate when the chip is in stop mode.</p> <p>0b - Watchdog disabled in chip stop mode.</p> <p>1b - Watchdog enabled in chip stop mode.</p>

23.3.1.3 Watchdog Counter Register (CNT)

23.3.1.3.1 Offset

Register	Offset
CNT	4h

23.3.1.3.2 Function

This section describes the watchdog counter register.

Memory map and register definition

The watchdog counter register provides access to the value of the free-running watchdog counter. Software can read the counter register at any time.

Software cannot write directly to the watchdog counter; however, two write sequences to these registers have special functions:

1. The *refresh sequence* resets the watchdog counter to 0x0000. See the "Refreshing the Watchdog" section.
2. The *unlock sequence* allows the watchdog to be reconfigured without forcing a reset (when CS[UPDATE] = 1). See the "Configure for reconfigurable" section.

NOTE

All other writes to this register are illegal and force a reset.

23.3.1.3.3 Diagram

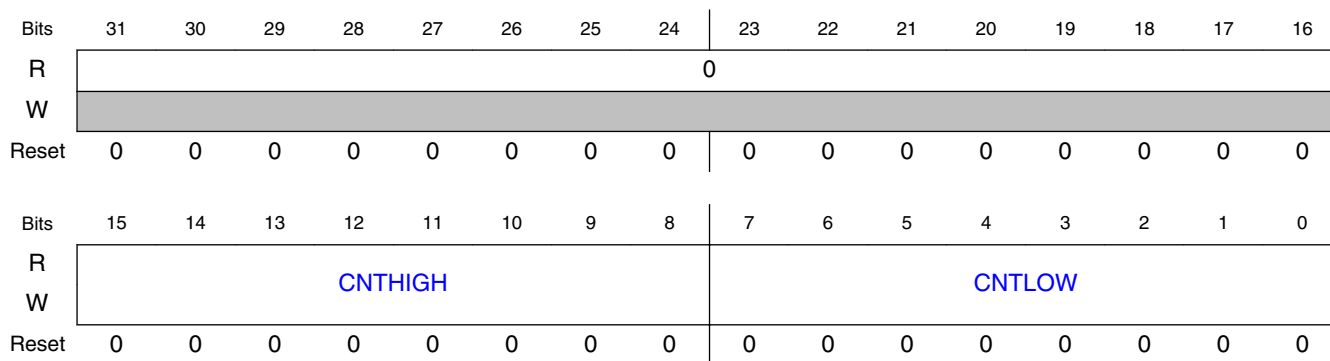

23.3.1.3.4 Fields

Field	Function
31-16 —	Reserved
15-8 CNTHIGH	High byte of the Watchdog Counter
7-0 CNTLOW	Low byte of the Watchdog Counter

23.3.1.4 Watchdog Timeout Value Register (TOVAL)

23.3.1.4.1 Offset

Register	Offset
TOVAL	8h

23.3.1.4.2 Function

This section describes the watchdog timeout value register. TOVAL contains the 16-bit value used to set the timeout period of the watchdog.

The watchdog counter (CNT) is continuously compared with the timeout value (TOVAL). If the counter reaches the timeout value, the watchdog forces a reset triggering event.

NOTE

Do not write 0 to the TOVAL register (if CS[TST]=11b, then TOVALHIGH cannot be written as 0; if CS[TST]=10b, then TOVALLOW cannot be 0); otherwise, the watchdog always generates a reset.

23.3.1.4.3 Diagram

Bits	31	30	29	28	27	26	25	24	23	22	21	20	19	18	17	16
R	0															
W																
Reset	0	0	0	0	0	0	0	0	0	0	0	0	0	0	0	0
Bits	15	14	13	12	11	10	9	8	7	6	5	4	3	2	1	0
R	TOVALHIGH								TOVALLOW							
W																
Reset	0	0	0	0	0	1	0	0	0	0	0	0	0	0	0	0

23.3.1.4.4 Fields

Field	Function
31-16 —	Reserved
15-8 TOVALHIGH	High byte of the timeout value
7-0 TOVALLOW	Low byte of the timeout value

23.3.1.5 Watchdog Window Register (WIN)

23.3.1.5.1 Offset

Register	Offset
WIN	Ch

23.3.1.5.2 Function

This section describes the watchdog window register. When window mode is enabled (CS[WIN] is set), The WIN register determines the earliest time that a refresh sequence is considered valid. See the [Watchdog refresh mechanism](#) section.

The WIN register value must be less than the TOVAL register value.

23.3.1.5.3 Diagram

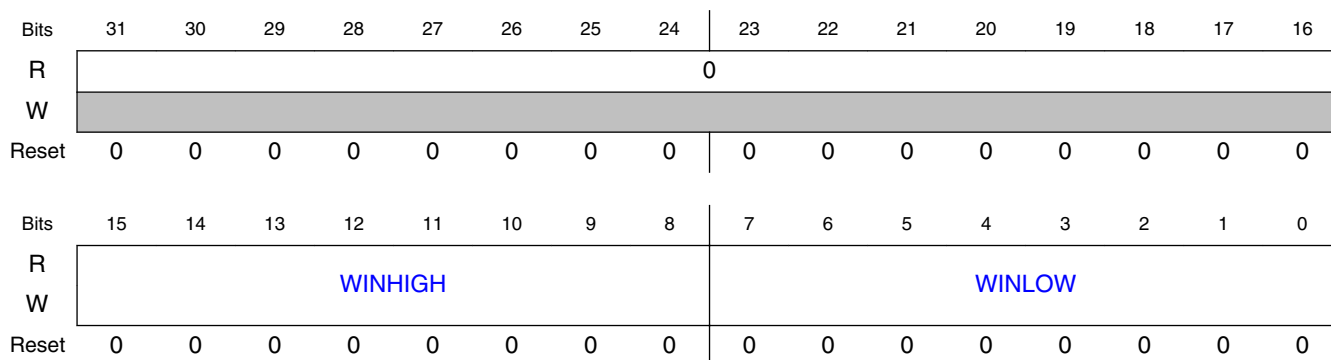

23.3.1.5.4 Fields

Field	Function
31-16 —	Reserved
15-8 WINHIGH	High byte of Watchdog Window
7-0 WINLOW	Low byte of Watchdog Window

23.4 Functional description

The WDOG module provides a fail safe mechanism to ensure the system can be reset to a known state of operation in case of system failure, such as the CPU clock stopping or there being a run away condition in the software code. The watchdog counter runs continuously off a selectable clock source and expects to be serviced (refreshed) periodically. If it is not, it generates a reset triggering event.

23.4.1 Clock source

The watchdog counter has the clock source options selected by programming CS[CLK]. See the "chip-specific information" section for available clock inputs and the default option for this device.

The options allow software to select a clock source independent of the bus clock for applications that need to meet more robust safety requirements. Using a clock source other than the bus clock ensures that the watchdog counter continues to run if the bus clock is somehow halted; see [Backup reset](#).

NOTE

The *default* clock source of WDOG should be enabled after its functional reset is deasserted, for the WDOG module to function properly.

An optional fixed prescaler for all clock sources allows for longer timeout periods. When CS[PRES] is set, the clock source is prescaled by 256 before clocking the watchdog counter.

The following table summarizes the different watchdog timeout periods which could be available, as an example.

Table 23-1. Watchdog timeout availability

Reference clock	Prescaler	Watchdog time-out availability
REF_CLK	Pass through	1×RCP to 65535×RCP ¹
	Enable	256×RCP to 16776960×RCP

1. RCP means Reference Clock Period.

NOTE

When the programmer switches clock sources during reconfiguration, the watchdog hardware holds the counter at zero for 2.5 periods of the previous clock source and 2.5

periods of the new clock source after the configuration time period (128 bus clocks) ends. This delay ensures a smooth transition before restarting the counter with the new configuration.

23.4.2 Watchdog refresh mechanism

The watchdog resets the MCU if the watchdog counter is not refreshed. A robust refresh mechanism makes it very unlikely that the watchdog can be refreshed by runaway code.

To refresh the watchdog counter, software must execute a refresh write sequence before the timeout period expires. In addition, if window mode is used, software must not start the refresh sequence until after the time value set in the WIN register. See the following figure.

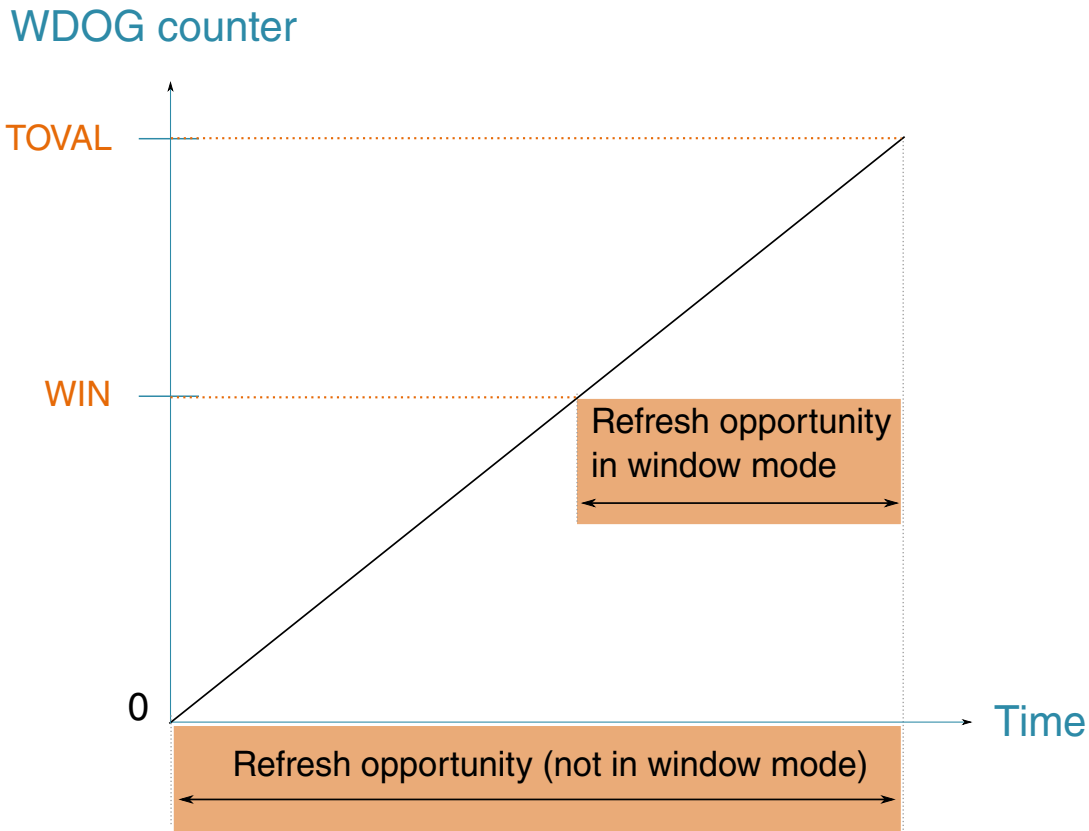

Figure 23-2. Refresh opportunity for the Watchdog counter

23.4.2.1 Window mode

Software finishing its main control loop faster than expected could be an indication of a problem. Depending on the requirements of the application, the WDOG can be programmed to force a reset when refresh attempts are early.

When Window mode is enabled, the watchdog must be refreshed after the counter has reached a minimum expected time value; otherwise, the watchdog resets the MCU. The minimum expected time value is specified in the WIN register. Setting CS[WIN] enables Window mode.

23.4.2.2 Refreshing the Watchdog

The refresh write sequence can be

- either two 16-bit writes (0xA602, 0xB480) or four 8-bit writes (0xA6, 0x02, 0xB4, 0x80) if WDOG_CS[CMD32EN] is 0;
- one 32-bit write (0xB480_A602) if WDOG_CS[CMD32EN] is 1.

to the CNT register. Both methods must occur before the WDG timeout; otherwise, the watchdog resets the MCU.

Note

Before starting the refresh sequence, disable the global interrupts. Otherwise, an interrupt could effectively invalidate the refresh sequence, if the interrupt occurs before the refresh writes finish. After the sequence finishes, restore the global interrupt control state.

The example codes can be found at the end of this chapter.

23.4.3 Configuring the Watchdog

23.4.3.1 Configuring the Watchdog Once

All watchdog control bits, timeout value, and window value are write-once after reset . This means that after a write has occurred they cannot be changed unless a reset occurs. This is guaranteed by the user configuring the window and timeout value first, followed by the other control bits, and ensuring that CS[UPDATE] is also set to 0.

This provides a robust mechanism to configure the watchdog and ensure that a runaway condition cannot mistakenly disable or modify the watchdog configuration after configured.

The new configuration takes effect only after all registers except CNT are written after reset. Otherwise, the WDOG uses the reset values by default. If window mode is not used (CS[WIN] is 0), writing to WIN is not required to make the new configuration take effect.

23.4.3.2 Reconfiguring the Watchdog

In some cases (like when supporting a bootloader function), you may want to reconfigure or disable the watchdog, *without forcing a reset first*.

- By setting CS[UPDATE] to 1 on the initial configuration of the watchdog after a reset, you can reconfigure the watchdog at any time by executing an unlock sequence.
- Conversely, if CS[UPDATE] remains 0, the only way to reconfigure the watchdog is by initiating a reset.

The unlock sequence is similar to the refresh sequence but uses different values.

23.4.3.2.1 Unlocking the Watchdog

The unlock sequence is a write to the CNT register of 0xC520 followed by 0xD928 within 16 bus clocks at any time after the watchdog has been configured. On completing the unlock sequence, the user must reconfigure the watchdog within 128 bus clocks; otherwise, the watchdog closes the unlock window.

NOTE

Due to the 128 bus clocks requirement for reconfiguring the watchdog, some delays must be inserted before executing STOP or WAIT instructions after reconfiguring the watchdog. This ensures that the watchdog's new configuration takes effect before the MCU enters low power mode. Otherwise, the MCU may not be waken up from low power mode.

The example codes can be found at end of this chapter.

23.4.4 Using interrupts to delay resets

- **When interrupts are enabled (CS[INT] = 1):** After a reset-triggering event (like a counter timeout or invalid refresh attempt), the watchdog first generates an interrupt request. Next, the watchdog delays 128 bus clocks (from the interrupt vector fetch, not the reset-triggering event) before forcing a reset, to allow the interrupt service routine (ISR) to perform tasks (like analyzing the stack to debug code).
- **When interrupts are disabled (CS[INT] = 0):** the watchdog does not delay the forcing a reset.

23.4.5 Backup reset

NOTE

A clock source other than the bus clock must be used as the reference clock for the counter; otherwise, the backup reset function is not available.

The backup reset function is a safeguard feature that independently generates a reset in case the main WDOG logic loses its clock (the bus clock) and can no longer monitor the counter. If the watchdog counter overflows twice in succession (without an intervening reset), the backup reset function takes effect and generates a reset.

Backup reset becomes valid when interrupt is enabled and the watchdog clock is from non bus clock. If interrupt is enabled, once the bus clock is cut off before exiting interrupt routine, the normal watchdog reset will be blocked. Under this case, the second overflow will cause backup reset directly.

23.4.6 Functionality in debug and low-power modes

By default, the watchdog is not functional in Debug mode, Wait mode, or Stop mode. However, the watchdog can remain functional in these modes as follows:

- **For Debug mode,** set CS[DBG]. (This way the watchdog is functional in Debug mode even when the CPU is held by the Debug module.)
- **For Wait mode,** set CS[WAIT].
- **For Stop mode,** set CS[STOP], CS[WAIT], and ensure the clock source is active in Stop mode.

NOTE

The watchdog can generate interrupt in Stop mode.

For Debug mode and Stop mode, in addition to the above configurations, a clock source other than the bus clock must be used as the reference clock for the counter; otherwise, the watchdog cannot function.

23.4.7 Fast testing of the watchdog

Before executing application code in safety critical applications, users are required to test that the watchdog works as expected and resets the MCU. Testing every bit of a 16-bit counter by letting it run to the overflow value takes a relatively long time (64 k clocks).

To help minimize the startup delay for application code after reset, the watchdog has a feature to test the watchdog more quickly by splitting the counter into its constituent byte-wide stages. The low and high bytes are run independently and tested for timeout against the corresponding byte of the timeout value register. (For complete coverage when testing the high byte of the counter, the test feature feeds the input clock via the 8th bit of the low byte, thus ensuring that the overflow connection from the low byte to the high byte is tested.)

Using this test feature reduces the test time to 512 clocks (not including overhead, such as user configuration and reset vector fetches). To further speed testing, use a faster clock (such as the bus clock) for the counter reference.

On a power-on reset, the POR bit in the system reset register is set, indicating the user should perform the WDOG fast test.

23.4.7.1 Testing each byte of the counter

The test procedure follows these steps:

1. Program the preferred watchdog timeout value in the TOVAL register during the watchdog configuration time period.
2. Select a byte of the counter to test using the CS[TST] = 10b for the low byte; CS[TST] = 11b for the high byte.
3. Wait for the watchdog to timeout. Optionally, in the idle loop, increment RAM locations as a parallel software counter for later comparison. Because the RAM is not affected by a watchdog reset, the timeout period of the watchdog counter can be compared with the software counter to verify the timeout period has occurred as expected.
4. The watchdog counter times out and forces a reset.
5. Confirm the WDOG flag in the system reset register is set, indicating that the watchdog caused the reset. (The POR flag remains clear.)

6. Confirm that CS[TST] shows a test (10b or 11b) was performed.

If confirmed, the count and compare functions work for the selected byte. Repeat the procedure, selecting the other byte in step 2.

NOTE

CS[TST] is cleared by a POR only and not affected by other resets.

23.4.7.2 Entering user mode

After successfully testing the low and high bytes of the watchdog counter, the user can configure CS[TST] to 01b to indicate the watchdog is ready for use in application user mode. Thus if a reset occurs again, software can recognize the reset trigger as a real watchdog reset caused by runaway or faulty application code.

As an ongoing test when using the default clock source, software can periodically read the CNT register to ensure the counter is being incremented.

23.5 Application Information

The watchdog is enabled by default after reset. To disable or reconfigure the watchdog, it is better to be done before the first watchdog timeout. It is suggested to disable or reconfigure the watchdog at the very beginning of the software code, e.g. beginning of the startup or main function.

NOTE

When the watchdog is configured by user, it needs at least 2.5 periods of watchdog clock to take effect. This means interval between two configures by user must be larger than 2.5 clocks.

NOTE

When Chip startup from BOOT ROM then jump to flash, the watchdog would be disabled in the beginning of bootloader, and enabled when bootloader exits. If there is any code in the flash program want to reconfigure the watchdog, it must be run 2.5 watchdog clocks later after the bootloader exits.

To disable or reconfigure the watchdog without forcing a reset, WDOG_CS[UPDATE] bit must be set during the initial configuration of the WDOG module. Then, the unlock sequence can be used at any time within the timeout limit to reconfigure the watchdog.

23.5.1 Disable Watchdog

To disable the watchdog, first do unlock sequence, then unset the WDOG_CS[EN] bit. The code snippet below shows an example for 32-bit write.

```
DisableInterrupts; // disable global interrupt
WDOG_CNT = 0xD928C520; //unlock watchdog
WDOG_CS &= ~WDOG_CS_EN_MASK; //disable watchdog
EnableInterrupts; //enable global interrupt
```

23.5.2 Disable Watchdog after Reset

All of watchdog registers are unlocked by reset. Therefore, unlock sequence is unnecessary, but it needs to write all of watchdog registers to make the new configuration take effect. The code snippet below shows an example of disabling watchdog after reset.

```
DisableInterrupts; // disable global interrupt
WDOG_CS &= ~WDOG_CS_EN_MASK; // disable watchdog
WDOG_TOVAL= 0xFFFF;
while(WDOG_CS[ULK]); // waiting for lock
while(~WDOG_CS[RCS]); // waiting for new configuration to take effect
EnableInterrupts; // enable global interrupt
```

23.5.3 Configure Watchdog

The watchdog can be configured once by set the WDOG_CS[UPDATE]=0. After that, the watchdog cannot be reconfigured until a reset. If set WDOG_CS[UPDATE]=1 when configuring the watchdog, the watchdog can be reconfigured without forcing a reset. The following example code shows how to configure the watchdog without window mode, clock source as LPO, interrupt enabled and timeout value to 256 clocks. The code snippet below shows an example for 32-bit write.

Configure once

```
DisableInterrupts; // disable global interrupt
WDOG_CNT = 0xD928C520; //unlock watchdog
while(WDOG_CS[ULK]==0); //wait until registers are unlocked
WDOG_TOVAL = 256; //set timeout value
WDOG_CS = WDOG_CS_EN(1) | WDOG_CS_CLK(1) | WDOG_CS_INT(1) |
          WDOG_CS_WIN(0) | WDOG_CS_UPDATE(0);
while(WDOG_CS[RCS]==0); //wait until new configuration takes effect
EnableInterrupts; //enable global interrupt
```

Configure for reconfigurable

```
DisableInterrupts; //disable global interrupt
WDOG_CNT = 0xD928C520; //unlock watchdog
while(WDOG_CS[ULK]==0); //wait until registers are unlocked
WDOG_TOVAL = 256; //set timeout value
WDOG_CS = WDOG_CS_EN(1) | WDOG_CS_CLK(1) | WDOG_CS_INT(1) |
```

```
        WDOG_CS_WIN(0) | WDOG_CS_UPDATE(1);  
while(WDOG_CS[RCS]==0); //wait until new configuration takes effect  
EnableInterrupts; //enable global interrupt
```

23.5.4 Refreshing the Watchdog

To refresh the watchdog and reset the watchdog counter to zero, a refresh sequence is required. The code snippet below shows an example for 32-bit write.

```
DisableInterrupts; // disable global interrupt  
WDOG_CNT = 0xB480A602; // refresh watchdog  
EnableInterrupts; // enable global interrupt
```

Chapter 24

Cyclic Redundancy Check (CRC)

24.1 Chip-specific CRC information

NOTE

All input bytes need to be byte transposed. Any additional transpose will be governed by the CRC protocol requirement.

24.2 Introduction

The cyclic redundancy check (CRC) module generates 16/32-bit CRC code for error detection.

The CRC module provides a programmable polynomial and other parameters required to implement a 16-bit or 32-bit CRC standard.

The 16/32-bit code is calculated for 32 bits of data at a time.

24.2.1 Features

Features of the CRC module include:

- Hardware CRC generator circuit using a 16-bit or 32-bit programmable shift register
- Programmable initial seed value and polynomial
- Option to transpose input data or output data (the CRC result) bitwise or byte-wise. This option is required for certain CRC standards. A byte-wise transpose operation is not possible when accessing the CRC data register via 8-bit accesses. In this case, the user's software must perform the byte-wise transpose function.
- Option for inversion of final CRC result
- 32-bit CPU register programming interface

24.2.2 Block diagram

The following is a block diagram of the CRC.

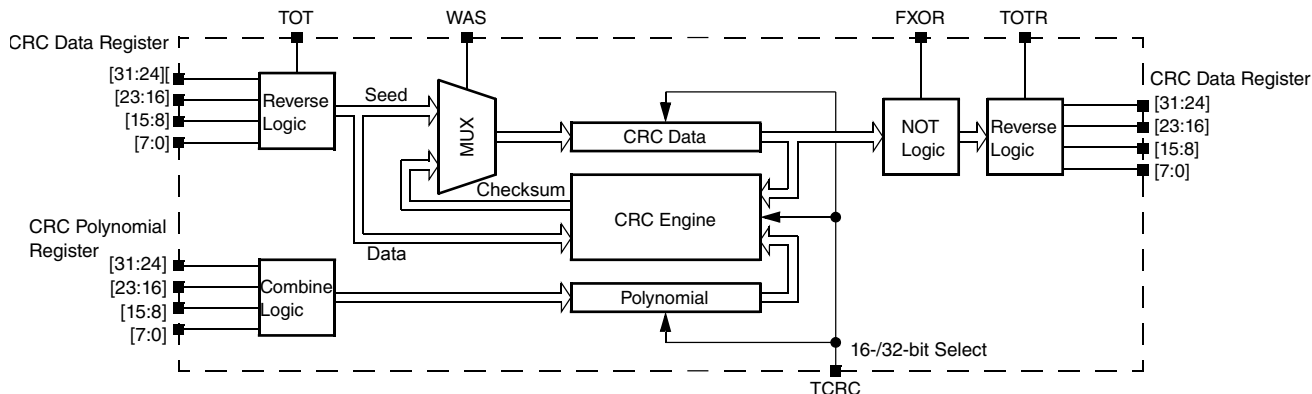

Figure 24-1. Programmable cyclic redundancy check (CRC) block diagram

24.2.3 Modes of operation

Various MCU modes affect the CRC module's functionality.

24.2.3.1 Run mode

This is the basic mode of operation.

24.2.3.2 Low-power modes (Stop)

Any CRC calculation in progress stops when the device enters a low-power mode that disables the module clock. It resumes after the clock is enabled or via the system reset for exiting the low-power mode. Clock gating for this module is dependent on the device.

24.3 Memory map and register descriptions

NOTE

Write access to the register addresses not mapped to the peripheral but included in the address space of the peripheral

may result in unpredictable functionality. The CRC module should be reconfigured if a transfer error occurs

24.3.1 CRC register descriptions

24.3.1.1 CRC Memory map

CRC base address: 4003_2000h

Offset	Register	Width (In bits)	Access	Reset value
0h	CRC Data register (DATA)	32	RW	FFFF_FFFFh
4h	CRC Polynomial register (GPOLY)	32	RW	0000_1021h
8h	CRC Control register (CTRL)	32	RW	0000_0000h

24.3.1.2 CRC Data register (DATA)

24.3.1.2.1 Offset

Register	Offset
DATA	0h

24.3.1.2.2 Function

The CRC Data register contains the value of the seed, data, and checksum. When CTRL[WAS] is set, any write to the data register is regarded as the seed value. When CTRL[WAS] is cleared, any write to the data register is regarded as data for general CRC computation.

In 16-bit CRC mode, the HU and HL fields are not used for programming the seed value, and reads of these fields return an indeterminate value. In 32-bit CRC mode, all fields are used for programming the seed value.

When programming data values, the values can be written 8 bits, 16 bits, or 32 bits at a time, provided all bytes are contiguous; with MSB of data value written first.

After all data values are written, the CRC result can be read from this data register. In 16-bit CRC mode, the CRC result is available in the LU and LL fields. In 32-bit CRC mode, all fields contain the result. Reads of this register at any time return the intermediate CRC value, provided the CRC module is configured.

24.3.1.2.3 Diagram

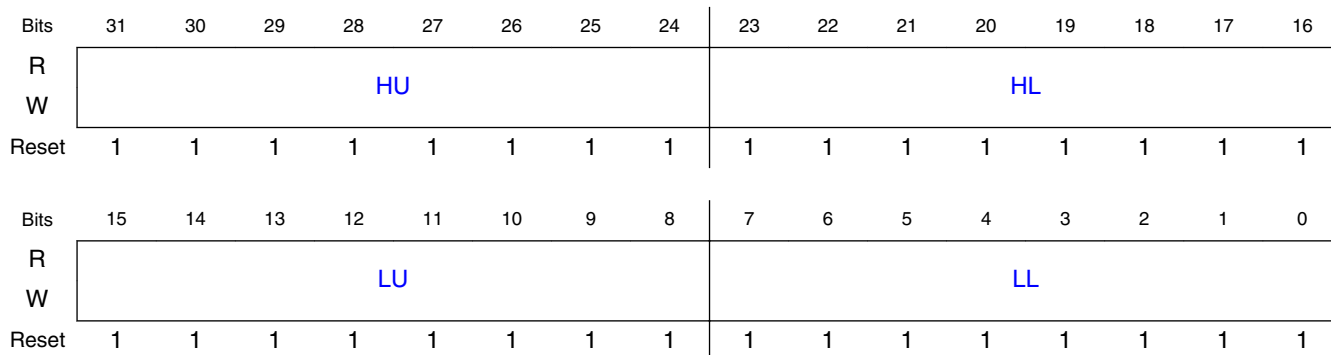

24.3.1.2.4 Fields

Field	Function
31-24 HU	CRC High Upper Byte In 16-bit CRC mode (CTRL[TCRC] is 0), this field is not used for programming a seed value. In 32-bit CRC mode (CTRL[TCRC] is 1), values written to this field are part of the seed value when CTRL[WAS] is 1. When CTRL[WAS] is 0, data written to this field is used for CRC checksum generation in both 16-bit and 32-bit CRC modes.
23-16 HL	CRC High Lower Byte In 16-bit CRC mode (CTRL[TCRC] is 0), this field is not used for programming a seed value. In 32-bit CRC mode (CTRL[TCRC] is 1), values written to this field are part of the seed value when CTRL[WAS] is 1. When CTRL[WAS] is 0, data written to this field is used for CRC checksum generation in both 16-bit and 32-bit CRC modes.
15-8 LU	CRC Low Upper Byte When CTRL[WAS] is 1, values written to this field are part of the seed value. When CTRL[WAS] is 0, data written to this field is used for CRC checksum generation.
7-0 LL	CRC Low Lower Byte When CTRL[WAS] is 1, values written to this field are part of the seed value. When CTRL[WAS] is 0, data written to this field is used for CRC checksum generation.

24.3.1.3 CRC Polynomial register (GPOLY)

24.3.1.3.1 Offset

Register	Offset
GPOLY	4h

24.3.1.3.2 Function

This register contains the value of the polynomial for the CRC calculation. The HIGH field contains the upper 16 bits of the CRC polynomial, which are used only in 32-bit CRC mode. Writes to the HIGH field are ignored in 16-bit CRC mode. The LOW field contains the lower 16 bits of the CRC polynomial, which are used in both 16- and 32-bit CRC modes.

24.3.1.3.3 Diagram

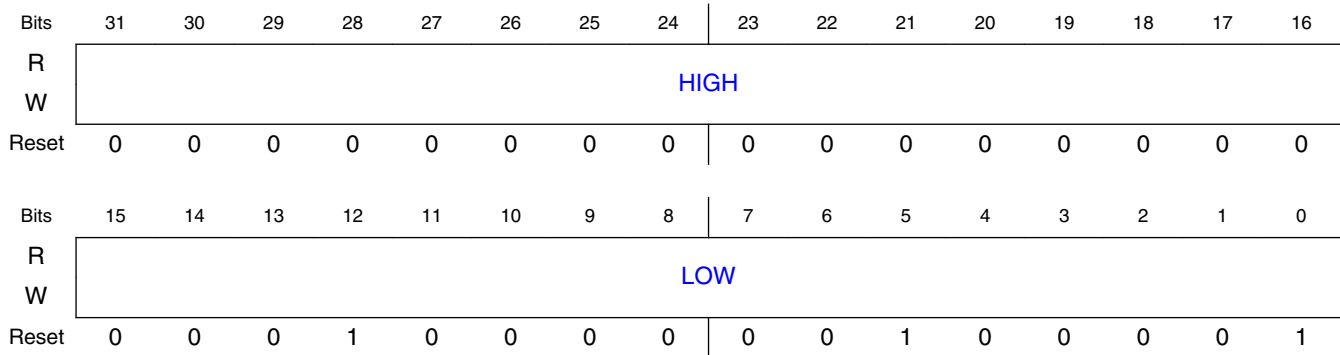

24.3.1.3.4 Fields

Field	Function
31-16 HIGH	High Polynomial Half-word Writable and readable in 32-bit CRC mode (CTRL[TCRC] is 1). This field is not writable in 16-bit CRC mode (CTRL[TCRC] is 0).
15-0 LOW	Low Polynomial Half-word Writable and readable in both 32-bit and 16-bit CRC modes.

24.3.1.4 CRC Control register (CTRL)

24.3.1.4.1 Offset

Register	Offset
CTRL	8h

24.3.1.4.2 Function

This register controls the configuration and working of the CRC module. Appropriate bits must be set before starting a new CRC calculation. A new CRC calculation is initialized by asserting CTRL[WAS] and then writing the seed into the CRC data register.

24.3.1.4.3 Diagram

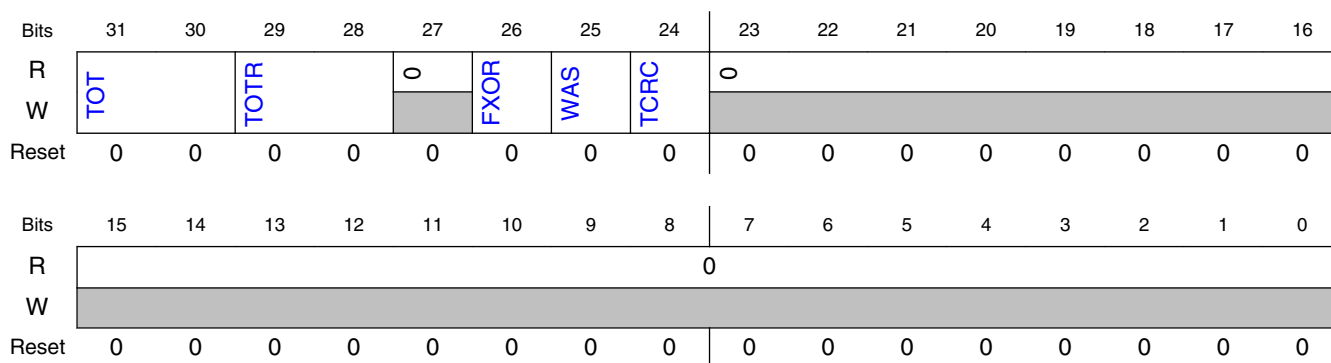

24.3.1.4.4 Fields

Field	Function
31-30 TOT	Type Of Transpose For Writes Defines the transpose configuration of the data written to the CRC data register. See the description of the transpose feature for the available transpose options. 00b - No transposition. 01b - Bits in bytes are transposed; bytes are not transposed. 10b - Both bits in bytes and bytes are transposed. 11b - Only bytes are transposed; no bits in a byte are transposed.
29-28 TOTR	Type Of Transpose For Read Identifies the transpose configuration of the value read from the CRC Data register. See the description of the transpose feature for the available transpose options. 00b - No transposition. 01b - Bits in bytes are transposed; bytes are not transposed. 10b - Both bits in bytes and bytes are transposed. 11b - Only bytes are transposed; no bits in a byte are transposed.
27 —	Reserved
26	Complement Read Of CRC Data Register

Table continues on the next page...

Field	Function
FXOR	Some CRC protocols require the final checksum to be XORed with 0xFFFFFFFF or 0xFFFF. Asserting this bit enables on the fly complementing of read data. 0b - No XOR on reading. 1b - Invert or complement the read value of the CRC Data register.
25 WAS	Write CRC Data Register As Seed When asserted, a value written to the CRC data register is considered a seed value. When deasserted, a value written to the CRC data register is taken as data for CRC computation. 0b - Writes to the CRC data register are data values. 1b - Writes to the CRC data register are seed values.
24 TCRC	TCRC Width of CRC protocol. 0b - 16-bit CRC protocol. 1b - 32-bit CRC protocol.
23-0 —	Reserved

24.4 Functional description

24.4.1 CRC initialization/reinitialization

To enable the CRC calculation, the user must program `CRC_CTRL[WAS]`, `CRC_GPOLY`, necessary parameters for transposition and CRC result inversion in the applicable registers. Asserting `CRC_CTRL[WAS]` enables the programming of the seed value into the `CRC_DATA` register.

After a completed CRC calculation, the module can be reinitialized for a new CRC computation by reasserting `CRC_CTRL[WAS]` and programming a new, or previously used, seed value. All other parameters must be set before programming the seed value and subsequent data values.

24.4.2 CRC calculations

In 16-bit and 32-bit CRC modes, data values can be programmed 8 bits, 16 bits, or 32 bits at a time, provided all bytes are contiguous. Noncontiguous bytes can lead to an incorrect CRC computation.

24.4.2.1 16-bit CRC

To compute a 16-bit CRC:

1. Clear CRC_CTRL[TCRC] to enable 16-bit CRC mode.
2. Program the transpose and complement options in the CTRL register as required for the CRC calculation. See [Transpose feature](#) and [CRC result complement](#) for details.
3. Write a 16-bit polynomial to the CRC_GPOLY[LOW] field. The CRC_GPOLY[HIGH] field is not usable in 16-bit CRC mode.
4. Set CRC_CTRL[WAS] to program the seed value.
5. Write a 16-bit seed to CRC_DATA[LU:LL]. CRC_DATA[HU:HL] are not used.
6. Clear CRC_CTRL[WAS] to start writing data values.
7. Write data values into CRC_DATA[HU:HL:LU:LL]. A CRC is computed on every data value write, and the intermediate CRC result is stored back into CRC_DATA[LU:LL].
8. When all values have been written, read the final CRC result from CRC_DATA[LU:LL].

Transpose and complement operations are performed on the fly while reading or writing values. See [Transpose feature](#) and [CRC result complement](#) for details.

24.4.2.2 32-bit CRC

To compute a 32-bit CRC:

1. Set CRC_CTRL[TCRC] to enable 32-bit CRC mode.
2. Program the transpose and complement options in the CTRL register as required for the CRC calculation. See [Transpose feature](#) and [CRC result complement](#) for details.
3. Write a 32-bit polynomial to CRC_GPOLY[HIGH:LOW].
4. Set CRC_CTRL[WAS] to program the seed value.
5. Write a 32-bit seed to CRC_DATA[HU:HL:LU:LL].
6. Clear CRC_CTRL[WAS] to start writing data values.
7. Write data values into CRC_DATA[HU:HL:LU:LL]. A CRC is computed on every data value write, and the intermediate CRC result is stored back into CRC_DATA[HU:HL:LU:LL].
8. When all values have been written, read the final CRC result from CRC_DATA[HU:HL:LU:LL]. The CRC is calculated bitwise, and two clocks are required to complete one CRC calculation.

Transpose and complement operations are performed on the fly while reading or writing values. See [Transpose feature](#) and [CRC result complement](#) for details.

24.4.3 Transpose feature

By default, the transpose feature is not enabled. However, some CRC standards require the input data and/or the final checksum to be transposed. The user software has the option to configure each transpose operation separately, as desired by the CRC standard. The data is transposed on the fly while being read or written.

Some protocols use little endian format for the data stream to calculate a CRC. In this case, the transpose feature usefully flips the bits. This transpose option is one of the types supported by the CRC module.

24.4.3.1 Types of transpose

The CRC module provides several types of transpose functions to flip the bits and/or bytes, for both writing input data and reading the CRC result, separately using the CTRL[TOT] or CTRL[TOTR] fields, according to the CRC calculation being used.

The following types of transpose functions are available for writing to and reading from the CRC data register:

1. CTRL[TOT] or CTRL[TOTR] is 00.

No transposition occurs.

2. CTRL[TOT] or CTRL[TOTR] is 01

Bits in a byte are transposed, while bytes are not transposed.

reg[31:0] becomes {reg[24:31], reg[16:23], reg[8:15], reg[0:7]}

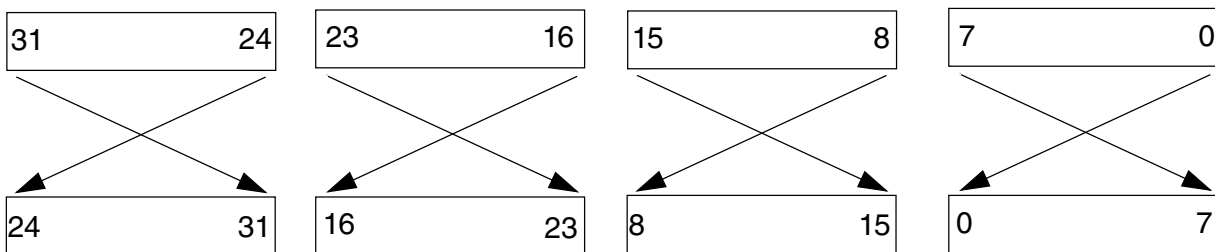

Figure 24-2. Transpose type 01

3. CTRL[TOT] or CTRL[TOTR] is 10.

Both bits in bytes and bytes are transposed.

reg[31:0] becomes = {reg[0:7], reg[8:15], reg[16:23], reg[24:31]}

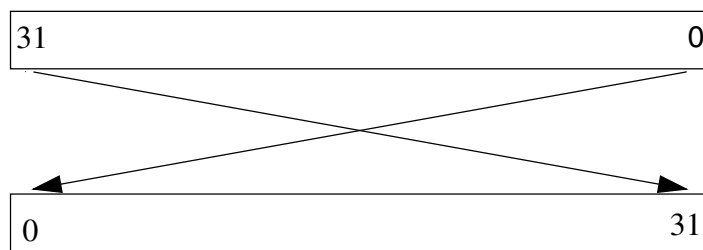

Figure 24-3. Transpose type 10

4. CTRL[TOT] or CTRL[TOTR] is 11.

Bytes are transposed, but bits are not transposed.

reg[31:0] becomes {reg[7:0], reg[15:8], reg[23:16], reg[31:24]}

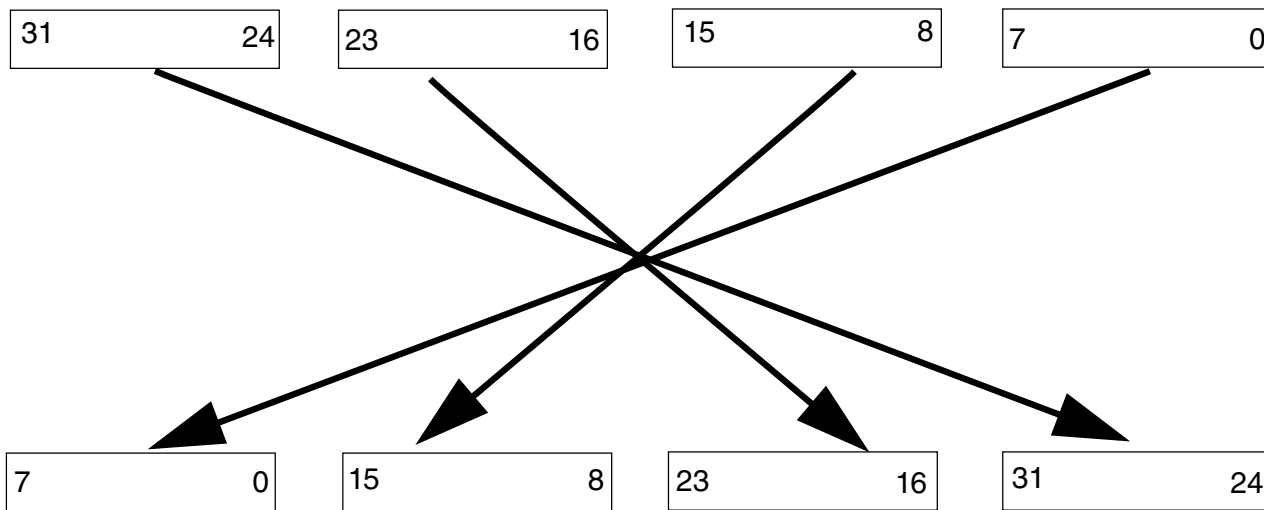

Figure 24-4. Transpose type 11

NOTE

For 8-bit and 16-bit write accesses to the CRC data register, the data is transposed with zeros on the unused byte or bytes (taking 32 bits as a whole), but the CRC is calculated on the valid byte(s) only. When reading the CRC data register for a 16-bit CRC result and using transpose options 10 and 11, the resulting value after transposition resides in the CRC[HU:HL] fields. The user software must account for this situation when reading the 16-bit CRC result, so reading 32 bits is preferred.

24.4.4 CRC result complement

When CTRL[FXOR] is set, the checksum is complemented. The CRC result complement function outputs the complement of the checksum value stored in the CRC data register every time the CRC data register is read. When CTRL[FXOR] is cleared, reading the CRC data register accesses the raw checksum value.

24.5 Use cases

NOTE

The following tables apply to little-endian format.

24.5.1 CRC Control Register programming

The following table shows the CRC Control Register programming for 16-bit CRC.

Table 24-1. Control Register (CTRL) programming for 16-bit CRC

Algorithm	Poly	Seed	Ref In	Ref Out	XOR Out	CTRL[TOT]	CTRL[TOTR]	CTRL[FXOR]
CRC-16/ CCITT_FALSE	0x1021	0xFFFF	0	0	0x0000	0x0	0x0	0x0
CRC-16 / ARC	0x8005	0x0000	1	1	0x0000	0x1	0x2	0x0
CRC16_AUG_CCI TT	0x1021	0x1D0F	0	0	0x0000	0x0	0x0	0x0
CRC16_BUYPAS S	0x8005	0x0000	0	0	0x0000	0x0	0x0	0x0
CRC16_CCITT_Z ERO	0x1021	0x0000	0	0	0x0000	0x0	0x0	0x0
CRC16_CDMA200 0	0xC867	0xFFFF	0	0	0x0000	0x0	0x0	0x0
CRC16_DDS_110	0x8005	0x800D	0	0	0x0000	0x0	0x0	0x0
CRC16_DECT_R	0x589	0x0000	0	0	0xFFFF	0x1	0x2	0x1
CRC16_DECT_X	0x589	0x0000	0	0	0x0000	0x0	0x0	0x0
CRC16_DNP	0x3D65	0x0000	1	1	0xFFFF	0x1	0x2	0x1
CRC16_EN_1375 7	0x3D65	0x0000	0	0	0xFFFF	0x1	0x2	0x1
CRC16_GENIBUS	0x1021	0xFFFF	0	0	0xFFFF	0x1	0x2	0x1
CRC16_MAXIM	0x8005	0x0000	1	1	0xFFFF	0x1	0x2	0x1
CRC16_MCRF4X X	0x1021	0xFFFF	1	1	0x0000	0x1	0x2	0x0
CRC16_RIELLO	0x1021	0xB2AA	1	1	0x0000	0x1	0x2	0x0
CRC16_T10_DIF	0x8BB7	0x0000	0	0	0x0000	0x0	0x0	0x0

Table continues on the next page...

Table 24-1. Control Register (CTRL) programming for 16-bit CRC (continued)

Algorithm	Poly	Seed	Ref In	Ref Out	XOR Out	CTRL[TOT]	CTRL[TOTR]	CTRL[FXOR]
CRC16_TELEDISK	0xA097	0x0000	0	0	0x0000	0x0	0x0	0x0
CRC16_TMS37157	0x1021	0x89EC	1	1	0x0000	0x1	0x2	0x0
CRC16_USB	0x8005	0xFFFF	1	1	0xFFFF	0x1	0x2	0x1
CRC16_A	0x1021	0xC6C6	1	1	0x0000	0x1	0x2	0x0
CRC16_KERMIT	0x1021	0x0000	1	1	0x0000	0x1	0x2	0x0
CRC16_MODBUS	0x8005	0xFFFF	1	1	0x0000	0x1	0x2	0x0
CRC16_X_25	0x1021	0xFFFF	1	1	0xFFFF	0x1	0x2	0x1
CRC16_XMODEM	0x1021	0x0000	0	0	0x0000	0x0	0x0	0x0

The following table shows the CRC Control Register programming for 32-bit CRC.

Table 24-2. Control Register (CTRL) programming for 32-bit CRC

Algorithm	Poly	Seed	Ref In	Ref Out	Xor Out	CTRL[TOT]	CTRL[TOTR]	CTRL[FXOR]
CRC - 32	0x04C11DB7	0xFFFFFFFF	1	1	0xFFFF_FFFF	0x1	0x2	0x1
CRC-32/BZIP2	0x04C11DB7	0xFFFFFFFF	0	0	0xFFFF_FFFF	0x0	0x0	0x1
CRC-32C	0x1EDC6F41	0xFFFFFFFF	1	1	0xFFFF_FFFF	0x1	0x2	0x1
CRC-32D	0xA833982B	0xFFFFFFFF	1	1	0xFFFF_FFFF	0x1	0x2	0x1
CRC-32/MPEG-2	0x04C11DB7	0xFFFFFFFF	0	0	0x0000_0000	0x0	0x0	0x0
CRC-32/POSIX	0x04C11DB7	0x00000000	0	0	0xFFFF_FFFF	0x0	0x0	0x1
CRC-32Q	0x814141AB	0x00000000	0	0	0x0000_0000	0x0	0x0	0x0
CRC-32/JAMCRC	0x04C11DB7	0xFFFFFFFF	1	1	0x0000_0000	0x1	0x2	0x0
CRC-32/XFER	0x000000AF	0x00000000	0	0	0x0000_0000	0x0	0x0	0x0

24.5.2 Expected read data fields

The following table shows the expected read data fields for 16-bit CRC.

Table 24-3. Expected read data fields for 16-bit CRC

Algorithm	CRC DATA Register (DATA)
CRC-16/CCITT_FALSE	[31 : 16] = Unknown [15 : 0] = Valid Data
CRC-16 / ARC	[31 : 16] = Valid Data [15 : 0] = Unknown
CRC16_AUG_CCITT	[31 : 16] = Unknown [15 : 0] = Valid Data
CRC16_BUYPASS	[31 : 16] = Unknown [15 : 0] = Valid Data
CRC16_CCITT_ZERO	[31 : 16] = Unknown [15 : 0] = Valid Data
CRC16_CDMA2000	[31 : 16] = Unknown [15 : 0] = Valid Data
CRC16_DDS_110	[31 : 16] = Unknown [15 : 0] = Valid Data
CRC16_DECT_R	[31 : 16] = Valid Data [15 : 0] = Unknown
CRC16_DECT_X	[31 : 16] = Unknown [15 : 0] = Valid Data
CRC16_DNP	[31 : 16] = Valid Data [15 : 0] = Unknown
CRC16_EN_13757	[31 : 16] = Valid Data [15 : 0] = Unknown
CRC16_GENIBUS	[31 : 16] = Valid Data [15 : 0] = Unknown
CRC16_MAXIM	[31 : 16] = Valid Data [15 : 0] = Unknown
CRC16_MCRF4XX	[31 : 16] = Valid Data [15 : 0] = Unknown
CRC16_RIELLO	[31 : 16] = Valid Data [15 : 0] = Unknown
CRC16_T10_DIF	[31 : 16] = Unknown [15 : 0] = Valid Data
CRC16_TELEDISK	[31 : 16] = Unknown [15 : 0] = Valid Data
CRC16_TMS37157	[31 : 16] = Valid Data [15 : 0] = Unknown
CRC16_USB	[31 : 16] = Valid Data [15 : 0] = Unknown
CRC16_A	[31 : 16] = Valid Data [15 : 0] = Unknown
CRC16_KERMIT	[31 : 16] = Valid Data [15 : 0] = Unknown
CRC16_MODBUS	[31 : 16] = Valid Data [15 : 0] = Unknown
CRC16_X_25	[31 : 16] = Valid Data [15 : 0] = Unknown
CRC16_XMODEM	[31 : 16] = Unknown [15 : 0] = Valid Data

The following table shows the expected read data fields for 32-bit CRC.

Table 24-4. Expected read data fields for 32-bit CRC

Algorithm	CRC DATA Register (DATA)
CRC - 32	[31 : 0] = Valid Data
CRC-32/BZIP2	[31 : 0] = Valid Data
CRC-32C	[31 : 0] = Valid Data
CRC-32D	[31 : 0] = Valid Data
CRC-32/MPEG-2	[31 : 0] = Valid Data
CRC-32/POSIX	[31 : 0] = Valid Data
CRC-32Q	[31 : 0] = Valid Data
CRC-32/JAMCRC	[31 : 0] = Valid Data
CRC-32/XFER	[31 : 0] = Valid Data

Chapter 25

Reset and Boot

25.1 Introduction

This table shows the reset sources that are supported.

Table 25-1. Reset sources

Reset sources	Description
POR reset	<ul style="list-style-type: none">• Power-on reset (POR)
System resets	<ul style="list-style-type: none">• External pin reset (PIN)• Low voltage detect (LVD)• Watchdog reset• Loss-of-clock (LOC) reset• Loss-of-lock (LOL) reset• Stop mode acknowledge error (SACKERR)• Software reset (SW)• Lockup reset (LOCKUP)• MDM DAP system reset
Debug reset	<ul style="list-style-type: none">• JTAG reset

25.2 Reset

This section discusses basic reset mechanisms and sources. Some peripheral modules that cause resets can be configured to cause interrupts instead. See the individual module chapters for more information.

Each reset source has an associated field in the Reset Control Module (RCM) [System Reset Status \(RCM_SRS\)](#) register. Besides immediate system reset, the RCM also supports optional configurable delayed system reset while an interrupt is generated. This provides software an option to perform a graceful shutdown.

The MCU exits reset in RUN mode where the CPU is executing code. See [Boot](#) for more details.

25.2.1 Power-on reset (POR)

When power is initially applied to the MCU or when the supply voltage drops below the POR detect voltage (V_{POR}), the POR circuit causes a POR reset condition.

As the supply voltage rises, the LVD circuit holds the MCU in reset until the supply has risen above the LVD low voltage detect threshold (V_{LVD}). Following a POR, the MCU writes 1 to the POR and LVD fields in **RCM_SRS** register.

Out of POR, both RCM_SRS[POR] and RCM_SRS[LVD] are configured as 1 by MCU.

While normal operation, if device supply goes below VPOR, MCU writes 1 to both RCM_SRS[POR] and RCM_SRS[LVD]. While normal operation, if device supply goes below VLVD (provided LVD is enabled to generate a reset) or VLVR but above VPOR, MCU writes 1 to RCM_SRS[LVD].

25.2.2 System reset sources

Resetting the MCU provides a way to start processing from a known set of initial conditions. System reset begins with the on-chip regulator in full regulation and system clocking generation from an internal reference. When the processor exits reset, it:

- Reads the start stack pointer (SP) (SP_main) from vector-table offset 0
- Reads the start program counter (PC) from vector-table offset 4
- Writes 0xFFFF_FFFF to the Link Register (LR)

The on-chip peripheral modules are disabled and the non-analog I/O pins are initially configured as disabled. The pins with analog functions assigned to them are configured for their analog functions after reset.

During and following a reset, the JTAG pins have their associated input pins configured as:

- TDI as pullup (PU)
- TCK as pulldown (PD)
- TMS as pullup

and associated output pin configured as:

- TDO with no pull-down or pull-up

25.2.2.1 External pin reset

RESET_B is a shared pin (See IO Signal Description Input Multiplexing sheet(s) attached to the Reference Manual). The user must configure the corresponding [PORT_PCR](#) register prior to using this pin as RESET_B. On any reset event, the MCU configures the corresponding pad as RESET_B pad. Asserting RESET_B wakes the MCU from any mode. The system clock is required to be available for proper functionality of Reset Pin. During a pin reset, the MCU writes 1 to [RCM_SRS\[PIN\]](#).

25.2.2.1.1 RESET_B pin filter

The RESET_B pin filter supports filtering from both the 128 kHz LPO clock and the bus clock. [RCM_RPC\[RSTFLTSS\]](#), [RCM_RPC\[RSTFLTSRW\]](#), and [RCM_RPC\[RSTFLTSEL\]](#) control this functionality. The filters are asynchronously reset on chip POR. The reset value for each filter assumes the RESET_B pin is negated.

For all stop modes where LPO clock is still active, the only filtering option is the LPO clock filter. The filtering logic either switches to bypass operation or has continued filtering operation depending on the filtering mode selected as described in [RCM_RPC](#) register.

The LPO filter has a fixed filter value. The pulses upto 2 LPO128K_CLK cycles will always be filtered. The pulses longer than 3 LPO128K_CLK cycles will always get passed and generate a RESET. The pulses in between 2 to 3 LPO128K_CLK cycles may or may not generate reset based on reset alignment with clock edge.

25.2.2.2 Low voltage detect (LVD)

The chip includes a system for managing low voltage conditions to protect memory contents and control MCU system states during supply voltage variations. The system consists of a POR circuit and an LVD circuit. The LVD system is always enabled in HSRUN and Normal Run. The LVD system is disabled when entering VLPx modes.

The LVD system can be configured to generate a reset upon detection of a low voltage condition by writing 1 to [PMC_LVDSC1\[LVDRE\]](#). After an LVD reset has occurred, the LVD system holds the MCU in reset until the supply voltage has risen above the low voltage detection threshold. The MCU writes 1 to [RCM_SRS\[LVD\]](#) bit is set following either an LVD reset or POR.

Besides LVD operation, the device also supports LVR(Low Voltage Reset) operation. If the supply voltage falls below the reset trip point (VLVR), a system reset will be generated. LVR system is enabled in all modes. LVDRE has effect on LVD operation only.

Out of POR, both RCM_SRS[POR] and RCM_SRS[LVD] are configured as 1 by MCU. While normal operation, if device supply goes below VPOR, MCU writes 1 to both RCM_SRS[POR] and RCM_SRS[LVD]. While normal operation, if device supply goes below VLVD (provided LVD is enabled to generate a reset) or VLVR but above VPOR, MCU writes 1 to RCM_SRS[LVD].

25.2.2.3 Watchdog reset

Watchdog timer (WDOG) monitors the operation of the system by expecting periodic communication from the software. This communication is generally known as servicing or refreshing the watchdog. If this periodic refreshing does not occur, the watchdog issues a system reset. The watchdog reset causes the MCU to write 1 to [RCM_SRS\[WDOG\]](#).

25.2.2.4 Loss-of-clock (LOC) reset

LOC reset is enabled when SOSC clock monitor is enabled (by writing 1 to [SOSCCM](#)) and configured to generate a reset on error (by writing 1 to [SOSCCMRE](#)). If the error bit ([SOSCERR](#)) is written to 1 and LOC reset is enabled (as mentioned above), the MCU resets. The MCU writes 1 to the [LOC](#) field to indicate this reset source.

NOTE

To prevent unexpected loss of clock reset events, all clock monitors should be disabled before entering any low power modes, including VLPR.

25.2.2.5 Loss-of-lock (LOL) reset

LOL reset is enabled when PLL clock monitor is enabled (by writing 1 to [SCG_SPLLCSR\[SPLLCM\]](#)) and configured to generate a reset on error (by writing 1 to [SCG_SPLLCSR\[SPLLCMRE\]](#)). If the error bit ([SCG_SPLLCSR\[SPLLEERR\]](#)) is written to 1 and LOL reset is enabled (as mentioned above), the MCU resets. The MCU writes 1 to [RCM_SRS\[LOL\]](#) field is set to indicate this reset source.

NOTE

This reset source does not cause a reset if the chip is in any Stop mode.

SPLL also flags LOL in case if the reference to SPLL goes faulty. So while using SPLL, any failure in reference clock source, i.e., SOSC might lead to either LOC or LOL event.

25.2.2.6 Stop mode acknowledge error (SACKERR)

The Stop mode acknowledge error (SACKERR) reset is generated if the core attempts to enter Stop mode, but not all modules acknowledge stop mode within $(2^{16} + 1)$ (corresponding to 0.5s) cycles of the LPO128K_CLK.

A module might not acknowledge the entry to Stop mode if an error condition occurs. The error can be caused by a failure of an external clock input to a module.

The [RCM_SRS\[SACKERR\]](#) bit is written to 1 to indicate this reset source.

25.2.2.7 Software reset (SW)

The SYSRESETREQ bit in the NVIC application interrupt and reset control register can be written to 1 to force a software reset. (See [Arm's NVIC](#) documentation for the full description of the register fields, especially the VECTKEY field requirements.) Writing 1 to SYSRESETREQ generates a software reset request. This reset forces a system reset of all major components except for the debug module. A software reset causes the MCU to write 1 to [RCM_SRS\[SW\]](#) field.

25.2.2.8 Lockup reset (LOCKUP)

The LOCKUP gives immediate indication of seriously errant kernel software. This is the result of the core being locked because of an unrecoverable exception following the activation of the processor's built in system state protection hardware.

The LOCKUP condition causes a system reset and also causes the MCU to write 1 to [RCM_SRS\[LOCKUP\]](#) field. See [Arm Cortex-M4 Devices Generic User Guide](#) (for S32K14x devices) and [Arm Cortex-M0 Devices Generic User Guide](#) (for S32K11x devices) for details on 'lockup' event.

25.2.2.9 MDM-AP system reset request

Writing 1 to the system reset request field in the [MDM-AP control register](#) initiates a system reset. This is the primary method for resets via the JTAG/SWD interface. The system reset is held until this field is written to 0.

Writing 1 to the core hold reset bit in the [MDM-AP control register](#) holds the core in reset as the rest of the chip comes out of system reset.

25.2.3 MCU Resets

A variety of resets are generated by the MCU to reset different modules.

25.2.3.1 POR Only

The POR Only reset asserts on the POR reset source only. It resets the PMC registers.

The POR Only reset also causes all other reset types to occur.

25.2.3.2 Chip POR

The Chip POR asserts on POR, LVR or LVD.

The Chip POR also causes the chip reset (including early chip reset) to occur.

25.2.3.3 Early chip reset

The early chip reset asserts on all reset sources. It resets only the flash memory module. It deasserts before flash memory initialization begins (earlier than the chip reset deassertion).

25.2.3.4 Chip reset

Chip reset asserts on all reset sources and only deasserts after flash memory initialization has completed and the RESET_B pin has also negated.

25.2.3.5 Core reset

The core comes out of reset after one cycle of chip reset. The core can be held in reset using the core hold reset bit in the MDM-AP control register as the rest of the chip comes out of system reset.

25.2.4 Reset pin

For all reset sources, the RESET_B pin is driven low by the MCU for at least 128 bus clock cycles and until flash memory initialization has completed.

After flash memory initialization has completed, the RESET_B pin is released and the internal chip reset deasserts. Keeping the RESET_B pin asserted externally delays the negation of the internal chip reset.

25.2.5 Debug resets

The following sections detail the debug resets.

25.2.5.1 JTAG reset

The JTAG module generate a system reset when certain IR codes are selected. This functional reset is asserted when EXTEST, HIGHZ and CLAMP instructions are active. The reset source from the JTAG module is released when any other IR code is selected. A JTAG reset causes the MCU to write 1 to [RCM_SRS\[JTAG\]](#) field.

25.2.5.2 Resetting the debug subsystem

Use the CDBGRSTREQ field within the SWJ-DP CTRL/STAT register to reset the debug modules. However the CDBGRSTREQ field does not reset all debug-related registers.

CDBGRSTREQ resets only the debug-related registers within the following modules:

- SWJ-DP
- AHB-AP
- TPIU
- MDM-AP (MDM control and status registers)

CDBGRSTREQ does not reset the debug-related registers within these modules:

- CM4 core (core debug registers: DHCSR, DCRSR, DCRDR, DEMCR)
- FPB
- DWT
- ITM
- NVIC
- Crossbar bus switch
- Private peripheral bus

25.3 Boot

This section describes the boot sequence, including sources and options.

25.3.1 Boot sources

This MCU supports cold booting from internal flash memory.

When the MCU boots from internal flash memory, the reset vectors are located at address 0x0 (initial SP_main) and 0x4 (initial PC).

The MCU also supports boot from RAM by relocating the exception vector table to RAM. This is implemented through a programmable Vector Table Offset Register (VTOR) in NVIC module.

The MCU supports serial code download via

- CAN
- LIN
- SPI etc.

The application developer can write their own flash memory based boot loaders or adapt the ones available at <http://www.nxp.com>. These boot loaders are then used to configure and use the communication protocol to perform mass serial download. For instance, the CAN module can be used to transfer data into its own message buffers, then the DMA module can be used to move the data into the main system RAM. Once the download is completed, the core can be used to transfer the new downloaded code into the flash memory area.

25.3.2 FOPT boot options

The **FOPT** register in the Flash Memory module allows the user to customize the operation of the MCU at boot time. The register contains read-only bits that are loaded from the NVM's option byte in the flash memory configuration field. The default setting for all values in the FTFC_FOPT register is logic 1 since it is copied from the option byte residing in flash memory, which has all bits as logic 1 in the flash memory erased state. To configure for alternate settings, program the appropriate bits in the NVM option byte. The new settings take effect on subsequent POR and any system reset. For more details on programming the option byte, see [the flash memory chapter](#).

The MCU uses **FOPT** to configure the MCU at reset as shown in this table.

Table 25-2. FTFC_FOPT definition

Bit number	Field	Value	Definition
7-6	Reserved		Reserved for future expansion
5	Reserved		Reserved
4	Reserved		Reserved for future expansion
3	RESET_PIN_CFG		Enables/disables control for the RESET pin.
		0	RESET_B pin is disabled following a POR and cannot be enabled as reset function. When this option is selected, there could be a short period of contention during a POR ramp where the MCU drives the pin low prior to establishing the setting of this option and releasing the reset function on the pin. This bit is preserved through system resets and low-power modes. When RESET_B pin function is disabled, it cannot be used as a source for low-power mode wake-up.
		1	The port is configured with pullup enabled, passive filter enabled.
2	NMI_PIN_CFG		Enables/disables control for the NMI function.
		0	NMI interrupts are always blocked. The associated pin continues to default to NMI_b pin controls with internal pullup enabled. When NMI_b pin function is disabled, it cannot be used as a source for low-power mode wake-up. If the NMI function is not required, either for an interrupt or wake up source, it is recommended that the NMI function be disabled by writing 0 to NMI_PIN_CFG.
		1	NMI_b pin/interrupts reset default to enabled.
1	Reserved		Reserved for future expansion.
0	LPBOOT ¹		Controls the reset value of clock divider of IRC 48 Mhz to feed the Core and platform clocks. Larger divide value selections produce lower average power consumption during POR and reset sequencing and after reset exit.
		0	Core and system clock divider (OUTDIV1) is 0x1 (divide by 2).
		1	Core and system clock divider (OUTDIV1) is 0x0 (divide by 1).

1. Not available in the S32K14xW devices

25.3.3 Boot sequence

At power up, the on-chip regulator holds the system in a POR state until the input supply is above the POR threshold. The system continues to be held in this static state until the internally regulated supplies have reached a safe operating voltage as determined by the LVD. The mode controller reset logic then controls this sequence to exit reset:

1. A system reset is held on internal logic, the RESET_B pin is driven out low, and the SCG is enabled in its default clocking mode.
2. Required clocks are enabled (core clock, system clock, flash clock, and any bus clocks that do not have clock gate control reset to disabled).

3. The system reset on internal logic continues to be held, but the flash controller is released from reset and begins initialization operation while the reset control logic continues to drive the RESET_B pin low.
4. Early in reset sequencing, the NVM option byte is read and stored to the flash memory module's FOPT register. If the LPBOOT is programmed for an alternate clock divider reset value, the system/core clock is switched to a slower clock speed.
5. When flash memory initialization completes, the RESET_B pin is released. If RESET_B continues to be asserted (an indication of a slow rise time on the RESET_B pin or external drive in low), the system continues to be held in reset. Once the RESET_B pin is detected high, the core clock is enabled and the system is released from reset.
6. When the system exits reset, the processor sets up the stack, program counter (PC), and link register (LR). The processor reads the start SP (SP_main) from vector-table offset 0. The core reads the start PC from vector-table offset 4. LR is written to 0xFFFF_FFFF.
7. If FlexNVM is enabled, the flash memory controller continues to restore the FlexNVM data. This data is not available immediately out of reset and the system should not access this data until the flash controller completes this initialization step as indicated by the [EEERDY](#) flag.

Subsequent system resets follow this same reset flow.

Chapter 26

Reset Control Module (RCM)

26.1 Chip-specific RCM information

High voltage detect (HVD) reset is not supported on this device. References to HVD reset or HVD trip must be ignored. The SACKERR timing is 0.5 s.

On this device, LVD (Low voltage detect) and LVR (Low voltage reset) events trigger LVD reset and hence Chip POR. Chip POR is triggered by POR, LVR or LVD events. The PMC_LVDSC1[LVDRE] is used to gate LVD only, and has no effect on LVR generation. With PMC_SC1[LVDRE] disabled, LVRs can still generate reset to system. See [Low Voltage Detect \(LVD\) System](#).

Wait mode is not supported on this device. See [Module operation in available power modes](#) for details on available power modes.

LPO128K_CLK is used as low power clock for reset pin filter.

See [ARM Cortex-M4 Devices Generic User Guide](#) (for S32K14x and S32K14xW devices) and [ARM Cortex-M0 Devices Generic User Guide](#) (for S32K11x devices) for details on 'lockup' event.

26.1.1 RCM register information

Following bit fields details CMU reset source and are available in S32K11x variants only:

- [RCM_PARAM\[ECMU_LOC\]](#),
- [RCM_SRS\[CMU_LOC\]](#),
- [RCM_SRS\[SCMU_LOC\]](#), and
- [RCM_SRIE\[CMU_LOC\]](#).

Following bit fields details reset caused by a loss of lock in the SCG PLL/FLL and are available in S32K14x and S32K14xW variants only:

- [RCM_PARAM\[ELOL\]](#),

- [RCM_SRS\[LOL\]](#), and
- [RCM_SRS\[SLOL\]](#).

NOTE

The read of the RCM registers is affected during EEERAM commands. For more information see note 'During execution of the SetRAM 0xFF' in [Chip-specific FTFC information](#).

26.2 Reset pin filter operation in STOP1/2 modes

The reset pins filtering in STOP1/2 mode is as follows:

- STOP1: Both RUN mode and STOP mode filters can operate. The filter with lower pulse duration dominates.
- STOP2: RUN mode filter operates.

26.3 Introduction

Information found here describes the registers of the Reset Control Module (RCM). The RCM implements many of the reset functions for the chip. See the chip's reset chapter for more information.

See [AN4503: Power Management for Kinetis and ColdFire+ MCUs](#) for further details on using the RCM.

26.4 Reset memory map and register descriptions

The RCM Memory Map/Register Definition can be found here.

The Reset Control Module (RCM) registers provide reset status information and reset filter control.

NOTE

The RCM registers can be written only in supervisor mode. Write accesses in user mode are blocked and will result in a bus error.

RCM memory map

Address offset (hex)	Register name	Width (in bits)	Access	Reset value	Section/page
0	Version ID Register (RCM_VERID)	32	R	0300_0003h	26.4.1/545
4	Parameter Register (RCM_PARAM)	32	R	See section	26.4.2/546
8	System Reset Status Register (RCM_SRS)	32	R	0000_0082h	26.4.3/548
C	Reset Pin Control register (RCM_RPC)	32	R/W	0000_0000h	26.4.4/551
18	Sticky System Reset Status Register (RCM_SSRS)	32	R/W	0000_0082h	26.4.5/553
1C	System Reset Interrupt Enable Register (RCM_SRIE)	32	R/W	0000_0000h	26.4.6/555

26.4.1 Version ID Register (RCM_VERID)

Address: 0h base + 0h offset = 0h

Bit	31	30	29	28	27	26	25	24	23	22	21	20	19	18	17	16	15	14	13	12	11	10	9	8	7	6	5	4	3	2	1	0	
R	MAJOR								MINOR								FEATURE																
W	[Shaded]																																
Reset	0	0	0	0	0	0	0	1	1	0	0	0	0	0	0	0	0	0	0	0	0	0	0	0	0	0	0	0	0	0	0	1	1

RCM_VERID field descriptions

Field	Description
31–24 MAJOR	Major Version Number This read only field returns the major version number for the specification.
23–16 MINOR	Minor Version Number This read only field returns the minor version number for the specification.
FEATURE	Feature Specification Number This read only field returns the feature set number. 0x0003 Standard feature set.

26.4.2 Parameter Register (RCM_PARAM)

Address: 0h base + 4h offset = 4h

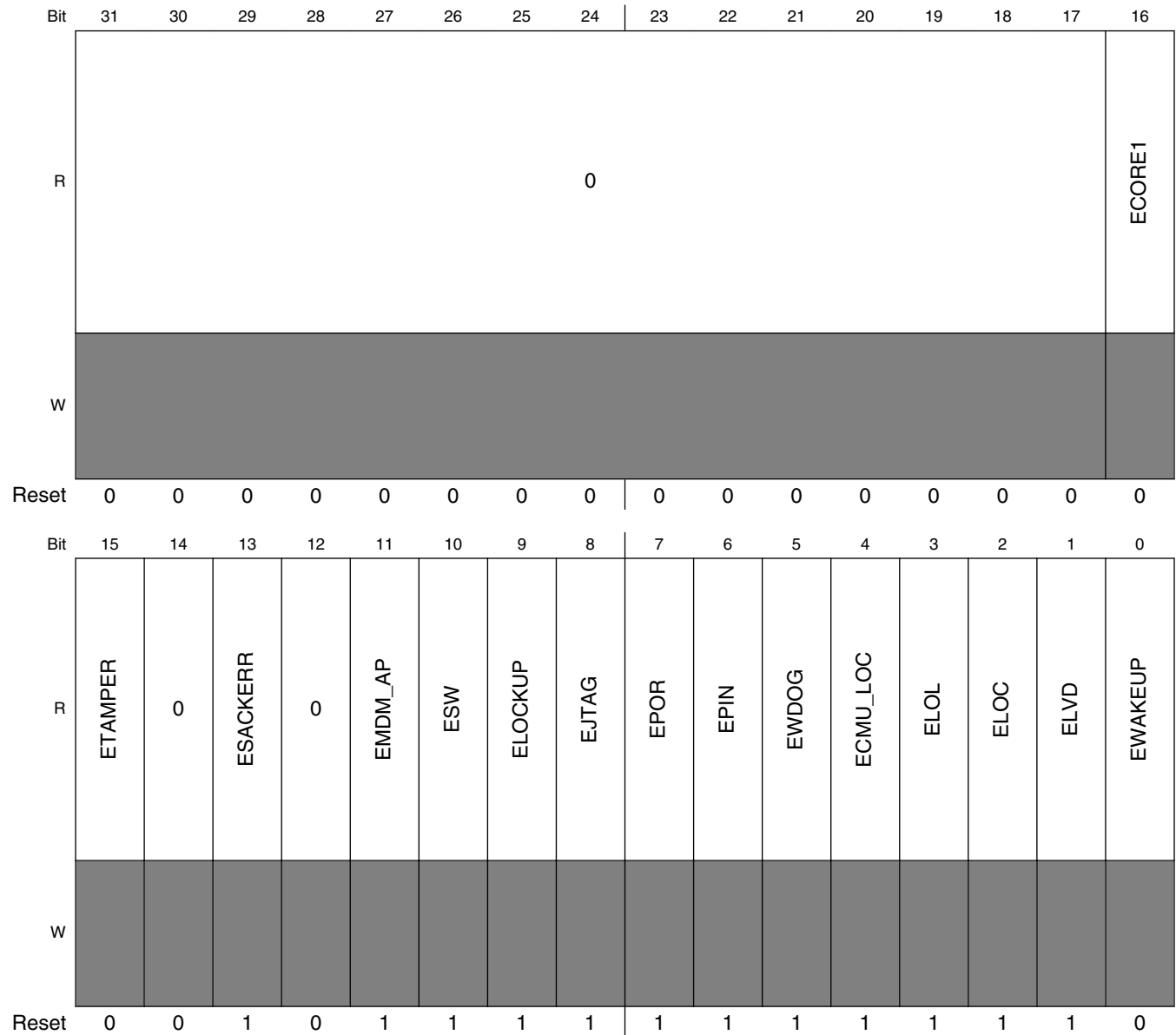

RCM_PARAM field descriptions

Field	Description
31–17 Reserved	This field is reserved. This read-only field is reserved and always has the value 0.
16 ECORE1	Existence of SRS[CORE1] status indication feature

Table continues on the next page...

RCM_PARAM field descriptions (continued)

Field	Description
	This static bit states whether or not the feature is available on the device. 0 The feature is not available. 1 The feature is available.
15 ETAMPER	Existence of SRS[TAMPER] status indication feature This static bit states whether or not the feature is available on the device. 0 The feature is not available. 1 The feature is available.
14 Reserved	This field is reserved. This read-only field is reserved and always has the value 0.
13 ESACKERR	Existence of SRS[SACKERR] status indication feature This static bit states whether or not the feature is available on the device. 0 The feature is not available. 1 The feature is available.
12 Reserved	This field is reserved. This read-only field is reserved and always has the value 0.
11 EMDM_AP	Existence of SRS[MDM_AP] status indication feature This static bit states whether or not the feature is available on the device. 0 The feature is not available. 1 The feature is available.
10 ESW	Existence of SRS[SW] status indication feature This static bit states whether or not the feature is available on the device. 0 The feature is not available. 1 The feature is available.
9 ELOCKUP	Existence of SRS[LOCKUP] status indication feature This static bit states whether or not the feature is available on the device. 0 The feature is not available. 1 The feature is available.
8 EJTAG	Existence of SRS[JTAG] status indication feature This static bit states whether or not the feature is available on the device. 0 The feature is not available. 1 The feature is available.
7 EPOR	Existence of SRS[POR] status indication feature This static bit states whether or not the feature is available on the device. 0 The feature is not available. 1 The feature is available.

Table continues on the next page...

RCM_PARAM field descriptions (continued)

Field	Description
6 EPIN	Existence of SRS[PIN] status indication feature This static bit states whether or not the feature is available on the device. 0 The feature is not available. 1 The feature is available.
5 EWDOG	Existence of SRS[WDOG] status indication feature This static bit states whether or not the feature is available on the device. 0 The feature is not available. 1 The feature is available.
4 ECMU_LOC	Existence of SRS[CMU_LOC] status indication feature This static bit states whether or not the feature is available on the device. 0 The feature is not available. 1 The feature is available.
3 ELOL	Existence of SRS[LOL] status indication feature This static bit states whether or not the feature is available on the device. 0 The feature is not available. 1 The feature is available.
2 ELOC	Existence of SRS[LOC] status indication feature This static bit states whether or not the feature is available on the device. 0 The feature is not available. 1 The feature is available.
1 ELVD	Existence of SRS[LVD] status indication feature This static bit states whether or not the feature is available on the device. 0 The feature is not available. 1 The feature is available.
0 EWAKEUP	Existence of SRS[WAKEUP] status indication feature This static bit states whether or not the feature is available on the device. 0 The feature is not available. 1 The feature is available.

26.4.3 System Reset Status Register (RCM_SRS)

This register includes read-only status flags to indicate the source of the most recent reset. Note that multiple flags can be set if multiple reset events occur at the same time. The reset state of these bits depends on what caused the MCU to reset.

NOTE

The reset value of this register depends on the reset source:

- POR (including LVD) — 0x82
- LVD (without POR) — 0x02
- Other reset — a bit is set if its corresponding reset source caused the reset

Address: 0h base + 8h offset = 8h

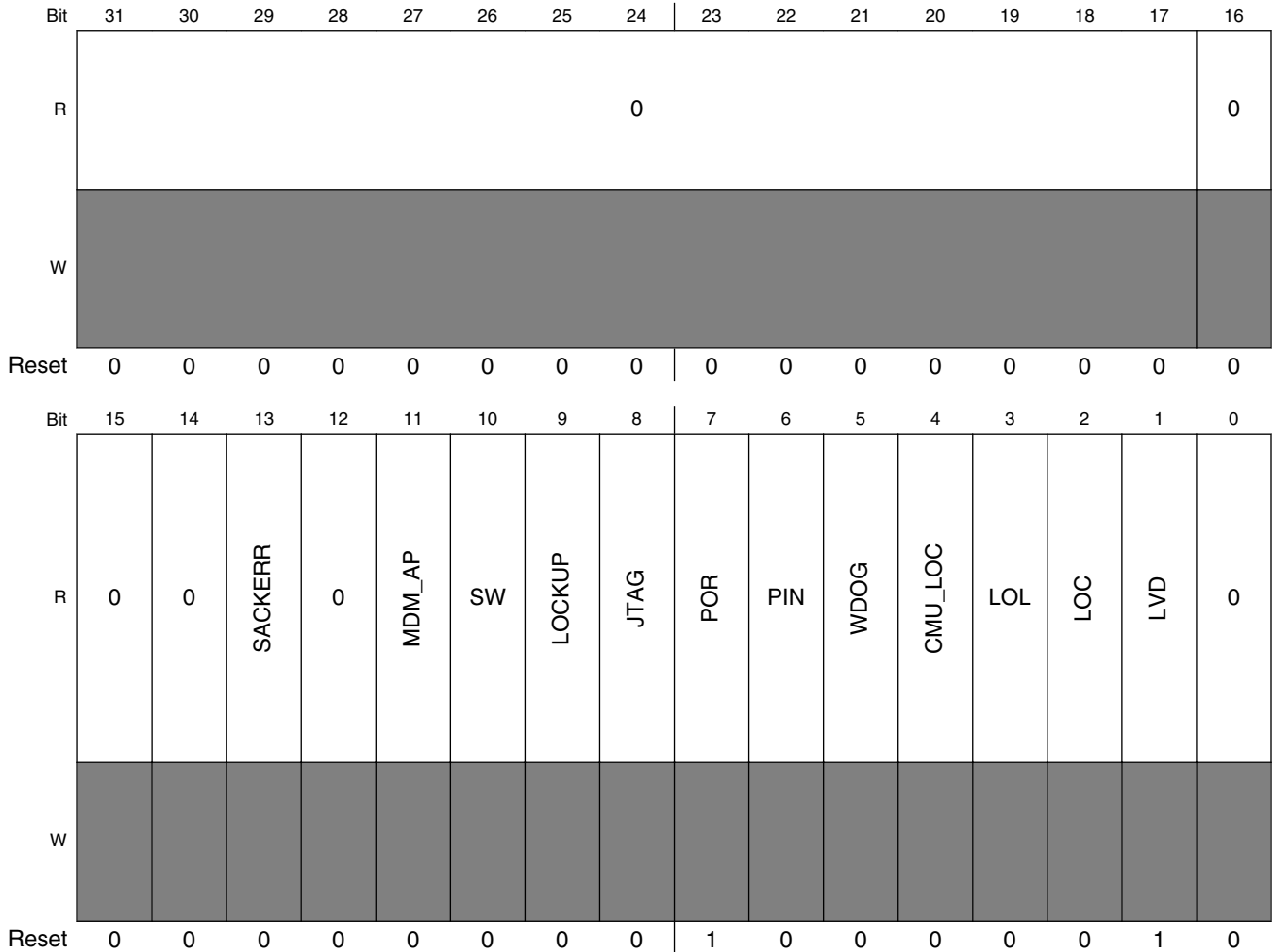

RCM_SRS field descriptions

Field	Description
31–17 Reserved	This field is reserved. This read-only field is reserved and always has the value 0.
16 Reserved	This field is reserved. This read-only field is reserved and always has the value 0.
15 Reserved	This field is reserved. This read-only field is reserved and always has the value 0.

Table continues on the next page...

RCM_SRS field descriptions (continued)

Field	Description
14 Reserved	This field is reserved. This read-only field is reserved and always has the value 0.
13 SACKERR	Stop Acknowledge Error Indicates that after an attempt to enter Stop mode, a reset has been caused by a failure of one or more peripherals to acknowledge within approximately one second to enter stop mode. 0 Reset not caused by peripheral failure to acknowledge attempt to enter stop mode 1 Reset caused by peripheral failure to acknowledge attempt to enter stop mode
12 Reserved	This field is reserved. This read-only field is reserved and always has the value 0.
11 MDM_AP	MDM-AP System Reset Request Indicates a reset has been caused by the host debugger system setting of the System Reset Request bit in the MDM-AP Control Register. 0 Reset was not caused by host debugger system setting of the System Reset Request bit 1 Reset was caused by host debugger system setting of the System Reset Request bit
10 SW	Software Indicates a reset has been caused by software setting of SYSRESETREQ bit in Application Interrupt and Reset Control Register in the Arm core. 0 Reset not caused by software setting of SYSRESETREQ bit 1 Reset caused by software setting of SYSRESETREQ bit
9 LOCKUP	Core Lockup Indicates a reset has been caused by the Arm core indication of a LOCKUP event. 0 Reset not caused by core LOCKUP event 1 Reset caused by core LOCKUP event
8 JTAG	JTAG generated reset Indicates a reset has been caused by the JTAG selection of certain IR codes: EXTEST, HIGHZ, and CLAMP. 0 Reset not caused by JTAG 1 Reset caused by JTAG
7 POR	Power-On Reset Indicates a reset has been caused by the power-on detection logic. Because the internal supply voltage was ramping up at the time, the low-voltage reset (LVD) status bit is also set to indicate that the reset occurred while the internal supply was below the LVD threshold. 0 Reset not caused by POR 1 Reset caused by POR
6 PIN	External Reset Pin Indicates a reset has been caused by an active-low level on the external $\overline{\text{RESET}}$ (RESET_b) pin. 0 Reset not caused by external reset pin 1 Reset caused by external reset pin

Table continues on the next page...

RCM_SRS field descriptions (continued)

Field	Description
5 WDOG	<p>Watchdog</p> <p>Indicates a reset has been caused by the watchdog timer timing out. This reset source can be blocked by disabling the watchdog.</p> <p>0 Reset not caused by watchdog timeout 1 Reset caused by watchdog timeout</p>
4 CMU_LOC	<p>CMU Loss-of-Clock Reset</p> <p>Indicates a reset has been caused by the CMU loss-of-clock circuit. CMU_FC_GCR[FCE] must be set to enable the frequency check circuit. See the CMU chapter for details.</p> <p>0 Reset not caused by the CMU loss-of-clock circuit. 1 Reset caused by the CMU loss-of-clock circuit.</p>
3 LOL	<p>Loss-of-Lock Reset</p> <p>Indicates a reset has been caused by a loss of lock in the SCG PLL/FLL.</p> <p>0 Reset not caused by a loss of lock in the PLL/FLL 1 Reset caused by a loss of lock in the PLL/FLL</p>
2 LOC	<p>Loss-of-Clock Reset</p> <p>Indicates a reset has been caused by a loss of external clock. The SCG SOSC clock monitor must be enabled for a loss of clock to be detected. Refer to the detailed SCG description for information on enabling the clock monitor.</p> <p>0 Reset not caused by a loss of external clock. 1 Reset caused by a loss of external clock.</p>
1 LVD	<p>Low-Voltage Detect Reset or High-Voltage Detect Reset</p> <p>If PMC_LVDSC1[LVDRE] is set and the supply drops below the LVD trip voltage, an LVD reset occurs. If PMC_HVDSC1[HVDRE] is set and the supply rises above the HVD trip voltage, an HVD reset occurs. This field is also set by POR.</p> <p>0 Reset not caused by LVD trip, HVD trip or POR 1 Reset caused by LVD trip, HVD trip or POR</p>
0 Reserved	<p>This field is reserved. This read-only field is reserved and always has the value 0.</p>

26.4.4 Reset Pin Control register (RCM_RPC)**NOTE**

This register is reset on Chip POR only, it is unaffected by other reset types.

NOTE

The bus clock filter is reset when disabled or when entering stop mode. The LPO filter is reset when disabled.

Reset memory map and register descriptions

Address: 0h base + Ch offset = Ch

Bit	31	30	29	28	27	26	25	24		23	22	21	20	19	18	17	16
R	0																
W	[Shaded]																
Reset	0	0	0	0	0	0	0	0		0	0	0	0	0	0	0	0
Bit	15	14	13	12	11	10	9	8		7	6	5	4	3	2	1	0
R	0			RSTFLTSEL					0					RSTFLTSS	RSTFLTSR		
W	[Shaded]			[Shaded]					[Shaded]					[Shaded]	W		
Reset	0	0	0	0	0	0	0	0		0	0	0	0	0	0	0	0

RCM_RPC field descriptions

Field	Description
31–13 Reserved	This field is reserved. This read-only field is reserved and always has the value 0.
12–8 RSTFLTSEL	Reset Pin Filter Bus Clock Select Selects the reset pin bus clock filter width: <ul style="list-style-type: none"> • Transition lengths less than RSTFLTSEL cycles are filtered. • Transition lengths between RSTFLTSEL and (RSTFLTSEL+1) cycles (inclusive) may be filtered. • Transition lengths greater than (RSTFLTSEL+1) cycles are not filtered.
7–3 Reserved	This field is reserved. This read-only field is reserved and always has the value 0.
2 RSTFLTSS	Reset Pin Filter Select in Stop Mode Selects how the reset pin filter is enabled in any stop mode. 0 All filtering disabled 1 LPO clock filter enabled
RSTFLTSRW	Reset Pin Filter Select in Run and Wait Modes Selects how the reset pin filter is enabled in run and wait modes. 00 All filtering disabled 01 Bus clock filter enabled for normal operation 10 LPO clock filter enabled for normal operation 11 Reserved

26.4.5 Sticky System Reset Status Register (RCM_SSRS)

This register includes status flags to indicate all reset sources since the last POR or LVD that have not been cleared by software. Software can clear the status flags by writing a logic one to a flag.

Address: 0h base + 18h offset = 18h

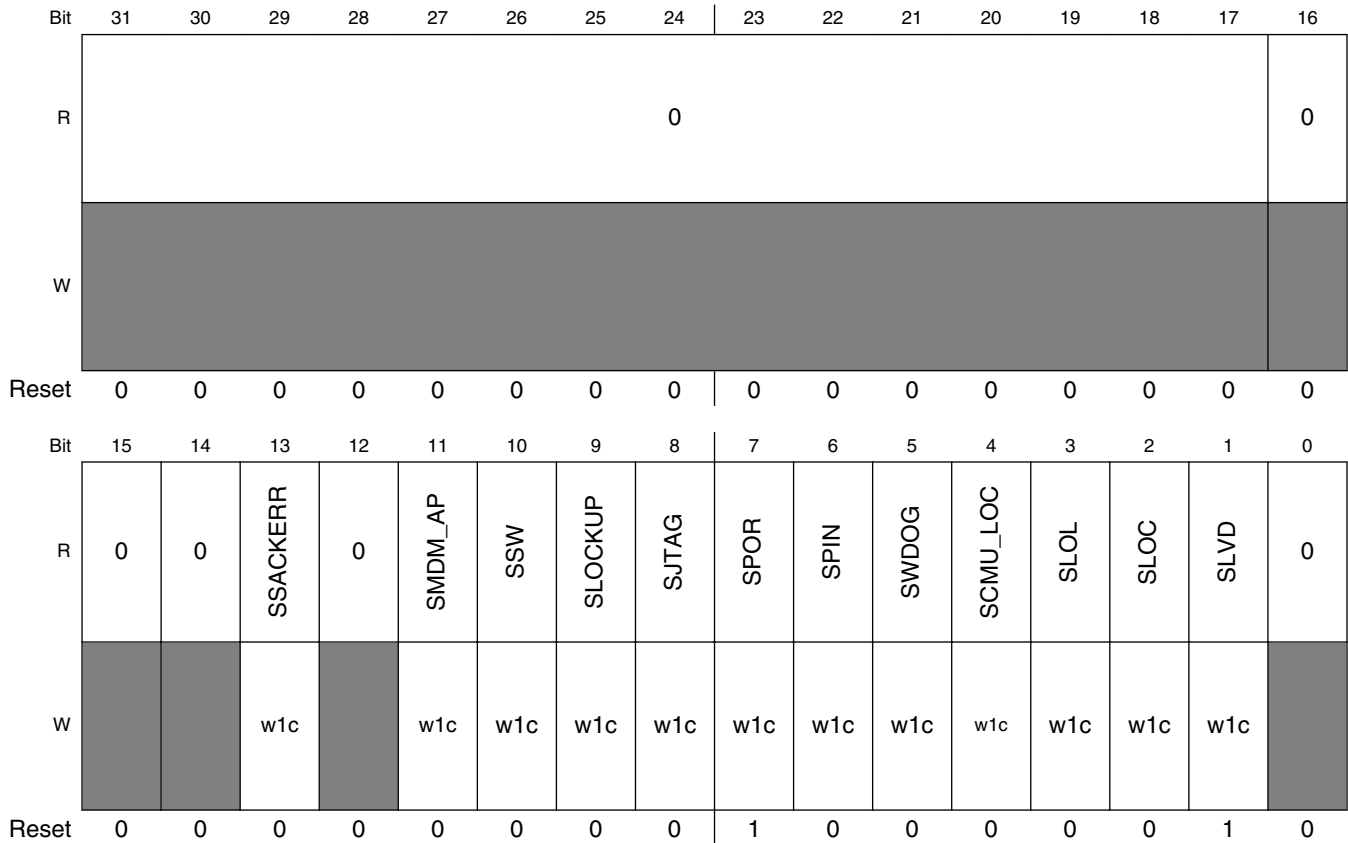

RCM_SSRS field descriptions

Field	Description
31–17 Reserved	This field is reserved. This read-only field is reserved and always has the value 0.
16 Reserved	This field is reserved. This read-only field is reserved and always has the value 0.
15 Reserved	This field is reserved. This read-only field is reserved and always has the value 0.
14 Reserved	This field is reserved. This read-only field is reserved and always has the value 0.
13 SSACKERR	Sticky Stop Acknowledge Error

Table continues on the next page...

RCM_SSRS field descriptions (continued)

Field	Description
	Indicates that after an attempt to enter Stop mode, a reset has been caused by a failure of one or more peripherals to acknowledge within approximately one second to enter stop mode. 0 Reset not caused by peripheral failure to acknowledge attempt to enter stop mode 1 Reset caused by peripheral failure to acknowledge attempt to enter stop mode
12 Reserved	This field is reserved. This read-only field is reserved and always has the value 0.
11 SMDM_AP	Sticky MDM-AP System Reset Request Indicates a reset has been caused by the host debugger system setting of the System Reset Request bit in the MDM-AP Control Register. 0 Reset was not caused by host debugger system setting of the System Reset Request bit 1 Reset was caused by host debugger system setting of the System Reset Request bit
10 SSW	Sticky Software Indicates a reset has been caused by software setting of SYSRESETREQ bit in Application Interrupt and Reset Control Register in the Arm core. 0 Reset not caused by software setting of SYSRESETREQ bit 1 Reset caused by software setting of SYSRESETREQ bit
9 SLOCKUP	Sticky Core Lockup Indicates a reset has been caused by the Arm core indication of a LOCKUP event. 0 Reset not caused by core LOCKUP event 1 Reset caused by core LOCKUP event
8 SJTAG	Sticky JTAG generated reset Indicates a reset has been caused by the JTAG selection of certain IR codes: EXTEST, HIGHZ, and CLAMP. 0 Reset not caused by JTAG 1 Reset caused by JTAG
7 SPOR	Sticky Power-On Reset Indicates a reset has been caused by the power-on detection logic. Because the internal supply voltage was ramping up at the time, the low-voltage reset (LVD) status bit is also set to indicate that the reset occurred while the internal supply was below the LVD threshold. 0 Reset not caused by POR 1 Reset caused by POR
6 SPIN	Sticky External Reset Pin Indicates a reset has been caused by an active-low level on the external $\overline{\text{RESET}}$ (RESET_b) pin. 0 Reset not caused by external reset pin 1 Reset caused by external reset pin
5 SWDOG	Sticky Watchdog Indicates a reset has been caused by the watchdog timer timing out. This reset source can be blocked by disabling the watchdog.

Table continues on the next page...

RCM_SSRS field descriptions (continued)

Field	Description
	0 Reset not caused by watchdog timeout 1 Reset caused by watchdog timeout
4 SCMU_LOC	Sticky CMU Loss-of-Clock Reset Indicates a reset has been caused by the CMU loss-of-clock circuit. CMU_FC_GCR[FCE] must be set to enable the frequency check circuit. See the CMU chapter for details. 0 Reset not caused by the CMU loss-of-clock circuit. 1 Reset caused by the CMU loss-of-clock circuit.
3 SLOL	Sticky Loss-of-Lock Reset Indicates a reset has been caused by a loss of lock in the SCG PLL/FLL. See the SCG description for information on the loss-of-lock event. 0 Reset not caused by a loss of lock in the PLL/FLL 1 Reset caused by a loss of lock in the PLL/FLL
2 SLOC	Sticky Loss-of-Clock Reset Indicates a reset has been caused by a loss of external clock. The SCG SOSC clock monitor must be enabled for a loss of clock to be detected. Refer to the detailed SCG description for information on enabling the clock monitor. 0 Reset not caused by a loss of external clock. 1 Reset caused by a loss of external clock.
1 SLVD	Sticky Low-Voltage Detect Reset If PMC_LVDSC1[LVDRE] is set and the supply drops below the LVD trip voltage, an LVD reset occurs. This field is also set by POR. 0 Reset not caused by LVD trip or POR 1 Reset caused by LVD trip or POR
0 Reserved	This field is reserved. This read-only field is reserved and always has the value 0.

26.4.6 System Reset Interrupt Enable Register (RCM_SRIE)

This register provides the option to delay the assertion of a system reset for a period of time (DELAY field) while an interrupt is generated. When an interrupt for a reset source is enabled, software has time to perform a graceful shutdown. A Chip POR source cannot be delayed by this feature. The SRS updates only after the system reset occurs.

NOTE

The reset delay feature requires the LPO clock to remain active.

NOTE

This register is reset on Chip POR only, it is unaffected by other reset types.

Reset memory map and register descriptions

Address: 0h base + 1Ch offset = 1Ch

Bit	31	30	29	28	27	26	25	24	23	22	21	20	19	18	17	16
R	0															0
W																
Reset	0	0	0	0	0	0	0	0	0	0	0	0	0	0	0	0
Bit	15	14	13	12	11	10	9	8	7	6	5	4	3	2	1	0
R	0	0	SACKERR	0	MDM_AP	SW	LOCKUP	JTAG	GIE	PIN	WDOG	CMU_LOC	LOL	LOC	DELAY	
W																
Reset	0	0	0	0	0	0	0	0	0	0	0	0	0	0	0	0

RCM_SRIE field descriptions

Field	Description
31–17 Reserved	This field is reserved. This read-only field is reserved and always has the value 0.
16 Reserved	This field is reserved. This read-only field is reserved and always has the value 0.
15 Reserved	This field is reserved. This read-only field is reserved and always has the value 0.
14 Reserved	This field is reserved. This read-only field is reserved and always has the value 0.
13 SACKERR	Stop Acknowledge Error Interrupt 0 Interrupt disabled. 1 Interrupt enabled.
12 Reserved	This field is reserved. This read-only field is reserved and always has the value 0.
11 MDM_AP	MDM-AP System Reset Request 0 Interrupt disabled. 1 Interrupt enabled.
10 SW	Software Interrupt 0 Interrupt disabled. 1 Interrupt enabled.
9 LOCKUP	Core Lockup Interrupt NOTE: The LOCKUP bit is useful only in devices with more than one core processor. 0 Interrupt disabled. 1 Interrupt enabled.
8 JTAG	JTAG generated reset 0 Interrupt disabled. 1 Interrupt enabled.

Table continues on the next page...

RCM_SRIE field descriptions (continued)

Field	Description
7 GIE	Global Interrupt Enable 0 All interrupt sources disabled. 1 All interrupt sources enabled. Note that the individual interrupt-enable bits still need to be set to generate interrupts.
6 PIN	External Reset Pin Interrupt 0 Reset not caused by external reset pin 1 Reset caused by external reset pin
5 WDOG	Watchdog Interrupt 0 Interrupt disabled. 1 Interrupt enabled.
4 CMU_LOC	CMU Loss-of-Clock Interrupt 0 Interrupt disabled. 1 Interrupt enabled.
3 LOL	Loss-of-Lock Interrupt 0 Interrupt disabled. 1 Interrupt enabled.
2 LOC	Loss-of-Clock Interrupt 0 Interrupt disabled. 1 Interrupt enabled.
DELAY	Reset Delay Time Configures the maximum reset delay time from when the interrupt is asserted and the system reset occurs. 00 10 LPO cycles 01 34 LPO cycles 10 130 LPO cycles 11 514 LPO cycles

Chapter 27

Clock Distribution

27.1 Introduction

This chapter presents the clock architecture overview of this device, clock distribution, module clocks, and clock terminology. The System Clock Generator (SCG) module is used to generate most of the clocks used by the device. The SCG module controls which clock source (internal references, external crystals, external clocks) is used to derive system clocks. The SCG also divides the selected clock source into a variety of clock domains, including clocks for system bus masters, system bus slaves, and flash memory.

The clock generation circuitry provides several clock dividers and selectors allowing different modules to be clocked at a frequency specific for that module. Clock generation logic also implements module specific clock gating allowing modules to be individually disabled. Thus, allowing optimization for performance or low power.

Various modules have specific clocks that can be generated from FIRC_CLK, SIRC_CLK, SOSC_CLK, SPLL_CLK, or Power Management Controller (PMC) clock signal (LPO128K_CLK). In addition, modules specific clocks that can be configured from alternate sources. Clock selection for most modules is controlled by the PCC module.

27.2 High level clocking diagram

The following diagram shows the high-level clocking architecture and various clock sources for this device.

Clock definitions

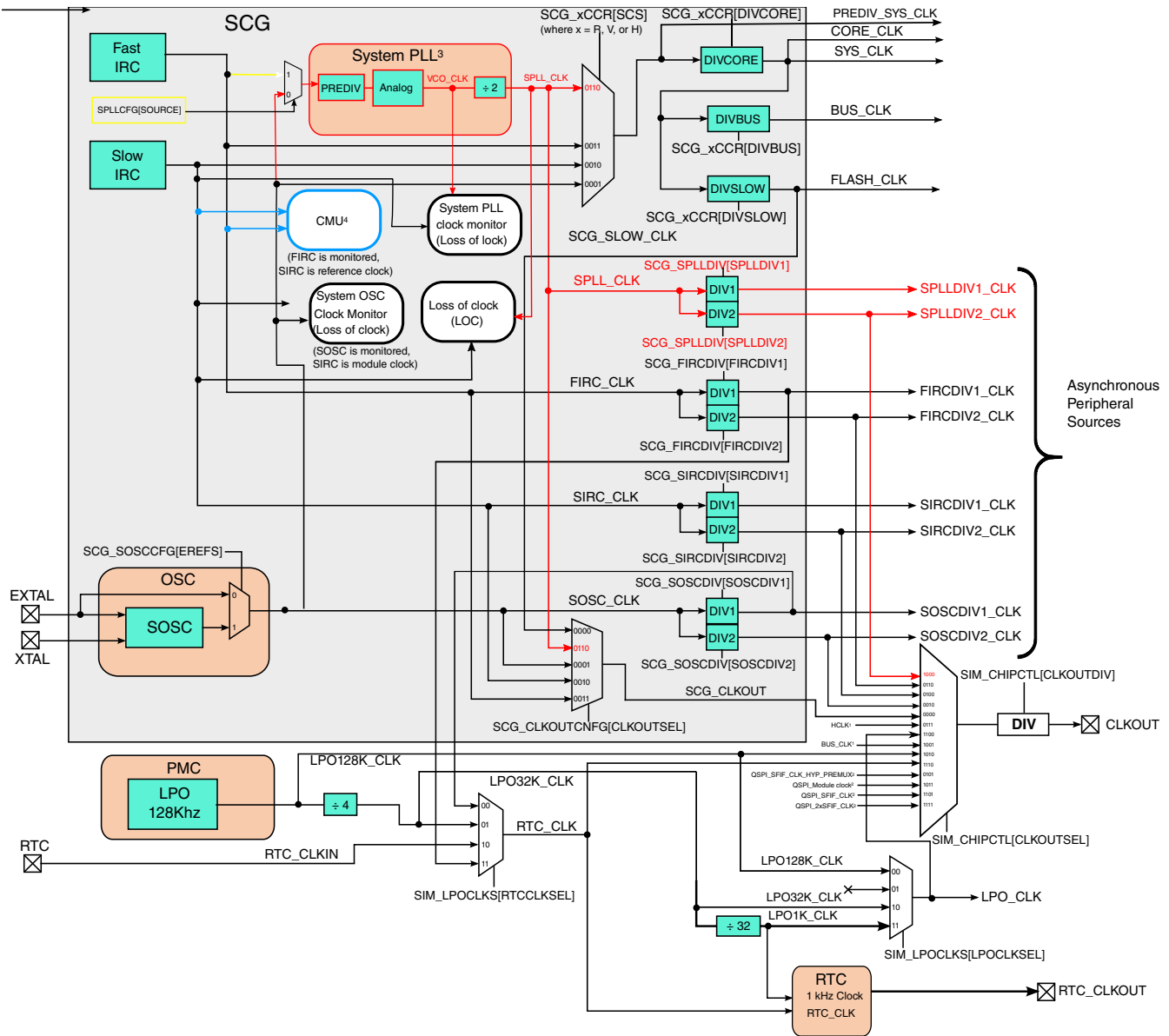

1. The source of HCLK (to Arm® Cortex® modules) is CORE_CLK. See section 'Clock definitions' for CORE_CLK and BUS_CLK
2. QSPI clocks are applicable for S32K148 only and Reserved for others. See QuadSPI clocking diagram in table 'Peripheral module clocking'
3. For S32K11x, inputs and muxes connected to PCC are Reserved. Also SPLLDIV_x_CLK are Reserved as indicated in **RED**
4. Available only in S32K11x as indicated in **BLUE**
5. Available only in S32K14xW as indicated in **YELLOW**

Figure 27-1. Clocking diagram

27.3 Clock definitions

The following table describes clocks shown in Figure 27-1 and other sections of this document.

Table 27-1. Clock descriptions

Clock name	Related clock selector	Related clock divider	Description
PREDIV_SYS_CLK ¹	SCG_xCCR[SCS]	—	Clocks the QSPI memory in HSRUN 80 mode.
CORE_CLK ²	SCG_xCCR[SCS]	SCG_xCCR[DIVCORE] (÷ 1...16)	Clocks the Arm core, divided by DIVCORE bits inside SCG.
SYS_CLK ²	SCG_xCCR[SCS]	SCG_xCCR[DIVCORE] (÷ 1...16)	Clocks the Crossbar, NVIC, Flash controller, FTM, PDB, and so on.
BUS_CLK	SCG_xCCR[SCS]	SCG_xCCR[DIVBUS] (÷ 1...16)	Clocks the chip peripherals.
FLASH_CLK ³ (SCG_SLOW_CLK in SCG)	SCG_xCCR[SCS]	SCG_xCCR[DIVSLOW] (÷ 1...8)	Clocks the flash module.
SPLL_CLK ⁴	—	—	Output of PLL (VCO_CLK ÷ 2)
SIRC_CLK	—	—	Output clock of Slow IRC.
FIRC_CLK	—	—	Output clock of Fast IRC.
SOSC_CLK	SCG_SOSCCFG[EREFS]	—	System oscillator clock. Can be either the EXTAL pin or output of oscillator (SOSC). NOTE: ERCLK/OSCERCLK stands for the same clock source, in some module chapters.
RTC_CLKOUT	—	—	RTC oscillator output driving external pin.
LPO32K_CLK	SIM_LPOCLKS[CLK32SEL]	A fixed divide by 4 of LPO_CLK drives 01b input of RTC_CLK multiplexer.	Source clock for RTC.
LPO128K_CLK	—	—	Always on low power oscillator clock generated by PMC.
SCG_CLKOUT	SCG_CLKOUTCNFG[CLKOUTSEL]	—	SCG output clock that can be driven by SOSC_CLK, SIRC_CLK, FIRC_CLK, SPLL_CLK ⁴ , or SCG_SLOW_CLK (FLASH_CLK).
LPO_CLK	SIM_LPOCLKS[LPOCLKSEL]	—	Clock output generated from one of three LPO clocks sources (LPO128K_CLK, LPO32K_CLK, LPO1K_CLK).
CLKOUT	SIM_CHIPCTL[CLKOUTSEL]	SIM_CHIPCTL[CLKOUTDIV] (÷ 1...8)	Selected from one of eight internal clock sources.
VCO_CLK ⁴	—	—	VCO output clock within PLL. Its frequency = SPLL_CLK × 2.
SPLLDIV1_CLK ⁴	—	SCG_SPLLDIV[SPLLDIV1] (÷ 1, 2, 4, 8, 16, 32, 64, or output disabled)	Divided SPLL_CLK This should be configured to 80MHz or less in RUN mode and to 112 MHz or less in HSRUN mode.
SPLLDIV2_CLK ⁴	—	SCG_SPLLDIV[SPLLDIV2] (÷ 1, 2, 4, 8, 16, 32, 64, or output disabled)	Divided SPLL_CLK This should be configured to 40 MHz or less in RUN mode and 56 MHz or less in HSRUN mode.

Table continues on the next page...

Table 27-1. Clock descriptions (continued)

Clock name	Related clock selector	Related clock divider	Description
FIRCDIV1_CLK	—	SCG_FIRCDIV[FIRCDIV1] (÷ 1, 2, 4, 8, 16, 32, 64, or output disabled)	Divided FIRC_CLK This should be configured to 48 MHz or less in RUN/HSRUN mode.
FIRCDIV2_CLK	—	SCG_FIRCDIV[FIRCDIV2] (÷ 1, 2, 4, 8, 16, 32, 64, or output disabled)	Divided FIRC_CLK This should be configured to 48 MHz or less in RUN/HSRUN mode.
SIRCDIV1_CLK	—	SCG_SIRCDIV[SIRCDIV1] (÷ 1, 2, 4, 8, 16, 32, 64, or output disabled)	Divided SIRC_CLK This should be configured to 8 MHz or less in RUN/HSRUN mode and to 4 MHz or less in VLPR/VLPS mode.
SIRCDIV2_CLK	—	SCG_SIRCDIV[SIRCDIV2](÷ 1, 2, 4, 8, 16, 32, 64, or output disabled)	Divided SIRC_CLK This should be configured to 8 MHz or less in RUN/HSRUN mode and to 4 MHz or less in VLPR/VLPS mode.
SOSCDIV1_CLK	—	SCG_SOSCDIV[SOSCDIV1] (÷ 1, 2, 4, 8, 16, 32, 64, or output disabled)	Divided SOSC_CLK This should be configured to 40 MHz or less in RUN/HSRUN mode.
SOSCDIV2_CLK	—	SCG_SOSCDIV[SOSCDIV2] (÷ 1, 2, 4, 8, 16, 32, 64, or output disabled)	Divided SOSC_CLK This should be configured to 40 MHz or less in RUN/HSRUN mode.

1. Only available in S32K148
2. SYS_CLK/CORE_CLK must not be configured to less than BUS_CLK.
3. For FLASH_CLK operating range during parallel boot see [Device Boot modes](#)
4. Only available in S32K14x series

NOTE

Configuring DIVSLOW_CLK to lower frequencies than supported flash frequencies mentioned in datasheet (fFLASH) adds wait states and no power saving. It is recommended to configure DIVSLOW_CLK as close to fFLASH.

27.4 Internal clocking requirements

The clock dividers are programmed via the SCG module's clock divider registers. The following requirements must be met when configuring the clocks for this chip:

- CORE_CLK and SYS_CLK clock frequency must be 112 MHz or less in HSRUN mode and 80 MHz in normal RUN mode (but not configured to be less than BUS_CLK).
- BUS_CLK frequency must be programmed to 56 MHz or less in HSRUN, 48 MHz or less in RUN (when using PLL as system clock source maximum bus clock

frequency is 40 MHz. See Option 1 and 3 below), and an integer divide of the CORE_CLK.

- FLASH_CLK frequency must be programmed to 28 MHz or less in HSRUN, 26.67 MHz or less in RUN, and an integer divide of the CORE_CLK. The core clock to flash clock ratio is limited to a max value of 8.

The following are a few of the common clock configurations for this chip in the four clocking modes:

Option 1: Slow RUN (typically using the undivided FIRC)¹, using the following [Memory Map/Register Definition](#) register settings:

- SCG_RCCR[SCS] = 0011b
- SCG_RCCR[DIVCORE] = 0000b
- SCG_RCCR[DIVBUS] = 0000b
- SCG_RCCR[DIVSLOW] = 0001b

Table 27-2. Slow RUN example

Clock	Frequency	
	S32K14x and S32K11x	S32K14xW
CORE_CLK	48 MHz	48 MHz
SYS_CLK	48 MHz	48 MHz
BUS_CLK	48 MHz (max freq. in RUN mode)	48 MHz (max freq. in RUN mode)
FLASH_CLK	24 MHz	16 MHz

Option 2: Normal RUN (with VCO_CLK = 320 MHz, SPLL_CLK = 160 MHz), using the following [Memory Map/Register Definition](#) register settings:

- SCG_RCCR[SCS] = 0110b
- SCG_RCCR[DIVCORE] = 0001b
- SCG_RCCR[DIVBUS] = 0001b
- SCG_RCCR[DIVSLOW] = 0010b

Table 27-3. Normal RUN example

Clock	Frequency	
	S32K14x and S32K11x	S32K14xW
CORE_CLK	80 MHz	80 MHz
SYS_CLK	80 MHz	80 MHz
BUS_CLK	40 MHz	40 MHz
FLASH_CLK	26.67 MHz (max freq. in RUN mode)	20 MHz (max freq. in RUN mode)

1. Default configuration after reset. FIRC_CLK = 48 MHz.

Option 3: Normal RUN (with VCO_CLK = 256 MHz, SPLL_CLK = 128 MHz), using the following [Memory Map/Register Definition](#) register settings:

- SCG_RCCR[SCS] = 0110b
- SCG_RCCR[DIVCORE] = 0001b
- SCG_RCCR[DIVBUS] = 0001b
- SCG_RCCR[DIVSLOW] = 0010b

Table 27-4. Normal RUN example

Clock	Frequency	
	S32K14x and S32K11x	S32K14xW
CORE_CLK	64 MHz	64 MHz
SYS_CLK	64 MHz	64 MHz
BUS_CLK	32 MHz	32 MHz
FLASH_CLK	21.33 MHz	16 MHz

Option 4: High Speed RUN (with VCO_CLK = 224 MHz, SPLL_CLK = 112 MHz), using the following [Memory Map/Register Definition](#) register settings:

- SCG_HCCR[SCS] = 0110b
- SCG_HCCR[DIVCORE] = 0000b
- SCG_HCCR[DIVBUS] = 0001b
- SCG_HCCR[DIVSLOW] = 0011b

Table 27-5. High Speed RUN example

Clock	Frequency
	S32K14x
CORE_CLK	112 MHz
SYS_CLK	112 MHz
BUS_CLK	56 MHz
FLASH_CLK	28 MHz

NOTE

All frequencies listed in table above are maximum for HSRUN mode.

Option 5: High Speed RUN 80 (with VCO_CLK = 320 MHz, SPLL_CLK = 160 MHz), using the following [Memory Map/Register Definition](#) register settings:

- SCG_HCCR[SCS] = 0110b
- SCG_HCCR[DIVCORE] = 0001b
- SCG_HCCR[DIVBUS] = 0001b
- SCG_HCCR[DIVSLOW] = 0010b

Table 27-6. High Speed RUN 80 example (mode used by QuadSPI only)

Clock	Frequency
	S32K14x
CORE_CLK	80 MHz
SYS_CLK	80 MHz
BUS_CLK	40 MHz
FLASH_CLK	26.67 MHz (maximum frequency in RUN mode)

Option 6: Very Low Power RUN, VLPR (with SIRC_CLK = 8 MHz), using the following [Memory Map/Register Definition](#) register settings:

- SCG_VCCR[SCS] = 0010b (SIRC_CLK)
- SCG_VCCR[DIVCORE] = 0001b
- SCG_VCCR[DIVBUS] = 0000b
- SCG_VCCR[DIVSLOW] = 0011b

Table 27-7. Very low power RUN example

Clock	Frequency	
	S32K14x and S32K11x	S32K14xW
CORE_CLK	4 MHz	1 MHz
SYS_CLK	4 MHz	1 MHz
BUS_CLK	4 MHz	1 MHz
FLASH_CLK	1 MHz	0.25 MHz

Following table summarizes the maximum frequencies and example configurations for each internal clock

Internal clocking requirements

Clock	HSRUN		RUN			VLPR		Notes
	S32K14x	S32K14xW	S32K14x	S32K14xW	S32K11x	S32K14x and S32K11x	S32K14xW	
CORE_CLK, SYS_CLK	112 MHz	NA	80 MHz	80 MHz	48 MHz	4 MHz	1 MHz	Must be configured to be more than or equal to BUS_CLK.
BUS_CLK	56 MHz	NA	48 MHz (40 MHz when using PLL as system clock source)	48 MHz	48 MHz	4 MHz	1 MHz	Must be integer divide of the CORE_CLK.
FLASH_CLK	28 MHz	NA	26.67 MHz	20 MHz	24 MHz	1 MHz	0.25 MHz	Must be integer divide of the CORE_CLK. The core clock to flash clock ratio is limited to a max value of 8.

NOTE

All frequencies listed in table above are maximum for VLPR mode.

NOTE

All asynchronous clock sources will also be restricted to 4 MHz in VLPR/VLPS mode as configured in SCG_SIRCDIV.

27.4.1 Clock divider values after reset

The default configuration out of reset has the CPU clocked by the Fast IRC (FIRC_CLK). The clocks (for example, CORE_CLK, FLASH_CLK, and BUS_CLK) are configured in the SCG module (see [Memory Map/Register Definition](#)).

27.4.2 HSRUN mode clocking

Clock dividers should not be modified while the chip is operating in HSRUN mode. They must be configured prior to entering HSRUN mode to guarantee:

- CORE_CLK/SYS_CLK is less than or equal to 112MHz
- BUS_CLK is less than or equal to 56 MHz
- FLASH_CLK is less than or equal to 28 MHz

27.4.3 VLPR mode clocking

Clock dividers should not be modified while the chip is operating in VLPR mode. They must be configured prior to entering VLPR mode to guarantee:

- CORE_CLK/SYS_CLK and BUS_CLK are less than or equal to 4 MHz and 1 MHz for S32K14x/S32K11x and S32K14xW variants respectively.
- FLASH_CLK is less than or equal to 1 MHz and 0.25 MHz for S3K14x/S32K11x and S32K14xW variants respectively.

NOTE

- For S32K14x and S32K11x variants: All asynchronous clock sources will also be restricted to 4 MHz in VLPR/VLPS mode as configured in SCG_SIRCDIV.
- For S32K14xW variants: All asynchronous clock sources will also be restricted to 1 MHz in VLPR/VLPS mode as configured in SCG_SIRCDIV.

27.4.4 VLPR/VLPS mode entry

When entering VLPR/VLPS mode, the system clock should be SIRC. The FIRC, SOSC, and SPLL must be disabled by software in RUN mode before making any mode transition. Ensure that CMU is gated by its PCC.CGC before entering STOP/VLPS/CPO mode.

27.5 Clock Gating

The clock to each module can be individually gated on and off using the PCC module. After any reset, PCC disables the clock to the corresponding module to conserve power. Prior to initializing a module, set the corresponding clock gating control bits in PCC register to enable the clock. Before turning off the clock, make sure to disable the module.

Any bus access to a peripheral that has its clock disabled generates an error termination.

27.6 Module clocks

The following table summarizes the clocks that can be used by each of the modules.

Table 27-8. Peripheral clock summary

Module name	Bus interface clock ¹	Bus interface clock ¹ gating	Peripheral functional clock	Additional clocks	Comments and maximum frequencies
		Gated by [CGC] of PCC	Clocks controlled by [PCS] of PCC		
Communications					
LPUART	BUS_CLK	Yes	SPLLDIV2_CLK, FIRCDIV2_CLK, SIRCDIV2_CLK, SOSCDIV2_CLK	—	Maximum frequency governed by BUS_CLK
LPSPi	BUS_CLK	Yes	SPLLDIV2_CLK, FIRCDIV2_CLK, SIRCDIV2_CLK, SOSCDIV2_CLK	—	Maximum frequency governed by BUS_CLK
LPI2C	BUS_CLK	Yes	SPLLDIV2_CLK, FIRCDIV2_CLK, SIRCDIV2_CLK, SOSCDIV2_CLK	—	Maximum frequency governed by BUS_CLK

Table continues on the next page...

Table 27-8. Peripheral clock summary (continued)

Module name	Bus interface clock ¹	Bus interface clock ¹ gating	Peripheral functional clock	Additional clocks	Comments and maximum frequencies
		Gated by [CGC] of PCC	Clocks controlled by [PCS] of PCC		
FlexIO ³	BUS_CLK	Yes	SPLLDIV2_CLK, FIRCDIV2_CLK, SIRCDIV2_CLK, SOSCDIV2_CLK	—	Maximum frequency governed by BUS_CLK
FlexCAN	SYS_CLK	Yes	—	SYS_CLK, SOSCDIV2_CLK	Support 40 MHz from OSC; SYS_CLK must be > 1.5x the protocol clock; while synchronous operation (when protocol clock is selected to SYS_CLK) can be done at 1:1 clock frequency. ⁴
Timers					
LPTMR	BUS_CLK	Yes	SPLLDIV2_CLK, FIRCDIV2_CLK, SIRCDIV2_CLK, SOSCDIV2_CLK	RTC_CLK ² , SIRCDIV2_CLK, LPO1K_CLK	Maximum frequency governed by BUS_CLK
LPIT	BUS_CLK	Yes	SPLLDIV2_CLK, FIRCDIV2_CLK, SIRCDIV2_CLK, SOSCDIV2_CLK, LPO128K_CLK ⁵	—	Maximum frequency governed by BUS_CLK
RTC	BUS_CLK	Yes	—	RTC_CLK ² , LPO1K_CLK	Maximum frequency governed by BUS_CLK
PDB	SYS_CLK	Yes	—	—	Maximum frequency governed by SYS_CLK
FlexTimer	SYS_CLK	Yes	SPLLDIV1_CLK, FIRCDIV1_CLK, SIRCDIV1_CLK, SOSCDIV1_CLK	RTC_CLK ² , SYS_CLK, TCLKx	Maximum frequency governed by SYS_CLK
System Modules					
WDOG	BUS_CLK	No	—	LPO_CLK ⁶ , SOSC_CLK, SIRC_CLK	Maximum frequency governed by BUS_CLK
EWM	BUS_CLK	Yes	—	LPO_CLK ⁶	Maximum frequency governed by BUS_CLK
PMC	BUS_CLK	No	—	—	Maximum frequency governed by BUS_CLK
SIM	BUS_CLK	No	—	—	Maximum frequency governed by BUS_CLK
RCM	BUS_CLK	No	—	LPO128K_CLK	Maximum frequency governed by BUS_CLK

Table continues on the next page...

Table 27-8. Peripheral clock summary (continued)

Module name	Bus interface clock ¹	Bus interface clock ¹ gating	Peripheral functional clock	Additional clocks	Comments and maximum frequencies
		Gated by [CGC] of PCC	Clocks controlled by [PCS] of PCC		
CRC	BUS_CLK	Yes	—	—	Maximum frequency governed by BUS_CLK
PORT	BUS_CLK	Yes	—	LPO128K_CLK	Maximum frequency governed by BUS_CLK
GPIO	SYS_CLK	No	—	—	Maximum frequency governed by SYS_CLK
TRGMUX	BUS_CLK	No	—	—	Maximum frequency governed by BUS_CLK
DMAMUX	BUS_CLK	Yes	—	—	Maximum frequency governed by BUS_CLK
DMA	SYS_CLK	No	—	—	Maximum frequency governed by SYS_CLK
MPU	SYS_CLK	No	—	—	Maximum frequency governed by SYS_CLK
EIM	SYS_CLK	No	—	—	Maximum frequency governed by SYS_CLK
ERM	SYS_CLK	No	—	—	Maximum frequency governed by SYS_CLK
MSCM	SYS_CLK	No	—	—	Maximum frequency governed by SYS_CLK
CMU	BUS_CLK	Yes	—	FIRC_CLK SIRC_CLK	—
Memory Modules					
FTFC ⁷	FLASH_CLK	Yes	—	—	Maximum frequency governed by FLASH_CLK
System RAM	SYS_CLK	No	—	—	Maximum frequency governed by SYS_CLK
Analog Modules					
ADC	BUS_CLK	Yes	SPLLDIV2_CLK, FIRCDIV2_CLK, SIRCDIV2_CLK, SOSCDIV2_CLK	—	50 MHz ⁸
CMP	BUS_CLK	Yes	—	—	Maximum frequency governed by BUS_CLK
QuadSPI	BUS_CLK/ SYS_CLK	Yes	SPLLDIV1_CLK FIRCDIV1_CLK	—	—
SAI	BUS_CLK	Yes	—	MCLK (from PAD) BCLK (from PAD)	—
ENET ⁹	SYS_CLK	Yes	SPLLDIV1_CLK SIRCDIV1_CLK FIRCDIV1_CLK	ENET_MII_RMII_TX_CLK (from PAD)	MAC timestamp clock period must be integer nano-seconds.

Table 27-8. Peripheral clock summary

Module name	Bus interface clock ¹	Bus interface clock ¹ gating	Peripheral functional clock	Additional clocks	Comments and maximum frequencies
		Gated by [CGC] of PCC	Clocks controlled by [PCS] of PCC		
			SOSCDIV1_CLK		

1. Refers to module's interface clock and should not be misinterpreted as BUS_CLK
2. RTC_CLK is the output from the multiplexer that uses SIM_LPOCLKS[RTCLKSEL] for source selection (See [Figure 1](#) for details).
3. FlexIO peripheral clock should not be more than twice of FlexIO bus interface clock. For fast access to FlexIO register (FLEXIO_CTRL[FASTACC]=1), FlexIO peripheral clock can be twice of FlexIO Bus interface clock.
4. In S32K11x variants, 'SYS_CLK > 1.5x the protocol clock' requirement is not applicable but the software needs to maintain following relationship:
 - CAN bit time > (3 x CANCLK period) + (3 x SYS_CLK period)
5. Only applicable for S32K14xW variants
6. LPO_CLK is the output from the multiplexer that uses SIM_LPOCLKS[LPOCLKSEL] for source selection (See [Figure 1](#) for details).
7. Do not change the clock control settings to the flash memory whilst simultaneously accessing the flash memory. Instead, it is recommended to execute from SRAM when a change in frequency is needed.
8. The maximum conversion clock frequency is 50 MHz. At any time, the conversion clock frequency should be less than the ADC bus interface clock frequency. See the device datasheet for ADC specifications.
9. Refer to [External signal description](#) for clocking restrictions.

NOTE

The above clock selections are controlled in the [PCC](#) module (column 4 of [Table 27-8](#)).

NOTE

- SIRC and LPO_CLK are the valid clock sources for VLP* modes.
- SPLL and FIRC are the valid clock sources for HSRUN mode.

The following table summarizes the clocks that can be used by each of the modules.

Table 27-9. Peripheral module clocking

Modules	PCC multiplexer
LPSPi LPIT ¹ FlexIO LPI2C LPUART	
LPIT ² T	
PDB	

Table continues on the next page...

Table 27-9. Peripheral module clocking (continued)

Modules	PCC multiplexer
DMAMUX CMP0 CRC	
GPIO	
PORT	

Table continues on the next page...

Table 27-9. Peripheral module clocking (continued)

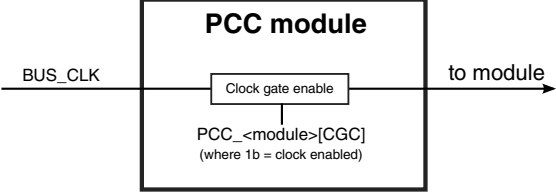
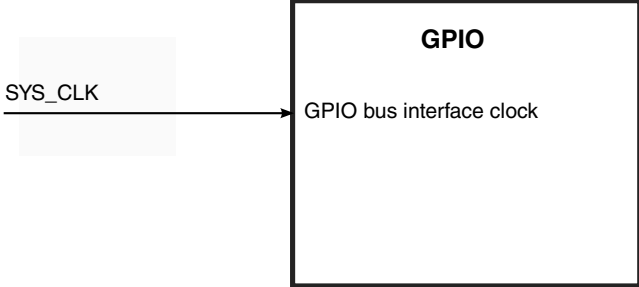
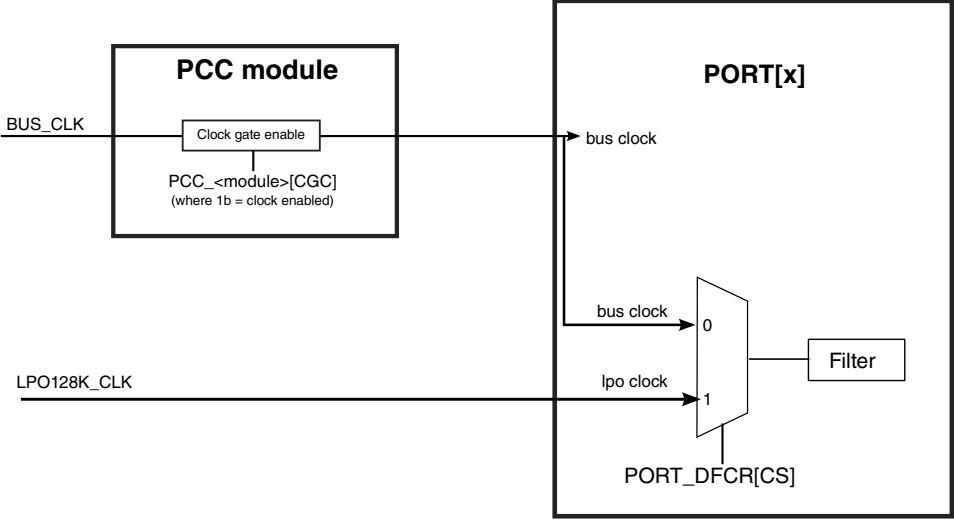
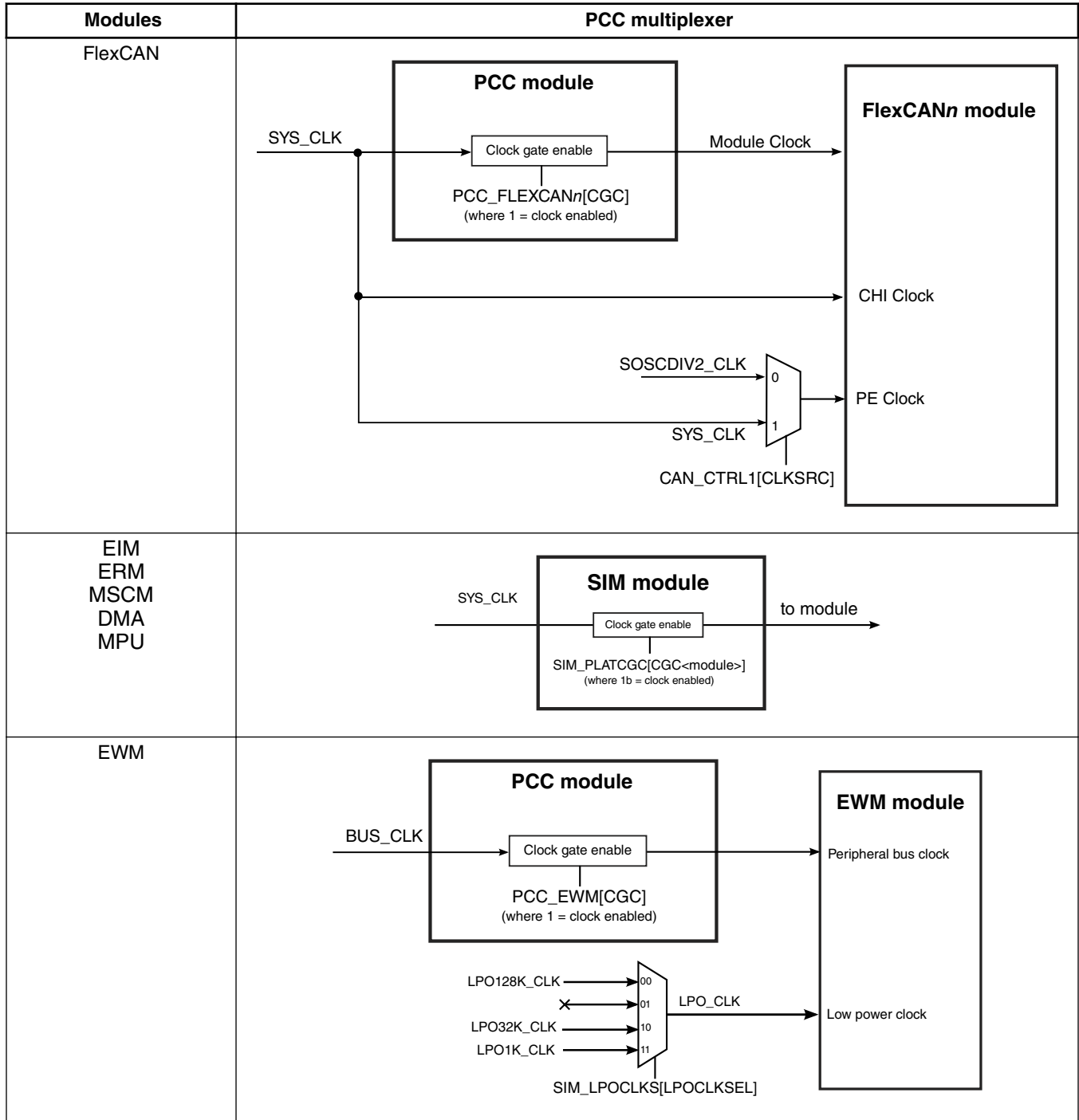

Table continues on the next page...

Table 27-9. Peripheral module clocking (continued)

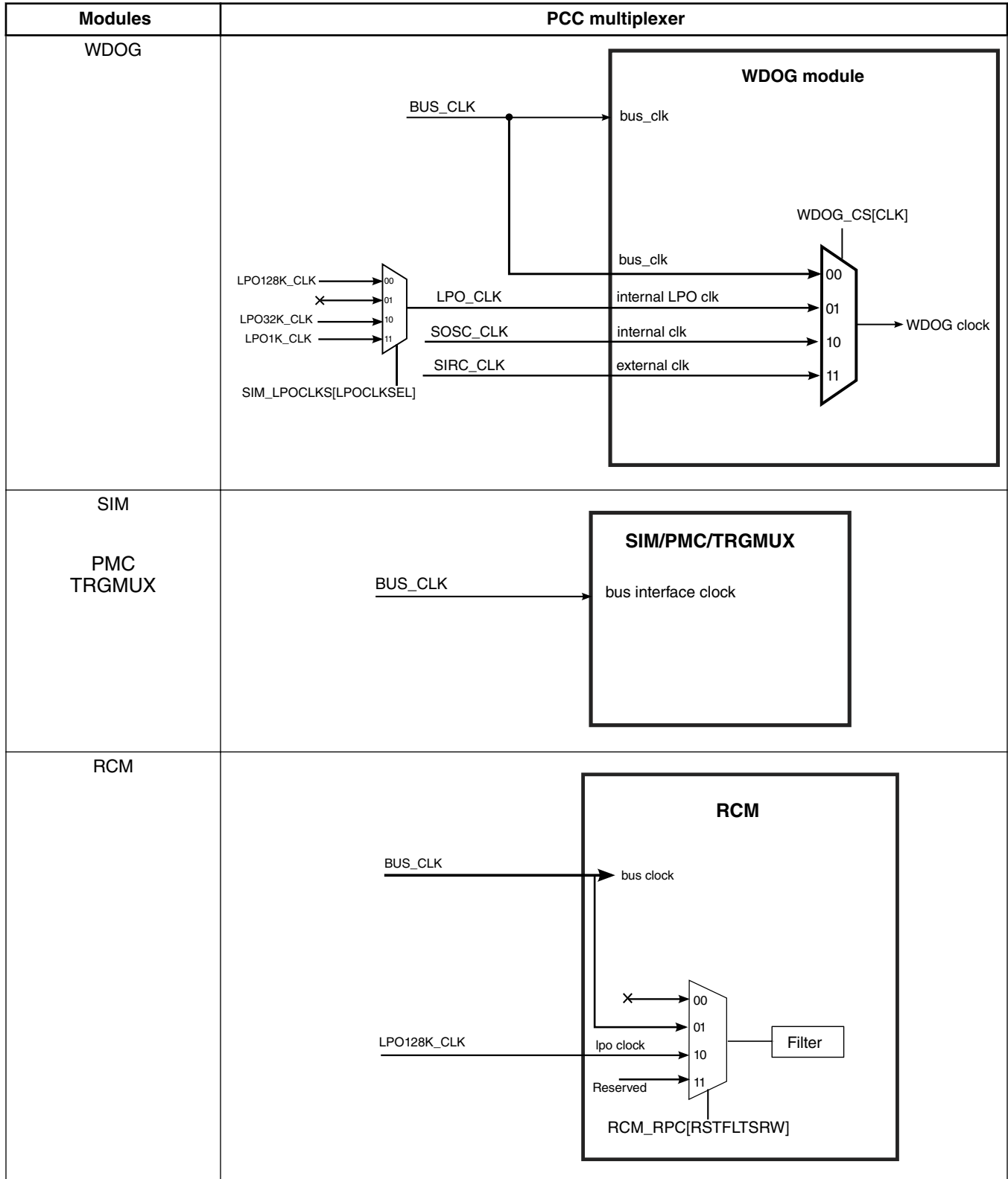

Table continues on the next page...

Table 27-9. Peripheral module clocking (continued)

Modules	PCC multiplexer
System RAM	
FTFC	
ADC	 <p>The ADC has multiple clock sources. Selection is determined by the configuration of PCC_ADCx[PCS]. The dividers should be configured such that the ADC conversion clock frequency lies within the valid range as per the ADC requirement (see the Data Sheet).</p>
FTM	

Table continues on the next page...

Table 27-9. Peripheral module clocking (continued)

Modules	PCC multiplexer
	 <p>The FTM module is clocked by the internal SYS_CLK (the FTM module refers to it as system clock) which could be up to CPU frequency, but the FTM counter allows to be clocked by three clock sources:</p> <ul style="list-style-type: none"> • System clock (SYS_CLK) from PCC • Internal fixed frequency clock • External clocks from pins (TCLK[2:0]) <p>The counter clock source selection is controlled by CLKS bits in FTMn_SC register. The FTM_CLK is controlled by PCC module and could run up to CPU frequency and provide higher resolution for the FTM timer.</p> <p>The fixed frequency clock is a fixed clock driven by RTC_CLK. SIM_LPOCLKS[RTCCLKSEL] is used to select the RTC_CLK source.</p> <p>There are three clocks that can be accessed externally to the chip (TCLK0, TCLK1, TCLK2). One of these clocks are selected to drive the 000b input of the multiplexer in the PCC (PCC_FLEXTMRn[PCS] = 000b) by configuring SIM_FTMOPT0[FTMnCLKSEL].</p> <p>The fixed frequency clock and external clocks provide the user more clock options for FTM counter.</p>
RTC	

Table continues on the next page...

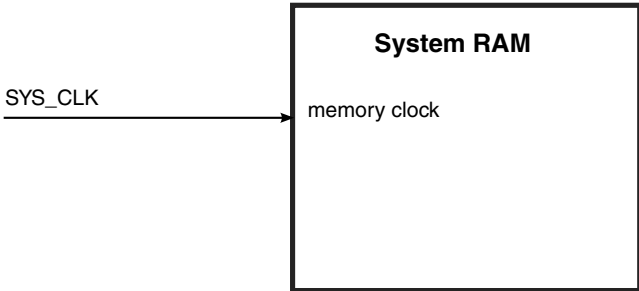
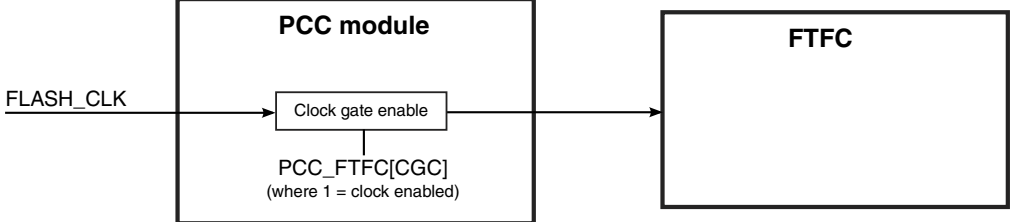
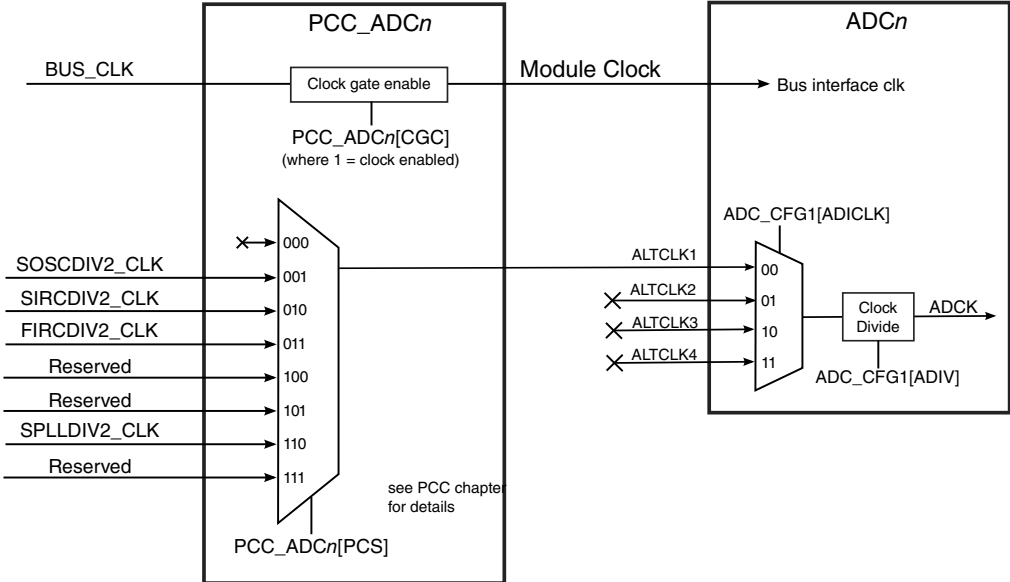
Table 27-9. Peripheral module clocking (continued)

Modules	PCC multiplexer
<p>LPTMR</p>	 <p>The prescaler and glitch filter of the LPTMR0 module can be clocked from misc sources determined by the PCC_LPTMR[PCS] control bitfield and LPTMR0_PSR[PCS] bitfield. The LPTMR_PSR[PCS] bitfield is used for internal LPTMR to select the clock source. The supported clock sources on this device are shown in following figure.</p> <p>NOTE: The clock selected must remain enabled if the LPTMR is to continue operating in all required low power modes.</p>
<p>TPIU</p>	
<p>SAI</p>	 <p>The BCLK can either be externally provided through BCLK pin or can be internally generated in internal bit clock mode using SAI internal divider by configuring SAI_n_RCR2[MSEL]/SAI_n_TCR2[MSEL] and SAI_n_RCR2[DIV]/SAI_n_TCR2[DIV].</p>

Table continues on the next page...

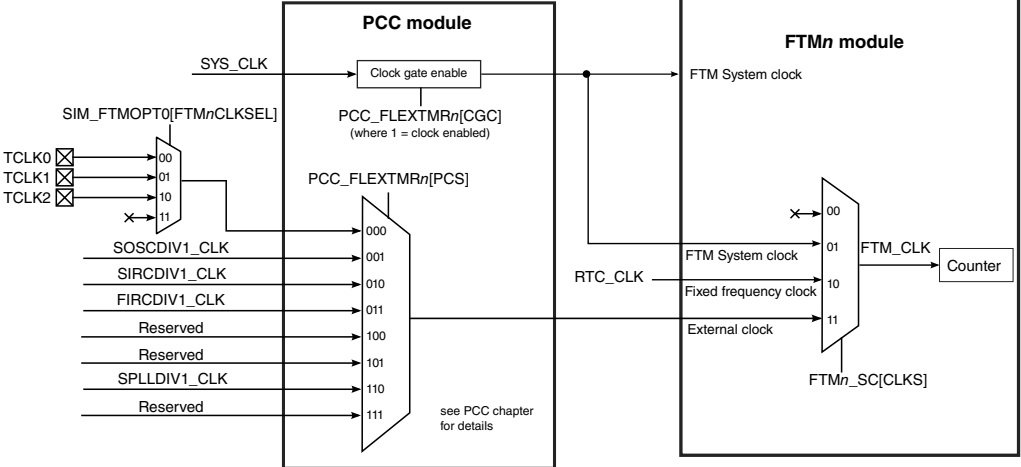
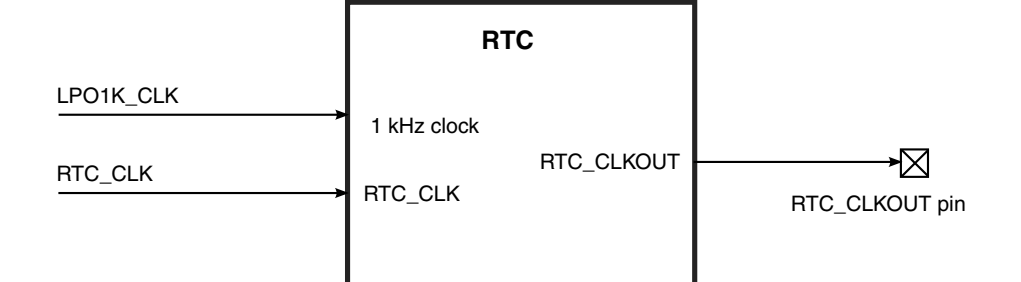
Table 27-9. Peripheral module clocking (continued)

Modules	PCC multiplexer															
	<p>NOTE: BCLK should never be greater than the Bus interface clock as it will lead to underrun or overflow of FIFO inside SAI.</p> <p style="text-align: center;">Table 27-10. Clocking option</p> <table border="1" data-bbox="435 348 1469 555"> <thead> <tr> <th>SAI instance</th> <th>MCLK source</th> <th>Description</th> </tr> </thead> <tbody> <tr> <td>SAI0</td> <td>SAIx_MCLK</td> <td>SAI0 MCLK</td> </tr> <tr> <td>SAI0</td> <td>SAIy_MCLK</td> <td>SAI1 MCLK</td> </tr> <tr> <td>SAI1</td> <td>SAIx_MCLK</td> <td>SAI1 MCLK</td> </tr> <tr> <td>SAI1</td> <td>SAIy_MCLK</td> <td>SAI0 MCLK</td> </tr> </tbody> </table> <p>1. For S32K14x and S32K11x variants 2. For S32K14xW variants</p>	SAI instance	MCLK source	Description	SAI0	SAIx_MCLK	SAI0 MCLK	SAI0	SAIy_MCLK	SAI1 MCLK	SAI1	SAIx_MCLK	SAI1 MCLK	SAI1	SAIy_MCLK	SAI0 MCLK
SAI instance	MCLK source	Description														
SAI0	SAIx_MCLK	SAI0 MCLK														
SAI0	SAIy_MCLK	SAI1 MCLK														
SAI1	SAIx_MCLK	SAI1 MCLK														
SAI1	SAIy_MCLK	SAI0 MCLK														
QuadSPI	 <p>NOTE:</p> <ol style="list-style-type: none"> 1. Clock gate enable: SIM_MISCTRL0[QSPI_CLK_SEL] 2. For programmable divider configuration, see QuadSPI_SOCCR[SOC CFG] implementation 															
ENET																

Table continues on the next page...

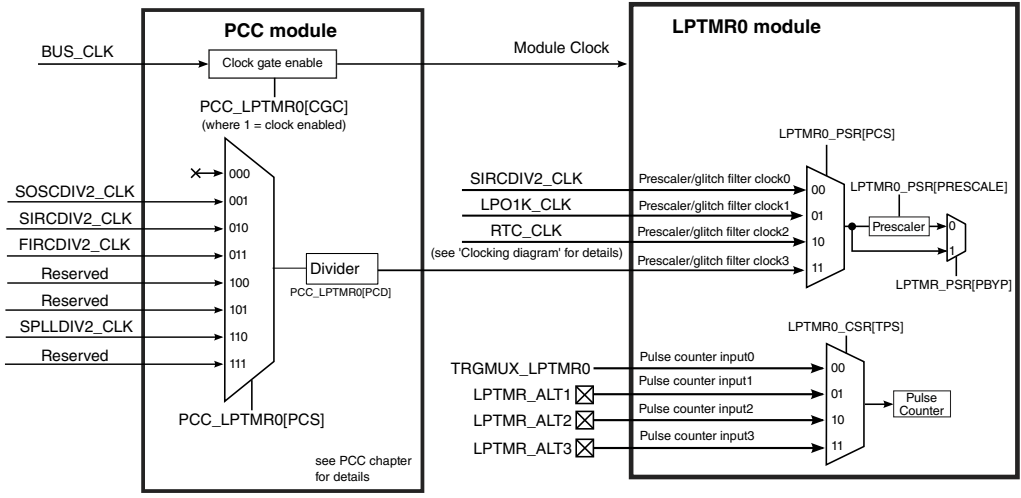
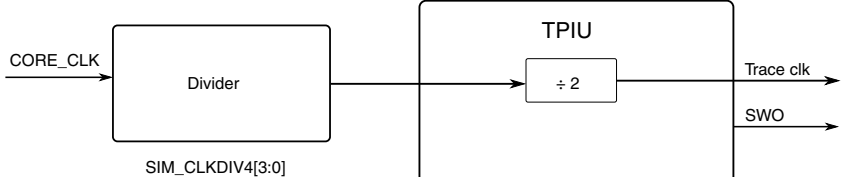
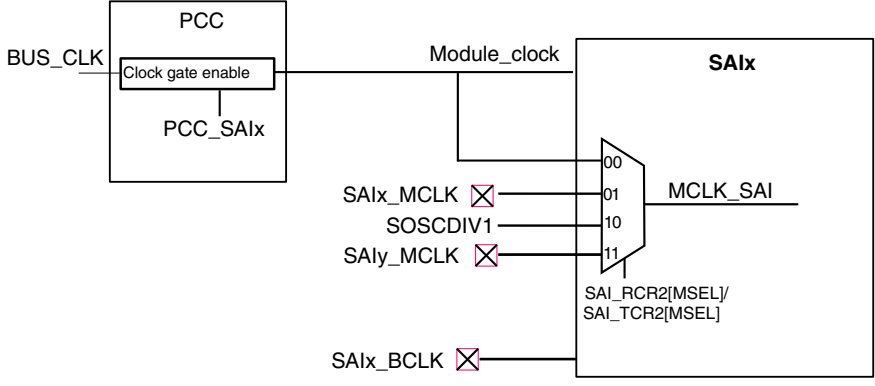
Table 27-9. Peripheral module clocking (continued)

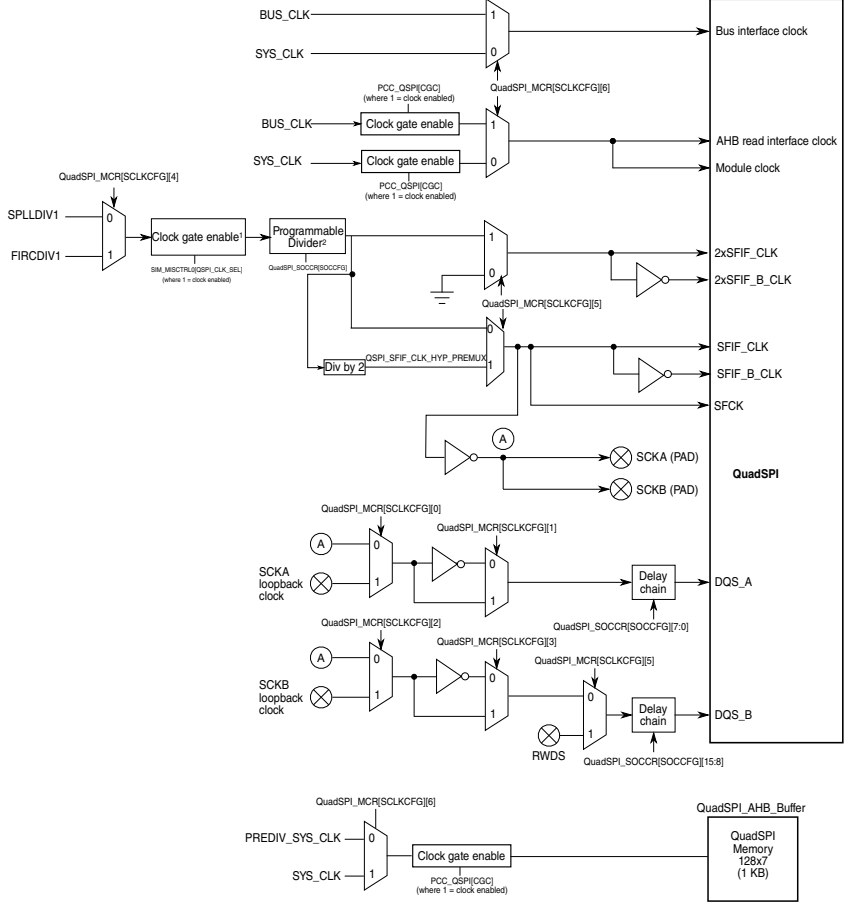
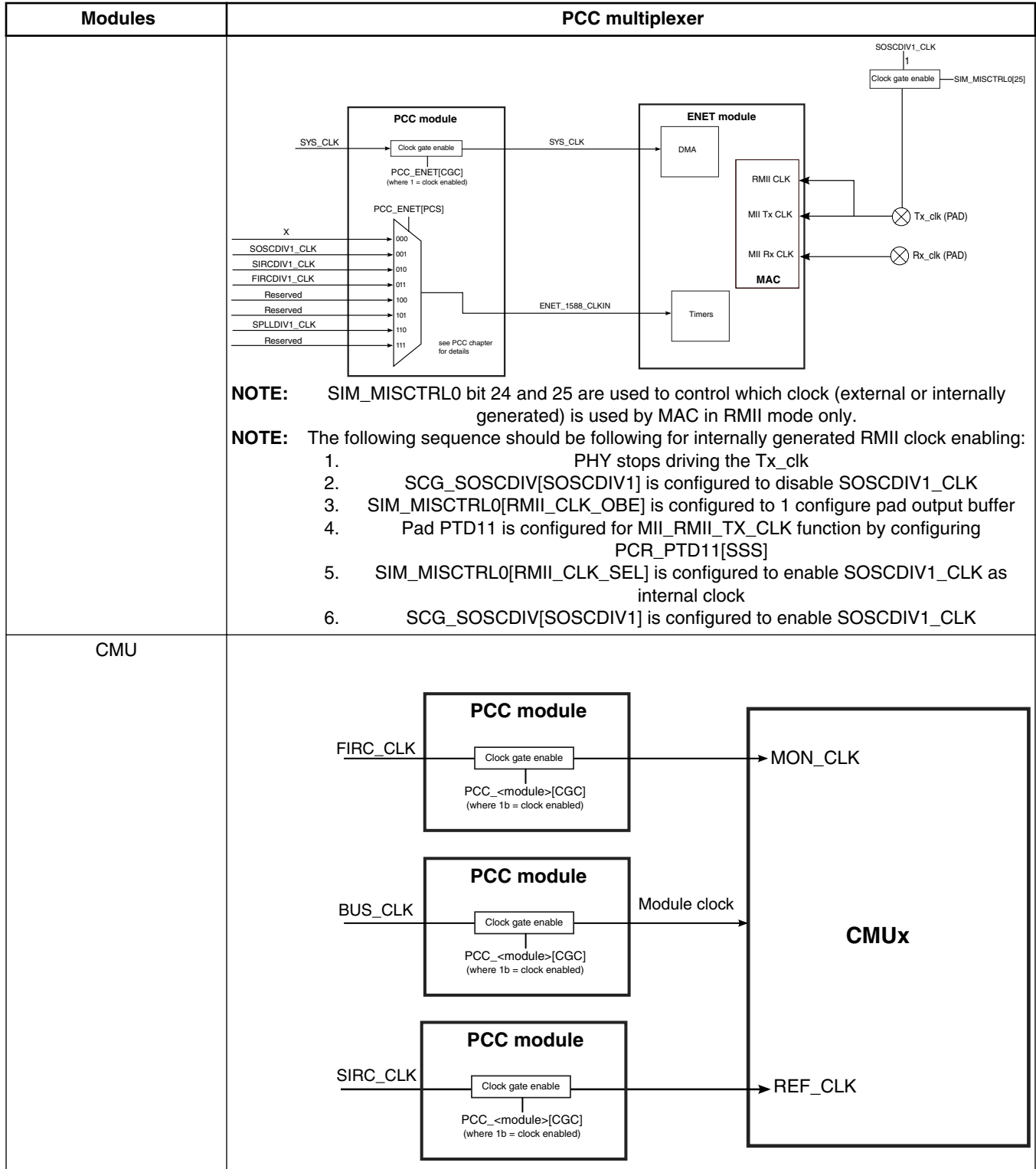

1. For S32K14x and S32K11x variants
2. For S32K14xW variants

NOTE

While changing peripheral clock source/divider configuration, the corresponding module should be disabled.

Chapter 28

System Clock Generator (SCG)

28.1 Chip-specific SCG information

Wait mode is not supported on this device. See [Module operation in available power modes](#) for details on available power modes.

NOTE

- SPLL mode is not available in S32K11x series of devices.
- HSRUN mode is not available in S32K14xW and S32K11x series of devices.
- SCG_SIRCCSR[SIRCLPEN] bit field is applicable for VLPS mode only.
- SCG_SIRCCSR[SIRCSTEN] bit field is not applicable and should be ignored.
- For S32K11x and S32K14xW series of devices only, writing to SCG_HCCR will give transfer error.
- For S32K14xW series of devices only, SPLLCFG[SOURCE] is configurable to support FIRC as reference for SPLL.

28.1.1 Register reset values

The reset values of some SCG registers vary across the products in the series. The following table shows these reset values for each product.

Table 28-1. SCG register reset values

Register	S32K116	S32K118	S32K142	S32K144	S32K144W	S32K146	S32K148
SCG_RCCR[DIVSLOW]	0001	0001	0001	0001	0010	0001	0001

28.1.2 Supported frequency ranges

This section describes the supported frequency ranges.

1. SCG_SOSCCFG[RANGE]

- 00 Reserved
- 01 Reserved
- 10 Medium frequency range selected for the crystal oscillator of 4 MHz to 8 MHz.
- 11 High frequency range selected for the crystal oscillator of 8 MHz to 40 MHz.

2. SCG_SIRCCFG[RANGE]

- 0 Reserved
- 1 Slow IRC high range clock (8 MHz)

28.1.3 Oscillator and SPLL guidelines

If the current system clock is SOSC, then following should be taken care by software before disabling SOSC:

- Configure all reset sources as 'Interrupt' (not as 'Reset') via RCM_SRIE
- The SOSC should be disabled via SCG_SOSCCSR[SOSCEN]
- After disabling SOSC, configure the reset source back to reset via RCM_SRIE
- When SPLL is enabled, both LOC and LOL must be configured as reset only (SOSCCSR[SOSCCMRE] and SPLLCSR[SPLLCMRE] must be 1 and RCM_SRIE[LOC], RCM_SRIE[LOL] must be 0). The only exception is during standard clock switching, in which case the 'clock switching sequence' protocol must be followed.

NOTE

If PLL is used, then oscillator needs to be in high range only, SCG_SOSCCFG[RANGE] on 11 as used in reference clock.

See note in section [IO Signal Table](#)

28.1.4 System clock switching

For any clock switching of system clock, follow the below steps:

- Before doing a clock switch, configure all reset sources to be 'Reset' (not as Interrupt) via RCM_SRIE.
- Program each reset source as Interrupt via RCM_SRIE for a minimum delay time of 10 LPO.
- Execute the clock switch

- Wait/Poll for the clock switch to complete
- Configure every reset source back to original intended reset configuration (Interrupt or Reset) via RCM_SRIE

NOTE

LOC flag would be raised when SOSC pulses are not detected for 8 to 16 clock cycles of SIRC/256. Hence, the LOC indication through reset to the system from the time when oscillator is cut off will vary from 256 μ s to 512 μ s.

28.1.5 System clock and clock monitor requirement

1. **System clock source SOSC/SPLL requirement:** Ensure below sequence is followed while switching system clock to SOSC/SPLL:
 - a. System clock source (SOSC/SPLL) is enabled
 - b. Clock monitors (SOSCCSR[SOSCCME] and SPLLCSR[SPLLCME]) and their corresponding reset event monitors (SOSCCSR[SOSCCMRE] and SPLLCSR[SPLLCMRE]) are enabled for SOSC/SPLL
 - c. SOSC/SPLL is selected as system clock source
2. **SOSC/SPLL clock monitor disable sequence requirement:** Ensure below sequence for disabling clock monitors while switching system clock source from SOSC/SPLL:
 - a. System clock source switched from SOSC/SPLL
 - b. Disable Clock monitors (SOSCCSR[SOSCCME] and SPLLCSR[SPLLCME]) and their corresponding reset event monitors (SOSCCSR[SOSCCMRE] and SPLLCSR[SPLLCMRE]) for SOSC/SPLL

It is imperative to follow the above guidelines to safeguard the device operation against loss of clock scenarios if system clock source malfunction due to any reason.

28.2 Introduction

The system clock generator (SCG) module provides the system clocks of the MCU. The SCG contains a system phase-locked loop (SPLL), a slow internal reference clock (SIRC), a fast internal reference clock (FIRC), and the system oscillator clock (SOSC). The SPLL is sourced by either the SOSC reference clock or the FIRC reference clock. The SCG can select either the output clock of the SPLL or a SCG reference clock (SIRC, FIRC, and SOSC) as the source for the MCU system clocks. The SCG also supports operation with crystal oscillators, which allows an external crystal, ceramic resonator, or another external clock source to produce the external reference clock (which are also available as clock sources for the MCU systems clocks).

28.2.1 Features

Key features of the SCG module are:

- System Phase-locked loop (SPLL):
 - Voltage-controlled oscillator (VCO)
 - Selectable Internal or External reference clock is used as the PLL source
 - Modulo VCO frequency divider
 - Phase/Frequency detector
 - Integrated loop filter
 - Can be selected as the clock source for the MCU system clocks
 - 2 programmable post-dividers clock outputs, which can be used as clock sources for other on-chip peripherals
- 2 Internal reference clock (IRC) generators:
 - Fast IRC clock with programmable High and Low frequency range
 - Fast clock can be used as a source for System PLL
 - Either the slow or the fast clock can be selected as the clock source for the MCU system clocks
 - 2 programmable post-divider clock outputs for each IRC, which can be used as clock sources for other on-chip peripherals
- System Crystal Oscillator:
 - Can be used as a source for the System PLL
 - Can be selected as the clock source for the MCU system clocks
- Clock monitor with reset and interrupt request capability for SPLL, SOSC, clocks
- Lock detector with interrupt request capability for use with the SPLL
- Each of the clock sources have reference dividers for clocking on-chip modules and peripherals, namely:
 - SPLLDIV1_CLK / SPLLDIV2_CLK
 - FIRCDIV1_CLK / SCG_FIRCDIV2_CLK

- SIRCDIV1_CLK / SIRCDIV2_CLK
- SOSCDIV1_CLK / SOSCDIV2_CLK

See the Clock Distribution Chapter for more information.

28.3 Memory Map/Register Definition

This section includes the memory map and register definition.

The SCG registers can only be written when in supervisor mode. Write accesses when in user mode will result in a bus transfer error. Read accesses may be performed in both supervisor and user mode.

NOTE

For any writable SCG registers, only 32-bit writes are allowed. 8-bit or 16-bit writes will result in transfer errors.

SCG memory map

Address offset (hex)	Register name	Width (in bits)	Access	Reset value	Section/page
0	Version ID Register (SCG_VERID)	32	R	0100_0000h	28.3.1/588
4	Parameter Register (SCG_PARAM)	32	R	See section	28.3.2/588
10	Clock Status Register (SCG_CSR)	32	R	See section	28.3.3/589
14	Run Clock Control Register (SCG_RCCR)	32	R/W	See section	28.3.4/592
18	VLPR Clock Control Register (SCG_VCCR)	32	R/W	See section	28.3.5/594
1C	HSRUN Clock Control Register (SCG_HCCR)	32	R/W	See section	28.3.6/596
20	SCG CLKOUT Configuration Register (SCG_CLKOUTCNFG)	32	R/W	0300_0000h	28.3.7/598
100	System OSC Control Status Register (SCG_SOSCCSR)	32	R/W	See section	28.3.8/600
104	System OSC Divide Register (SCG_SOSCDIV)	32	R/W	0000_0000h	28.3.9/602
108	System Oscillator Configuration Register (SCG_SOSCCFG)	32	R/W	0000_0010h	28.3.10/603
200	Slow IRC Control Status Register (SCG_SIRCCSR)	32	R/W	0100_0005h	28.3.11/604
204	Slow IRC Divide Register (SCG_SIRCDIV)	32	R/W	0000_0000h	28.3.12/605
208	Slow IRC Configuration Register (SCG_SIRCCFG)	32	R/W	0000_0001h	28.3.13/606
300	Fast IRC Control Status Register (SCG_FIRCCSR)	32	R/W	See section	28.3.14/607
304	Fast IRC Divide Register (SCG_FIRCDIV)	32	R/W	0000_0000h	28.3.15/609
308	Fast IRC Configuration Register (SCG_FIRCCFG)	32	R/W	0000_0000h	28.3.16/610

Table continues on the next page...

SCG memory map (continued)

Address offset (hex)	Register name	Width (in bits)	Access	Reset value	Section/page
600	System PLL Control Status Register (SCG_SPLLCSR)	32	R/W	0000_0000h	28.3.17/ 611
604	System PLL Divide Register (SCG_SPLLDIV)	32	R/W	0000_0000h	28.3.18/ 613
608	System PLL Configuration Register (SCG_SPLLCFG)	32	R/W	0000_0000h	28.3.19/ 613

28.3.1 Version ID Register (SCG_VERID)

Note: Writing to this register will result in a transfer error.

Address: 0h base + 0h offset = 0h

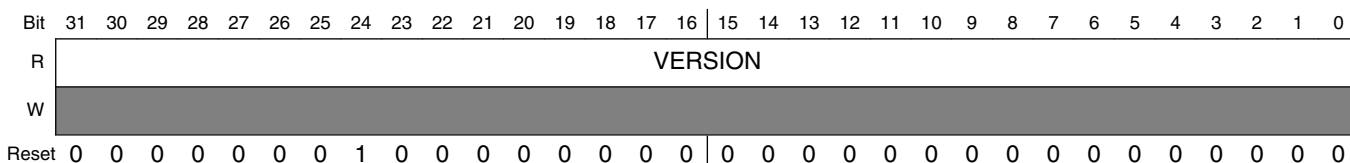

SCG_VERID field descriptions

Field	Description
VERSION	SCG Version Number

28.3.2 Parameter Register (SCG_PARAM)

Note: Writing to this register will result in a transfer error.

Address: 0h base + 4h offset = 4h

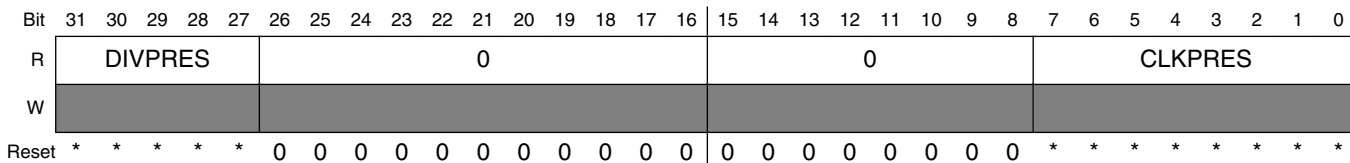

* Notes:

- DIVPRES field: The reset value is controlled by which SCG System Dividers are used by Soc.
- CLKPRES field: The reset value is controlled by which SCG Clock Sources are used by Soc. Please reference the Reference manual clocking chapter.

SCG_PARAM field descriptions

Field	Description
31–27 DIVPRES	Divider Present Indicates which system clock dividers are present in this instance of SCG. DIVPRES[27]=1 System DIVSLOW is present. DIVPRES[28]=1 System DIVBUS is present DIVPRES[29]=1 Reserved DIVPRES[30]=1 Reserved DIVPRES[31]=1 System DIVCORE is present
26–16 Reserved	This field is reserved. This read-only field is reserved and always has the value 0.
15–8 Reserved	This field is reserved. This read-only field is reserved and always has the value 0.
CLKPRES	Clock Present Indicates which clock sources are present in this instance of SCG. Any bits not defined in this bit field are Reserved and always has the value 0 when read. CLKPRES[0] Reserved CLKPRES[1]=1 System OSC (SOSC) is present CLKPRES[2]=1 Slow IRC (SIRC) is present CLKPRES[3]=1 Fast IRC (FIRC) is present CLKPRES[6]=1 System PLL (SPLL) is present

28.3.3 Clock Status Register (SCG_CSR)

This register returns the currently configured system clock source and the system clock dividers for the core (DIVCORE) and peripheral interface clock (DIVSLOW). The SCG_CSR reflects the configuration set by one of three clock control registers SCG_RCCR, SCG_VCCR, SCG_HCCR.

Note: Writing to this register will result in a transfer error.

Address: 0h base + 10h offset = 10h

Bit	31	30	29	28	27	26	25	24	23	22	21	20	19	18	17	16	15	14	13	12	11	10	9	8	7	6	5	4	3	2	1	0			
R	0		SCS				0				DIVCORE				0		0		DIVBUS				DIVSLOW												
W	0																																		
Reset	0	0	0	0	0	0	0	1	1	0	0	0	0	*	*	*	*	0	0	0	0	0	0	0	0	0	0	0	0	0	0	0	0	0	1

* Notes:

- DIVCORE field: The reset value is controlled by user FOPT bits that get uploaded during reset. The valid reset values are div-by-1 or div-by-2 when resetting into RUN mode or div-by-4 or div-by-8 when resetting into VLPR mode.

SCG_CSR field descriptions

Field	Description
31–28 Reserved	This field is reserved. This read-only field is reserved and always has the value 0.
27–24 SCS	System Clock Source Returns the currently configured clock source generating the system clock. 0000 Reserved 0001 System OSC (SOSC_CLK) 0010 Slow IRC (SIRC_CLK) 0011 Fast IRC (FIRC_CLK) 0100 0101 Reserved 0110 System PLL (SPLL_CLK) 0111 Reserved
23–20 Reserved	This field is reserved. This read-only field is reserved and always has the value 0.
19–16 DIVCORE	Core Clock Divide Ratio If SPLL is selected as system clock source, the maximum DIVCORE value is Divide-by-4. 0000 Divide-by-1 0001 Divide-by-2 0010 Divide-by-3 0011 Divide-by-4 0100 Divide-by-5 0101 Divide-by-6 0110 Divide-by-7 0111 Divide-by-8 1000 Divide-by-9 1001 Divide-by-10 1010 Divide-by-11 1011 Divide-by-12 1100 Divide-by-13 1101 Divide-by-14 1110 Divide-by-15 1111 Divide-by-16
15–12 Reserved	This field is reserved. This read-only field is reserved and always has the value 0.
11–8 Reserved	This field is reserved. This read-only field is reserved and always has the value 0.
7–4 DIVBUS	Bus Clock Divide Ratio 0000 Divide-by-1 0001 Divide-by-2 0010 Divide-by-3 0011 Divide-by-4 0100 Divide-by-5 0101 Divide-by-6

Table continues on the next page...

SCG_CSR field descriptions (continued)

Field	Description
	0110 Divide-by-7 0111 Divide-by-8 1000 Divide-by-9 1001 Divide-by-10 1010 Divide-by-11 1011 Divide-by-12 1100 Divide-by-13 1101 Divide-by-14 1110 Divide-by-15 1111 Divide-by-16
DIVSLOW	Slow Clock Divide Ratio 0000 Divide-by-1 0001 Divide-by-2 0010 Divide-by-3 0011 Divide-by-4 0100 Divide-by-5 0101 Divide-by-6 0110 Divide-by-7 0111 Divide-by-8 1000 Reserved 1001 Reserved 1010 Reserved 1011 Reserved 1100 Reserved 1101 Reserved 1110 Reserved 1111 Reserved

28.3.4 Run Clock Control Register (SCG_RCCR)

This register controls the system clock source and the system clock dividers for the core, platform, external and bus clock domains when in Run mode only. This register can only be written using a 32-bit write. Selecting a different clock source when in RUN requires that clock source to be enabled first and be valid before system clocks switch to that clock source. If system clock divide ratios also change when selecting a different clock mode when in RUN, new system clock divide ratios will not take affect until new clock source is valid.

Address: 0h base + 14h offset = 14h

Bit	31	30	29	28	27	26	25	24	23	22	21	20	19	18	17	16	15	14	13	12	11	10	9	8	7	6	5	4	3	2	1	0				
R	0				SCS				0				DIVCORE				Reserved				0				DIVBUS				DIVSLOW							
W	0				0				0				0				0				0				0											
Reset	0	0	0	0	0	0	1	1	0	0	0	0	*	*	*	*	0	0	0	0	0	0	0	0	0	0	0	0	0	0	0	0	0	0	0	1

* Notes:

- DIVCORE field: The reset value is controlled by user FOPT bits that get uploaded during reset. The two valid reset values are div-by-1 and div-by-2

SCG_RCCR field descriptions

Field	Description
31–28 Reserved	This field is reserved. This read-only field is reserved and always has the value 0.
27–24 SCS	System Clock Source Selects the clock source generating the system clock in Run mode. Attempting to select a clock that is not valid will be ignored. Selecting a different clock source when in Run mode requires that clock source to be enabled first and be valid before system clocks are allowed to switch to that clock source. 0000 Reserved 0001 System OSC (SOSC_CLK) 0010 Slow IRC (SIRC_CLK) 0011 Fast IRC (FIRC_CLK) 0100 0101 Reserved 0110 System PLL (SPLL_CLK) 0111 Reserved
23–20 Reserved	This field is reserved. This read-only field is reserved and always has the value 0.
19–16 DIVCORE	Core Clock Divide Ratio 0000 Divide-by-1 0001 Divide-by-2 0010 Divide-by-3 0011 Divide-by-4

Table continues on the next page...

SCG_RCCR field descriptions (continued)

Field	Description
	0100 Divide-by-5 0101 Divide-by-6 0110 Divide-by-7 0111 Divide-by-8 1000 Divide-by-9 1001 Divide-by-10 1010 Divide-by-11 1011 Divide-by-12 1100 Divide-by-13 1101 Divide-by-14 1110 Divide-by-15 1111 Divide-by-16
15–12 Reserved	This field is reserved. Software should write 0 to these bits to maintain compatibility. This field is reserved.
11–8 Reserved	This field is reserved. This read-only field is reserved and always has the value 0.
7–4 DIVBUS	Bus Clock Divide Ratio 0000 Divide-by-1 0001 Divide-by-2 0010 Divide-by-3 0011 Divide-by-4 0100 Divide-by-5 0101 Divide-by-6 0110 Divide-by-7 0111 Divide-by-8 1000 Divide-by-9 1001 Divide-by-10 1010 Divide-by-11 1011 Divide-by-12 1100 Divide-by-13 1101 Divide-by-14 1110 Divide-by-15 1111 Divide-by-16
DIVSLOW	Slow Clock Divide Ratio 0000 Divide-by-1 0001 Divide-by-2 0010 Divide-by-3 0011 Divide-by-4 0100 Divide-by-5 0101 Divide-by-6 0110 Divide-by-7 0111 Divide-by-8 1000 Reserved 1001 Reserved

Table continues on the next page...

SCG_RCCR field descriptions (continued)

Field	Description
1010	Reserved
1011	Reserved
1100	Reserved
1101	Reserved
1110	Reserved
1111	Reserved

28.3.5 VLPR Clock Control Register (SCG_VCCR)

This register controls the system clock source and the system clock dividers for the core, platform, external and bus clock domains when in VLPR mode only. This register can only be written using a 32-bit write. Selecting a different clock source when in VLPR requires that clock source to be enabled first and be valid before system clocks switch to that clock source. If system clock divide ratios also change when selecting a different clock mode when in VLPR, new system clock divide ratios will not take affect until new clock source is valid.

Address: 0h base + 18h offset = 18h

Bit	31	30	29	28	27	26	25	24	23	22	21	20	19	18	17	16	15	14	13	12	11	10	9	8	7	6	5	4	3	2	1	0				
R	0				SCS				0				DIVCORE				Reserved				0				DIVBUS				DIVSLOW							
W	0				0				0				0				0				0				0											
Reset	0	0	0	0	0	0	1	0	0	0	0	0	*	*	*	*	0	0	0	0	0	0	0	0	0	0	0	0	0	0	0	0	0	0	0	1

* Notes:

- DIVCORE field: The reset value is controlled by user FOPT bits that get uploaded during reset. The two option reset values are div-by-4 and div-by-8.

SCG_VCCR field descriptions

Field	Description
31–28 Reserved	This field is reserved. This read-only field is reserved and always has the value 0.
27–24 SCS	System Clock Source Selects the clock source generating the system clock in VLPR mode. Attempting to select a clock that is not valid will be ignored. Selects the clock source generating the system clock. Selecting a different clock source when in VLPR mode requires that clock source to be enabled first and be valid before system clocks switch to that clock source. 0000 Reserved 0001 Reserved 0010 Slow IRC (SIRC_CLK) 0011 Reserved 0100

Table continues on the next page...

SCG_VCCR field descriptions (continued)

Field	Description
	0101 Reserved 0110 Reserved 0111 Reserved
23–20 Reserved	This field is reserved. This read-only field is reserved and always has the value 0.
19–16 DIVCORE	Core Clock Divide Ratio 0000 Divide-by-1 0001 Divide-by-2 0010 Divide-by-3 0011 Divide-by-4 0100 Divide-by-5 0101 Divide-by-6 0110 Divide-by-7 0111 Divide-by-8 1000 Divide-by-9 1001 Divide-by-10 1010 Divide-by-11 1011 Divide-by-12 1100 Divide-by-13 1101 Divide-by-14 1110 Divide-by-15 1111 Divide-by-16
15–12 Reserved	This field is reserved. Software should write 0 to these bits to maintain compatibility. This field is reserved.
11–8 Reserved	This field is reserved. This read-only field is reserved and always has the value 0.
7–4 DIVBUS	Bus Clock Divide Ratio 0000 Divide-by-1 0001 Divide-by-2 0010 Divide-by-3 0011 Divide-by-4 0100 Divide-by-5 0101 Divide-by-6 0110 Divide-by-7 0111 Divide-by-8 1000 Divide-by-9 1001 Divide-by-10 1010 Divide-by-11 1011 Divide-by-12 1100 Divide-by-13 1101 Divide-by-14 1110 Divide-by-15 1111 Divide-by-16
DIVSLOW	Slow Clock Divide Ratio

Table continues on the next page...

SCG_VCCR field descriptions (continued)

Field	Description
0000	Divide-by-1
0001	Divide-by-2
0010	Divide-by-3
0011	Divide-by-4
0100	Divide-by-5
0101	Divide-by-6
0110	Divide-by-7
0111	Divide-by-8
1000	Reserved
1001	Reserved
1010	Reserved
1011	Reserved
1100	Reserved
1101	Reserved
1110	Reserved
1111	Reserved

28.3.6 HSRUN Clock Control Register (SCG_HCCR)

This register controls the system clock source and the system clock dividers for the core, platform, external and bus clock domains when in HSRUN mode only. This register can only be written using a 32-bit write. Selecting a different clock source when in HSRUN requires that clock source to be enabled first and be valid before system clocks switch to that clock source. If system clock divide ratios also change when selecting a different clock mode when in HSRUN, new system clock divide ratios will not take affect until new clock source is valid.

Address: 0h base + 1Ch offset = 1Ch

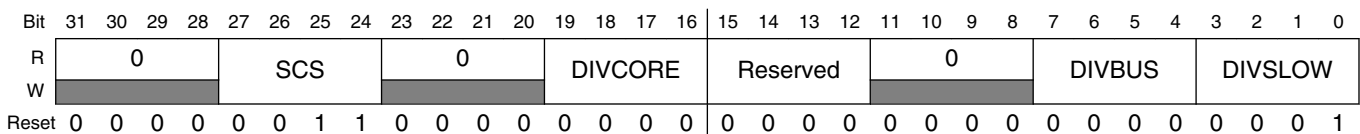

SCG_HCCR field descriptions

Field	Description
31–28 Reserved	This field is reserved. This read-only field is reserved and always has the value 0.
27–24 SCS	System Clock Source Selects the clock source generating the system clock in HSRUN mode. Attempting to select a clock that is not valid will be ignored. Selecting a different clock source when in HSRUN mode will enable that clock source and switch to that clock mode when it is valid.

Table continues on the next page...

SCG_HCCR field descriptions (continued)

Field	Description
	0000 Reserved 0001 Reserved 0010 Reserved 0011 Fast IRC (FIRC_CLK) 0100 0101 Reserved 0110 System PLL (SPLL_CLK) 0111 Reserved
23–20 Reserved	This field is reserved. This read-only field is reserved and always has the value 0.
19–16 DIVCORE	Core Clock Divide Ratio 0000 Divide-by-1 0001 Divide-by-2 0010 Divide-by-3 0011 Divide-by-4 0100 Divide-by-5 0101 Divide-by-6 0110 Divide-by-7 0111 Divide-by-8 1000 Divide-by-9 1001 Divide-by-10 1010 Divide-by-11 1011 Divide-by-12 1100 Divide-by-13 1101 Divide-by-14 1110 Divide-by-15 1111 Divide-by-16
15–12 Reserved	This field is reserved. Software should write 0 to these bits to maintain compatibility. This field is reserved.
11–8 Reserved	This field is reserved. This read-only field is reserved and always has the value 0.
7–4 DIVBUS	Bus Clock Divide Ratio 0000 Divide-by-1 0001 Divide-by-2 0010 Divide-by-3 0011 Divide-by-4 0100 Divide-by-5 0101 Divide-by-6 0110 Divide-by-7 0111 Divide-by-8 1000 Divide-by-9 1001 Divide-by-10 1010 Divide-by-11 1011 Divide-by-12

Table continues on the next page...

SCG_HCCR field descriptions (continued)

Field	Description
	1100 Divide-by-13 1101 Divide-by-14 1110 Divide-by-15 1111 Divide-by-16
DIVSLOW	Slow Clock Divide Ratio 0000 Divide-by-1 0001 Divide-by-2 0010 Divide-by-3 0011 Divide-by-4 0100 Divide-by-5 0101 Divide-by-6 0110 Divide-by-7 0111 Divide-by-8 1000 Reserved 1001 Reserved 1010 Reserved 1011 Reserved 1100 Reserved 1101 Reserved 1110 Reserved 1111 Reserved

28.3.7 SCG CLKOUT Configuration Register (SCG_CLKOUTCNFG)

This register controls which SCG clock source is selected to be ported out to the CLKOUT pin.

Address: 0h base + 20h offset = 20h

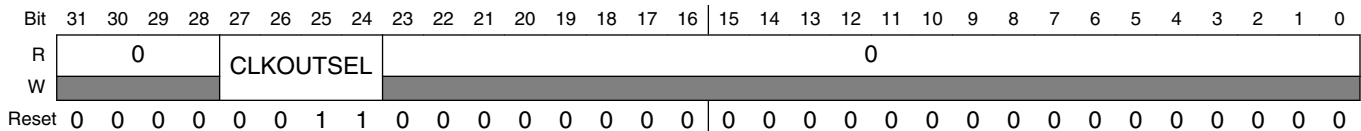

SCG_CLKOUTCNFG field descriptions

Field	Description
31–28 Reserved	This field is reserved. This read-only field is reserved and always has the value 0.
27–24 CLKOUTSEL	SCG Clkout Select Selects the SCG system clock. 0000 SCG SLOW Clock 0001 System OSC (SOSC_CLK)

Table continues on the next page...

SCG_CLKOUTCNFG field descriptions (continued)

Field	Description
	0010 Slow IRC (SIRC_CLK) 0011 Fast IRC (FIRC_CLK) 0100 0101 Reserved 0110 System PLL (SPLL_CLK) 0111 Reserved 1111 Reserved
Reserved	This field is reserved. This read-only field is reserved and always has the value 0.

28.3.8 System OSC Control Status Register (SCG_SOSCCSR)

Address: 0h base + 100h offset = 100h

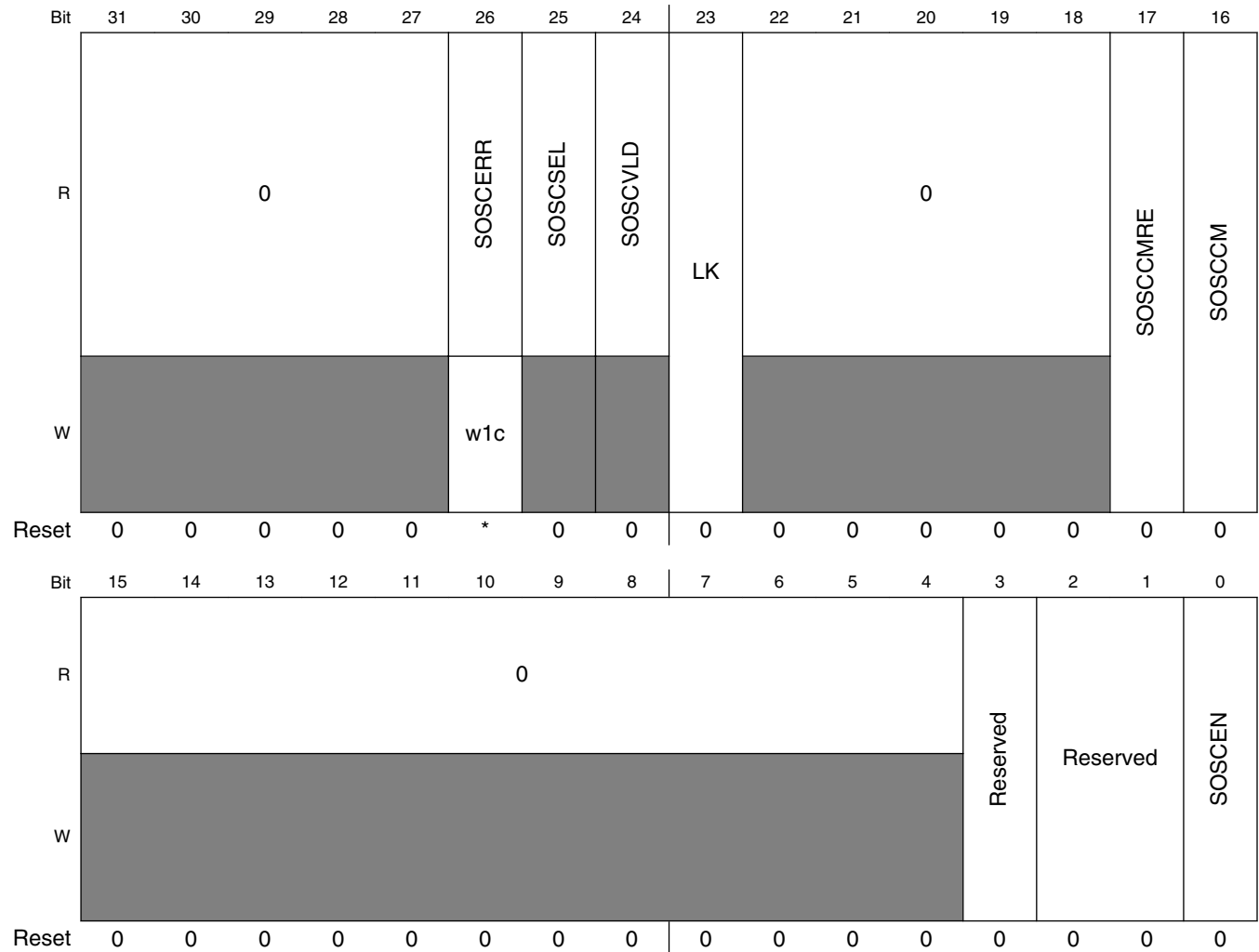

* Notes:

- SOSCERR field: This flag is reset on Chip POR only

SCG_SOSCCSR field descriptions

Field	Description
31–27 Reserved	This field is reserved. This read-only field is reserved and always has the value 0.
26 SOSCERR	System OSC Clock Error This flag is reset on Chip POR only, software can also clear this flag by writing a logic one. 0 System OSC Clock Monitor is disabled or has not detected an error 1 System OSC Clock Monitor is enabled and detected an error

Table continues on the next page...

SCG_SOSCCSR field descriptions (continued)

Field	Description
25 SOSCSEL	System OSC Selected 0 System OSC is not the system clock source 1 System OSC is the system clock source
24 SOSCVLD	System OSC Valid The SOSC is considered valid after 4096 xtal counts. 0 System OSC is not enabled or clock is not valid 1 System OSC is enabled and output clock is valid
23 LK	Lock Register This bit field can be cleared/set at any time. 0 This Control Status Register can be written. 1 This Control Status Register cannot be written.
22–18 Reserved	This field is reserved. This read-only field is reserved and always has the value 0.
17 SOSCCMRE	System OSC Clock Monitor Reset Enable 0 Clock Monitor generates interrupt when error detected 1 Clock Monitor generates reset when error detected
16 SOSCCM	System OSC Clock Monitor Enables the clock monitor when SOSCVLD is set. If the clock source is disabled in a low power mode then the clock monitor is also disabled in the low power mode. When the clock monitor is disabled in a low power mode, it remains disabled until the clock valid flag is set following exit from the low power mode. 0 System OSC Clock Monitor is disabled 1 System OSC Clock Monitor is enabled
15–4 Reserved	This field is reserved. This read-only field is reserved and always has the value 0.
3 Reserved	This field is reserved. This field is reserved. Software should write 0 to these bits to maintain compatibility.
2–1 Reserved	This field is reserved. This field is reserved. Software should write 0 to these bits to maintain compatibility.
0 SOSCEN	System OSC Enable If this bit written during clock switching, it should be read back and confirmed before proceeding. 0 System OSC is disabled 1 System OSC is enabled

28.3.9 System OSC Divide Register (SCG_SOSCDIV)

The SCG_SOSCDIV register provides the control of clock trees which can be used to provide optional peripheral functional clocks, or alternative module clocks. Each clock tree has optional dividers of the input SOSC clock. Changes to SOSCDIV should be done when System OSC is disabled to prevent glitches to output divided clock.

Address: 0h base + 104h offset = 104h

Bit	31	30	29	28	27	26	25	24	23	22	21	20	19	18	17	16
R	0													Reserved		
W	[Shaded]															
Reset	0	0	0	0	0	0	0	0	0	0	0	0	0	0	0	0
Bit	15	14	13	12	11	10	9	8	7	6	5	4	3	2	1	0
R	0					SOSCDIV2			0							
W	[Shaded]								[Shaded]							
Reset	0	0	0	0	0	0	0	0	0	0	0	0	0			

SCG_SOSCDIV field descriptions

Field	Description
31–19 Reserved	This field is reserved. This read-only field is reserved and always has the value 0.
18–16 Reserved	This field is reserved. This bit field is reserved. Software should write 0 to this bit field to maintain compatibility.
15–11 Reserved	This field is reserved. This read-only field is reserved and always has the value 0.
10–8 SOSCDIV2	System OSC Clock Divide 2 Clock divider 2 for System OSC. Used by modules that need an asynchronous clock source. 000 Output disabled 001 Divide by 1 010 Divide by 2 011 Divide by 4 100 Divide by 8 101 Divide by 16 110 Divide by 32 111 Divide by 64
7–3 Reserved	This field is reserved. This read-only field is reserved and always has the value 0.

28.3.10 System Oscillator Configuration Register (SCG_SOSCCFG)

The SOSCCFG register cannot be changed when the System OSC is enabled. When the System OSC is enabled, writes to this register are ignored, and there is no transfer error.

Address: 0h base + 108h offset = 108h

Bit	31	30	29	28	27	26	25	24		23	22	21	20	19	18	17	16
R	0																
W	[Shaded]																
Reset	0	0	0	0	0	0	0	0		0	0	0	0	0	0	0	0
Bit	15	14	13	12	11	10	9	8		7	6	5	4	3	2	1	0
R	0				Reserved				0		RANGE		HGO	EREFS	0		
W	[Shaded]				[Shaded]				[Shaded]		[Shaded]		[Shaded]	[Shaded]	[Shaded]		
Reset	0	0	0	0	0	0	0	0		0	0	0	1	0	0	0	0

SCG_SOSCCFG field descriptions

Field	Description
31–12 Reserved	This field is reserved. This read-only field is reserved and always has the value 0.
11–8 Reserved	This field is reserved. This bit is reserved. Software should write 0 to this bit field.
7–6 Reserved	This field is reserved. This read-only field is reserved and always has the value 0.
5–4 RANGE	System OSC Range Select Selects the frequency range for the system crystal oscillator (OSC) See chip-specific information for supported crystal oscillator ranges. 00 Reserved 01 Low frequency range selected for the crystal oscillator 10 Medium frequency range selected for the crystal oscillator 11 High frequency range selected for the crystal oscillator
3 HGO	High Gain Oscillator Select Controls the crystal oscillator power mode of operations. 0 Configure crystal oscillator for low-gain operation 1 Configure crystal oscillator for high-gain operation
2 EREFS	External Reference Select Selects the source for the external reference clock. This bit selects which clock is output from the System OSC (SOSC) into the SCG, thus either the crystal oscillator or from an external clock input

Table continues on the next page...

SCG_SOSCCFG field descriptions (continued)

Field	Description
	0 External reference clock selected 1 Internal crystal oscillator of OSC selected.
Reserved	This field is reserved. This read-only field is reserved and always has the value 0.

28.3.11 Slow IRC Control Status Register (SCG_SIRCCSR)

Address: 0h base + 200h offset = 200h

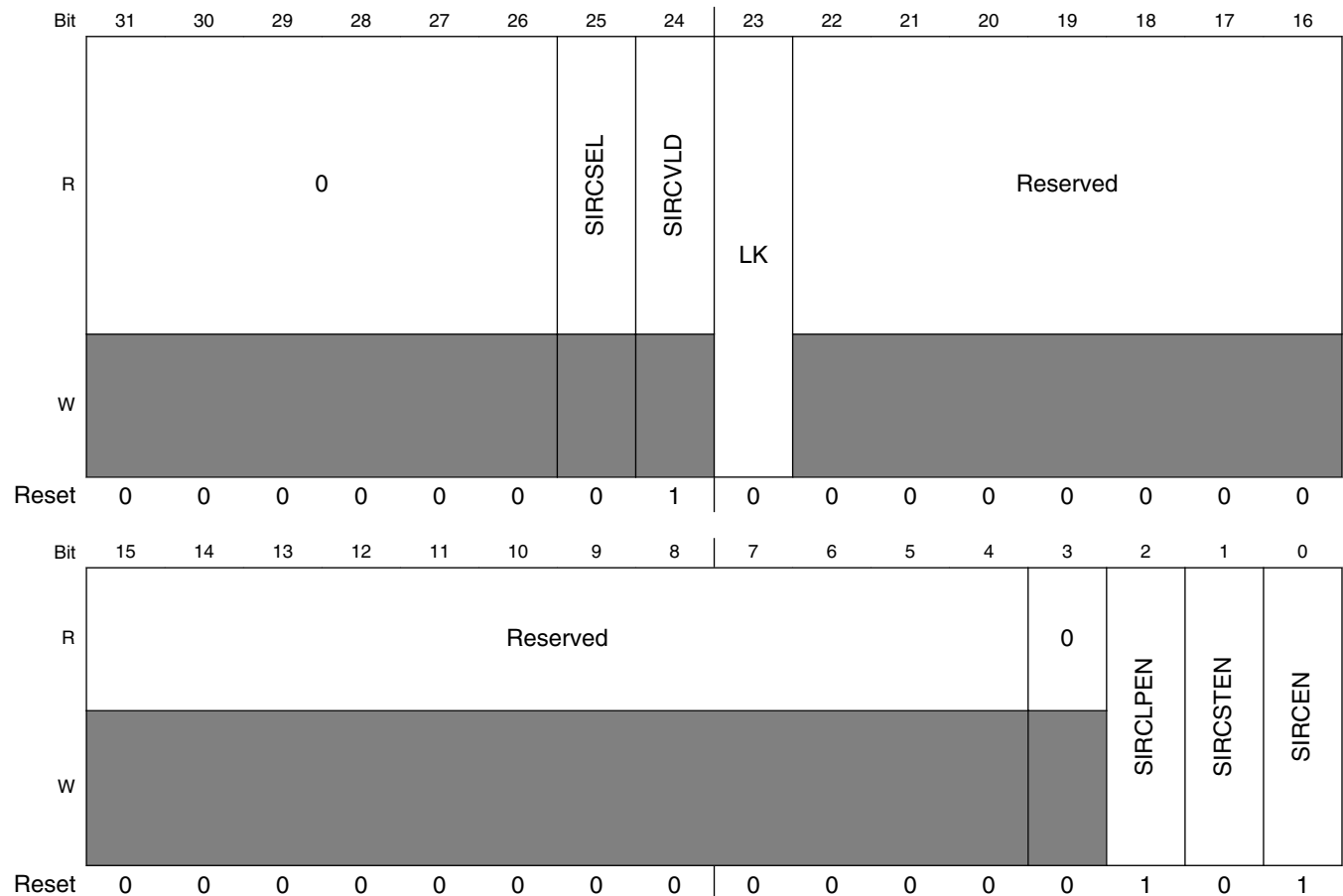

SCG_SIRCCSR field descriptions

Field	Description
31–26 Reserved	This field is reserved. This read-only field is reserved and always has the value 0.
25 SIRCSEL	Slow IRC Selected 0 Slow IRC is not the system clock source 1 Slow IRC is the system clock source

Table continues on the next page...

SCG_SIRCCSR field descriptions (continued)

Field	Description
24 SIRCVLD	Slow IRC Valid 0 Slow IRC is not enabled or clock is not valid 1 Slow IRC is enabled and output clock is valid
23 LK	Lock Register This bit field can be cleared/set at any time. 0 Control Status Register can be written. 1 Control Status Register cannot be written.
22–4 Reserved	This field is reserved and is always has the value 0 This field is reserved.
3 Reserved	This field is reserved and is always has the value 0 This field is reserved. This read-only field is reserved and always has the value 0.
2 SIRCLPEN	Slow IRC Low Power Enable 0 Slow IRC is disabled in VLP modes 1 Slow IRC is enabled in VLP modes
1 SIRCSTEN	Slow IRC Stop Enable 0 Slow IRC is disabled in supported Stop modes 1 Slow IRC is enabled in supported Stop modes
0 SIRCEN	Slow IRC Enable If this bit written during clock switching, it should be read back and confirmed before proceeding. 0 Slow IRC is disabled 1 Slow IRC is enabled

28.3.12 Slow IRC Divide Register (SCG_SIRCDIV)

To prevent glitches to the output divided clock, change SIRDIV when the Slow IRC is disabled.

Address: 0h base + 204h offset = 204h

Bit	31	30	29	28	27	26	25	24	23	22	21	20	19	18	17	16	15	14	13	12	11	10	9	8	7	6	5	4	3	2	1	0
R	0													Reserved			0			SIRCDIV		0										
W	0													0			2		0													
Reset	0	0	0	0	0	0	0	0	0	0	0	0	0	0	0	0	0	0	0	0	0	0	0	0	0	0	0	0	0	0	0	

SCG_SIRCDIV field descriptions

Field	Description
31–19 Reserved	This field is reserved. This read-only field is reserved and always has the value 0.
18–16 Reserved	This field is reserved. This bit field is reserved. Software should write 0 to this bit field to maintain compatibility.
15–11 Reserved	This field is reserved. This read-only field is reserved and always has the value 0.
10–8 SIRCDIV2	Slow IRC Clock Divide 2 Clock divider 2 for Slow IRC. Used by modules that need an asynchronous clock source. 000 Output disabled 001 Divide by 1 010 Divide by 2 011 Divide by 4 100 Divide by 8 101 Divide by 16 110 Divide by 32 111 Divide by 64
7–3 Reserved	This field is reserved. This read-only field is reserved and always has the value 0.

28.3.13 Slow IRC Configuration Register (SCG_SIRCCFG)

The SIRCCFG register cannot be changed when the slow IRC clock is enabled. When the slow IRC clock is enabled, writes to this register are ignored, and there is no transfer error.

Address: 0h base + 208h offset = 208h

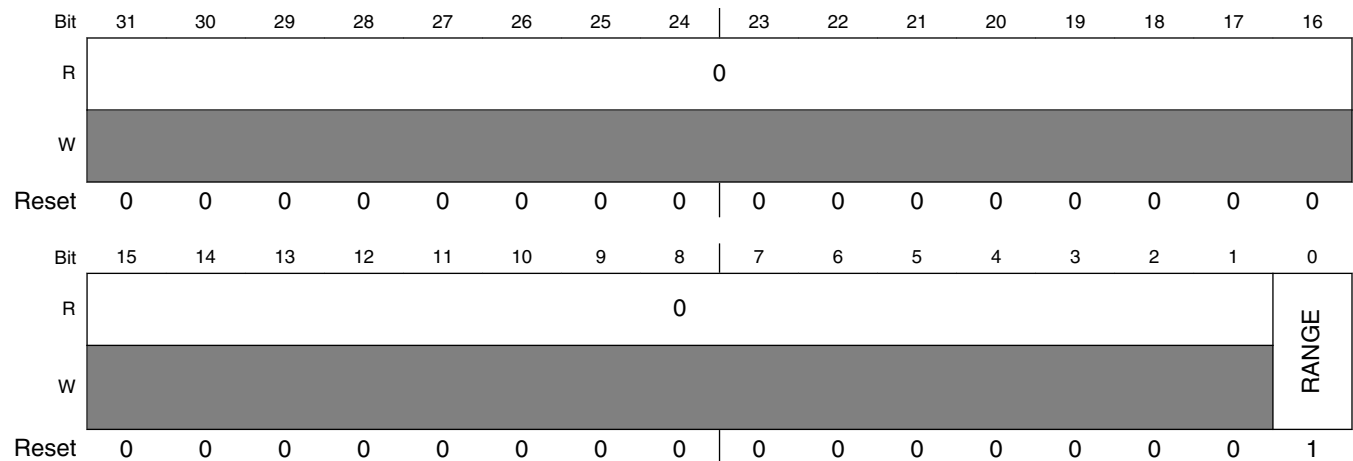

SCG_SIRCCFG field descriptions

Field	Description
31–1 Reserved	This field is reserved. This read-only field is reserved and always has the value 0.
0 RANGE	Frequency Range See chip-specific information for supported frequency ranges. 0 Slow IRC low range clock (2 MHz) 1 Slow IRC high range clock (8 MHz)

28.3.14 Fast IRC Control Status Register (SCG_FIRCCSR)

Address: 0h base + 300h offset = 300h

Bit	31	30	29	28	27	26	25	24	23	22	21	20	19	18	17	16
R	0						0	FIRCSEL	FIRCVLD	LK	0					
W	Shaded						Shaded	Shaded	Shaded	Shaded	Shaded					
Reset	0	0	0	0	0	0	1	1	0	0	0	0	0	0	0	0
Bit	15	14	13	12	11	10	9	8	7	6	5	4	3	2	1	0
R	0						Reserved		0				FIRCREGOFF	Reserved		FIRCEN
W	Shaded						Reserved		Shaded				FIRCREGOFF	Reserved		FIRCEN
Reset	0	0	0	0	0	0	0	0	0	0	0	0	0	0	0	1

SCG_FIRCCSR field descriptions

Field	Description
31–27 Reserved	This field is reserved. This read-only field is reserved and always has the value 0.
26 Reserved	This field is reserved. This read-only field is reserved and always has the value 0.
25 FIRCSEL	Fast IRC Selected status 0 Fast IRC is not the system clock source 1 Fast IRC is the system clock source
24 FIRCVLD	Fast IRC Valid status 0 Fast IRC is not enabled or clock is not valid. 1 Fast IRC is enabled and output clock is valid. The clock is valid once there is an output clock from the FIRC analog.
23 LK	Lock Register This bit field can be cleared/set at any time. 0 Control Status Register can be written. 1 Control Status Register cannot be written.
22–10 Reserved	This field is reserved. This read-only field is reserved and always has the value 0.
9–8 Reserved	This field is reserved. This field is reserved. Software should write 0 to these bits to maintain compatibility.
7–4 Reserved	This field is reserved. This read-only field is reserved and always has the value 0.
3 FIRCREGOFF	Fast IRC Regulator Enable NOTE: When Fast IRC is used, FIRCREGOFF must be 0. Fast IRC cannot be operated with FIRCREGOFF=1. 0 Fast IRC Regulator is enabled. 1 Fast IRC Regulator is disabled.
2–1 Reserved	This field is reserved. Software should write 0 to these bits to maintain compatibility. This field is reserved.
0 FIRCEN	Fast IRC Enable If this bit written during clock switching, it should be read back and confirmed before proceeding. 0 Fast IRC is disabled 1 Fast IRC is enabled

28.3.15 Fast IRC Divide Register (SCG_FIRCDIV)

Changes to FIRCDIV should be done when FAST IRC is disabled to prevent glitches to output divided clock.

Address: 0h base + 304h offset = 304h

Bit	31	30	29	28	27	26	25	24	23	22	21	20	19	18	17	16	15	14	13	12	11	10	9	8	7	6	5	4	3	2	1	0
R	0													Reserved			0			FIRCDIV2			0									
W	0													0			0			0			0				0					
Reset	0	0	0	0	0	0	0	0	0	0	0	0	0	0	0	0	0	0	0	0	0	0	0	0	0	0	0	0	0	0	0	0

SCG_FIRCDIV field descriptions

Field	Description
31–19 Reserved	This field is reserved. This read-only field is reserved and always has the value 0.
18–16 Reserved	This field is reserved. This bit field is reserved. Software should write 0 to this bit field to maintain compatibility.
15–11 Reserved	This field is reserved. This read-only field is reserved and always has the value 0.
10–8 FIRCDIV2	Fast IRC Clock Divide 2 Clock divider 2 for the Fast IRC. Used by modules that need an asynchronous clock source. 000 Output disabled 001 Divide by 1 010 Divide by 2 011 Divide by 4 100 Divide by 8 101 Divide by 16 110 Divide by 32 111 Divide by 64
7–3 Reserved	This field is reserved. This read-only field is reserved and always has the value 0.

28.3.16 Fast IRC Configuration Register (SCG_FIRCCFG)

The FIRCCFG register cannot be changed when the Fast IRC is enabled. When the Fast IRC is enabled, writes to this register are ignored, and there is no transfer error.

Address: 0h base + 308h offset = 308h

Bit	31	30	29	28	27	26	25	24		23	22	21	20	19	18	17	16
R	0																
W	[Shaded]																
Reset	0	0	0	0	0	0	0	0		0	0	0	0	0	0	0	0
Bit	15	14	13	12	11	10	9	8		7	6	5	4	3	2	1	0
R	0															RANGE	
W	[Shaded]															[Shaded]	
Reset	0	0	0	0	0	0	0	0		0	0	0	0	0	0	0	0

SCG_FIRCCFG field descriptions

Field	Description
31–2 Reserved	This field is reserved. This read-only field is reserved and always has the value 0.
RANGE	Frequency Range See chip-specific information for supported frequency ranges. 00 Fast IRC is trimmed to 48 MHz 01 Reserved 10 Reserved 11 Reserved

28.3.17 System PLL Control Status Register (SCG_SPLLCSR)

Address: 0h base + 600h offset = 600h

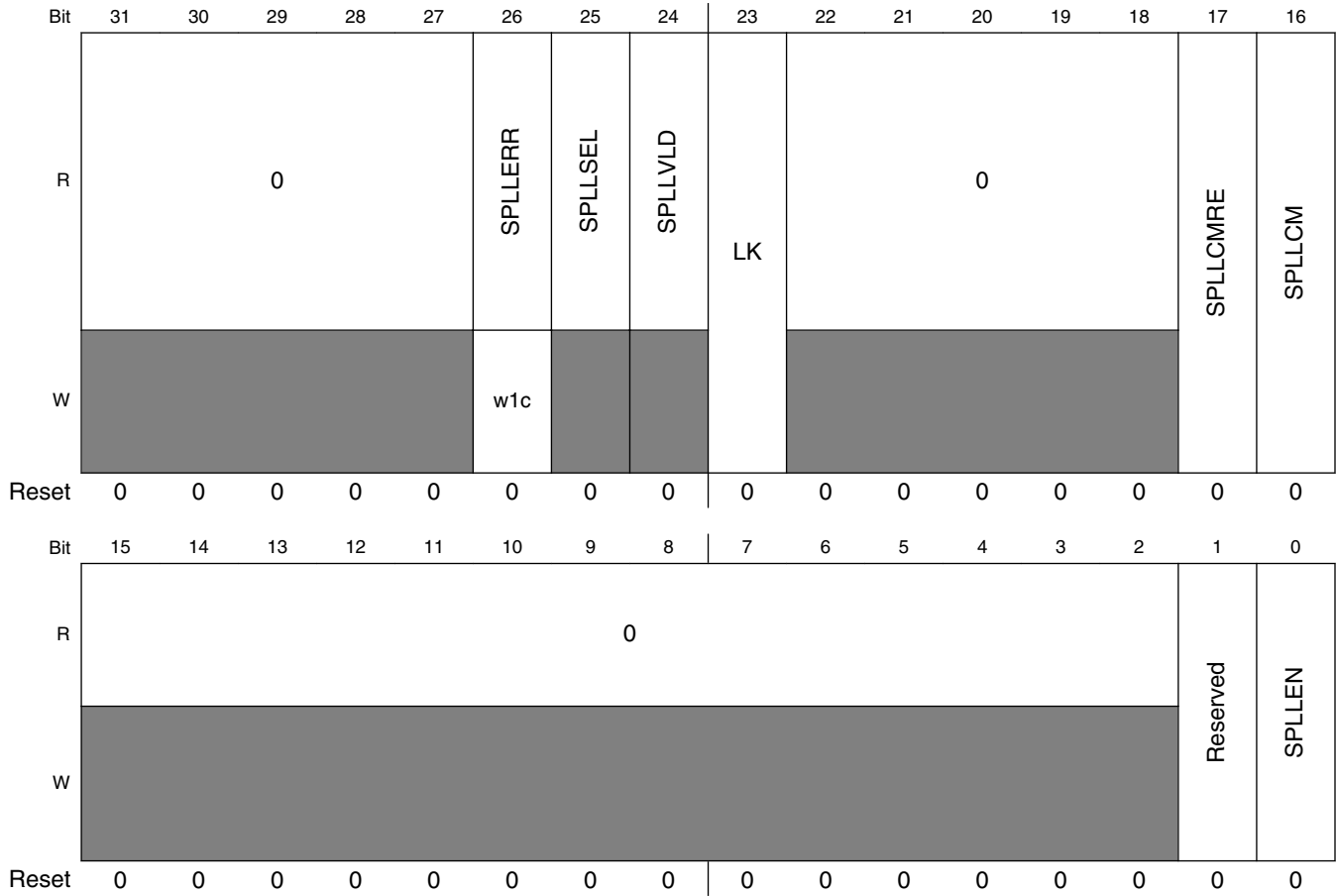

SCG_SPLLCSR field descriptions

Field	Description
31–27 Reserved	This field is reserved. This read-only field is reserved and always has the value 0.
26 SPLLERR	System PLL Clock Error This flag is reset on Chip POR only, software can also clear this flag by writing a logic one NOTE: The LOL Flag is set when the PLL reference is out of range (Dunl in datasheet) and is constantly modulated such that 3 consecutive un-locked samples of the reference clock are generated. 0 System PLL Clock Monitor is disabled or has not detected an error 1 System PLL Clock Monitor is enabled and detected an error. System PLL Clock Error flag will not set when System OSC is selected as its source and SOSCERR has set.
25 SPLLSEL	System PLL Selected 0 System PLL is not the system clock source 1 System PLL is the system clock source

Table continues on the next page...

SCG_SPLLCSR field descriptions (continued)

Field	Description
24 SPLLVD	<p>System PLL Valid</p> <p>Indicates when the SPLL clock is valid. When the System PLL (SPLL) is disabled, the System PLL Valid bit (SPLLVD) will clear without causing the System PLL Clock Error bit (SPLLERR) to get set. In a similar way, if the System PLL (SPLL) is using the System Oscillator (SOSC) as its reference clock, and a System OSC Clock Error (SOSCCSR[SOSCERR]) is detected, then the System PLL Valid bit (SPLLVD) will clear without asserting a System PLL Clock Error (SPLLERR).</p> <p>Lock detect is determined by a lock detect circuit. Three samples of lock detect determines whether or not the clock is valid.</p> <p>NOTE: The System PLL Valid bit (SPLLVD) should only be used to verify that the SPLL is locked after initialization. To monitor the SPLL clock, ensure that the System PLL Clock Monitor is enabled, using the System PLL Clock Monitor bit (SPLLCM).</p> <p>0 System PLL is not enabled or clock is not valid 1 System PLL is enabled and output clock is valid</p>
23 LK	<p>Lock Register</p> <p>This bit field can be cleared/set at any time.</p> <p>0 Control Status Register can be written. 1 Control Status Register cannot be written.</p>
22–18 Reserved	<p>This field is reserved. This read-only field is reserved and always has the value 0.</p>
17 SPLLCMRE	<p>System PLL Clock Monitor Reset Enable</p> <p>0 Clock Monitor generates interrupt when error detected 1 Clock Monitor generates reset when error detected</p>
16 SPLLCM	<p>System PLL Clock Monitor</p> <p>Enables the clock monitor, if the clock source is disabled in a low power mode then the clock monitor is also disabled in the low power mode. When the clock monitor is disabled in a low power mode, it remains disabled until the clock valid flag is set following exit from the low power mode.</p> <p>0 System PLL Clock Monitor is disabled 1 System PLL Clock Monitor is enabled</p>
15–2 Reserved	<p>This field is reserved. This read-only field is reserved and always has the value 0.</p>
1 Reserved	<p>This field is reserved. This field is reserved. Software should write 0 to this bit to maintain compatibility.</p>
0 SPLLEN	<p>System PLL Enable</p> <p>NOTE: If this bit written during clock switching, it should be read back and confirmed before proceeding. As the device exits reset, the SCG_RCCR register should be configured as per the supported frequency ranges of the device BEFORE enabling the SPLL (SPLLEN =1).</p> <p>0 System PLL is disabled 1 System PLL is enabled</p>

28.3.18 System PLL Divide Register (SCG_SPLLDIV)

Changes to SPLLDIV should be done when System PLL is disabled to prevent glitches to output divided clock.

Address: 0h base + 604h offset = 604h

Bit	31	30	29	28	27	26	25	24	23	22	21	20	19	18	17	16
R	0													Reserved		
W	[Shaded]															
Reset	0	0	0	0	0	0	0	0	0	0	0	0	0	0	0	0
Bit	15	14	13	12	11	10	9	8	7	6	5	4	3	2	1	0
R	0					SPLLDIV2			0							
W	[Shaded]															
Reset	0	0	0	0	0	0	0	0	0	0	0	0	0	0	0	0

SCG_SPLLDIV field descriptions

Field	Description
31–19 Reserved	This field is reserved. This read-only field is reserved and always has the value 0.
18–16 Reserved	This field is reserved. This bit field is reserved. Software should write 0 to this bit field to maintain compatibility.
15–11 Reserved	This field is reserved. This read-only field is reserved and always has the value 0.
10–8 SPLLDIV2	System PLL Clock Divide 2 Clock divider 2 for System PLL. Used by modules that need an asynchronous clock source. 000 Clock disabled 001 Divide by 1 010 Divide by 2 011 Divide by 4 100 Divide by 8 101 Divide by 16 110 Divide by 32 111 Divide by 64
7–3 Reserved	This field is reserved. This read-only field is reserved and always has the value 0.

28.3.19 System PLL Configuration Register (SCG_SPLLCFG)

The SPLLCFG register cannot be changed when the System PLL is enabled. When the System PLL is enabled, writes to this register are ignored, and there is no transfer error.

The below information applies to VCO_CLK.

Memory Map/Register Definition

The $SPLL_CLK = (VCO_CLK)/2$

The $VCO_CLK = SPLL_SOURCE / (PREDIV + 1) \times (MULT + 16)$

$SPLL_SOURCE$ is the clock source selected from the $SOURCE$ bitfield of this register.

Address: 0h base + 608h offset = 608h

Bit	31	30	29	28	27	26	25	24	23	22	21	20	19	18	17	16
R	0								MULT							
W	[Shaded]								[Shaded]							
Reset	0	0	0	0	0	0	0	0	0	0	0	0	0	0	0	0
Bit	15	14	13	12	11	10	9	8	7	6	5	4	3	2	1	0
R	0					PREDIV			0					SOURCE		
W	[Shaded]					[Shaded]			[Shaded]							
Reset	0	0	0	0	0	0	0	0	0	0	0	0	0	0	0	0

SCG_SPLLCFG field descriptions

Field	Description																																																																								
31–21 Reserved	This field is reserved. This read-only field is reserved and always has the value 0.																																																																								
20–16 MULT	System PLL Multiplier Multiplier for the System PLL. The MULT bits establish the multiplication factor applied to the PLL reference clock frequency. Table 28-2. PLL VCO Multiply Factor <table border="1"> <thead> <tr> <th>MULT</th><th>Multiply Factor</th><th>MULT</th><th>Multiply Factor</th><th>MULT</th><th>Multiply Factor</th><th>MULT</th><th>Multiply Factor</th></tr> </thead> <tbody> <tr><td>00000</td><td>16</td><td>01000</td><td>24</td><td>10000</td><td>32</td><td>11000</td><td>40</td></tr> <tr><td>00001</td><td>17</td><td>01001</td><td>25</td><td>10001</td><td>33</td><td>11001</td><td>41</td></tr> <tr><td>00010</td><td>18</td><td>01010</td><td>26</td><td>10010</td><td>34</td><td>11010</td><td>42</td></tr> <tr><td>00011</td><td>19</td><td>01011</td><td>27</td><td>10011</td><td>35</td><td>11011</td><td>43</td></tr> <tr><td>00100</td><td>20</td><td>01100</td><td>28</td><td>10100</td><td>36</td><td>11100</td><td>44</td></tr> <tr><td>00101</td><td>21</td><td>01101</td><td>29</td><td>10101</td><td>37</td><td>11101</td><td>45</td></tr> <tr><td>00110</td><td>22</td><td>01110</td><td>30</td><td>10110</td><td>38</td><td>11110</td><td>46</td></tr> <tr><td>00111</td><td>23</td><td>01111</td><td>31</td><td>10111</td><td>39</td><td>11111</td><td>47</td></tr> </tbody> </table>	MULT	Multiply Factor	MULT	Multiply Factor	MULT	Multiply Factor	MULT	Multiply Factor	00000	16	01000	24	10000	32	11000	40	00001	17	01001	25	10001	33	11001	41	00010	18	01010	26	10010	34	11010	42	00011	19	01011	27	10011	35	11011	43	00100	20	01100	28	10100	36	11100	44	00101	21	01101	29	10101	37	11101	45	00110	22	01110	30	10110	38	11110	46	00111	23	01111	31	10111	39	11111	47
MULT	Multiply Factor	MULT	Multiply Factor	MULT	Multiply Factor	MULT	Multiply Factor																																																																		
00000	16	01000	24	10000	32	11000	40																																																																		
00001	17	01001	25	10001	33	11001	41																																																																		
00010	18	01010	26	10010	34	11010	42																																																																		
00011	19	01011	27	10011	35	11011	43																																																																		
00100	20	01100	28	10100	36	11100	44																																																																		
00101	21	01101	29	10101	37	11101	45																																																																		
00110	22	01110	30	10110	38	11110	46																																																																		
00111	23	01111	31	10111	39	11111	47																																																																		
15–11 Reserved	This field is reserved. This read-only field is reserved and always has the value 0.																																																																								
10–8 PREDIV	PLL Reference Clock Divider																																																																								

Table continues on the next page...

SCG_SPLLCFG field descriptions (continued)

Field	Description																		
	<p>Selects the amount to divide down the reference clock for the System PLL. The resulting frequency must be in the range specified in the datasheet.</p> <p style="text-align: center;">Table 28-3. System PLL Reference Divide Factor</p> <table border="1"> <thead> <tr> <th>PREDIV</th> <th>Divide Factor</th> </tr> </thead> <tbody> <tr> <td>000</td> <td>1</td> </tr> <tr> <td>001</td> <td>2</td> </tr> <tr> <td>010</td> <td>3</td> </tr> <tr> <td>011</td> <td>4</td> </tr> <tr> <td>100</td> <td>5</td> </tr> <tr> <td>101</td> <td>6</td> </tr> <tr> <td>110</td> <td>7</td> </tr> <tr> <td>111</td> <td>8</td> </tr> </tbody> </table>	PREDIV	Divide Factor	000	1	001	2	010	3	011	4	100	5	101	6	110	7	111	8
PREDIV	Divide Factor																		
000	1																		
001	2																		
010	3																		
011	4																		
100	5																		
101	6																		
110	7																		
111	8																		
7–1 Reserved	<p>This field is reserved. This read-only field is reserved and always has the value 0.</p>																		
0 SOURCE	<p>Clock Source</p> <p>Configures the input clock source for the System PLL.</p> <p>0 System OSC (SOSC) 1 Fast IRC (FIRC)</p>																		

28.4 Functional description

28.4.1 SCG Clock Mode Transitions

The following figure shows the valid clock mode transitions supported by SCG.

Slow IRC (SIRC) boot mode is not supported on this device.

SCG Valid Mode Transitions

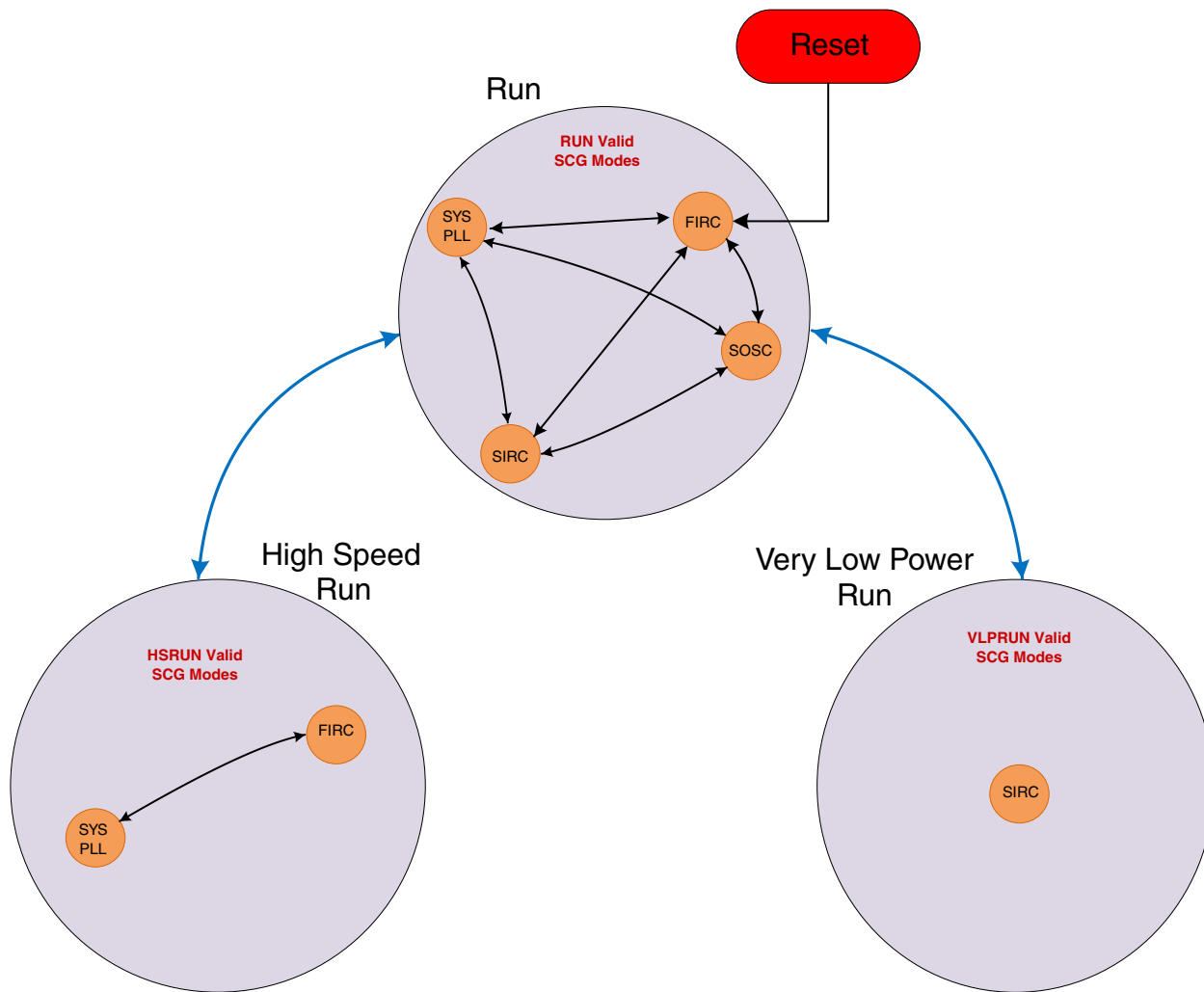

Figure 28-1. SCG Valid Mode Transition Diagram

NOTE

When a transition between run modes (RUN, HSRUN, VLPRUN) is required, the SCG should complete the switch to the clock mode as defined in the SCG clock control register first. Once the switch to the clock mode is completed, the system can then initiate the request for the selected run mode.

For example, if a transition from RUN mode to VLPRUN is required, first complete any required clock change. Initiate the VLPRUN request **after** the clock change has completed.

The power modes are chip specific. For more details about power mode assignments, see power management and system mode control information.

The modes of operation listed in the following table are the valid modes for this implementation of the SCG.

Table 28-4. SCG modes of operation

Mode	Description
System Oscillator Clock (SOSC)	<p>System Oscillator Clock (SOSC) mode is entered when all the following conditions occur:</p> <ul style="list-style-type: none"> • RUN MODE: 0001 is written to RCCR[SCS]. • SOSSEN = 1 • SOSCVLD = 1 <p>In SOSC mode, SCGCLKOUT and system clocks are derived from the external System Oscillator Clock (SOSC).</p>
Slow Internal Reference Clock (SIRC)	<p>Slow Internal Reference Clock (SIRC) mode is entered when all the following conditions occur:</p> <ul style="list-style-type: none"> • RUN MODE: 0010 is written to RCCR[SCS]. • VLRUN MODE: 0010 is written to VCCR[SCS] and 1 is written to SIRCCSR[SIRCLPEN]. • SIRCEN = 1 • SIRCVLD = 1 <p>In SIRC mode, SCGCLKOUT and system clocks are derived from the slow internal reference clock. Two frequency ranges are available for SIRC clock as described in the SIRCCFG[RANGE] register definition. Changes to SIRC range settings will be ignored when SIRC clock is enabled.</p> <p>Information regarding SIRC operation during normal and low power stop modes is found in the "Stop" row of this table.</p> <p>See chip-specific information for supported frequency ranges.</p>
Fast Internal Reference Clock (FIRC)	<p>Fast Internal Reference Clock (FIRC) mode is the default clock mode of operation and is entered when all the following conditions occur:</p> <ul style="list-style-type: none"> • RUN MODE: 0011 is written to RCCR[SCS]. • HSRUN MODE: 0011 is written to HCCR[SCS]. • FIRCEN = 1 • FIRCREGOFF = 0 • FIRCVLD = 1 <p>In FIRC mode, SCGCLKOUT and system clocks are derived from the fast internal reference clock. Four frequency range settings are available for FIRC clock as described in the FIRC[RANGE] register definition. Changes to FIRC range settings will be ignored when FIRC clock is enabled.</p> <p>See chip-specific information for supported frequency ranges.</p>
Sys PLL (SPLL)	<p>Sys PLL (SPLL) mode is entered when all the following conditions occur:</p> <ul style="list-style-type: none"> • RUN MODE: 0110 is written to RCCR[SCS]. • HSRUN MODE: 0110 is written to HCCR[SCS]. • SPLLEN = 1 • SPLLVD = 1

Table continues on the next page...

Table 28-4. SCG modes of operation (continued)

Mode	Description
	<p>In SPLL mode, the SCGCLKOUT and system clocks are derived from the output of PLL which is controlled by either the System Oscillator (SOSC) clock or the Fast internal reference clock (FIRC). The selected PLL clock frequency locks to a multiplication factor, as specified by its corresponding SCG_SPLLCFG[MULT], times the selected PLL reference frequency. The PLL's programmable reference divider must be configured to produce a valid PLL reference clock. This divide value is defined by the SCG_SPLLCFG[PREDIV] bits.</p>
Stop	<p>Entered whenever the MCU enters a Stop state. The power modes are chip specific. For power mode assignments, see the chapter that describes how modules are configured and SCG behaviour during Stop recovery. Entering Stop mode, all SCG clock signals are static except the following clocks which can continue to run and stay enabled in the following cases:</p> <p>SIRCCLK is available in Normal Stop and VLPS mode when all the following conditions become true:</p> <ul style="list-style-type: none"> • SIRCCSR[SIRCEN] = 1 • SIRCCSR[SIRCSTEN] = 1 • SIRCCSR[SIRCLPEN] = 1 in VLPS

Chapter 29

Peripheral Clock Controller (PCC)

29.1 Chip-specific PCC information

For module specific clocking, see [Module clocks](#).

NOTE

While change a peripheral clock configurations (clock source, divider configurations, etc.), the corresponding module should be disabled:

- Clock should be CGC gated
- Module should be disabled by MDIS bit, if available

NOTE

- Before clock configuration changes, the user should ensure that module is disabled and not actively communicating / interacting and is in a quiescent state.
- For S32K144W, PCC_LPIT additionally supports LPO_CLK (configured with PCC_LPIT[PCS]=111).

After clock switching, the module should be soft reset using soft reset bit (module software reset bit), if available.

SIM_SDID[FEATURES] bit field overrides the PCC.PR status for the chip.

29.1.1 PCC register information

The [PCC memory map](#) shows a superset of registers implemented for the S32K1xx series. Registers for instances unavailable in a particular variant are reserved.

S32K11x has two additional registers (PCC_CMU0 and PCC_CMU1) for CMU0 and CMU1 instances as described in the following sections. Similarly S32K144W has one register, PCC_FTFM in place of PCC_FTFC as described in the following sections.

29.1.1.1 PCC CMU0 Register (PCC_CMU0)

29.1.1.1.1 Offset

Register	Offset
PCC_CMU0	F8h

29.1.1.1.2 Function

PCC Register

29.1.1.1.3 Diagram

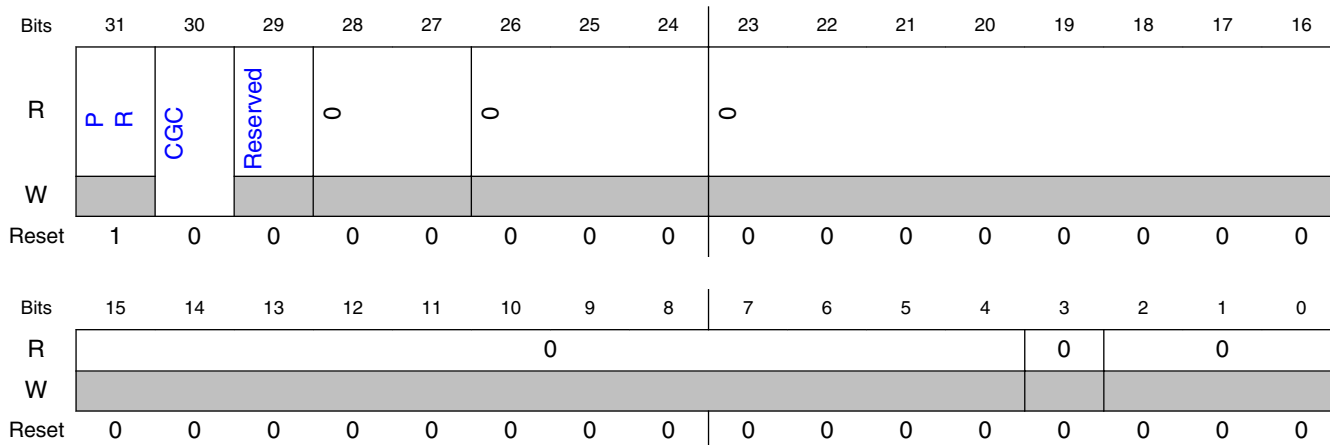

29.1.1.1.4 Fields

Field	Function
31 PR	Present This bit shows whether the peripheral is present on this device. 0b - Peripheral is not present. 1b - Peripheral is present.
30 CGC	Clock Gate Control This read/write bit enables the clock for the peripheral. 0b - Clock disabled 1b - Clock enabled. The current clock selection and divider options are locked.
29 —	This read-only bit field is reserved. This bit can change values but is a don't-care.

Table continues on the next page...

Field	Function
28-27 —	This read-only bit field is reserved and always has the value 0.
26-24 —	This read-only bit field is reserved and always has the value 0.
23-4 —	This read-only bit field is reserved and always has the value 0.
3 —	This read-only bit field is reserved and always has the value 0.
2-0 —	This read-only bit field is reserved and always has the value 0.

29.1.1.2 PCC CMU1 Register (PCC_CMU1)

29.1.1.2.1 Offset

Register	Offset
PCC_CMU1	FCh

29.1.1.2.2 Function

PCC Register

29.1.1.2.3 Diagram

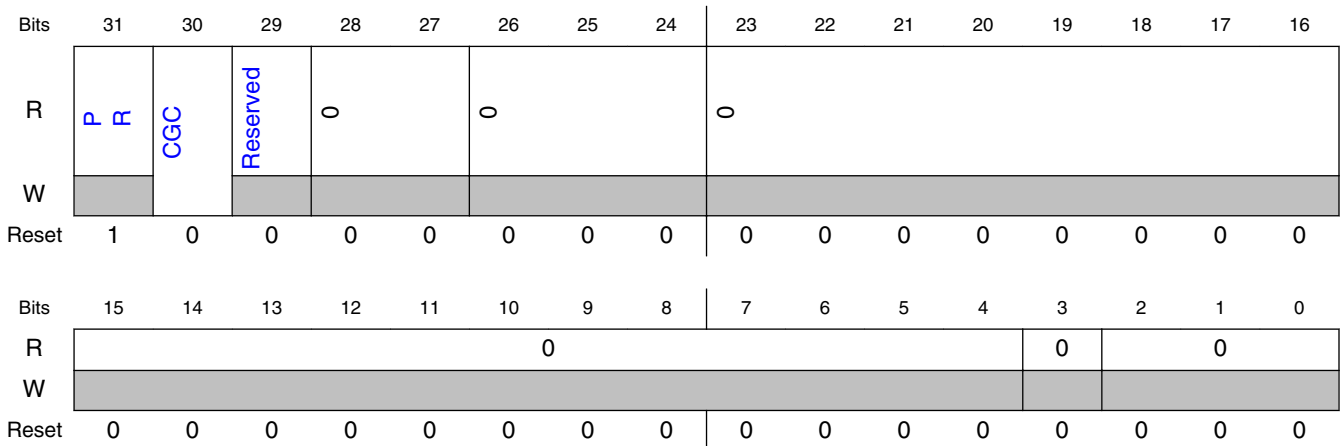

29.1.1.2.4 Fields

Field	Function
31 PR	Present This bit shows whether the peripheral is present on this device. 0b - Peripheral is not present. 1b - Peripheral is present.
30 CGC	Clock Gate Control This read/write bit enables the clock for the peripheral. 0b - Clock disabled 1b - Clock enabled. The current clock selection and divider options are locked.
29 —	This read-only bit field is reserved. This bit can change values but is a don't-care.
28-27 —	This read-only bit field is reserved and always has the value 0.
26-24 —	This read-only bit field is reserved and always has the value 0.
23-4 —	This read-only bit field is reserved and always has the value 0.
3 —	This read-only bit field is reserved and always has the value 0.
2-0 —	This read-only bit field is reserved and always has the value 0.

29.1.1.3 PCC FTFM Register (PCC_FTFM)

29.1.1.3.1 Offset

Register	Offset
PCC_FTFM	80h

29.1.1.3.2 Function

PCC Register

29.1.1.3.3 Diagram

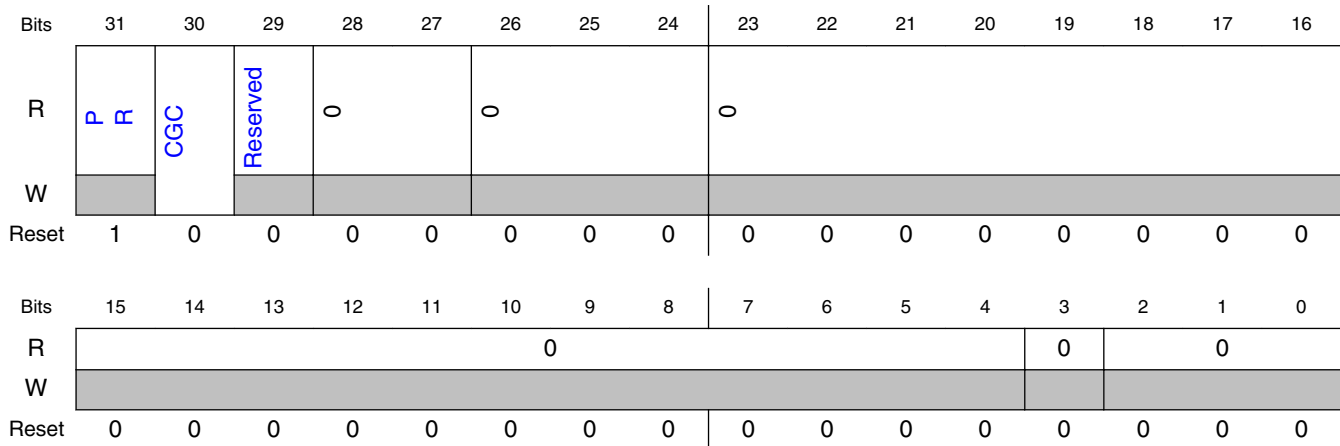

29.1.1.3.4 Fields

Field	Function
31 PR	Present This bit shows whether the peripheral is present on this device. 0b - Peripheral is not present. 1b - Peripheral is present.
30 CGC	Clock Gate Control This read/write bit enables the clock for the peripheral. 0b - Clock disabled 1b - Clock enabled. The current clock selection and divider options are locked.
29 —	This read-only bit field is reserved. This bit can change values but is a don't-care.
28-27 —	This read-only bit field is reserved and always has the value 0.
26-24 —	This read-only bit field is reserved and always has the value 0.
23-4 —	This read-only bit field is reserved and always has the value 0.
3 —	This read-only bit field is reserved and always has the value 0.
2-0 —	This read-only bit field is reserved and always has the value 0.

29.2 Introduction

The Peripheral Clock Control (PCC) module provides clock control and configuration for on-chip peripherals. Each peripheral has its own clock control and configuration register.

29.3 Features

The PCC module enables software to configure the following clocking options for each peripheral:

- Interface clock gating
- Functional clock source selection
- Functional clock divide values

Below is a block diagram of the PCC module:

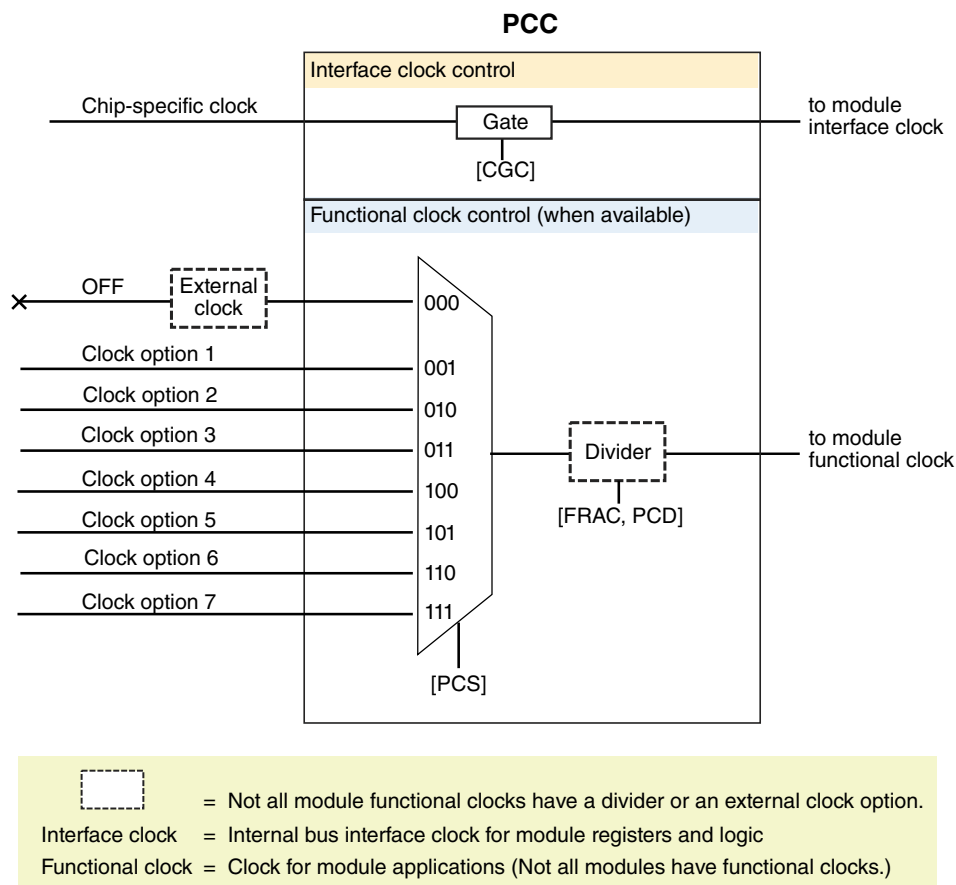

Figure 29-1. PCC Block Diagram

29.4 Functional description

The PCC module provides on-chip peripherals (modules) their own dedicated PCC registers for clock gating and configuration options. Each module's PCC register contains a clock gating control bit (CGC) for the module's interface clock. Before a module can be used, its interface clock must be enabled (CGC = 1) in the module's PCC register.

If a module has a functional clock, its PCC register may provide options for the clock source, selected by programming the Peripheral Clock Select (PCS) field. Optionally, a module may also have a clock divider, selected by programming the Peripheral Clock Divider (PCD) field along with a Fraction (FRAC) field. Before configuring a functional clock, the module's interface clock must be disabled (CGC = 0).

29.5 Memory map and register definition

Each module has its own dedicated PCC register, which controls the clock gating, clock source and divider (when applicable) for that specific module. See each module's PCC register for details.

PCC registers can be written only in supervisor mode using 32-bit accesses.

NOTE

To configure the clocking options available to a given module or to modify an existing configuration, first disable the module's interface clock by writing 0 to its CGC bit.

29.6 PCC register descriptions

29.6.1 PCC memory map

PCC base address: 4006_5000h

Offset	Register	Width (In bits)	Access	Reset value
80h	PCC FTFC Register (PCC_FTFC)	32	RW	C000_0000h

Table continues on the next page...

PCC register descriptions

Offset	Register	Width (In bits)	Access	Reset value
84h	PCC DMAMUX Register (PCC_DMAMUX)	32	RW	8000_0000h
90h	PCC FlexCAN0 Register (PCC_FlexCAN0)	32	RW	8000_0000h
94h	PCC FlexCAN1 Register (PCC_FlexCAN1)	32	RW	8000_0000h
98h	PCC FTM3 Register (PCC_FTM3)	32	RW	8000_0000h
9Ch	PCC ADC1 Register (PCC_ADC1)	32	RW	8000_0000h
ACh	PCC FlexCAN2 Register (PCC_FlexCAN2)	32	RW	8000_0000h
B0h	PCC LPSPI0 Register (PCC_LPSPI0)	32	RW	8000_0000h
B4h	PCC LPSPI1 Register (PCC_LPSPI1)	32	RW	8000_0000h
B8h	PCC LPSPI2 Register (PCC_LPSPI2)	32	RW	8000_0000h
C4h	PCC PDB1 Register (PCC_PDB1)	32	RW	8000_0000h
C8h	PCC CRC Register (PCC_CRC)	32	RW	8000_0000h
D8h	PCC PDB0 Register (PCC_PDB0)	32	RW	8000_0000h
DCh	PCC LPIT Register (PCC_LPIT)	32	RW	8000_0000h
E0h	PCC FTM0 Register (PCC_FTM0)	32	RW	8000_0000h
E4h	PCC FTM1 Register (PCC_FTM1)	32	RW	8000_0000h
E8h	PCC FTM2 Register (PCC_FTM2)	32	RW	8000_0000h
ECh	PCC ADC0 Register (PCC_ADC0)	32	RW	8000_0000h
F4h	PCC RTC Register (PCC_RTC)	32	RW	8000_0000h
100h	PCC LPTMR0 Register (PCC_LPTMR0)	32	RW	8000_0000h
124h	PCC PORTA Register (PCC_PORTA)	32	RW	8000_0000h
128h	PCC PORTB Register (PCC_PORTB)	32	RW	8000_0000h
12Ch	PCC PORTC Register (PCC_PORTC)	32	RW	8000_0000h
130h	PCC PORTD Register (PCC_PORTD)	32	RW	8000_0000h
134h	PCC PORTE Register (PCC_PORTE)	32	RW	8000_0000h
150h	PCC SAI0 Register (PCC_SAI0)	32	RW	8000_0000h
154h	PCC SAI1 Register (PCC_SAI1)	32	RW	8000_0000h
168h	PCC FlexIO Register (PCC_FlexIO)	32	RW	8000_0000h
184h	PCC EWM Register (PCC_EWM)	32	RW	8000_0000h
198h	PCC LPI2C0 Register (PCC_LPI2C0)	32	RW	8000_0000h
19Ch	PCC LPI2C1 Register (PCC_LPI2C1)	32	RW	8000_0000h
1A8h	PCC LPUART0 Register (PCC_LPUART0)	32	RW	8000_0000h
1ACh	PCC LPUART1 Register (PCC_LPUART1)	32	RW	8000_0000h
1B0h	PCC LPUART2 Register (PCC_LPUART2)	32	RW	8000_0000h
1B8h	PCC FTM4 Register (PCC_FTM4)	32	RW	8000_0000h
1BCh	PCC FTM5 Register (PCC_FTM5)	32	RW	8000_0000h
1C0h	PCC FTM6 Register (PCC_FTM6)	32	RW	8000_0000h
1C4h	PCC FTM7 Register (PCC_FTM7)	32	RW	8000_0000h
1CCh	PCC CMP0 Register (PCC_CMP0)	32	RW	8000_0000h
1D8h	PCC QSPI Register (PCC_QSPI)	32	RW	8000_0000h
1E4h	PCC ENET Register (PCC_ENET)	32	RW	8000_0000h

29.6.2 PCC FTFC Register (PCC_FTFC)

29.6.2.1 Offset

Register	Offset
PCC_FTFC	80h

29.6.2.2 Function

This register is for the FTFC module.

29.6.2.3 Diagram

Bits	31	30	29	28	27	26	25	24	23	22	21	20	19	18	17	16
R	1	1	CGC	Reserved	0	0	0	0	0	0	0	0	0	0	0	0
W																
Reset	1	1	0	0	0	0	0	0	0	0	0	0	0	0	0	0
Bits	15	14	13	12	11	10	9	8	7	6	5	4	3	2	1	0
R	0								0	0	0	0	0	0	0	0
W																
Reset	0	0	0	0	0	0	0	0	0	0	0	0	0	0	0	0

29.6.2.4 Fields

Field	Function
31 PR	Present This bit shows whether the peripheral is present on this device. 0b - Peripheral is not present. 1b - Peripheral is present.
30	Clock Gate Control

Table continues on the next page...

PCC register descriptions

Field	Function
CGC	This read/write bit enables the interface clock for the peripheral, allowing access to the module's registers. It also controls whether the clock selection and divider options can be modified. 0b - Clock disabled. The current clock selection and divider options are not locked and can be modified. 1b - Clock enabled. The current clock selection and divider options are locked and cannot be modified.
29 —	This read-only bit field is reserved. This bit can change values but is a don't-care.
28-27 —	This read-only bit field is reserved and always has the value 0.
26-24 —	This read-only bit field is reserved and always has the value 0.
23-4 —	This read-only bit field is reserved and always has the value 0.
3 —	This read-only bit field is reserved and always has the value 0.
2-0 —	This read-only bit field is reserved and always has the value 0.

29.6.3 PCC DMAMUX Register (PCC_DMAMUX)

29.6.3.1 Offset

Register	Offset
PCC_DMAMUX	84h

29.6.3.2 Function

This register is for the DMAMUX module.

29.6.3.3 Diagram

Bits	31	30	29	28	27	26	25	24	23	22	21	20	19	18	17	16
R	P	R	CGC	Reserved	0	0	0	0	0	0	0	0	0	0	0	0
W																
Reset	1	0	0	0	0	0	0	0	0	0	0	0	0	0	0	0
Bits	15	14	13	12	11	10	9	8	7	6	5	4	3	2	1	0
R	0								0	0						
W																
Reset	0	0	0	0	0	0	0	0	0	0	0	0	0	0	0	0

29.6.3.4 Fields

Field	Function
31 PR	Present This bit shows whether the peripheral is present on this device. 0b - Peripheral is not present. 1b - Peripheral is present.
30 CGC	Clock Gate Control This read/write bit enables the interface clock for the peripheral, allowing access to the module's registers. It also controls whether the clock selection and divider options can be modified. 0b - Clock disabled. The current clock selection and divider options are not locked and can be modified. 1b - Clock enabled. The current clock selection and divider options are locked and cannot be modified.
29 —	This read-only bit field is reserved. This bit can change values but is a don't-care.
28-27 —	This read-only bit field is reserved and always has the value 0.
26-24 —	This read-only bit field is reserved and always has the value 0.
23-4 —	This read-only bit field is reserved and always has the value 0.
3 —	This read-only bit field is reserved and always has the value 0.
2-0 —	This read-only bit field is reserved and always has the value 0.

29.6.4 PCC FlexCAN0 Register (PCC_FlexCAN0)

29.6.4.1 Offset

Register	Offset
PCC_FlexCAN0	90h

29.6.4.2 Function

This register is for the FlexCAN0 module.

29.6.4.3 Diagram

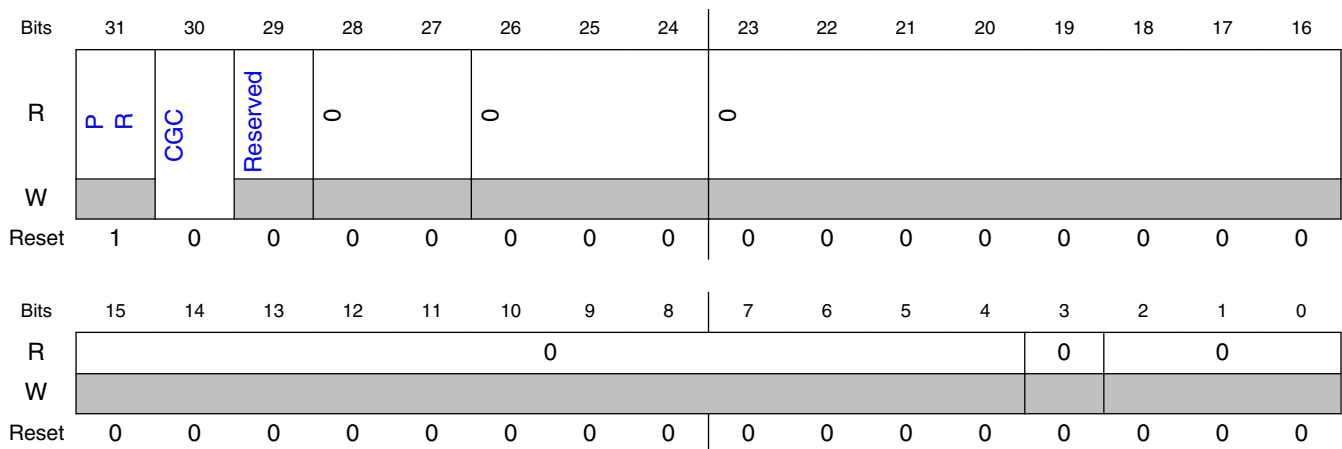

29.6.4.4 Fields

Field	Function
31 PR	Present This bit shows whether the peripheral is present on this device. 0b - Peripheral is not present. 1b - Peripheral is present.
30 CGC	Clock Gate Control

Table continues on the next page...

Field	Function
	This read/write bit enables the interface clock for the peripheral, allowing access to the module's registers. It also controls whether the clock selection and divider options can be modified. 0b - Clock disabled. The current clock selection and divider options are not locked and can be modified. 1b - Clock enabled. The current clock selection and divider options are locked and cannot be modified.
29 —	This read-only bit field is reserved. This bit can change values but is a don't-care.
28-27 —	This read-only bit field is reserved and always has the value 0.
26-24 —	This read-only bit field is reserved and always has the value 0.
23-4 —	This read-only bit field is reserved and always has the value 0.
3 —	This read-only bit field is reserved and always has the value 0.
2-0 —	This read-only bit field is reserved and always has the value 0.

29.6.5 PCC FlexCAN1 Register (PCC_FlexCAN1)

29.6.5.1 Offset

Register	Offset
PCC_FlexCAN1	94h

29.6.5.2 Function

This register is for the FlexCAN1 module.

29.6.5.3 Diagram

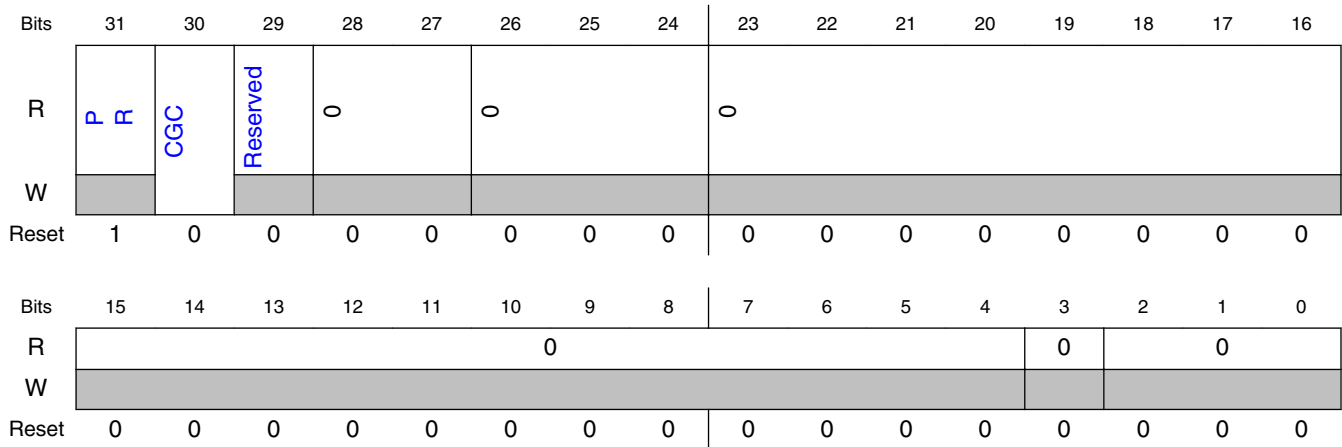

29.6.5.4 Fields

Field	Function
31 PR	Present This bit shows whether the peripheral is present on this device. 0b - Peripheral is not present. 1b - Peripheral is present.
30 CGC	Clock Gate Control This read/write bit enables the interface clock for the peripheral, allowing access to the module's registers. It also controls whether the clock selection and divider options can be modified. 0b - Clock disabled. The current clock selection and divider options are not locked and can be modified. 1b - Clock enabled. The current clock selection and divider options are locked and cannot be modified.
29 —	This read-only bit field is reserved. This bit can change values but is a don't-care.
28-27 —	This read-only bit field is reserved and always has the value 0.
26-24 —	This read-only bit field is reserved and always has the value 0.
23-4 —	This read-only bit field is reserved and always has the value 0.
3 —	This read-only bit field is reserved and always has the value 0.
2-0 —	This read-only bit field is reserved and always has the value 0.

29.6.6 PCC FTM3 Register (PCC_FTM3)

29.6.6.1 Offset

Register	Offset
PCC_FTM3	98h

29.6.6.2 Function

This register is for the FTM3 module.

29.6.6.3 Diagram

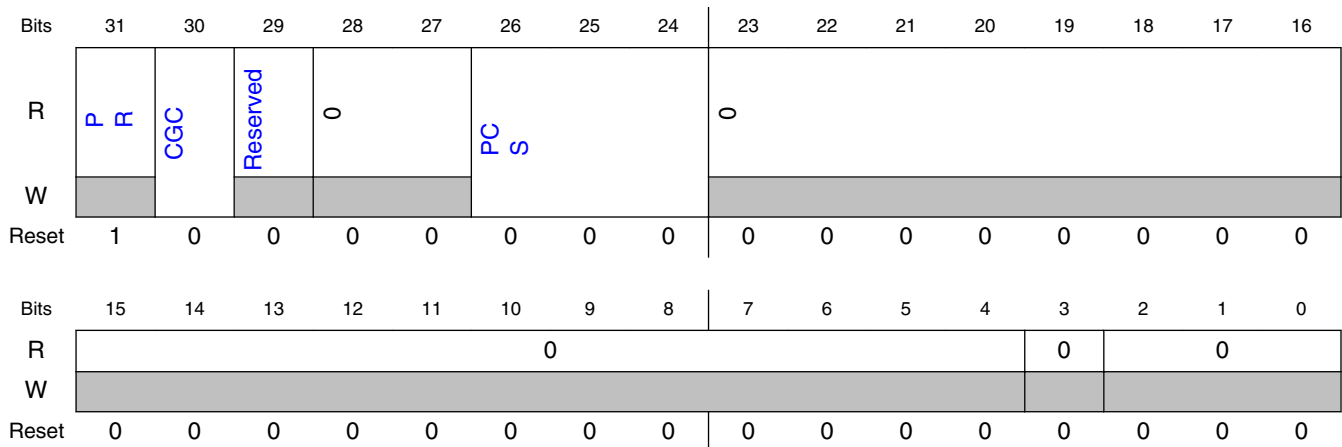

29.6.6.4 Fields

Field	Function
31 PR	Present This bit shows whether the peripheral is present on this device. 0b - Peripheral is not present. 1b - Peripheral is present.
30 CGC	Clock Gate Control

Table continues on the next page...

PCC register descriptions

Field	Function
	<p>This read/write bit enables the interface clock for the peripheral, allowing access to the module's registers. It also controls whether the clock selection and divider options can be modified.</p> <p>0b - Clock disabled. The current clock selection and divider options are not locked and can be modified.</p> <p>1b - Clock enabled. The current clock selection and divider options are locked and cannot be modified.</p>
29 —	This read-only bit field is reserved. This bit can change values but is a don't-care.
28-27 —	This read-only bit field is reserved and always has the value 0.
26-24 PCS	<p>Peripheral Clock Source Select</p> <p>This read/write bit field is used for peripherals that support various clock selections. This field can be written only when the clock is disabled (CGC = 0).</p> <p>000b - Clock is off. An external clock can be enabled for this peripheral.</p> <p>001b - Clock option 1</p> <p>010b - Clock option 2</p> <p>011b - Clock option 3</p> <p>100b - Clock option 4</p> <p>101b - Clock option 5</p> <p>110b - Clock option 6</p> <p>111b - Clock option 7</p>
23-4 —	This read-only bit field is reserved and always has the value 0.
3 —	This read-only bit field is reserved and always has the value 0.
2-0 —	This read-only bit field is reserved and always has the value 0.

29.6.7 PCC ADC1 Register (PCC_ADC1)

29.6.7.1 Offset

Register	Offset
PCC_ADC1	9Ch

29.6.7.2 Function

This register is for the ADC1 module.

29.6.7.3 Diagram

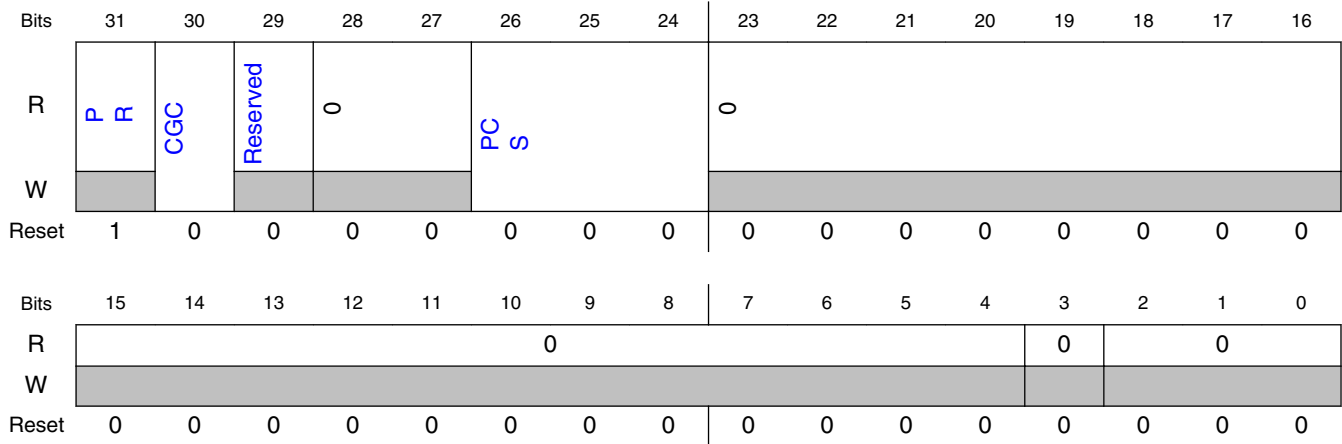

29.6.7.4 Fields

Field	Function
31 PR	Present This bit shows whether the peripheral is present on this device. 0b - Peripheral is not present. 1b - Peripheral is present.
30 CGC	Clock Gate Control This read/write bit enables the interface clock for the peripheral, allowing access to the module's registers. It also controls whether the clock selection and divider options can be modified. 0b - Clock disabled. The current clock selection and divider options are not locked and can be modified. 1b - Clock enabled. The current clock selection and divider options are locked and cannot be modified.
29 —	This read-only bit field is reserved. This bit can change values but is a don't-care.
28-27 —	This read-only bit field is reserved and always has the value 0.
26-24 PCS	Peripheral Clock Source Select This read/write bit field is used for peripherals that support various clock selections. This field can be written only when the clock is disabled (CGC = 0). 000b - Clock is off. 001b - Clock option 1 010b - Clock option 2 011b - Clock option 3 100b - Clock option 4 101b - Clock option 5

Table continues on the next page...

PCC register descriptions

Field	Function
	110b - Clock option 6 111b - Clock option 7
23-4 —	This read-only bit field is reserved and always has the value 0.
3 —	This read-only bit field is reserved and always has the value 0.
2-0 —	This read-only bit field is reserved and always has the value 0.

29.6.8 PCC FlexCAN2 Register (PCC_FlexCAN2)

29.6.8.1 Offset

Register	Offset
PCC_FlexCAN2	ACh

29.6.8.2 Function

This register is for the FlexCAN2 module.

29.6.8.3 Diagram

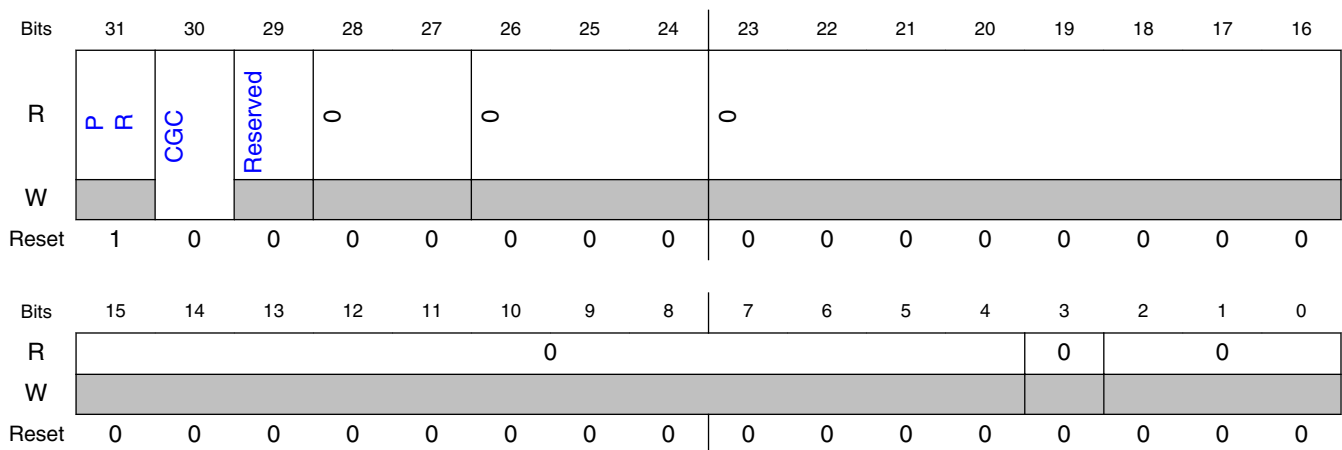

29.6.8.4 Fields

Field	Function
31 PR	Present This bit shows whether the peripheral is present on this device. 0b - Peripheral is not present. 1b - Peripheral is present.
30 CGC	Clock Gate Control This read/write bit enables the interface clock for the peripheral, allowing access to the module's registers. It also controls whether the clock selection and divider options can be modified. 0b - Clock disabled. The current clock selection and divider options are not locked and can be modified. 1b - Clock enabled. The current clock selection and divider options are locked and cannot be modified.
29 —	This read-only bit field is reserved. This bit can change values but is a don't-care.
28-27 —	This read-only bit field is reserved and always has the value 0.
26-24 —	This read-only bit field is reserved and always has the value 0.
23-4 —	This read-only bit field is reserved and always has the value 0.
3 —	This read-only bit field is reserved and always has the value 0.
2-0 —	This read-only bit field is reserved and always has the value 0.

29.6.9 PCC LPSPI0 Register (PCC_LPSPi0)

29.6.9.1 Offset

Register	Offset
PCC_LPSPi0	B0h

29.6.9.2 Function

This register is for the LPSPI0 module.

29.6.9.3 Diagram

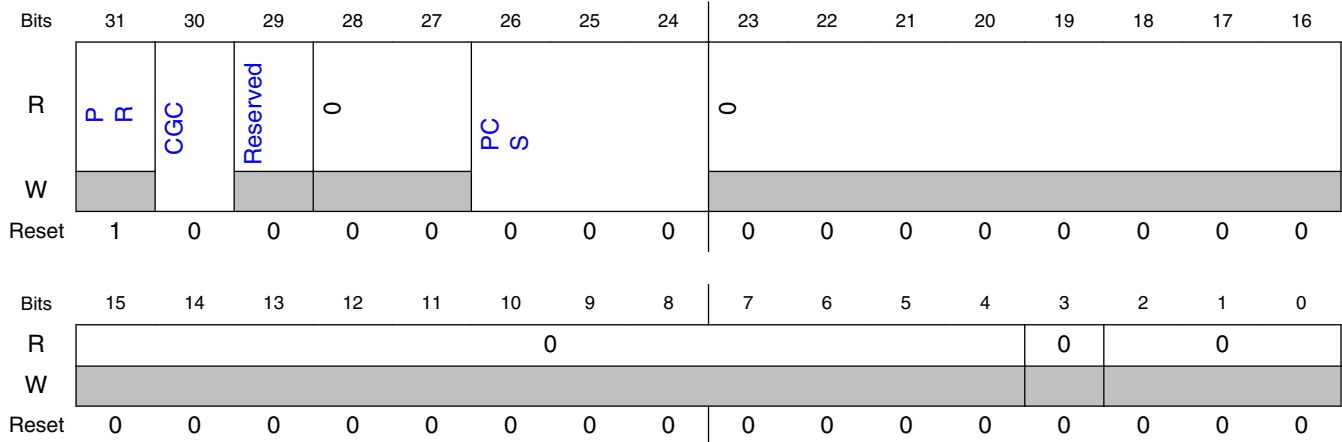

29.6.9.4 Fields

Field	Function
31 PR	Present This bit shows whether the peripheral is present on this device. 0b - Peripheral is not present. 1b - Peripheral is present.
30 CGC	Clock Gate Control This read/write bit enables the interface clock for the peripheral, allowing access to the module's registers. It also controls whether the clock selection and divider options can be modified. 0b - Clock disabled. The current clock selection and divider options are not locked and can be modified. 1b - Clock enabled. The current clock selection and divider options are locked and cannot be modified.
29 —	This read-only bit field is reserved. This bit can change values but is a don't-care.
28-27 —	This read-only bit field is reserved and always has the value 0.
26-24 PCS	Peripheral Clock Source Select This read/write bit field is used for peripherals that support various clock selections. This field can be written only when the clock is disabled (CGC = 0). 000b - Clock is off. 001b - Clock option 1 010b - Clock option 2 011b - Clock option 3 100b - Clock option 4 101b - Clock option 5

Table continues on the next page...

Field	Function
	110b - Clock option 6 111b - Clock option 7
23-4 —	This read-only bit field is reserved and always has the value 0.
3 —	This read-only bit field is reserved and always has the value 0.
2-0 —	This read-only bit field is reserved and always has the value 0.

29.6.10 PCC LPSPI1 Register (PCC_LPSP1)

29.6.10.1 Offset

Register	Offset
PCC_LPSP1	B4h

29.6.10.2 Function

This register is for the LPSP1 module.

29.6.10.3 Diagram

Bits	31	30	29	28	27	26	25	24	23	22	21	20	19	18	17	16
R	0	0	0	0	0	0	0	0	0	0	0	0	0	0	0	0
W	0	0	0	0	0	0	0	0	0	0	0	0	0	0	0	0
Reset	1	0	0	0	0	0	0	0	0	0	0	0	0	0	0	0
Bits	15	14	13	12	11	10	9	8	7	6	5	4	3	2	1	0
R	0	0	0	0	0	0	0	0	0	0	0	0	0	0	0	0
W	0	0	0	0	0	0	0	0	0	0	0	0	0	0	0	0
Reset	0	0	0	0	0	0	0	0	0	0	0	0	0	0	0	0

29.6.10.4 Fields

Field	Function
31 PR	Present This bit shows whether the peripheral is present on this device. 0b - Peripheral is not present. 1b - Peripheral is present.
30 CGC	Clock Gate Control This read/write bit enables the interface clock for the peripheral, allowing access to the module's registers. It also controls whether the clock selection and divider options can be modified. 0b - Clock disabled. The current clock selection and divider options are not locked and can be modified. 1b - Clock enabled. The current clock selection and divider options are locked and cannot be modified.
29 —	This read-only bit field is reserved. This bit can change values but is a don't-care.
28-27 —	This read-only bit field is reserved and always has the value 0.
26-24 PCS	Peripheral Clock Source Select This read/write bit field is used for peripherals that support various clock selections. This field can be written only when the clock is disabled (CGC = 0). 000b - Clock is off. 001b - Clock option 1 010b - Clock option 2 011b - Clock option 3 100b - Clock option 4 101b - Clock option 5 110b - Clock option 6 111b - Clock option 7
23-4 —	This read-only bit field is reserved and always has the value 0.
3 —	This read-only bit field is reserved and always has the value 0.
2-0 —	This read-only bit field is reserved and always has the value 0.

29.6.11 PCC LPSPI2 Register (PCC_LPSPi2)

29.6.11.1 Offset

Register	Offset
PCC_LPSPi2	B8h

29.6.11.2 Function

This register is for the LPSPi2 module.

29.6.11.3 Diagram

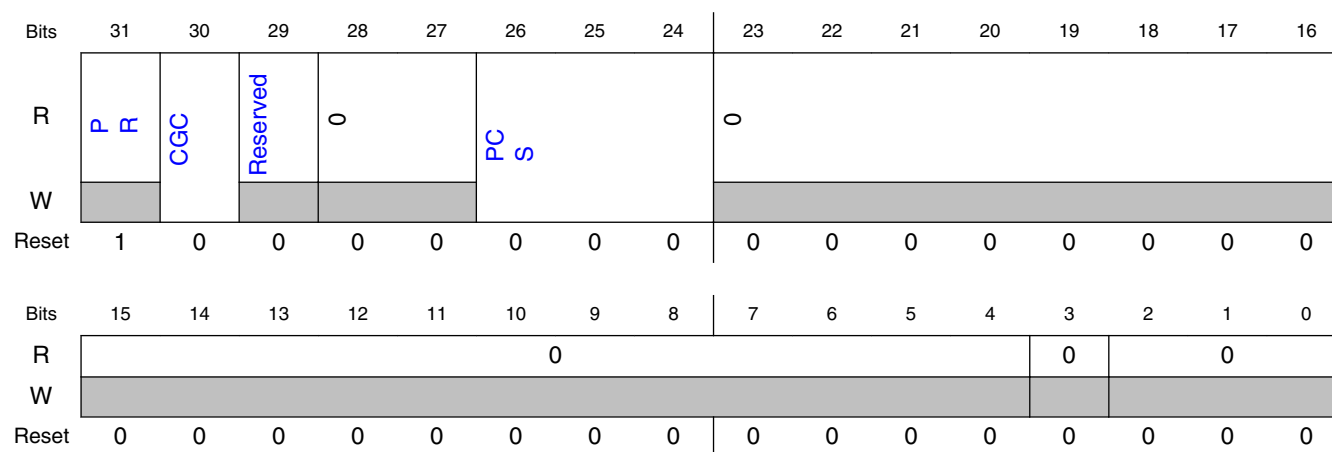

29.6.11.4 Fields

Field	Function
31 PR	Present This bit shows whether the peripheral is present on this device. 0b - Peripheral is not present. 1b - Peripheral is present.
30 CGC	Clock Gate Control This read/write bit enables the interface clock for the peripheral, allowing access to the module's registers. It also controls whether the clock selection and divider options can be modified. 0b - Clock disabled. The current clock selection and divider options are not locked and can be modified. 1b - Clock enabled. The current clock selection and divider options are locked and cannot be modified.

Table continues on the next page...

PCC register descriptions

Field	Function
29 —	This read-only bit field is reserved. This bit can change values but is a don't-care.
28-27 —	This read-only bit field is reserved and always has the value 0.
26-24 PCS	Peripheral Clock Source Select This read/write bit field is used for peripherals that support various clock selections. This field can be written only when the clock is disabled (CGC = 0). 000b - Clock is off. 001b - Clock option 1 010b - Clock option 2 011b - Clock option 3 100b - Clock option 4 101b - Clock option 5 110b - Clock option 6 111b - Clock option 7
23-4 —	This read-only bit field is reserved and always has the value 0.
3 —	This read-only bit field is reserved and always has the value 0.
2-0 —	This read-only bit field is reserved and always has the value 0.

29.6.12 PCC PDB1 Register (PCC_PDB1)

29.6.12.1 Offset

Register	Offset
PCC_PDB1	C4h

29.6.12.2 Function

This register is for the PDB1 module.

29.6.12.3 Diagram

Bits	31	30	29	28	27	26	25	24	23	22	21	20	19	18	17	16
R	P	R	CGC	Reserved	0	0	0	0	0	0	0	0	0	0	0	0
W																
Reset	1	0	0	0	0	0	0	0	0	0	0	0	0	0	0	0
Bits	15	14	13	12	11	10	9	8	7	6	5	4	3	2	1	0
R	0								0	0						
W																
Reset	0	0	0	0	0	0	0	0	0	0	0	0	0	0	0	0

29.6.12.4 Fields

Field	Function
31 PR	Present This bit shows whether the peripheral is present on this device. 0b - Peripheral is not present. 1b - Peripheral is present.
30 CGC	Clock Gate Control This read/write bit enables the interface clock for the peripheral, allowing access to the module's registers. It also controls whether the clock selection and divider options can be modified. 0b - Clock disabled. The current clock selection and divider options are not locked and can be modified. 1b - Clock enabled. The current clock selection and divider options are locked and cannot be modified.
29 —	This read-only bit field is reserved. This bit can change values but is a don't-care.
28-27 —	This read-only bit field is reserved and always has the value 0.
26-24 —	This read-only bit field is reserved and always has the value 0.
23-4 —	This read-only bit field is reserved and always has the value 0.
3 —	This read-only bit field is reserved and always has the value 0.
2-0 —	This read-only bit field is reserved and always has the value 0.

29.6.13 PCC CRC Register (PCC_CRC)

29.6.13.1 Offset

Register	Offset
PCC_CRC	C8h

29.6.13.2 Function

This register is for the CRC module.

29.6.13.3 Diagram

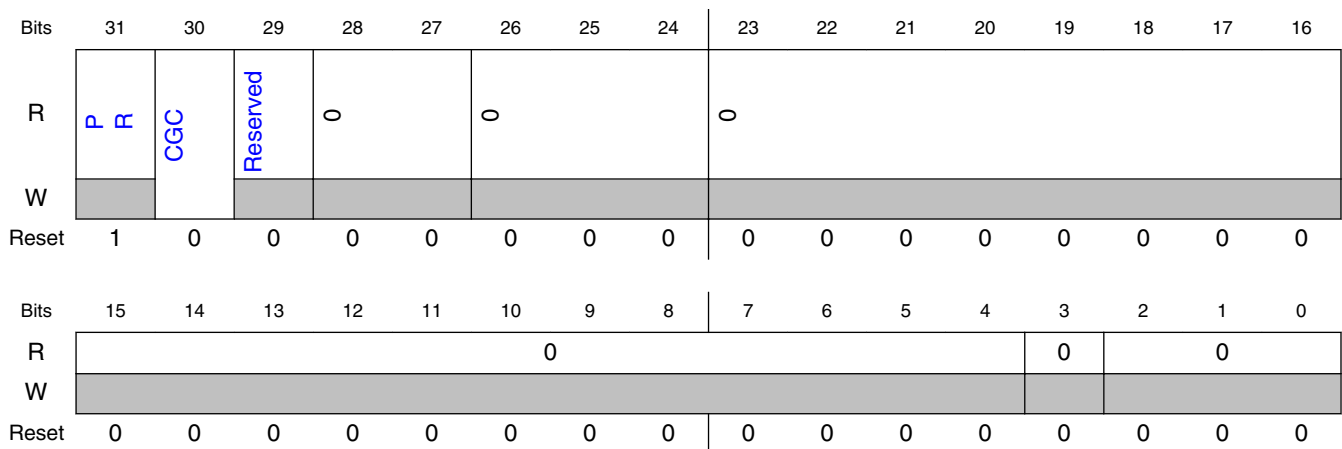

29.6.13.4 Fields

Field	Function
31 PR	Present This bit shows whether the peripheral is present on this device. 0b - Peripheral is not present. 1b - Peripheral is present.
30 CGC	Clock Gate Control

Table continues on the next page...

Field	Function
	This read/write bit enables the interface clock for the peripheral, allowing access to the module's registers. It also controls whether the clock selection and divider options can be modified. 0b - Clock disabled. The current clock selection and divider options are not locked and can be modified. 1b - Clock enabled. The current clock selection and divider options are locked and cannot be modified.
29 —	This read-only bit field is reserved. This bit can change values but is a don't-care.
28-27 —	This read-only bit field is reserved and always has the value 0.
26-24 —	This read-only bit field is reserved and always has the value 0.
23-4 —	This read-only bit field is reserved and always has the value 0.
3 —	This read-only bit field is reserved and always has the value 0.
2-0 —	This read-only bit field is reserved and always has the value 0.

29.6.14 PCC PDB0 Register (PCC_PDB0)

29.6.14.1 Offset

Register	Offset
PCC_PDB0	D8h

29.6.14.2 Function

This register is for the PDB0 module.

29.6.14.3 Diagram

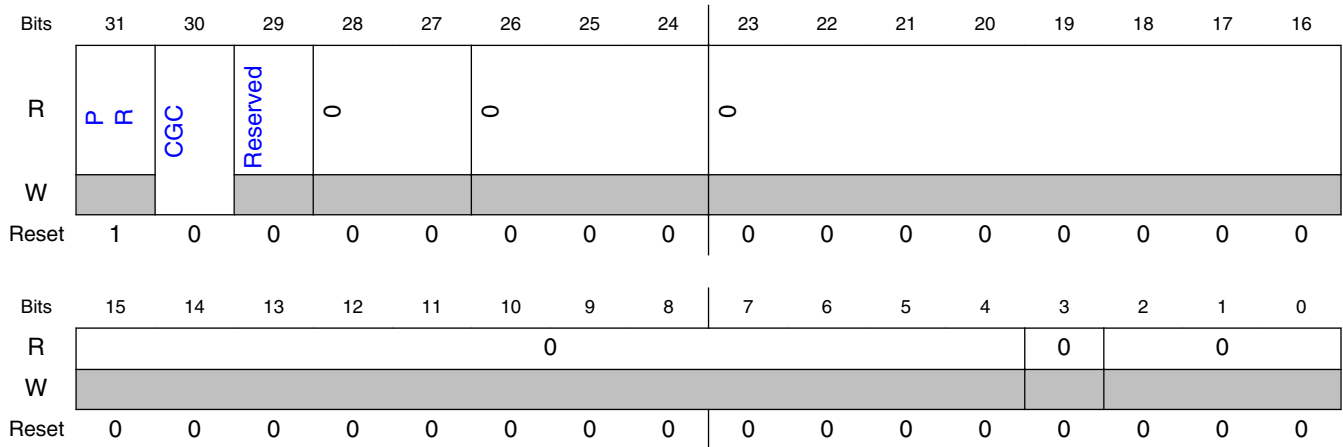

29.6.14.4 Fields

Field	Function
31 PR	Present This bit shows whether the peripheral is present on this device. 0b - Peripheral is not present. 1b - Peripheral is present.
30 CGC	Clock Gate Control This read/write bit enables the interface clock for the peripheral, allowing access to the module's registers. It also controls whether the clock selection and divider options can be modified. 0b - Clock disabled. The current clock selection and divider options are not locked and can be modified. 1b - Clock enabled. The current clock selection and divider options are locked and cannot be modified.
29 —	This read-only bit field is reserved. This bit can change values but is a don't-care.
28-27 —	This read-only bit field is reserved and always has the value 0.
26-24 —	This read-only bit field is reserved and always has the value 0.
23-4 —	This read-only bit field is reserved and always has the value 0.
3 —	This read-only bit field is reserved and always has the value 0.
2-0 —	This read-only bit field is reserved and always has the value 0.

29.6.15 PCC LPIT Register (PCC_LPIT)

29.6.15.1 Offset

Register	Offset
PCC_LPIT	DCh

29.6.15.2 Function

This register is for the LPIT module.

29.6.15.3 Diagram

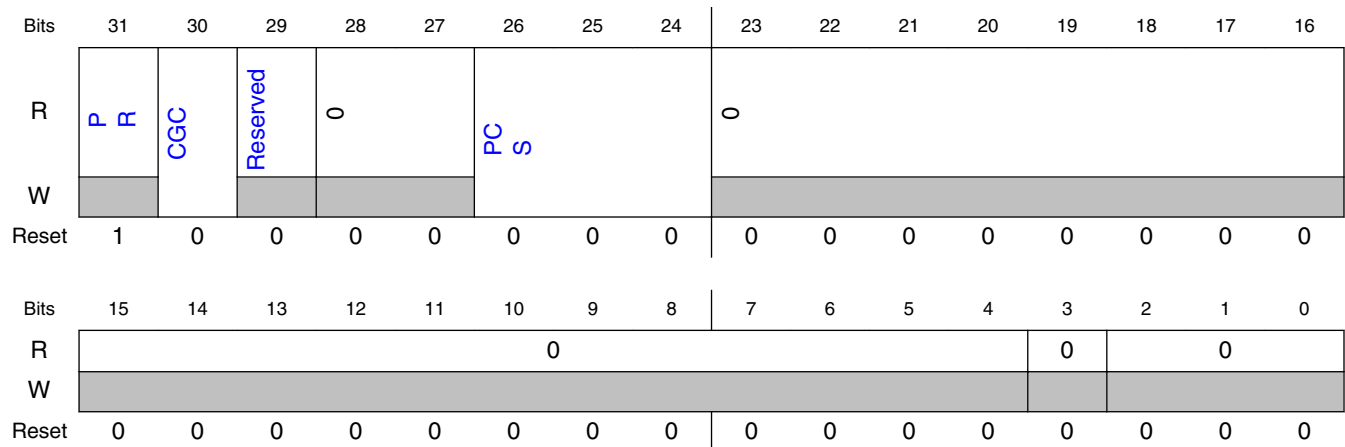

29.6.15.4 Fields

Field	Function
31 PR	Present This bit shows whether the peripheral is present on this device. 0b - Peripheral is not present. 1b - Peripheral is present.
30 CGC	Clock Gate Control

Table continues on the next page...

PCC register descriptions

Field	Function
	<p>This read/write bit enables the interface clock for the peripheral, allowing access to the module's registers. It also controls whether the clock selection and divider options can be modified.</p> <p>0b - Clock disabled. The current clock selection and divider options are not locked and can be modified.</p> <p>1b - Clock enabled. The current clock selection and divider options are locked and cannot be modified.</p>
29 —	This read-only bit field is reserved. This bit can change values but is a don't-care.
28-27 —	This read-only bit field is reserved and always has the value 0.
26-24 PCS	<p>Peripheral Clock Source Select</p> <p>This read/write bit field is used for peripherals that support various clock selections. This field can be written only when the clock is disabled (CGC = 0).</p> <p>000b - Clock is off.</p> <p>001b - Clock option 1</p> <p>010b - Clock option 2</p> <p>011b - Clock option 3</p> <p>100b - Clock option 4</p> <p>101b - Clock option 5</p> <p>110b - Clock option 6</p> <p>111b - Clock option 7</p>
23-4 —	This read-only bit field is reserved and always has the value 0.
3 —	This read-only bit field is reserved and always has the value 0.
2-0 —	This read-only bit field is reserved and always has the value 0.

29.6.16 PCC FTM0 Register (PCC_FTM0)

29.6.16.1 Offset

Register	Offset
PCC_FTM0	E0h

29.6.16.2 Function

This register is for the FTM0 module.

29.6.16.3 Diagram

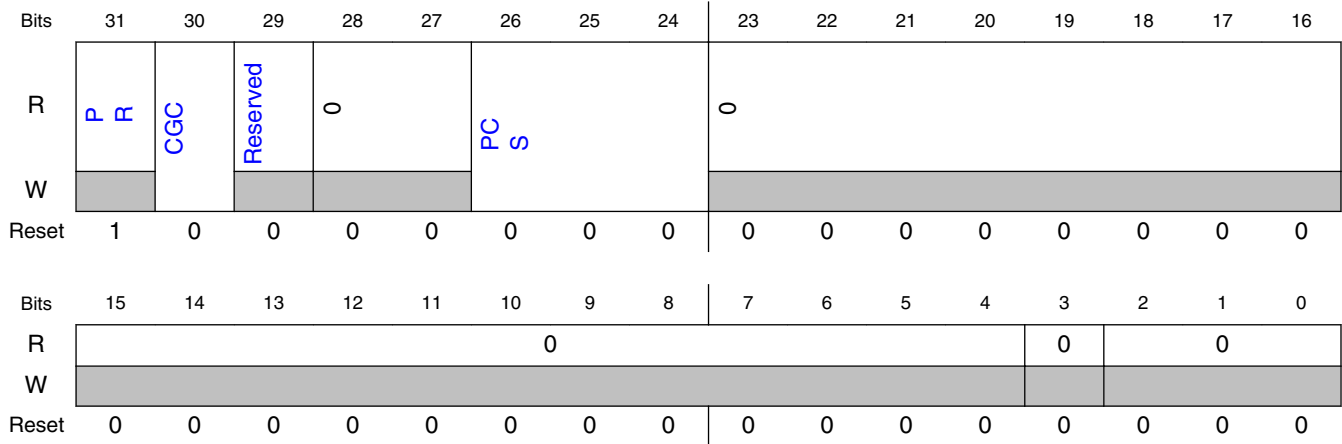

29.6.16.4 Fields

Field	Function
31 PR	Present This bit shows whether the peripheral is present on this device. 0b - Peripheral is not present. 1b - Peripheral is present.
30 CGC	Clock Gate Control This read/write bit enables the interface clock for the peripheral, allowing access to the module's registers. It also controls whether the clock selection and divider options can be modified. 0b - Clock disabled. The current clock selection and divider options are not locked and can be modified. 1b - Clock enabled. The current clock selection and divider options are locked and cannot be modified.
29 —	This read-only bit field is reserved. This bit can change values but is a don't-care.
28-27 —	This read-only bit field is reserved and always has the value 0.
26-24 PCS	Peripheral Clock Source Select This read/write bit field is used for peripherals that support various clock selections. This field can be written only when the clock is disabled (CGC = 0). 000b - Clock is off. An external clock can be enabled for this peripheral. 001b - Clock option 1 010b - Clock option 2 011b - Clock option 3 100b - Clock option 4 101b - Clock option 5

Table continues on the next page...

PCC register descriptions

Field	Function
	110b - Clock option 6 111b - Clock option 7
23-4 —	This read-only bit field is reserved and always has the value 0.
3 —	This read-only bit field is reserved and always has the value 0.
2-0 —	This read-only bit field is reserved and always has the value 0.

29.6.17 PCC FTM1 Register (PCC_FTM1)

29.6.17.1 Offset

Register	Offset
PCC_FTM1	E4h

29.6.17.2 Function

This register is for the FTM1 module.

29.6.17.3 Diagram

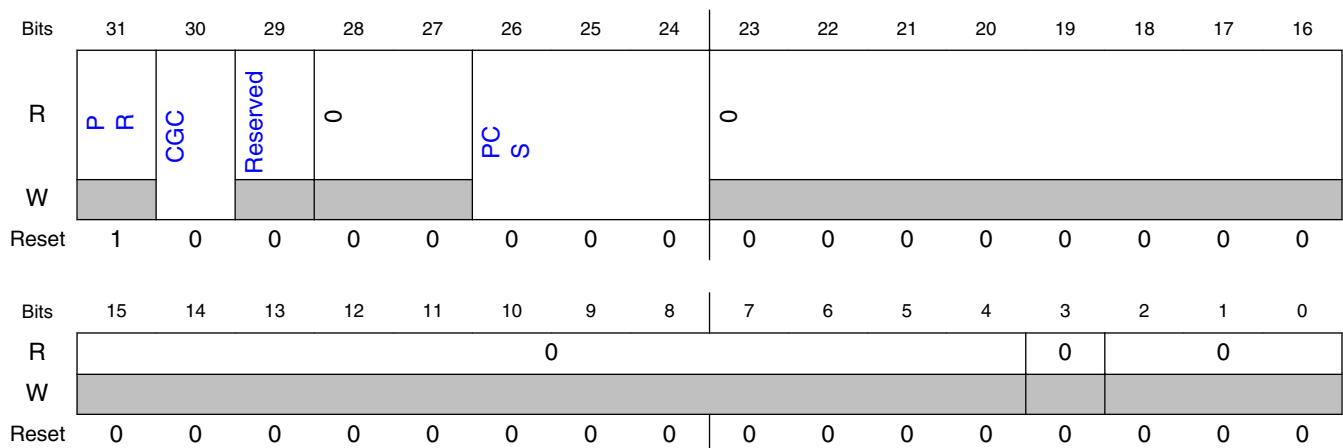

29.6.17.4 Fields

Field	Function
31 PR	Present This bit shows whether the peripheral is present on this device. 0b - Peripheral is not present. 1b - Peripheral is present.
30 CGC	Clock Gate Control This read/write bit enables the interface clock for the peripheral, allowing access to the module's registers. It also controls whether the clock selection and divider options can be modified. 0b - Clock disabled. The current clock selection and divider options are not locked and can be modified. 1b - Clock enabled. The current clock selection and divider options are locked and cannot be modified.
29 —	This read-only bit field is reserved. This bit can change values but is a don't-care.
28-27 —	This read-only bit field is reserved and always has the value 0.
26-24 PCS	Peripheral Clock Source Select This read/write bit field is used for peripherals that support various clock selections. This field can be written only when the clock is disabled (CGC = 0). 000b - Clock is off. An external clock can be enabled for this peripheral. 001b - Clock option 1 010b - Clock option 2 011b - Clock option 3 100b - Clock option 4 101b - Clock option 5 110b - Clock option 6 111b - Clock option 7
23-4 —	This read-only bit field is reserved and always has the value 0.
3 —	This read-only bit field is reserved and always has the value 0.
2-0 —	This read-only bit field is reserved and always has the value 0.

29.6.18 PCC FTM2 Register (PCC_FTM2)

29.6.18.1 Offset

Register	Offset
PCC_FTM2	E8h

29.6.18.2 Function

This register is for the FTM2 module.

29.6.18.3 Diagram

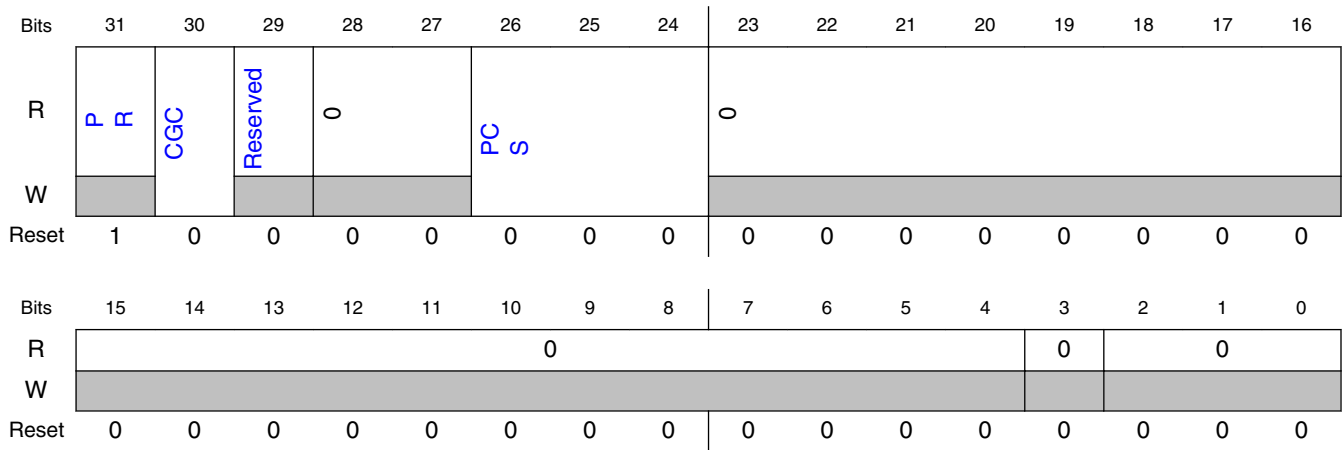

29.6.18.4 Fields

Field	Function
31 PR	Present This bit shows whether the peripheral is present on this device. 0b - Peripheral is not present. 1b - Peripheral is present.
30 CGC	Clock Gate Control This read/write bit enables the interface clock for the peripheral, allowing access to the module's registers. It also controls whether the clock selection and divider options can be modified. 0b - Clock disabled. The current clock selection and divider options are not locked and can be modified. 1b - Clock enabled. The current clock selection and divider options are locked and cannot be modified.

Table continues on the next page...

Field	Function
29 —	This read-only bit field is reserved. This bit can change values but is a don't-care.
28-27 —	This read-only bit field is reserved and always has the value 0.
26-24 PCS	Peripheral Clock Source Select This read/write bit field is used for peripherals that support various clock selections. This field can be written only when the clock is disabled (CGC = 0). 000b - Clock is off. An external clock can be enabled for this peripheral. 001b - Clock option 1 010b - Clock option 2 011b - Clock option 3 100b - Clock option 4 101b - Clock option 5 110b - Clock option 6 111b - Clock option 7
23-4 —	This read-only bit field is reserved and always has the value 0.
3 —	This read-only bit field is reserved and always has the value 0.
2-0 —	This read-only bit field is reserved and always has the value 0.

29.6.19 PCC ADC0 Register (PCC_ADC0)

29.6.19.1 Offset

Register	Offset
PCC_ADC0	ECh

29.6.19.2 Function

This register is for the ADC0 module.

29.6.19.3 Diagram

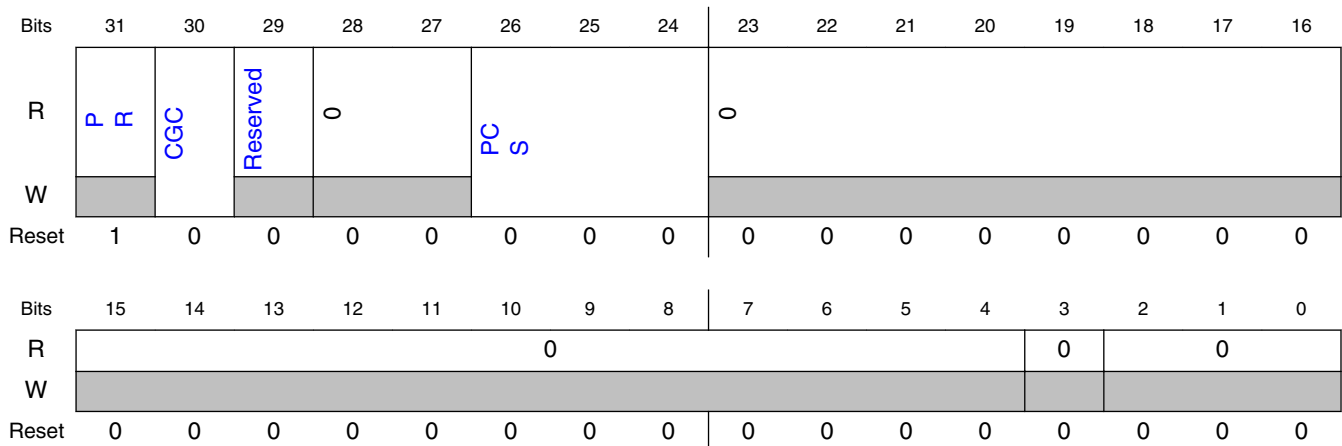

29.6.19.4 Fields

Field	Function
31 PR	Present This bit shows whether the peripheral is present on this device. 0b - Peripheral is not present. 1b - Peripheral is present.
30 CGC	Clock Gate Control This read/write bit enables the interface clock for the peripheral, allowing access to the module's registers. It also controls whether the clock selection and divider options can be modified. 0b - Clock disabled. The current clock selection and divider options are not locked and can be modified. 1b - Clock enabled. The current clock selection and divider options are locked and cannot be modified.
29 —	This read-only bit field is reserved. This bit can change values but is a don't-care.
28-27 —	This read-only bit field is reserved and always has the value 0.
26-24 PCS	Peripheral Clock Source Select This read/write bit field is used for peripherals that support various clock selections. This field can be written only when the clock is disabled (CGC = 0). 000b - Clock is off. 001b - Clock option 1 010b - Clock option 2 011b - Clock option 3 100b - Clock option 4 101b - Clock option 5 110b - Clock option 6

Table continues on the next page...

Field	Function
	111b - Clock option 7
23-4 —	This read-only bit field is reserved and always has the value 0.
3 —	This read-only bit field is reserved and always has the value 0.
2-0 —	This read-only bit field is reserved and always has the value 0.

29.6.20 PCC RTC Register (PCC_RTC)

29.6.20.1 Offset

Register	Offset
PCC_RTC	F4h

29.6.20.2 Function

This register is for the RTC module.

29.6.20.3 Diagram

Bits	31	30	29	28	27	26	25	24	23	22	21	20	19	18	17	16
R	1	0	Reserved	0	0	0	0	0	0	0	0	0	0	0	0	0
W	0	0	0	0	0	0	0	0	0	0	0	0	0	0	0	0
Reset	1	0	0	0	0	0	0	0	0	0	0	0	0	0	0	0
Bits	15	14	13	12	11	10	9	8	7	6	5	4	3	2	1	0
R	0								0	0	0	0	0	0	0	0
W	0								0	0	0	0	0	0	0	0
Reset	0	0	0	0	0	0	0	0	0	0	0	0	0	0	0	0

29.6.20.4 Fields

Field	Function
31 PR	Present This bit shows whether the peripheral is present on this device. 0b - Peripheral is not present. 1b - Peripheral is present.
30 CGC	Clock Gate Control This read/write bit enables the interface clock for the peripheral, allowing access to the module's registers. It also controls whether the clock selection and divider options can be modified. 0b - Clock disabled. The current clock selection and divider options are not locked and can be modified. 1b - Clock enabled. The current clock selection and divider options are locked and cannot be modified.
29 —	This read-only bit field is reserved. This bit can change values but is a don't-care.
28-27 —	This read-only bit field is reserved and always has the value 0.
26-24 —	This read-only bit field is reserved and always has the value 0.
23-4 —	This read-only bit field is reserved and always has the value 0.
3 —	This read-only bit field is reserved and always has the value 0.
2-0 —	This read-only bit field is reserved and always has the value 0.

29.6.21 PCC LPTMR0 Register (PCC_LPTMR0)

29.6.21.1 Offset

Register	Offset
PCC_LPTMR0	100h

29.6.21.2 Function

This register is for the LPTMR0 module.

29.6.21.3 Diagram

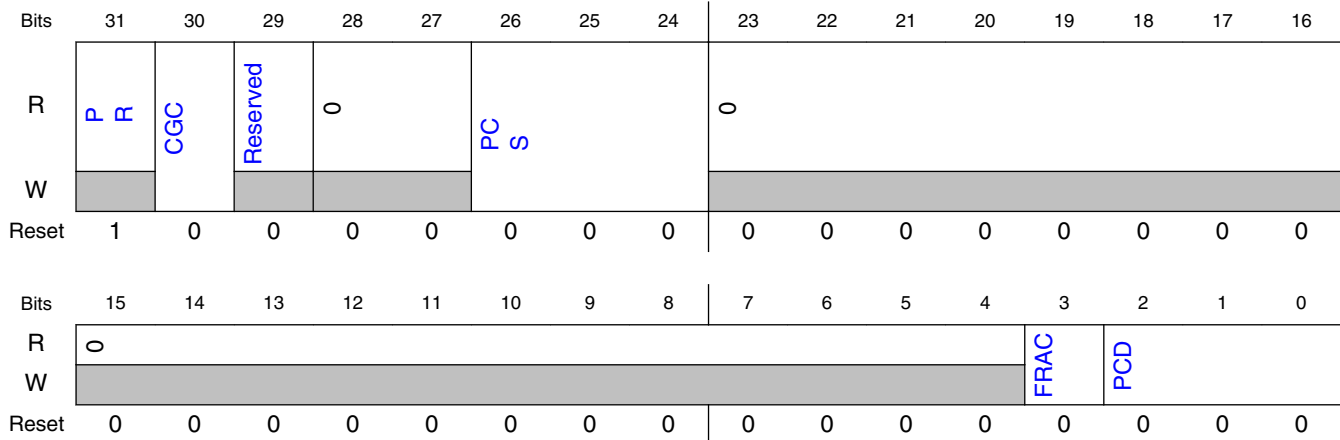

29.6.21.4 Fields

Field	Function
31 PR	Present This bit shows whether the peripheral is present on this device. 0b - Peripheral is not present. 1b - Peripheral is present.
30 CGC	Clock Gate Control This read/write bit enables the interface clock for the peripheral, allowing access to the module's registers. It also controls whether the clock selection and divider options can be modified. 0b - Clock disabled. The current clock selection and divider options are not locked and can be modified. 1b - Clock enabled. The current clock selection and divider options are locked and cannot be modified.
29 —	This read-only bit field is reserved. This bit can change values but is a don't-care.
28-27 —	This read-only bit field is reserved and always has the value 0.
26-24 PCS	Peripheral Clock Source Select This read/write bit field is used for peripherals that support various clock selections. This field can be written only when the clock is disabled (CGC = 0). 000b - Clock is off. 001b - Clock option 1 010b - Clock option 2 011b - Clock option 3 100b - Clock option 4 101b - Clock option 5

Table continues on the next page...

PCC register descriptions

Field	Function
	110b - Clock option 6 111b - Clock option 7
23-4 —	This read-only bit field is reserved and always has the value 0.
3 FRAC	Peripheral Clock Divider Fraction This read/write bit field sets the fraction multiply value for the fractional clock divider used as a clock source. Divider output clock = Divider input clock x [(FRAC+1)/(PCD+1)]. This field can be written only when the clock is disabled (CGC = 0). NOTE: When dividing by 1 (PCD = 000), do not set the FRAC bit; otherwise, the output clock is disabled. 0b - Fractional value is 0. 1b - Fractional value is 1.
2-0 PCD	Peripheral Clock Divider Select This read/write bit field is used for peripherals that require a clock divider. Divider output clock = Divider input clock x [(FRAC+1)/(PCD+1)]. This field can be written only when the clock is disabled (CGC = 0). 000b - Divide by 1. 001b - Divide by 2. 010b - Divide by 3. 011b - Divide by 4. 100b - Divide by 5. 101b - Divide by 6. 110b - Divide by 7. 111b - Divide by 8.

29.6.22 PCC PORTA Register (PCC_PORTA)

29.6.22.1 Offset

Register	Offset
PCC_PORTA	124h

29.6.22.2 Function

This register is for the PORTA module.

29.6.22.3 Diagram

Bits	31	30	29	28	27	26	25	24	23	22	21	20	19	18	17	16
R	P	R	CGC	Reserved	0	0	0	0	0	0	0	0	0	0	0	0
W																
Reset	1	0	0	0	0	0	0	0	0	0	0	0	0	0	0	0
Bits	15	14	13	12	11	10	9	8	7	6	5	4	3	2	1	0
R	0								0	0						
W																
Reset	0	0	0	0	0	0	0	0	0	0	0	0	0	0	0	0

29.6.22.4 Fields

Field	Function
31 PR	Present This bit shows whether the peripheral is present on this device. 0b - Peripheral is not present. 1b - Peripheral is present.
30 CGC	Clock Gate Control This read/write bit enables the interface clock for the peripheral, allowing access to the module's registers. It also controls whether the clock selection and divider options can be modified. 0b - Clock disabled. The current clock selection and divider options are not locked and can be modified. 1b - Clock enabled. The current clock selection and divider options are locked and cannot be modified.
29 —	This read-only bit field is reserved. This bit can change values but is a don't-care.
28-27 —	This read-only bit field is reserved and always has the value 0.
26-24 —	This read-only bit field is reserved and always has the value 0.
23-4 —	This read-only bit field is reserved and always has the value 0.
3 —	This read-only bit field is reserved and always has the value 0.
2-0 —	This read-only bit field is reserved and always has the value 0.

29.6.23 PCC PORTB Register (PCC_PORTB)

29.6.23.1 Offset

Register	Offset
PCC_PORTB	128h

29.6.23.2 Function

This register is for the PORTB module.

29.6.23.3 Diagram

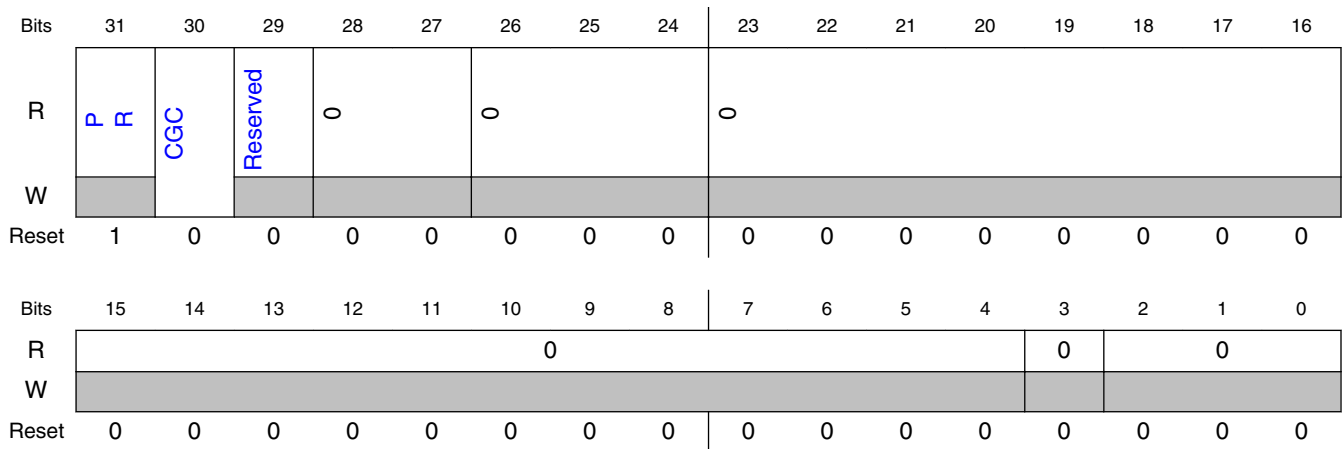

29.6.23.4 Fields

Field	Function
31 PR	Present This bit shows whether the peripheral is present on this device. 0b - Peripheral is not present. 1b - Peripheral is present.
30 CGC	Clock Gate Control

Table continues on the next page...

Field	Function
	This read/write bit enables the interface clock for the peripheral, allowing access to the module's registers. It also controls whether the clock selection and divider options can be modified. 0b - Clock disabled. The current clock selection and divider options are not locked and can be modified. 1b - Clock enabled. The current clock selection and divider options are locked and cannot be modified.
29 —	This read-only bit field is reserved. This bit can change values but is a don't-care.
28-27 —	This read-only bit field is reserved and always has the value 0.
26-24 —	This read-only bit field is reserved and always has the value 0.
23-4 —	This read-only bit field is reserved and always has the value 0.
3 —	This read-only bit field is reserved and always has the value 0.
2-0 —	This read-only bit field is reserved and always has the value 0.

29.6.24 PCC PORTC Register (PCC_PORTC)

29.6.24.1 Offset

Register	Offset
PCC_PORTC	12Ch

29.6.24.2 Function

This register is for the PORTC module.

29.6.24.3 Diagram

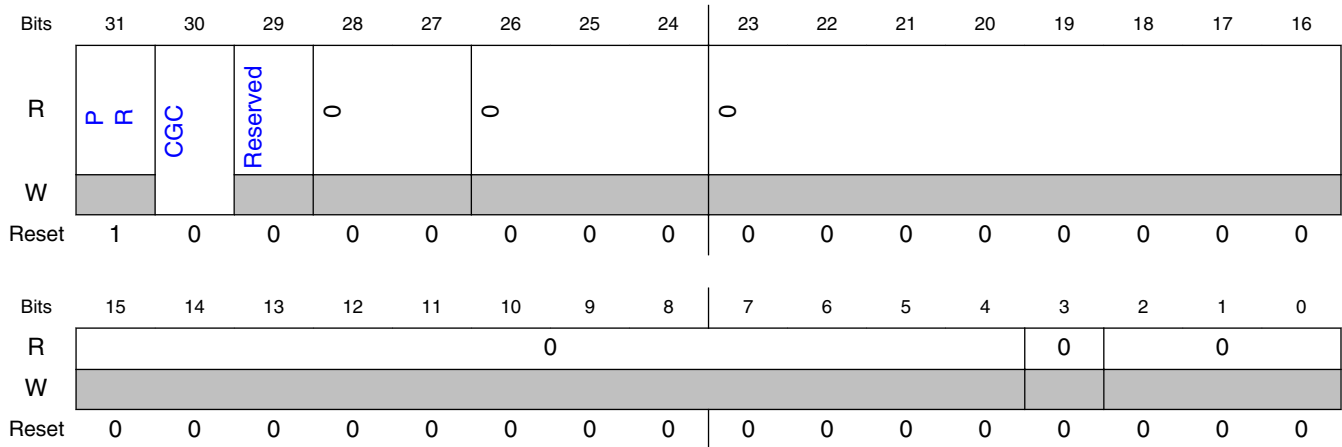

29.6.24.4 Fields

Field	Function
31 PR	Present This bit shows whether the peripheral is present on this device. 0b - Peripheral is not present. 1b - Peripheral is present.
30 CGC	Clock Gate Control This read/write bit enables the interface clock for the peripheral, allowing access to the module's registers. It also controls whether the clock selection and divider options can be modified. 0b - Clock disabled. The current clock selection and divider options are not locked and can be modified. 1b - Clock enabled. The current clock selection and divider options are locked and cannot be modified.
29 —	This read-only bit field is reserved. This bit can change values but is a don't-care.
28-27 —	This read-only bit field is reserved and always has the value 0.
26-24 —	This read-only bit field is reserved and always has the value 0.
23-4 —	This read-only bit field is reserved and always has the value 0.
3 —	This read-only bit field is reserved and always has the value 0.
2-0 —	This read-only bit field is reserved and always has the value 0.

29.6.25 PCC PORTD Register (PCC_PORTD)

29.6.25.1 Offset

Register	Offset
PCC_PORTD	130h

29.6.25.2 Function

This register is for the PORTD module.

29.6.25.3 Diagram

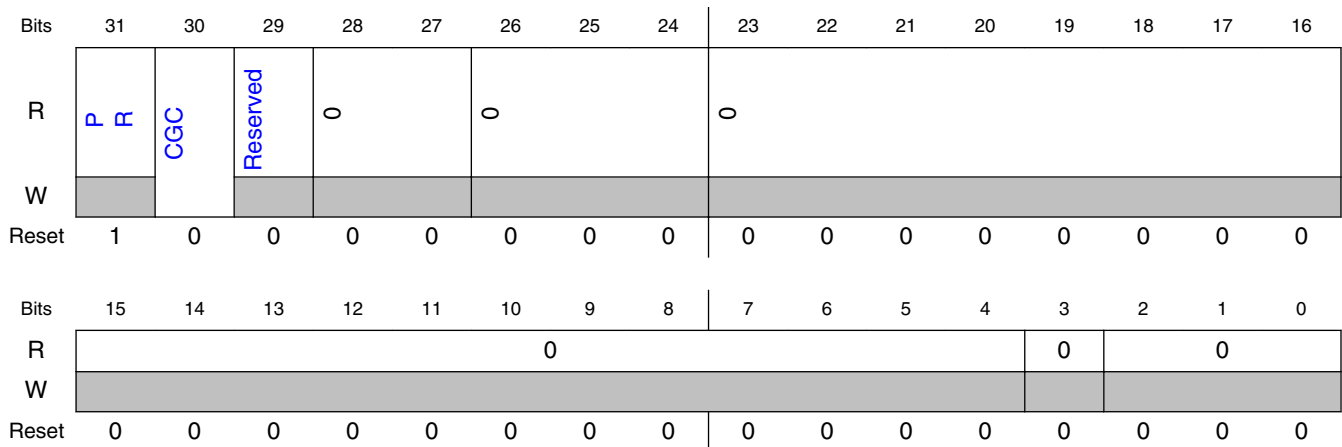

29.6.25.4 Fields

Field	Function
31 PR	Present This bit shows whether the peripheral is present on this device. 0b - Peripheral is not present. 1b - Peripheral is present.
30 CGC	Clock Gate Control

Table continues on the next page...

PCC register descriptions

Field	Function
	This read/write bit enables the interface clock for the peripheral, allowing access to the module's registers. It also controls whether the clock selection and divider options can be modified. 0b - Clock disabled. The current clock selection and divider options are not locked and can be modified. 1b - Clock enabled. The current clock selection and divider options are locked and cannot be modified.
29 —	This read-only bit field is reserved. This bit can change values but is a don't-care.
28-27 —	This read-only bit field is reserved and always has the value 0.
26-24 —	This read-only bit field is reserved and always has the value 0.
23-4 —	This read-only bit field is reserved and always has the value 0.
3 —	This read-only bit field is reserved and always has the value 0.
2-0 —	This read-only bit field is reserved and always has the value 0.

29.6.26 PCC PORTE Register (PCC_PORTE)

29.6.26.1 Offset

Register	Offset
PCC_PORTE	134h

29.6.26.2 Function

This register is for the PORTE module.

29.6.26.3 Diagram

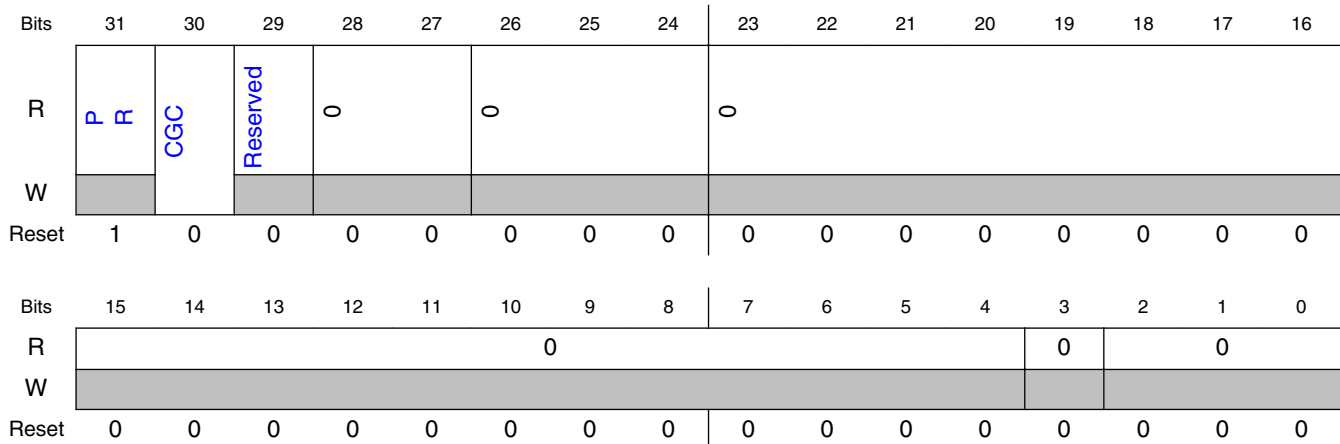

29.6.26.4 Fields

Field	Function
31 PR	Present This bit shows whether the peripheral is present on this device. 0b - Peripheral is not present. 1b - Peripheral is present.
30 CGC	Clock Gate Control This read/write bit enables the interface clock for the peripheral, allowing access to the module's registers. It also controls whether the clock selection and divider options can be modified. 0b - Clock disabled. The current clock selection and divider options are not locked and can be modified. 1b - Clock enabled. The current clock selection and divider options are locked and cannot be modified.
29 —	This read-only bit field is reserved. This bit can change values but is a don't-care.
28-27 —	This read-only bit field is reserved and always has the value 0.
26-24 —	This read-only bit field is reserved and always has the value 0.
23-4 —	This read-only bit field is reserved and always has the value 0.
3 —	This read-only bit field is reserved and always has the value 0.
2-0 —	This read-only bit field is reserved and always has the value 0.

29.6.27 PCC SAI0 Register (PCC_SAI0)

29.6.27.1 Offset

Register	Offset
PCC_SAI0	150h

29.6.27.2 Function

This register is for the SAI0 module.

29.6.27.3 Diagram

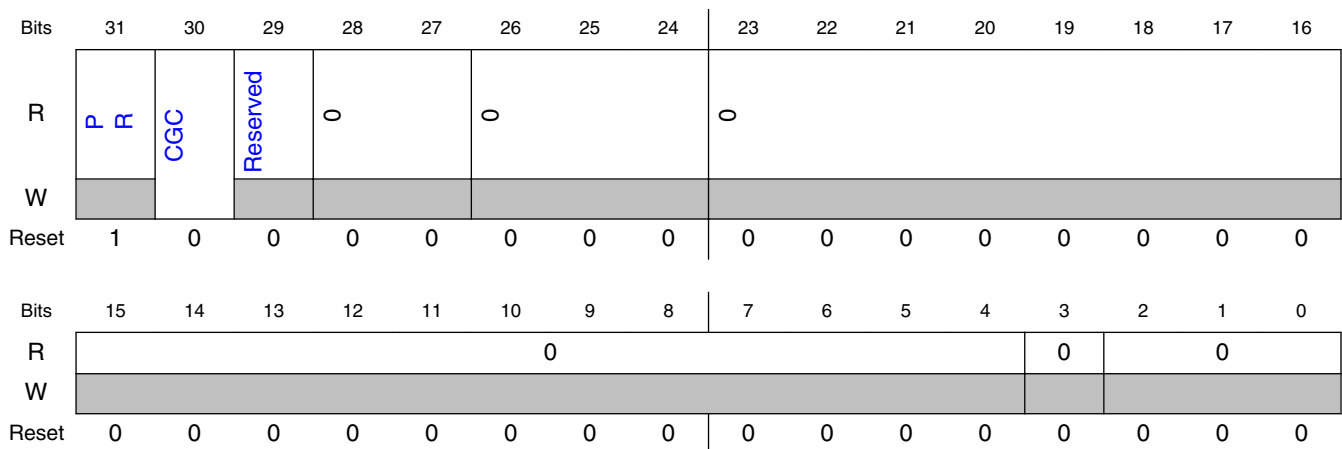

29.6.27.4 Fields

Field	Function
31 PR	Present This bit shows whether the peripheral is present on this device. 0b - Peripheral is not present. 1b - Peripheral is present.
30 CGC	Clock Gate Control

Table continues on the next page...

Field	Function
	This read/write bit enables the interface clock for the peripheral, allowing access to the module's registers. It also controls whether the clock selection and divider options can be modified. 0b - Clock disabled. The current clock selection and divider options are not locked and can be modified. 1b - Clock enabled. The current clock selection and divider options are locked and cannot be modified.
29 —	This read-only bit field is reserved. This bit can change values but is a don't-care.
28-27 —	This read-only bit field is reserved and always has the value 0.
26-24 —	This read-only bit field is reserved and always has the value 0.
23-4 —	This read-only bit field is reserved and always has the value 0.
3 —	This read-only bit field is reserved and always has the value 0.
2-0 —	This read-only bit field is reserved and always has the value 0.

29.6.28 PCC_SAI1 Register (PCC_SAI1)

29.6.28.1 Offset

Register	Offset
PCC_SAI1	154h

29.6.28.2 Function

This register is for the SAI1 module.

29.6.28.3 Diagram

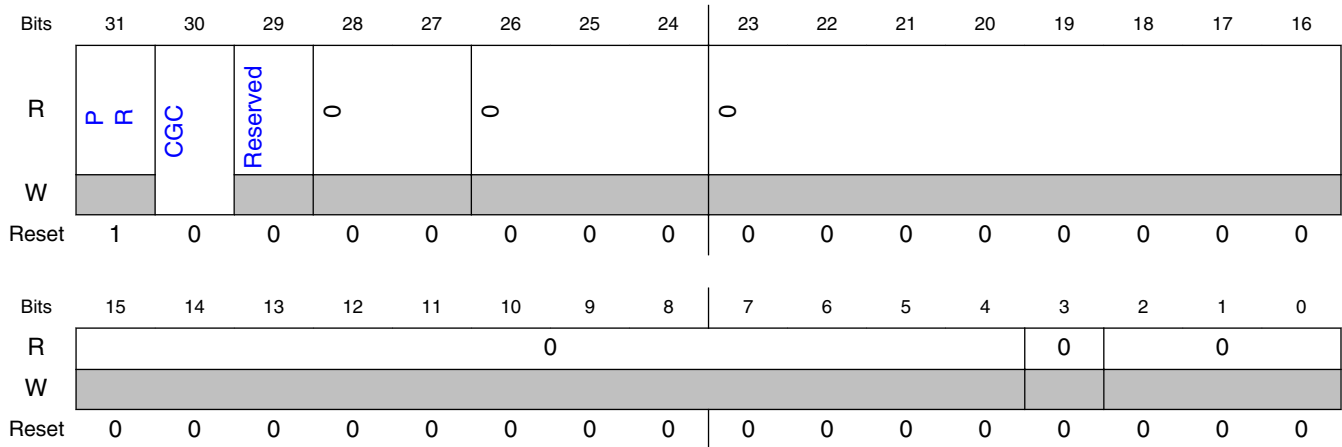

29.6.28.4 Fields

Field	Function
31 PR	Present This bit shows whether the peripheral is present on this device. 0b - Peripheral is not present. 1b - Peripheral is present.
30 CGC	Clock Gate Control This read/write bit enables the interface clock for the peripheral, allowing access to the module's registers. It also controls whether the clock selection and divider options can be modified. 0b - Clock disabled. The current clock selection and divider options are not locked and can be modified. 1b - Clock enabled. The current clock selection and divider options are locked and cannot be modified.
29 —	This read-only bit field is reserved. This bit can change values but is a don't-care.
28-27 —	This read-only bit field is reserved and always has the value 0.
26-24 —	This read-only bit field is reserved and always has the value 0.
23-4 —	This read-only bit field is reserved and always has the value 0.
3 —	This read-only bit field is reserved and always has the value 0.
2-0 —	This read-only bit field is reserved and always has the value 0.

29.6.29 PCC FlexIO Register (PCC_FlexIO)

29.6.29.1 Offset

Register	Offset
PCC_FlexIO	168h

29.6.29.2 Function

This register is for the FlexIO module.

29.6.29.3 Diagram

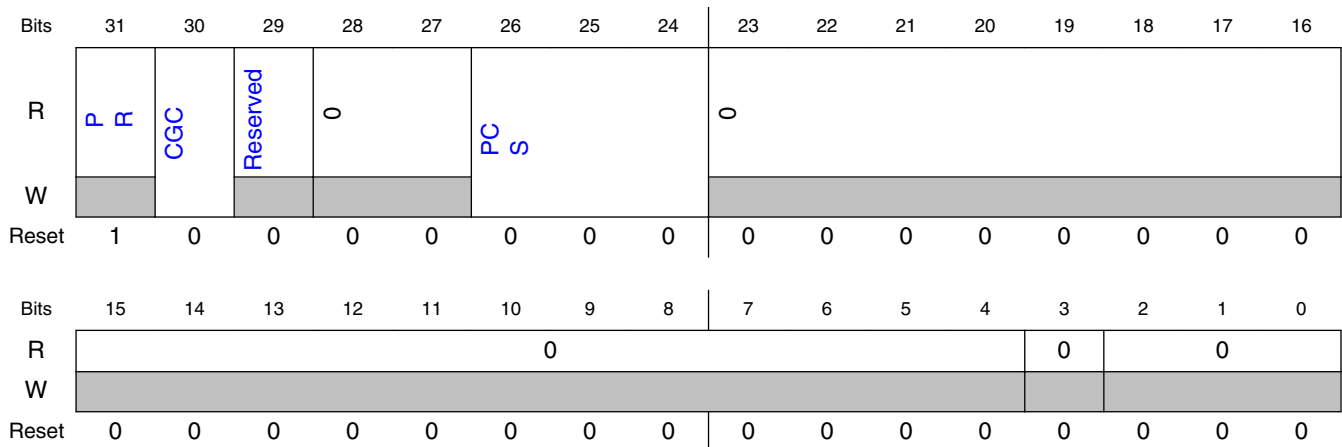

29.6.29.4 Fields

Field	Function
31 PR	Present This bit shows whether the peripheral is present on this device. 0b - Peripheral is not present. 1b - Peripheral is present.
30 CGC	Clock Gate Control

Table continues on the next page...

PCC register descriptions

Field	Function
	<p>This read/write bit enables the interface clock for the peripheral, allowing access to the module's registers. It also controls whether the clock selection and divider options can be modified.</p> <p>0b - Clock disabled. The current clock selection and divider options are not locked and can be modified.</p> <p>1b - Clock enabled. The current clock selection and divider options are locked and cannot be modified.</p>
29 —	This read-only bit field is reserved. This bit can change values but is a don't-care.
28-27 —	This read-only bit field is reserved and always has the value 0.
26-24 PCS	<p>Peripheral Clock Source Select</p> <p>This read/write bit field is used for peripherals that support various clock selections. This field can be written only when the clock is disabled (CGC = 0).</p> <p>000b - Clock is off. 001b - Clock option 1 010b - Clock option 2 011b - Clock option 3 100b - Clock option 4 101b - Clock option 5 110b - Clock option 6 111b - Clock option 7</p>
23-4 —	This read-only bit field is reserved and always has the value 0.
3 —	This read-only bit field is reserved and always has the value 0.
2-0 —	This read-only bit field is reserved and always has the value 0.

29.6.30 PCC EWM Register (PCC_EWM)

29.6.30.1 Offset

Register	Offset
PCC_EWM	184h

29.6.30.2 Function

This register is for the EWM module.

29.6.30.3 Diagram

Bits	31	30	29	28	27	26	25	24	23	22	21	20	19	18	17	16
R	PR	CGC	Reserved	0		0			0							
W																
Reset	1	0	0	0	0	0	0	0	0	0	0	0	0	0	0	0

Bits	15	14	13	12	11	10	9	8	7	6	5	4	3	2	1	0
R	0								0	0						
W																
Reset	0	0	0	0	0	0	0	0	0	0	0	0	0	0	0	0

29.6.30.4 Fields

Field	Function
31 PR	Present This bit shows whether the peripheral is present on this device. 0b - Peripheral is not present. 1b - Peripheral is present.
30 CGC	Clock Gate Control This read/write bit enables the interface clock for the peripheral, allowing access to the module's registers. It also controls whether the clock selection and divider options can be modified. 0b - Clock disabled. The current clock selection and divider options are not locked and can be modified. 1b - Clock enabled. The current clock selection and divider options are locked and cannot be modified.
29 —	This read-only bit field is reserved. This bit can change values but is a don't-care.
28-27 —	This read-only bit field is reserved and always has the value 0.
26-24 —	This read-only bit field is reserved and always has the value 0.
23-4 —	This read-only bit field is reserved and always has the value 0.
3 —	This read-only bit field is reserved and always has the value 0.
2-0 —	This read-only bit field is reserved and always has the value 0.

29.6.31 PCC LPI2C0 Register (PCC_LPI2C0)

29.6.31.1 Offset

Register	Offset
PCC_LPI2C0	198h

29.6.31.2 Function

This register is for the LPI2C0 module.

29.6.31.3 Diagram

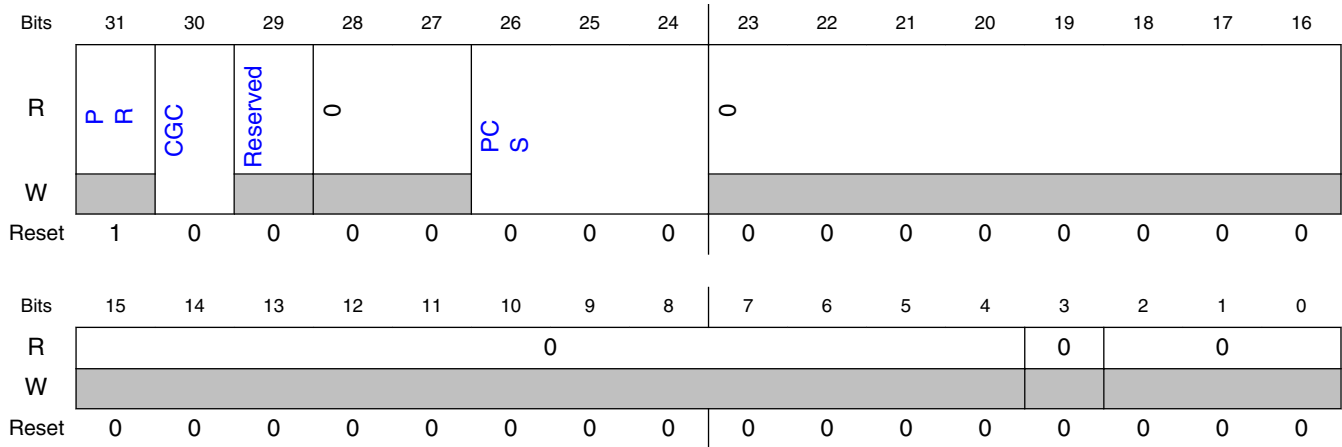

29.6.31.4 Fields

Field	Function
31 PR	Present This bit shows whether the peripheral is present on this device. 0b - Peripheral is not present. 1b - Peripheral is present.
30	Clock Gate Control

Table continues on the next page...

Field	Function
CGC	This read/write bit enables the interface clock for the peripheral, allowing access to the module's registers. It also controls whether the clock selection and divider options can be modified. 0b - Clock disabled. The current clock selection and divider options are not locked and can be modified. 1b - Clock enabled. The current clock selection and divider options are locked and cannot be modified.
29 —	This read-only bit field is reserved. This bit can change values but is a don't-care.
28-27 —	This read-only bit field is reserved and always has the value 0.
26-24 PCS	Peripheral Clock Source Select This read/write bit field is used for peripherals that support various clock selections. This field can be written only when the clock is disabled (CGC = 0). 000b - Clock is off. 001b - Clock option 1 010b - Clock option 2 011b - Clock option 3 100b - Clock option 4 101b - Clock option 5 110b - Clock option 6 111b - Clock option 7
23-4 —	This read-only bit field is reserved and always has the value 0.
3 —	This read-only bit field is reserved and always has the value 0.
2-0 —	This read-only bit field is reserved and always has the value 0.

29.6.32 PCC LPI2C1 Register (PCC_LPI2C1)

29.6.32.1 Offset

Register	Offset
PCC_LPI2C1	19Ch

29.6.32.2 Function

This register is for the LPI2C1 module.

29.6.32.3 Diagram

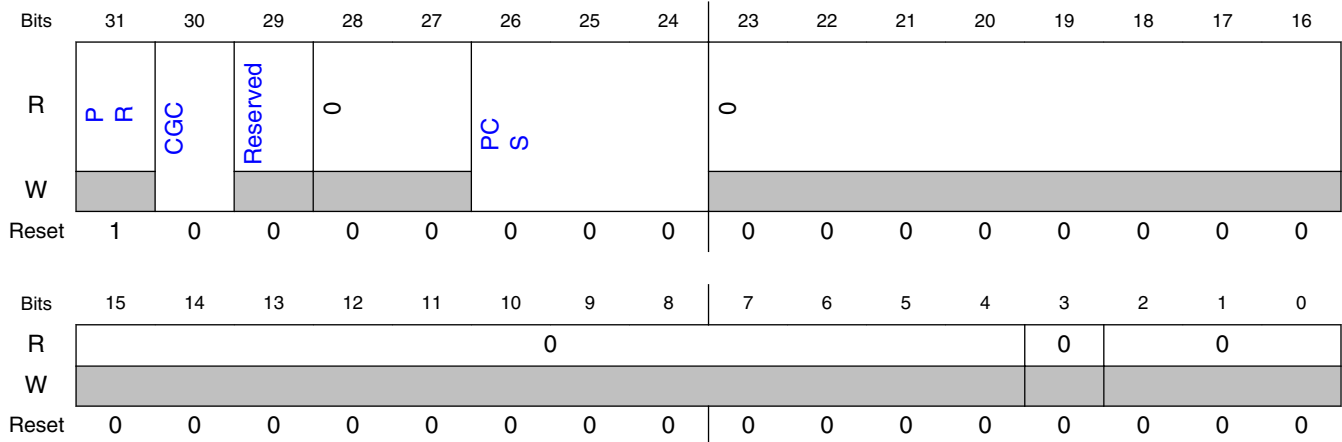

29.6.32.4 Fields

Field	Function
31 PR	Present This bit shows whether the peripheral is present on this device. 0b - Peripheral is not present. 1b - Peripheral is present.
30 CGC	Clock Gate Control This read/write bit enables the interface clock for the peripheral, allowing access to the module's registers. It also controls whether the clock selection and divider options can be modified. 0b - Clock disabled. The current clock selection and divider options are not locked and can be modified. 1b - Clock enabled. The current clock selection and divider options are locked and cannot be modified.
29 —	This read-only bit field is reserved. This bit can change values but is a don't-care.
28-27 —	This read-only bit field is reserved and always has the value 0.
26-24 PCS	Peripheral Clock Source Select This read/write bit field is used for peripherals that support various clock selections. This field can be written only when the clock is disabled (CGC = 0). 000b - Clock is off. 001b - Clock option 1 010b - Clock option 2 011b - Clock option 3 100b - Clock option 4 101b - Clock option 5

Table continues on the next page...

Field	Function
	110b - Clock option 6 111b - Clock option 7
23-4 —	This read-only bit field is reserved and always has the value 0.
3 —	This read-only bit field is reserved and always has the value 0.
2-0 —	This read-only bit field is reserved and always has the value 0.

29.6.33 PCC LPUART0 Register (PCC_LPUART0)

29.6.33.1 Offset

Register	Offset
PCC_LPUART0	1A8h

29.6.33.2 Function

This register is for the LPUART0 module.

29.6.33.3 Diagram

Bits	31	30	29	28	27	26	25	24	23	22	21	20	19	18	17	16
R	0	0	Reserved	0	0	0	0	0	0	0	0	0	0	0	0	0
W	0	0	0	0	0	0	0	0	0	0	0	0	0	0	0	0
Reset	1	0	0	0	0	0	0	0	0	0	0	0	0	0	0	0
Bits	15	14	13	12	11	10	9	8	7	6	5	4	3	2	1	0
R	0	0	0	0	0	0	0	0	0	0	0	0	0	0	0	0
W	0	0	0	0	0	0	0	0	0	0	0	0	0	0	0	0
Reset	0	0	0	0	0	0	0	0	0	0	0	0	0	0	0	0

29.6.33.4 Fields

Field	Function
31 PR	Present This bit shows whether the peripheral is present on this device. 0b - Peripheral is not present. 1b - Peripheral is present.
30 CGC	Clock Gate Control This read/write bit enables the interface clock for the peripheral, allowing access to the module's registers. It also controls whether the clock selection and divider options can be modified. 0b - Clock disabled. The current clock selection and divider options are not locked and can be modified. 1b - Clock enabled. The current clock selection and divider options are locked and cannot be modified.
29 —	This read-only bit field is reserved. This bit can change values but is a don't-care.
28-27 —	This read-only bit field is reserved and always has the value 0.
26-24 PCS	Peripheral Clock Source Select This read/write bit field is used for peripherals that support various clock selections. This field can be written only when the clock is disabled (CGC = 0). 000b - Clock is off. 001b - Clock option 1 010b - Clock option 2 011b - Clock option 3 100b - Clock option 4 101b - Clock option 5 110b - Clock option 6 111b - Clock option 7
23-4 —	This read-only bit field is reserved and always has the value 0.
3 —	This read-only bit field is reserved and always has the value 0.
2-0 —	This read-only bit field is reserved and always has the value 0.

29.6.34 PCC LPUART1 Register (PCC_LPUART1)

29.6.34.1 Offset

Register	Offset
PCC_LPUART1	1ACh

29.6.34.2 Function

This register is for the LPUART1 module.

29.6.34.3 Diagram

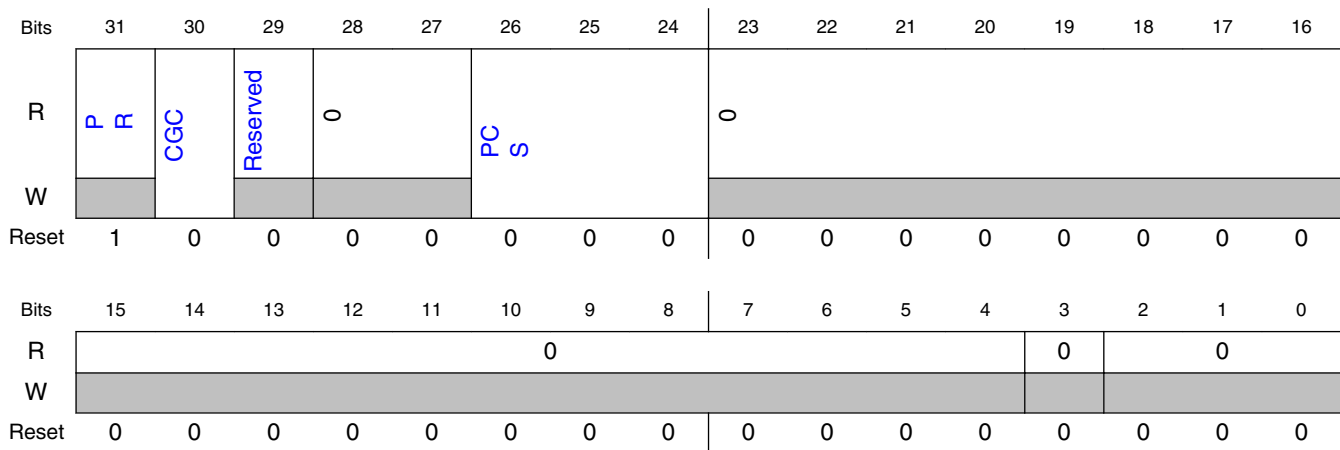

29.6.34.4 Fields

Field	Function
31 PR	Present This bit shows whether the peripheral is present on this device. 0b - Peripheral is not present. 1b - Peripheral is present.
30 CGC	Clock Gate Control This read/write bit enables the interface clock for the peripheral, allowing access to the module's registers. It also controls whether the clock selection and divider options can be modified. 0b - Clock disabled. The current clock selection and divider options are not locked and can be modified. 1b - Clock enabled. The current clock selection and divider options are locked and cannot be modified.

Table continues on the next page...

PCC register descriptions

Field	Function
29 —	This read-only bit field is reserved. This bit can change values but is a don't-care.
28-27 —	This read-only bit field is reserved and always has the value 0.
26-24 PCS	Peripheral Clock Source Select This read/write bit field is used for peripherals that support various clock selections. This field can be written only when the clock is disabled (CGC = 0). 000b - Clock is off. 001b - Clock option 1 010b - Clock option 2 011b - Clock option 3 100b - Clock option 4 101b - Clock option 5 110b - Clock option 6 111b - Clock option 7
23-4 —	This read-only bit field is reserved and always has the value 0.
3 —	This read-only bit field is reserved and always has the value 0.
2-0 —	This read-only bit field is reserved and always has the value 0.

29.6.35 PCC LPUART2 Register (PCC_LPUART2)

29.6.35.1 Offset

Register	Offset
PCC_LPUART2	1B0h

29.6.35.2 Function

This register is for the LPUART2 module.

29.6.35.3 Diagram

Bits	31	30	29	28	27	26	25	24	23	22	21	20	19	18	17	16	
R	P	R	CGC	Reserved	0	PCS			0								
W																	
Reset	1	0	0	0	0	0	0	0	0	0	0	0	0	0	0	0	
Bits	15	14	13	12	11	10	9	8	7	6	5	4	3	2	1	0	
R	0								0	0							
W																	
Reset	0	0	0	0	0	0	0	0	0	0	0	0	0	0	0	0	

29.6.35.4 Fields

Field	Function
31 PR	Present This bit shows whether the peripheral is present on this device. 0b - Peripheral is not present. 1b - Peripheral is present.
30 CGC	Clock Gate Control This read/write bit enables the interface clock for the peripheral, allowing access to the module's registers. It also controls whether the clock selection and divider options can be modified. 0b - Clock disabled. The current clock selection and divider options are not locked and can be modified. 1b - Clock enabled. The current clock selection and divider options are locked and cannot be modified.
29 —	This read-only bit field is reserved. This bit can change values but is a don't-care.
28-27 —	This read-only bit field is reserved and always has the value 0.
26-24 PCS	Peripheral Clock Source Select This read/write bit field is used for peripherals that support various clock selections. This field can be written only when the clock is disabled (CGC = 0). 000b - Clock is off. 001b - Clock option 1 010b - Clock option 2 011b - Clock option 3 100b - Clock option 4 101b - Clock option 5 110b - Clock option 6

Table continues on the next page...

PCC register descriptions

Field	Function
	111b - Clock option 7
23-4 —	This read-only bit field is reserved and always has the value 0.
3 —	This read-only bit field is reserved and always has the value 0.
2-0 —	This read-only bit field is reserved and always has the value 0.

29.6.36 PCC FTM4 Register (PCC_FTM4)

29.6.36.1 Offset

Register	Offset
PCC_FTM4	1B8h

29.6.36.2 Function

This register is for the FTM4 module.

29.6.36.3 Diagram

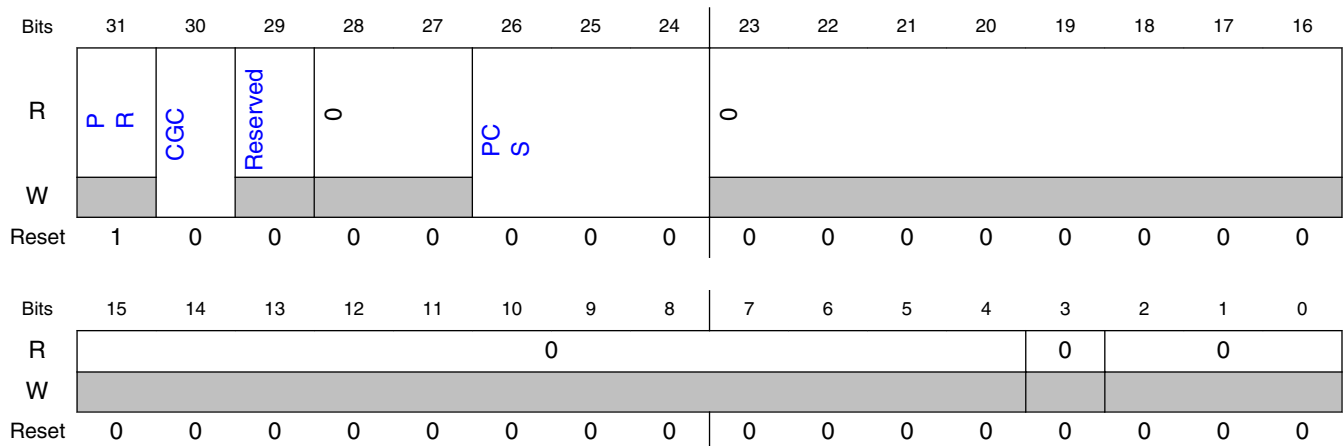

29.6.36.4 Fields

Field	Function
31 PR	Present This bit shows whether the peripheral is present on this device. 0b - Peripheral is not present. 1b - Peripheral is present.
30 CGC	Clock Gate Control This read/write bit enables the interface clock for the peripheral, allowing access to the module's registers. It also controls whether the clock selection and divider options can be modified. 0b - Clock disabled. The current clock selection and divider options are not locked and can be modified. 1b - Clock enabled. The current clock selection and divider options are locked and cannot be modified.
29 —	This read-only bit field is reserved. This bit can change values but is a don't-care.
28-27 —	This read-only bit field is reserved and always has the value 0.
26-24 PCS	Peripheral Clock Source Select This read/write bit field is used for peripherals that support various clock selections. This field can be written only when the clock is disabled (CGC = 0). 000b - Clock is off. An external clock can be enabled for this peripheral. 001b - Clock option 1 010b - Clock option 2 011b - Clock option 3 100b - Clock option 4 101b - Clock option 5 110b - Clock option 6 111b - Clock option 7
23-4 —	This read-only bit field is reserved and always has the value 0.
3 —	This read-only bit field is reserved and always has the value 0.
2-0 —	This read-only bit field is reserved and always has the value 0.

29.6.37 PCC FTM5 Register (PCC_FTM5)

29.6.37.1 Offset

Register	Offset
PCC_FTM5	1BCh

29.6.37.2 Function

This register is for the FTM5 module.

29.6.37.3 Diagram

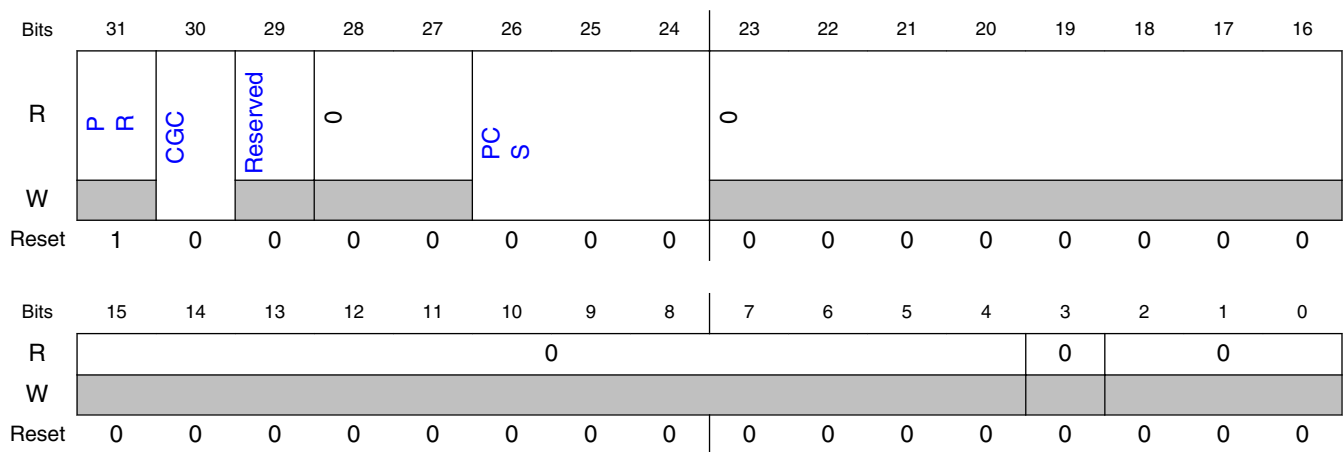

29.6.37.4 Fields

Field	Function
31 PR	Present This bit shows whether the peripheral is present on this device. 0b - Peripheral is not present. 1b - Peripheral is present.
30 CGC	Clock Gate Control This read/write bit enables the interface clock for the peripheral, allowing access to the module's registers. It also controls whether the clock selection and divider options can be modified. 0b - Clock disabled. The current clock selection and divider options are not locked and can be modified. 1b - Clock enabled. The current clock selection and divider options are locked and cannot be modified.

Table continues on the next page...

Field	Function
29 —	This read-only bit field is reserved. This bit can change values but is a don't-care.
28-27 —	This read-only bit field is reserved and always has the value 0.
26-24 PCS	Peripheral Clock Source Select This read/write bit field is used for peripherals that support various clock selections. This field can be written only when the clock is disabled (CGC = 0). 000b - Clock is off. An external clock can be enabled for this peripheral. 001b - Clock option 1 010b - Clock option 2 011b - Clock option 3 100b - Clock option 4 101b - Clock option 5 110b - Clock option 6 111b - Clock option 7
23-4 —	This read-only bit field is reserved and always has the value 0.
3 —	This read-only bit field is reserved and always has the value 0.
2-0 —	This read-only bit field is reserved and always has the value 0.

29.6.38 PCC FTM6 Register (PCC_FTM6)

29.6.38.1 Offset

Register	Offset
PCC_FTM6	1C0h

29.6.38.2 Function

This register is for the FTM6 module.

29.6.38.3 Diagram

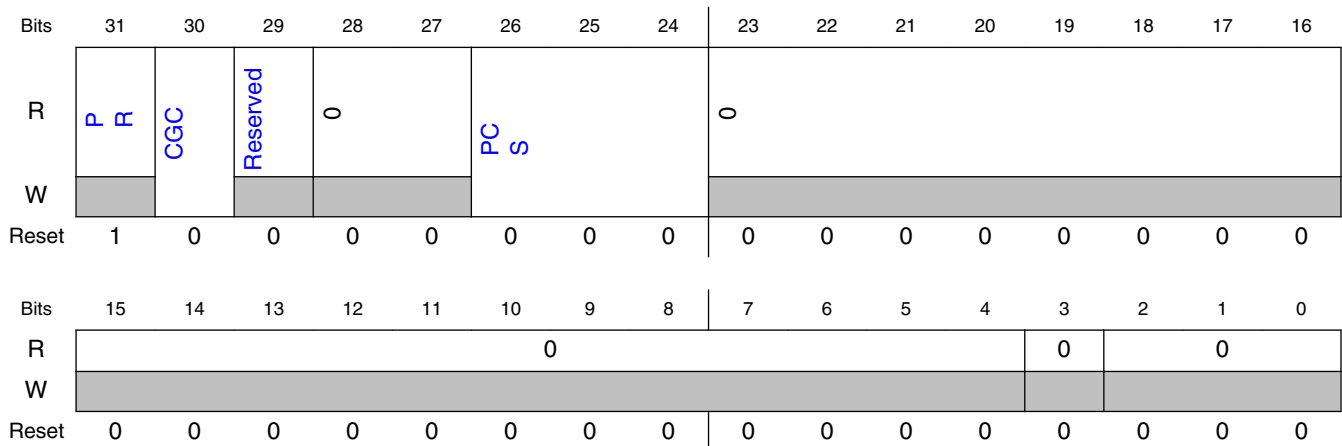

29.6.38.4 Fields

Field	Function
31 PR	Present This bit shows whether the peripheral is present on this device. 0b - Peripheral is not present. 1b - Peripheral is present.
30 CGC	Clock Gate Control This read/write bit enables the interface clock for the peripheral, allowing access to the module's registers. It also controls whether the clock selection and divider options can be modified. 0b - Clock disabled. The current clock selection and divider options are not locked and can be modified. 1b - Clock enabled. The current clock selection and divider options are locked and cannot be modified.
29 —	This read-only bit field is reserved. This bit can change values but is a don't-care.
28-27 —	This read-only bit field is reserved and always has the value 0.
26-24 PCS	Peripheral Clock Source Select This read/write bit field is used for peripherals that support various clock selections. This field can be written only when the clock is disabled (CGC = 0). 000b - Clock is off. An external clock can be enabled for this peripheral. 001b - Clock option 1 010b - Clock option 2 011b - Clock option 3 100b - Clock option 4 101b - Clock option 5 110b - Clock option 6

Table continues on the next page...

Field	Function
	111b - Clock option 7
23-4 —	This read-only bit field is reserved and always has the value 0.
3 —	This read-only bit field is reserved and always has the value 0.
2-0 —	This read-only bit field is reserved and always has the value 0.

29.6.39 PCC FTM7 Register (PCC_FTM7)

29.6.39.1 Offset

Register	Offset
PCC_FTM7	1C4h

29.6.39.2 Function

This register is for the FTM7 module.

29.6.39.3 Diagram

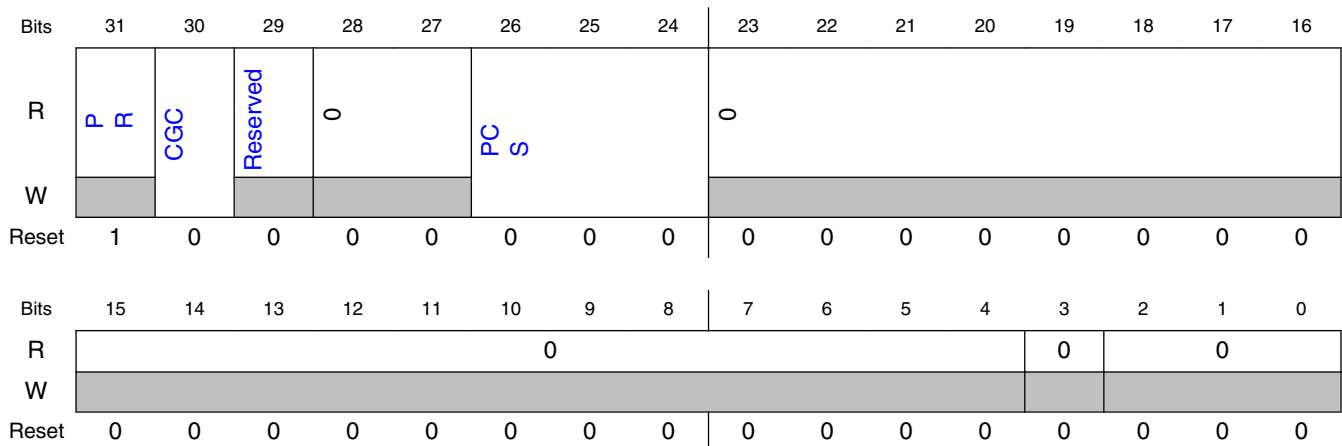

29.6.39.4 Fields

Field	Function
31 PR	Present This bit shows whether the peripheral is present on this device. 0b - Peripheral is not present. 1b - Peripheral is present.
30 CGC	Clock Gate Control This read/write bit enables the interface clock for the peripheral, allowing access to the module's registers. It also controls whether the clock selection and divider options can be modified. 0b - Clock disabled. The current clock selection and divider options are not locked and can be modified. 1b - Clock enabled. The current clock selection and divider options are locked and cannot be modified.
29 —	This read-only bit field is reserved. This bit can change values but is a don't-care.
28-27 —	This read-only bit field is reserved and always has the value 0.
26-24 PCS	Peripheral Clock Source Select This read/write bit field is used for peripherals that support various clock selections. This field can be written only when the clock is disabled (CGC = 0). 000b - Clock is off. An external clock can be enabled for this peripheral. 001b - Clock option 1 010b - Clock option 2 011b - Clock option 3 100b - Clock option 4 101b - Clock option 5 110b - Clock option 6 111b - Clock option 7
23-4 —	This read-only bit field is reserved and always has the value 0.
3 —	This read-only bit field is reserved and always has the value 0.
2-0 —	This read-only bit field is reserved and always has the value 0.

29.6.40 PCC CMP0 Register (PCC_CMP0)

29.6.40.1 Offset

Register	Offset
PCC_CMP0	1CCh

29.6.40.2 Function

This register is for the CMP0 module.

29.6.40.3 Diagram

Bits	31	30	29	28	27	26	25	24	23	22	21	20	19	18	17	16
R	PR	CGC	Reserved	0		0			0							
W																
Reset	1	0	0	0	0	0	0	0	0	0	0	0	0	0	0	0
Bits	15	14	13	12	11	10	9	8	7	6	5	4	3	2	1	0
R	0												0		0	
W																
Reset	0	0	0	0	0	0	0	0	0	0	0	0	0	0	0	0

29.6.40.4 Fields

Field	Function
31 PR	Present This bit shows whether the peripheral is present on this device. 0b - Peripheral is not present. 1b - Peripheral is present.
30 CGC	Clock Gate Control This read/write bit enables the interface clock for the peripheral, allowing access to the module's registers. It also controls whether the clock selection and divider options can be modified. 0b - Clock disabled. The current clock selection and divider options are not locked and can be modified. 1b - Clock enabled. The current clock selection and divider options are locked and cannot be modified.

Table continues on the next page...

PCC register descriptions

Field	Function
29 —	This read-only bit field is reserved. This bit can change values but is a don't-care.
28-27 —	This read-only bit field is reserved and always has the value 0.
26-24 —	This read-only bit field is reserved and always has the value 0.
23-4 —	This read-only bit field is reserved and always has the value 0.
3 —	This read-only bit field is reserved and always has the value 0.
2-0 —	This read-only bit field is reserved and always has the value 0.

29.6.41 PCC QSPI Register (PCC_QSPI)

29.6.41.1 Offset

Register	Offset
PCC_QSPI	1D8h

29.6.41.2 Function

This register is for the QSPI module.

29.6.41.3 Diagram

Bits	31	30	29	28	27	26	25	24	23	22	21	20	19	18	17	16
R	P	R	CGC	Reserved	0	0	0	0	0	0	0	0	0	0	0	0
W																
Reset	1	0	0	0	0	0	0	0	0	0	0	0	0	0	0	0
Bits	15	14	13	12	11	10	9	8	7	6	5	4	3	2	1	0
R	0								0	0						
W																
Reset	0	0	0	0	0	0	0	0	0	0	0	0	0	0	0	0

29.6.41.4 Fields

Field	Function
31 PR	Present This bit shows whether the peripheral is present on this device. 0b - Peripheral is not present. 1b - Peripheral is present.
30 CGC	Clock Gate Control This read/write bit enables the interface clock for the peripheral, allowing access to the module's registers. It also controls whether the clock selection and divider options can be modified. 0b - Clock disabled. The current clock selection and divider options are not locked and can be modified. 1b - Clock enabled. The current clock selection and divider options are locked and cannot be modified.
29 —	This read-only bit field is reserved. This bit can change values but is a don't-care.
28-27 —	This read-only bit field is reserved and always has the value 0.
26-24 —	This read-only bit field is reserved and always has the value 0.
23-4 —	This read-only bit field is reserved and always has the value 0.
3 —	This read-only bit field is reserved and always has the value 0.
2-0 —	This read-only bit field is reserved and always has the value 0.

29.6.42 PCC ENET Register (PCC_ENET)

29.6.42.1 Offset

Register	Offset
PCC_ENET	1E4h

29.6.42.2 Function

This register is for the ENET module.

29.6.42.3 Diagram

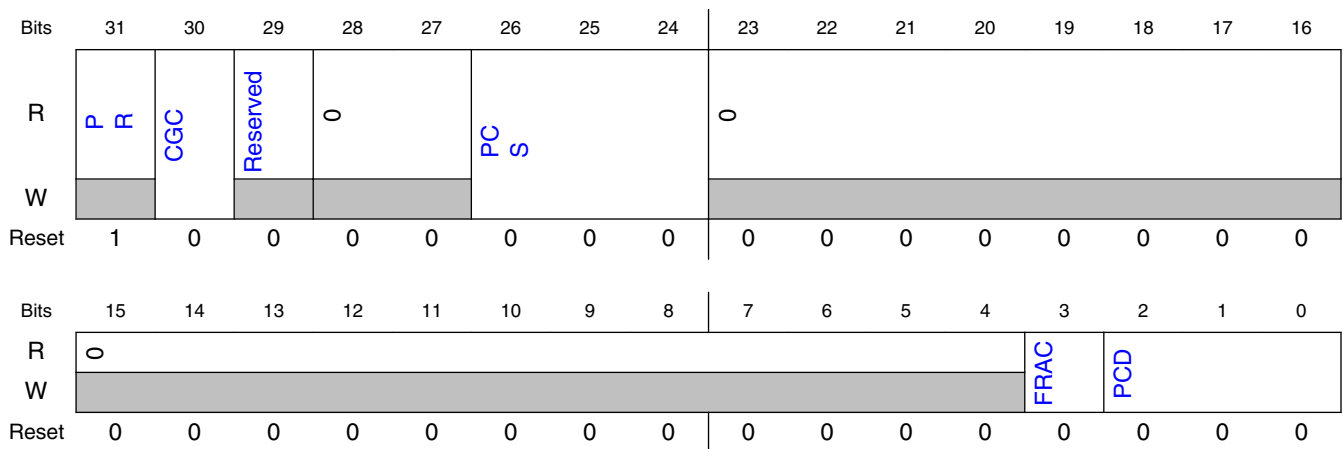

29.6.42.4 Fields

Field	Function
31 PR	Present This bit shows whether the peripheral is present on this device. 0b - Peripheral is not present. 1b - Peripheral is present.
30 CGC	Clock Gate Control

Table continues on the next page...

Field	Function
	<p>This read/write bit enables the interface clock for the peripheral, allowing access to the module's registers. It also controls whether the clock selection and divider options can be modified.</p> <p>0b - Clock disabled. The current clock selection and divider options are not locked and can be modified.</p> <p>1b - Clock enabled. The current clock selection and divider options are locked and cannot be modified.</p>
29 —	This read-only bit field is reserved. This bit can change values but is a don't-care.
28-27 —	This read-only bit field is reserved and always has the value 0.
26-24 PCS	<p>Peripheral Clock Source Select</p> <p>This read/write bit field is used for peripherals that support various clock selections. This field can be written only when the clock is disabled (CGC = 0).</p> <p>000b - Clock is off. 001b - Clock option 1 010b - Clock option 2 011b - Clock option 3 100b - Clock option 4 101b - Clock option 5 110b - Clock option 6 111b - Clock option 7</p>
23-4 —	This read-only bit field is reserved and always has the value 0.
3 FRAC	<p>Peripheral Clock Divider Fraction</p> <p>This read/write bit field sets the fraction multiply value for the fractional clock divider used as a clock source. Divider output clock = Divider input clock x [(FRAC+1)/(PCD+1)].</p> <p>This field can be written only when the clock is disabled (CGC = 0).</p> <p>NOTE: When dividing by 1 (PCD = 000), do not set the FRAC bit; otherwise, the output clock is disabled.</p> <p>0b - Fractional value is 0. 1b - Fractional value is 1.</p>
2-0 PCD	<p>Peripheral Clock Divider Select</p> <p>This read/write bit field is used for peripherals that require a clock divider. Divider output clock = Divider input clock x [(FRAC+1)/(PCD+1)].</p> <p>This field can be written only when the clock is disabled (CGC = 0).</p> <p>000b - Divide by 1. 001b - Divide by 2. 010b - Divide by 3. 011b - Divide by 4. 100b - Divide by 5. 101b - Divide by 6. 110b - Divide by 7. 111b - Divide by 8.</p>

Chapter 30

Clock Monitoring Unit (CMU)

30.1 CMU chip-specific information

CMU is available in only S32K11x series of devices. Other products in the S32K1xx series do not have CMU.

S32K11x has two instances of CMU: CMU0 and CMU1. It monitors FIRC which is the main source of system clock. CMU needs to be enabled through software as it is not enabled by default. CMU0 is used for reset generation on loss of clock detection, mapped to RCM_SRS[4]. The loss of clock is indicated when FIRC goes below the threshold programmed. Set IER[FHHAIE] and IER[FLLAIE] along with threshold programming to enable reset functionality. CMU1 is used for interrupt generation when FIRC goes below or above the programmed threshold limits. Set IER[FHHIE] and IER[FLLIE] along with threshold programming in CMU1 to enable interrupt functionality.

Following figure shows connection of CMU with the chip:

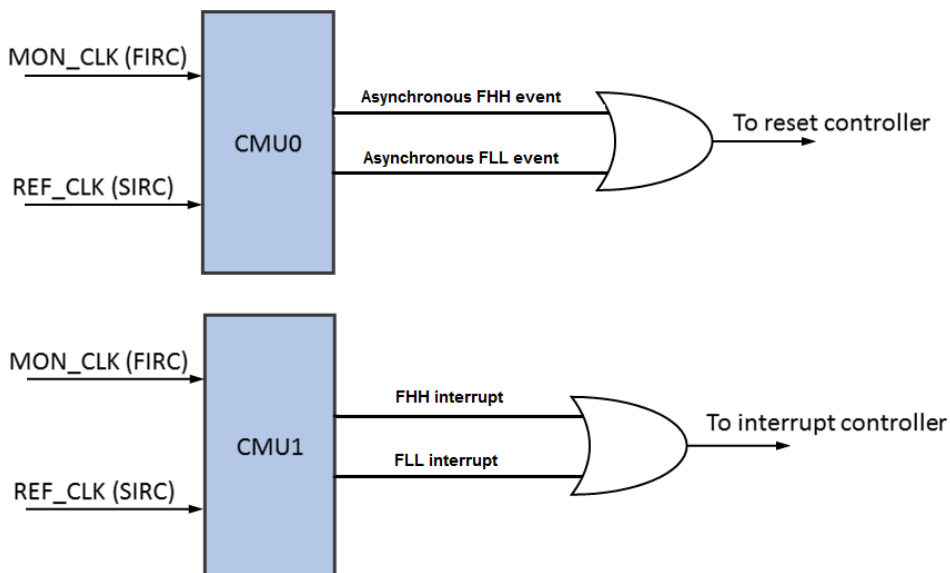

Figure 30-1. CMU on chip

Loss of Clock Indication Time Example: Conditions applied:

- CMU is enabled
- Monitored clock is lost
- 5 us LOC indication time requirement with
 - bus clock at 48 MHz
 - reference clock at 8 MHz

Formula for LOC indication time: $(2 * \text{REF_CNT} + 2) * \text{reference clock cycle} + 3 * \text{bus clock cycles}$

Calculation: $5 \text{ us} > (2 * \text{REF_CNT} + 2) * 0.125 \text{ us} + 3 * 0.0208 \text{ us}$

Result: $\text{REF_CNT} < 18$

Interpretation: The FLL REF_CNT should be programmed less than 18.

NOTE

- CMU needs to be disabled before disabling either FIRC or SIRC. If system clock is FIRC, CMU cannot be enabled if FIRC is not present from start, since system clock is required to enable CMU.
- For safety applications, CMU should run on a different clock than WDOG.
- CMU can flag FIRC clock out of range event to $\pm 7.5\%$ accuracy only in worst case, conditioned to FIRC and SIRC adhering to the device datasheet specifications range i.e. $\pm 1.1\%$ and $\pm 3.3\%$ respectively in worst case. If FIRC and SIRC violates the specifications, CMU accuracy will drop further below $\pm 7.5\%$.
- Hardware safety reaction time taken by CMU in flagging FIRC clock out of range event is 128 us for $\pm 7.5\%$ accuracy when REF_CNT is programmed to a value of 1000. If FIRC and SIRC violates the specifications, hardware safety reaction time will increase beyond 128 us.
- It is recommended to reset system through software for a clock out of range event rather than using an interrupt.

30.2 Introduction

CMU_FC modules are required to ensure clock signal integrity on the chip.

CMU_FC checks if the frequency of a monitored clock is within a programmable frequency range specified by the user. If the frequency is outside the specified limits, it could lead to performance, protocol, and timing failures. CMU_FC requires a clock that is used as a base reference for the frequency check operation. This reference clock must be within documented limits for correct CMU_FC operation. If a reference clock is outside operating parameters, CMU_FC behavior cannot be guaranteed.

30.2.1 Basic operation

CMU_FC counts clock cycles of the monitored clock during time duration of n clock cycles of the reference clock. The number n reference cycles is user programmable. The final count of the monitored clock after this time is compared against the user programmable upper and lower threshold count limits. The cycle count is then checked to see if it is within programmed limits. If the monitored clock count is not within programmed limits, a register status field is set. If needed, an interrupt can be configured to assert when the status flag sets.

If needed, an interrupt can be configured to assert when the status flag sets.

CMU_FC cannot detect the following:

- Duty cycle variations of a monitored clock.
- Instantaneous monitored clock frequency variations which do not cross the upper or lower measurement thresholds.

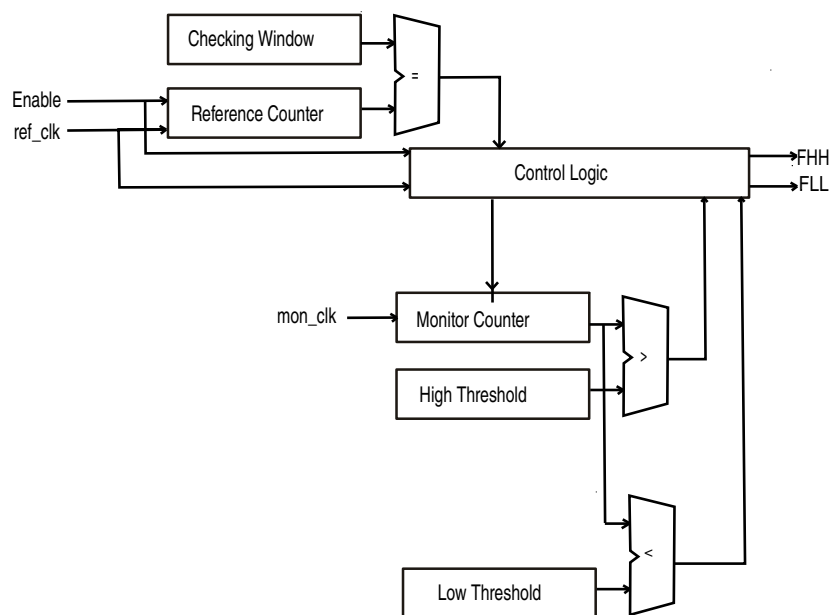

Figure 30-2. CMU_FC block diagram

30.2.2 Features

The CMU_FC features are:

- If a monitored clock frequency is higher than high frequency reference (FHH), an event occurs.
- If a monitored clock frequency is lower than low frequency reference (FLL), an event occurs.
- Programmable duration of reference clock cycles.
- Time out functionality to generate an FLL event when a monitored clock is lost.
- Masking of FHH interrupt.
- Masking of FLL interrupt.

Table 30-1. Clock description

Signal Name	I/O	Description
ref_clk	I	Reference Clock - Clock signal CMU_FC uses as reference for evaluating monitored clock.
mon_clk	I	Monitored Clock - Clock signal CMU_FC compares to lower and higher frequency limits to determine if the clock is operating within defined frequency range.

NOTE

See the Clocking chapter for details of monitored and reference clocks used on this chip.

30.3 CMU_FC register descriptions

30.3.1 CMU_FC Memory map

This section describes the address order of all the CMU_FC registers. Each description includes a standard register diagram and associated field descriptions.

CMU0 base address: 4003_E000h

CMU1 base address: 4003_F000h

Offset	Register	Width (In bits)	Access	Reset value
0h	Global Configuration Register (GCR)	32	RW	0000_0000h
4h	Reference Count Configuration Register (RCCR)	32	RW	0000_0000h
8h	High Threshold Configuration Register (HTCR)	32	RW	00FF_FFFFh
Ch	Low Threshold Configuration Register (LTCR)	32	RW	0000_0000h
10h	Status Register (SR)	32	W1C	0000_0000h
14h	Interrupt Enable Register (IER)	32	RW	0000_0000h

30.3.2 Global Configuration Register (GCR)

30.3.2.1 Offset

Register	Offset
GCR	0h

30.3.2.2 Function

GCR is used to control module level configurations.

30.3.2.3 Diagram

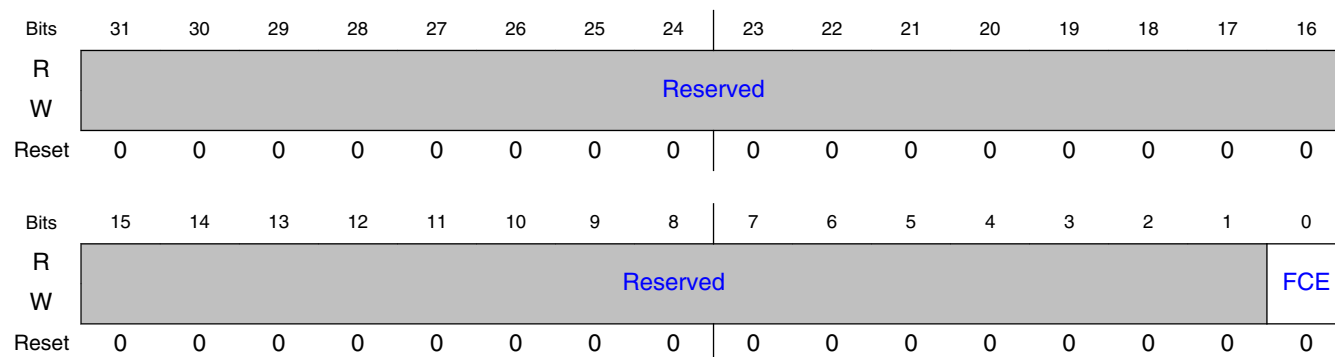

30.3.2.4 Fields

Field	Function
31-1 —	Reserved.
0 FCE	Frequency Check Enable. This field enables CMU_FC. The default state of CMU_FC is disabled. When GCR[FCE] = 1, it must be programmed to 0 only when SR[RS] = 1. It can be written 1 at any time. 0b - Frequency Check Disabled 1b - Frequency Check Enabled

30.3.3 Reference Count Configuration Register (RCCR)

30.3.3.1 Offset

Register	Offset
RCCR	4h

30.3.3.2 Function

RCCR is used to program the reference count duration of the frequency check window.

NOTE

RCCR can be written only when GCR[FCE] = 0. If RCCR is written when GCR[FCE] = 1, a bus transfer error is generated.

30.3.3.3 Diagram

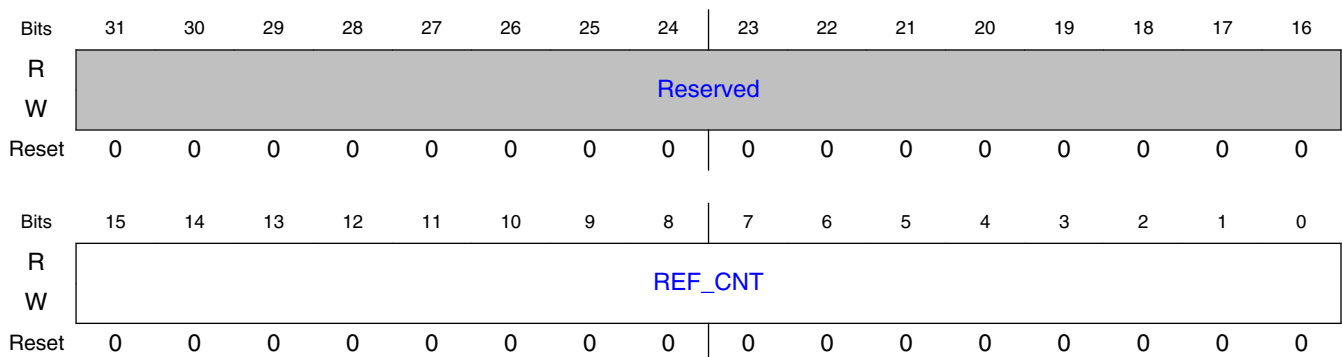

30.3.3.4 Fields

Field	Function
31-16 —	Reserved.
15-0 REF_CNT	Reference clock count. RCCR[REF_CNT] is the number of reference clock counts that the frequency check runs. This field defines the duration of one frequency check window.

30.3.4 High Threshold Configuration Register (HTCR)

30.3.4.1 Offset

Register	Offset
HTCR	8h

30.3.4.2 Function

HTCR is used to program high threshold limit of the monitored clock counter.

NOTE

HTCR can be written only when $GCR[FCE] = 0$. If HTCR is written when $GCR[FCE] = 1$, a bus transfer error is generated.

30.3.4.3 Diagram

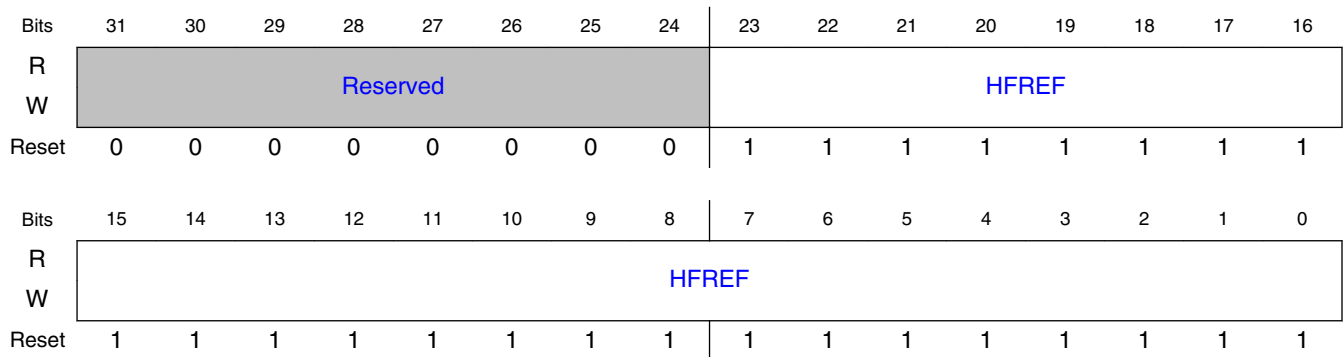

30.3.4.4 Fields

Field	Function
31-24 —	Reserved.
23-0 HFREF	High frequency reference threshold. HCTR[HFREF] determines the high reference value for the monitored clock frequency. The HCTR[HFREF] value is determined by the equation: $f_{\text{Monitored_clock}} / f_{\text{Reference_clock}} \times \text{RCCR}[\text{REF_CNT}] + \text{high threshold margin.}$

30.3.5 Low Threshold Configuration Register (LTCR)

30.3.5.1 Offset

Register	Offset
LTCR	Ch

30.3.5.2 Function

This register is used to program low threshold bound of the monitored clock counter.

NOTE

LTCR can be written only when GCR[FCE] = 0. If LTRC is written when GCR[FCE] = 1, a bus transfer error is generated.

30.3.5.3 Diagram

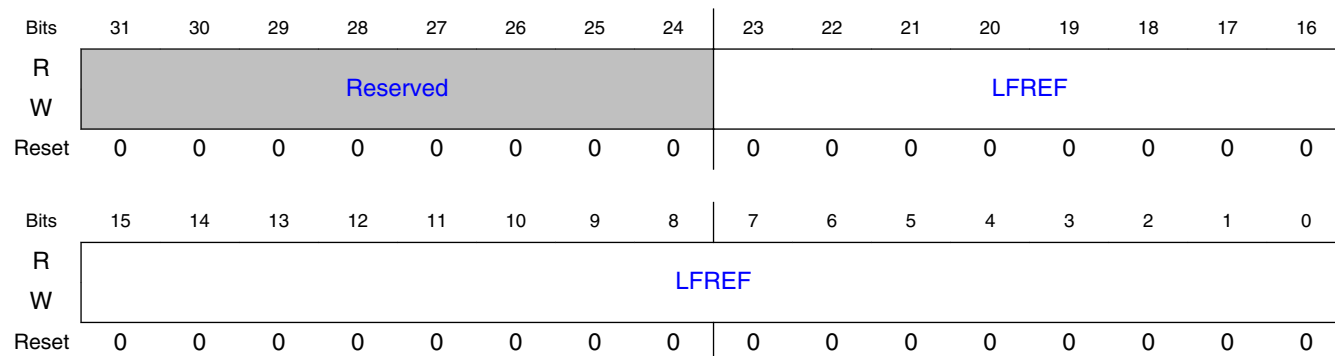

30.3.5.4 Fields

Field	Function
31-24 —	Reserved.
23-0 LFREF	Low Frequency Reference Threshold. LCTR[LFREF] determines the low reference value for the monitored clock frequency. The LCTR[LFREF] value is determined by the equation: $f_{\text{Monitored_clock}} / f_{\text{Reference_clock}} \times \text{RCCR}[\text{REF_CNT}] - \text{low threshold margin}$.

30.3.6 Status Register (SR)

30.3.6.1 Offset

Register	Offset
SR	10h

30.3.6.2 Function

SR shows the CMU_FC status.

30.3.6.3 Diagram

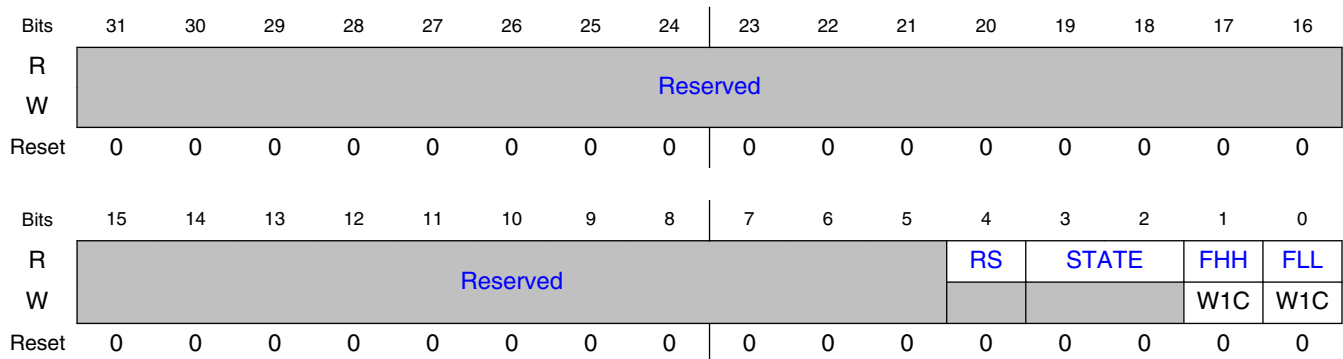

30.3.6.4 Fields

Field	Function
31-5 —	Reserved.
4 RS	<p>Run Status</p> <p>SR[RS] shows the running state of the CMU_FC internal logic. After enabling the frequency check operation (GCR[FCE] = 1), a fixed delay is required before SR[RS] indicates the running status. If the frequency check operation need to be disabled, software must read SR[RS] = 1 before writing GCR[FCE] = 0.</p> <p>0b - Frequency check stopped 1b - Frequency check running</p>
3-2 STATE	<p>Module state</p> <p>These bits provide the internal state information.</p> <p>00b - Configure state: Configuration registers and IER programming is getting done 01b - Initialization state: Register configurations are getting loaded internally. 10b - Initialization wait state: CMU_FC stays in this state for 1 bus clock cycle. 11b - Frequency check state: CMU_FC is ready to start frequency check operation in this state.</p>
1 FHH	<p>Frequency higher than high frequency reference threshold event status.</p> <p>This bit is set by hardware when the monitored clock frequency becomes higher than the high threshold value in HTCR[HFREF]. SR[FHH] is cleared when written 1.</p> <p>0b - No FHH event 1b - FHH event occurred</p>
0 FLL	<p>Frequency lower than low frequency reference threshold event status.</p> <p>This field is set by hardware when the $f_{\text{Monitored_clock}}$ is lower than the low threshold value in LTCR[LFREF]. SR[FLL] is cleared when written 1.</p> <p>0b - No FLL event 1b - FLL event captured</p>

30.3.7 Interrupt Enable Register (IER)

30.3.7.1 Offset

Register	Offset
IER	14h

30.3.7.2 Function

This register enables CMU_FC interrupts.

NOTE

- This register can only be written when $GCR[FCE] = 0$. If IER is written when $GCR[FCE] = 1$, a bus transfer error is generated.

30.3.7.3 Diagram

Bits	31	30	29	28	27	26	25	24	23	22	21	20	19	18	17	16
R	Reserved															
W	Reserved															
Reset	0	0	0	0	0	0	0	0	0	0	0	0	0	0	0	0
Bits	15	14	13	12	11	10	9	8	7	6	5	4	3	2	1	0
R	Reserved												FHHAIE	FLLAI	FHHIE	FLLI
W	Reserved												E	E	E	E
Reset	0	0	0	0	0	0	0	0	0	0	0	0	0	0	0	0

30.3.7.4 Fields

Field	Function
31-4	Reserved.
—	
3	Frequency Higher than High Frequency Reference Threshold Asynchronous Interrupt enable
FHHAIE	This bit is used to enable/disable FHH asynchronous interrupt at the module boundary.

Table continues on the next page...

CMU_FC register descriptions

Field	Function						
	<p>NOTE: This field is not supported in every instance. The following table includes only supported registers.</p> <table border="1"> <thead> <tr> <th>Field supported in</th> <th>Field not supported in</th> </tr> </thead> <tbody> <tr> <td>CMU0_IER</td> <td>—</td> </tr> <tr> <td>—</td> <td>CMU1_IER</td> </tr> </tbody> </table> <p>0b - Asynchronous FHH interrupt disabled 1b - Asynchronous FHH interrupt enabled</p>	Field supported in	Field not supported in	CMU0_IER	—	—	CMU1_IER
Field supported in	Field not supported in						
CMU0_IER	—						
—	CMU1_IER						
2 FLLAIE	<p>Frequency Lower than Low Frequency Reference Threshold Asynchronous Interrupt Enable This bit is used to enable/disable FLL asynchronous interrupt at the module boundary.</p> <p>NOTE: This field is not supported in every instance. The following table includes only supported registers.</p> <table border="1"> <thead> <tr> <th>Field supported in</th> <th>Field not supported in</th> </tr> </thead> <tbody> <tr> <td>CMU0_IER</td> <td>—</td> </tr> <tr> <td>—</td> <td>CMU1_IER</td> </tr> </tbody> </table> <p>0b - Asynchronous FLL interrupt disabled 1b - Asynchronous FLL interrupt enabled</p>	Field supported in	Field not supported in	CMU0_IER	—	—	CMU1_IER
Field supported in	Field not supported in						
CMU0_IER	—						
—	CMU1_IER						
1 FHHIE	<p>Frequency Higher than High Frequency Reference Threshold Synchronous Interrupt Enable This bit is used to enable/disable FHH synchronous interrupt at the module boundary.</p> <p>NOTE: This field is not supported in every instance. The following table includes only supported registers.</p> <table border="1"> <thead> <tr> <th>Field supported in</th> <th>Field not supported in</th> </tr> </thead> <tbody> <tr> <td>—</td> <td>CMU0_IER</td> </tr> <tr> <td>CMU1_IER</td> <td>—</td> </tr> </tbody> </table> <p>0b - Synchronous FHH interrupt disabled 1b - Synchronous FHH interrupt enabled</p>	Field supported in	Field not supported in	—	CMU0_IER	CMU1_IER	—
Field supported in	Field not supported in						
—	CMU0_IER						
CMU1_IER	—						
0 FLLIE	<p>Frequency Lower than Low Frequency Reference Threshold Synchronous Interrupt Enable This bit is used to enable/disable FLL synchronous interrupt at the module boundary.</p> <p>NOTE: This field is not supported in every instance. The following table includes only supported registers.</p> <table border="1"> <thead> <tr> <th>Field supported in</th> <th>Field not supported in</th> </tr> </thead> <tbody> <tr> <td>—</td> <td>CMU0_IER</td> </tr> <tr> <td>CMU1_IER</td> <td>—</td> </tr> </tbody> </table> <p>0b - Synchronous FLL interrupt disabled 1b - Synchronous FLL interrupt enabled</p>	Field supported in	Field not supported in	—	CMU0_IER	CMU1_IER	—
Field supported in	Field not supported in						
—	CMU0_IER						
CMU1_IER	—						

30.4 Functional description

Frequency checking starts when software writes $GCR[FCE] = 1$. The CMU_FC requires a fixed number of reference clock cycles before hardware operations start. The status field $SR[RS] = 1$ immediately after frequency check operation starts. Safety critical applications must poll $SR[RS]$ to determine when a check operation starts.

CMU_FC performs continuous periodic clock checking of the monitored clock. Each checking window involves the following operations:

- Stage 1 - Reference clock counter runs for $RCCR[REF_CNT]$ reference clock cycles. Monitored clock counter runs in parallel for the same time duration as reference clock counter.
- Stage 2 - After stage 1, the module compares the final monitored clock count against the programmed thresholds.

If the monitored clock count is greater than the high threshold value in $HTCR[HFREF]$, an FHH event is generated.

If the monitored clock count is lower than the low threshold value in $LTCR[LFREF]$, an FLL event is generated.

30.4.1 Monitored clock lost

If monitored clock is lost before it can be evaluated (Stage 2, see [Functional description](#)), CMU_FC waits for $RCCR[REF_CNT]$ reference clock periods by extending Stage 2 before an FLL event is triggered.

NOTE

- Worst case FLL response time if monitored clock is already absent when module is enabled = $(2 \times RCCR[REF_CNT] + 12)$ ref_clk cycles + 15 bus clock cycles.
- Worst case FLL response time if monitored clock stops while the module is running = $(2 \times RCCR[REF_CNT] + 2)$ ref_clk cycles + 3 bus clock cycles.

30.5 Programming guidelines

30.5.1 Programming HFREF and LFREF

HFREF/LFREF programming must be done considering the following:

- Tolerable monitored clock frequency variation.
- Maximum reference clock frequency variation.
- Inherent module inaccuracy.

The CMU_FC has an expected maximum deviation of +/- 3 ideal monitored clock cycles.

Example programming HTCR[HFREF] and HTCR[LFREF]:

- $f_{\text{Reference_clock}} = 20 \text{ MHz}$
- $f_{\text{Monitored_clock}} = 200 \text{ MHz}$
- $\text{RCCR}[\text{REF_CNT}] = 10$
- Ideal Monitored Clock Count = $(f_{\text{Monitored_clock}} / f_{\text{Reference_clock}}) \times \text{REF_CNT} = 100$

Now, consider the combined spec variation of reference clock and monitored clock = +/- 5%.

- The inherent inaccuracy of CMU_FC is 3 cycles.
- Minimum Monitored Clock Count = $(\text{Ideal Monitored Clock Count} \times 0.95) - 3 = 92$ (HTCR[LFREF])
- Maximum Monitored Clock Count = $(\text{Ideal Monitored Clock Count} \times 1.05) + 3 = 108$ (HTCR[HFREF])

30.5.2 Programming RCCR[REF_CNT]

Programming RCCR[REF_CNT] must be done after considering application requirements of event response time and required accuracy. Higher value of REF_CNT results in longer checking window leading to better accuracy in monitored clock measurement. Lower value of REF_CNT results in shorter checking window and faster response.

Minimum $\text{RCCR}[\text{REF_CNT}] = \text{CEILING value of MAX}(3 \times (f_{\text{Reference_clock}} / f_{\text{Bus_clock}}), \text{ or } 6 + 3 \times (f_{\text{Reference_clock}} / f_{\text{Monitored_clock}}))$.

Example to determine RCCR[REF_CNT]:

- $f_{\text{Bus_clock}} = 8 \text{ MHz}$
- $f_{\text{Reference_clock}} = 8 \text{ MHz}$
- $f_{\text{Monitored_clock}} = 48 \text{ MHz}$
- Formula #1: $3 \times (f_{\text{Reference_clock}} / f_{\text{Bus_clock}})$
- $3 \times (8 \text{ MHz} / 8 \text{ MHz}) = 3 \text{ MHz}$

- Formula #2: $6 + 3 \times (f_{\text{Reference_clock}} / f_{\text{Monitored_clock}})$
- $6 + 3 \times (8 \text{ MHz} / 48 \text{ MHz}) = 6.5 \text{ MHz}$
- $\text{MAX}(3 \text{ MHz}, 6.5 \text{ MHz}) = 6.5 \text{ MHz}$
- Then, CEILING value of MAX = 7 MHz (6.5 MHz rounded)
- Therefore, minimum RCCR[REF_CNT] = 7.

30.5.3 CMU_FC programming sequence

The recommended programming sequence of CMU_FC is:

1. In any order, do the following:
 - Program RCCR[REF_CNT] to define the frequency check window duration in reference clock cycles.
 - Program LTCCR[LFREF] and HTCCR[HFREF] to set the permissible frequency range of the monitored clock.
 - If needed, program IER register to enable interrupt.
2. Once the above steps are complete, writing GCR[FCE] = 1 starts the frequency check operation. The ability to write RCCR, LTCCR[LFREF], and HTCCR[HFREF] is disabled after writing GCR[FCE] = 1. An attempted write to any of those registers generates a bus transfer error.
3. To reconfigure RCCR, LTCCR[LFREF], and HTCCR[HFREF] registers, or to stop frequency check operation, write GCR[FCE] = 0 after SR[RS] = 1.

Chapter 31

Memories and Memory Interfaces

31.1 Introduction

This chapter discusses the configuration of the memories and memory interfaces, such as the flash memory, the Flash Memory Controller and the SRAM. Additional related information can be found in the following chapters:

- [MPU](#)
- [DMAMUX](#)
- [eDMA](#)
- [EIM](#)
- [ERM](#)

31.2 Flash Memory Controller and flash memory modules

For details about these modules, see:

- [Flash Memory Controller \(FMC\)](#)
- [Flash Memory Module \(FTFC\)](#)
- [Flash Memory Module \(FTFM\)](#)

NOTE

Before using any FTFC feature, program partition command (PGMPART) must be issued. For more information, see [Program Partition command](#).

31.3 SRAM configuration

This section summarizes how the module has been configured in the chip.

Table 31-1. Reference links to related information

Topic	Related module	Reference
System memory map		See attached S32K1xx_memory_map.xlsx
Clocking	System Clock Generator	Clock Distribution
Arm Cortex-M4 core		Arm Cortex-M4F core
Arm Cortex-M0+ core		Arm Cortex-M0+ core
System MPU		Memory Protection Unit (MPU)

31.3.1 SRAM sizes

This chip contains SRAM tightly coupled with the Arm Cortex-M4F core/Arm Cortex-M0+ core. The on-chip SRAM is split into contiguous SRAM_L and SRAM_U regions in the memory map:

- SRAM_L is anchored to 1FFF_FFFFh and occupies the space before this ending address.
- SRAM_U is anchored to 2000_0000h and occupies the space after this beginning address.

NOTE

Misaligned accesses across the 2000_0000h boundary are not supported in the Arm Cortex-M4F architecture.

The 10th character (Ordering Option Y) in orderable product part number identifies the total amount of SRAM on a device (for details see device datasheet). For each chip in the series, the following table shows the size of each SRAM region within that total.

Table 31-2. On-chip SRAM sizes

Chip	SRAM_L (KB) ¹	SRAM_U (KB) ¹	FlexRAM (KB) ¹	Total SRAM (KB)
S32K116	1 ²	14	2 ²	17
S32K118	1 ²	22	2 ²	25
S32K142	16	12	4	32
S32K144	32	28	4	64
	28	16	4	48
S32K144W	32	28	4	64

Table continues on the next page...

Table 31-2. On-chip SRAM sizes (continued)

Chip	SRAM_L (KB) ¹	SRAM_U (KB) ¹	FlexRAM (KB) ¹	Total SRAM (KB)
	28	16	4	48
S32K146	64	60	4	128
	48	44	4	96
S32K148	128	124	4	256
	96	92	4	192

1. See attached S32K1xx_memory_map.xlsx for specific addresses
2. 1 KB of for MTB. If not used for MTB, can be use as System RAM. Not ECC protected

NOTE

No ECC or access error is generated for FlexRAM used as System RAM. The region of size equal to FlexRAM (4 KB) after SRAM_U end address is reserved, but no access error is generated for this region.

31.3.2 SRAM accessibility**NOTE**

This section is applicable for CM4 core only.

Both SRAM_L and SRAM_U have a frontdoor port and a backdoor port.

The following table summarizes the master access to and performance of accesses to each port. The following figure illustrates the master access.

Table 31-3. SRAM accessibility and performance

SRAM region	Frontdoor port		Backdoor port	
	Master access	Performance	Master access	Performance
SRAM_L	Cortex-M4F core code bus	Single-cycle access	Non-core bus masters	Minimum two cycles for read and one cycle for write
SRAM_U	Cortex-M4F core system bus	Single-cycle access	Non-core bus masters	Minimum two cycles for read and one cycle for write

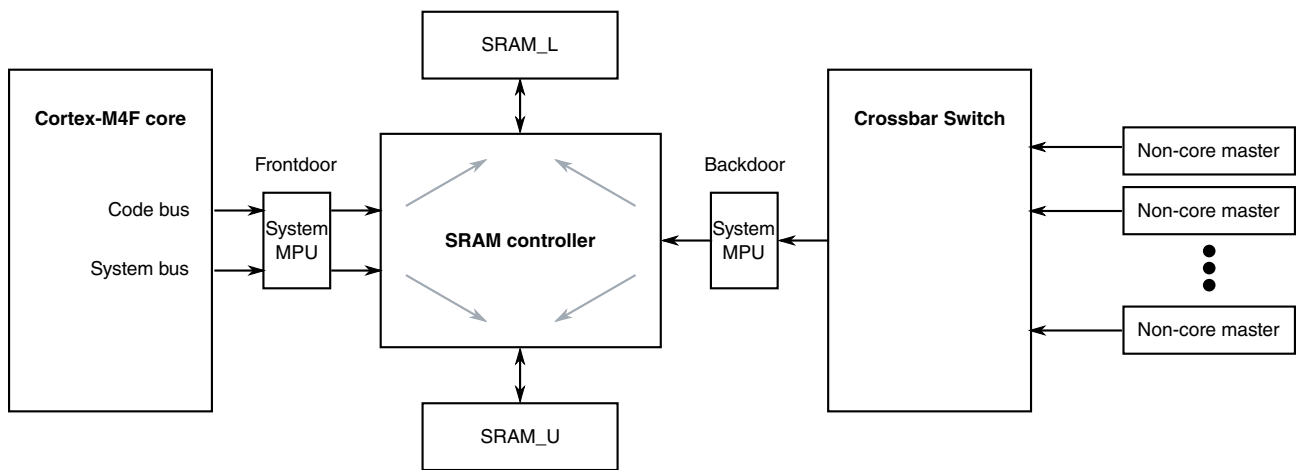

Figure 31-1. SRAM accessibility

The following simultaneous accesses to SRAM_L and SRAM_U can occur:

- Core code bus access to SRAM_L and core system bus access to SRAM_U
- Core code bus access to SRAM_L and non-core bus master access to SRAM_U
- Core system bus access to SRAM_U and non-core bus master access to SRAM_L

The following table illustrates these scenarios.

Table 31-4. SRAM simultaneous accesses

Core code bus access	Core system bus access	Non-core bus master access
SRAM_L	SRAM_U	—
SRAM_L	—	SRAM_U
—	SRAM_U	SRAM_L

NOTE

Burst accesses cannot occur across the 2000_0000h boundary that separates the two SRAM arrays. The two arrays should be treated as separate memory ranges for burst accesses.

To supplement the main system RAM, FlexRAM can be used as system RAM. However, FlexRAM accesses involve additional system latencies.

31.3.3 SRAM arbitration and priority control

The [Core Platform Control Register \(MCM_CPCR\)](#) controls the arbitration and priority schemes for the two SRAM arrays.

31.3.4 SRAM retention: power modes and resets

Power to the SRAM is maintained in all power modes.

To retain and access SRAM contents across functional resets, write application code to execute the following sequence:

1. Configure the [System Reset Interrupt Enable Register \(RCM_SRIE\)](#) to delay the reset and instead generate an interrupt on every reset request.
2. On an interrupt for a reset request, application code configures the chip to enter Run mode and then writes 0 to both [SRAMU_RETEN](#) and [SRAML_RETEN](#) in the [Chip Control register \(CHIPCTL\)](#). This logic ensures that any attempted access to SRAM is blocked after these bits are written, thereby preventing memory corruption during reset assertion.
3. The chip remains in Run mode until the reset asserts.

NOTE

During software initialization, ensure that no accesses occur to RAM with retained contents.

4. After exiting reset, read [SRAMU_RETEN](#) and [SRAML_RETEN](#) in the [Chip Control register \(CHIPCTL\)](#) and write 1 to them to allow accesses to SRAM.

31.3.5 SRAM access: Behavior of device when in accessing a memory with multi-bit ECC error

Following described the behavior of device when in accessing a memory with multi-bit ECC error.

Table 31-5. SRAM access: Behavior of device when in accessing a memory with multi-bit ECC error

Master accessing SRAM memory with ECC error	S32K11x	S32K14x	Recommended reaction
CPU	A hard fault occurs when CPU accesses an SRAM with multi bit ECC error. The CPU jumps to hard fault error interrupt handler first and then only it services ERM interrupt (provided it is enabled). So for early handling of this event, within the hard fault interrupt handler check if ERM status register is showing non-correctable ECC error event.	When CPU accesses an SRAM with multi bit ECC error, it jumps to ERM interrupt handler (provided it is enabled). No hard fault error interrupt occurs. Hence recommendation is to always enable the ERM interrupt. Further, check within ERM interrupt handler if ERM status register is showing non-correctable ECC error event. If yes, it is	A reset reaction is recommended on receiving an ECC event after doing necessary health checks for system level communication to external world, as ECC errors are not expected and can refer to unexpected event.

Table continues on the next page...

Table 31-5. SRAM access: Behavior of device when in accessing a memory with multi-bit ECC error (continued)

Master accessing SRAM memory with ECC error	S32K11x	S32K14x	Recommended reaction
	If yes, it is recommended to follow the recommended reaction (system reset).	recommended to follow the recommended reaction (system reset).	
DMA	DMA stops as soon as an access to the SRAM memory with multi bit ECC error. An error is indicated in DMA Error Status(ES) register and the done bit for the corresponding channel does not get set TCDn_CSR[DONE]. CPU gets an ERM interrupt as well (provided it is enabled).	DMA accesses to complete when accessing SRAM location with multi bit ECC error. CPU gets an ERM interrupt (provided it is enabled).	A reset reaction is recommended on receiving an ECC event after doing necessary health checks for system level communication to external world, as ECC errors are not expected and can refer to unexpected event.
ENET	NA as no ENET in S32K11x	Applicable only to S32K148. ENET accesses to an SRAM location with multi bit ECC error is to complete gracefully. CPU gets an ERM interrupt (provided it is enabled).	A reset reaction is recommended on receiving an ECC event after doing necessary health checks for system level communication to external world, as ECC errors are not expected and can refer to unexpected event.

Chapter 32

PRAM Controller (PRAMC)

32.1 PRAMC chip-specific information

PRAMC is available in only S32K11x series of devices. Other products in the S32K1xx series do not have PRAMC.

32.2 Introduction

The PRAM_CTL module is an asynchronous reset RAM array controller with integrated error detection and correction.

Shown below in [Figure 32-1](#) is a simplified block diagram of how the PRAM_CTL is implemented:

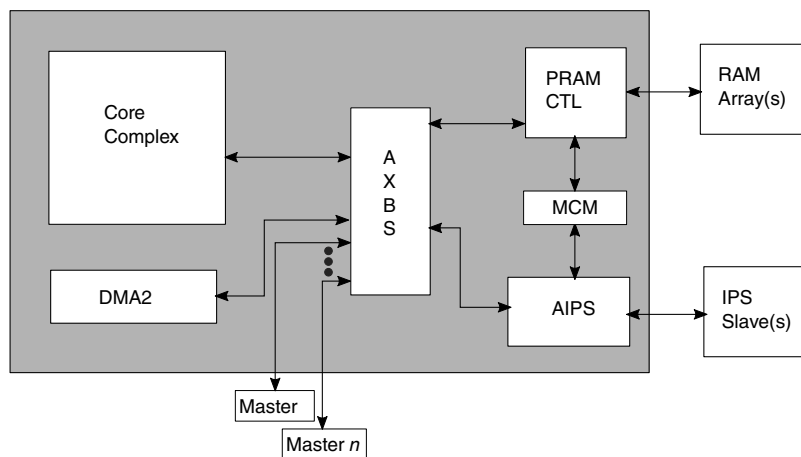

Figure 32-1. Simplified block diagram

In the above figure, the AXBS is the AHB crossbar switch (*arbiter*) and the MCM is the Miscellaneous Control Module where error detection information is stored. Refer to the appropriate chapter for a complete description.

32.3 Memory map and register definition

The memory map for the PRAM memory space is determined by the system in which the controller is implemented. There are no program-visible registers within the controller. All ECC error reporting and forcing capabilities are implemented via program-visible registers located in the Miscellaneous Control Module (MCM).

32.4 Functional description

32.4.1 Error Correcting Code (ECC)

32.4.1.1 Overview

The PRAM_CTL memory controller uses a 7-bit error correcting code (ECC) to correct single-bit errors and detect multiple-bit errors within the 32-bit data field. Since the ECC bits are written to and read from memory with the data, it is essential that each 32-bit memory location be written to a known value before being read. If an uninitialized memory address is read, it is likely the read will result in a multiple-bit ECC error and an errored transaction on the AHB. Only 32-bit write transfers can be used to initialize the memory as 16-bit or 8-bit writes will generate a read/modify/write scenario (see [Less than 32-bit writes](#)).

The ECC is composed of two modules, the encoder and the decoder. The decode module is shown in greater detail in [Figure 32-2](#).

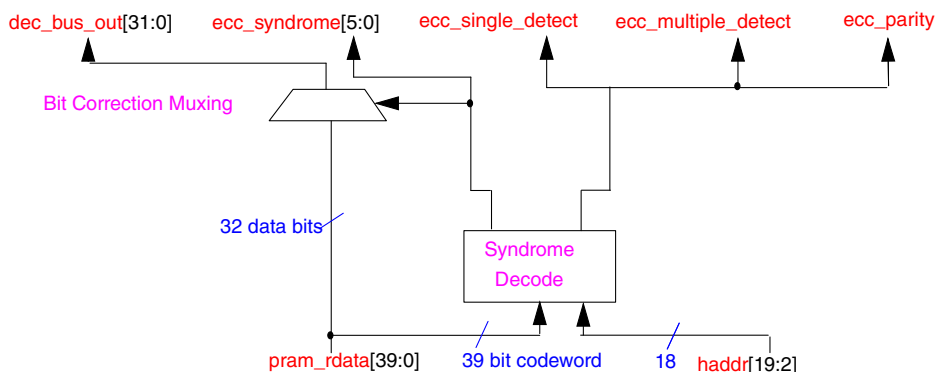

Figure 32-2. Block Diagram: 39-bit ECC Decode

The encoder logic is included in the write data path to the RAM and generates the 7-bit ECC code, which is written to the RAM with the data. Together, the data bus and ECC bits are called the *code word*.

The decoder logic is included in the read data path from the RAM back to the AHB bus. The decoder uses the same algorithm as the encoder and generates 7 unique ECC bits, or the *syndrome*[6:0], from the 39-bit code word (7 ECC and 32 data bits). This syndrome is used to determine which bit within the 39-bit data bus caused the single-bit correctable error. See the MCM block guide for more detail on which syndromes map to which bits.

Single-bit corrections cause the output *ecc_single_error* to be asserted. Multiple-bit errors cause the *ecc_multi_error* output to be asserted as well as an AHB ERROR response to be generated (*see AMBA AHB spec 2.0, pg 3-23*). AHB address attributes are also saved and outputted for each case. These two flags are mutually exclusive.

The assertion of these two flags may cause an interrupt to be generated, the EER bit to be set in the Miscellaneous Control Module (*MCM*), and the errored address, syndrome, parity and master address to be saved in the MCM (*See the MCM Block Guide for a programming model*). The effect of more than 2 simultaneous errors may produce unexpected behavior.

32.4.2 Read/Write introduction

As stated earlier in [Overview](#), it is essential that each memory address be written to a known value before it is read. This includes reads generated from the read/modify/write operation which occurs when a write transfer of less than 32 bits is requested (see [Less than 32-bit writes](#)).

32.4.3 Reads

All read transfers, of any size, complete with a zero wait states response on the AHB.

32.4.3.1 Unaligned reads

Any unaligned read will execute as if the size of the transfer is equal to the corresponding unaligned container size. For example, a 16-bit unaligned read will have a container of 32 bits and therefore the controller will execute the read as if it were a 32-bit read.

32.4.3.2 ECC errors on reads

A decoded multiple-bit ECC error will result in the termination of the corresponding AHB transaction with the AHB two cycle ERROR response (*hresp*).

The array is left unchanged.

32.4.3.3 Optional read wait-state

The PRAM_CTL can be optionally programmed to insert one wait-state in the AHB response on reads. Asserting the module-level input *pram_add_one_ws* will insert one wait state in the AHB data phase as well as the ECC reporting interface to the MCM. The state of *pram_add_one_wait_state* has no effect on writes nor reads less than 32-bit in size.

32.4.3.4 Reads and ECC events

- RAM reads in which no ECC events are detected will incur 1 wait state.
- RAM reads in which a single-bit, correctable ECC event is detected will incur 1 wait state
- RAM reads in which a multi-bit, non-correctable ECC error is detected will incur 2 wait states.

32.4.4 Writes

32.4.4.1 32-bit writes

Aligned 32-bit writes execute in a single AHB data phase cycle allowing for zero wait states on back to back writes.

32.4.4.2 Less than 32-bit writes

Less than 32-bit writes require a three step process referred to as a read/modify/write operation. Each 32-bit location must be initialized with a valid codeword created by the ECC encode block. This codeword must be kept consistent with the entire 32-bit word.

Therefore, for each less than 32-bit write, the array data must be read (*read*), the AHB write data merged with the array data and the codeword regenerated (*modify*), before the data can be stored (*write*).

32.4.4.3 Unaligned writes

It should be noted that unaligned writes always generate read/modify/write operations in the pram controller in order to preserve the validity of the ECC codeword.

32.4.5 Late write hits

A late write hit occurs when the late write buffer is valid and the address of the late write buffer matches *haddr*. The following table shows the possible late write hit scenarios and the result of each.

Table 32-1. Late write hit cases

	Access Type	haddr	lwb addr	lwb size	Action Description	Wait State?
1	<=32-bit read	A0	A0	32	hrdata = lwb data 0	No
2	<=32-bit read	A0	A1	32	Not a hit, actually a miss, lwb held, normal array read	No
3	32-bit write	A0	-	-	Store during address phase	No
4	<32-bit write	A*	A*	*	Array read if necessary lwb/pram_rdata merged	No

A0 : address bit A[2]=0

A1 : address bit A[2]=1

A* : address bit A[2]=either 1 or 0

* : any valid value can be substituted

lwb : late write buffer

In all late write hit cases, no additional wait states are inserted on the AHB.

32.5 Initialization / application information

It is essential that each memory address be written to a known value before it is read. This includes reads generated from the read/modify/write operation which occurs when a write transfer of less than 32 bits or unaligned write is requested (see [Less than 32-bit writes](#)). Without writing an address to a known value first, a read from this address will most likely generate an ECC multiple error.

Chapter 33

Local Memory Controller (LMEM)

33.1 Chip-specific LMEM information

Variants of S32K11x series do not have LMEM.

33.1.1 LMEM region description

See attached S32K1xx_memory_map.xlsx for LMEM regions.

NOTE

- Cache write buffer is not supported on S32K14x as the memory region which is cacheable is read-only.
- [PCCRM\[R2\]](#) should be programmed as 00b (Non-Cacheable) as S32K148 FlexNVMS region is not cacheable. The device may show unexpected behavior when cache tries to access FlexNVM region.

33.1.2 LMEM SRAM sizes

SRAM sizes vary across the products in the S32K14x series. In this chapter, [SRAM Arrays](#) documents the superset SRAM sizes.

For each S32K14x product's SRAM sizes and other details, see [SRAM sizes](#).

33.2 Introduction

The Local Memory Controller provides the processor with tightly-coupled processor-local memories and bus paths to all slave memory spaces.

33.2.1 Block Diagram

The processor has a modified 32-bit Harvard bus architecture. Using a 32-bit address space, low-order addresses (0x0000_0000 through 0x1FFF_FFFF) use the Processor Code (PC) bus, and high-order addresses (0x2000_0000 through 0xFFFF_FFFF) use the Processor System (PS) bus. As the bus names imply, normal operation has code accesses on the PC bus and data accesses on the PS bus.

This device has been augmented with tightly-coupled memories for the PC and PS buses. The memories include RAMs and caches. These local memories provide zero wait state access to RAM and cacheable address spaces.

The local memory controller includes three memory controllers and their attached memories:

- SRAM lower (SRAM_L) controller via the PC bus
- SRAM upper (SRAM_U) controller via the PS bus
- Cache memory controller via the PC bus

The local memory controller has the following 32-bit AMBA_ AHB buses:

- Two inputs are for the processor's modified Harvard buses – the Processor Code (PC) and the Processor System (PS) buses.
- One input is for the "backdoor" port used by all other bus masters to access the SRAM controller space.
- Two output ports are the CCM (Core Code Master) bus used for PC accesses that do not hit the PC cache or SRAM_L or are non-cacheable and the CSM (Core System Master) bus used for PS references that do not hit the SRAM_U.

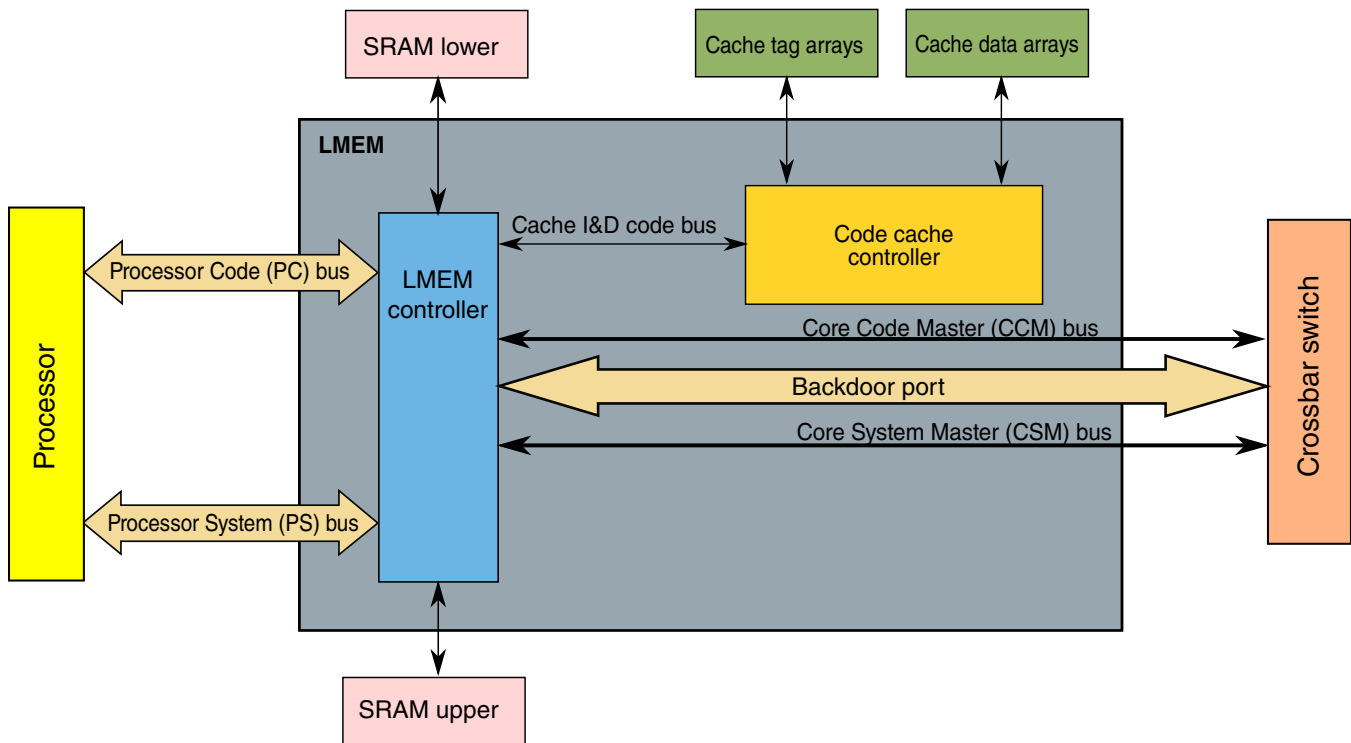

Figure 33-1. Local memory controller block diagram

NOTE

The SRAM and cache controllers reside within the LMEM, but the single-port synchronous RAM arrays used by these controllers are external.

The LMEM contains address decode logic for the PC and PS buses. This logic routes the core's accesses to the various system resources. The address spaces are device-specific. See the chip-specific LMEM information for the address space decode details.

33.2.2 Cache features

A cache is a block of high-speed memory locations containing address information (commonly known as a tag) and the associated data. The purpose is to decrease the average time of a memory access. Caches operate on two principles of locality:

- Spatial locality — An access to one location is likely to be followed by accesses from adjacent locations (for example, sequential instruction execution or usage of a data structure).
- Temporal locality — An access to an area of memory is likely to be repeated within a short time period (for example, execution of a code loop).

To minimize the quantity of control information stored, the spatial locality property is used to group several locations together under the same tag. This logical block is commonly known as a cache line.

When data is loaded into a cache, access times for subsequent loads and stores are reduced, resulting in overall performance benefits. An access to information already in a cache is known as a cache hit, and other accesses are called cache misses.

Normally, caches are self-managing, with the updates occurring automatically. Whenever the processor wants to access a cacheable location, the cache is checked. If the access is a cache hit, the access occurs immediately. Otherwise, a location is allocated and the cache line is loaded from memory. Different cache topologies and access policies are possible. However, they must comply with the memory coherency model of the underlying architecture.

Caches introduce a number of potential problems, mainly because of:

- memory accesses occurring at times other than when the programmer would normally expect them,
- the existence of multiple physical locations where a data item can be held.

The local memory controller supports the following modes of operation:

1. Write-through — access to address spaces with this cache mode are cacheable.
 - If all cacheable spaces are read-only spaces, the cache will contain read-only data and all write to the cache will fault. See the chip-specific cacheable space information.
 - A write-through read miss on the input bus causes a line read on the output bus of a 16-byte-aligned memory address containing the desired address. This miss data is loaded into the cache and is marked as valid and not modified.
 - A write-through read hit to a valid cache location returns data from the cache with no output bus access.
 - A write-through write miss bypasses the cache and writes to the output bus (no allocate on write miss policy for write-through mode spaces).
 - A write-through write hit updates the cache hit data and writes to the output bus.
 - The caches are processor-local and do not support hardware cache coherency. If the processor has accessed write-through regions and an external bus master (such as DMA) then needs update these regions, software must first perform explicit cache clears to any needed cache memory range to ensure all modified cache lines update their associated memories before being modified by external masters and subsequent processor accesses will get the updated memory.
2. Non-cacheable — access to address spaces with this cache mode are not cacheable. These accesses bypass the cache and access the output bus.

33.3 Memory Map/Register Definition

The cache programmer's model provides a variety of registers for configuring and controlling the cache, as well as indirect access paths to all cache tag and data storage.

NOTE

The LMEM registers are accessible in supervisor mode only.

33.3.1 LMEM register descriptions

33.3.1.1 LMEM memory map

LMEM base address: E008_2000h

Offset	Register	Width (In bits)	Access	Reset value
0h	Cache control register (PCCCR)	32	RW	0000_0000h
4h	Cache line control register (PCCLCR)	32	RW	0000_0000h
8h	Cache search address register (PCCSAR)	32	RW	0000_0000h
Ch	Cache read/write value register (PCCVVR)	32	RW	0000_0000h
20h	Cache regions mode register (PCCRMR)	32	RW	AA0F_A000h

33.3.1.2 Cache control register (PCCCR)

33.3.1.2.1 Offset

Register	Offset
PCCCR	0h

33.3.1.2.2 Diagram

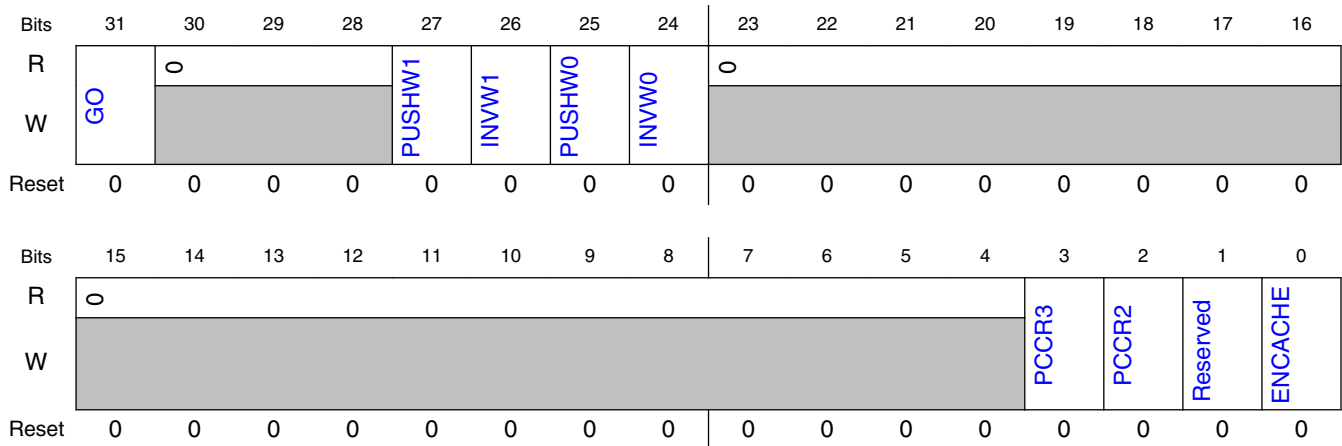

33.3.1.2.3 Fields

Field	Function
31 GO	Initiate Cache Command Setting this bit initiates the cache command indicated by bits 27-24. Reading this bit indicates if a command is active NOTE: This bit stays set until the command completes. Writing zero has no effect. 0b - Write: no effect. Read: no cache command active. 1b - Write: initiate command indicated by bits 27-24. Read: cache command active.
30-28 —	Reserved
27 PUSHW1	Push Way 1 0b - No operation 1b - When setting the GO bit, push all modified lines in way 1
26 INWV1	Invalidate Way 1 NOTE: If the PUSHW1 and INWV1 bits are set, then after setting the GO bit, push all modified lines in way 1 and invalidate all lines in way 1 (clear way 1). 0b - No operation 1b - When setting the GO bit, invalidate all lines in way 1
25 PUSHW0	Push Way 0 0b - No operation 1b - When setting the GO bit, push all modified lines in way 0
24 INWV0	Invalidate Way 0 NOTE: If the PUSHW0 and INWV0 bits are set, then after setting the GO bit, push all modified lines in way 0 and invalidate all lines in way 0 (clear way 0). 0b - No operation 1b - When setting the GO bit, invalidate all lines in way 0.
23-4 —	Reserved
3	Forces no allocation on cache misses (must also have PCCR2 asserted)

Table continues on the next page...

Field	Function
PCCR3	
2 PCCR2	Forces all cacheable spaces to write through
1 —	This field is reserved. Software should write 0 to this bit to maintain compatibility.
0 ENCACHE	Cache enable 0b - Cache disabled 1b - Cache enabled

33.3.1.3 Cache line control register (PCCLCR)

33.3.1.3.1 Offset

Register	Offset
PCCLCR	4h

33.3.1.3.2 Function

This register defines specific line-sized cache operations to be performed using a specific cache line address or a physical address.

If a physical address is specified, both ways of the cache are searched, and the command is only performed on the way which hits.

33.3.1.3.3 Diagram

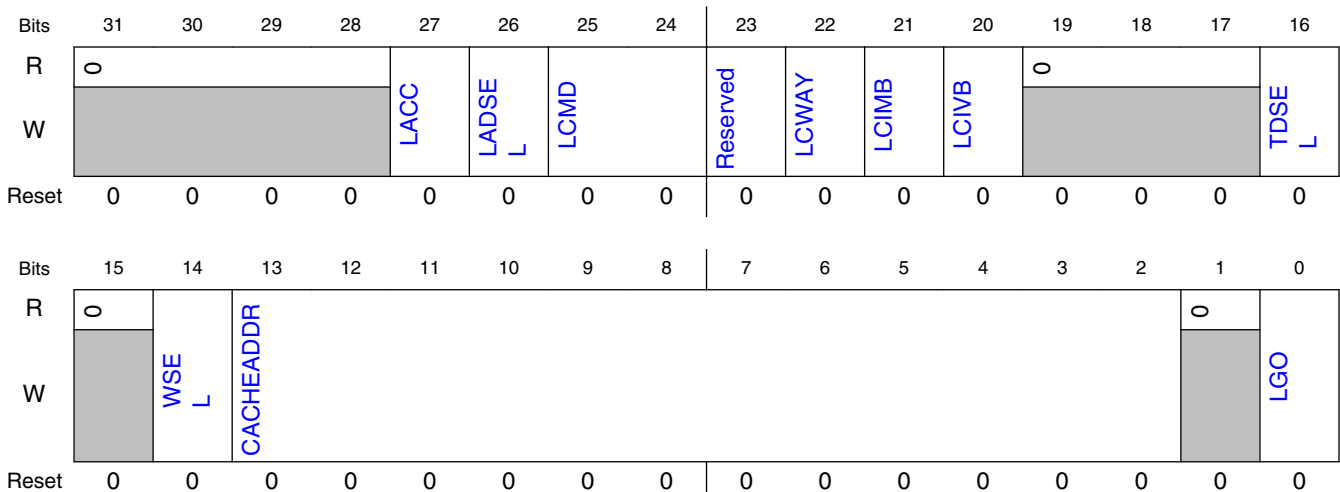

33.3.1.3.4 Fields

Field	Function
31-28 —	Reserved
27 LACC	Line access type 0b - Read 1b - Write
26 LADSEL	Line Address Select When using the cache address, the way must also be specified in CLCR[WSEL]. When using the physical address, both ways are searched and the command is performed only if a hit. 0b - Cache address 1b - Physical address
25-24 LCMD	Line Command 00b - Search and read or write 01b - Invalidate 10b - Push 11b - Clear
23 —	Reserved
22 LCWAY	Line Command Way Indicates the way used by the line command. Only applies if valid bit LCIVB = 1.
21 LCIMB	Line Command Initial Modified Bit If command used cache address and way, then this bit shows the initial state of the modified bit If command used physical address and a hit, then this bit shows the initial state of the modified bit. If a miss, this bit reads zero.
20 LCIVB	Line Command Initial Valid Bit If command used cache address and way, then this bit shows the initial state of the valid bit If command used physical address and a hit, then this bit shows the initial state of the valid bit. If a miss, this bit reads zero.
19-17 —	Reserved
16 TDSEL	Tag/Data Select Selects tag or data for search and read or write commands. 0b - Data 1b - Tag
15 —	Reserved
14 WSEL	Way select Selects the way for line commands. 0b - Way 0

Table continues on the next page...

Field	Function
	1b - Way 1
13-2 CACHEADDR	Cache address CLCR[10:4] bits are used to access the tag arrays CLCR[10:2] bits are used to access the data arrays
1 —	Reserved
0 LGO	Initiate Cache Line Command Setting this bit initiates the cache line command indicated by bits 27-24. Reading this bit indicates if a line command is active NOTE: This bit stays set until the command completes. Writing zero has no effect. NOTE: This bit is shared with CSAR[LGO] 0b - Write: no effect. Read: no line command active. 1b - Write: initiate line command indicated by bits 27-24. Read: line command active.

33.3.1.4 Cache search address register (PCCSAR)

33.3.1.4.1 Offset

Register	Offset
PCCSAR	8h

33.3.1.4.2 Function

The CSAR register is used to define the explicit cache address or the physical address for line-sized commands specified in the CLCR[LADSEL] bit.

33.3.1.4.3 Diagram

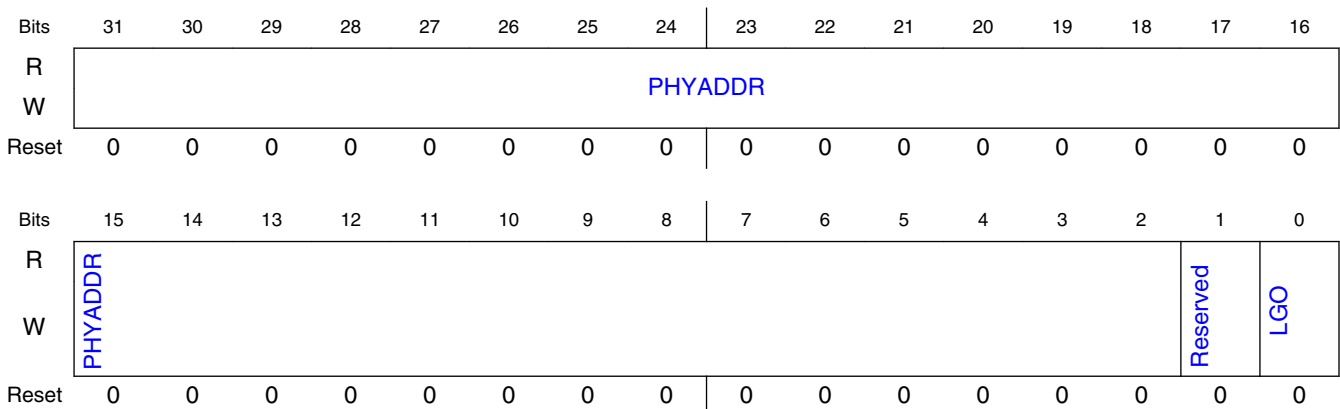

33.3.1.4.4 Fields

Field	Function
31-2 PHYADDR	Physical Address PHYADDR represents bits [31:2] of the system address. CSAR[31:11] bits are used for tag compare CSAR[10:4] bits are used to access the tag arrays CSAR[10:2] bits are used to access the data arrays
1 —	Reserved
0 LGO	Initiate Cache Line Command Setting this bit initiates the cache line command indicated by bits 27-24. Reading this bit indicates if a line command is active NOTE: This bit stays set until the command completes. Writing zero has no effect. NOTE: This bit is shared with CLCR[LGO] 0b - Write: no effect. Read: no line command active. 1b - Write: initiate line command indicated by bits CLCR[27:24]. Read: line command active.

33.3.1.5 Cache read/write value register (PCCCVR)

33.3.1.5.1 Offset

Register	Offset
PCCCVR	Ch

33.3.1.5.2 Function

The CCVR register is used to source write data or return read data for the commands specified in the CLCR register.

33.3.1.5.3 Diagram

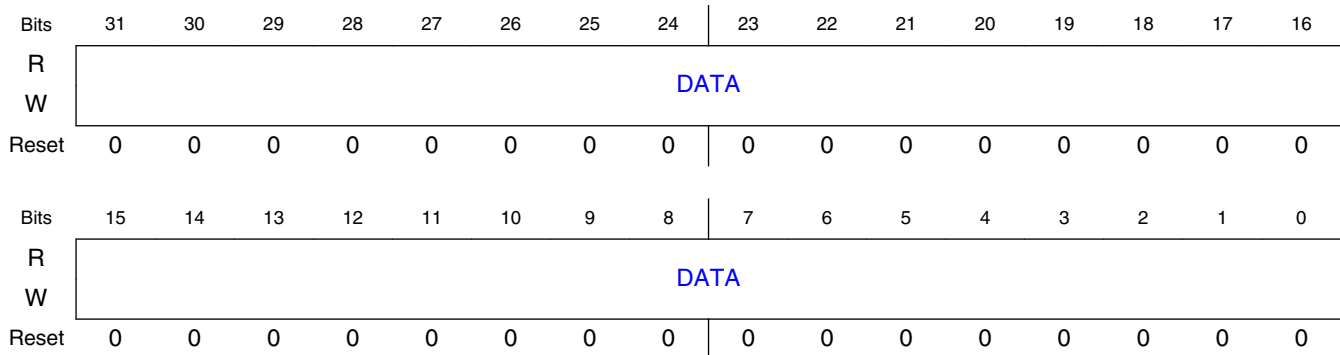

33.3.1.5.4 Fields

Field	Function
31-0 DATA	Cache read/write Data For tag search, read or write: <ul style="list-style-type: none"> • CCVR[31:11] bits are used for tag array R/W value • CCVR[10:4] bits are used for tag set address on reads; unused on writes • CCVR[3:2] bits are reserved • CCVR[1] tag modify bit • CCVR[0] tag valid bit For data search, read or write: <ul style="list-style-type: none"> • CCVR[31:0] bits are used for data array R/W value

33.3.1.6 Cache regions mode register (PCCRM)

33.3.1.6.1 Offset

Register	Offset
PCCRM	20h

33.3.1.6.2 Function

The CRMR register allows you to demote the cache mode of various subregions within the device's memory map. Demoting the cache mode reduces the cache function applied to a memory region from write-back to write-through to non-cacheable. After a region is demoted, its cache mode can only be raised by a reset, which returns it to its default state.

To maintain cache coherency, changes to the cache mode should be completed while the address space being changed is not being accessed or the cache is disabled. Before a cache mode change, complete a cache clear all command to push and invalidate any cache entries that may have changed.

NOTE

The address/module assignment of the 16 subregions is device-specific. See the chip-specific LMEM information for these details. Some of the regions may not be used (non-cacheable), and some regions may not be capable of write-back.

33.3.1.6.3 Diagram

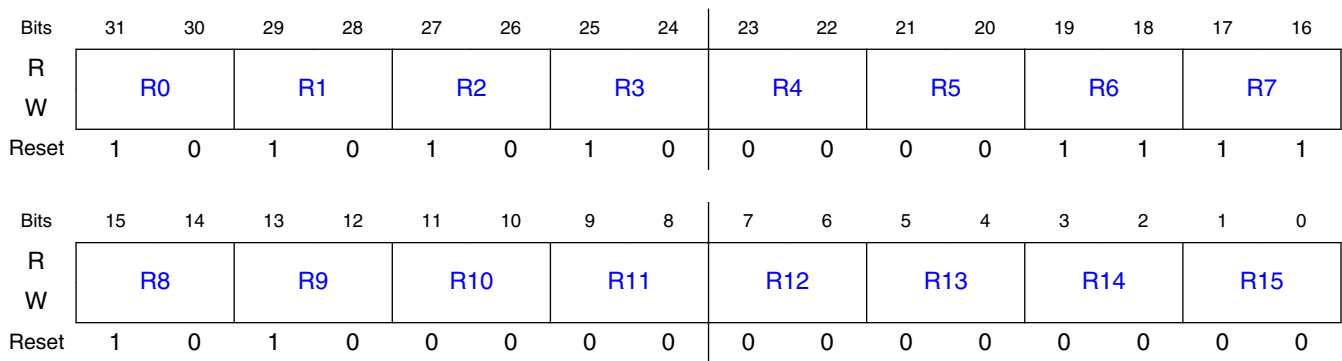

33.3.1.6.4 Fields

Field	Function
31-30 R0	Region 0 mode Controls the cache mode for region 0 00b - Non-cacheable 01b - Non-cacheable 10b - Write-through 11b - Write-back
29-28 R1	Region 1 mode Controls the cache mode for region 1 00b - Non-cacheable 01b - Non-cacheable 10b - Write-through 11b - Write-back
27-26 R2	Region 2 mode Controls the cache mode for region 2 00b - Non-cacheable 01b - Non-cacheable 10b - Write-through

Table continues on the next page...

Field	Function
	11b - Write-back
25-24 R3	Region 3 mode Controls the cache mode for region 3 00b - Non-cacheable 01b - Non-cacheable 10b - Write-through 11b - Write-back
23-22 R4	Region 4 mode Controls the cache mode for region 4 00b - Non-cacheable 01b - Non-cacheable 10b - Write-through 11b - Write-back
21-20 R5	Region 5 mode Controls the cache mode for region 5 00b - Non-cacheable 01b - Non-cacheable 10b - Write-through 11b - Write-back
19-18 R6	Region 6 mode Controls the cache mode for region 6 00b - Non-cacheable 01b - Non-cacheable 10b - Write-through 11b - Write-back
17-16 R7	Region 7 mode Controls the cache mode for region 7 00b - Non-cacheable 01b - Non-cacheable 10b - Write-through 11b - Write-back
15-14 R8	Region 8 mode Controls the cache mode for region 8 00b - Non-cacheable 01b - Non-cacheable 10b - Write-through 11b - Write-back
13-12 R9	Region 9 mode Controls the cache mode for region 9 00b - Non-cacheable 01b - Non-cacheable 10b - Write-through 11b - Write-back
11-10 R10	Region 10 mode Controls the cache mode for region 10 00b - Non-cacheable

Table continues on the next page...

Functional Description

Field	Function
	01b - Non-cacheable 10b - Write-through 11b - Write-back
9-8 R11	Region 11 mode Controls the cache mode for region 11 00b - Non-cacheable 01b - Non-cacheable 10b - Write-through 11b - Write-back
7-6 R12	Region 12 mode Controls the cache mode for region 12 00b - Non-cacheable 01b - Non-cacheable 10b - Write-through 11b - Write-back
5-4 R13	Region 13 mode Controls the cache mode for region 13 00b - Non-cacheable 01b - Non-cacheable 10b - Write-through 11b - Write-back
3-2 R14	Region 14 mode Controls the cache mode for region 14 00b - Non-cacheable 01b - Non-cacheable 10b - Write-through 11b - Write-back
1-0 R15	Region 15 mode Controls the cache mode for region 15 00b - Non-cacheable 01b - Non-cacheable 10b - Write-through 11b - Write-back

33.4 Functional Description

33.4.1 LMEM Function

The Local Memory Controller receives the following requests:

- Core master bus requests on the Processor Code (PC) bus,

- Core master bus requests on the Processor System (PS) bus, and
- SRAM controller requests from all other bus masters on the backdoor port.

The Local Memory Controller address decode logic routes these accesses and also provides any crossbar switch slave target logic. Finally, the Local Memory controller provides the needed MPU connections for checking all SRAM controller and cacheable accesses.

The programming model for the Code Cache is accessed via the core's Private Peripheral Bus (PPB).

33.4.1.1 Processor Code accesses

Processor Code accesses are routed to the SRAM_L if they are mapped to that space. All other PC accesses are routed to the Code Cache Memory Controller. This controller then processes the cacheable accesses as needed, while bypassing the non-cacheable, cache write-through, cache miss, and cache maintenance accesses to the CCM bus and the crossbar switch using the Master0 port.

33.4.1.2 Processor System accesses

Processor System accesses are routed to the SRAM_U if they are mapped to that space. All other PS accesses are routed to the CCM bus and the crossbar switch using the Master1 port.

33.4.1.3 Backdoor port accesses

All LMEM backdoor port accesses are for the SRAM controller. These accesses go to the SRAM_L or the SRAM_U depending on their specific address.

33.4.2 SRAM Function

33.4.2.1 SRAM Configuration

The figure below shows how the SRAM controller is configured.

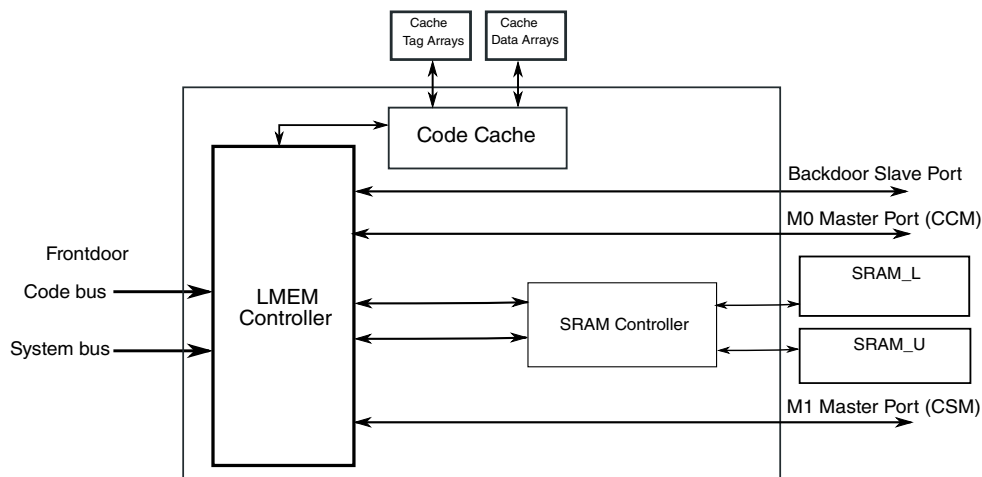

Figure 33-2. LMEM Interface to SRAM

33.4.2.2 SRAM Arrays

The on-chip SRAM is split into two logical arrays, SRAM_L and SRAM_U.

SRAM_L size is 128 KBytes.

SRAM_U size is 128 KBytes.

Valid address ranges for SRAM_L and SRAM_U are then defined as:

- SRAM_L = (0x20000_0000 - 128 KBytes) to 0x1fff_ffff
- SRAM_U = 0x2000_0000 to (0x2000_0000 + 128 KBytes)

SRAML_SIZE and SRAMU_SIZE do not have to be equal.

33.4.2.3 SRAM Accesses

The SRAM is split into two logical arrays that are 32-bits wide:

- SRAM_L — Accessible by the code bus of the core and by the backdoor port.
- SRAM_U — Accessible by the system bus of the core and by the backdoor port.

The backdoor port makes the SRAM accessible to the non-core bus masters (such as DMA).

Figure 33-3 illustrates the SRAM accesses within the device.

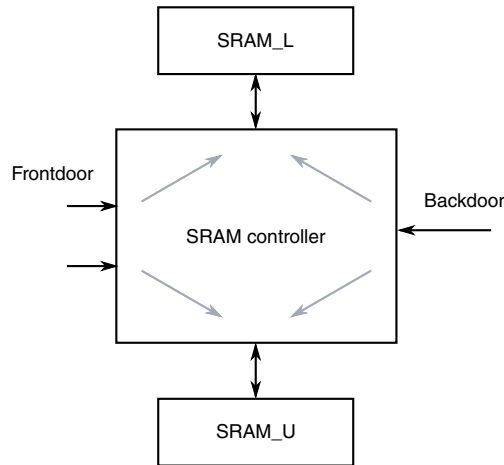

Figure 33-3. SRAM access diagram

The following simultaneous accesses can be made to different logical halves of the SRAM:

- Core code and core system
- Core code and non-core master
- Core system and non-core master

NOTE

Two non-core masters cannot access SRAM simultaneously. The required arbitration and serialization is provided by the crossbar switch. The SRAM_L and SRAM_U arbitration is controlled by the SRAM controller based on the configuration bits in the MCM module.

NOTE

Burst-access cannot occur across the 0x2000_0000 boundary that separates the two SRAM arrays. The two arrays should be treated as separate memory ranges for burst accesses.

33.4.3 Cache Function

The cache on this device is structured as follows. The cache has a 2-way set-associative cache structure with a total size of 4 KBytes for the Code Cache. The cache has 32-bit address and data paths and a 16-byte line size. The cache tags and data storage use single-port, synchronous RAMs.

Functional Description

For the Code 4-KByte cache, each cache TAG function uses two 128 x 23-bit RAM arrays and the cache DATA function uses two 512 x 32-bit RAM arrays. The cache TAG entries store 21 bits of upper address as well as a modified and valid bit per cache line. The cache DATA entries store four bytes of code or data.

All normal cache accesses use physical addresses. This leads to the following cache address use:

CODE CACHE - 4 KByte size = (128 sets) x (16-byte lines) x (2-way set associative)

Table 33-1. Tag Cache Address Use

Tag Cache Address Use	Code Cache
Tag Hit Address Range	Address[31:11]
Tag Set Select Address Range	Address[10:4] used to select 1 of 128 sets
Not Used	Address[3:0]

Table 33-2. Data Cache Address Use

Data Cache Address Use	Code Cache
Not Used	Address[31:11]
Data Set Select Address Range	Address[10:4] used to select one of 128 sets
32-bit word select	Address[3:2] used to select one of four 32-bit words within a set
Byte select	Address[1:0] used to select the byte within the 32-bit word

33.4.4 Cache Control

The Code Cache is disabled at reset. Cache tag and data arrays are not cleared at reset. Therefore, to enable the cache, cache commands must be done to clear and initialize the required tag array bits and to configure and enable the caches.

33.4.4.1 Cache set commands

The cache set commands may operate on:

- all of way 0,
- all of way 1, or
- all of both ways (complete cache).

Cache set commands are initiated using the upper bits in the CCR register. Cache set commands perform their operation on the cache independent of the cache enable bit, CCR[ENCACHE].

A cache set command is initiated by setting the CCR[GO] bit. This bit also acts as a busy bit for set commands. It stays set while the command is active and is cleared by the hardware when the set command completes.

Supported cache set commands are given in [Table 33-3](#). Set commands work as follows:

- Invalidate – Unconditionally clear valid and modify bits of a cache entry.
- Push – Push a cache entry if it is valid and modified, then clear the modify bit. If entry not valid or not modified, leave as is.
- Clear – Push a cache entry if it is valid and modified, then clear the valid and modify bits. If entry not valid or not modified, clear the valid bit.

Table 33-3. Cache Set Commands

CCR[27:24]				Command
PUSHW1	INVW1	PUSHW0	INVW0	
0	0	0	0	NOP
0	0	0	1	Invalidate all way 0
0	0	1	0	Push all way 0
0	0	1	1	Clear all way 0
0	1	0	0	Invalidate all way 1
0	1	0	1	Invalidate all way 1; invalidate all way 0 (invalidate cache)
0	1	1	0	Invalidate all way 1; push all way 0
0	1	1	1	Invalidate all way 1; clear all way 0
1	0	0	0	Push all way 1
1	0	0	1	Push all way 1; invalidate all way 0
1	0	1	0	Push all way 1; push all way 0 (push cache)
1	0	1	1	Push all way 1; clear all way 0
1	1	0	0	Clear all way 1
1	1	0	1	Clear all way 1; invalidate all way 0
1	1	1	0	Clear all way 1; push all way 0
1	1	1	1	Clear all way 1; clear all way 0 (clear cache)

After a reset, complete an invalidate cache command before using the cache. It is possible to combine the cache invalidate command with the cache enable. That is, setting CCR to 0x8500_0001 will invalidate the cache and enable the cache.

33.4.4.2 Cache line commands

Cache line commands operate on a single line in the cache at a time. Cache line commands can be performed using a physical or cache address.

- A cache address consists of a set address and a way select. The line command acts on the specified cache line.
- Cache line commands with physical addresses first search both ways of the cache set specified by the following physical address bits. If they hit, the commands perform their action on the hit way:
 - For Code Cache - [10:4]

Cache line commands are specified using the upper bits in the CLCR register. Cache line commands perform their operation on the cache independent of the cache enable bit (CCR[ENCACHE]). Using a cache address, the command can be completely specified using the CLCR register. Using a physical address, the command must also use the CSAR register to specify the physical address.

A line cache command is initiated by setting the line command go bit (CLCR[LGO] or CSAR[LGO]). This bit also acts as a busy bit for line commands. It stays set while the command is active and is cleared by the hardware when the command completes.

The CLCR[27:24] bits select the line command as follows:

Table 33-4. Cache Line Commands

CLCR[27:24]			Command
LACC	LADSEL	LCMD	
0	0	00	Search by cache address and way
0	0	01	Invalidate by cache address and way
0	0	10	Push by cache address and way
0	0	11	Clear by cache address and way
0	1	00	Search by physical address
0	1	01	Invalidate by physical address
0	1	10	Push by physical address
0	1	11	Clear by physical address
1	0	00	Write by cache address and way
1	0	01	Reserved, NOP
1	0	10	Reserved, NOP
1	0	11	Reserved, NOP
1	1	xx	Reserved, NOP

33.4.4.2.1 Executing a series of line commands using cache addresses

A series of line commands with incremental cache addresses can be performed by just writing to the CLCR.

- Place the command in CLCR[27:24],
- Set the way (CLCR[WSEL]) and tag/data (CLCR[TDSEL]) controls as needed,
- Place the cache address in CLCR[CACHEADDR], and
- Set the line command go bit (CLCR[LGO]).

When one line command completes, initiate the next command by following these steps:

- Increment the cache address (at bit 2 to step through data or at bit 4 to step through lines), and
- Set the line command go bit (CLCR[LGO]).

33.4.4.2.2 Executing a series of line commands using physical addresses

Perform a series of line commands with incremental physical addresses using the following steps:

- Write to the CLCR.
 - Place the command in CLCR[27:24]
 - Set the tag/data (CLCR[TDSEL]) control
- Place the physical address in CSAR[PHYADDR] and set the line command go bit (CSAR[LGO]).

When one line command completes, initiate the next command by following these steps:

- Increment the physical address (at bit 2 to step through data or at bit 4 to step through lines), and
- Set the line command go bit (CSAR[LGO]).

The line command go bit is shared between the CLCR and CSAR registers, so that the above steps can be completed in a single write to the CSAR register.

33.4.4.2.3 Line command results

At completion of a line command, the CLCR register contains information on the initial state of the line targeted by the command. For line commands with cache addresses, this information is read before the line command action is performed from the targeted cache line. For line commands with physical addresses, this information is read on a hit before the line command action is performed from the hit cache line or has initial valid bit

Functional Description

cleared if the command misses. In general, if the valid indicator (CLCR[LCIVB] is cleared, the targeted line was invalid at the start of the line command and no line operation was performed.

Table 33-5. Line command results

CLCR[22:20]			For cache address commands	For physical address commands
LCWAY	LCIMB	LCIVB		
0	0	0	Way 0 line was invalid	No hit
0	0	1	Way 0 valid, not modified	Way 0 valid, not modified
0	1	0	Way 0 line was invalid	No hit
0	1	1	Way 0 valid and modified	Way 0 valid and modified
1	0	0	Way 1 line was invalid	No hit
1	0	1	Way 1 valid, not modified	Way 1 valid, not modified
1	1	0	Way 1 line was invalid	No hit
1	1	1	Way 1 valid and modified	Way 1 valid and modified

At completion of a line command other than a write, the CCVR (Cache R/W Value Register) contains information on the initial state of the line tag or data targeted by the command. For line commands, CLCR[TDSEL] selects between tag and data. If the line command used a physical address and missed, the data is don't care. For write commands, the CCVR holds the write data.

Chapter 34

Miscellaneous System Control Module (MSCM)

34.1 Chip-specific MSCM information

34.1.1 Chip-specific TMLSZ/TMUSZ information

The TMLSZ and TMUSZ fields of MSCM's CPxCFG2 register document the device's TCMU (SRAM_U) and TCML (SRAM_L) sizes, respectively. However, for devices with a total SRAM size smaller than 64 KB, these fields show the maximum possible SRAM partition size for the device's part number. For example: On S32K144, TMUSZ indicates an SRAM_U size of 32 KB, but the actual SRAM_U size is either 28 KB or 16 KB. On any given device: For the exact amount of total SRAM, refer to the 10th character (Ordering Option Y) in orderable product part number. (for details see device datasheet) For the exact amounts of SRAM_L and SRAM_U within that total, see [SRAM sizes](#).

NOTE

TCMU and TCML terms are interchangeable with SRAM_U and SRAM_L.

34.1.2 Chip-specific register information

The reset values of some MSCM registers vary across the products in this series. The following table shows these reset values for each product.

Table 34-1. MSCM register reset values

Register	S32K116	S32K118	S32K142	S32K144	S32K144W	S32K146	S32K148
CPxCFG2 ¹	NA	NA	0601_0601	0701_0701	0701_0701	0801_0801	0901_0901
CP0CFG2 ¹	NA	NA	0601_0601	0701_0701	0701_0701	0801_0801	0901_0901
OCMDR0	C806_9000	C906_9000	C906_9000	CA08_9000	CA08_9000	CB08_9000	CC08_9000
OCMDR1	C606_B000	C606_B000	C706_B000	C706_B000	C706_B000	C706_B000	CA08_B000
OCMDR2	C204_D000	C204_D000	C304_D000	C304_D000	C304_D000	C304_D000	C304_D000

Overview

1. This Register is Reserved/not available in S32K11x variants. For TCM sizes, see [MCM](#) chapter. Device specific reset values of LMDR0 and LMDR1 registers are documented in Chip-specific MCM information.

NOTE

The DFLASH value indicated above for S32K148 is for non EEE mode, i.e., complete FlexNVM (512 KB) being used as DFLASH. For EEE mode, this size will be 448 KB.

34.2 Overview

The Miscellaneous System Control Module (MSCM) contains CPU configuration registers and on-chip memory controller registers.

The MSCM block diagram is shown below in [Figure 34-1](#) :

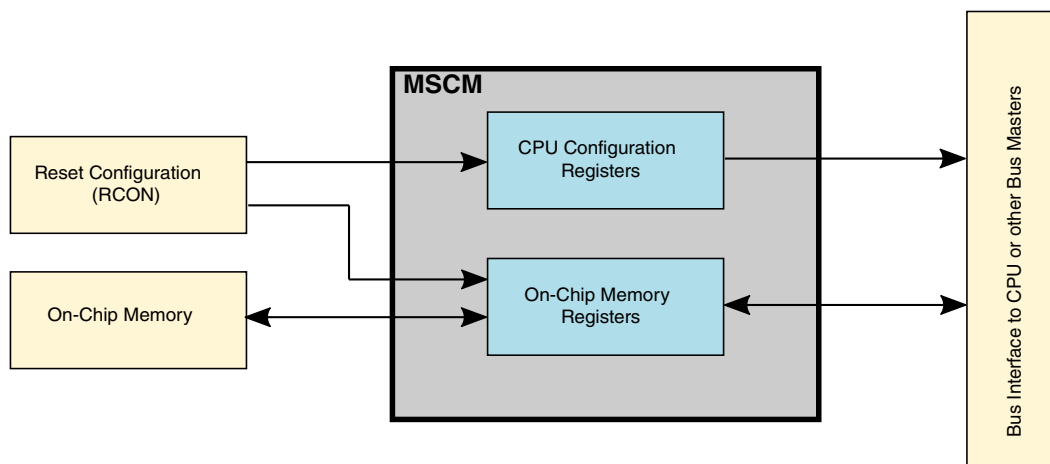

Figure 34-1. MSCM Block Diagram

34.3 Chip Configuration and Boot

The device's logical definition is controlled via chip-specific configuration bits, supported memory sizes and packing options. Collectively, these configuration bits define a reset configuration value (RCON).

Once the core has fetched the needed reset vector(s), it is expected that core and system configuration information is read from a globally-accessible slave peripheral that properly converts the information into more appropriate values. More specifically, the

core accesses configuration information from a common set of peripheral addresses and the chip configuration logic properly evaluates based on the requesting processor and returns the appropriate value for the given processor, including core identification.

As an example, there is a single 32-bit read-only location for the core identification. A 32-bit read from this location returns a 4-character ASCII string: 0x434D3401("Cortex-M4").

The programming model associated with the core configuration information is included as part of the Miscellaneous System Control Module (MSCM). It specifically includes multiple views of the processor configuration; one view that is available generically to the core, and other views that are available to any bus masters in the system.

34.4 MSCM Memory Map/Register Definition

34.4.1 CPU Configuration Memory Map and Registers

The CPU configuration portion of the MSCM module provides a set of memory-mapped read-only addresses defining the processor set-up. This portion of the MSCM programming model can only be accessed with privileged mode 32-bit read references; any other access type or size is terminated with an error. If the processor is logically not included in the chip configuration, then reads of its configuration registers return zeroes.

The CPU Configuration registers are organized based on the logical processor number (not any type of physical port number) and partitioned into the following equal sections:

Table 34-2. CPU Configuration Register Sections

Offset addresses	Function
0x000 - 0x01F	Defines the generic processor "x" configuration. This region is only accessible to the processor core; reads by non-core bus masters are treated as read-as-zero (RAZ) accesses.
0x020 - 0x03F	Defines the configuration information for processor 0 (CP0). This region is accessible to any bus master.

Attempted user mode or write accesses are terminated with an error.

34.4.2 MSCM register descriptions

34.4.2.1 MSCM memory map

MSCM base address: 4000_1000h

Offset	Register	Width (In bits)	Access	Reset value
0h	Processor X Type Register (CPxTYPE)	32	RO	Table 34-2
4h	Processor X Number Register (CPxNUM)	32	RO	Table 34-2
8h	Processor X Master Register (CPxMASTER)	32	RO	Table 34-2
Ch	Processor X Count Register (CPxCOUNT)	32	RO	0000_0000h
10h	Processor X Configuration Register 0 (CPxCFG0)	32	RO	Table 34-2
14h	Processor X Configuration Register 1 (CPxCFG1)	32	RO	Table 34-2
18h	Processor X Configuration Register 2 (CPxCFG2)	32	RO	Table 34-2
1Ch	Processor X Configuration Register 3 (CPxCFG3)	32	RO	Table 34-2
20h	Processor 0 Type Register (CP0TYPE)	32	RO	434D_3401h
24h	Processor 0 Number Register (CP0NUM)	32	RO	0000_0000h
28h	Processor 0 Master Register (CP0MASTER)	32	RO	0000_0000h
2Ch	Processor 0 Count Register (CP0COUNT)	32	RO	0000_0000h
30h	Processor 0 Configuration Register 0 (CP0CFG0)	32	RO	0400_0000h
34h	Processor 0 Configuration Register 1 (CP0CFG1)	32	RO	0000_0000h
38h	Processor 0 Configuration Register 2 (CP0CFG2)	32	RO	0901_0901h
3Ch	Processor 0 Configuration Register 3 (CP0CFG3)	32	RO	0000_0101h
400h	On-Chip Memory Descriptor Register (OCMDR0)	32	RW	DC08_9000h
404h	On-Chip Memory Descriptor Register (OCMDR1)	32	RW	CA08_B000h
408h	On-Chip Memory Descriptor Register (OCMDR2)	32	RW	C304_D000h

34.4.2.2 Processor X Type Register (CPxTYPE)

34.4.2.2.1 Offset

Register	Offset
CPxTYPE	0h

34.4.2.2.2 Function

The register provides a CPU-specific response indicating the personality of the core making the access. The 32-bit response includes 3 ASCII characters that define the CPU type, along with a byte that defines the logical revision number. The logical revision number follows Arm’s rYpZ nomenclature.

NOTE

CPxTYPE value(s) for this device:

- If CPU0 is making the access = 0x434D3401
- If the read access is not from a CPU, then the value read is 0x00000000

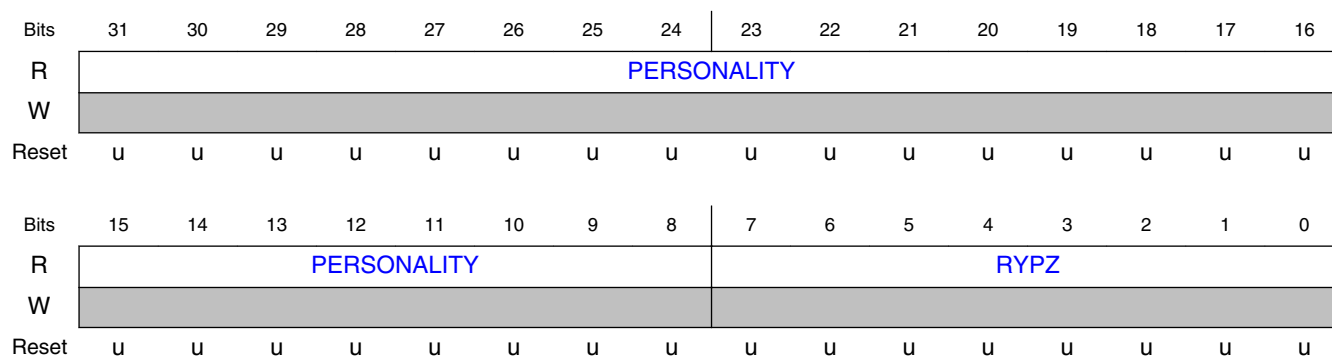
34.4.2.2.3 Diagram**34.4.2.2.4 Fields**

Field	Function
31-8 PERSONALITY	Processor x Personality This read-only field defines the processor personality for CPUx if CPUx = Cortex-M4, then PERSONALITY = 0x43_4D_34 ("CM4").
7-0 RYPZ	Processor x Revision This read-only field defines the processor revision for CPUx: 0x00 corresponds to the r0p0 core release. 0x01 corresponds to the r0p1 core release. ...

34.4.2.3 Processor X Number Register (CPxNUM)**34.4.2.3.1 Offset**

Register	Offset
CPxNUM	4h

34.4.2.3.2 Function

The register provides a CPU-specific response indicating the logical processor number of the core making the access. The logical processor number is always 0.

If the read access is not from a CPU, then the value read is 0x00000000.

34.4.2.3.3 Diagram

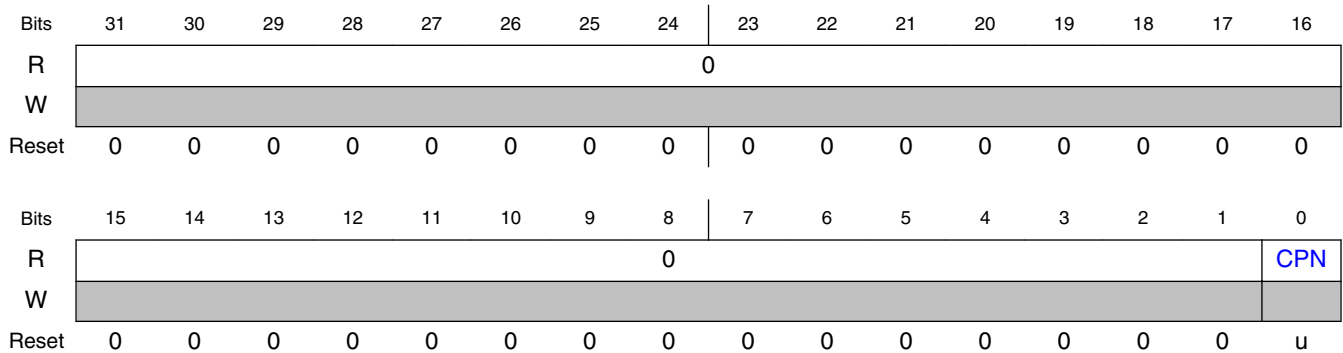

34.4.2.3.4 Fields

Field	Function
31-1 —	Reserved
0 CPN	Processor x Number This zero-filled word defines the logical processor number for CPUx If single core configuration, then CPN = 0

34.4.2.4 Processor X Master Register (CPxMASTER)

34.4.2.4.1 Offset

Register	Offset
CPxMASTER	8h

34.4.2.4.2 Function

The register provides a CPU-specific response indicating the physical bus master number of the core that is making the access. The 32-bit response defines the physical master number for processor x.

- CPxMASTER = 0x00000000

NOTE

A privileged read from a CPU returns the appropriate processor information. Reads from a non-CPU bus master returns all zeroes. Attempted user mode or write accesses are terminated with an error.

34.4.2.4.3 Diagram

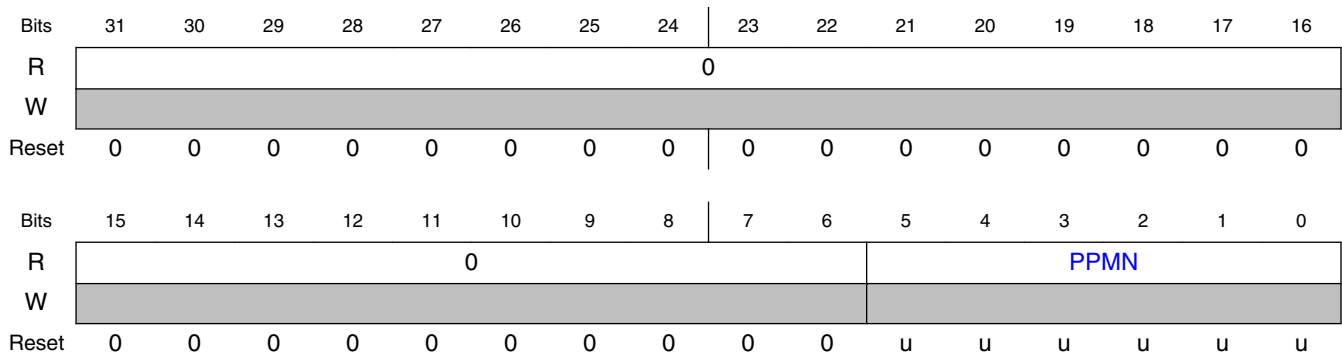

34.4.2.4.4 Fields

Field	Function
31-6 —	Reserved
5-0 PPMN	Processor x Physical Master Number This read-only field defines the physical bus master number for CPUx. PPMN = 0x00

34.4.2.5 Processor X Count Register (CPxCOUNT)

34.4.2.5.1 Offset

Register	Offset
CPxCOUNT	Ch

34.4.2.5.2 Function

The register indicates the total number of processor cores in the chip configuration.

34.4.2.5.3 Diagram

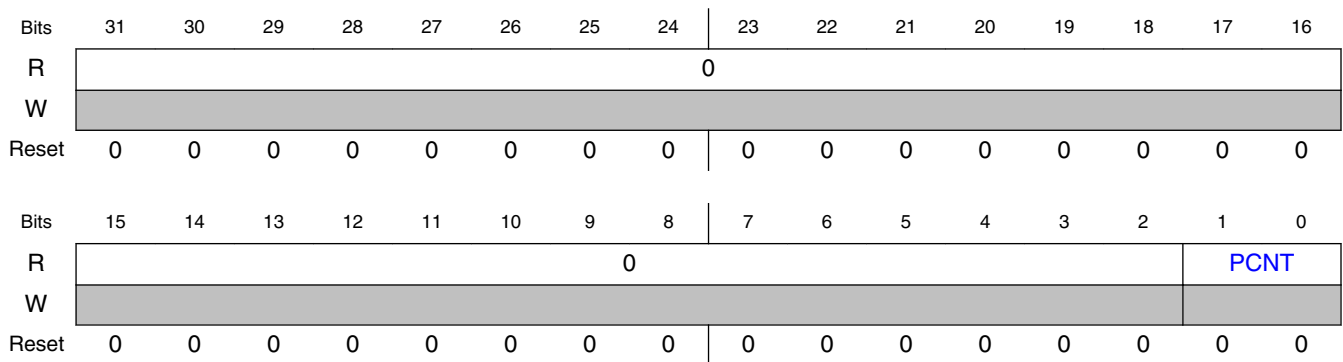

34.4.2.5.4 Fields

Field	Function
31-2 —	Reserved
1-0 PCNT	Processor Count This read-only field defines the processor count for the chip configuration: PCNT = 00 (Single Core)

34.4.2.6 Processor X Configuration Register 0 (CPxCFG0)

34.4.2.6.1 Offset

Register	Offset
CPxCFG0	10h

34.4.2.6.2 Function

The CPxCFG0 register provides a CPU-specific response detailing configuration information, in this case, information on the Level 1 caches (if present).

Access: Privileged read-only

NOTE

Reset values for the Processor X Configuration Register 0:

- For CPU0 - CPxCFG0 = 0x04000000
- If the read access is not from a CPU, then the value read is 0x00000000

34.4.2.6.3 Diagram

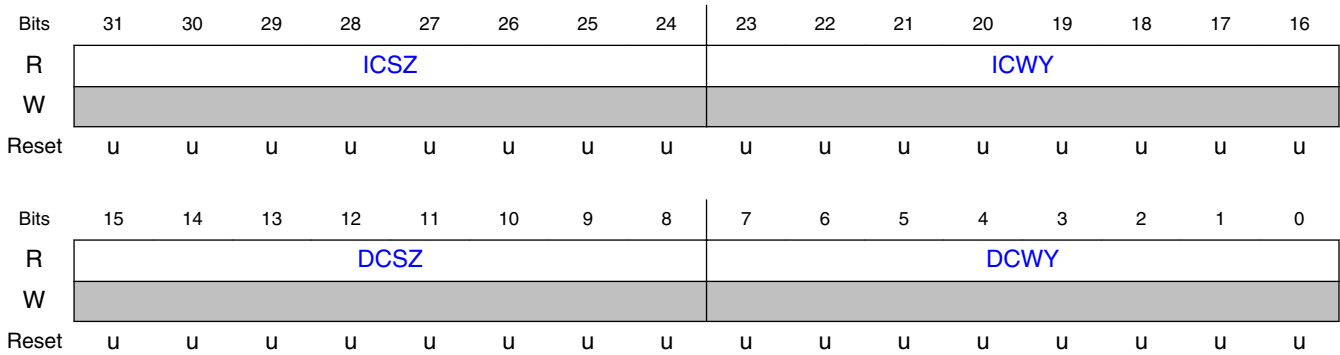

34.4.2.6.4 Fields

Field	Function
31-24 ICSZ	<p>Level 1 Instruction Cache Size</p> <p>This read-only field provides an encoded value of the Instruction Cache size. The capacity of the memory is expressed as Size [bytes] = $2^{(8+ICSZ)}$, where ICSZ is non-zero; a ICSZ = 0 indicates the memory is not present.</p> <ul style="list-style-type: none"> • if no Instruction Cache, then ICSZ = 0x00 • if a 512 byte Instruction Cache, then ICSZ = 0x01 • if a 1 Kbyte Instruction Cache, then ICSZ = 0x02 • if a 2 Kbyte Instruction Cache, then ICSZ = 0x03 • if a 4 Kbyte Instruction Cache, then ICSZ = 0x04 • if an 8 Kbyte Instruction Cache, then ICSZ = 0x05 • if a 16 Kbyte Instruction Cache, then ICSZ = 0x06 • if a 32 Kbyte Instruction Cache, then ICSZ = 0x07 • if a 64 Kbyte Instruction Cache, then ICSZ = 0x08
23-16 ICWY	Level 1 Instruction Cache Ways

Table continues on the next page...

MSCM Memory Map/Register Definition

Field	Function
	This read-only field provides the number of cache ways for the Instruction Cache. ICWY=0x00 indicates not present.
15-8 DCSZ	<p>Level 1 Data Cache Size</p> <p>This read-only field provides an encoded value of the Data Cache size. The capacity of the memory is expressed as Size [bytes] = $2^{(8+DCSZ)}$, where DCSZ is non-zero; a DCSZ = 0 indicates the memory is not present.</p> <ul style="list-style-type: none"> • if no Data Cache, then DCSZ = 0x00 • if a 512 byte Data Cache, then DCSZ = 0x01 • if a 1 Kbyte Data Cache, then DCSZ = 0x02 • if a 2 Kbyte Data Cache, then DCSZ = 0x03 • if a 4 Kbyte Data Cache, then DCSZ = 0x04 • if an 8 Kbyte Data Cache, then DCSZ = 0x05 • if a 16 Kbyte Data Cache, then DCSZ = 0x06 • if a 32 Kbyte Data Cache, then DCSZ = 0x07 • if a 64 Kbyte Data Cache, then DCSZ = 0x08
7-0 DCWY	<p>Level 1 Data Cache Ways</p> <p>This read-only field provides the number of cache ways for the Data Cache. DCWY=0x00 indicates not present.</p>

34.4.2.7 Processor X Configuration Register 1 (CPxCFG1)

34.4.2.7.1 Offset

Register	Offset
CPxCFG1	14h

34.4.2.7.2 Function

The CPxCFG1 register provides a CPU-specific response detailing configuration information, in this case, information on a Level 2 cache (if present).

Access: Privileged read-only

NOTE

Reset values for the Processor X Configuration Register 1:

- For CPU0 - CPxCFG1 = 0x00000000
- If the read access is not from a CPU, then the value read is 0x00000000

34.4.2.7.3 Diagram

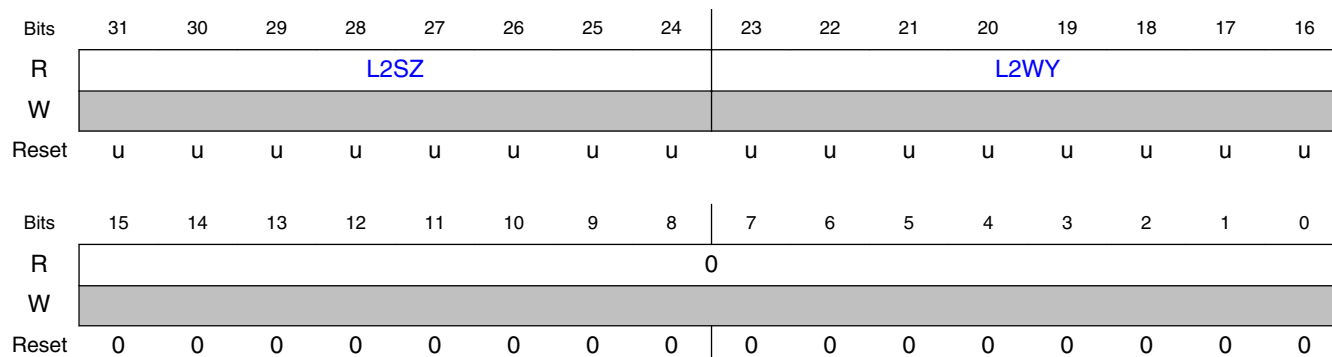

34.4.2.7.4 Fields

Field	Function
31-24 L2SZ	<p>Level 2 Instruction Cache Size</p> <p>This read-only field provides an encoded value of the Instruction Cache size. The capacity of the memory is expressed as Size [bytes] = $2^{(8+L2SZ)}$, where L2SZ is non-zero; a L2SZ = 0 indicates the memory is not present.</p> <ul style="list-style-type: none"> • if no Level 2 Cache, then L2SZ = 0x00 • if a 512 byte Level 2 Cache, then L2SZ = 0x01 • if a 1 Kbyte Level 2 Cache, then L2SZ = 0x02 • if a 2 Kbyte Level 2 Cache, then L2SZ = 0x03 • if a 4 Kbyte Level 2 Cache, then L2SZ = 0x04 • if an 8 Kbyte Level 2 Cache, then L2SZ = 0x05 • if a 16 Kbyte Level 2 Cache, then L2SZ = 0x06 • if a 32 Kbyte Level 2 Cache, then L2SZ = 0x07 • if a 64 Kbyte Level 2 Cache, then L2SZ = 0x08
23-16 L2WY	<p>Level 2 Instruction Cache Ways</p> <p>This read-only field provides the number of cache ways for the Instruction Cache. L2WY=0x00 indicates not present.</p>
15-0 —	Reserved

34.4.2.8 Processor X Configuration Register 2 (CPxCFG2)

34.4.2.8.1 Offset

Register	Offset
CPxCFG2	18h

34.4.2.8.2 Function

The CPxCFG2 register provides a CPU-specific response detailing configuration information, in this case, information on tightly-coupled local memories (if present).

NOTE

Reset values for the Processor X Configuration Register 2:

- For CPU0 - CPxCFG2 = 0x09010901
- If the read access is not from a CPU, then the value read is 0x00000000

34.4.2.8.3 Diagram

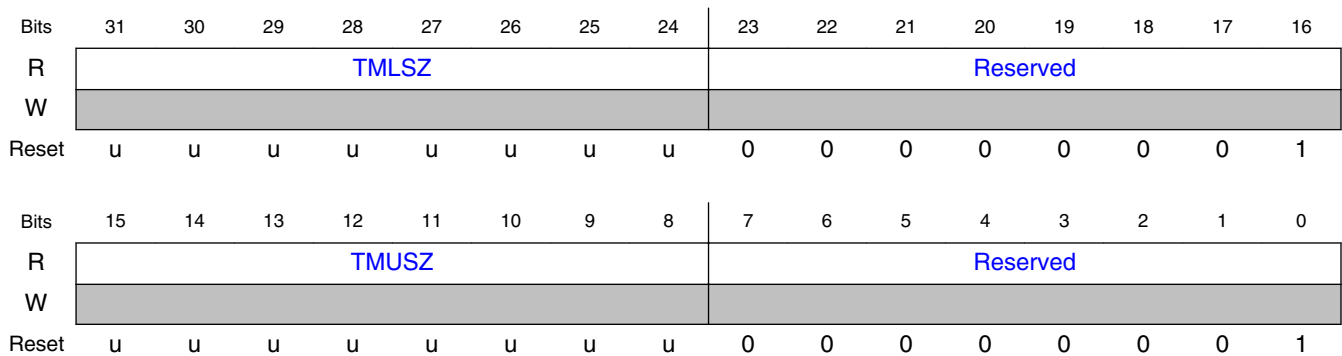

34.4.2.8.4 Fields

Field	Function
31-24 TMLSZ	<p>Tightly-coupled Memory Lower Size</p> <p>This field provides an encoded value of the tightly-coupled local memory lower size. The capacity of the memory is expressed as Size [bytes] = $2^{(8+TMLSZ)}$, where TMLSZ is non-zero; a TMLSZ = 0 indicates the memory is not present.</p> <ul style="list-style-type: none"> • if no TCML, then TMLSZ = 0x00 • if a 512 byte TCML, then TMLSZ = 0x01 • if a 1 Kbyte TCML, then TMLSZ = 0x02 • if a 2 Kbyte TCML, then TMLSZ = 0x03 • if a 4 Kbyte TCML, then TMLSZ = 0x04 • if an 8 Kbyte TCML, then TMLSZ = 0x05 • if a 16 Kbyte TCML, then TMLSZ = 0x06 • if a 32 Kbyte TCML, then TMLSZ = 0x07 • if a 64 Kbyte TCML, then TMLSZ = 0x08 • if a 128 Kbyte TCML, then TMLSZ = 0x09
23-16 —	Reserved
15-8	Tightly-coupled Memory Upper Size

Table continues on the next page...

Field	Function
TMUSZ	<p>This field provides an encoded value of the tightly-coupled local memory upper size. The capacity of the memory is expressed as $\text{Size [bytes]} = 2^{(8+\text{TMUSZ})}$, where TMUSZ is non-zero; a TMUSZ = 0 indicates the memory is not present.</p> <ul style="list-style-type: none"> • if no TCMU, then TMUSZ = 0x00 • if a 512 byte TCMU, then TMUSZ = 0x01 • if a 1 Kbyte TCMU, then TMUSZ = 0x02 • if a 2 Kbyte TCMU, then TMUSZ = 0x03 • if a 4 Kbyte TCMU, then TMUSZ = 0x04 • if an 8 Kbyte TCMU, then TMUSZ = 0x05 • if a 16 Kbyte TCMU, then TMUSZ = 0x06 • if a 32 Kbyte TCMU, then TMUSZ = 0x07 • if a 64 Kbyte TCMU, then TMUSZ = 0x08 • if a 128 Kbyte TCMU, then TMUSZ = 0x09
7-0 —	Reserved

34.4.2.9 Processor X Configuration Register 3 (CPxCFG3)

34.4.2.9.1 Offset

Register	Offset
CPxCFG3	1Ch

34.4.2.9.2 Function

The CPxCFG3 register provides a CPU-specific response detailing configuration information, in this case, information on processor options.

NOTE

Reset values for the Processor X Configuration Register 3:

- For CPU0 - CPxCFG3 = 0x00000101
- If the read access is not from a CPU, then the value read is 0x00000000

34.4.2.9.3 Diagram

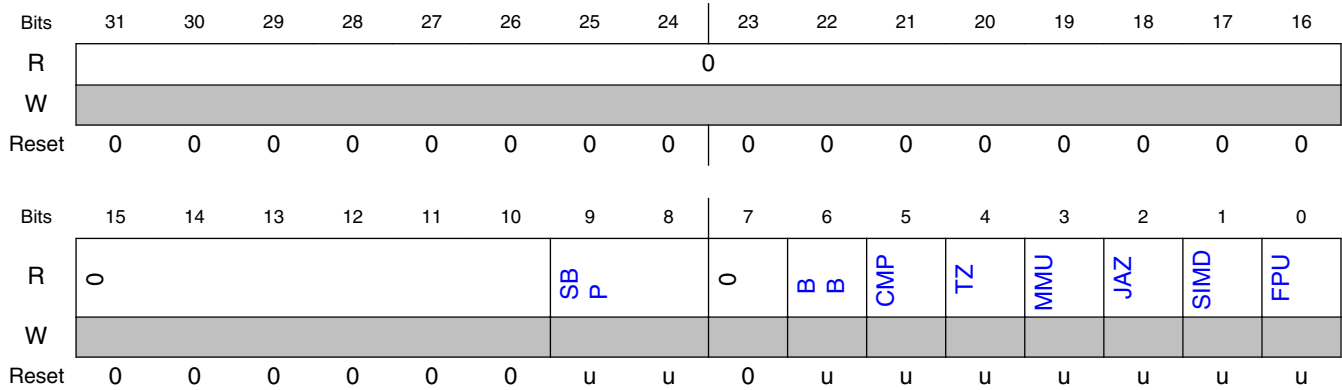

34.4.2.9.4 Fields

Field	Function
31-10 —	Reserved
9-8 SBP	System Bus Ports This field defines the number of physical connections to the system bus fabric for this processor.
7 —	Reserved
6 BB	Bit Banding This field defines if the processor supports "bit banding". 0b - Bit Banding is not supported. 1b - Bit Banding is supported.
5 CMP	Core Memory Protection unit This field indicates if the core memory protection hardware is included in the processor. 0b - Core Memory Protection is not included. 1b - Core Memory Protection is included.
4 TZ	Trust Zone This field indicates if the Trust Zone capabilities are supported in the processor.. 0b - Trust Zone support is not included. 1b - Trust Zone support is included.
3 MMU	Memory Management Unit Memory Management Unit. This field indicates if the virtual memory management capabilities are supported in the processor. 0b - MMU support is not included. 1b - MMU support is included.
2 JAZ	Jazelle support This field indicates if Jazelle hardware is supported in the processor. 0b - Jazelle support is not included.

Table continues on the next page...

Field	Function
	1b - Jazelle support is included.
1 SIMD	SIMD/NEON instruction support This field indicates if the instruction set extensions supporting SIMD and/or NEON capabilities are supported in the processor. 0b - SIMD/NEON support is not included. 1b - SIMD/NEON support is included.
0 FPU	Floating Point Unit This field indicates if hardware support for floating point capabilities are supported in the processor. 0b - FPU support is not included. 1b - FPU support is included.

34.4.2.10 Processor 0 Type Register (CP0TYPE)

34.4.2.10.1 Offset

Register	Offset
CP0TYPE	20h

34.4.2.10.2 Function

The register provides the personality of Processor 0. The 32-bit response includes 3 ASCII characters defining the CPU type, along with a byte defining the logical revision number. The logical revision number follows Arm's rYpZ nomenclature.

34.4.2.10.3 Diagram

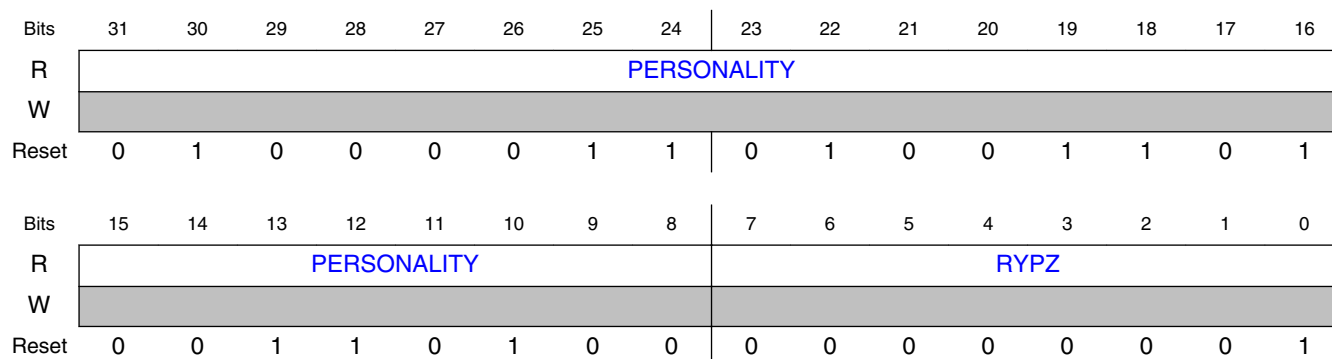

34.4.2.10.4 Fields

Field	Function
31-8 PERSONALITY	Processor 0 Personality This read-only field defines the processor personality for CP0 CP0 = Cortex-M4, then PERSONALITY = 0x43_4D_34 ("CM4").
7-0 RYPZ	Processor 0 Revision This read-only field defines the processor revision for CPU0: 0x00 corresponds to the r0p0 core release. 0x01 corresponds to the r0p1 core release. ...

34.4.2.11 Processor 0 Number Register (CP0NUM)

34.4.2.11.1 Offset

Register	Offset
CP0NUM	24h

34.4.2.11.2 Function

The register provides the logical processor number of Processor 0. The logical processor number is always 0.

34.4.2.11.3 Diagram

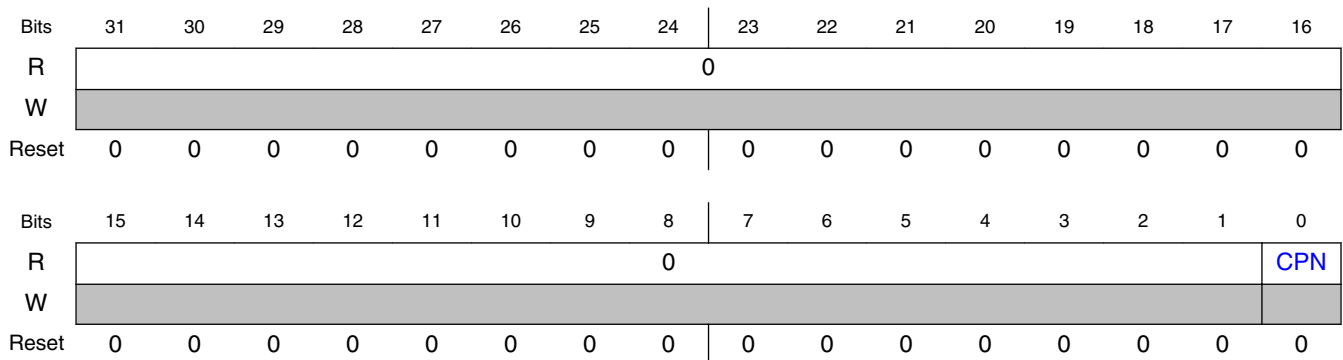

34.4.2.11.4 Fields

Field	Function
31-1 —	Reserved
0 CPN	Processor 0 Number This zero-filled word defines the logical processor number for CPU0 If single core configuration, then CPN = 0

34.4.2.12 Processor 0 Master Register (CP0MASTER)

34.4.2.12.1 Offset

Register	Offset
CP0MASTER	28h

34.4.2.12.2 Function

The register provides the physical bus master number of Processor 0.

34.4.2.12.3 Diagram

Bits	31	30	29	28	27	26	25	24	23	22	21	20	19	18	17	16
R	0															
W																
Reset	0	0	0	0	0	0	0	0	0	0	0	0	0	0	0	0
Bits	15	14	13	12	11	10	9	8	7	6	5	4	3	2	1	0
R	0								PPMN							
W																
Reset	0	0	0	0	0	0	0	0	0	0	0	0	0	0	0	0

34.4.2.12.4 Fields

Field	Function
31-6	Reserved

Table continues on the next page...

MSCM Memory Map/Register Definition

Field	Function
—	
5-0 PPMN	Processor 0 Physical Master Number This read-only field defines the physical bus master number for CPU0

34.4.2.13 Processor 0 Count Register (CP0COUNT)

34.4.2.13.1 Offset

Register	Offset
CP0COUNT	2Ch

34.4.2.13.2 Function

The register indicates the total number of processor cores in the chip configuration.

34.4.2.13.3 Diagram

Bits	31	30	29	28	27	26	25	24	23	22	21	20	19	18	17	16
R	0															
W																
Reset	0	0	0	0	0	0	0	0	0	0	0	0	0	0	0	0
Bits	15	14	13	12	11	10	9	8	7	6	5	4	3	2	1	0
R	0															PCNT
W																
Reset	0	0	0	0	0	0	0	0	0	0	0	0	0	0	0	0

34.4.2.13.4 Fields

Field	Function
31-2 —	Reserved
1-0 PCNT	Processor Count This read-only field defines the processor count for the chip configuration: PCNT = 00 (Single Core)

34.4.2.14 Processor 0 Configuration Register 0 (CP0CFG0)

34.4.2.14.1 Offset

Register	Offset
CP0CFG0	30h

34.4.2.14.2 Function

The CP0CFG0 register provides information on the CPU0 Level 1 caches (if present).

Access: Privileged read-only

NOTE

Reset values for the Processor 0 Configuration Register 0:

- CP0CFG0 = 0x04000000

34.4.2.14.3 Diagram

Bits	31	30	29	28	27	26	25	24	23	22	21	20	19	18	17	16
R	ICSZ								ICWY							
W	[Shaded]															
Reset	0	0	0	0	0	1	0	0	0	0	0	0	0	0	0	0
Bits	15	14	13	12	11	10	9	8	7	6	5	4	3	2	1	0
R	DCSZ								DCWY							
W	[Shaded]															
Reset	0	0	0	0	0	0	0	0	0	0	0	0	0	0	0	0

34.4.2.14.4 Fields

Field	Function
31-24	Level 1 Instruction Cache Size
ICSZ	<p>This read-only field provides an encoded value of the Instruction Cache size. The capacity of the memory is expressed as $\text{Size [bytes]} = 2^{(8+\text{ICSZ})}$, where ICSZ is non-zero; a ICSZ = 0 indicates the memory is not present.</p> <ul style="list-style-type: none"> • if no Instruction Cache, then ICSZ = 0x00 • if a 512 byte Instruction Cache, then ICSZ = 0x01 • if a 1 Kbyte Instruction Cache, then ICSZ = 0x02 • if a 2 Kbyte Instruction Cache, then ICSZ = 0x03

Table continues on the next page...

MSCM Memory Map/Register Definition

Field	Function
	<ul style="list-style-type: none"> • if a 4 Kbyte Instruction Cache, then ICSZ = 0x04 • if an 8 Kbyte Instruction Cache, then ICSZ = 0x05 • if a 16 Kbyte Instruction Cache, then ICSZ = 0x06 • if a 32 Kbyte Instruction Cache, then ICSZ = 0x07 • if a 64 Kbyte Instruction Cache, then ICSZ = 0x08
23-16 ICWY	<p>Level 1 Instruction Cache Ways</p> <p>This read-only field provides the number of cache ways for the Instruction Cache. ICWY=0x00 indicates not present.</p>
15-8 DCSZ	<p>Level 1 Data Cache Size</p> <p>This read-only field provides an encoded value of the Data Cache size. The capacity of the memory is expressed as Size [bytes] = $2^{(8+DCSZ)}$, where DCSZ is non-zero; a DCSZ = 0 indicates the memory is not present.</p> <ul style="list-style-type: none"> • if no Data Cache, then DCSZ = 0x00 • if a 512 byte Data Cache, then DCSZ = 0x01 • if a 1 Kbyte Data Cache, then DCSZ = 0x02 • if a 2 Kbyte Data Cache, then DCSZ = 0x03 • if a 4 Kbyte Data Cache, then DCSZ = 0x04 • if an 8 Kbyte Data Cache, then DCSZ = 0x05 • if a 16 Kbyte Data Cache, then DCSZ = 0x06 • if a 32 Kbyte Data Cache, then DCSZ = 0x07 • if a 64 Kbyte Data Cache, then DCSZ = 0x08
7-0 DCWY	<p>Level 1 Data Cache Ways</p> <p>This read-only field provides the number of cache ways for the Data Cache. DCWY=0x00 indicates not present.</p>

34.4.2.15 Processor 0 Configuration Register 1 (CP0CFG1)

34.4.2.15.1 Offset

Register	Offset
CP0CFG1	34h

34.4.2.15.2 Function

The CP0CFG1 register provides information on CPU0 Level 2 cache (if present).

Access: Privileged read-only

NOTE

Reset values for the Processor 0 Configuration Register 1:

- CP0CFG1 = 0x00000000

34.4.2.15.3 Diagram

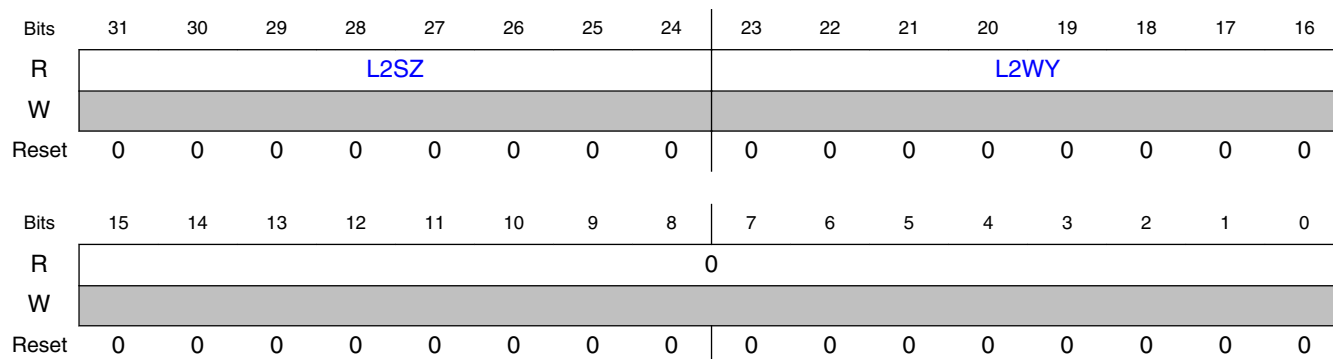

34.4.2.15.4 Fields

Field	Function
31-24 L2SZ	<p>Level 2 Instruction Cache Size</p> <p>This read-only field provides an encoded value of the Instruction Cache size. The capacity of the memory is expressed as $\text{Size [bytes]} = 2^{(8+L2SZ)}$, where L2SZ is non-zero; a L2SZ = 0 indicates the memory is not present.</p> <ul style="list-style-type: none"> • if no Level 2 Cache, then L2SZ = 0x00 • if a 512 byte Level 2 Cache, then L2SZ = 0x01 • if a 1 Kbyte Level 2 Cache, then L2SZ = 0x02 • if a 2 Kbyte Level 2 Cache, then L2SZ = 0x03 • if a 4 Kbyte Level 2 Cache, then L2SZ = 0x04 • if an 8 Kbyte Level 2 Cache, then L2SZ = 0x05 • if a 16 Kbyte Level 2 Cache, then L2SZ = 0x06 • if a 32 Kbyte Level 2 Cache, then L2SZ = 0x07 • if a 64 Kbyte Level 2 Cache, then L2SZ = 0x08
23-16 L2WY	<p>Level 2 Instruction Cache Ways</p> <p>This read-only field provides the number of cache ways for the Instruction Cache. L2WY=0x00 indicates not present.</p>
15-0 —	Reserved

34.4.2.16 Processor 0 Configuration Register 2 (CP0CFG2)

34.4.2.16.1 Offset

Register	Offset
CP0CFG2	38h

34.4.2.16.2 Function

The CP0CFG2 register provides information on CPU0 tightly-coupled local memories (if present).

NOTE

Reset values for the Processor 0 Configuration Register 2:

- CP0CFG2 = 0x09010901

34.4.2.16.3 Diagram

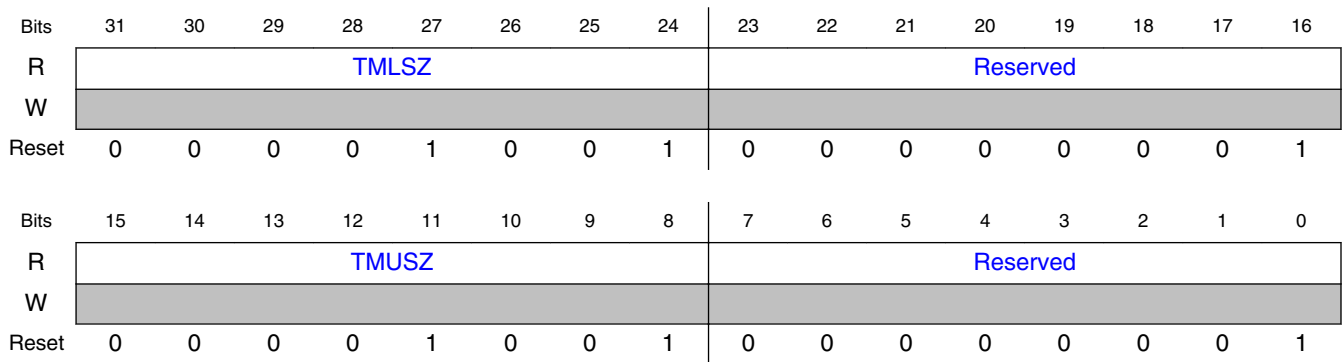

34.4.2.16.4 Fields

Field	Function
31-24 TMLSZ	<p>Tightly-coupled Memory Lower Size</p> <p>This field provides an encoded value of the tightly-coupled local memory lower size. The capacity of the memory is expressed as Size [bytes] = $2^{(8+TMLSZ)}$, where TMLSZ is non-zero; a TMLSZ = 0 indicates the memory is not present.</p> <ul style="list-style-type: none"> • if no TCML, then TMLSZ = 0x00 • if a 512 byte TCML, then TMLSZ = 0x01 • if a 1 Kbyte TCML, then TMLSZ = 0x02 • if a 2 Kbyte TCML, then TMLSZ = 0x03 • if a 4 Kbyte TCML, then TMLSZ = 0x04 • if an 8 Kbyte TCML, then TMLSZ = 0x05 • if a 16 Kbyte TCML, then TMLSZ = 0x06 • if a 32 Kbyte TCML, then TMLSZ = 0x07 • if a 64 Kbyte TCML, then TMLSZ = 0x08 • if a 128 Kbyte TCML, then TMLSZ = 0x09
23-16 —	Reserved
15-8 TMUSZ	<p>Tightly-coupled Memory Upper Size</p> <p>This field provides an encoded value of the tightly-coupled local memory upper size. The capacity of the memory is expressed as Size [bytes] = $2^{(8+TMUSZ)}$, where TMUSZ is non-zero; a TMUSZ = 0 indicates the memory is not present.</p>

Table continues on the next page...

Field	Function
	<ul style="list-style-type: none"> • if no TCMU, then TMUSZ = 0x00 • if a 512 byte TCMU, then TMUSZ = 0x01 • if a 1 Kbyte TCMU, then TMUSZ = 0x02 • if a 2 Kbyte TCMU, then TMUSZ = 0x03 • if a 4 Kbyte TCMU, then TMUSZ = 0x04 • if an 8 Kbyte TCMU, then TMUSZ = 0x05 • if a 16 Kbyte TCMU, then TMUSZ = 0x06 • if a 32 Kbyte TCMU, then TMUSZ = 0x07 • if a 64 Kbyte TCMU, then TMUSZ = 0x08 • if a 128 Kbyte TCMU, then TMUSZ = 0x09
7-0 —	Reserved

34.4.2.17 Processor 0 Configuration Register 3 (CP0CFG3)

34.4.2.17.1 Offset

Register	Offset
CP0CFG3	3Ch

34.4.2.17.2 Function

The CP0CFG3 register provides information on Processor 0 options.

NOTE

Reset values for the Processor 0 Configuration Register 3:

- CP0CFG3 = 0x00000101

34.4.2.17.3 Diagram

Bits	31	30	29	28	27	26	25	24	23	22	21	20	19	18	17	16			
R	0																		
W																			
Reset	0	0	0	0	0	0	0	0	0	0	0	0	0	0	0	0			
Bits	15	14	13	12	11	10	9	8	7	6	5	4	3	2	1	0			
R	0								SB	P	0	B	B	CMP	TZ	MMU	JAZ	SIMD	FPU
W																			
Reset	0	0	0	0	0	0	0	1	0	0	0	0	0	0	0	0	0	0	1

34.4.2.17.4 Fields

Field	Function
31-10 —	Reserved
9-8 SBP	System Bus Ports This field defines the number of physical connections to the system bus fabric for this processor.
7 —	Reserved
6 BB	Bit Banding This field defines if the processor supports "bit banding". 0b - Bit Banding is not supported. 1b - Bit Banding is supported.
5 CMP	Core Memory Protection unit This field indicates if the core memory protection hardware is included in the processor. 0b - Core Memory Protection is not included. 1b - Core Memory Protection is included.
4 TZ	Trust Zone This field indicates if the Trust Zone capabilities are supported in the processor.. 0b - Trust Zone support is not included. 1b - Trust Zone support is included.
3 MMU	Memory Management Unit Memory Management Unit. This field indicates if the virtual memory management capabilities are supported in the processor. 0b - MMU support is not included. 1b - MMU support is included.
2 JAZ	Jazelle support This field indicates if Jazelle hardware is supported in the processor. 0b - Jazelle support is not included. 1b - Jazelle support is included.
1 SIMD	SIMD/NEON instruction support This field indicates if the instruction set extensions supporting SIMD and/or NEON capabilities are supported in the processor. 0b - SIMD/NEON support is not included. 1b - SIMD/NEON support is included.
0 FPU	Floating Point Unit This field indicates if hardware support for floating point capabilities are supported in the processor. 0b - FPU support is not included. 1b - FPU support is included.

34.4.2.18 On-Chip Memory Descriptor Register (OCMDR0)

34.4.2.18.1 Offset

Register	Offset
OCMDR0	400h

34.4.2.18.2 Function

This section of the programming model is an array of 32-bit generic on-chip memory descriptor registers that provide static information about the attached memories, as well as configurable controls (where appropriate).

- Privileged 32-bit reads from a processor core or the debugger return the appropriate processor information.
- Reads from any other bus master return all zeroes.
- Privileged writes from a processor core or the debugger to writeable registers update the appropriate fields.
- Privileged writes from other bus masters are ignored.
- Attempted user mode accesses or any access with a size other than 32 bits are terminated with an error.

The following table describes the OCMDR_n reset values and the associated memory type:

OCMDR _n	Reset Value	On-Chip Memory Type
OCMDR0	0xDC089000	Program Flash
OCMDR1	0xCA08B000	Data Flash
OCMDR2	0xC304D000	EEERAM

34.4.2.18.3 Diagram

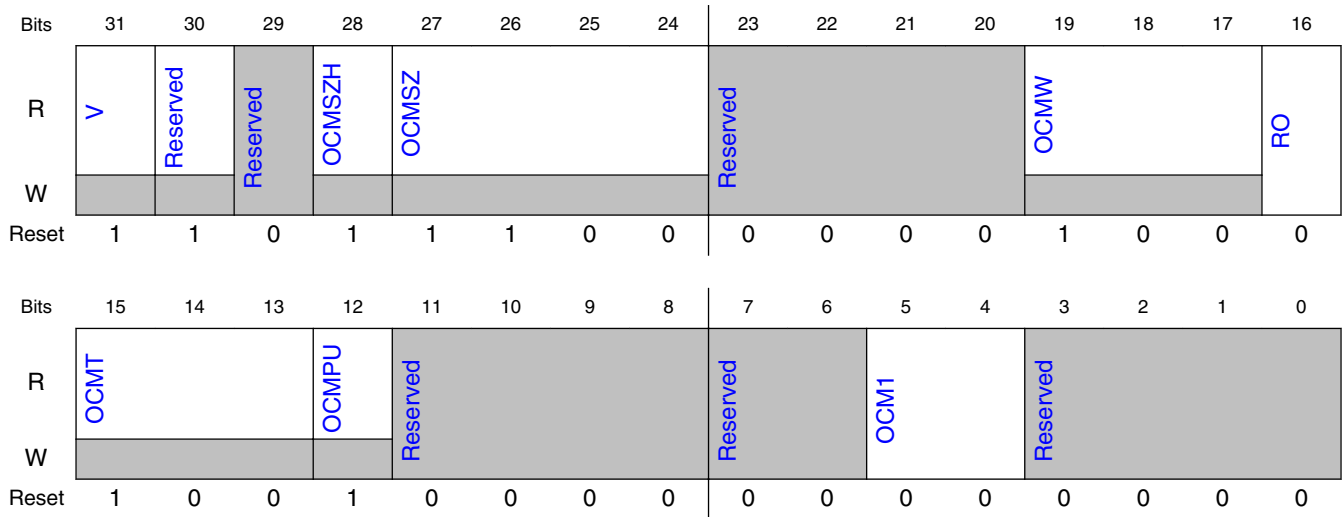

34.4.2.18.4 Fields

Field	Function
31 V	V OCMEM Valid bit. This read-only field defines the validity (presence) of the on-chip memory 0b - OCMEMn is not present. 1b - OCMEMn is present.
30 —	Reserved This Reserved field always has the value of 1.
29 —	Reserved
28 OCMSZH	OCMSZH OCMEM Size “Hole”. For on-chip memories that are not fully populated, that is, include a memory “hole” in the upper 25% of the address range, this bit is used. 0b - OCMEMn is a power-of-2 capacity. 1b - OCMEMn is not a power-of-2, with a capacity is 0.75 * OCMSZ.
27-24 OCMSZ	OCMSZ OCMEM Size. This read-only field provides an encoded value of the on-chip memory size. 0000b - no OCMEMn 0001b - 1KB OCMEMn 0010b - 2KB OCMEMn 0011b - 4KB OCMEMn 0100b - 8KB OCMEMn 0101b - 16KB OCMEMn 0110b - 32KB OCMEMn 0111b - 64KB OCMEMn 1000b - 128KB OCMEMn 1001b - 256KB OCMEMn 1010b - 512KB OCMEMn

Table continues on the next page...

Field	Function
	1011b - 1MB OCMEMn 1100b - 2MB OCMEMn 1101b - 4MB OCMEMn 1110b - 8MB OCMEMn 1111b - 16MB OCMEMn
23-20 —	Reserved
19-17 OCMW	OCMW OCMEM datapath Width. This read-only field defines the width of the on-chip memory: 000-001b - Reserved 010b - OCMEMn 32-bits wide 011b - OCMEMn 64-bits wide 100b - OCMEMn 128-bits wide 101b - OCMEMn 256-bits wide 110-111b - Reserved
16 RO	RO Read-Only. This register bit provides a mechanism to “lock” the configuration state defined by OCMDRn[11:0]. Once asserted, attempted writes to the OCMDRn[11:0] register are ignored until the next reset clears the flag. 0b - Writes to the OCMDRn[11:0] are allowed 1b - Writes to the OCMDRn[11:0] are ignored
15-13 OCMT	OCMT OCMEM Type. This field defines the type of the on-chip memory: 000b - Reserved 001b - Reserved 010b - Reserved 011b - Reserved 100b - OCMEMn is a Program Flash. 101b - OCMEMn is a Data Flash. 110b - OCMEMn is an EEE. 111b - Reserved
12 OCMPU	OCMPU OCMEM Memory Protection Unit. This field is reserved for this device.
11-8 —	Reserved
7-6 —	Reserved
5-4 OCM1	OCMEM Control Field 1 The flash controller needs to be idle when writing to an OCMDRn register associated with Flash memory. This means no read/erase/execute/etc operations from the Flash memory should be made while writing to the OCMDRn register associated with that memory. Changing controller configuration while active can cause undesired results. OCMDRn[4] or OCMDRn[5] bit controls whether prefetches (or speculative accesses) are initiated in response to instruction fetches or data references, see section FMC speculative reads. Value 0 means enable and value 1 means disable.

Table continues on the next page...

Field	Function		
	Flash Speculate (OCMDRn bit 5)	Data Prefetch (OCMDRn bit 4)	Result
	Disabled	Disabled	All speculation disabled and speculation buffer is cleared
	Disabled	Enabled	
	Enabled	Disabled	Speculation for Instruction enabled and Speculation for Data disabled
	Enabled	Enabled	Speculation for both Instruction and Data enabled
3-0 —	Reserved		

34.4.2.19 On-Chip Memory Descriptor Register (OCMDR1)

34.4.2.19.1 Offset

Register	Offset
OCMDR1	404h

34.4.2.19.2 Function

This section of the programming model is an array of 32-bit generic on-chip memory descriptor registers that provide static information about the attached memories, as well as configurable controls (where appropriate).

- Privileged 32-bit reads from a processor core or the debugger return the appropriate processor information.
- Reads from any other bus master return all zeroes.
- Privileged writes from a processor core or the debugger to writeable registers update the appropriate fields.
- Privileged writes from other bus masters are ignored.
- Attempted user mode accesses or any access with a size other than 32 bits are terminated with an error.

The following table describes the OCMDRn reset values and the associated memory type:

OCMDRn	Reset Value	On-Chip Memory Type
OCMDR0	0xDC089000	Program Flash
OCMDR1	0xCA08B000	Data Flash
OCMDR2	0xC304D000	EEERAM

34.4.2.19.3 Diagram

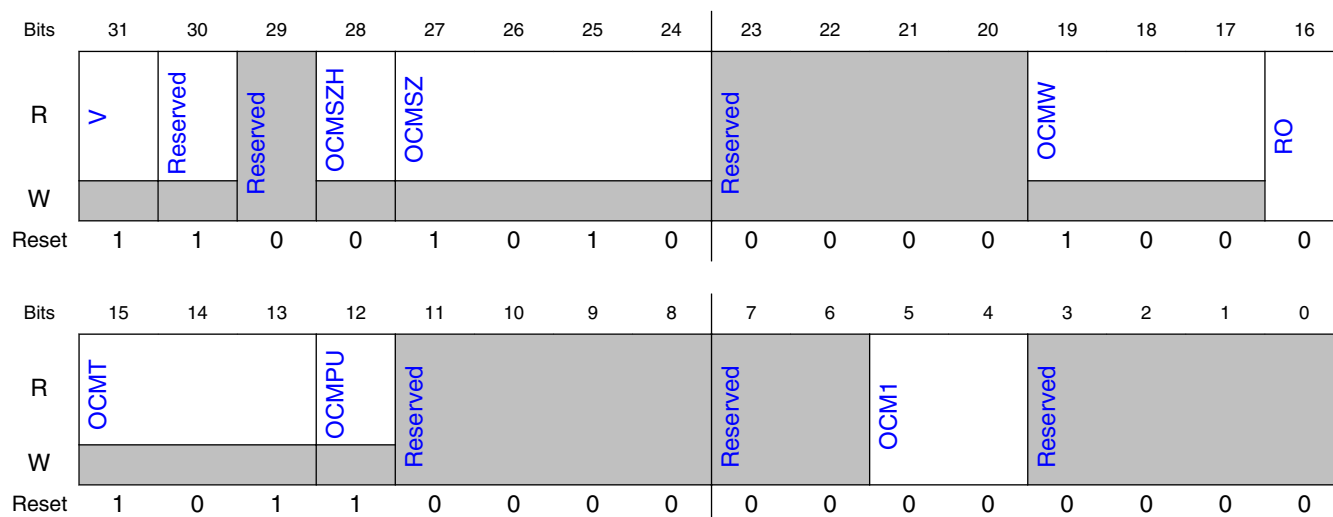

34.4.2.19.4 Fields

Field	Function
31 V	V OCMEM Valid bit. This read-only field defines the validity (presence) of the on-chip memory 0b - OCMEMn is not present. 1b - OCMEMn is present.
30 —	Reserved This Reserved field always has the value of 1.
29 —	Reserved
28 OCMSZH	OCMSZH OCMEM Size “Hole”. For on-chip memories that are not fully populated, that is, include a memory “hole” in the upper 25% of the address range, this bit is used. 0b - OCMEMn is a power-of-2 capacity. 1b - OCMEMn is not a power-of-2, with a capacity is 0.75 * OCMSZ.
27-24 OCMSZ	OCMSZ OCMEM Size. This read-only field provides an encoded value of the on-chip memory size. 0000b - no OCMEMn

Table continues on the next page...

MSCM Memory Map/Register Definition

Field	Function
	0001b - 1KB OCMEMn 0010b - 2KB OCMEMn 0011b - 4KB OCMEMn 0100b - 8KB OCMEMn 0101b - 16KB OCMEMn 0110b - 32KB OCMEMn 0111b - 64KB OCMEMn 1000b - 128KB OCMEMn 1001b - 256KB OCMEMn 1010b - 512KB OCMEMn 1011b - 1MB OCMEMn 1100b - 2MB OCMEMn 1101b - 4MB OCMEMn 1110b - 8MB OCMEMn 1111b - 16MB OCMEMn
23-20 —	Reserved
19-17 OCMW	OCMW OCMEM datapath Width. This read-only field defines the width of the on-chip memory: 000-001b - Reserved 010b - OCMEMn 32-bits wide 011b - OCMEMn 64-bits wide 100b - OCMEMn 128-bits wide 101b - OCMEMn 256-bits wide 110-111b - Reserved
16 RO	RO Read-Only. This register bit provides a mechanism to “lock” the configuration state defined by OCMDRn[11:0]. Once asserted, attempted writes to the OCMDRn[11:0] register are ignored until the next reset clears the flag. 0b - Writes to the OCMDRn[11:0] are allowed 1b - Writes to the OCMDRn[11:0] are ignored
15-13 OCMT	OCMT OCMEM Type. This field defines the type of the on-chip memory: 000b - Reserved 001b - Reserved 010b - Reserved 011b - Reserved 100b - OCMEMn is a Program Flash. 101b - OCMEMn is a Data Flash. 110b - OCMEMn is an EEE. 111b - Reserved
12 OCMPU	OCMPU OCMEM Memory Protection Unit. This field is reserved for this device.
11-8 —	Reserved
7-6 —	Reserved
5-4 OCM1	OCMEM Control Field 1

Table continues on the next page...

Field	Function														
	<p>The flash controller needs to be idle when writing to an OCMDRn register associated with Flash memory. This means no read/erase/execute/etc operations from the Flash memory should be made while writing to the OCMDRn register associated with that memory. Changing controller configuration while active can cause undesired results.</p> <p>OCMDRn[4] or OCMDRn[5] bit controls whether prefetches (or speculative accesses) are initiated in response to instruction fetches or data references, see section FMC speculative reads. Value 0 means enable and value 1 means disable.</p> <table border="1"> <thead> <tr> <th>Flash Speculate (OCMDRn bit 5)</th> <th>Data Prefetch (OCMDRn bit 4)</th> <th>Result</th> </tr> </thead> <tbody> <tr> <td>Disabled</td> <td>Disabled</td> <td rowspan="2">All speculation disabled and speculation buffer is cleared</td> </tr> <tr> <td>Disabled</td> <td>Enabled</td> </tr> <tr> <td>Enabled</td> <td>Disabled</td> <td>Speculation for Instruction enabled and Speculation for Data disabled</td> </tr> <tr> <td>Enabled</td> <td>Enabled</td> <td>Speculation for both Instruction and Data enabled</td> </tr> </tbody> </table>	Flash Speculate (OCMDRn bit 5)	Data Prefetch (OCMDRn bit 4)	Result	Disabled	Disabled	All speculation disabled and speculation buffer is cleared	Disabled	Enabled	Enabled	Disabled	Speculation for Instruction enabled and Speculation for Data disabled	Enabled	Enabled	Speculation for both Instruction and Data enabled
Flash Speculate (OCMDRn bit 5)	Data Prefetch (OCMDRn bit 4)	Result													
Disabled	Disabled	All speculation disabled and speculation buffer is cleared													
Disabled	Enabled														
Enabled	Disabled	Speculation for Instruction enabled and Speculation for Data disabled													
Enabled	Enabled	Speculation for both Instruction and Data enabled													
3-0 —	Reserved														

34.4.2.20 On-Chip Memory Descriptor Register (OCMDR2)

34.4.2.20.1 Offset

Register	Offset
OCMDR2	408h

34.4.2.20.2 Function

This section of the programming model is an array of 32-bit generic on-chip memory descriptor registers that provide static information about the attached memories, as well as configurable controls (where appropriate).

- Privileged 32-bit reads from a processor core or the debugger return the appropriate processor information.
- Reads from any other bus master return all zeroes.
- Privileged writes from a processor core or the debugger to writeable registers update the appropriate fields.
- Privileged writes from other bus masters are ignored.
- Attempted user mode accesses or any access with a size other than 32 bits are terminated with an error.

MSCM Memory Map/Register Definition

The following table describes the OCMDRn reset values and the associated memory type:

OCMDRn	Reset Value	On-Chip Memory Type
OCMDR0	0xDC089000	Program Flash
OCMDR1	0xCA08B000	Data Flash
OCMDR2	0xC304D000	EEERAM

34.4.2.20.3 Diagram

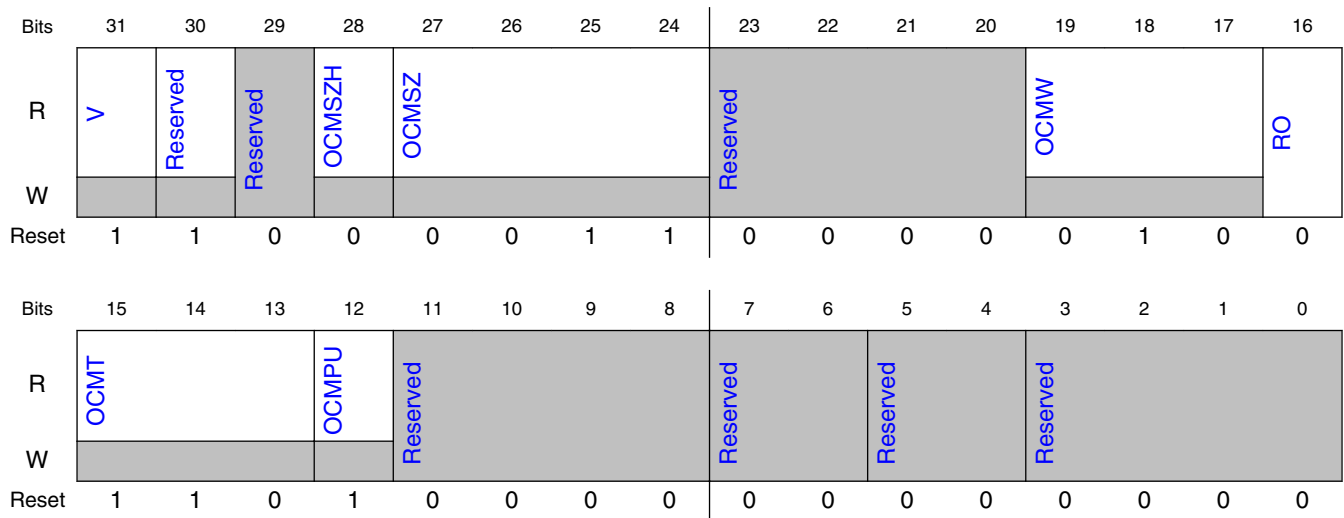

34.4.2.20.4 Fields

Field	Function
31 V	V OCMEM Valid bit. This read-only field defines the validity (presence) of the on-chip memory 0b - OCMEMn is not present. 1b - OCMEMn is present.
30 —	Reserved This Reserved field always has the value of 1.
29 —	Reserved
28 OCMSZH	OCMSZH OCMEM Size “Hole”. For on-chip memories that are not fully populated, that is, include a memory “hole” in the upper 25% of the address range, this bit is used. 0b - OCMEMn is a power-of-2 capacity. 1b - OCMEMn is not a power-of-2, with a capacity is $0.75 * OCMSZ$.

Table continues on the next page...

Field	Function
27-24 OCMSZ	OCMSZ OCMEM Size. This read-only field provides an encoded value of the on-chip memory size. 0000b - no OCMEMn 0001b - 1KB OCMEMn 0010b - 2KB OCMEMn 0011b - 4KB OCMEMn 0100b - 8KB OCMEMn 0101b - 16KB OCMEMn 0110b - 32KB OCMEMn 0111b - 64KB OCMEMn 1000b - 128KB OCMEMn 1001b - 256KB OCMEMn 1010b - 512KB OCMEMn 1011b - 1MB OCMEMn 1100b - 2MB OCMEMn 1101b - 4MB OCMEMn 1110b - 8MB OCMEMn 1111b - 16MB OCMEMn
23-20 —	Reserved
19-17 OCMW	OCMW OCMEM datapath Width. This read-only field defines the width of the on-chip memory: 000-001b - Reserved 010b - OCMEMn 32-bits wide 011b - OCMEMn 64-bits wide 100b - OCMEMn 128-bits wide 101b - OCMEMn 256-bits wide 110-111b - Reserved
16 RO	RO Read-Only. This register bit provides a mechanism to “lock” the configuration state defined by OCMDRn[11:0]. Once asserted, attempted writes to the OCMDRn[11:0] register are ignored until the next reset clears the flag. 0b - Writes to the OCMDRn[11:0] are allowed 1b - Writes to the OCMDRn[11:0] are ignored
15-13 OCMT	OCMT OCMEM Type. This field defines the type of the on-chip memory: 000b - Reserved 001b - Reserved 010b - Reserved 011b - Reserved 100b - OCMEMn is a Program Flash. 101b - OCMEMn is a Data Flash. 110b - OCMEMn is an EEE. 111b - Reserved
12 OCMPU	OCMPU OCMEM Memory Protection Unit. This field is reserved for this device.
11-8 —	Reserved
7-6	Reserved

Table continues on the next page...

MSCM Memory Map/Register Definition

Field	Function
—	
5-4 —	Reserved
3-0 —	Reserved

Chapter 35

Flash Memory Controller (FMC)

35.1 Chip-specific FMC information

This section summarizes how the module has been configured in the chip.

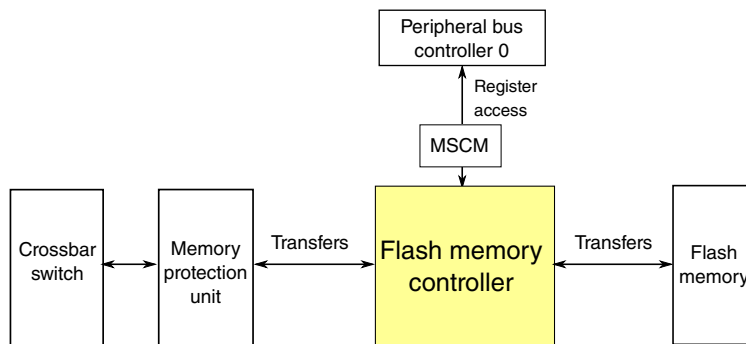

Figure 35-1. Flash Memory Controller configuration

Wait/VLPW mode is not supported on this device. See [Module operation in available power modes](#) for details on available power modes.

Table 35-1. Reference links to related information

Topic	Related module	Reference
System memory map		See attached S32K1xx_memory_map.xlsx
Clocking	System Clock Generator	Clock Distribution
Transfers	Flash memory	Flash Memory Module (FTFC)
Transfers	System MPU	Memory Protection Unit (MPU)
Transfers	Crossbar Switch	Crossbar Switch (AXBS-Lite)
Register access	Peripheral Bridge	Peripheral Bridge (AIPS-Lite)
Register controls	MSCM	OCMC1 field of MSCM registers On-Chip Memory Descriptor Register (OCMDR0)

35.1.1 FMC masters

For master port assignments, see [Crossbar Switch master assignments](#).

35.1.2 Program flash and Data flash port width

For Program flash and Data flash port widths, see [Flash memory sizes](#).

35.1.3 ECC Implementation for NVM

35.1.3.1 ECC Implementation for NVM (for S32K14x devices)

Any single-bit ECC errors are automatically corrected, and any double-bit ECC errors are reflected onto FERSTAT[DFDIF] flag at the read access from Data Flash or Program Flash. When the double-bit ECC error has occurred, the flash controller reports the error to the AHB which causes a bus fault. If Bus fault interrupt is not enabled, the error is handled by the Hard fault. After servicing the Bus fault (if enabled), the Double Bit Fault Detect Interrupt is serviced (if enabled).

35.1.3.2 ECC Implementation for NVM (for S32K11x devices)

Any single-bit ECC errors are automatically corrected, and any double-bit ECC errors are reflected onto FERSTAT[DFDIF] flag at the read access from Data Flash or Program Flash. When the double-bit ECC error has occurred, the flash controller reports the error to the AHB which causes a Hard fault. After servicing the Hard fault, the Double Bit Fault Detect Interrupt is serviced (if enabled).

35.2 Introduction

The Flash Memory Controller (FMC) is a memory acceleration unit that provides:

- an interface between the device and the dual-bank nonvolatile memory. Bank 0 consists of program flash memory, and bank 1 consists of FlexNVM.
- buffers that can accelerate flash memory and FlexNVM data transfers.

35.2.1 Overview

The Flash Memory Controller manages the interface between the device and the dual-bank flash memory. The Program Flash is referred as Bank 0 and the Data Flash is referred as Bank 1. The FMC receives status information detailing the configuration of the memory and uses this information to ensure a proper interface. The following table shows the supported read/write operations.

Flash memory type	Read	Write
Program flash memory	8-bit, 16-bit, and 32-bit reads	— ¹
FlexNVM used as Data flash memory	8-bit, 16-bit, and 32-bit reads	— ¹
FlexNVM and FlexRAM used as emulated EEPROM	8-bit, 16-bit, and 32-bit reads	8-bit, 16-bit, and 32-bit writes

1. A write operation to program flash memory or to FlexNVM used as data flash memory results in a bus error.

In addition, for bank 0 and bank 1, the FMC provides separate mechanisms for accelerating the interface between the device and the flash memory. A 128 (64 for bank1, Data Flash)-bit speculation buffer can prefetch the next 128 (64 for bank1, Data Flash)-bit flash memory location, and a single-entry 128 (64 for bank1, Data Flash)-bit buffer can store previously accessed flash memory or FlexNVM data for quick access times.

35.2.2 Features

The FMC's features include:

- Interface between the device and the dual-bank flash memory and FlexMemory:
 - 8-bit, 16-bit, and 32-bit read operations to program flash memory and FlexNVM used as data flash memory.
 - 8-bit, 16-bit, and 32-bit read and write operations to FlexNVM and FlexRAM used as emulated EEPROM.
 - For bank 0 (Program Flash): The memory returns 128 bits, therefore read accesses to consecutive 32-bit spaces in memory return the second, third, and fourth read data with no wait states. For bank 1 (Data Flash): The memory returns 64 bits, therefore read accesses to consecutive 32-bit spaces in memory return the second read data with no wait states.
- For bank 0 and bank 1: Acceleration of data transfer from program flash memory and FlexMemory to the device:
 - 128 (64 for bank1, Data Flash)-bit prefetch speculation buffer with controls for instruction/data access per master and bank
 - Single-entry buffer per bank

35.3 Modes of operation

The FMC only operates when a bus master accesses the flash memory or FlexMemory.

In terms of device power modes, the FMC only operates in run modes, including VLPR modes.

For any device power mode where the flash memory or FlexMemory cannot be accessed, the FMC is disabled.

35.4 External signal description

The FMC has no external signals.

35.5 Functional description

The FMC is a flash acceleration unit with flexible buffers for user configuration.

Whenever a hit occurs for the prefetch speculation buffer, or the single-entry buffer, the requested data is transferred within a single system clock.

35.5.1 Default configuration

Upon system reset, the FMC is configured to provide a significant level of buffering for transfers from the flash memory or FlexMemory:

- For bank 0 and bank 1:
 - Prefetch support for data and instructions is enabled.
 - The single-entry buffer is enabled.

35.5.2 Speculative reads

The FMC has a single buffer that reads ahead to the next word in the flash memory if there is an idle cycle. Speculative prefetching is programmable for each bank for instruction and/or data accesses using `MSCM_OCMDR0[5]` and `MSCM_OCMDR1[5]` (value 0 means "enables prefetches (or speculative accesses)"). Because many code accesses are sequential, using the speculative prefetch buffer improves performance in most cases.

When speculative reads are enabled, the FMC immediately requests the next sequential address after a read completes. By requesting the next word immediately, speculative reads can help to reduce or even eliminate wait states when accessing sequential code and/or data.

For example, consider the following scenario:

- Assume a system with a 4:1 core-to-flash clock ratio and with speculative reads enabled.
- The core requests four (for Data Flash, bank 1) or eight (for Program Flash, bank 0) sequential longwords in back-to-back requests, meaning there are no core cycle delays except for stalls waiting for flash memory data to be returned.
- None of the data is already stored in the cache or speculation buffer.

In this scenario, the sequence of events for accessing the four (for Data Flash, bank 1) or eight (for Program Flash, bank 0) longwords is as follows:

1. The first longword read requires 4 to 7 core clocks.
2. Due to the 128-bit data bus of the flash memory, the second longword read takes only 1 core clock because the data is already available inside the FMC. For the same reason, the third and fourth longword reads each take only 1 core clock.
3. Per 64-bit for Data Flash (bank 1), accessing the third longword requires 3 core clock cycles. The flash memory read itself takes 4 clocks, but the first clock overlaps with the second longword read.
4. Per 128-bit for Program Flash (bank 0), accessing the fifth longword requires 1 core clock cycle. The flash memory read itself takes 4 clocks, but the access starts immediately after the first read. As a result, 3 clocks for this access overlap with the second, third, and fourth longword reads from the core.
5. Per 64-bit for Data Flash (bank 1), reading the fourth longword, like the second longword, takes only 1 clock due to the 64-bit flash memory data bus.
6. Per 128-bit for Program Flash (bank 0), reading the sixth, seventh, and eighth longwords takes only 1 clock each because the data is already available inside the FMC.

35.6 Initialization and application information

The FMC does not require user initialization. Flash acceleration features are enabled by default.

Chapter 36

Flash Memory Module (FTFC)

36.1 Chip-specific FTFC information

FTFC is available in only S32K1xx series of devices.

This section summarizes how the module has been configured in the chip.

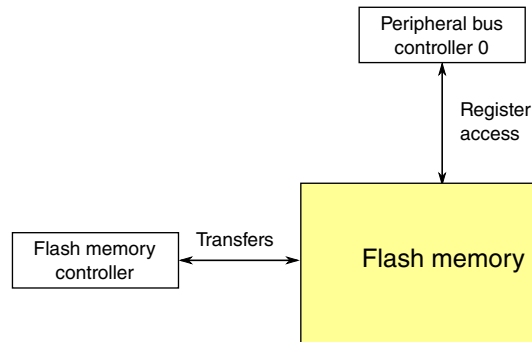

Figure 36-1. Flash memory configuration

Wait mode is not supported on this device. See [Module operation in available power modes](#) for details on power modes.

Table 36-1. Reference links to related information

Topic	Related module	Reference
System memory map		See attached S32K1xx_memory_map.xlsx
Clocking	System Clock Generator	Clock Distribution
Transfers	Flash Memory Controller	Flash Memory Controller (FMC)
Register access	Peripheral Bridge	Peripheral Bridge (AIPS-Lite)

NOTE

During execution of the SetRAM 0xFF and SetRAM 0x00 command (before CCIF flag is set) and PGMPART command any register in modules: LPTimer, SRTC, RCM, SMC and SIM can be read as 0 during this time and can take up to 1 Flash clock

cycle tFlash + 1 bus clock cycle tbus time slot of the command execution. Therefore, it is not recommended to write or read the modules during that window of these commands in execution. The modules operation is not affected by reads.

36.1.1 Flash memory types

The chip contains these types of flash memory:

- Program flash memory: nonvolatile flash memory that can execute program code
- FlexMemory, which encompasses the following memory types:
 - FlexNVM: nonvolatile flash memory that can
 - Execute program code
 - Store data
 - Back up emulated EEPROM data
 - FlexRAM: RAM that
 - Can be used as SRAM or as high-endurance emulated EEPROM storage
 - Accelerates flash-memory programming

NOTE

- PCC_FTFC[CGC] must be 1 during secure boot and when FlexRAM is operating as System RAM.
- CSEc (Security) or EEPROM writes/erase will trigger error flags in HSRUN mode (112 MHz) because this use case is not allowed to execute simultaneously. The device need to switch to RUN mode (80 Mhz) to execute CSEc (Security) or EEPROM writes/erase.

36.1.2 Flash memory sizes

The FTFC module is offered in various configurations. Each configuration consists of one or more read partitions. A given read partition may only be occupied with one task at a time. Having multiple read partitions allows for concurrent operations such as Read While Write (RWW). Special consideration must be given to a partition with FlexNVM in it as the FlexMEM feature is comprised of several aspects including Data Flash, Emulated EEPROM backup, CSEc features (requires Emulated EEPROM to be enabled). Thus, a single FlexMEM read partition could be requested to be read from, programmed, erased, Emulated EEPROM update, or CSEc cryptographic operation, but only one of these at one time.

The sizes of flash memory types on the chip are:

Chips	Program Flash			FlexNVM	FlexRAM	Program Flash port width	Data Flash port width
	Total	Block size	Number of Blocks				
S32K116	128 KB	128 KB	1	32 KB	2 KB	64	64
S32K118	256 KB	256 KB	1	32 KB	2 KB	64	64
S32K142	256 KB	256 KB	1	64 KB	4 KB	64	64
S32K144	512 KB	512 KB	1	64 KB	4 KB	128	64
S32K144W	512 KB	512 KB	1	64 KB	4 KB	128	64
S32K146	1 M	512 KB	2	64 KB	4 KB	128	64
S32K148	Up to 2 M	512 KB	3	Up to 512 KB ¹	4 KB	128	128

1. The available Program Flash is reduced by the size of FlexNVM. When the Program Flash is completely used, then FlexNVM is not available.

NOTE

- PGMPART command must be issued to have all of this memory area available.
- Size of speculative buffer for Program Flash is equal to size of the Program Flash port width. Size of the speculative buffer for Data Flash is equal to the size of the Data flash port width. For details see [FMC chapter](#)

36.1.2.1 128 KB program flash / 32 KB FlexNVM / 2 KB FlexRAM module (S32K116)

The 128KB FTFC flash module consists of two NVM read partitions and one FlexRAM block:

- One 128KB program flash read partition (non-interleaved 1 × 128KB)¹
- One 32KB FlexNVM read partition (non-interleaved 1 × 32 KB)¹
- One 2KB FlexRAM

[Figure 36-2](#) shows the 128KB flash module in various configurations.

NOTE

When the FlexNVM is configured for Emulated EEPROM, the associated E Flash disappears from the memory map as shown

1. Non-interleaved blocks have a data width of 64-bits.

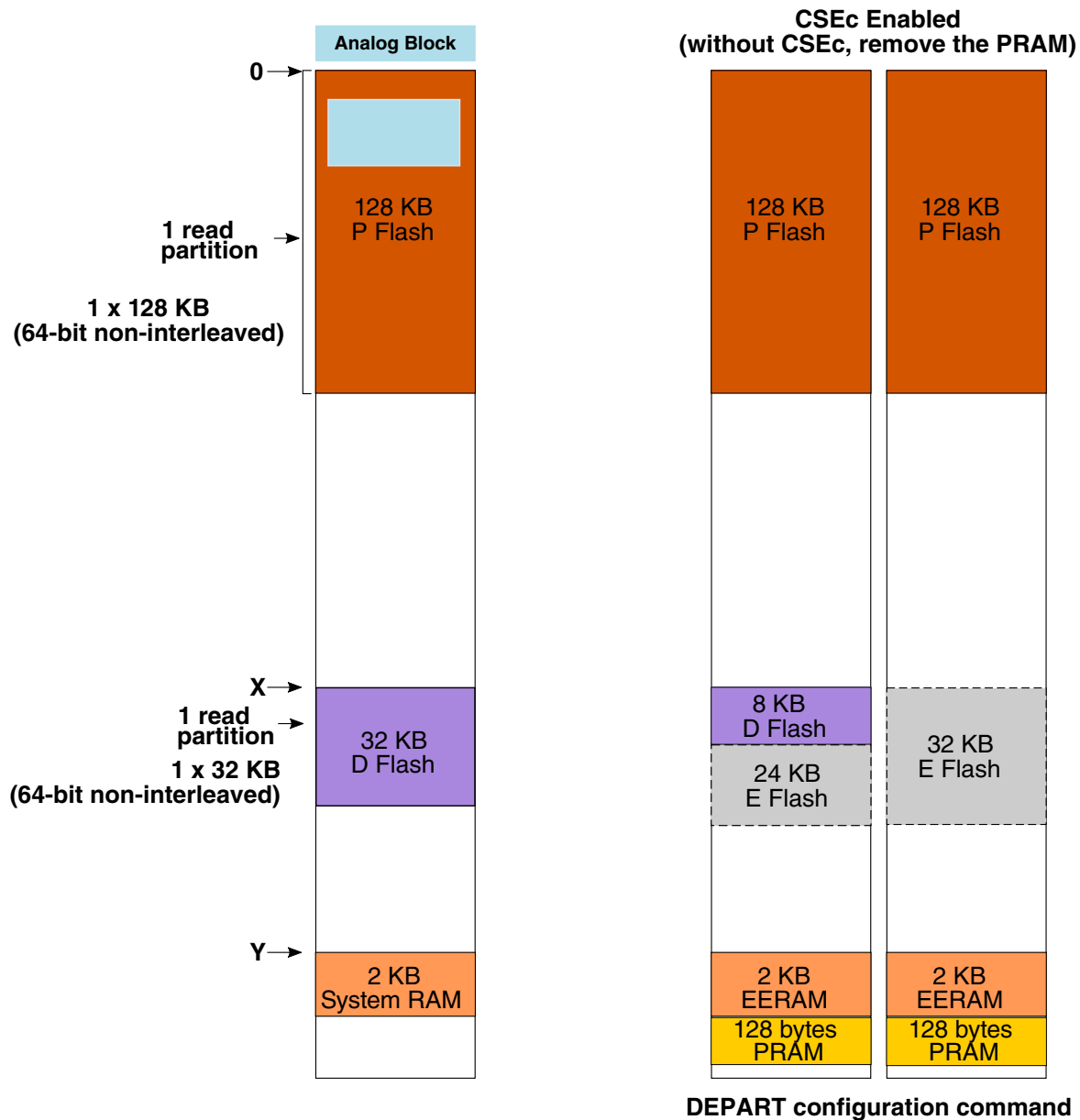

Figure 36-2. 128KB flash memory map

36.1.2.1.1 Emulated EEPROM data set size (EESIZE)

Table 36-2. Emulated EEPROM data set size for 2 KB FlexRAM

Data flash IFR: 0x03FE							
7	6	5	4	3	2	1	0
1	EEERST	1	1	EESIZE			
= Unimplemented or Reserved							

Table 36-3. EEPROM Data Set Size Field Description

Field	Description
7 Reserved	This read-only bitfield is reserved and must always be written as one.
6 EEERST	<p>EEPROM Load on Reset — Determines whether the flash reset sequence takes time to load the FlexRAM with valid EEPROM data.</p> <p>'0' = FlexRAM is not loaded with valid EEPROM data during the flash reset sequence (see the Set FlexRAM Function command to load the FlexRAM with valid EEPROM data)</p> <p>'1' = FlexRAM is loaded with valid EEPROM data during the flash reset sequence</p> <p>For CSEc enabled parts, the FlexRAM is always loaded with valid EEPROM data during the flash reset sequence, and will include the inaccessible Key <n> addresses as applicable.</p>
5-4	Reserved
3-0 EEESIZE	<p>EEPROM Size — Encoding of the total available FlexRAM for emulated EEPROM use.</p> <p>NOTE:</p> <ol style="list-style-type: none"> EEESIZE must be 0 bytes (1111b) when the FlexNVM partition code is set to 'No EEPROM'. For CSEc enabled parts, the EEE size must be '0011' - 2,048 Bytes <p>'0000' = Reserved '0001' = Reserved '0010' = Reserved '0011' = 2,048 Bytes '0100' = Reserved '0101' = Reserved '0110' = Reserved '0111' = Reserved '1000' = Reserved '1001' = Reserved '1010' = Reserved '1011' = Reserved '1100' = Reserved '1101' = Reserved '1110' = Reserved '1111' = 0 Bytes</p>

36.1.2.1.2 FlexNVM partition code (DEPART)

The FlexNVM partition code byte in the data flash 0 IFR supplies a code which specifies how to split the FlexNVM block between data flash memory and emulated EEPROM backup memory supporting emulated EEPROM functions. To program the DEPART value, see the Program Partition command.

Table 36-4. FlexNVM partition code

Data Flash IFR: 0x03FC							
7	6	5	4	3	2	1	0
1	1	1	1	DEPART			
= Unimplemented or Reserved							

Table 36-5. FlexNVM partition code field description

Field	Description																					
7-4 Reserved	This read-only bitfield is reserved and must always be written as one.																					
3-0 DEPART	<p>FlexNVM Partition Code — Encoding of the data flash / emulated EEPROM backup split within the FlexNVM memory block. FlexNVM memory not partitioned for data flash is used to store EEPROM records.</p> <table border="1"> <thead> <tr> <th>DEPART</th> <th>Data flash size (KB)</th> <th>EEPROM backup size (KB)</th> </tr> </thead> <tbody> <tr> <td>0000</td> <td>32</td> <td>0</td> </tr> <tr> <td>0011</td> <td>0</td> <td>32</td> </tr> <tr> <td>1000</td> <td>0</td> <td>32</td> </tr> <tr> <td>1001</td> <td>8</td> <td>24</td> </tr> <tr> <td>1011</td> <td>32</td> <td>0</td> </tr> <tr> <td>1111</td> <td>Default value. FlexNVM not configured with a valid DEPART code</td> <td>-</td> </tr> </tbody> </table>	DEPART	Data flash size (KB)	EEPROM backup size (KB)	0000	32	0	0011	0	32	1000	0	32	1001	8	24	1011	32	0	1111	Default value. FlexNVM not configured with a valid DEPART code	-
DEPART	Data flash size (KB)	EEPROM backup size (KB)																				
0000	32	0																				
0011	0	32																				
1000	0	32																				
1001	8	24																				
1011	32	0																				
1111	Default value. FlexNVM not configured with a valid DEPART code	-																				

36.1.2.2 256 KB program flash / 32 KB FlexNVM / 2 KB FlexRAM module (S32K118)

This 256KB FTFC flash module consists of two NVM read partitions and one FlexRAM block:

- One 256KB program flash read partition (non-interleaved 1 × 256KB)²
- One 32KB FlexNVM read partition (non-interleaved 1 × 32 KB)²
- One 2KB FlexRAM

Figure 36-3 shows the 256KB flash module in various configurations.

NOTE

When the FlexNVM is configured for Emulated EEPROM, the associated EFlash disappears from the memory map as shown

2. Non-interleaved blocks have a data width of 64-bits.

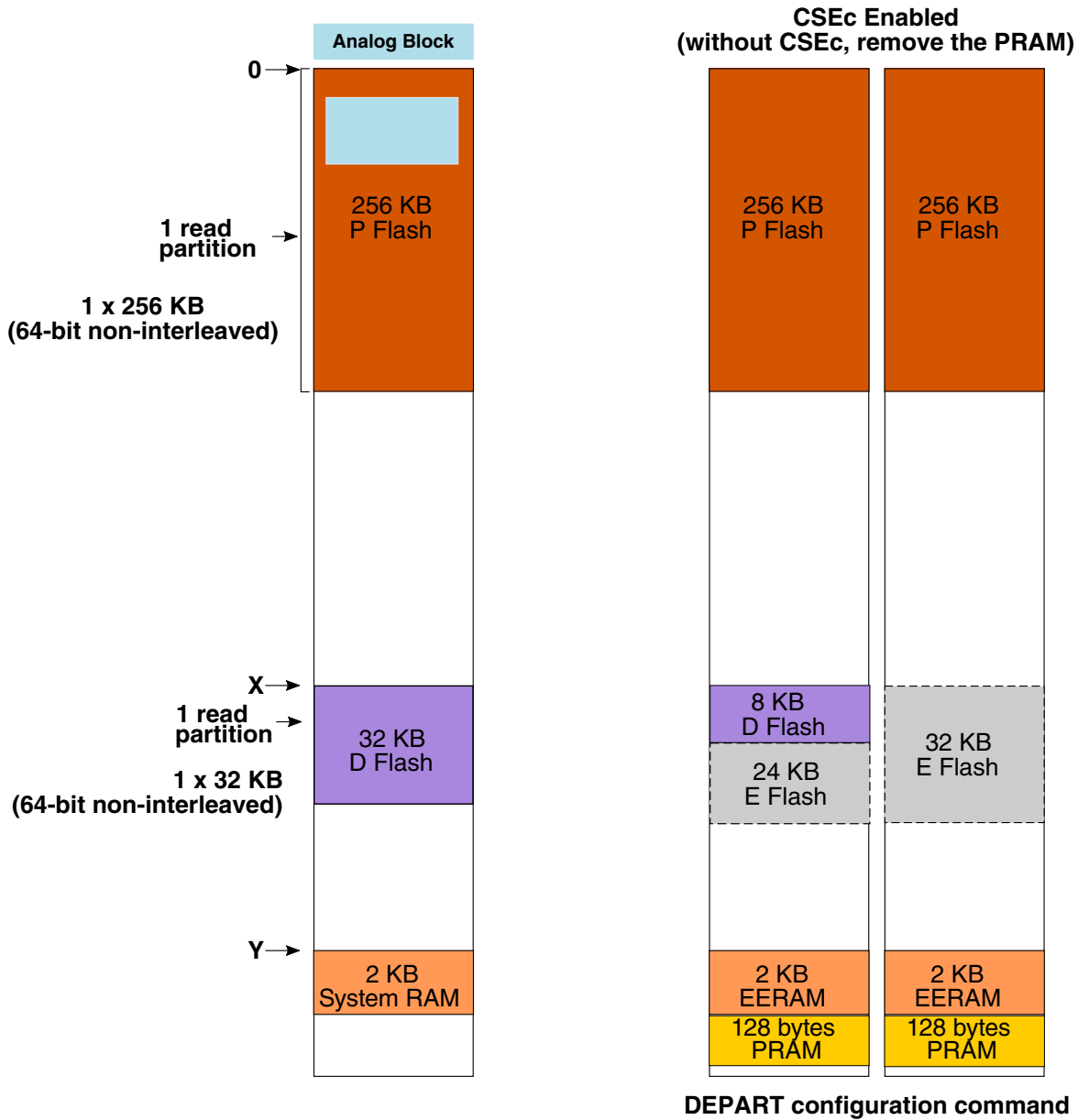

Figure 36-3. 256KB flash memory map

36.1.2.2.1 Emulated EEPROM data set size (EESIZE)

Table 36-6. Emulated EEPROM data set size for 2 KB FlexRAM

Data flash IFR: 0x03FE							
7	6	5	4	3	2	1	0
1	EEERST	1	1	EESIZE			
= Unimplemented or Reserved							

Table 36-7. EEPROM Data Set Size Field Description

Field	Description
7 Reserved	This read-only bitfield is reserved and must always be written as one.
6 EEERST	<p>EEPROM Load on Reset — Determines whether the flash reset sequence takes time to load the FlexRAM with valid EEPROM data.</p> <p>'0' = FlexRAM is not loaded with valid EEPROM data during the flash reset sequence (see the Set FlexRAM Function command to load the FlexRAM with valid EEPROM data)</p> <p>'1' = FlexRAM is loaded with valid EEPROM data during the flash reset sequence</p> <p>For CSEc enabled parts, the FlexRAM is always loaded with valid EEPROM data during the flash reset sequence, and will include the inaccessible Key <n> addresses as applicable.</p>
5-4	Reserved
3-0 EEESIZE	<p>EEPROM Size — Encoding of the total available FlexRAM for emulated EEPROM use.</p> <p>NOTE:</p> <ol style="list-style-type: none"> EEESIZE must be 0 bytes (1111b) when the FlexNVM partition code is set to 'No EEPROM'. For CSEc enabled parts, the EEE size must be '0011' - 2,048 Bytes <p>'0000' = Reserved '0001' = Reserved '0010' = Reserved '0011' = 2,048 Bytes '0100' = Reserved '0101' = Reserved '0110' = Reserved '0111' = Reserved '1000' = Reserved '1001' = Reserved '1010' = Reserved '1011' = Reserved '1100' = Reserved '1101' = Reserved '1110' = Reserved '1111' = 0 Bytes</p>

36.1.2.2.2 FlexNVM partition code (DEPART)

The FlexNVM partition code byte in the data flash 0 IFR supplies a code which specifies how to split the FlexNVM block between data flash memory and emulated EEPROM backup memory supporting emulated EEPROM functions. To program the DEPART value, see the Program Partition command.

Table 36-8. FlexNVM partition code

Data Flash IFR: 0x03FC							
7	6	5	4	3	2	1	0
1	1	1	1	DEPART			
= Unimplemented or Reserved							

Table 36-9. FlexNVM partition code field description

Field	Description																					
7-4 Reserved	This read-only bitfield is reserved and must always be written as one.																					
3-0 DEPART	<p>FlexNVM Partition Code — Encoding of the data flash / emulated EEPROM backup split within the FlexNVM memory block. FlexNVM memory not partitioned for data flash is used to store EEPROM records.</p> <table border="1"> <thead> <tr> <th>DEPART</th> <th>Data flash size (KB)</th> <th>EEPROM backup size (KB)</th> </tr> </thead> <tbody> <tr> <td>0000</td> <td>32</td> <td>0</td> </tr> <tr> <td>0011</td> <td>0</td> <td>32</td> </tr> <tr> <td>1000</td> <td>0</td> <td>32</td> </tr> <tr> <td>1001</td> <td>8</td> <td>24</td> </tr> <tr> <td>1011</td> <td>32</td> <td>0</td> </tr> <tr> <td>1111</td> <td>Default value. FlexNVM not configured with a valid DEPART code</td> <td>-</td> </tr> </tbody> </table>	DEPART	Data flash size (KB)	EEPROM backup size (KB)	0000	32	0	0011	0	32	1000	0	32	1001	8	24	1011	32	0	1111	Default value. FlexNVM not configured with a valid DEPART code	-
DEPART	Data flash size (KB)	EEPROM backup size (KB)																				
0000	32	0																				
0011	0	32																				
1000	0	32																				
1001	8	24																				
1011	32	0																				
1111	Default value. FlexNVM not configured with a valid DEPART code	-																				

36.1.2.3 256 KB program flash / 64 KB FlexNVM / 4 KB FlexRAM module (S32K142)

This 256KB FTFC flash module consists of two NVM read partitions and one FlexRAM block:

- One 256KB program flash read partition (non-interleaved $1 \times 256\text{KB}$)³
- One 64KB FlexNVM read partition (non-interleaved $1 \times 64\text{KB}$)³
- One 4KB FlexRAM

Figure 36-4 shows the 256KB flash module in various configurations.

NOTE

When the FlexNVM is configured for Emulated EEPROM, the associated E Flash disappears from the memory map as shown

3. Non-interleaved blocks have a data width of 64-bits.

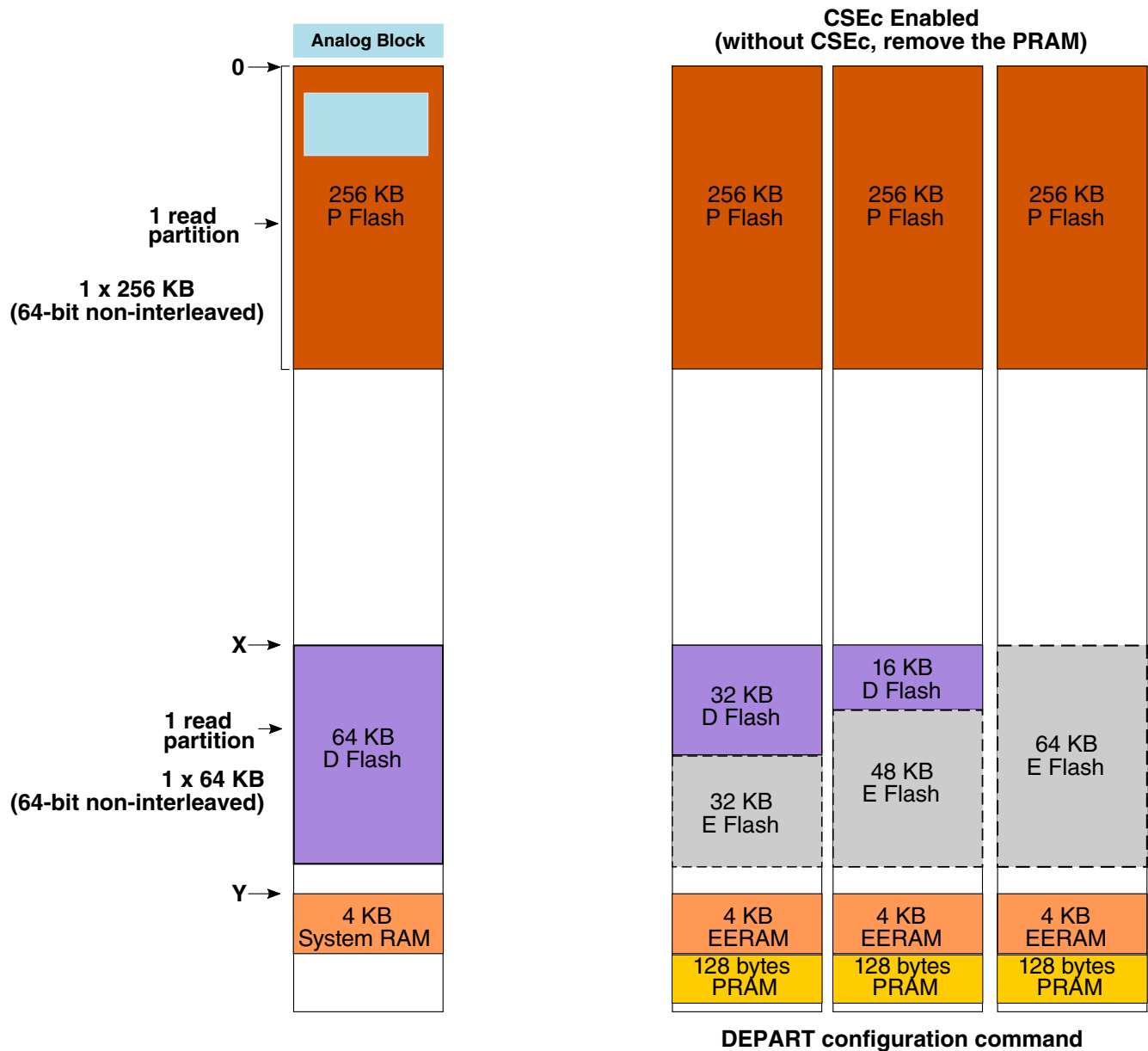

Figure 36-4. 256KB flash memory map

36.1.2.3.1 Emulated EEPROM data set size (EESIZE)

Table 36-10. Emulated EEPROM data set size for 4 KB FlexRAM

Data flash IFR: 0x03FE							
7	6	5	4	3	2	1	0
1	EEERST	1	1	EESIZE			
= Unimplemented or Reserved							

Table 36-11. EEPROM Data Set Size Field Description

Field	Description
7 Reserved	This read-only bitfield is reserved and must always be written as one.
6 EEERST	<p>EEPROM Load on Reset — Determines whether the flash reset sequence takes time to load the FlexRAM with valid EEPROM data.</p> <p>'0' = FlexRAM is not loaded with valid EEPROM data during the flash reset sequence (see the Set FlexRAM Function command to load the FlexRAM with valid EEPROM data)</p> <p>'1' = FlexRAM is loaded with valid EEPROM data during the flash reset sequence</p> <p>For CSEc enabled parts, the FlexRAM is always loaded with valid EEPROM data during the flash reset sequence, and will include the inaccessible Key <n> addresses as applicable.</p>
5-4	Reserved
3-0 EEESIZE	<p>EEPROM Size — Encoding of the total available FlexRAM for emulated EEPROM use.</p> <p>NOTE:</p> <ol style="list-style-type: none"> EEESIZE must be 0 bytes (1111b) when the FlexNVM partition code is set to 'No EEPROM'. For CSEc enabled parts, the EEE size must be '0010' - 4,096 bytes <p>'0000' = Reserved '0001' = Reserved '0010' = 4,096 bytes '0011' = Reserved '0100' = Reserved '0101' = Reserved '0110' = Reserved '0111' = Reserved '1000' = Reserved '1001' = Reserved '1010' = Reserved '1011' = Reserved '1100' = Reserved '1101' = Reserved '1110' = Reserved '1111' = 0 Bytes</p>

36.1.2.3.2 FlexNVM partition code (DEPART)

The FlexNVM partition code byte in the data flash 0 IFR supplies a code which specifies how to split the FlexNVM block between data flash memory and emulated EEPROM backup memory supporting emulated EEPROM functions. To program the DEPART value, see the Program Partition command.

Table 36-12. FlexNVM partition code

Data Flash IFR: 0x03FC							
7	6	5	4	3	2	1	0
1	1	1	1	DEPART			
= Unimplemented or Reserved							

Table 36-13. FlexNVM partition code field description

Field	Description																											
7-4 Reserved	This read-only bitfield is reserved and must always be written as one.																											
3-0 DEPART	<p>FlexNVM Partition Code — Encoding of the data flash / emulated EEPROM backup split within the FlexNVM memory block. FlexNVM memory not partitioned for data flash is used to store EEPROM records.</p> <table border="1"> <thead> <tr> <th>DEPART</th> <th>Data flash size (KB)</th> <th>EEPROM backup size (KB)</th> </tr> </thead> <tbody> <tr> <td>0000</td> <td>64</td> <td>0</td> </tr> <tr> <td>0011</td> <td>32</td> <td>32</td> </tr> <tr> <td>0100</td> <td>0</td> <td>64</td> </tr> <tr> <td>1000</td> <td>0</td> <td>64</td> </tr> <tr> <td>1010</td> <td>16</td> <td>48</td> </tr> <tr> <td>1011</td> <td>32</td> <td>32</td> </tr> <tr> <td>1100</td> <td>64</td> <td>0</td> </tr> <tr> <td>1111</td> <td>Default value. FlexNVM not configured with a valid DEPART code</td> <td>-</td> </tr> </tbody> </table>	DEPART	Data flash size (KB)	EEPROM backup size (KB)	0000	64	0	0011	32	32	0100	0	64	1000	0	64	1010	16	48	1011	32	32	1100	64	0	1111	Default value. FlexNVM not configured with a valid DEPART code	-
DEPART	Data flash size (KB)	EEPROM backup size (KB)																										
0000	64	0																										
0011	32	32																										
0100	0	64																										
1000	0	64																										
1010	16	48																										
1011	32	32																										
1100	64	0																										
1111	Default value. FlexNVM not configured with a valid DEPART code	-																										

36.1.2.4 512 KB program flash / 64 KB FlexNVM / 4 KB FlexRAM module (S32K144)

The 512KB FTFC flash module consists of two NVM read partitions and one FlexRAM block:

- One 512KB program flash read partition (interleaved 2 × 256KB)⁴
- One 64KB FlexNVM read partition (non-interleaved 1 × 64KB)⁵
- One 4KB FlexRAM

Figure 36-5 shows the 512KB flash module in various configurations.

NOTE

When the FlexNVM is configured for Emulated EEPROM, the associated E Flash disappears from the memory map as shown

4. Interleaved blocks have a data width of 128-bits.
 5. Non-interleaved blocks have a data width of 64-bits.

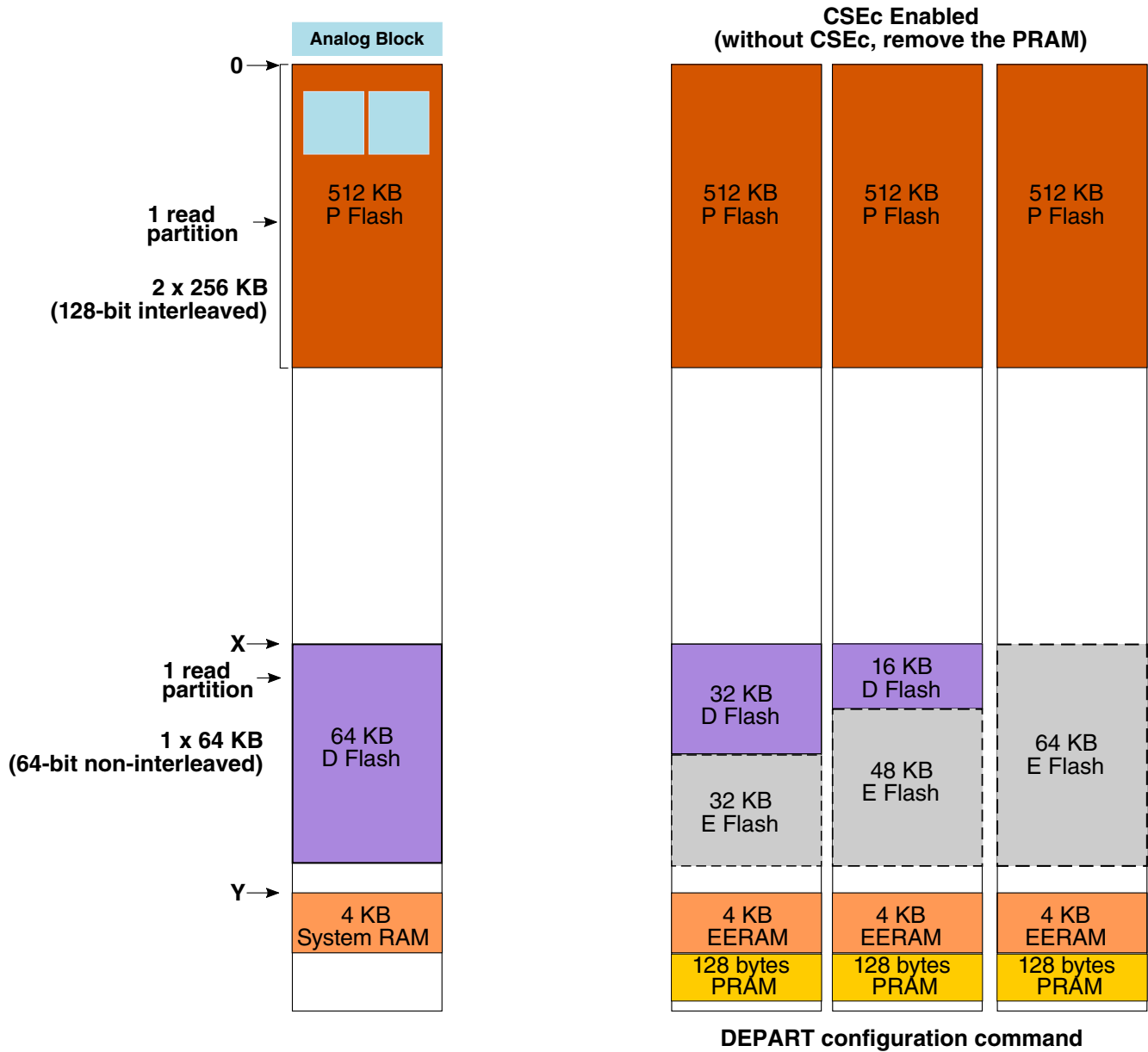

Figure 36-5. 512KB flash memory map

36.1.2.4.1 Emulated EEPROM data set size (EESIZE)

Table 36-14. Emulated EEPROM data set size for 4 KB FlexRAM

Data flash IFR: 0x03FE							
7	6	5	4	3	2	1	0
1	EEERST	1	1	EESIZE			
= Unimplemented or Reserved							

Table 36-15. EEPROM Data Set Size Field Description

Field	Description
7 Reserved	This read-only bitfield is reserved and must always be written as one.
6 EEERST	<p>EEPROM Load on Reset — Determines whether the flash reset sequence takes time to load the FlexRAM with valid EEPROM data.</p> <p>'0' = FlexRAM is not loaded with valid EEPROM data during the flash reset sequence (see the Set FlexRAM Function command to load the FlexRAM with valid EEPROM data)</p> <p>'1' = FlexRAM is loaded with valid EEPROM data during the flash reset sequence</p> <p>For CSEc enabled parts, the FlexRAM is always loaded with valid EEPROM data during the flash reset sequence, and will include the inaccessible Key <n> addresses as applicable.</p>
5-4	Reserved
3-0 EEESIZE	<p>EEPROM Size — Encoding of the total available FlexRAM for emulated EEPROM use.</p> <p>NOTE:</p> <ol style="list-style-type: none"> EEESIZE must be 0 bytes (1111b) when the FlexNVM partition code is set to 'No EEPROM'. For CSEc enabled parts, the EEE size must be '0010' - 4,096 bytes <p>'0000' = Reserved '0001' = Reserved '0010' = 4,096 bytes '0011' = Reserved '0100' = Reserved '0101' = Reserved '0110' = Reserved '0111' = Reserved '1000' = Reserved '1001' = Reserved '1010' = Reserved '1011' = Reserved '1100' = Reserved '1101' = Reserved '1110' = Reserved '1111' = 0 Bytes</p>

36.1.2.4.2 FlexNVM partition code (DEPART)

The FlexNVM partition code byte in the data flash 0 IFR supplies a code which specifies how to split the FlexNVM block between data flash memory and emulated EEPROM backup memory supporting emulated EEPROM functions. To program the DEPART value, see the Program Partition command.

Table 36-16. FlexNVM partition code

Data Flash IFR: 0x03FC							
7	6	5	4	3	2	1	0
1	1	1	1	DEPART			
= Unimplemented or Reserved							

Table 36-17. FlexNVM partition code field description

Field	Description																											
7-4 Reserved	This read-only bitfield is reserved and must always be written as one.																											
3-0 DEPART	<p>FlexNVM Partition Code — Encoding of the data flash / emulated EEPROM backup split within the FlexNVM memory block. FlexNVM memory not partitioned for data flash is used to store EEPROM records.</p> <table border="1"> <thead> <tr> <th>DEPART</th> <th>Data flash size (KB)</th> <th>EEPROM backup size (KB)</th> </tr> </thead> <tbody> <tr> <td>0000</td> <td>64</td> <td>0</td> </tr> <tr> <td>0011</td> <td>32</td> <td>32</td> </tr> <tr> <td>0100</td> <td>0</td> <td>64</td> </tr> <tr> <td>1000</td> <td>0</td> <td>64</td> </tr> <tr> <td>1010</td> <td>16</td> <td>48</td> </tr> <tr> <td>1011</td> <td>32</td> <td>32</td> </tr> <tr> <td>1100</td> <td>64</td> <td>0</td> </tr> <tr> <td>1111</td> <td>Default value. FlexNVM not configured with a valid DEPART code</td> <td>-</td> </tr> </tbody> </table>	DEPART	Data flash size (KB)	EEPROM backup size (KB)	0000	64	0	0011	32	32	0100	0	64	1000	0	64	1010	16	48	1011	32	32	1100	64	0	1111	Default value. FlexNVM not configured with a valid DEPART code	-
DEPART	Data flash size (KB)	EEPROM backup size (KB)																										
0000	64	0																										
0011	32	32																										
0100	0	64																										
1000	0	64																										
1010	16	48																										
1011	32	32																										
1100	64	0																										
1111	Default value. FlexNVM not configured with a valid DEPART code	-																										

36.1.2.5 1 MB program flash / 64 KB FlexNVM / 4 KB FlexRAM module (S32K146)

The 1MB FTFC flash module consists of three NVM read partitions and one FlexRAM block:

- Two 512KB program flash read partitions (interleaved $2 \times 256\text{KB}$)⁶
- One 64KB FlexNVM read partition (non-interleaved $1 \times 64\text{KB}$)⁷
- One 4KB FlexRAM

Figure 36-6 shows the 1MB flash module in various configurations.

NOTE

When the FlexNVM is configured for Emulated EEPROM, the associated E Flash disappears from the memory map as shown

6. Interleaved blocks have a data width of 128-bits.

7. Non-interleaved blocks have a data width of 64-bits.

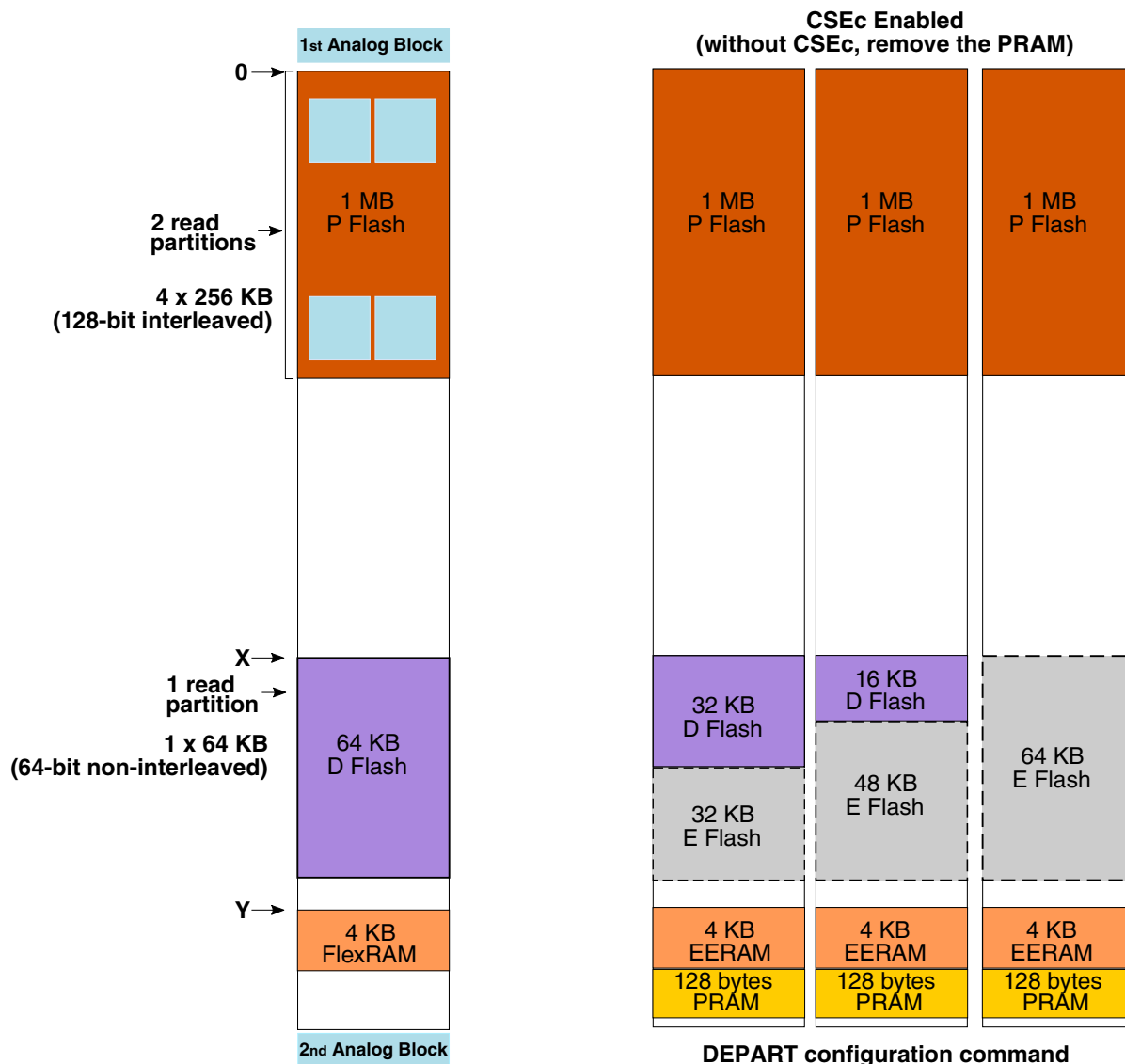

Figure 36-6. 1 MB flash memory map

36.1.2.5.1 Emulated EEPROM data set size (EESIZE)

Table 36-18. Emulated EEPROM data set size for 4 KB FlexRAM

Data flash IFR: 0x03FE							
7	6	5	4	3	2	1	0
1	EEERST	1	1	EESIZE			
= Unimplemented or Reserved							

Table 36-19. EEPROM Data Set Size Field Description

Field	Description
7	This read-only bitfield is reserved and must always be written as one.

Table continues on the next page...

Table 36-19. EEPROM Data Set Size Field Description (continued)

Field	Description
Reserved	
6 EEERST	<p>EEPROM Load on Reset — Determines whether the flash reset sequence takes time to load the FlexRAM with valid EEPROM data.</p> <p>'0' = FlexRAM is not loaded with valid EEPROM data during the flash reset sequence (see the Set FlexRAM Function command to load the FlexRAM with valid EEPROM data)</p> <p>'1' = FlexRAM is loaded with valid EEPROM data during the flash reset sequence</p> <p>For CSEc enabled parts, the FlexRAM is always loaded with valid EEPROM data during the flash reset sequence, and will include the inaccessible Key <n> addresses as applicable.</p>
5-4	Reserved
3-0 EEESIZE	<p>EEPROM Size — Encoding of the total available FlexRAM for emulated EEPROM use.</p> <p>NOTE:</p> <ol style="list-style-type: none"> EEESIZE must be 0 bytes (1111b) when the FlexNVM partition code is set to 'No EEPROM'. For CSEc enabled parts, the EEE size must be '0010' - 4,096 bytes <p>'0000' = Reserved '0001' = Reserved '0010' = 4,096 bytes '0011' = Reserved '0100' = Reserved '0101' = Reserved '0110' = Reserved '0111' = Reserved '1000' = Reserved '1001' = Reserved '1010' = Reserved '1011' = Reserved '1100' = Reserved '1101' = Reserved '1110' = Reserved '1111' = 0 Bytes</p>

36.1.2.5.2 FlexNVM partition code (DEPART)

The FlexNVM partition code byte in the data flash 0 IFR supplies a code which specifies how to split the FlexNVM block between data flash memory and emulated EEPROM backup memory supporting emulated EEPROM functions. To program the DEPART value, see the Program Partition command.

Table 36-20. FlexNVM partition code

Data Flash IFR: 0x03FC							
7	6	5	4	3	2	1	0
1	1	1	1	DEPART			
= Unimplemented or Reserved							

Table 36-21. FlexNVM partition code field description

Field	Description																											
7-4 Reserved	This read-only bitfield is reserved and must always be written as one.																											
3-0 DEPART	<p>FlexNVM Partition Code — Encoding of the data flash / emulated EEPROM backup split within the FlexNVM memory block. FlexNVM memory not partitioned for data flash is used to store EEPROM records.</p> <table border="1"> <thead> <tr> <th>DEPART</th> <th>Data flash size (KB)</th> <th>EEPROM backup size (KB)</th> </tr> </thead> <tbody> <tr> <td>0000</td> <td>64</td> <td>0</td> </tr> <tr> <td>0011</td> <td>32</td> <td>32</td> </tr> <tr> <td>0100</td> <td>0</td> <td>64</td> </tr> <tr> <td>1000</td> <td>0</td> <td>64</td> </tr> <tr> <td>1010</td> <td>16</td> <td>48</td> </tr> <tr> <td>1011</td> <td>32</td> <td>32</td> </tr> <tr> <td>1100</td> <td>64</td> <td>0</td> </tr> <tr> <td>1111</td> <td>Default value. FlexNVM not configured with a valid DEPART code</td> <td>-</td> </tr> </tbody> </table>	DEPART	Data flash size (KB)	EEPROM backup size (KB)	0000	64	0	0011	32	32	0100	0	64	1000	0	64	1010	16	48	1011	32	32	1100	64	0	1111	Default value. FlexNVM not configured with a valid DEPART code	-
DEPART	Data flash size (KB)	EEPROM backup size (KB)																										
0000	64	0																										
0011	32	32																										
0100	0	64																										
1000	0	64																										
1010	16	48																										
1011	32	32																										
1100	64	0																										
1111	Default value. FlexNVM not configured with a valid DEPART code	-																										

36.1.2.6 2 MB program flash / 64 KB FlexNVM / 4 KB FlexRAM module (S32K148)

The 2MB FTFC flash module consists of four NVM read partitions and one FlexRAM block:

- Three 512KB program flash read partitions (interleaved 2 × 256KB)⁸
- One shared Program/Data Flash (FlexNVM) read partition (interleaved 2 × 256KB)⁸. This shared read partition consists of 448 KB PFlash (interleaved 2 × 224KB) and 64KB FlexNVM (interleaved 2 × 32KB) areas.
- One 4KB FlexRAM

Figure 36-7 shows the 2MB flash module in various configurations.

NOTE

1. The last partition (448KB Program Flash and 64KB Data Flash/FlexMEM), being a single read partition which is shared, needs consideration as code may not execute from the 448KB Program Flash area at the same time as the 64KB Data Flash/FlexNVM area is being accessed.

8. Interleaved blocks have a data width of 128-bits.

- Since the FlexNVM is configured for Emulated EEPROM on the 2MB module, DEPART values are limited to 64KB or none.

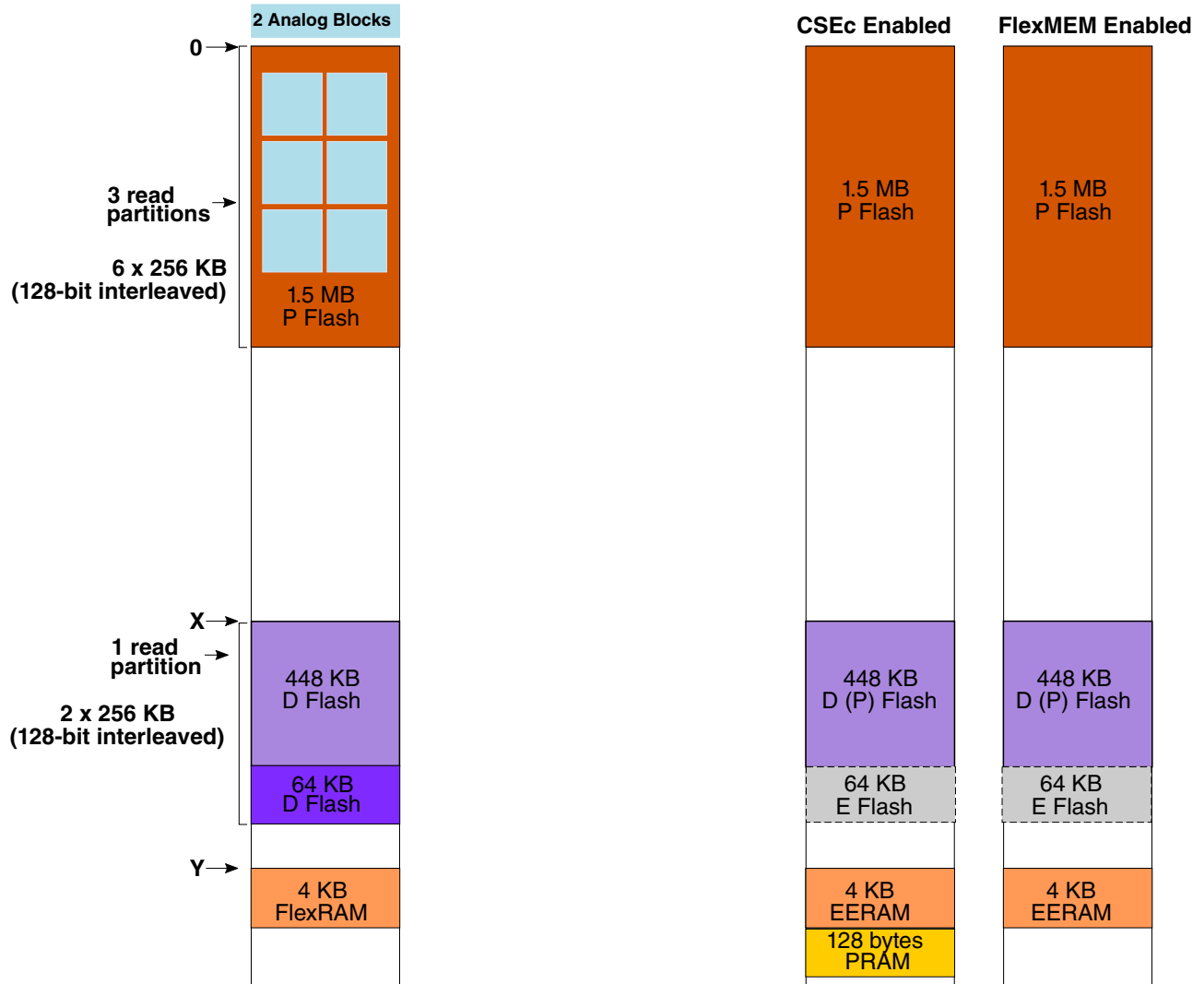

Figure 36-7. 2 MB flash memory map

36.1.2.6.1 Emulated EEPROM data set size (EESIZE)

Table 36-22. Emulated EEPROM data set size for 4 KB FlexRAM

Data flash IFR: 0x03FE							
7	6	5	4	3	2	1	0
1	EEERST	1	1	EESIZE			
= Unimplemented or Reserved							

Table 36-23. EEPROM Data Set Size Field Description

Field	Description
7 Reserved	This read-only bitfield is reserved and must always be written as one.
6 EEERST	<p>EEPROM Load on Reset — Determines whether the flash reset sequence takes time to load the FlexRAM with valid EEPROM data.</p> <p>'0' = FlexRAM is not loaded with valid EEPROM data during the flash reset sequence (see the Set FlexRAM Function command to load the FlexRAM with valid EEPROM data)</p> <p>'1' = FlexRAM is loaded with valid EEPROM data during the flash reset sequence</p> <p>For CSEc enabled parts, the FlexRAM is always loaded with valid EEPROM data during the flash reset sequence, and will include the inaccessible Key <n> addresses as applicable.</p>
5-4	Reserved
3-0 EEESIZE	<p>EEPROM Size — Encoding of the total available FlexRAM for emulated EEPROM use.</p> <p>NOTE:</p> <ol style="list-style-type: none"> EEESIZE must be 0 bytes (1111b) when the FlexNVM partition code is set to 'No EEPROM'. For CSEc enabled parts, the EEE size must be '0010' - 4,096 bytes <p>'0000' = Reserved '0001' = Reserved '0010' = 4,096 bytes '0011' = Reserved '0100' = Reserved '0101' = Reserved '0110' = Reserved '0111' = Reserved '1000' = Reserved '1001' = Reserved '1010' = Reserved '1011' = Reserved '1100' = Reserved '1101' = Reserved '1110' = Reserved '1111' = 0 Bytes</p>

36.1.2.6.2 FlexNVM partition code (DEPART)

The FlexNVM partition code byte in the data flash 0 IFR supplies a code which specifies how to split the FlexNVM block between data flash memory and emulated EEPROM backup memory supporting emulated EEPROM functions. To program the DEPART value, see the Program Partition command.

Table 36-24. FlexNVM partition code

Data Flash IFR: 0x03FC							
7	6	5	4	3	2	1	0
1	1	1	1	DEPART			
= Unimplemented or Reserved							

Table 36-25. FlexNVM partition code field description

Field	Description													
7-4 Reserved	This read-only bitfield is reserved and must always be written as one.													
3-0 DEPART	<p>FlexNVM Partition Code — Encoding of the data flash / emulated EEPROM backup split within the FlexNVM memory block. FlexNVM memory not partitioned for data flash is used to store EEPROM records.</p> <table border="1"> <thead> <tr> <th>DEPART</th> <th>Data flash size (KB)</th> <th>EEPROM backup size (KB)</th> </tr> </thead> <tbody> <tr> <td>0000</td> <td>512 KB</td> <td>0</td> </tr> <tr> <td>0100</td> <td>D Flash size - EEPROM size (512 KB - 64 KB = 448 KB)</td> <td>64</td> </tr> <tr> <td>1111¹</td> <td>512 KB</td> <td>0</td> </tr> </tbody> </table> <p>¹Although this is the default value, a . PGMPART command must be launched for this code to be valid.</p>	DEPART	Data flash size (KB)	EEPROM backup size (KB)	0000	512 KB	0	0100	D Flash size - EEPROM size (512 KB - 64 KB = 448 KB)	64	1111 ¹	512 KB	0	
DEPART	Data flash size (KB)	EEPROM backup size (KB)												
0000	512 KB	0												
0100	D Flash size - EEPROM size (512 KB - 64 KB = 448 KB)	64												
1111 ¹	512 KB	0												

1. Although this is the default value, a PGMPART command must be launched for this code to be valid.

36.1.3 Flash memory map

The various types of flash memory and the registers for flash memory have different base addresses, as the following figure shows. Each base address is specified in the attached file S32K1xx_memory_map.xlsx.

Chip-specific FTFC information

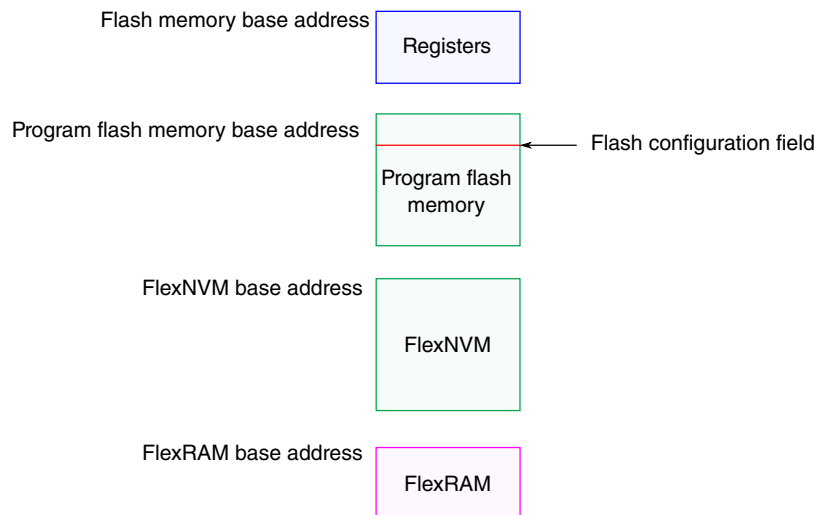

Figure 36-8. Flash memory map

36.1.4 Flash memory security

See [Flash memory security](#).

36.1.5 Power mode restrictions on flash memory programming

The flash memory should not be programmed or erased while the chip is operating in:

- VLPR mode
- HSRUN mode

No FTFC commands of any type, including CSE commands (for CSEc parts), are available when the chip is in these modes.

36.1.6 Flash memory modes

The FTFC module has two operating modes: NVM Normal and NVM Special.

- On this chip, the FTFC is always configured in NVM Normal mode.
- The chip has no operating conditions in which the FTFC is configured for NVM Special mode.

36.1.7 Erase all contents of flash memory

An [Erase All Blocks command](#) can be launched by software through a series of peripheral bus writes to FTFC registers.

In addition, the entire flash memory can be erased from the external SWJ-DP debug port according to this sequence:

1. Set MDM-AP Control[0].
2. MDM-AP Status[0] sets to indicate the mass erase command has been accepted.
3. MDM-AP Status[0] clears when the mass erase completes.

36.1.8 Customize MCU operations via FTFC_FOPT register

The [Flash Option Register \(FOPT\)](#) allows you to customize the operation of the MCU at boot time. For details about the meaning of FOPT values and how to program alternative configuration options, see [FOPT boot options](#).

36.1.9 Simultaneous operations on PFLASH read partitions

While executing from a particular PFLASH read partition, FTFC commands (except parallel boot) cannot run over that PFLASH read partition. Below are number of PFLASH read partitions in each device:

Table 36-26. PFLASH partitions

Chip	No. of PFLASH read partitions
S32K116	1 (128 KB)
S32K118	1 (256 KB)
S32K142	1 (256 KB)
S32K144	1 (512 KB)
S32K146	2 (each 512 KB)
S32K148	3 (each 512 KB)

36.2 Introduction

The FTFC module includes the following accessible memory regions:

- Program flash memory for vector space and code store

- FlexNVM for data store and additional code store
- FlexRAM for high-endurance data store or traditional RAM

Flash memory is ideal for single-supply applications, permitting in-the-field erase and reprogramming operations without the need for any external high voltage power sources.

The FTFC module includes a memory controller that executes commands to modify flash memory contents. An erased bit reads '1' and a programmed bit reads '0'. The programming operation is unidirectional; it can only move bits from the '1' state (erased) to the '0' state (programmed). Only the erase operation restores bits from '0' to '1'; bits cannot be programmed from a '0' to a '1'.

CAUTION

A flash memory location must be in the erased state before being programmed. Cumulative programming of bits (back-to-back program operations without an intervening erase) within a flash memory location is not allowed. Re-programming of existing 0s to 0 is not allowed as this overstresses the device.

The standard shipping condition for flash memory is erased with security disabled. Data loss over time may occur due to degradation of the erased ('1') states and/or programmed ('0') states. Therefore, it is recommended that each flash block or sector be re-erased immediately prior to factory programming to ensure that the full data retention capability is achieved.

36.2.1 Features

The FTFC module includes the following features.

NOTE

See the device's Chip Configuration details for the exact amount of flash memory available on your device.

36.2.1.1 Program flash memory features

- Sector size of 2 KB for non-interleaved configurations (i.e., 256 KB and less). 4 KB for interleaved configurations (512 KB and greater)
- Program flash protection scheme prevents accidental program or erase of stored data
- Automated, built-in, program and erase algorithms with verify

- Section programming for faster bulk programming times
- Read access to the program flash block is possible while programming or erasing data in the data flash block or FlexRAM

36.2.1.2 FlexNVM memory features

When FlexNVM is partitioned for data flash memory:

- Sector size of 2 KB for non-interleaved configurations (i.e., all configurations other than the 2 MB configuration). 4 KB for interleaved configurations (2 MB)
- Protection scheme prevents accidental program or erase of stored data
- Automated, built-in program and erase algorithms with verify
- Section programming for faster bulk programming times
- Read access to the data flash block possible while programming or erasing data in the program flash block

36.2.1.3 FlexRAM features

- Memory that can be used as traditional RAM or as high-endurance emulated EEPROM storage
- Up to 4 KB of FlexRAM configured for emulated EEPROM or traditional RAM operations
- When configured for emulated EEPROM:
 - Protection scheme prevents accidental modification for emulated EEPROM
 - Built-in hardware emulation scheme to automate emulated EEPROM record maintenance functions
 - Programmable emulated EEPROM data set size and FlexNVM partition code facilitating emulated EEPROM memory endurance trade-offs
 - Supports only FlexRAM aligned writes of 1, 2, or 4 bytes at a time
 - Read access to FlexRAM possible while programming or erasing data in the program or data flash memory
- When configured for traditional RAM:
 - Read and write access possible to the FlexRAM while programming or erasing data in the program or data flash memory

36.2.1.4 Cryptographic Services Engine (CSEc) module features

The FTFC module includes feature support for the SHE (Secure Hardware Extension) specification.

- Secure cryptographic key storage (ranging from 3 to 17 user keys)
- AES-128 encryption and decryption
- AES-128 CMAC (Cipher-based Message Authentication Code) calculation and authentication
- ECB (Electronic Cypher Book) Mode - encryption and decryption
- CBC (Cipher Block Chaining) Mode - encryption and decryption
- True and Pseudo random number generation
- Miyaguchi-Prenell compression function
- Secure Boot Mode (user configurable)
 - Sequential Boot Mode
 - Parallel Boot Mode
 - Strict Sequential Boot Mode (unchangeable once set)

36.2.1.5 Other FTFC module features

- Internal high-voltage supply generator for flash memory program and erase operations
- Optional interrupt generation upon flash command completion
- Supports MCU security mechanisms which prevent unauthorized access to the flash memory contents
- ECC Logic to correct single-bit faults and detect multi-bit faults in each NVM flash phrase

36.2.2 Block diagram

The block diagram of the FTFC module is shown in the following figure.

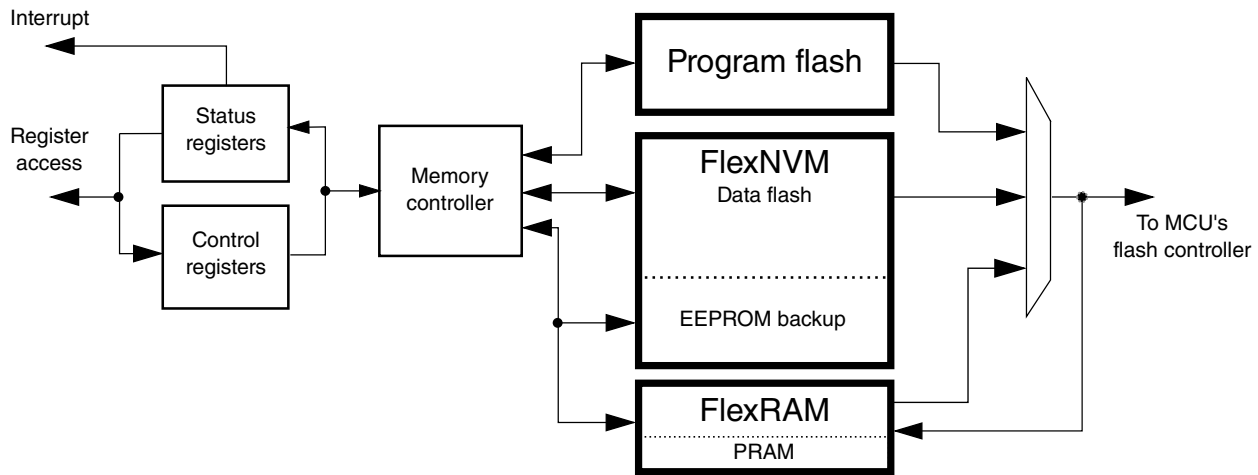

Figure 36-9. FTFC block diagram

36.2.3 Glossary

Command write sequence — A series of MCU writes to the Flash FCCOB register group that initiates and controls the execution of Flash algorithms that are built into the FTFC module.

Cryptographic Services Engine— CSEc - Feature set for various encryption, decryption and authentication algorithms built to meet the SHE specification. This (CSEc) is a 'compact' version of the CSE module

CSE_PRAM — RAM dedicated to the CSEc Parameter space. Used for all CSEc/SHE command requests and related data input / output.

Data flash memory — Partitioned from the FlexNVM block, the data flash memory provides nonvolatile storage for user data, boot code, and additional code store.

Data flash sector — The data flash sector is the smallest portion of the data flash memory that can be erased.

Double-Phrase — 128-bits of data with an aligned double-phrase having byte-address[3:0] == 0000.

EEPROM — Using a built-in filing system, the FTFC module emulates the characteristics of an EEPROM by effectively providing a high-endurance, byte-writeable (program and erase) NVM.

EEPROM backup data header — The emulated EEPROM backup data header consists of a 64-bit field found in emulated EEPROM backup data memory which contains information used by the emulated EEPROM filing system to determine the status of a specific emulated EEPROM backup flash sector.

EEPROM backup data record — Data record found in emulated EEPROM backup data memory which is used by the emulated EEPROM filing system.

EEPROM backup data memory — Partitioned from the FlexNVM block, emulated EEPROM backup data memory provides nonvolatile storage for the emulated EEPROM filing system representing data written to the FlexRAM requiring highest endurance.

EEPROM backup data sector — The emulated EEPROM backup data sector contains one emulated EEPROM header and up to 255 emulated EEPROM backup data records, which are used by the emulated EEPROM filing system.

Endurance (cycling) — The number of times that a flash memory location can be erased and reprogrammed.

FCCOB (Flash Common Command Object) — A group of flash registers that are used to pass command, address, data, and any associated parameters to the memory controller in the FTFC module.

Flash block — A macro within the FTFC module which provides the nonvolatile memory storage.

FlexMemory — FTFC configuration that supports data flash, emulated EEPROM, and FlexRAM.

FlexNVM Block — The FlexNVM block can be configured to be used as data flash memory, emulated EEPROM backup flash memory, or a combination of both.

FlexRAM — The FlexRAM refers to a RAM, dedicated to the FTFC module, that can be configured to store emulated EEPROM data or as traditional RAM. When configured for emulated EEPROM, valid writes to the FlexRAM generates a new emulated EEPROM backup data record stored in the emulated EEPROM backup flash memory.

FTFC Module — All flash blocks plus a flash management unit providing high-level control and an interface to MCU buses.

HSRUN — An MCU power mode enabling temporary high-speed access to the memory resources in the FTFC module. The user has no access to the Flash command set (no FCCOB or CSEc commands, nor emulated EEPROM functions, nor FlexRAM access - only system reads to NVM arrays) when the MCU is in HSRUN mode.

IFR — Nonvolatile information register found in each flash block, separate from the main memory array.

Interleaved/Non-Interleaved — Interleaved (D or P Flash) refers to an internal data path being 128-bits wide and addresses internally alternating between two 64-bit wide datapath modules. While non-interleaved (D or P Flash) refers to an internal data path being 64-bits wide. Interleaved DFlash (2MB macro) has different DEPART options than the non-interleaved macros.

Longword — 32 bits of data with an aligned longword having byte-address[1:0] = 00.

NVM — Nonvolatile memory. A memory technology that maintains stored data during power-off. The flash array is an NVM using NOR-type flash memory technology.

NVM Normal Mode — An NVM mode that provides basic user access to FTFC resources. The CPU or other bus masters initiate flash program and erase operations (or other flash commands) using writes to the FCCOB register group in the FTFC module.

Phrase — 64 bits of data with an aligned phrase having byte-address[2:0] = 000.

Program flash — The program flash memory provides nonvolatile storage for vectors and code store.

Program flash sector — The smallest portion of the program flash memory (consecutive addresses) that can be erased.

Quad-Phrase — 256 bits of data with an aligned quad-phrase having byte-address[4:0] = 00000.

RWW— Read-While-Write. The ability to simultaneously read from one memory resource while commanded operations are active in another memory resource.

Section program buffer — Lower quarter of the FlexRAM allocated for storing large amounts of data for programming via the Program Section command.

Secure — An MCU state conveyed to the FTFC module as described in the Chip Configuration details for this device. In the secure state, reading and changing NVM contents is restricted.

Word — 16 bits of data with an aligned word having byte-address[0] = 0.

36.3 External signal description

The FTFC module contains no signals that connect off-chip.

36.4 Memory map and registers

This section describes the memory map and registers for the FTFC module. Data read from unimplemented memory space in the FTFC module is undefined. Writes to unimplemented or reserved memory space (registers) in the FTFC module are ignored.

36.4.1 Flash configuration field description

The program flash memory contains a 16-byte flash configuration field that stores default protection settings (loaded on reset) and security information that allows the MCU to restrict access to the FTFC module.

Flash Configuration Field Offset Address	Size (Bytes)	Field Description
0x0_0400 - 0x0_0407	8	Backdoor Comparison Key. Refer to Verify Backdoor Access Key command and Un-securing the MCU using backdoor key access .
0x0_0408 - 0x0_040B	4	Program flash protection bytes. Refer to the description of the Program Flash Protection Registers (FPROT0-3).
0x0_040F	1	Data flash protection byte. Refer to the description of the Data Flash Protection Register (FDPROT).
0x0_040E	1	EEPROM protection byte. Refer to the description of the EEPROM Protection Register (FEPROT).
0x0_040D	1	Flash nonvolatile option byte. Refer to the description of the Flash Option Register (FOPT).
0x0_040C	1	Flash security byte. Refer to the description of the Flash Security Register (FSEC).

36.4.2 Program flash 0 IFR map

The program flash 0 IFR is a 1 KB nonvolatile information memory, 64 bytes of which can be read freely, but the user has no erase and limited program capabilities (see the Read Once, and Program Once commands in [Read Once command](#), and [Program Once command](#)). The contents of the program flash 0 IFR are summarized in the following table and further described in the subsequent paragraphs.

The program flash 0 IFR is located within the program flash 0 memory block.

Address Range	Size (Bytes)	Field Description
0x000 – 0x3BF	960	Reserved
0x3C0 – 0x3FF	64	Program Once Field

36.4.2.1 Program Once field

The Program Once field in the program flash 0 IFR provides 64 bytes of user data storage separate from the program flash 0 main array. The user can program the Program Once field one time only as there is no program flash IFR erase mechanism available to the user. The Program Once field can be read any number of times. This section of the program flash 0 IFR is accessed in 8 byte records using the Read Once and Program Once commands (see [Read Once command](#) and [Program Once command](#)).

36.4.3 Data flash 0 IFR map

The data flash 0 IFR is a 1 KB nonvolatile information memory that can be erased, but the user has limited program capabilities in the data flash 0 IFR (see the Program Partition command in [Program Partition command](#), the Erase All Blocks command in [Erase All Blocks command](#) in The contents of the data flash 0 IFR are summarized in the following table and further described in the subsequent paragraphs.

The data flash 0 IFR is located within the data flash 0 memory block.

Address Range	Size (Bytes)	Field Description
0x00 – 0x3FB, 0x3FE – 0x3FF	1022	Reserved
0x3FD	1	EEPROM Data Set Size
0x3FC	1	FlexNVM Partition Code

36.4.3.1 EEPROM data set size

The emulated EEPROM data set size byte in the data flash 0 IFR supplies information which determines the amount of FlexRAM used in each of the available emulated EEPROM subsystems and indicates whether the FlexRAM is loaded with valid emulated EEPROM data during the flash reset sequence. To program the EEERST, EEESIZE value, see the Program Partition command described in [Program Partition command](#). Also see the chip-specific information.

Refer to the SoC SIM (System Integration Module) for read values of this information (EEERST, EEESIZE).

36.4.3.2 FlexNVM partition code

The FlexNVM partition code byte in the data flash 0 IFR supplies a code which specifies how to split the FlexNVM block between data flash memory and emulated EEPROM backup memory supporting emulated EEPROM functions. To program the DEPART value, see the Program Partition command described in [Program Partition command](#). Also see the chip-specific information.

Refer to the SoC SIM (System Integration Module) for read values of this information (DEPART).

36.4.4 Register descriptions

The FTFC module contains a set of memory-mapped control and status registers.

NOTE

While a command is running (FSTAT[CCIF]=0), register writes are not accepted to any register except FCNFG, FSTAT, FERCNFG and FERSTAT. The no-write rule is relaxed during the start-up reset sequence, prior to the initial rise of CCIF. During this initialization period the user may write any register. All register writes are also disabled (except for registers FCNFG, FSTAT, FERCNFG and FERSTAT) whenever an erase suspend request is active (FCNFG[ERSSUSP]=1).

36.4.4.1 FTFC register descriptions

36.4.4.1.1 FTFC memory map

FTFC base address: 4002_0000h

Offset	Register	Width (In bits)	Access	Reset value
0h	Flash Status Register (FSTAT)	8	W1C	80h
1h	Flash Configuration Register (FCNFG)	8	RW	02h
2h	Flash Security Register (FSEC)	8	RO	Table 36-26
3h	Flash Option Register (FOPT)	8	RO	Table 36-26

Table continues on the next page...

Offset	Register	Width (In bits)	Access	Reset value
4h	Flash Common Command Object Registers (FCCOB3)	8	RW	00h
5h	Flash Common Command Object Registers (FCCOB2)	8	RW	00h
6h	Flash Common Command Object Registers (FCCOB1)	8	RW	00h
7h	Flash Common Command Object Registers (FCCOB0)	8	RW	00h
8h	Flash Common Command Object Registers (FCCOB7)	8	RW	00h
9h	Flash Common Command Object Registers (FCCOB6)	8	RW	00h
Ah	Flash Common Command Object Registers (FCCOB5)	8	RW	00h
Bh	Flash Common Command Object Registers (FCCOB4)	8	RW	00h
Ch	Flash Common Command Object Registers (FCCOBB)	8	RW	00h
Dh	Flash Common Command Object Registers (FCCOBA)	8	RW	00h
Eh	Flash Common Command Object Registers (FCCOB9)	8	RW	00h
Fh	Flash Common Command Object Registers (FCCOB8)	8	RW	00h
10h	Program Flash Protection Registers (FPROT3)	8	RW	Table 36-26
11h	Program Flash Protection Registers (FPROT2)	8	RW	Table 36-26
12h	Program Flash Protection Registers (FPROT1)	8	RW	Table 36-26
13h	Program Flash Protection Registers (FPROT0)	8	RW	Table 36-26
16h	EEPROM Protection Register (FEPROT)	8	RW	Table 36-26
17h	Data Flash Protection Register (FDPROT)	8	RW	Table 36-26
2Ch	Flash CSEc Status Register (FCSESTAT)	8	RO	00h
2Eh	Flash Error Status Register (FERSTAT)	8	W1C	00h
2Fh	Flash Error Configuration Register (FERCNFG)	8	RW	00h

36.4.4.1.2 Flash Status Register (FSTAT)

36.4.4.1.2.1 Offset

Register	Offset
FSTAT	0h

36.4.4.1.2.2 Function

The FSTAT register reports the operational status of the FTFC module.

The CCIF, RDCOLERR, ACCERR, and FPVIOL bits are readable and writable. The MGSTAT0 bit is read only. The unassigned bits read 0 and are not writable.

NOTE

When set, the Access Error (ACCERR) and Flash Protection Violation (FPVIOL) bits in this register prevent the launch of any more commands or writes to the FlexRAM (when EEERDY is set) until the flag is cleared (by writing a one to it).

36.4.4.1.2.3 Diagram

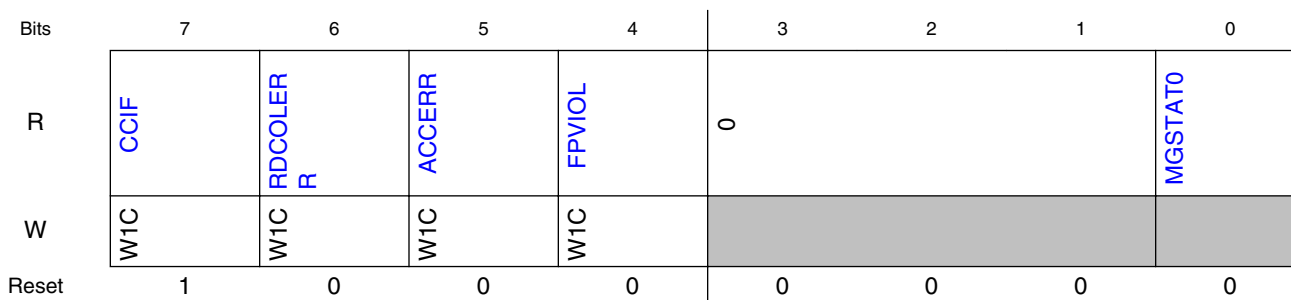

36.4.4.1.2.4 Fields

Field	Function
7 CCIF	<p>Command Complete Interrupt Flag</p> <p>The CCIF flag indicates that an FTFC/CSEc command or emulated EEPROM file system operation has completed. The CCIF flag is cleared by writing a 1 to CCIF to launch a command, and CCIF stays low until command completion or command violation. The CCIF flag is also cleared by a successful write to FlexRAM while enabled for EEE, and CCIF stays low until the emulated EEPROM file system has created the associated EEPROM data record. The CCIF flag will also clear upon execution of any CSEc command, and will set upon completion.</p> <p>The CCIF bit is reset to 0 but is set to 1 by the memory controller at the end of the reset initialization sequence. Depending on how quickly the read occurs after reset release, the user may or may not see the 0 hardware reset value.</p> <p>0b - FTFC command or emulated EEPROM file system operation in progress 1b - FTFC command or emulated EEPROM file system operation has completed</p>
6 RDCOLERR	<p>FTFC Read Collision Error Flag</p> <p>The RDCOLERR error bit indicates that the MCU attempted a read from an FTFC resource that was being manipulated by an FTFC command (CCIF=0). Any simultaneous access is detected as a collision error by the block arbitration logic. The read data in this case cannot be guaranteed. The RDCOLERR bit is cleared by writing a 1 to it. Writing a 0 to RDCOLERR has no effect.</p> <p>0b - No collision error detected 1b - Collision error detected</p>
5 ACCERR	<p>Flash Access Error Flag</p> <p>The ACCERR error bit indicates an illegal access has occurred to an FTFC resource caused by a violation of the command write sequence or issuing an illegal FTFC command. While ACCERR is set, the CCIF flag cannot be cleared to launch a command. The ACCERR bit is cleared by writing a 1 to ACCERR while CCIF is set. Writing a 0 to the ACCERR bit has no effect.</p> <p>0b - No access error detected</p>

Table continues on the next page...

Field	Function
	1b - Access error detected
4 FPVIOL	Flash Protection Violation Flag The FPVIOL error bit indicates an attempt was made to program or erase an address in a protected area of program flash or data flash memory during a command write sequence or a write was attempted to a protected area of the FlexRAM while enabled for emulated EEPROM. While FPVIOL is set, the CCIF flag cannot be cleared to launch a command. The FPVIOL bit is cleared by writing a 1 to FPVIOL while CCIF is set. Writing a 0 to the FPVIOL bit has no effect. 0b - No protection violation detected 1b - Protection violation detected
3-1 —	Reserved
0 MGSTAT0	Memory Controller Command Completion Status Flag The MGSTAT0 status flag is set if an error is detected during execution of an FTFC command or during the flash reset sequence. As a status flag, this bit cannot (and need not) be cleared by the user like the other error flags in this register. The value of the MGSTAT0 bit for "command-N" is valid only at the end of the "command-N" execution when CCIF=1 and before the next command has been launched. At some point during the execution of "command-N+1," the previous result is discarded and any previous error is cleared.

36.4.4.1.3 Flash Configuration Register (FCNFG)

36.4.4.1.3.1 Offset

Register	Offset
FCNFG	1h

36.4.4.1.3.2 Function

This register provides information on the current functional state of the FTFC module.

The erase control bits (ERSAREQ and ERSSUSP) have write restrictions. RAMRDY, and EEERDY are read-only status bits. The reset values for the RAMRDY, and EEERDY bits are determined during the reset sequence.

36.4.4.1.3.3 Diagram

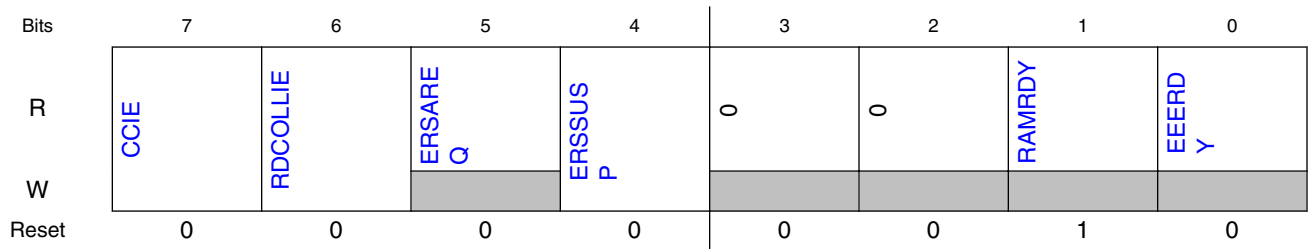

36.4.4.1.3.4 Fields

Field	Function
7 CCIE	<p>Command Complete Interrupt Enable</p> <p>The CCIE bit controls interrupt generation when an FTFC/CSEc command completes.</p> <p>0b - Command complete interrupt disabled 1b - Command complete interrupt enabled. An interrupt request is generated whenever the FSTAT[CCIF] flag is set.</p>
6 RDCOLLIE	<p>Read Collision Error Interrupt Enable</p> <p>The RDCOLLIE bit controls interrupt generation when an FTFC read collision error occurs.</p> <p>0b - Read collision error interrupt disabled 1b - Read collision error interrupt enabled. An interrupt request is generated whenever an FTFC read collision error is detected (see the description of FSTAT[RDCOLERR]).</p>
5 ERSAREQ	<p>Erase All Request</p> <p>This bit issues a request to the memory controller to execute the Erase All Blocks command and release MCU security. ERSAREQ is not directly writable but is under indirect user control. Refer to the device's Chip Configuration details on how to request this command.</p> <p>The ERSAREQ bit sets when an erase all request is triggered external to the FTFC and CCIF is set (no command is currently being executed). ERSAREQ is cleared by the FTFC when the operation completes.</p> <p>0b - No request or request complete 1b - Request to: (1) run the Erase All Blocks command, (2) verify the erased state, (3) program the security byte in the Flash Configuration Field to the unsecure state, and (4) release MCU security by setting the FSEC[SEC] field to the unsecure state.</p>
4 ERSSUSP	<p>Erase Suspend</p> <p>The ERSSUSP bit allows the user to suspend (interrupt) the Erase Flash Sector command while it is executing.</p> <p>0b - No suspend requested 1b - Suspend the current Erase Flash Sector command execution</p>
3 —	Reserved
2 —	Reserved
1 RAMRDY	<p>RAM Ready</p> <p>This flag indicates the current status of the FlexRAM.</p>

Table continues on the next page...

Field	Function
	<p>The state of the RAMRDY flag is normally controlled by the Set FlexRAM Function command. During the reset sequence, the RAMRDY flag is cleared if the FlexNVM block is partitioned for emulated EEPROM with the option to load the FlexRAM during the reset sequence and will be set if the FlexNVM block is not partitioned for emulated EEPROM or if the FlexNVM block is partitioned for emulated EEPROM with the option to not load the FlexRAM during the reset sequence. The RAMRDY flag is cleared if the Program Partition command is run to partition the FlexNVM block for emulated EEPROM. The RAMRDY flag sets after completion of the Erase All Blocks command or Erase All Blocks Unsecure command or execution of the erase-all operation triggered external to the FTFC.</p> <p>0b - FlexRAM is not available for traditional RAM access 1b - FlexRAM is available as traditional RAM only; writes to the FlexRAM do not trigger EEPROM operations</p>
0 EEERDY	<p>EEERDY</p> <p>This flag indicates if the EEPROM backup data has been copied to the FlexRAM and is therefore available for read access. During the reset sequence, the EEERDY flag remains clear while CCIF=0 and only sets if the FlexNVM block is partitioned for emulated EEPROM.</p> <p>0b - FlexRAM is not available for emulated EEPROM operation 1b - FlexRAM is available for EEPROM operations where: (1) reads from the FlexRAM return data previously written to the FlexRAM in emulated EEPROM mode and (2) writes launch an EEPROM operation to store the written data in the FlexRAM and EEPROM backup.</p>

36.4.4.1.4 Flash Security Register (FSEC)

36.4.4.1.4.1 Offset

Register	Offset
FSEC	2h

36.4.4.1.4.2 Function

This read-only register holds all bits associated with the security of the MCU and FTFC module.

During the reset sequence, the register is loaded with the contents of the flash security byte in the Flash Configuration Field located in program flash memory.

36.4.4.1.4.3 Diagram

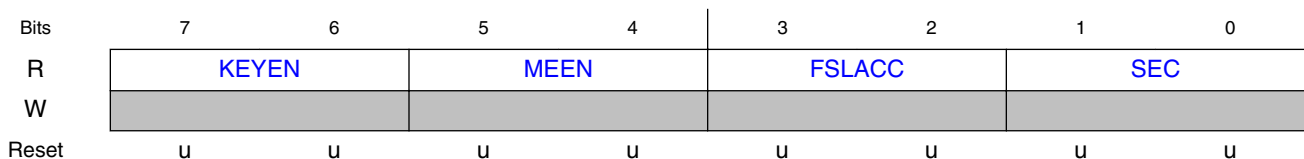

36.4.4.1.4.4 Fields

Field	Function
7-6 KEYEN	<p>Backdoor Key Security Enable</p> <p>These bits enable and disable backdoor key access to the FTFC module.</p> <p>00b - Backdoor key access disabled 01b - Backdoor key access disabled (preferred KEYEN state to disable backdoor key access) 10b - Backdoor key access enabled 11b - Backdoor key access disabled</p>
5-4 MEEN	<p>Mass Erase Enable Bits</p> <p>Enables and disables mass erase capability of the FTFC module. When the SEC field is set to unsecure, the MEEN setting does not matter.</p> <p>00b - Mass erase is enabled 01b - Mass erase is enabled 10b - Mass erase is disabled 11b - Mass erase is enabled</p>
3-2 FSLACC	<p>Factory Failure Analysis Access Code</p> <p>These bits enable or disable access to the flash memory contents during returned part failure analysis at the factory. When SEC is secure and FSLACC is denied, access to the program flash contents is denied and any failure analysis performed during factory test must begin with a mass erase, with MEEN enabled, to unsecure the part.</p> <p>When access is granted (SEC is unsecure, or SEC is secure and FSLACC is granted), factory testing has visibility of the current flash contents. The state of the FSLACC bits is only relevant when the SEC bits are set to secure. When the SEC field is set to unsecure, the FSLACC setting does not matter.</p> <p>00b - Factory access granted 01b - Factory access denied 10b - Factory access denied 11b - Factory access granted</p>
1-0 SEC	<p>Flash Security</p> <p>These bits define the security state of the MCU. In the secure state, the MCU limits access to FTFC module resources. The limitations are defined per device and are detailed in the Chip Configuration details. If the FTFC module is unsecured using backdoor key access, the SEC bits are forced to 10b.</p> <p>00b - MCU security status is secure 01b - MCU security status is secure 10b - MCU security status is unsecure (The standard shipping condition of the FTFC is unsecure.) 11b - MCU security status is secure</p>

36.4.4.1.5 Flash Option Register (FOPT)

36.4.4.1.5.1 Offset

Register	Offset
FOPT	3h

36.4.4.1.5.2 Function

The flash option register allows the MCU to customize its operations by examining the state of these read-only bits, which are loaded from NVM at reset. The function of the bits is defined in the device's Chip Configuration details.

All bits in the register are read-only.

During the reset sequence, the register is loaded from the flash nonvolatile option byte in the Flash Configuration Field located in program flash memory.

36.4.4.1.5.3 Diagram

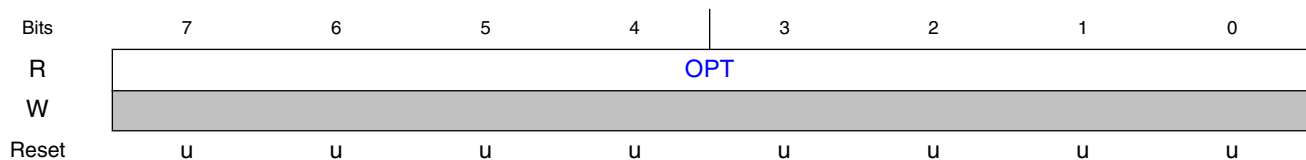

36.4.4.1.5.4 Fields

Field	Function
7-0	Nonvolatile Option
OPT	These bits are loaded from flash to this register at reset. Refer to the device's Chip Configuration details for the definition and use of these bits.

36.4.4.1.6 Flash Common Command Object Registers (FCCOB0 - FCCOBB)

36.4.4.1.6.1 Offset

Register	Offset
FCCOB3	4h
FCCOB2	5h
FCCOB1	6h
FCCOB0	7h
FCCOB7	8h
FCCOB6	9h
FCCOB5	Ah
FCCOB4	Bh

Table continues on the next page...

Memory map and registers

Register	Offset
FCCOBB	Ch
FCCOBA	Dh
FCCOB9	Eh
FCCOB8	Fh

36.4.4.1.6.2 Function

The FCCOB register group provides 12 bytes for command codes and parameters. The individual bytes within the set append a 0-B hex identifier to the FCCOB register name: FCCOB0, FCCOB1, ..., FCCOBB.

36.4.4.1.6.3 Diagram

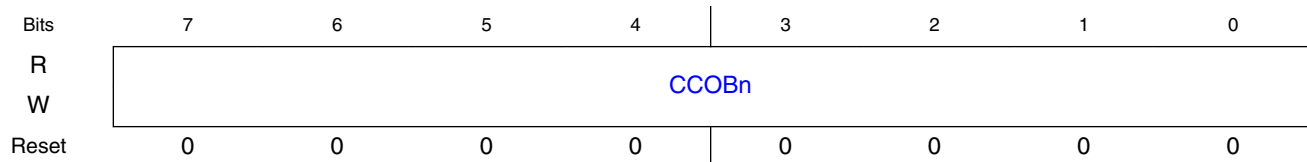

36.4.4.1.6.4 Fields

Field	Function						
7-0 CCOBn	<p>CCOBn</p> <p>The FCCOB register provides a command code and relevant parameters to the memory controller. The individual registers that compose the FCCOB data set can be written in any order, but you must provide all needed values, which vary from command to command. First, set up all required FCCOB fields and then initiate the command's execution by writing a 1 to the FSTAT[CCIF] bit. This clears the CCIF bit, which locks all FCCOB parameter fields and they cannot be changed by the user until the command completes (CCIF returns to 1). No command buffering or queuing is provided; the next command can be loaded only after the current command completes.</p> <p>Some commands return information to the FCCOB registers. Any values returned to FCCOB are available for reading after the FSTAT[CCIF] flag returns to 1 by the memory controller.</p> <p>The following table shows a generic FTFC command format. The first FCCOB register, FCCOB0, always contains the command code. This 8-bit value defines the command to be executed. The command code is followed by the parameters required for this specific FTFC command, typically an address and/or data values.</p> <p>NOTE: The command parameter table is written in terms of FCCOB Number (which is equivalent to the byte number). This number is a reference to the FCCOB register name and is not the register address.</p> <table border="1"> <thead> <tr> <th>FCCOB Number</th> <th>Typical Command Parameter Contents [7:0]</th> </tr> </thead> <tbody> <tr> <td>0</td> <td>FCMD (a code that defines the FTFC command)</td> </tr> <tr> <td>1</td> <td>Flash address [23:16]</td> </tr> </tbody> </table>	FCCOB Number	Typical Command Parameter Contents [7:0]	0	FCMD (a code that defines the FTFC command)	1	Flash address [23:16]
FCCOB Number	Typical Command Parameter Contents [7:0]						
0	FCMD (a code that defines the FTFC command)						
1	Flash address [23:16]						

Field	Function	
	FCCOB Number	Typical Command Parameter Contents [7:0]
	2	Flash address [15:8]
	3	Flash address [7:0]
	4	Data Byte 0
	5	Data Byte 1
	6	Data Byte 2
	7	Data Byte 3
	8	Data Byte 4
	9	Data Byte 5
	A	Data Byte 6
	B	Data Byte 7
<p>1. Refers to FCCOB register name, not register address</p> <p>FCCOB Endianness and Multi-Byte Access:</p> <p>The FCCOB register group uses a big endian addressing convention. For all command parameter fields larger than 1 byte, the most significant data resides in the lowest FCCOB register number. The FCCOB register group may be read and written as individual bytes, aligned words (2 bytes) or aligned longwords (4 bytes).</p>		

1. Refers to FCCOB register name, not register address

36.4.4.1.7 Program Flash Protection Registers (FPROT0 - FPROT3)

36.4.4.1.7.1 Offset

Register	Offset
FPROT3	10h
FPROT2	11h
FPROT1	12h
FPROT0	13h

36.4.4.1.7.2 Function

The FPROT registers define which program flash regions are protected from program and erase operations. Protected flash regions cannot have their content changed; that is, these regions cannot be programmed and cannot be erased by any FTFC command (except ERSALLU command and erase all that is triggered external to the FTFC). Unprotected regions can be changed by program and erase operations.

If the configuration PFlash size isn't a 2ⁿ multiple, round up to the next 2ⁿ size for the *region_size*. For example, the 2 MB macro is built with 1.5 MB PFlash plus 512 KB mixed P/DFlash (448 KB/64 KB). For this calculation, the PFlash should use 2 MB as the *region_size*.

The four FPROT registers allow up to 32 protectable regions of equal memory size. The FPROT register bits are mapped to the protectable regions as follows:

- $region_size = total_program_flash_size / 32$
- Starting from the program flash base address, Region 0 refers to the first *region_size* bytes, region 1 refers to the next *region_size* bytes, and so on.

In other words:

- $region_n_start_address = program_flash_base_address + (n) * region_size$
- $region_n_end_address = program_flash_base_address + ((n+1) * region_size) - 1$

For example, if the total program flash size is 512 MB, the *region_size* is 16 KB. If the lowest program flash address is 0x000A_0000, the regions are defined as follows:

Region	Start Address	End Address
0	0x000A_0000	0x000A_3FFF
1	0x000A_4000	0x000A_7FFF
2	0x000A_8000	0x000A_BFFF
3	0x000A_C000	0x000A_FFFF
...
32	0x0011_C000	0x0011_FFFF

- A '0' in an FPROT[PROT] bit indicates its corresponding flash protection region is protected
- A '1' in an FPROT[PROT] bit indicates its corresponding flash protection region is unprotected

Program flash protection register	Program flash protection bits
FPROT0	PROT[31:24]
FPROT1	PROT[23:16]
FPROT2	PROT[15:8]
FPROT3	PROT[7:0]

During the reset sequence, the FPROT registers are loaded with the contents of the program flash protection bytes in the Flash Configuration Field as indicated in the following table.

Program flash protection register	Flash Configuration Field offset address
FPROT0	0x000B
FPROT1	0x000A
FPROT2	0x0009
FPROT3	0x0008

To change the program flash protection that is loaded during the reset sequence, unprotect the sector of program flash memory that contains the Flash Configuration Field. Then, reprogram the program flash protection byte.

36.4.4.1.7.3 Diagram

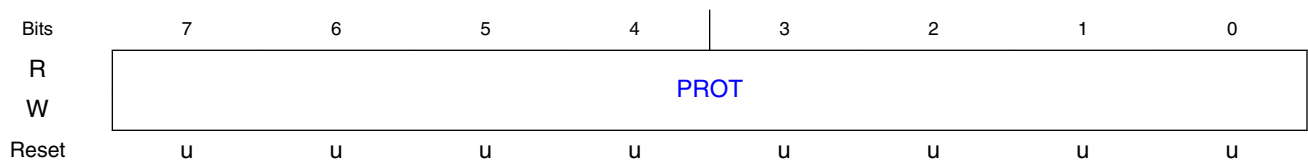

36.4.4.1.7.4 Fields

Field	Function
7-0 PROT	<p>Program Flash Region Protect</p> <p>Each program flash region can be protected from program and erase operations by setting the associated PROT bit to the protected state.</p> <p>In NVM Normal mode: The protection can only be increased, meaning that currently unprotected memory can be protected, but currently protected memory cannot be unprotected. Since unprotected regions are marked with a 1 and protected regions use a 0, only writes changing 1s to 0s are accepted. This 1-to-0 transition check is performed on a bit-by-bit basis. Those FPROT bits with 1-to-0 transitions are accepted while all bits with 0-to-1 transitions are ignored.</p> <p>Restriction: The user must never write to any FPROT register while a command is running (CCIF=0). Trying to alter data in any protected area in the program flash memory results in a protection violation error and sets the FSTAT[FPVIOL] bit. A full block erase of a program flash block (except ERSALLU command and erase all that is triggered external to the FTFC) is not possible if it contains any protected region.</p>

36.4.4.1.8 EEPROM Protection Register (FEPROT)

36.4.4.1.8.1 Offset

Register	Offset
FEPROT	16h

36.4.4.1.8.2 Function

The FEPROT register defines which emulated EEPROM regions of the FlexRAM are protected against program and erase operations (not including DBG_AUTH command). Protected EEPROM regions cannot have their content changed by writing to it. Unprotected regions can be changed by writing to the FlexRAM.

36.4.4.1.8.3 Diagram

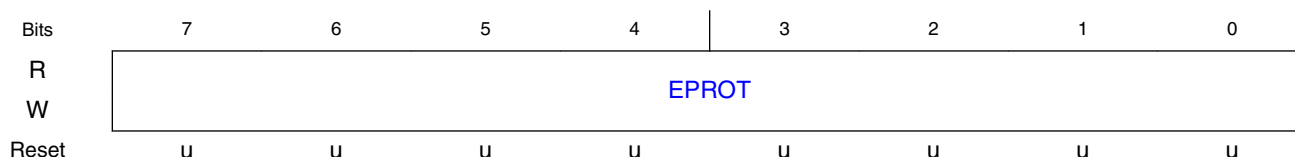

36.4.4.1.8.4 Fields

Field	Function
7-0 EPROT	<p>EEPROM Region Protect</p> <p>Individual emulated EEPROM regions can be protected from alteration by setting the associated EPROT bit to the protected state. The EPROT bits are not used when the FlexNVM Partition Code is set to data flash only. When the FlexNVM Partition Code is set to data flash and EEPROM or EEPROM only, each EPROT bit covers one-eighth of the configured EEPROM data (see the EEPROM Data Set Size parameter description).</p> <p>In NVM Normal mode: The protection can only be increased. This means that currently-unprotected memory can be protected, but currently-protected memory cannot be unprotected. Since unprotected regions are marked with a 1 and protected regions use a 0, only writes changing 1s to 0s are accepted. This 1-to-0 transition check is performed on a bit-by-bit basis. Those FEPROT bits with 1-to-0 transitions are accepted while all bits with 0-to-1 transitions are ignored.</p> <p>Restriction: Never write to the FEPROT register while a command is running (CCIF=0).</p> <p>Reset: During the reset sequence, the FEPROT register is loaded with the contents of the EEPROM protection byte in the Flash Configuration Field located in program flash. The flash basis for the reset values is signified by X in the register diagram. To change the EEPROM protection that will be loaded during the reset sequence, the sector of program flash that contains the Flash Configuration Field must be unprotected; then the EEPROM protection byte must be erased and reprogrammed.</p> <p>Trying to alter data by writing to any protected area in the emulated EEPROM results in a protection violation error and sets the FSTAT[FPVIOL] bit.</p> <p>0000000b - EEPROM region is protected 0000001b - EEPROM region is not protected</p>

36.4.4.1.9 Data Flash Protection Register (FDPROT)

36.4.4.1.9.1 Offset

Register	Offset
FDPROT	17h

36.4.4.1.9.2 Function

The FDPROT register defines which data flash regions are protected against program and erase operations. Protected Flash regions cannot have their content changed; that is, these regions cannot be programmed and cannot be erased by any FTFC command (except DBG_AUTH command, ERSALLU command and erase all which is triggered external to the FTFC). Unprotected regions can be changed by both program and erase operations.

36.4.4.1.9.3 Diagram

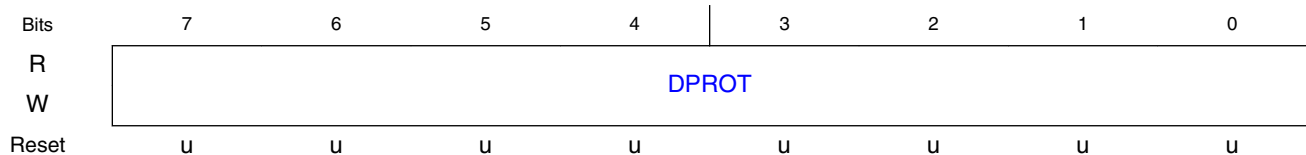

36.4.4.1.9.4 Fields

Field	Function
7-0 DPROT	<p>Data Flash Region Protect</p> <p>Individual data flash regions can be protected from program and erase operations by setting the associated DPROT bit to the protected state. Each DPROT bit protects one-eighth of the partitioned data flash memory space. The granularity of data flash protection cannot be less than the data flash sector size. If an unused DPROT bit is set to the protected state, the Erase all Blocks command does not execute and sets the FSTAT[FPVIOL] bit. Similar to FPROT, if the configuration DFlash size isn't a 2ⁿ multiple, round up to the next 2ⁿ size for the region_size.</p> <p>In NVM Normal mode: The protection can only be increased, meaning that currently unprotected memory can be protected but currently protected memory cannot be unprotected. Since unprotected regions are marked with a 1 and protected regions use a 0, only writes changing 1s to 0s are accepted. This 1-to-0 transition check is performed on a bit-by-bit basis. Those FDPROT bits with 1-to-0 transitions are accepted while all bits with 0-to-1 transitions are ignored.</p> <p>Restriction: The user must never write to the FDPROT register while a command is running (CCIF=0).</p>

Memory map and registers

Field	Function
	<p>Reset: During the reset sequence, the FDPROT register is loaded with the contents of the data flash protection byte in the Flash Configuration Field located in program flash memory. The flash basis for the reset values is signified by X in the register diagram. To change the data flash protection that will be loaded during the reset sequence, unprotect the sector of program flash that contains the Flash Configuration Field. Then, erase and reprogram the data flash protection byte.</p> <p>Trying to alter data with the program and erase commands (except ERSALLU command and erase all which is triggered external to the FTFC) in any protected area in the data flash memory results in a protection violation error and sets the FSTAT[FPVIOL] bit. A block erase of any data flash memory block (see the Erase Flash Block command description) is not possible if the data flash block contains any protected region or if the FlexNVM memory has been partitioned for emulated EEPROM.</p> <p>00000000b - Data Flash region is protected 00000001b - Data Flash region is not protected</p>

36.4.4.1.10 Flash CSEc Status Register (FCSESTAT)

36.4.4.1.10.1 Offset

Register	Offset
FCSESTAT	2Ch

36.4.4.1.10.2 Function

The FCSESTAT register reports the status of the CSEc cryptographic related feature set operations.

Following is a quick reference mapping CSEc status flags from the FCSESTAT register.

Table 36-27. Boot/MAC map to CSEc Status Flags

	SB	BIN	BFN	BOK	<err code>
No Boot Type	0	0	0	0	0
MAC is Empty	1	1	1	0	NO_ERR
MAC Mismatch	1	0	1	0	NO_ERR
MAC Match	1	0	0	1	NO_ERR
MAC_KEY is empty	0	0	1	0	NO_SECURE_BOOT

36.4.4.1.10.3 Diagram

Bits	7	6	5	4	3	2	1	0
R	IDB	EDB	RIN	BOK	BFN	BIN	SB	BSY
W								
Reset	0	0	0	0	0	0	0	0

36.4.4.1.10.4 Fields

Field	Function
7 IDB	<p>Internal Debug</p> <p>The IDB bit is set by the DBG_AUTH command when no flash keys are stored. It is cleared upon reset and by the LOAD_KEY command.</p> <p>0b - Internal debug functions are disabled 1b - Internal debugger functions are enabled</p>
6 EDB	<p>External Debug</p> <p>The EDB bit is set when the CPU debug port (BDM/JTAG/etc.) is activated. It is cleared upon reset.</p> <p>0b - External debugger not attached 1b - External debugger is attached</p>
5 RIN	<p>Random Number Generator Initialized</p> <p>The RIN bit is set by the INIT_RNG command. It is cleared upon reset and by the DBG_AUTH command.</p> <p>0b - Random number generator is not initialized. 1b - Random number generator is initialized.</p>
4 BOK	<p>Secure Boot OK</p> <p>The BOK bit is set by the successful completion of the secure boot process. It is cleared upon reset or by the BOOT_FAILURE command. This will remain cleared if BOOT_MAC/BOOT_MAC_KEY/boot flavor selection is absent.</p> <p>0b - Secure boot is not complete, or secure boot failure 1b - Secure boot was successful.</p>
3 BFN	<p>Secure Boot Finished</p> <p>The BFN bit is set by the BOOT_FAILURE or BOOT_OK commands, or the secure boot process when the BIN bit is set, an error has been encountered, or the BOOT_MAC value doesn't match. It assumes BOOT_MAC_KEY is present and boot flavor is configured to a secure boot type (serial, parallel, strict). It is cleared upon reset.</p> <p>0b - Secure Boot is not finished. 1b - Secure Boot has finished</p>
2 BIN	<p>Secure Boot Initialization</p> <p>The BIN bit is set by the secure boot process if the BOOT_MAC memory slot is empty. It is cleared upon reset. Assumes BOOT_MAC_KEY is present. (autonomous boot per SHE section 10.3)</p> <p>0b - Secure boot personalization not completed. 1b - Secure boot personalization has completed</p>
1 SB	<p>Secure Boot</p> <p>The SB bit is set by the secure boot process if the BOOT_MAC_KEY slot is not empty. It is cleared upon reset. Assumes secure boot flavor is configured (serial, parallel or strict)</p>

Table continues on the next page...

Memory map and registers

Field	Function
	0b - Secure boot not activated 1b - Secure boot is activated
0 BSY	Busy The BSY bit is set when a CSEc command is issued. It is cleared when the command process has completed 0b - CSEc command processing has completed 1b - CSEc command processing is in progress

36.4.4.1.11 Flash Error Status Register (FERSTAT)

36.4.4.1.11.1 Offset

Register	Offset
FERSTAT	2Eh

36.4.4.1.11.2 Function

This register reports the detection of uncorrected ECC errors during read access to the FTFC module.

The DFDIF flag is readable and writable. The unassigned bits read 0 and are not writable.

36.4.4.1.11.3 Diagram

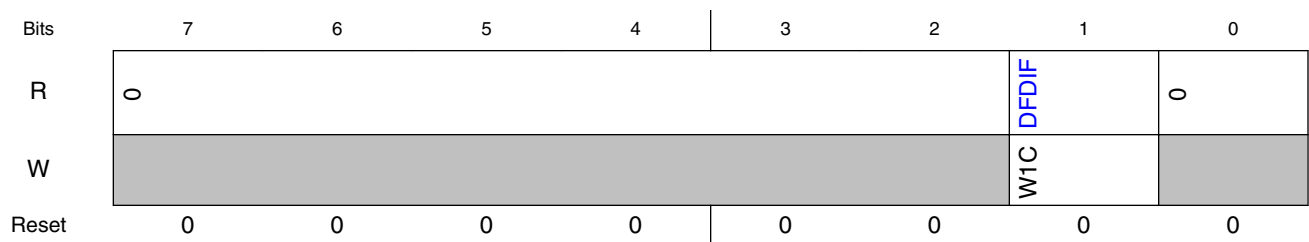

36.4.4.1.11.4 Fields

Field	Function
7-2 —	Reserved
1	Double Bit Fault Detect Interrupt Flag

Table continues on the next page...

Field	Function
DFDIF	The DFDIF flag indicates an uncorrectable ECC fault was detected during a valid flash read access from the platform flash controller. The DFDIF flag is cleared by writing a 1 to it. Writing a 0 to DFDIF has no effect. 0b - Double bit fault not detected during a valid flash read access from the platform flash controller 1b - Double bit fault detected (or FERCNFG[DFDD] is set) during a valid flash read access from the platform flash controller
0 —	Reserved

36.4.4.1.12 Flash Error Configuration Register (FERCNFG)

36.4.4.1.12.1 Offset

Register	Offset
FERCNFG	2Fh

36.4.4.1.12.2 Function

This register enables the force and interrupt of uncorrected ECC errors detected during read access to the FTFC module.

The FDFD and DFDIE bits are readable and writable. The unassigned bits read 0 and are not writable.

36.4.4.1.12.3 Diagram



36.4.4.1.12.4 Fields

Field	Function
7-6 —	Reserved
5	Force Double Bit Fault Detect

Table continues on the next page...

Functional description

Field	Function
DFD	The FDFD bit enables the user to emulate the setting of the FERSTAT[DFDIF] flag to check the associated interrupt routine. The FDFD bit is cleared by writing a 0 to FDFD. 0b - FERSTAT[DFDIF] sets only if a double bit fault is detected during read access from the platform flash controller 1b - FERSTAT[DFDIF] sets during any valid flash read access from the platform flash controller. An interrupt request is generated if the DFDIE bit is set.
4-2 —	Reserved
1 DFDIE	Double Bit Fault Detect Interrupt Enable The DFDIE bit controls interrupt generation when an uncorrectable ECC fault is detected during a valid flash read access from the platform flash controller. 0b - Double bit fault detect interrupt disabled 1b - Double bit fault detect interrupt enabled. An interrupt request is generated whenever the FERSTAT[DFDIF] flag is set.
0 —	Reserved

36.5 Functional description

The following sections describe functional details of the FTFC module.

36.5.1 Flash protection

Individual regions within the flash memory can be protected from program and erase operations. Protection is controlled by the following registers:

- FPROT n — Four registers protect 32 regions of the program flash memory as shown in the following figure

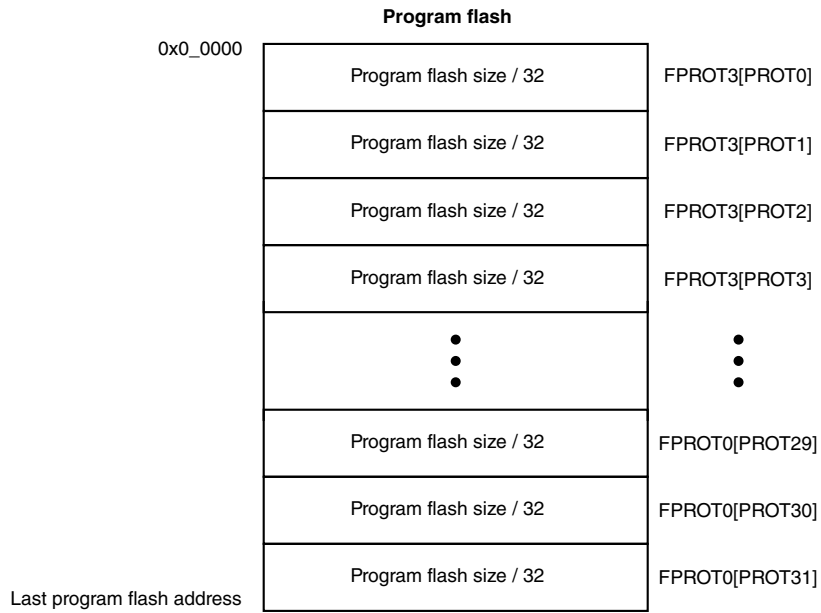

Figure 36-10. Program flash protection

- **FDPROT** —
 - For 2^n data flash sizes, protects eight regions of the data flash memory as shown in the following figure

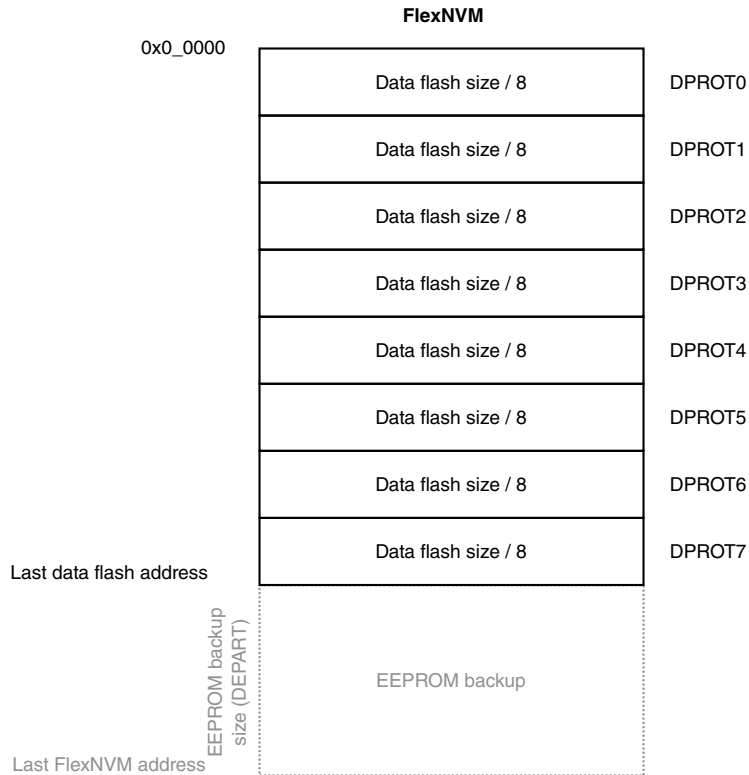

Figure 36-11. Data flash protection (2^n data flash sizes)

- **FEPROT** — Protects eight regions of the emulated EEPROM memory as shown in the following figure

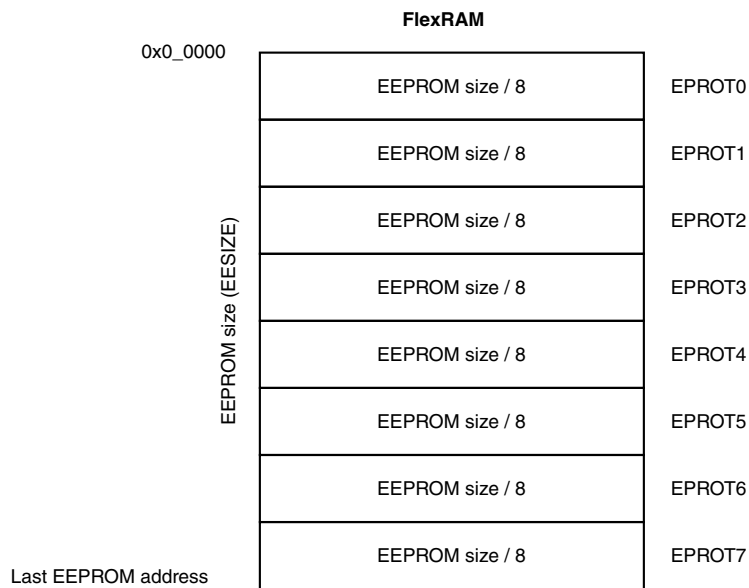

Figure 36-12. EEPROM protection

36.5.2 FlexNVM description

This section describes the FlexNVM memory.

36.5.2.1 FlexNVM block partitioning for FlexRAM

The user can configure the FlexNVM block as:

- Basic data flash,
- EEPROM flash records to support the built-in emulated EEPROM feature, or
- A combination of both.

When using the CSEc feature set, the EEE Flash configuration must be selected (EEPROM-backup size must be greater than 0).

The user's FlexNVM configuration choice is specified using the Program Partition command described in [Program Partition command](#).

CAUTION

While different partitions of the FlexNVM block are available, the intention is that a single partition choice is used throughout the entire lifetime of a given application. The FlexNVM partition code choices affect the endurance and data retention characteristics of the device.

36.5.2.2 EEPROM user perspective

The following figure shows the emulated EEPROM system. To handle varying customer requirements, the FlexRAM and FlexNVM blocks can be split into partitions as shown.

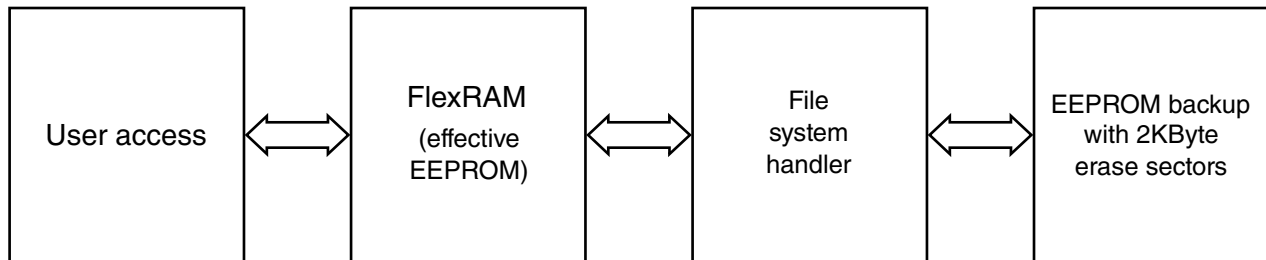

Figure 36-13. Top-level emulated EEPROM architecture

1. **EEPROM partition (EEESIZE)** — The amount of FlexRAM used for emulated EEPROM can be set to either 0 Bytes (no EEPROM), or to the maximum FlexRAM size. The emulated EEPROM partition grows from the bottom of the FlexRAM address space. Utilizing fewer records will increase the ratio of RAM to NVM, thus increasing the w/e endurance. For FlexRAM usage other than EEPROM (see [Set FlexRAM Function command](#)).
2. **Data flash partition (DEPART)** — The amount of FlexNVM memory used for data flash can be programmed from 0 bytes (all of the FlexNVM block is available for emulated EEPROM backup) to the maximum size of the FlexNVM block.
3. **FlexNVM EEPROM partition** — The amount of FlexNVM memory used for emulated EEPROM backup (see [Figure 36-9](#)). In order to achieve specified w/e cycle endurance, the emulated EEPROM backup size must be at least 16 times the emulated EEPROM partition size in FlexRAM. For parts other than the 2MB configuration (with interleaved DFlash), the FlexNVM may be split according to the Program Partition command, allowing for part EFlash and part DFlash. For example a 64kB FlexNVM could be partitioned for 32kB emulated EEPROM and 32kB DFlash. To maintain the full specified w/e endurance in the emulated EEPROM system, the number of records stored in FlexRAM should be limited to maintain the 1:16 ratio of RAM to NVM. The management of total number of records is left to the user.

The partition information (EEESIZE, DEPART) is stored in the data flash IFR and is programmed using the Program Partition command (see [Program Partition command](#)). Typically, the Program Partition command is executed only once in the lifetime of the device.

Data flash memory is useful for applications that need to quickly store large amounts of data or store data that is static. The emulated EEPROM partition in FlexRAM is useful for storing smaller amounts of data that will be changed often.

36.5.2.3 EEPROM implementation overview

Out of reset with the FSTAT[CCIF] bit clear, the partition settings (EESIZE, DEPART) are read from the data flash IFR and the emulated EEPROM file system is initialized accordingly. The emulated EEPROM file system locates all valid EEPROM data records in EEPROM backup and copies the newest data to FlexRAM. The FSTAT[CCIF] and FCNFG[EEERDY] bits are set after data from all valid EEPROM data records is copied to the FlexRAM. After the CCIF bit is set, the FlexRAM is available for read or write access.

When configured for emulated EEPROM use, writes to an unprotected location in FlexRAM invokes the emulated EEPROM file system to program a new EEPROM data record in the emulated EEPROM backup memory in a round-robin fashion. As needed, the emulated EEPROM file system identifies the emulated EEPROM backup sector that is being erased for future use and partially erases that emulated EEPROM backup sector. After a write to the FlexRAM, the FlexRAM is not accessible until the FSTAT[CCIF] bit is set. The FCNFG[EEERDY] bit will also be set. If enabled, the interrupt associated with the FSTAT[CCIF] bit can be used to determine when the FlexRAM is available for read or write access.

After a sector in emulated EEPROM backup is full of EEPROM data records, EEPROM data records from the sector holding the oldest data are gradually copied over to a previously-erased emulated EEPROM backup sector. When the sector copy completes, the emulated EEPROM backup sector holding the oldest data is tagged for erase.

CAUTION

Interrupting an emulated EEPROM operation (due to power loss, reset, supplies out of specified operational ranges, or any other reasons) will leave the contents in an indeterminate state. The user must take appropriate counter measures to prevent data loss in case of an interrupted emulated EEPROM operation.

36.5.2.4 Write endurance to FlexRAM for emulated EEPROM

When the FlexNVM partition code is not set to full data flash, the emulated EEPROM data set size should be set to the non-zero value.

The bytes not assigned to data flash via the FlexNVM partition code are used by the FTFC to obtain an effective endurance increase for the EEPROM data. The built-in emulated EEPROM record management system raises the number of program/erase cycles that can be attained prior to device wear-out by cycling the EEPROM data through a larger emulated EEPROM NVM storage space.

While different partitions of the FlexNVM are available, the intention is that a single choice for the FlexNVM partition code and emulated EEPROM data set size is used throughout the entire lifetime of a given application.

Normal EEE writes and quick writes should not be used in an aggressive brownout environment (e.g., multiple back-to-back brownouts without recovery in between).

36.5.2.5 ECC implementation for FlexNVM

When the FlexNVM region is configured as Data Flash, any single-bit ECC errors are automatically corrected, and any double-bit ECC errors are reflected onto FERSTAT[DFDIF] flag at the read access from Data Flash.

When the FlexNVM region is configured as Emulated EEPROM, any single-bit ECC errors are automatically corrected before copying data into EEERAM at the read access from Emulated EEPROM, and any double-bit ECC errors on valid Emulated EEPROM locations which containing data that need to be copied to EEERAM are reflected as the corresponding data records left as all 1's in EEERAM.

36.5.3 Interrupts

The FTFC module can generate interrupt requests to the MCU upon the occurrence of various FTFC events. These interrupt events and their associated status and control bits are shown in the following table.

Table 36-28. FTFC interrupt sources

FTFC Event	Readable Status Bit	Interrupt Enable Bit
FTFC Command and CSEc command Complete	FSTAT[CCIF]	FCNFG[CCIE]
FTFC Read Collision Error	FSTAT[RDCOLERR]	FCNFG[RDCOLLIE]
FTFC ECC Error Detection	FERSTAT[DFDIF]	FERCNFG[DFDIE]

Note

Vector addresses and their relative interrupt priority are determined at the MCU level.

36.5.4 Flash operation in low-power modes

36.5.4.1 Wait mode

When the MCU enters wait mode, the FTFC module is not affected. The FTFC module can recover the MCU from wait via the command complete interrupt (see [Interrupts](#)).

36.5.4.2 Stop mode

When the MCU requests stop mode, if an FTFC command is active (CCIF = 0) the command execution completes before the MCU is allowed to enter stop mode.

CAUTION

The MCU should never enter stop mode while any FTFC command is running (CCIF = 0).

NOTE

While the MCU is in very-low-power modes (VLPR, VLPW, VLPS), the FTFC module does not accept flash commands.

36.5.5 Functional modes of operation

The FTFC module has two operating modes: NVM Normal and NVM Special. The operating mode affects the command set availability (see [Table 36-29](#)). Refer to the Chip Configuration details of this device for how to activate each mode.

36.5.6 Flash memory reads and ignored writes

The FTFC module requires only the flash address to execute a flash memory read. MCU read access is available to all flash memory.

The MCU must not read from the flash memory while commands are running (as evidenced by CCIF=0) on that block. Read data cannot be guaranteed from a flash block while any command is processing within that block. The block arbitration logic detects any simultaneous access and reports this as a read collision error (see the FSTAT[RDCOLERR] bit).

36.5.7 Read while write (RWW)

The following simultaneous accesses are allowed for devices with FlexNVM:

- The user may read from one partition of the program flash memory while commands (typically program and erase operations) are active in another partition of the program flash, the data flash, and FlexRAM memory space.
- The MCU can fetch instructions from program flash during both data flash program and erase operations and while emulated EEPROM backup is maintained by the EEPROM commands.
- Conversely, the user may read from data flash and FlexRAM while program and erase commands are executing on the program flash.
- When configured as traditional RAM, writes to the FlexRAM are allowed during data flash operations.

Simultaneous data flash operations and FlexRAM writes, when FlexRAM is used for EEE, are not possible.

Simultaneous operations are further discussed in [Allowed simultaneous flash operations](#).

36.5.8 Flash program and erase

All flash functions except read require the user to setup and launch an FTFC command through a series of peripheral bus writes. The user cannot initiate any further FTFC commands until notified that the current command has completed. The FTFC command structure and operation are detailed in [FTFC command operations](#).

CAUTION

Interrupting a program or erase operation (due to power loss, reset, supplies out of specified operational ranges, or any other reasons) will leave the contents in an indeterminate state. The user must take appropriate counter measures to prevent data loss in case of an interrupted program or erase operation.

36.5.9 FTFC command operations

FTFC command (not related to CSEc) operations are typically used to modify flash memory contents. The next sections describe:

- The command write sequence used to set FTFC command parameters and launch execution
- A description of all FTFC commands available

NOTE

1. For CSEc/SHE commands, refer to [Cryptographic Services Engine \(CSEc\)](#)
2. Warning: When running any FTFC command such as ERSALL that changes the flash configuration content, care must be taken with re-programming the configuration information prior to reset. Otherwise, the part may get locked up

36.5.9.1 Command write sequence

FTFC commands are specified using a command write sequence illustrated in [Figure 36-14](#). The FTFC module performs various checks on the command (FCCOB) content and continues with command execution if all requirements are fulfilled.

Before launching a command, the ACCERR and FPVIOL bits in the FSTAT register must be zero and the CCIF flag must read 1 to verify that any previous command has completed. If CCIF is zero, the previous command execution is still active, a new command write sequence cannot be started, and all writes to the FCCOB registers are ignored.

Attempts to launch an FTFC command in VLP mode will be ignored. Attempts to launch any FTFC command (including SHE commands, FlexRAM/EEPROM accesses) in HSRUN mode will be trapped with the ACCERR flag being set.

36.5.9.1.1 Load the FCCOB registers

The user must load the FCCOB registers with all parameters required by the desired FTFC command. The individual registers that make up the FCCOB data set can be written in any order. The user must be sure to provide all of the required parameters (which may vary from command to command).

36.5.9.1.2 Launch the command by clearing CCIF

Once all relevant command parameters have been loaded, the user launches the command by clearing the FSTAT[CCIF] bit by writing a '1' to it. The CCIF flag remains zero until the FTFC command completes.

The FSTAT register contains a blocking mechanism, which prevents a new command from launching (can't clear CCIF) if the previous command resulted in an access error (FSTAT[ACCERR]=1) or a protection violation (FSTAT[FPVIOL]=1). In error scenarios, two writes to FSTAT are required to initiate the next command: the first write clears the error flags, the second write clears CCIF.

36.5.9.1.3 Command execution and error reporting

The command processing has several steps:

1. The FTFC reads the command code and performs a series of parameter checks and protection checks, if applicable, which are unique to each command.

If the parameter check fails, the FSTAT[ACCERR] (access error) flag is set. ACCERR reports invalid instruction codes and out-of bounds addresses. Usually, access errors suggest that the command was not set-up with valid parameters in the FCCOB register group.

Program and erase commands also check the address to determine if the operation is requested to execute on protected areas. If the protection check fails, the FSTAT[FPVIOL] (protection error) flag is set.

Command processing never proceeds to execution when the parameter or protection step fails. Instead, command processing is terminated after setting the FSTAT[CCIF] bit.

2. If the parameter and protection checks pass, the command proceeds to execution. Run-time errors, such as failure to erase verify, may occur during the execution phase. Run-time errors are reported in the FSTAT[MGSTAT0] bit. A command may have access errors, protection errors, and run-time errors, but the run-time errors are not seen until all access and protection errors have been corrected.
3. Command execution results, if applicable, are reported back to the user via the FCCOB and FSTAT registers.
4. The FTFC sets the FSTAT[CCIF] bit signifying that the command has completed.

The flow for a generic command write sequence is illustrated in the following figure.

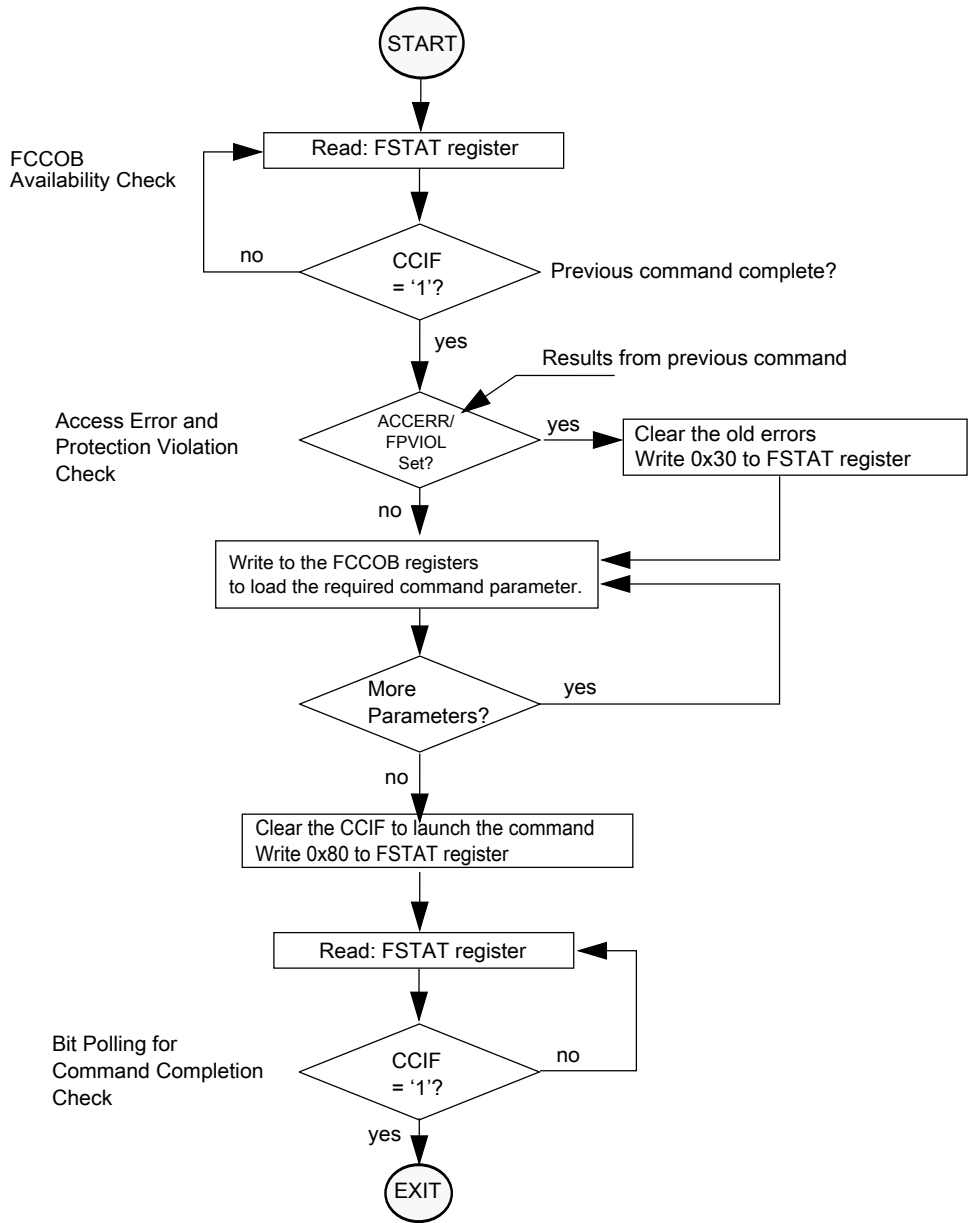

Figure 36-14. Generic flash command write sequence flowchart

36.5.9.2 Flash commands

The following table summarizes the function of all flash commands. If any column is marked with an 'X', the flash command is relevant to that particular memory resource.

FCMD	Command	Program Flash	Data Flash	FlexRAM	Function
0x00	Read 1s Block	x	x		Verify that a program flash or data flash block is erased. FlexNVM

Table continues on the next page...

FCMD	Command	Program Flash	Data Flash	FlexRAM	Function
					block must not be partitioned for emulated EEPROM.
0x01	Read 1s Section	x	x		Verify that a given number of program flash or data flash locations from a starting address are erased.
0x02	Program Check	x	x		Tests previously-programmed phrases at margin read levels.
0x07	Program Phrase	x	x		Program 8 bytes in a program flash block or a data flash block.
0x08	Erase Flash Block	x	x		Erase a program flash block or data flash block. An erase of any flash block is only possible when unprotected. FlexNVM block must not be partitioned for emulated EEPROM.
0x09	Erase Flash Sector	x	x		Erase all bytes in a program flash or data flash sector.
0x0B	Program Section	x	x	x	Program data from the Section Program Buffer to a program flash or data flash block.
0x40	Read 1s All Blocks	x	x		Verify that all program flash, data flash blocks, emulated EEPROM backup data records, and data flash IFR are erased then release MCU security.
0x41	Read Once	IFR			Read 8 bytes of a dedicated 64 byte field in the program flash 0 IFR.
0x43	Program Once	IFR			One-time program of 8 bytes of a

Table continues on the next page...

Functional description

FCMD	Command	Program Flash	Data Flash	FlexRAM	Function
					dedicated 64-byte field in the program flash 0 IFR.
0x44	Erase All Blocks	x	x	x	<p>Erase all program flash blocks, data flash blocks, FlexRAM, emulated EEPROM backup data records, and data flash IFR. Then, verify-erase. The flash security byte is left erased (secured state).</p> <p>NOTE: An erase is only possible when all memory locations are unprotected.</p>
0x45	Verify Backdoor Access Key	x			Release MCU security after comparing a set of user-supplied security keys to those stored in the program flash.
0x49	Erase All Blocks Unsecure	x	x	x	Erase all program flash blocks, data flash blocks, FlexRAM, emulated EEPROM backup data records, and data flash IFR. Then, verify-erase, program the security byte to the unsecure state.
0x80	Program Partition		IFR, x	x	Program the FlexNVM Partition Code and emulated EEPROM Data Set Size into the data flash IFR. format all emulated EEPROM backup data sectors allocated for emulated

Table continues on the next page...

FCMD	Command	Program Flash	Data Flash	FlexRAM	Function
					EEPROM, initialize the FlexRAM.
0x81	Set FlexRAM Function		×	×	Switches FlexRAM function between RAM and emulated EEPROM. When switching to emulated EEPROM, FlexNVM is not available while valid data records are being copied from emulated EEPROM backup to FlexRAM.

36.5.9.3 Flash commands by mode

The following table shows the flash commands that can be executed in each flash operating mode.

Table 36-29. Flash commands by mode

FCMD	Command	Unsecure	Secure	MEEN=10
0x00	Read 1s Block	×	×	×
0x01	Read 1s Section	×	×	×
0x02	Program Check	×	×	×
0x07	Program Phrase	×	×	×
0x08	Erase Flash Block	×	×	×
0x09	Erase Flash Sector	×	×	×
0x0B	Program Section	×	×	×
0x40	Read 1s All Blocks	×	×	×
0x41	Read Once	×	×	×
0x43	Program Once	×	×	×
0x44	Erase All Blocks	×	×	×
0x45	Verify Backdoor Access Key	×	×	×
0x49	Erase All Blocks Unsecure	×	×	—
0x80	Program Partition	×	×	×
0x81	Set FlexRAM Function	×	×	×

36.5.9.4 Allowed simultaneous flash operations

Only the operations marked 'OK' in the following table are permitted to run simultaneously on the program flash, data flash, and FlexRAM memories. Some operations cannot be executed simultaneously because certain hardware resources are shared by the memories. The priority has been placed on permitting program flash reads while program and erase operations execute on the FlexNVM and FlexRAM. This provides read (program flash) while write (FlexNVM, FlexRAM) functionality. In general, none of these CCOB commands may be executed simultaneously with any CSEc command, and vice versa. See the CSEc chapter for details.

Table 36-30. Allowed simultaneous memory operations

		Program flash X ¹			Data flash			FlexRAM/PRAM		
		Read	Program Phrase	Erase Flash Sector ²	Read	Program Phrase	Erase Flash Sector ²	Read	EE-Write ³	RAM-Write ⁴
Program flash Y ¹	Read		OK	OK		OK	OK		OK	
	Program Phrase	OK			OK			OK		OK
	Erase Flash Sector ²	OK			OK			OK		OK
Data flash	Read		OK	OK						
	Program Phrase	OK						OK		OK
	Erase Flash Sector ²	OK						OK		OK
FlexRAM	Read		OK	OK		OK	OK			
	EE-Write ³	OK								
	RAM-Write ⁴		OK	OK		OK	OK			

1. PFlash X refers to any of the PFlash partitions and PFlash Y refers to any of the PFlash partitions, but not the same block. Thus, it is possible to read from any of the partitions while programming or erasing another. While it's impossible to read, program or erase the same PFlash partition at the same time.
2. Also applies to Erase Flash Block
3. When FlexRAM configured for emulated EEPROM (EEERDY=1).
4. When FlexRAM configured as traditional RAM (RAMRDY=1); single cycle operation.

36.5.10 Margin read commands

The Read-1s commands (Read 1s All Blocks, Read 1s Block, Read 1s Section) and the Program Check command have a margin choice parameter that allows the user to apply non-standard read reference levels to the program flash and data flash array reads performed by these commands. Using the preset 'user' and 'factory' margin levels, these

commands perform their associated read operations at tighter tolerances than a 'normal' read. These non-standard read levels are applied only during the command execution. All simple (un-commanded) flash array reads to the MCU always use the standard, un-margined, read reference level.

Only the 'normal' read level should be employed during normal flash usage. The non-standard, 'user' and 'factory' margin levels should be employed only in special cases. They can be used during special diagnostic routines to gain confidence that the device is not suffering from the end-of-life data loss customary of flash memory devices.

Erased ('1') and programmed ('0') bit states can degrade due to elapsed time and data cycling (number of times a bit is erased and re-programmed). The lifetime of the erased states is relative to the last erase operation. The lifetime of the programmed states is measured from the last program time.

The 'user' and 'factory' levels become, in effect, a minimum margin, i.e., if the reads pass at the tighter tolerances of the 'user' and 'factory' margins, then the 'normal' reads have at least this much margin before they experience data loss.

The 'user' margin is a small delta to the normal read reference level. 'User' margin levels can be employed to check that flash memory contents have adequate margin for normal level read operations. If unexpected read results are encountered when checking flash memory contents at the 'user' margin levels, loss of information might soon occur during 'normal' readout.

The 'factory' margin is a bigger deviation from the norm, a more stringent read criteria that should only be attempted immediately (or very soon) after completion of an erase or program command, early in the cycling life. 'Factory' margin levels can be used to check that flash memory contents have adequate margin for long-term data retention at the normal level setting. If unexpected results are encountered when checking flash memory contents at 'factory' margin levels, the flash memory contents should be erased and reprogrammed.

CAUTION

Factory margin levels must only be used during verify of the initial factory programming.

36.5.11 Flash command descriptions

This section describes all flash commands that can be launched by a command write sequence. The FTFC sets the FSTAT[ACCERR] bit and aborts the command execution if any of the following illegal conditions occur:

Functional description

- There is an unrecognized command code in the FCCOB FCMD field.
- There is an error in a FCCOB field for the specific commands. Refer to the error handling table provided for each command.

Ensure that the ACCERR and FPVIOL bits in the FSTAT register are cleared prior to starting the command write sequence. As described in [Launch the command by clearing CCIF](#), a new command cannot be launched while these error flags are set.

Do not attempt to read a flash block while the FTFC is running a command (CCIF = 0) on that same block. The FTFC may return invalid data to the MCU with the collision error flag (FSTAT[RDCOLERR]) set.

When required by the command, address bit 23 selects between program flash memory (=0) and data flash memory (=1).

CAUTION

Flash data must be in the erased state before being programmed. Cumulative programming of bits (adding more zeros) is not allowed.

36.5.11.1 Read 1s Block command

The Read 1s Block command checks to see if an entire program flash or data flash block has been erased to the specified margin level. The FCCOB flash address bits determine which block is erase-verified.

Table 36-31. Read 1s Block Command FCCOB requirements

FCCOB Number	FCCOB Contents [7:0]
0	0x00 (RD1BLK)
1	Flash address [23:16] in the flash block to be verified
2	Flash address [15:8] in the flash block to be verified
3	Flash address [7:0] ¹ in the flash block to be verified
4	Read-1 Margin Choice

1. Must be 128-bit aligned (Flash address [3:0] = 0000) for interleaved flash, 64-bit aligned (Flash address [2:0] = 000) for non-interleaved flash.

After clearing CCIF to launch the Read 1s Block command, the FTFC sets the read margin for 1s according to [Table 36-32](#) and then reads all locations within the selected program flash or data flash block.

When the data flash is targeted, DEPART must be set for no EEPROM, else the Read 1s Block command aborts setting the FSTAT[ACCERR] bit. If the FTFC fails to read all 1s (i.e., the flash block is not fully erased), the FSTAT[MGSTAT0] bit is set. The CCIF flag sets after the Read 1s Block operation has completed.

Table 36-32. Margin level choices for Read 1s Block

Read Margin Choice	Margin Level Description
0x00	Use the 'normal' read level for 1s
0x01	Apply the 'User' margin to the normal read-1 level
0x02	Apply the 'Factory' margin to the normal read-1 level

Table 36-33. Read 1s Block Command error handling

Error Condition	Error Bit
Command not available in current mode/security	FSTAT[ACCERR]
An invalid margin choice is specified	FSTAT[ACCERR]
Program flash is selected and the address is out of program flash range	FSTAT[ACCERR]
Data flash is selected and the address is out of data flash range	FSTAT[ACCERR]
Data flash is selected with emulated EEPROM enabled	FSTAT[ACCERR]
Flash address is not 128-bit aligned for interleaved flash, 64-bit aligned for non-interleaved flash	FSTAT[ACCERR]
Read-1s fails	FSTAT[MGSTAT0]

36.5.11.2 Read 1s Section command

The Read 1s Section command checks if a section of program flash or data flash memory is erased to the specified read margin level. The Read 1s Section command defines the starting address and the number of double-phrases to be verified for program flash, phrases for data flash.

Table 36-34. Read 1s Section command FCCOB requirements

FCCOB Number	FCCOB Contents [7:0]
0	0x01 (RD1SEC)
1	Flash address [23:16] of the first double-phrase to be verified for interleaved flash, phrase for non-interleaved flash
2	Flash address [15:8] of the first double-phrase to be verified for interleaved flash, phrase for non-interleaved flash
3	Flash address [7:0] ¹ of the first double-phrase to be verified for interleaved flash, phrase for non-interleaved flash
4	Number of double-phrases to be verified for interleaved flash, phrases for non-interleaved flash [15:8]

Table continues on the next page...

Table 36-34. Read 1s Section command FCCOB requirements (continued)

FCCOB Number	FCCOB Contents [7:0]
5	Number of double-phrases to be verified for interleaved flash, phrases for non-interleaved flash [7:0]
6	Read-1 Margin Choice

1. Must be 128-bit aligned (Flash address [3:0] = 0000) for interleaved flash, 64-bit aligned (Flash address [2:0] = 000) for non-interleaved flash.

Upon clearing CCIF to launch the Read 1s Section command, the FTFC sets the read margin for 1s according to [Table 36-35](#) and then reads all locations within the specified section of flash memory.

If the FTFC fails to read all 1s (i.e., the flash section is not erased), the FSTAT(MGSTAT0) bit is set. The CCIF flag sets after the Read 1s Section operation completes.

Table 36-35. Margin level choices for Read 1s Section

Read Margin Choice	Margin Level Description
0x00	Use the 'normal' read level for 1s
0x01	Apply the 'User' margin to the normal read-1 level
0x02	Apply the 'Factory' margin to the normal read-1 level

Table 36-36. Read 1s Section command error handling

Error Condition	Error Bit
Command not available in current mode/security	FSTAT[ACCERR]
An invalid margin code is supplied	FSTAT[ACCERR]
An invalid flash address is supplied	FSTAT[ACCERR]
Flash address is not 128-bit aligned for interleaved flash, 64-bit aligned for non-interleaved flash	FSTAT[ACCERR]
The requested section crosses a flash block boundary	FSTAT[ACCERR]
The requested number of double-phrases for interleaved flash, phrases for non-interleaved flash is zero	FSTAT[ACCERR]
Read-1s fails	FSTAT[MGSTAT0]

36.5.11.3 Program Check command

The Program Check command tests a previously programmed program flash or data flash longword to see if it reads correctly at the specified margin level.

Table 36-37. Program Check command FCCOB requirements

FCCOB Number	FCCOB Contents [7:0]
0	0x02 (PGMCHK)
1	Flash address [23:16]
2	Flash address [15:8]
3	Flash address [7:0] ¹
4	Margin Choice
8	Byte 0 expected data
9	Byte 1 expected data
A	Byte 2 expected data
B	Byte 3 expected data

1. Must be longword aligned (Flash address [1:0] = 00).

Upon clearing CCIF to launch the Program Check command, the FTFC sets the read margin for 1s based on the provided margin choice according to [Table 36-38](#). The Program Check operation then reads the specified longword, and compares the actual read data to the expected data provided by the FCCOB. If the comparison at margin-1 fails, the MGSTAT0 bit is set.

The FTFC will then set the read margin for 0s based on the provided margin choice. The Program Check operation will then read the specified longword and compare the actual read data to the expected data provided by the FCCOB. If the comparison at margin-0 fails, the MGSTAT0 bit will be set. The CCIF flag will set after the Program Check operation has completed.

The starting address must be longword aligned (the lowest two bits of the byte address must be 00):

- Byte 0 data is expected at the supplied 32-bit aligned address,
- Byte 1 data is expected at byte address specified + 0b01,
- Byte 2 data is expected at byte address specified + 0b10, and
- Byte 3 data is expected at byte address specified + 0b11.

NOTE

See the description of margin reads, [Margin read commands](#)

Table 36-38. Margin level choices for Program Check

Read Margin Choice	Margin Level Description
0x01	Read at 'User' margin-1 and 'User' margin-0
0x02	Read at 'Factory' margin-1 and 'Factory' margin-0

Table 36-39. Program Check command error handling

Error Condition	Error Bit
Command not available in current mode/security	FSTAT[ACCERR]
An invalid flash address is supplied	FSTAT[ACCERR]
Flash address is not longword aligned	FSTAT[ACCERR]
An invalid margin choice is supplied	FSTAT[ACCERR]
Either of the margin reads does not match the expected data	FSTAT[MGSTAT0]

36.5.11.4 Program Phrase command

The Program Phrase command programs eight previously-erased bytes in the program flash memory or in the data flash memory using an embedded algorithm.

CAUTION

A Flash memory location must be in the erased state before being programmed. Cumulative programming of bits (back-to-back program operations without an intervening erase) within a Flash memory location is not allowed. Re-programming of existing 0s to 0 is not allowed as this overstresses the device.

Table 36-40. Program Phrase Command FCCOB requirements

FCCOB Number	FCCOB Contents [7:0]
0	0x07 (PGM8)
1	Flash address [23:16]
2	Flash address [15:8]
3	Flash address [7:0] ¹
4	Byte 0 program value
5	Byte 1 program value
6	Byte 2 program value
7	Byte 3 program value
8	Byte 4 program value
9	Byte 5 program value
A	Byte 6 program value
B	Byte 7 program value

1. Must be 64-bit aligned (Flash address [2:0] = 000)

Upon clearing CCIF to launch the Program Phrase command, the FTFC programs the data bytes into the flash using the supplied address. The protection status is always checked. The targeted flash locations must be currently unprotected (see the description of the FPROT registers) to permit execution of the Program Phrase operation.

The programming operation is unidirectional. It can only move NVM bits from the erased state ('1') to the programmed state ('0'). Erased bits that fail to program to the '0' state are flagged as errors in MGSTAT0. The CCIF flag is set after the Program Phrase operation completes.

The starting address must be 64-bit aligned (flash address [2:0] = 000):

- Byte 0 data is written to the starting address ('start'),
- Byte 1 data is programmed to byte address start+0b01,
- Byte 2 data is programmed to byte address start+0b10, and
- Byte 3 data is programmed to byte address start+0b11, etc.

Table 36-41. Program Phrase command error handling

Error Condition	Error Bit
Command not available in current mode/security	FSTAT[ACCERR]
An invalid flash address is supplied	FSTAT[ACCERR]
Flash address is not 64-bit aligned	FSTAT[ACCERR]
Flash address points to a protected area	FSTAT[FPVIOL]
Any errors have been encountered during the verify operation.	FSTAT[MGSTAT0]

36.5.11.5 Erase Flash Block command

The Erase Flash Block operation erases all addresses in a single program flash or data flash block.

Table 36-42. Erase Flash Block command FCCOB requirements

FCCOB Number	FCCOB Contents [7:0]
0	0x08 (ERSBLK)
1	Flash address [23:16] in the flash block to be erased
2	Flash address [15:8] in the flash block to be erased
3	Flash address [7:0] ¹ in the flash block to be erased

1. Must be 128-bit aligned (Flash address [3:0] = 0000) for interleaved flash, 64-bit aligned (Flash address [2:0] = 000) for non-interleaved flash.

Upon clearing CCIF to launch the Erase Flash Block command, the FTFC erases the main array of the selected flash block and verifies that it is erased. When the data flash is targeted, DEPART must be set for no EEPROM (see [FlexNVM partition code](#)) else the Erase Flash Block command aborts setting the FSTAT[ACCERR] bit. The Erase Flash Block command aborts and sets the FSTAT[FPVIOL] bit if any region within the block is protected (see the description of the program flash protection (FPROT) registers and the

Functional description

data flash protection (FDPROT) registers). If the erase verify fails, the MGSTAT0 bit in FSTAT is set. The CCIF flag will set after the Erase Flash Block operation has completed.

Table 36-43. Erase Flash Block command error handling

Error Condition	Error Bit
Command not available in current mode/security	FSTAT[ACCERR]
Program flash is selected and the address is out of program flash range	FSTAT[ACCERR]
Data flash is selected and the address is out of data flash range	FSTAT[ACCERR]
Data flash is selected with emulated EEPROM enabled	FSTAT[ACCERR]
Flash address is not 128-bit aligned for interleaved flash, 64-bit aligned for non-interleaved flash	FSTAT[ACCERR]
Any area of the selected flash block is protected	FSTAT[FPVIOL]
Any errors have been encountered during the verify operation ¹	FSTAT[MGSTAT0]

1. User margin read may be run using the Read 1s Block command to verify all bits are erased.

36.5.11.6 Erase Flash Sector command

The Erase Flash Sector operation erases all addresses in a flash sector.

Table 36-44. Erase Flash Sector command FCCOB requirements

FCCOB Number	FCCOB Contents [7:0]
0	0x09 (ERSSCR)
1	Flash address [23:16] in the flash sector to be erased
2	Flash address [15:8] in the flash sector to be erased
3	Flash address [7:0] ¹ in the flash sector to be erased

1. Must be 128-bit aligned (Flash address [3:0] = 0000) for interleaved flash, 64-bit aligned (Flash address [2:0] = 000) for non-interleaved flash.

After clearing CCIF to launch the Erase Flash Sector command, the FTFC erases the selected program flash or data flash sector and then verifies that it is erased. The Erase Flash Sector command aborts if the selected sector is protected (see the description of the FPROT registers). If the erase-verify fails the FSTAT[MGSTAT0] bit is set. The CCIF flag is set after the Erase Flash Sector operation completes. The Erase Flash Sector command is suspendable (see the FCNFG[ERSSUSP] bit and [Figure 36-15](#)).

Table 36-45. Erase Flash Sector command error handling

Error Condition	Error Bit
Command not available in current mode/security	FSTAT[ACCERR]
An invalid Flash address is supplied	FSTAT[ACCERR]

Table continues on the next page...

Table 36-45. Erase Flash Sector command error handling (continued)

Error Condition	Error Bit
Flash address is not 128-bit aligned for interleaved flash, 64-bit aligned for non-interleaved flash	FSTAT[ACCERR]
The selected program flash or data flash sector is protected	FSTAT[FPVIOL]
Any errors have been encountered during the verify operation ¹	FSTAT[MGSTAT0]

1. User margin read may be run using the Read 1s Section command to verify all bits are erased.

36.5.11.6.1 Suspending an Erase Flash Sector operation

To suspend an Erase Flash Sector operation set the FCNFG[ERSSUSP] bit when CCIF, ACCERR, and FPVIOL are clear and the CCOB command field holds the code for the Erase Flash Sector command. During the Erase Flash Sector operation (see [Erase Flash Sector command](#)), the flash samples the state of the ERSSUSP bit at convenient points. If the FTFC detects that the ERSSUSP bit is set, the Erase Flash Sector operation is suspended and the FTFC sets CCIF. While ERSSUSP is set, all writes to flash registers are ignored except for writes to the FSTAT, FCNFG, FERCNFG and FERSTAT registers.

If an Erase Flash Sector operation effectively completes before the FTFC detects that a suspend request has been made, the FTFC clears the ERSSUSP bit prior to setting CCIF. When an Erase Flash Sector operation has been successfully suspended, the FTFC sets CCIF and leaves the ERSSUSP bit set. While CCIF is set, the ERSSUSP bit can only be cleared to prevent the withdrawal of a suspend request before the FTFC has acknowledged it.

36.5.11.6.2 Resuming a suspended Erase Flash Sector operation

If the ERSSUSP bit is still set when CCIF is cleared to launch the next command, the previous Erase Flash Sector operation resumes. The FTFC acknowledges the request to resume a suspended operation by clearing the ERSSUSP bit. A new suspend request can then be made by setting ERSSUSP. A single Erase Flash Sector operation can be suspended and resumed multiple times.

There is a minimum elapsed time limit of 4.3 msec between the request to resume the Erase Flash Sector operation (CCIF is cleared) and the request to suspend the operation again (ERSSUSP is set). This minimum time period is required to ensure that the Erase Flash Sector operation will eventually complete. If the minimum period is continually violated, i.e., the suspend requests come repeatedly and too quickly, no forward progress is made by the Erase Flash Sector algorithm. The resume/suspend sequence runs indefinitely without completing the erase.

36.5.11.6.3 Aborting a suspended Erase Flash Sector operation

The user may choose to abort a suspended Erase Flash Sector operation by clearing the ERSSUSP bit prior to clearing CCIF for the next command launch. When a suspended operation is aborted, the FTFC starts the new command using the new FCCOB contents.

While FCNFG[ERSSUSP] is set, a write to the FlexRAM while FCNFG[EEERDY] is set clears ERSSUSP and aborts the suspended operation. The FlexRAM write operation is executed by the FTFC.

Note

Aborting the erase leaves the bitcells in an indeterminate, partially-erased state. Data in this sector is not reliable until a new erase command fully completes.

The following figure shows how to suspend and resume the Erase Flash Sector operation.

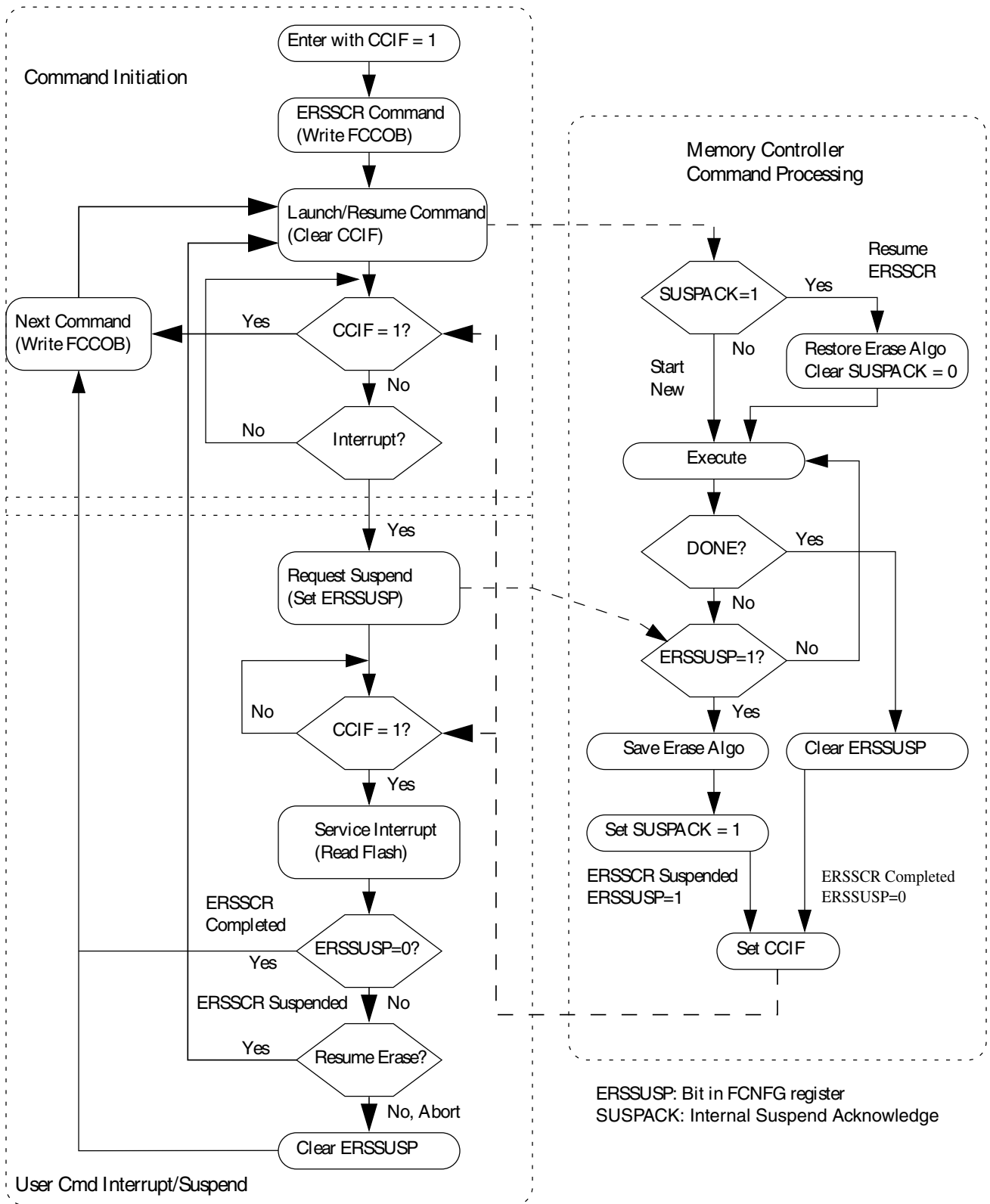

Figure 36-15. Suspend and resume of Erase Flash Sector operation

36.5.11.7 Program Section command

The Program Section operation programs the data found in the section program buffer to previously erased locations in the flash memory using an embedded algorithm. Data is preloaded into the section program buffer by writing to the FlexRAM while it is set to function as a programming acceleration RAM (see [Flash sector programming](#)).

The section program buffer is limited to the lower quarter of the programming acceleration RAM (byte addresses 0x0000- 0x<1/4 * FlexRAM size>). Data written to the remainder of the programming acceleration RAM is ignored and may be overwritten during Program Section command execution.

CAUTION

A flash memory location must be in the erased state before being programmed. Cumulative programming of bits (back-to-back program operations without an intervening erase) within a flash memory location is not allowed. Re-programming of existing 0s to 0 is not allowed as this overstresses the device.

Table 36-46. Program Section command FCCOB requirements

FCCOB Number	FCCOB Contents [7:0]
0	0x0B (PGMSEC)
1	Flash address [23:16]
2	Flash address [15:8]
3	Flash address [7:0] ¹
4	Number of double-phrases (for interleaved blocks), phrases (for non-interleaved blocks) to program [15:8]
5	Number of double-phrases (for interleaved blocks), phrases (for non-interleaved blocks) to program [7:0]

1. Must be 128-bit aligned (Flash address [3:0] = 0000) for interleaved flash, 64-bit aligned (Flash address [2:0] = 000) for non-interleaved flash.

After clearing CCIF to launch the Program Section command, the FTFC will block access to the FlexRAM and program the data residing in the Section Program Buffer into the flash memory starting at the flash address provided.

The starting address must be unprotected (see the description of the FPROT registers) to permit execution of the Program Section operation. Programming, which is not allowed to cross a flash sector boundary, continues until all requested double-phrases (for interleaved blocks), phrases (for non-interleaved blocks) have been programmed.

After the Program Section operation has completed, the CCIF flag will set and normal access to the FlexRAM is restored. The contents of the Section Program Buffer is not changed by the Program Section operation.

Table 36-47. Program Section command error handling

Error Condition	Error Bit
Command not available in current mode/security	FSTAT[ACCERR]
An invalid flash address is supplied	FSTAT[ACCERR]
Flash address is not 128-bit aligned for interleaved flash, 64-bit aligned for non-interleaved flash	FSTAT[ACCERR]
The requested section crosses a program flash sector boundary	FSTAT[ACCERR]
The requested number of double-phrases for interleaved flash, phrases for non-interleaved flash is zero	FSTAT[ACCERR]
The space required to store data for the requested number of double-phrases for interleaved flash, phrases for non-interleaved flash is more than one quarter the size of the FlexRAM	FSTAT[ACCERR]
The FlexRAM is not set to function as a traditional RAM, i.e., set if RAMRDY=0	FSTAT[ACCERR]
The flash address falls in a protected area	FSTAT[FPVIOL]
Any errors have been encountered during the verify operation	FSTAT[MGSTAT0]

36.5.11.7.1 Flash sector programming

The process of programming an entire flash sector using the Program Section command is as follows:

1. If required, execute the Set FlexRAM Function command to make the FlexRAM available as traditional RAM and initialize the FlexRAM to all ones.
2. Launch the Erase Flash Sector command to erase the flash sector to be programmed.
3. Beginning with the starting address of the FlexRAM, sequentially write enough data to the RAM to fill an entire flash sector or one quarter of the FlexRAM, whichever is less. This area of the RAM serves as the section program buffer.

NOTE

In step 1, the section program buffer was initialized to all ones, the erased state of the flash memory.

The section program buffer can be written to while the operation launched in step 2 is executing, i.e., while CCIF = 0.

4. Execute the Program Section command to program the contents of the section program buffer into the selected flash sector.
5. If a Flash sector is larger than one quarter of the FlexRAM, repeat steps 3 and 4 until the sector has been completely programmed.
6. To program additional flash sectors, repeat steps 2 through 4.
7. To restore emulated EEPROM functionality, execute the Set FlexRAM Function command to make the FlexRAM available for emulated EEPROM.

36.5.11.8 Read 1s All Blocks command

The Read 1s All Blocks command checks if the program flash blocks, data flash blocks, emulated EEPROM backup records, and data flash IFR have been erased to the specified read margin level, if applicable, and releases security if the readout passes, i.e. all data reads as '1'.

Table 36-48. Read 1s All Blocks command FCCOB requirements

FCCOB Number	FCCOB Contents [7:0]
0	0x40 (RD1ALL)
1	Read-1 Margin Choice

After clearing CCIF to launch the Read 1s All Blocks command, the FTFC:

- sets the read margin for 1s according to [Table 36-49](#),
- checks the contents of the program flash, data flash, emulated EEPROM backup records, and data flash IFR are in the erased state.

If the FTFC confirms that these memory resources are erased, security is released by setting the FSEC[SEC] field to the unsecure state. The security byte in the flash configuration field (see [Flash configuration field description](#)) remains unaffected by the Read 1s All Blocks command. If the read fails, i.e., all flash memory resources are not in the fully erased state, the FSTAT[MGSTAT0] bit is set.

The EEERDY and RAMRDY bits are clear during the Read 1s All Blocks operation and are restored at the end of the Read 1s All Blocks operation.

The CCIF flag sets after the Read 1s All Blocks operation has completed.

Table 36-49. Margin level choices for Read 1s All Blocks

Read Margin Choice	Margin Level Description
0x00	Use the 'normal' read level for 1s
0x01	Apply the 'User' margin to the normal read-1 level
0x02	Apply the 'Factory' margin to the normal read-1 level

Table 36-50. Read 1s All Blocks command error handling

Error Condition	Error Bit
An invalid margin choice is specified	FSTAT[ACCERR]
Read-1s fails	FSTAT[MGSTAT0]

36.5.11.9 Read Once command

The Read Once command provides read access to a reserved 64 -byte field located in the program flash IFR (see [Program flash 0 IFR map](#) and [Program Once field](#)). Access to the Program Once field is via 8 records, each 8 bytes long. The Program Once field is programmed using the Program Once command described in [Program Once command](#).

Table 36-51. Read Once command FCCOB requirements

FCCOB Number	FCCOB Contents [7:0]
0	0x41 (RDONCE)
1	Program Once record index (0x00 - 0x07)
Returned Values	
4	Program Once byte 0 value
5	Program Once byte 1 value
6	Program Once byte 2 value
7	Program Once byte 3 value
8	Program Once byte 4 value
9	Program Once byte 5 value
A	Program Once byte 6 value
B	Program Once byte 7 value

After clearing CCIF to launch the Read Once command, an 8-byte Program Once record is read from the program flash IFR and stored in the FCCOB register. The CCIF flag is set after the Read Once operation completes. Valid record index values for the Read Once command range from 0x00 to 0x07 . During execution of the Read Once command, any attempt to read addresses within the program flash block containing this 64 -byte field returns invalid data. The Read Once command can be executed any number of times.

Table 36-52. Read Once command error handling

Error Condition	Error Bit
Command not available in current mode/security	FSTAT[ACCERR]
An invalid record index is supplied	FSTAT[ACCERR]

36.5.11.10 Program Once command

The Program Once command enables programming to a reserved 64 -byte field in the program flash IFR (see [Program flash 0 IFR map](#) and [Program Once field](#)). Access to the Program Once field is via 8 records, each 8 bytes long. The Program Once field can be read using the Read Once command (see [Read Once command](#)). Each Program Once record can be programmed only once since the program flash IFR cannot be erased.

Table 36-53. Program Once command FCCOB requirements

FCCOB Number	FCCOB Contents [7:0]
0	0x43 (PGMONCE)
1	Program Once record index (0x00 - 0x07)
2	Not Used
3	Not Used
4	Program Once Byte 0 value
5	Program Once Byte 1 value
6	Program Once Byte 2 value
7	Program Once Byte 3 value
8	Program Once Byte 4 value
9	Program Once Byte 5 value
A	Program Once Byte 6 value
B	Program Once Byte 7 value

After clearing CCIF to launch the Program Once command, the FTFC first verifies that the selected record is erased. If erased, then the selected record is programmed using the values provided. The Program Once command also verifies that the programmed values read back correctly. The CCIF flag is set after the Program Once operation has completed.

The reserved program flash IFR location accessed by the Program Once command cannot be erased and any attempt to program one of these records when the existing value is not Fs (erased) is not allowed. Valid record index values for the Program Once command range from 0x00 to 0x07 . During execution of the Program Once command, any attempt to read addresses within program flash returns invalid data.

Table 36-54. Program Once command error handling

Error Condition	Error Bit
Command not available in current mode/security	FSTAT[ACCERR]
An invalid record index is supplied	FSTAT[ACCERR]
The requested record has already been programmed to a non-erased value ¹	FSTAT[ACCERR]
Any errors have been encountered during the verify operation.	FSTAT[MGSTAT0]

1. If a Program Once record is initially programmed to 0xFFFF_FFFF_FFFF_FFFF, the Program Once command is allowed to execute again on that same record.

36.5.11.11 Erase All Blocks command

The Erase All Blocks operation erases all flash memory, initializes the FlexRAM, verifies all memory contents, and releases MCU security.

Table 36-55. Erase All Blocks command FCCOB requirements

FCCOB Number	FCCOB Contents [7:0]
0	0x44 (ERSALL)

After clearing CCIF to launch the Erase All Blocks command, the FTFC erases all program flash memory, data flash memory, data flash IFR space, emulated EEPROM backup memory, and FlexRAM, then verifies that all are erased.

If the FTFC verifies that all flash memories and the FlexRAM were properly erased, MCU security is released by setting the FSEC[SEC] field to the unsecure state and the FCNFG[RAMRDY] bit is set. The Erase All Blocks command aborts if any flash or FlexRAM region is protected. The security byte and all other contents of the flash configuration field (see [Flash configuration field description](#)) are erased by the Erase All Blocks command. If the erase-verify fails, the FSTAT[MGSTAT0] bit is set. The CCIF flag is set after the Erase All Blocks operation completes.

NOTE

For CSEc enabled parts, the presence of any (1 or more) Flash Keys will prevent this command from executing. Refer to the commands CMD_DBG_CHAL and CMD_DBG_AUTH for the procedures to pass a challenge/authentication process which will first remove the keys, then (assuming successful execution) allow this command to be executed.

Table 36-56. Erase All Blocks command error handling

Error Condition	Error Bit
Command not available in current mode/security, or CSEc key allocation being non-zero keys	FSTAT[ACCERR]
Any region of the program flash memory, data flash memory, or FlexRAM is protected	FSTAT[FPVIOL]
Any errors have been encountered during the verify operation ¹	FSTAT[MGSTAT0]

1. User margin read may be run using the Read 1s All Blocks command to verify all bits are erased.

36.5.11.11.1 Triggering an erase all external to the flash module

The functionality of the Erase All Blocks/Erase All Blocks Unsecure command is also available in an un-commanded fashion outside of the flash memory. Refer to the device's Chip Configuration details for information on this functionality.

Before invoking the external erase all function, the FCCOB0 register must not contain 0x44. When invoked, the erase-all function erases all program flash memory, data flash memory, data flash IFR space, emulated EEPROM backup, and FlexRAM regardless of the state of the FSTAT[ACCERR and FPVIOL] flags or the protection settings. If the post-erase verify passes, the routine releases security by setting the FSEC[SEC] field register to the unsecure state and the FCNFG[RAMRDY] bit sets. The security byte in the Flash Configuration Field is also programmed to the unsecure state. The status of the erase-all request is reflected in the FCNFG[ERSAREQ] bit. The FCNFG[ERSAREQ] bit is cleared once the operation completes and the normal FSTAT error reporting, except FPVIOL, is available as described in [Erase All Blocks command](#).

36.5.11.12 Verify Backdoor Access Key command

The Verify Backdoor Access Key command only executes if the mode and security conditions are satisfied (see [Flash commands by mode](#)). Execution of the Verify Backdoor Access Key command is further qualified by the FSEC[KEYEN] bits. The Verify Backdoor Access Key command releases security if user-supplied keys in the FCCOB match those stored in the Backdoor Comparison Key bytes of the Flash Configuration Field. The column labeled Flash Configuration Field offset address shows the location of the matching byte in the Flash Configuration Field.

Table 36-57. Verify Backdoor Access Key command FCCOB requirements

FCCOB Number	FCCOB Contents [7:0]	Flash Configuration Field Offset Address
0	0x45 (VFYKEY)	
1-3	Not Used	
4	Key Byte 0	0x0_0003
5	Key Byte 1	0x0_0002
6	Key Byte 2	0x0_0001
7	Key Byte 3	0x0_0000
8	Key Byte 4	0x0_0007
9	Key Byte 5	0x0_0006
A	Key Byte 6	0x0_0005
B	Key Byte 7	0x0_0004

After clearing CCIF to launch the Verify Backdoor Access Key command, the FTFC checks the FSEC[KEYEN] bits to verify that this command is enabled. If not enabled, the FTFC sets the FSTAT[ACCERR] bit and terminates. If the command is enabled, the FTFC compares the key provided in FCCOB to the backdoor comparison key in the Flash Configuration Field. If the backdoor keys match, the FSEC[SEC] field is changed to the unsecure state and security is released. If the backdoor keys do not match, security is not released and all future attempts to execute the Verify Backdoor Access Key command are immediately aborted and the FSTAT[ACCERR] bit is (again) set to 1 until a reset of the FTFC module occurs. If the entire 8-byte key is all zeros or all ones, the Verify Backdoor Access Key command fails with an access error. The CCIF flag is set after the Verify Backdoor Access Key operation completes.

Table 36-58. Verify Backdoor Access Key command error handling

Error Condition	Error Bit
Command not available in current mode/security	FSTAT[ACCERR]
The supplied key is all-0s or all-Fs	FSTAT[ACCERR]
An incorrect backdoor key is supplied	FSTAT[ACCERR]
Backdoor key access has not been enabled (see the description of the FSEC register)	FSTAT[ACCERR]
This command is launched and the backdoor key has mismatched since the last reset	FSTAT[ACCERR]

36.5.11.13 Erase All Blocks Unsecure command

The Erase All Blocks Unsecure operation erases all flash memory, initializes the FlexRAM, verifies all memory contents, programs the security byte in the Flash Configuration Field to the unsecure state, and releases MCU security.

Table 36-59. Erase All Blocks Unsecure command FCCOB requirements

FCCOB Number	FCCOB Contents [7:0]
0	0x49 (ERSALLU)

After clearing CCIF to launch the Erase All Blocks Unsecure command, the FTFC erases all program flash memory, data flash memory, data flash IFR space, emulated EEPROM backup memory, and FlexRAM, then verifies that all are erased.

If the FTFC verifies that all flash memories and the FlexRAM were properly erased, security is released by setting the FSEC[SEC] field to the unsecure state, the security byte (see [Flash configuration field description](#)) is programmed to the unsecure state by the Erase All Blocks Unsecure command, and the FCNFG[RAMRDY] bit is set. If the erase or program verify fails, the FSTAT[MGSTAT0] bit is set. The CCIF flag is set after the Erase All Blocks Unsecure operation completes.

NOTE

For CSEc enabled parts, the presence of any (1 or more) Flash Keys will prevent this command from executing. Refer to the commands `CMD_DBG_CHAL` and `CMD_DBG_AUTH` for the procedures to pass a challenge/authentication process which will first remove the keys, then (assuming successful execution) allow this command to be executed.

Table 36-60. Erase All Blocks Unsecure command error handling

Error Condition	Error Bit
Command not available in current mode/security, or key allocation being non-zero keys	FSTAT[ACCERR]
Any errors have been encountered during erase or program verify operations	FSTAT[MGSTAT0]

36.5.11.14 Program Partition command

The Program Partition command prepares the FlexNVM block for use as data flash, emulated EEPROM backup, or a combination of both and initializes the FlexRAM. The Program Partition command must not be launched from flash memory, since flash memory resources are not accessible during Program Partition command execution. Changes related to execution of the Program Partition command take effect after the next reset.

The Program Partition command is expected to be run for fresh parts before other FTFC and CSEc commands are launched.

CAUTION

While different partitions of the FlexNVM are available, the intention is that a single partition choice is used throughout the entire lifetime of a given application. The FlexNVM Partition Code choices affect the endurance and data retention characteristics of the device.

Interrupting a Program Partition operation (due to power loss, reset, supplies out of specified operational ranges, or any other reasons) can leave the partition codes in an indeterminate state. The user must take appropriate counter measures to prevent data loss in case of an interrupted Program Partition operation.

Table 36-61. Program Partition command FCCOB requirements

FCCOB Number	FCCOB Contents [7:0]
0	0x80 (PGMPART)
1	CSEc Key Size
2	SFE
3	FlexRAM load during reset option (only bit 0 used): 0 - FlexRAM loaded with valid EEPROM data during reset sequence 1 - FlexRAM not loaded during reset sequence
4	EEPROM Data Set Size Code
5	FlexNVM Partition Code

Table 36-62. CSEc/SHE key size

FCCOB1 [1:0]	Number of Flash Keys ({MASTER_ECU_KEY, BOOT_MAC_KEY, BOOT_MAC, KEY_<n>})	Number of Bytes (subtracts from the total EEERAM space)
2'b00	Zero	0
2'b01	1 to 5 keys	128 Bytes
2'b10	1 to 10 keys	256 Bytes
2'b11	1 to 20 keys	512 Bytes

For non-CSEc enabled parts, the number of Flash Keys must be configured as 2'b00 (no keys).

For CSEc enabled parts, the number of Flash Keys is user configurable, but the space will assume that the MASTER_ECU_KEY, BOOT_MAC_KEY and BOOT_MAC are there (if any keys are enabled), and thus will occupy 3 key slots of the available 20 key slot space. This results in leaving key slots for a range of 1 to 17 User Key_<n> keys.

For non-CSEc enabled parts the key allocation must be set to Zero keys (2'b00), otherwise the command will return an error.

NOTE

For CSEc enabled parts, once Flash Keys are allocated (regardless of being initialized or not), the SHE spec requirement of not erasing Flash Keys without authentication will apply. This will mean Authentication (DBG_CHAL & DBG_AUTH) commands must be run and pass (removing all flash keys) before erase of the DFlash (all Flash Keys are backed up in emulated EEPROM in DFlash). Thus Erase All Blocks and Erase All Blocks Unsecure will not work, nor will Erase Flash Block or Sector IF the selected Block/Sector

Functional description

includes the DFlash where the keys are stored. Additionally if any Flash Keys are write protected, they can't be erased/removed, thus the DFlash can't be erased and the Authentication process will not pass.

Table 36-63. Security Flag Extension (SFE)

SFE	Results
SFE == 0x01	Flash Key 'Verify Only' attribute enabled
SFE == 0x00	Flash Key 'Verify Only' attribute not enabled

The FCCOB[2] field is for the enhanced Security Flag Extension (SFE) is in a 8-bit field, but only bit [0] is used (bits [7:1] are ignored). This feature is an extension to the SHE specification. For standard SHE usage model, the user should configure this as 'not enabled' (SFE == 0x00). This addition is to add capability to flag a key as 'VERIFY_ONLY'. That is, the user can configure SFE == 0x01 and then use the LOAD_KEY command to add a new attribute to the key which would tell the GENERATE_MAC command that the key is to be used only by the VERIFY_MAC command (by configuring SFE as 'enabled' and then using LOAD_KEY to set the new VERIFY_ONLY attribute on that key).

The VERIFY_ONLY attribute has no effect if the KEY_USAGE attribute is '0'.

See the CMD_LOAD_KEY command for more information on the new attribute.

Table 36-64. Valid emulated EEPROM data set size codes : 2 KB FlexRAM configurations

EEPROM Data Set Size Code (FCCOB4) ¹	EEPROM Data Set Size (Bytes)
EEESIZE (FCCOB4[3:0])	
0xF	0 ²
0x3	2k

1. FCCOB4[7:4] = 0000

2. EEPROM Data Set Size must be set to 0 Bytes when the FlexNVM Partition Code is set for no EEPROM.

Table 36-65. Valid emulated EEPROM data set size codes : 4 KB FlexRAM configurations

EEPROM Data Set Size Code (FCCOB4) ¹	EEPROM Data Set Size (Bytes)
EEESIZE (FCCOB4[3:0])	
0xF	0 ²
0x2	4k

1. FCCOB4[7:4] = 0000

2. EEPROM Data Set Size must be set to 0 Bytes when the FlexNVM Partition Code is set for no EEPROM.

Table 36-66. Valid FlexNVM partition codes : 128 KB and 256 KB configurations with 32 KB FlexNVM

FlexNVM Partition Code DEPART (FCCOB5[3:0]) ¹	Data flash Size (KB)	EEPROM-backup Size (KB)
0000	32	0
0011	0	32
1000	0	32
1001	8	24
1011	32	0

1. FCCOB5[7:4] = 0000

Table 36-67. Valid FlexNVM partition codes : 256 KB, 512 KB and 1MB configurations with 64 KB FlexNVM

FlexNVM Partition Code DEPART (FCCOB5[3:0]) ¹	Data flash Size (KB)	EEPROM-backup Size (KB)
0000	64	0
0011	32	32
0100	0	64
1000	0	64
1010	16	48
1011	32	32
1100	64	0

1. FCCOB5[7:4] = 0000

NOTE

For the 2M configuration (where DFlash is implemented in multiple blocks) the FlexNVM may only be configured into: all Data flash, or 64 KB emulated EEPROM backup with the remainder left as Data Flash. Thus there are only three valid values for DEPART (FCCOB5[3:0]) : either 4'b0100 (64 KB emulated EEPROM, remainder is DFlash) or 4'b0000, 4'b1111 (0 KB emulated EEPROM/all DFlash).

Table 36-68. Valid FlexNVM partition codes: 2 MB configurations

FlexNVM Partition Code DEPART (FCCOB5[3:0]) ¹	Data flash Size (KB)	EEPROM-backup Size (KB)
0000	DFlash size (512 KB)	0
0100	DFlash size - EEPROM size (512 KB - 64 KB = 448 KB)	64
1111	DFlash size (512 KB)	0

1. FCCOB5[7:4] = 0000

Functional description

After clearing CCIF to launch the Program Partition command, the FTFC first verifies that the EEPROM Data Set Size Code and FlexNVM Partition Code in the data flash IFR are erased. If erased, the Program Partition command erases the contents of the FlexNVM memory. If the FlexNVM is to be partitioned for emulated EEPROM backup, the allocated emulated EEPROM backup sectors are formatted for emulated EEPROM use. Finally, the partition codes are programmed into the data flash IFR using the values provided. The Program Partition command also verifies that the partition codes read back correctly after programming. The CCIF flag is set after the Program Partition operation completes.

Prior to launching the Program Partition command, the data flash IFR must be in an erased state, which can be accomplished by executing the Erase All Blocks or Erase All Blocks Unsecure commands or by an external request (see [Triggering an erase all external to the flash module](#)).

Table 36-69. Program Partition command error handling

Error Condition	Error Bit
Command not available in current mode/security	FSTAT[ACCERR]
The EEPROM data size and FlexNVM partition code bytes are not initially 0xFFFF	FSTAT[ACCERR]
Invalid EEPROM Data Set Size Code is entered (see Table 36-65 for valid codes)	FSTAT[ACCERR]
Invalid FlexNVM Partition Code is entered (see Table 36-66 for valid codes)	FSTAT[ACCERR]
FlexNVM Partition Code = full data flash (no emulated EEPROM) and EEPROM Data Set Size Code allocates FlexRAM for emulated EEPROM	FSTAT[ACCERR]
FlexNVM Partition Code allocates space for emulated EEPROM backup, but EEPROM Data Set Size Code allocates no FlexRAM for emulated EEPROM	FSTAT[ACCERR]
FCCOB1[7:0] > 0x3	FSTAT[ACCERR]
FCCOB1[7:0] > 0 for non-CSEc enabled parts	FSTAT[ACCERR]
FCCOB1[7:0] > 0, when EEPROM-backup Size is 0	FSTAT[ACCERR]
FCCOB1[7:0] > 0, when SFE = 1	FSTAT[ACCERR]
FCCOB1[7:0] > 0, when FCCOB3[0] = 1	FSTAT[ACCERR]
FCCOB4[7:4] != 0000	FSTAT[ACCERR]
FCCOB5[7:4] != 0000	FSTAT[ACCERR]
Any errors have been encountered during the verify operation	FSTAT[MGSTAT0]

36.5.11.15 Set FlexRAM Function command

The Set FlexRAM Function command changes the function of the FlexRAM:

- When not partitioned for emulated EEPROM, the FlexRAM is typically used as traditional RAM.
- When partitioned for emulated EEPROM, the FlexRAM is typically used to store EEPROM data.

Table 36-70. Set FlexRAM Function command FCCOB requirements

FCCOB Number	FCCOB Contents [7:0]
0	0x81 (SETRAM)
1	FlexRAM Function Control Code (see Table 36-71)
2	Reserved
3	Reserved
4	Number of FlexRAM bytes allocated for EEPROM quick writes [15:8]
5	Number of FlexRAM bytes allocated for EEPROM quick writes [7:0]
Returned Values	
5	Brown-out (BO) Detection Codes <ul style="list-style-type: none"> • 0x00 - No EEPROM issues detected • 0x01 - BO detected before completing EEPROM quick write maintenance • 0x02 - BO detected before completing EEPROM quick writes • 0x04 - BO detected during normal EEPROM write activity
6	Number of EEPROM quick write records requiring maintenance [15:8]
7	Number of EEPROM quick write records requiring maintenance [7:0]
8	EEPROM sector erase count [15:8]
9	EEPROM sector erase count [7:0]

Table 36-71. FlexRAM Function control

FlexRAM Function Control Code	Action
0xFF	Make FlexRAM available as RAM: <ul style="list-style-type: none"> • Clear the FCNFG[RAMRDY] and FCNFG[EEERDY] flags • Write a background of ones to all FlexRAM locations • Set the FCNFG[RAMRDY] flag
0xAA	Complete interrupted EEPROM quick write process <ul style="list-style-type: none"> • Clear the FCNFG.EEERDY flag (and FCNFG.RAMRDY flag) • Complete maintenance on interrupted EEPROM quick write operations • Set the FCNFG.EEERDY flag
0x77	EEPROM quick write status query <ul style="list-style-type: none"> • Clear the FCNFG.EEERDY flag (and FCNFG.RAMRDY flag) • Report emulated EEPROM status • Set the FCNFG.EEERDY flag
0x55	Make FlexRAM available for EEPROM quick writes <ul style="list-style-type: none"> • Clear the FCNFG.EEERDY flash (and FCNFG.RAMRDY flag) • Enable the emulated EEPROM system for EEPROM quick writes • Set the FCNFG.EEERDY flag
0x00	Make FlexRAM available for emulated EEPROM: <ul style="list-style-type: none"> • Clear the FCNFG[RAMRDY] and FCNFG[EEERDY] flags • Write a background of ones to all FlexRAM locations • Copy-down existing EEPROM data to FlexRAM • Set the FCNFG[EEERDY] flag

After clearing CCIF to launch the Set FlexRAM Function command, the FTFC sets the function of the FlexRAM based on the FlexRAM Function Control Code.

When making the FlexRAM available as traditional RAM, the FTFC clears the FCNFG[EEERDY] and FCNFG[RAMRDY] flags, overwrites the contents of the entire FlexRAM with a background pattern of all ones, and sets the FCNFG[RAMRDY] flag. The state of the EPROT register does not prevent the FlexRAM from being overwritten. When the FlexRAM is set to function as a RAM, normal read and write accesses to the FlexRAM are available. When large sections of flash memory need to be programmed, e.g. during factory programming, the FlexRAM can be used as the Section Program Buffer for the Program Section command (see [Program Section command](#)).

When the FlexRAM Function Control Code is 0x55 or 0xAA, after clearing the EEERDY flag, all EEPROM normal or quick write activity not previously completed will be processed. If the EEPROM quick write activity did not complete writing all requested records, the records written will be cleared, effectively restoring previously valid records. If all EEPROM quick write records were written but maintenance activities were not completed, maintenance will complete on the remaining quick write records. The CCIF and EEERDY flag will remain negated until all EEPROM maintenance activities have been completed.

When the FlexRAM Function Control Code is 0x77, after clearing the EEERDY flag, the emulated EEPROM system will be interrogated, and EEPROM cleanup requirements and EEPROM sector erase count will be reported. If EEPROM normal write activity is interrupted by a reset or loss of power before finalizing the record, BO detection code 0x04 will be returned. If the EEPROM quick write activity is interrupted by a reset before writing all quick write records requested with control code 0x55, BO detection code 0x02 will be returned. If the interruption occurs after all quick writes requested have been written but before quick write maintenance has completed, BO detection code 0x01 will be returned. The CCIF and EEERDY flag will remain negated until the EEPROM status has been loaded into the FCCOB registers.

When making the FlexRAM available for EEPROM quick writes, the contents of the FlexRAM will be left as is and the emulated EEPROM system will be prepared for quick write activities. After the EEERDY flag in the FCNFG register is set, the emulated EEPROM system is ready for quick writes. When the FlexRAM is set to accept the EEPROM quick writes, read and write access to the FlexRAM is available but each 32-bit write to the FlexRAM will invoke EEPROM quick write activity. The CCIF and EEERDY flag will deassert on each 32-bit write and assert after the associated EEPROM quick write activity has completed. After the last 32-bit write to the FlexRAM, specified by the contents of FCCOB4 and FCCOB5, the emulated EEPROM system will create the data record for the last write (~150uSec) and begin the EEPROM maintenance activities on the entire block of quick write data. The CCIF and EEERDY flag will remain negated until all EEPROM quick write maintenance activities have completed.

For configurations with interleaved flash blocks for EEPROM backup, quick writes should be restricted to either within the first half of EEERAM or within the second half of EEERAM. Otherwise, FSTAT[ACCERR] will be returned.

Once a quick write is started, user must finish the entire quick write activity prior to starting another FTFC or CSE command.

When making the FlexRAM available for emulated EEPROM, the FTFC clears the FCNFG[RAMRDY] and FCNFG[EEERDY] flags, overwrites the contents of the FlexRAM allocated for emulated EEPROM with a background pattern of all ones, and copies the existing EEPROM data from the EEPROM backup record space to the FlexRAM. After completion of the EEPROM copy-down, the FCNFG[EEERDY] flag is set. When the FlexRAM is set to function as emulated EEPROM, normal read and write access to the FlexRAM is available, but writes to the FlexRAM also invoke emulated EEPROM activity.

The CCIF flag will be set after the Set FlexRAM Function operation has completed.

Table 36-72. Set FlexRAM Function command error handling

Error Condition	Error Bit
Command not available in current mode/security	FSTAT[ACCERR]
FlexRAM Function Control Code is not defined	FSTAT[ACCERR]
FlexRAM Function Control Code is set to make the FlexRAM available for emulated EEPROM, but FlexNVM is not partitioned for emulated EEPROM	FSTAT[ACCERR]
Set if FlexRAM Function Control Code is set to 0xAA, 0x77 or 0x55 but FCNFG.[EEERDY] =0 (FlexRAM not in emulated EEPROM mode)	FSTAT[ACCERR]
Set if FlexRAM is in EEPROM quick write mode, i.e. all EEPROM quick writes to the FlexRAM have not been completed	FSTAT[ACCERR]
Set if FlexRAM Function Control Code is set to make FlexRAM available for EEPROM quick writes but the number of bytes allocated for quick write is less than 16, more than 512, or not divisible by 4 (only 32-bit quick writes are allowed)	FSTAT[ACCERR]
Set if emulated EEPROM system is in quick write mode and writes to the FlexRAM are not 32-bits	FSTAT[ACCERR]

36.5.12 Security

The FTFC module provides security information to the MCU based on contents of the FSEC security register. The MCU then limits access to FTFC resources as defined in the device's Chip Configuration details. During reset, the FTFC module initializes the FSEC register using data read from the security byte of the Flash Configuration Field (see [Flash configuration field description](#)).

Functional description

The following fields are available in the FSEC register. Details of the settings are described in the FSEC register description.

Table 36-73. FSEC fields

FSEC field	Description
KEYEN	Backdoor Key Access
MEEN	Mass Erase Capability
FSLACC	Factory Access
SEC	MCU security

36.5.12.1 FTFC access by mode and security

The following table summarizes how access to the FTFC module is affected by security and operating mode.

Table 36-74. FTFC access summary

Operating Mode	MCU Security State	
	Unsecure	Secure
NVM Normal	Full command set	

36.5.12.2 Changing the security state

The security state out of reset can be permanently changed by programming the security byte of the flash configuration field. This assumes that you are starting from a mode where the necessary program flash erase and program commands are available and that the region of the program flash containing the flash configuration field is unprotected. If the flash security byte is successfully programmed, its new value takes effect after the next MCU reset.

36.5.12.2.1 Un-securing the MCU using backdoor key access

The MCU can be unsecured by using the backdoor key access feature which requires knowledge of the contents of the 8-byte backdoor key value stored in the Flash Configuration Field (see [Flash configuration field description](#)). If the FSEC[KEYEN] bits are in the enabled state, the Verify Backdoor Access Key command (see [Verify Backdoor Access Key command](#)) can be run which allows the user to present prospective keys for comparison to the stored keys. If the keys match, the FSEC[SEC] bits are changed to unsecure the MCU. The entire 8-byte key cannot be all 0s or all 1s, i.e.,

0x0000_0000_0000_0000 and 0xFFFF_FFFF_FFFF_FFFF are not accepted by the Verify Backdoor Access Key command as valid comparison values. While the Verify Backdoor Access Key command is active, program flash memory is not available for read access and returns invalid data.

The user code stored in the program flash memory must have a method of receiving the backdoor keys from an external stimulus. This external stimulus would typically be through one of the on-chip serial ports.

If the KEYEN bits are in the enabled state, the MCU can be unsecured by the backdoor key access sequence described below:

1. Follow the command sequence for the Verify Backdoor Access Key command as explained in [Verify Backdoor Access Key command](#)
2. If the Verify Backdoor Access Key command is successful, the MCU is unsecured and the FSEC[SEC] bits are forced to the unsecure state

An illegal key provided to the Verify Backdoor Access Key command prohibits future use of the Verify Backdoor Access Key command. A reset of the MCU is the only method to re-enable the Verify Backdoor Access Key command when a comparison fails.

After the backdoor keys have been correctly matched, the MCU is unsecured by changing the FSEC[SEC] bits. A successful execution of the Verify Backdoor Access Key command changes the security in the FSEC register only. It does not alter the security byte or the keys stored in the Flash Configuration Field ([Flash configuration field description](#)). After the next reset of the MCU, the security state of the FTFC module reverts back to the Flash security byte in the Flash Configuration Field. The Verify Backdoor Access Key command sequence has no effect on the program and erase protections defined in the program flash protection registers.

If the backdoor keys successfully match, the unsecured MCU has full control of the contents of the Flash Configuration Field. The MCU may erase the sector containing the Flash Configuration Field and reprogram the flash security byte to the unsecure state and change the backdoor keys to any desired value.

36.5.13 Cryptographic Services Engine (CSEc)

The FTFC module has added features to comply with the SHE⁹ specification. It is assumed that the user is familiar with the SHE specification, therefore we do not replicate the document here.

9. HIS SHE Specification - Secure Hardware Extension Functional Specification; Version 1.0.1; Rev429 from 23.03.2009

By using an embedded processor, firmware and hardware assisted AES-128 sub-block, the FTFC macro enables encryption, decryption and message generation and authentication algorithms for secure messaging applications. Additionally a TRNG and Miyaguchi-Prenell compression sub-blocks enables true random number generation (entropy generator for PRNG in AES sub-block).

To access the command feature set, the part must be configured for EEE operation, using the PGMPART command. See more in [Program Partition command](#). By enabling security features and configuring a number of CSEc keys, the total size of the EEERAM will be reduced by the space required to store the keys. The key space will then be un-addressable space in the EEERAM.

The CCOB command set is effectively extended to include SHE commands related to ECB, CBC and CMAC features. Secure storage of security keys is enabled within the FTFC module, including up to 17 user keys (MASTER_ECU_KEY, BOOT_MAC_KEY, BOOT_MAC are assumed to be allocated). These commands are referred to as the CSEc command set. The CSEc command set requires input data and command to be entered as described in [User CSEc command interface and command set](#).

NOTE

1. It is not possible to concurrently execute : EEE operations, CCOB commands related to Program, Erase (or other standard FTFC flash commands), CSEc commands. Only one operation (of any type) may be ongoing at any given time.
2. Execution of a CSEc command while in Erase Suspend (ERSSUSP) will result in the Suspended Erase operation being aborted (not able to be resumed, also Aborted Erase commands will leave the contents in an indeterminate state).
3. It is also not possible to execute a different CSEc command in the middle of a continuation of an ongoing CSEc command.
4. It is possible to execute a FCCOB command in the middle of a continuation of an ongoing CSEc command, BUT the result is the existing CSEc command will be canceled.
5. Starting execution of CCOB commands or CSEc commands will lock out the CCOB interface, the EEERAM and the PRAM. The lock is in place until the requested command completes.

CAUTION

Interrupting a CSEc key update operation (due to power loss, reset, supplies out of specified operational ranges, or any other reasons) will leave the contents in an indeterminate state. The user must take appropriate counter measures to prevent data loss in case of an interrupted CSEc key update operation.

For security reasons some features will be disabled upon any type of debugger (JTAG, DP, SDB, etc.) connection to the SoC, per SHE specification requirements according to user configurations.

All message data blocks are to be provided as 128-bit blocks. Minimum block size of one. If data messages contain less than 128-bits, the message must be padded (according to SHE spec) to the required 128-bit block size before passing data to the FTFC module.

Internal to the FTFC module are stored the required Secret Key and the Unique ID. Both in unaddressable and unalterable space, and are programmed in Factory Final Test. Also supported are the CSEc Keys as described. The flash keys are stored in the EEERAM space, with a configurable amount of space for flash keys. The space is subtracted from the end address range of the EEERAM. Anywhere from 1 to 20 (17 user keys) flash keys may be configured as described in the Non-Volatile Key table. With the assumption that the first three keys are occupied by MASTER_ECU_KEY, BOOT_MAC_KEY and BOOT_MAC. Leaving anywhere from 1 to 17 KEY_<n> keys to be configured.

Table 36-75. Non-Volatile keys and RAM_KEY

Key Name	{KBS, KeyIDx}		Type	Size (Bytes)	Comments
SECRET_KEY	X	0x0	ROM	16	
UID	X	0x0	ROM	15	
MASTER_ECU_KEY	X	0x1	Flash	16	
BOOT_MAC_KEY	X	0x2	Flash	16	
BOOT_MAC	X	0x3	Flash	16	
KEY_01 - KEY_10	1'b0	0x4 - 0xD	Flash	16	minimum 3 user keys - max 17
KEY_11 - KEY_17	1'b1	0x4 - 0xA	Flash	16	
RESERVED	1'b1	0xB - 0xE	RESERVED	16	
RESERVED	1'b0	0xE	RESERVED	16	
RAM_KEY	X	0xF	Volatile (RAM_KEY)	16	

Table 36-76. Other volatile keys

Key Name	ADDRESS	Type	Size (Bytes)	Comments
PRNG_KEY	N/A	RAM	16	
PRNG_STATE	N/A	RAM	16	

Table 36-77. ROM keys

Key Name	ADDRESS	Type	Size (Bytes)	Comments
SECRET_KEY	N/A	ROM	16	
UID	N/A	ROM	15	accessible via the GET_ID command

36.5.13.1 Key/seed/random number generation

This is the high level flow in which to initialize and generate random numbers.

1. Run CMD_INIT_RNG to initialize a random seed from the internal TRNG

NOTE

- a. CMD_INIT_RNG must be run after every POR, and before the first execution of CMD_RND
- b. If the seed is run through compression before the seed is used in the PRNG, then CSESTAT[RIN] will be set
- c. Note that if the next step (run CMD_RND) is run without initializing the seed, an error (ERC_RNG_SEED) will be set.

2. Run CMD_RND to generate a random number

The PRNG uses the PRNG_STATE/KEY and Seed per SHE spec and the AIS20 standard as follows:

- $PRNG_STATE_i = ENC_{ECB, PRNG_KEY}(PRNG_STATE_{i-1})$
- $RND = PRNG_STATE_i$

3. For additional random numbers the user may continue executing CMD_RND unless a POR event occurred. Each time a POR occurs, the CMD_INT_RND command must first be run before attempting to regenerate new random numbers

36.5.13.2 Secure boot mode

Three user selectable boot modes (as described in the SHE specification) are supported. The boot modes are configured in the command 'CMD_BOOT_DEFINE'

- Sequential Boot Mode
 - a. Flash system comes out of RESET and main Core stays in RESET, or may execute from ROM code
 - b. FTFC verifies customer firmware block (via CMAC calculation)

- c. Depending on the verification (CMAC verify pass/fail) FTFC and security keys will be available for security tasks or not (per pass/fail results and individual key attributes)
- d. Main Core comes out of reset and starts execution of customer firmware
- Strict Sequential Boot Mode
 - a. Flash system comes out of RESET and main Core stays in RESET, or may execute from ROM
 - b. FTFC verifies customer firmware block (via CMAC calculation)
 - c. Depending on the firmware verification result (CMAC verify pass/fail) FTFC and security keys are available for security tasks or not (per pass/fail results and individual key attributes)
 - d. If the MAC compare fails, then the Main Core stays in RESET (no customer code is executed), or may execute ROM code.

NOTE

1. The correct BOOT_MAC must be stored before selecting 'Strict' secure boot mode. Otherwise the boot check will fail and the part will be stuck in reset.
2. If any key is write protected then DBG_CHALLENGE/AUTH will not pass due to the write protected key blocking erase of all keys. This also results in negating the capability of Failure Analysis return is ever applicable. Care must be taken if write protecting any keys is to be used in the application.

- Parallel Boot Mode
 - a. FTFC system and Main Core come out of RESET.
 - b. Main Core starts execution of customer firmware
 - c. In parallel to Main Core code execution, the FTFC module verifies customer block of firmware
 - d. Depending on the result of firmware verification (CMAC pass/fail), FTFC and security keys are available for security related tasks or not (per pass/fail result and individual key attributes).

Non-volatile keys may be disabled (each key has an attribute to decide the response for that key) when secure boot detects manipulation of software or the secure boot process. Boot failure sensitive memory slots will only be re-activated on the next successful boot. Additionally, non-volatile keys may be disabled (again, each key has an attribute to dictate this behavior) when a debugger is attached (JTAG, BDM, etc.), and will only be re-activated upon the next successful boot.

36.5.13.3 User CSEc command interface and command set

The following sections will describe the SHE compliant commands implemented in the CSEc command set, The command interface, data structure and protocol related to all operations.

The commands follow a similar protocol to the CCOB commands in that once a command has started the CCOB interface will be locked and no further commands may be initiated until completion of the ongoing command.

This results in one SHE command (CMD_CANCEL) not being implemented in the CSE command feature set of this module. Also, the CMD_STATUS isn't strictly supported as we may not interrupt an ongoing command. But the intent of the CMD_STATUS command is met by a user accessible status (FCSESTAT) register

All cryptographic functions are processed by an AES-128 engine. Encryption and decryption of data are supported by Electronic Cipher Book (ECB) mode for single blocks (128-bits) of data, and by Cipher Block Chaining (CBC) mode for Integer Multiples of 128-bit block sized data.

Cipher-based Message Authentication Code (CMAC) generation and verification is also supported by the AES-128 engine, in addition with use of Miyaguchi-Prenell compression function.

Usage of (most of) the CSEc command set is constructed by writing the data (plain text or cipher text) to the CSE_PRAM followed by writing the command word to the CSE_PRAM at address offsets as specified below. The act of writing the 'Command Header' word to the CSE_PRAM will trigger the CCOB interface to be locked down and the command operation execution to start.

NOTE

1. The usage model requires writing the CSE_PRAM data contents BEFORE writing the command header contents.
Write the Command Header LAST!
2. Writes to any Byte (bytes 0-3) in the Command Header will lock out the interface.
3. In general, commands that start with Byte[1] of the Command Header (continue) but is the first call to that command, will result in a Sequence Error (ERC_SEQUENCE_ERROR).
4. For continued commands (Command Header Byte[1] =0x01) will ignore any data changes in Byte[2] (data type), Byte[0] (key slot) and any MAC_LENGTH,

MESSAGE_LENGTH, PAGE_LENGTH, as these are only captured on the first command execution.

Execution of CSEc commands can be thought of as transferring blocks of system memory contents into CSE_PRAM space for command execution, then transferring CSE_PRAM space contents back into system memory for use. Each transfer will consist of data in the form of a number of 'n' 128-bit blocks followed by the command header. The number 'n' may vary from none to 7, as there is space allocated in CSE_PRAM for up to 7, 128-bit blocks of data. Additionally, 128-bits for the command header and associated parameters (like message length) for the command. The format is graphically shown in each of the command descriptions below.

The SHE specification lists a set of error codes and which error condition may apply to which key.

Below is the overall general priority order in which the error codes are implemented in this macro (highest priority to lowest). Additionally there is a rough list of examples that may be the source of the error (Note that the list of examples is not exhaustive). Please refer to each command to see which particular ERC_* codes apply to it:

- ERC_GENERAL_ERROR. Example: FuncID is not valid
- ERC_SEQUENCE_ERROR. Example: CalSeq invalid: continuation a command error - changed command type
- ERC_GENERAL_ERROR. Example: Message Length is ==0
- ERC_KEY_INVALID. Example: key slot doesn't qualify per key map to command; KeyID[7:5] are set; kBS==0 & KeyIDx==0xE
- ERC_KEY_NOT_AVAILABLE. Example: key has DBG Attached flag and debugger is active
- ERC_KEY_EMPTY. Example: key slot is empty (not initialized)/not present or higher slot (not partitioned) than partitioned; For RAM_KEY if plain attribute is set
- ERC_NO_SECURE_BOOT. N/A for FTFC - BOOT_DEFINE once configured, will automatically run secure boot
- ERC_KEY_WRITE_PROTECTED. Example : update a write protected key slot, or activate debugger with write protected key(s)
- ERC_KEY_UPDATE_ERROR. Example: key update authentication failed; for LOAD_KEY : M3 != M3* or UID is empty and AuthID isn't the same key slot
- ERC_RNG_SEED. Example: didn't initialize the seed using the TRNG, i.e., CSESTAT[RIN] != 1
- ERC_NO_DEBUGGING. Example: DEBUG command authentication failed
- ERC_BUSY. N/A for FTFC
- ERC_MEMORY_FAILURE. Example: general memory technology failure (multi-bit ECC error, common fault detected)

Functional description

- **ERC_GENERAL_ERROR**. Example: general catch all for error not defined above; also for 'pointer method **GENERATE_MAC** if the message length would cause the sequence to cross a read partition boundary (maximum CMAC can be calculated on 512KB program flash block)
- **ERC_NO_ERROR**. Example: No error - command will execute

36.5.13.3.1 CSEc command header

Each command may have varying amounts of data associated with it, but each command has a standard command header. The command word header is as follows:

Figure 36-16. CSEc command header

Bytes					
3	2	1	0	7	6
Command Word				Error Bits	
FuncID	Func Format	CallSeq	KeyID		

The **FuncID** (Function ID) is 8-bits long. Valid values range from 0x01 to 0x16. These are the CSEc commands.

The **FuncFormat** (Function Format) specifies how the data is transferred to/from the CSEc. There are two use cases. One (most common) is a copy all data and the command function call method and the other is a pointer and function call method. In the 'copy' method, the main core or DMA will first copy the data and then the function call into the CSE_PRAM. For the 'pointer' case (for the two CSEc MAC commands), the main core or DMA will provide the pointer information followed by the command function call.

Copy method : 0x00

Pointer method : 0x01

The **CallSeq** (Call Sequence) specifies if the information is the first or a following function call. The use case is to provide ongoing data in cases where the full data set can not be provided to CSE_PRAM space along with one command function call. For example a CMAC Verify of a set of 128-bit blocks where there are more than seven 128-bit blocks.

0x00 : 1st Function Call

0x01 : 2nd through nth Function Call

The **KeyID** is divided into two parts. the KeyIDx which is a 4-bit value representing the SHE specification key index. Then the KBS (Key Block Select - not used in all commands) which is a 1-bit value allowing the customer to switch between key banks. KEY_ID=KeyID[4:0]={KBS, KeyIDx[3:0]}.

NOTE

KeyIDx is a 4-bit value. Writing 1's to the upper 4-bits may result in addressing the incorrect key index/slot.

Finally the command header also contains 16-bits of Error information.

Command Header

(Bytes: as shown in table above)

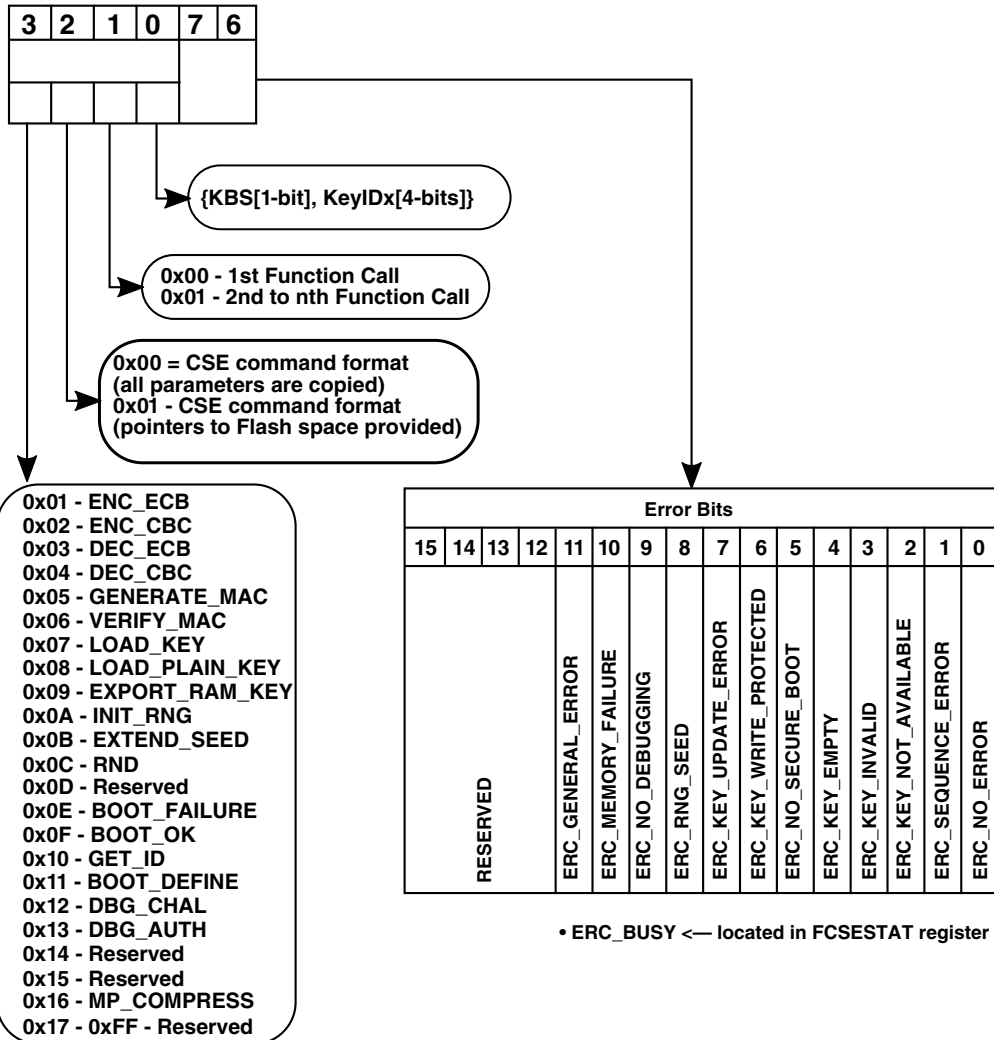

• ERC_BUSY ← located in FCSESTAT register

36.5.13.4 Generic PRAM interface description

The PRAM interface can be thought of a 128-bit wide SRAM with eight 128-bit pages. The diagrams are shown in Little Endian for byte ordering. The first ‘page’ always starts with the command header and this must be the last data written in a sequence of data written to the PRAM. This is because writing to the command header (any write to any of the bytes 0-3) triggers the macro to lock the PRAM interface so CSEc operation may start.

Figure 36-17. Generic PRAM interface

Bits	[127:0]															
Bits	31:2 4	23:1 7	15:8	7:0	31:2 4	23:1 7	15:8	7:0	31:2 4	23:1 7	15:8	7:0	31:2 4	23:1 7	15:8	7:0
WD	Word 0				Word 1				Word 2				Word 3			
Page	Byte															
	3	2	1	0	7	6	5	4	B	A	9	8	F	E	D	C
0	Func D	Func Form at	CallS eq	KeyID	Error Bits			Command Specific								
1	Data Input to CSEc OR Data Output from CSEc															
2																
3																
4																
5																
6																
7																

To setup a CSEc command, the user should first enter the data as required, in 128-bit blocks, as many blocks as desired (within the seven pages allowed at one given time). Followed by any associated control information such as ‘MESSAGE_LENGTH’. Followed by the last write which is to the command word.

The operation will start as indicated by CCIF transitioning from 1 to 0. The operation will complete and set CCIF to 1 again. At this point the user may read the PRAM to verify or transfer results as applicable.

If the same command is to be continued, the user should write the remaining data in as applicable, followed by updated Command Header information (same command but Byte 1 changed to indicate this is a continuation of the same command). For continuation of any command, the KeyID, FuncFormat, MAC_LENGTH, PAGE_LENGTH and MESSAGE_LENGTH are only captured on the first command written.

NOTE

1. If while continuing a command with a change in the FuncID field, a sequence error will occur. The FuncID field must stay consistent throughout the continuation of a command.
2. A general statement about all MAC and ENC/DEC commands:

Per SHE specification, the User/Application must manage any potential padding (blocks of bit length less than the 128-bit block length) for all ENC/DEC commands. While the CSEc module will manage all potential padding for the MAC commands.

36.5.13.5 CMD_ENC_ECB

The Encrypt ECB command operates on a single 128-bit block of data. The function encrypts a given PLAIN_TEXT (128-bits) with the key identified by the KEY_ID (5-bits), and returns CIPHER_TEXT (128-bits). The 'PAGE_LENGTH' is used to tell the operation how many 128-bit pages are to be processed. All data must be presented in 128-bit blocks (all padding must be done by the application). This command may also be extended by setting the CallSeq field to 0x01 for continued pages of data.

Table 36-78. Encrypt ECB command details

Parameter	Direction	Width
KEY_ID	IN	5
PAGE_LENGTH	IN	16
PLAIN_TEXT	IN	n * 128
CIPHER_TEXT	OUT	n * 128
CIPHER_TEXT = ENC _{ECB,KEY, KEY_ID} (PLAIN_TEXT)		
Error Codes: ERC_NO_ERROR, ERC_SEQUENCE_ERROR, ERC_KEY_NOT_AVAILABLE, ERC_KEY_INVALID,ERC_KEY_EMPTY, ERC_MEMORY_FAILURE, ERC_BUSY, ERC_GENERAL_ERROR		

CSEc Command and Data Structure for CSE_PRAM content writes/reads is as follows:

Figure 36-18. Encrypt ECB input parameter format

	3	2	1	0	7	6	5	4	B	A	9	8	F	E	D	C
0	0x01	0x00	0x00	KeyID	Error Bits		Reserved								PAGE_LENGTH	
1	PLAIN_TEXT 1															
2	PLAIN_TEXT 2															

Table continues on the next page...

Functional description

	3	2	1	0	7	6	5	4	B	A	9	8	F	E	D	C
3	PLAIN_TEXT 3															
4	PLAIN_TEXT 4															
5	PLAIN_TEXT 5															
6	PLAIN_TEXT 6															
7	PLAIN_TEXT 7															

Figure 36-19. Encrypt ECB output parameter format

	3	2	1	0	7	6	5	4	B	A	9	8	F	E	D	C
0	0x01	0x00	0x00	KeyID	Error Bits	Reserved										
1	CIPHER_TEXT 1															
2	CIPHER_TEXT 2															
3	CIPHER_TEXT 3															
4	CIPHER_TEXT 4															
5	CIPHER_TEXT 5															
6	CIPHER_TEXT 6															
7	CIPHER_TEXT 7															

36.5.13.6 CMD_ENC_CBC

The Encrypt CBC command operates on multiple 128-bit blocks of data. The function encrypts a number of PLAIN_TEXT (128-bits) blocks with the key identified by the KEY_ID (5-bits) and Initialization vector (IV), then returns CIPHER_TEXT (128-bits) blocks for each input block.

All data presented must be in 128-bit blocks (any padding must be done by the application).

Table 36-79. Encrypt CBC command details

Parameter	Direction	Width
KEY_ID	IN	5
PAGE_LENGTH	IN	16
IV	IN	128
PLAIN_TEXT	IN	n * 128
CIPHER_TEXT	OUT	n * 128
CIPHER_TEXT = ENC _{CBC,KEY, KEY_ID,IV} (PLAIN_TEXT)		
Error Codes: ERC_NO_ERROR, ERC_SEQUENCE_ERROR, ERC_KEY_NOT_AVAILABLE, ERC_KEY_INVALID, ERC_KEY_EMPTY, ERC_MEMORY_FAILURE, ERC_BUSY, ERC_GENERAL_ERROR		

Figure 36-20. Encrypt CBC input parameter format

	3	2	1	0	7	6	5	4	B	A	9	8	F	E	D	C
0	0x02	0x00	0x00	KeyID	Error Bits	Reserved										PAGE_LENGTH
1	IV															
2	PLAIN_TEXT 1															
3	PLAIN_TEXT 2															
4	PLAIN_TEXT 3															
5	PLAIN_TEXT 4															
6	PLAIN_TEXT 5															
7	PLAIN_TEXT 6															

Figure 36-21. Encrypt CBC output parameter format

	3	2	1	0	7	6	5	4	B	A	9	8	F	E	D	C
0	0x02	0x00	0x00	KeyID	Error Bits	Reserved										
1	IV															
2	CIPHER_TEXT 1															
3	CIPHER_TEXT 2															
4	CIPHER_TEXT 3															
5	CIPHER_TEXT 4															
6	CIPHER_TEXT 5															
7	CIPHER_TEXT 6															

Subsequent pages of information are provided, with the Byte 1 field of the CSEc Command Header indicating an ongoing operation is to be continued (i.e., change the CallSeq field from 0x00 to 0x01).

Figure 36-22. Continuation of input parameters

	3	2	1	0	7	6	5	4	B	A	9	8	F	E	D	C
0	0x02	0x00	0x01	KeyID	Error Bits	Reserved										
1	PLAIN_TEXT 7															
2	PLAIN_TEXT 8															
3	PLAIN_TEXT 9															
4	PLAIN_TEXT 10															
5	PLAIN_TEXT 11															
6	PLAIN_TEXT 12															
7	PLAIN_TEXT 13															

Figure 36-23. Continuation of output parameters

	3	2	1	0	7	6	5	4	B	A	9	8	F	E	D	C
0	0x02	0x00	0x01	KeyID	Error Bits	Reserved										
1	CIPHER_TEXT 7															
2	CIPHER_TEXT 8															
3	CIPHER_TEXT 9															
4	CIPHER_TEXT 10															
5	CIPHER_TEXT 11															
6	CIPHER_TEXT 12															
7	CIPHER_TEXT 13															

Then continue transferring data in and out until the full CBC operation is complete.

36.5.13.7 CMD_DEC_ECB

The Decrypt ECB command operates on a single 128-bit block of data. The function decrypts a given CYPHER_TEXT (128-bits) with the key identified by the KEY_ID (5-bits), and returns PLAIN_TEXT (128-bits). This command may also be extended by using the CallSeq field to 0x01 for continued pages of data.

All data presented must be in 128-bit blocks (any padding must be done by the application).

Table 36-80. Decrypt ECB command details

Parameter	Direction	Width
KEY_ID	IN	5
PAGE_LENGTH	IN	16
CIPHER_TEXT	IN	n * 128
PLAIN_TEXT	OUT	n * 128
PLAIN_TEXT = DEC _{ECB,KEY, KEY_ID} (CIPHER_TEXT)		
Error Codes: ERC_NO_ERROR, ERC_SEQUENCE_ERROR, ERC_KEY_NOT_AVAILABLE, ERC_KEY_INVALID, ERC_KEY_EMPTY, ERC_MEMORY_FAILURE, ERC_BUSY, ERC_GENERAL_ERROR		

Figure 36-24. Decrypt ECB input parameter format

	3	2	1	0	7	6	5	4	B	A	9	8	F	E	D	C
0	0x03	0x00	0x00	KeyID	Error Bits	Reserved										PAGE_LENGTH
1	CIPHER_TEXT 1															

Table continues on the next page...

	3	2	1	0	7	6	5	4	B	A	9	8	F	E	D	C
2	CIPHER_TEXT 2															
3	CIPHER_TEXT 3															
4	CIPHER_TEXT 4															
5	CIPHER_TEXT 5															
6	CIPHER_TEXT 6															
7	CIPHER_TEXT 7															

Figure 36-25. Decrypt ECB output parameter format

	3	2	1	0	7	6	5	4	B	A	9	8	F	E	D	C
0	0x03	0x00	0x00	KeyID	Error Bits	Reserved										
1	PLAIN_TEXT 1															
2	PLAIN_TEXT 2															
3	PLAIN_TEXT 3															
4	PLAIN_TEXT 4															
5	PLAIN_TEXT 5															
6	PLAIN_TEXT 6															
7	PLAIN_TEXT 7															

36.5.13.8 CMD_DEC_CBC

The Decrypt CBC command operates on multiple 128-bit blocks of data. The function decrypts a number of CIPHER_TEXT (128-bits) blocks with the key identified by the KEY_ID (5-bits) and Initialization vector (IV), then returns PLAIN_TEXT (128-bits) blocks for each input block.

All data must be presented in 128-bit blocks (any padding must be done by the application).

Table 36-81. Decrypt CBC command details

Parameter	Direction	Width
KEY_ID	IN	5
PAGE_LENGTH	IN	16
IV	IN	128
CIPHER_TEXT	IN	n * 128
PLAIN_TEXT	OUT	n * 128
PLAIN_TEXT = DEC _{CBC,KEY, KEY_ID,IV} (CIPHER_TEXT)		
Error Codes : ERC_NO_ERROR, ERC_SEQUENCE_ERROR, ERC_KEY_NOT_AVAILABLE, ERC_KEY_INVALID,ERC_KEY_EMPTY, ERC_MEMORY_FAILURE, ERC_BUSY, ERC_GENERAL_ERROR		

Figure 36-26. Decrypt CBC input parameters

	3	2	1	0	7	6	5	4	B	A	9	8	F	E	D	C	
0	0x04	0x00	0x00	KeyID	Error Bits		Reserved									PAGE_LENGTH	
1	IV																
2	CIPHER_TEXT 1																
3	CIPHER_TEXT 2																
4	CIPHER_TEXT 3																
5	CIPHER_TEXT 4																
6	CIPHER_TEXT 5																
7	CIPHER_TEXT 6																

Figure 36-27. Decrypt CBC output parameters

	3	2	1	0	7	6	5	4	B	A	9	8	F	E	D	C	
0	0x04	0x00	0x00	KeyID	Error Bits		Reserved										
1	IV																
2	PLAIN_TEXT 1																
3	PLAIN_TEXT 2																
4	PLAIN_TEXT 3																
5	PLAIN_TEXT 4																
6	PLAIN_TEXT 5																
7	PLAIN_TEXT 6																

Subsequent pages of information are provided, with the Byte 1 field of the CSEc Command Header indicating an ongoing operation is to be continued (i.e., change the CallSeq field from 0x00 to 0x01).

Figure 36-28. Continuation of input parameters

	3	2	1	0	7	6	5	4	B	A	9	8	F	E	D	C	
0	0x04	0x00	0x01	KeyID	Error Bits		Reserved										
1	CIPHER_TEXT 7																
2	CIPHER_TEXT 8																
3	CIPHER_TEXT 9																
4	CIPHER_TEXT 10																
5	CIPHER_TEXT 11																
6	CIPHER_TEXT 12																
7	CIPHER_TEXT 13																

Figure 36-29. Continuation of output parameters

	3	2	1	0	7	6	5	4	B	A	9	8	F	E	D	C
0	0x04	0x00	0x01	KeyID	Error Bits	Reserved										
1	PLAIN_TEXT 7															
2	PLAIN_TEXT 8															
3	PLAIN_TEXT 9															
4	PLAIN_TEXT 10															
5	PLAIN_TEXT 11															
6	PLAIN_TEXT 12															
7	PLAIN_TEXT 13															

36.5.13.9 CMD_GENERATE_MAC

The Generate MAC command operates on a MESSAGE of length in bits of MESSAGE_LENGTH. The function uses a key (KEY_ID) to encode a MAC value (128-bits) for the full message body.

Data is processed in 128-bit blocks through MESSAGE_LENGTH number of bits, with padding done internally on the last block if not an integer divide by 128-bit.

Output does not reflect the CMAC value until the full message has been processed, at which point it overwrites the second page of data as indicated in [Figure 36-33](#).

Table 36-82. Generate MAC command details

Parameter	Direction	Width
KEY_ID	IN	5
MESSAGE_LENGTH	IN	32
MESSAGE (DATA <n>)	IN	n * 128
MAC	OUT	128
MAC = CMAC _{KEY, KEY_ID} (MESSAGE, MESSAGE_LENGTH)		
Error Codes: ERC_NO_ERROR, ERC_SEQUENCE_ERROR, ERC_KEY_NOT_AVAILABLE, ERC_KEY_INVALID, ERC_KEY_EMPTY, ERC_MEMORY_FAILURE, ERC_BUSY, ERC_GENERAL_ERROR		

Figure 36-30. Generate MAC input parameters

	3	2	1	0	7	6	5	4	B	A	9	8	F	E	D	C
0	0x05	0x00	0x00	KeyID	Error Bits	Reserved						MESSAGE_LENGTH				
1	DATA 1															
2	DATA 2															

Table continues on the next page...

Functional description

	3	2	1	0	7	6	5	4	B	A	9	8	F	E	D	C
3	DATA 3															
4	DATA 4															
5	DATA 5															
6	DATA 6															
7	DATA 7															

Figure 36-31. Generate MAC output parameters

	3	2	1	0	7	6	5	4	B	A	9	8	F	E	D	C
0	0x05	0x00	0x00	KeyID	Error Bits	Reserved						MESSAGE_LENGTH				
1	DATA 1															
2	DATA 2															
3	DATA 3															
4	DATA 4															
5	DATA 5															
6	DATA 6															
7	DATA 7															

Figure 36-32. Continuation of input parameters

	3	2	1	0	7	6	5	4	B	A	9	8	F	E	D	C
0	0x05	0x00	0x01	KeyID	Error Bits	Reserved						MESSAGE_LENGTH				
1	DATA 8															
2	DATA 9															
3	DATA 10															
4	DATA 11															
5	DATA 12															
6	DATA 13															
7	DATA 14															

Figure 36-33. Continuation of output parameters

	3	2	1	0	7	6	5	4	B	A	9	8	F	E	D	C
0	0x05	0x00	0x01	KeyID	Error Bits	Reserved						MESSAGE_LENGTH				
1	DATA 8															
2	MAC															
3	DATA 10															
4	DATA 11															
5	DATA 12															

Table continues on the next page...

	3	2	1	0	7	6	5	4	B	A	9	8	F	E	D	C
6	DATA 13															
7	DATA 14															

36.5.13.10 CSEc format for CMD_GENERATE_MAC (pointer method)

For data that is contained fully within the NVM macro the ‘pointer’ method of communication is used. For internal NVM space the maximum size of data is limited to be no more than one read partition, or less if the starting address is not the start of the read partition (i.e., the address sequence cannot cross boundaries of read partitions). The 'Flash Start Address' must be 128-bit aligned (the same is true for CMD_VERIFY_MAC pointer method).

If CMD_GENERATE_MAC pointer method is executed on non-PFlash locations, the result will be unpredictable (the same is true for CMD_VERIFY_MAC pointer method).

Figure 36-34. CSEc format for GENERATE_MAC input parameters

	3	2	1	0	7	6	5	4	B	A	9	8	F	E	D	C
0	0x05	0x01	0x00	KeyID	Error Bits	Reserved						MESSAGE_LENGTH				
1	Flash Start Address				Reserved											
2	Reserved															
3	Reserved															
4	Reserved															
5	Reserved															
6	Reserved															
7	Reserved															

Figure 36-35. CSEc format for CMD_GENERATE_MAC output parameters

	3	2	1	0	7	6	5	4	B	A	9	8	F	E	D	C
0	0x05	0x01	0x00	KeyID	Error Bits	Reserved						MESSAGE_LENGTH				
1	Flash Start Address				Reserved											
2	MAC															
3	Reserved															
4	Reserved															
5	Reserved															
6	Reserved															
7	Reserved															

36.5.13.11 CMD_VERIFY_MAC

The Verify MAC command verifies a MAC of a given MESSAGE, which can be multiple 128-bit blocks of data, against a provided for MAC. The MESSAGE to compare, starting with the leftmost bit of the MAC, are given in the MESSAGE_LENGTH. The value 0 is not allowed and is interpreted by SHE to compare all bits of the MAC. The function returns an error if the length provided for message has another length than stated in MESSAGE_LENGTH. Input DATA1-DATAn until all messages are entered, with the expected MAC being the last entry after all DATA are input, i.e., MAC will be the position of block N+1 for 'N' number of DATA blocks.

All padding is to be done according to SHE specification using MESSAGE_LENGTH.

$$n = \text{CEIL}(\text{MESSAGE_LENGTH} / 128)$$

The first example shows 6 DATA blocks followed by the expected MAC, with the output overwriting the DATA1 block at the end of the operation with the MAC verification status.

The continuation examples show DATA1-10 by continuing from the first example but DATA7 would be written in place of the CMAC from the first example, followed by continuation with DATA8 which follows on the next page. Finally ending in DATA10 for this example, following with the expected CMAC value after the DATA 10 entry.

Table 36-83. Verify MAC command details

Parameter	Direction	Width
KEY_ID	IN	5
MESSAGE_LENGTH	IN	32
MESSAGE (DATA <n>)	IN	n * 128
MAC	IN	128
MAC_LENGTH (MAC Length[6:0])	IN	7
VERIFICATION_STATUS (Verification Status[0])	OUT	1
$\text{MAC}_{\text{calc}} = \text{TRUNCATE}(\text{CMAC}_{\text{KEY, KEY_ID}}(\text{MESSAGE}, \text{MESSAGE_LENGTH}), \text{MAC_LENGTH})$ $\text{MAC}_{\text{ref}} = \text{TRUNCATE}(\text{MAC}, \text{MAC_LENGTH})$ $\text{VERIFICATION_STATUS} = (0 \sim (\text{MAC}_{\text{calc}} - \text{MAC}_{\text{ref}}))$		
Error Codes: ERC_NO_ERROR, ERC_SEQUENCE_ERROR, ERC_KEY_NOT_AVAILABLE, ERC_KEY_INVALID, ERC_KEY_EMPTY, ERC_MEMORY_FAILURE, ERC_BUSY, ERC_GENERAL_ERROR		

Figure 36-36. Verify MAC input parameters

	3	2	1	0	7	6	5	4	B	A	9	8	F	E	D	C
0	0x06	0x00	0x00	KeyID	Error Bits		Reserved	MAC Length			Reserved		MESSAGE_LENGTH			
1	DATA 1															
2	DATA 2															
3	DATA 3															
4	DATA 4															
5	DATA 5															
6	DATA 6															
7	MAC															

Figure 36-37. Verify MAC output parameters

	3	2	1	0	7	6	5	4	B	A	9	8	F	E	D	C
0	0x06	0x00	0x00	KeyID	Error Bits		Reserved	MAC Length			Reserved		MESSAGE_LENGTH			
1					Verification Status	DATA 1										
2	DATA 2															
3	DATA 3															
4	DATA 4															
5	DATA 5															
6	DATA 6															
7	MAC															

Figure 36-38. Continuation of input parameters

	3	2	1	0	7	6	5	4	B	A	9	8	F	E	D	C
0	0x06	0x00	0x01	KeyID	Error Bits		Reserved	MAC Length			Reserved		MESSAGE_LENGTH			
1	DATA 8															
2	DATA 9															
3	DATA 10															
4	MAC															
5																
6																
7																

Figure 36-39. Continuation of output parameters

	3	2	1	0	7	6	5	4	B	A	9	8	F	E	D	C
0	0x06	0x00	0x01	KeyID	Error Bits		Reserved	MAC Length			Reserved		MESSAGE_LENGTH			
1					Verification Status	Data 8										

Table continues on the next page...

Functional description

	3	2	1	0	7	6	5	4	B	A	9	8	F	E	D	C
2	DATA 9															
3	DATA 10															
4	MAC															
5																
6																
7																

36.5.13.12 CMD_VERIFY_MAC - CSEc format (pointer method)

Figure 36-40. Verify MAC (pointer method) input parameters

	3	2	1	0	7	6	5	4	B	A	9	8	F	E	D	C
0	0x06	0x01	0x00	KeyID	Error Bits	Reserved	MAC Length	Reserved	MESSAGE_LENGTH							
1	Flash Start Address				Reserved											
2	MAC															
3	Reserved															
4																
5																
6																
7																

Figure 36-41. Verify MAC (pointer method) output parameters

	3	2	1	0	7	6	5	4	B	A	9	8	F	E	D	C
0	0x06	0x01	0x00	KeyID	Error Bits	Reserved	MAC Length	Reserved	MESSAGE_LENGTH							
1	Flash Start Address				Verification Status	Reserved										
2	MAC															
3	Reserved															
4																
5																
6																
7																

36.5.13.13 CMD_LOAD_KEY

The LOAD KEY command updates an internal key per the SHE specification. If a protected key is loaded into the RAM_KEY, the function has to disable the plain key status bit.

Table 36-84. LOAD_KEY command details

Parameter	Direction	Width
KEY_ID	IN	5
M1	IN	128
M2	IN	256
M3	IN	128
M4	OUT	256
M5	OUT	128

Error Codes: ERC_NO_ERROR, ERC_SEQUENCE_ERROR, ERC_KEY_NOT_AVAILABLE, ERC_KEY_INVALID, ERC_KEY_WRITE_PROTECTED, ERC_KEY_UPDATE_ERROR, ERC_KEY_EMPTY, ERC_MEMORY_FAILURE, ERC_BUSY, ERC_GENERAL_ERROR

NOTE

1. Due to extension of the maximum number of keys (beyond SHE specification) and the usage of KBS to identify the higher and lower order keys, M1 entry will follow the traditional SHE specifications (requiring the two 4-bit ID and AuthID entries along with UID), but the command will need more information showing which KBS (0 or 1) is requested. This will be communicated by an additional requirement of entering the KEY_ID ({KBS,KeyIDx[3:0]}). Lastly, the KeyIDx[3:0] in M1 must be consistent with the KeyIDx[3:0] in the 5-bit KEY_ID entry in the command header.
2. If the key AuthID is empty, the key update can work with AuthID = ID and Auth_value = all F's; otherwise ERC_KEY_UPDATE_ERROR is returned.
3. When updating BOOT_MAC, KBS must be set to 0 (KBS=1 will generate an error).
4. Once a quick write is started, user must finish the entire quick write activity prior to starting a LOAD_KEY command.

The PGMPART configuration (see Program Partition Command) allows for an extension to the SHE specification in which the user may enable a VERIFY_ONLY flag for the GENERATE_MAC to take into consideration. For the VERIFY_ONLY attribute, if set,

Functional description

the associated memory key slot will be treated as invalid by the CMD_GENERATE_MAC command (only valid for CMD_VERIFY_MAC). The VERIFY_ONLY attribute has no effect if KEY_USAGE == 0.

The SHE specification defines M2 as:

$$M2 - ENC_{CBD,K1,IV=0} (C_{ID} \| F_{ID} \| "0...0"_{95} | K_{ID}') : SFE == 0x00$$

$$M2 - ENC_{CBD,K1,IV=0} (C_{ID} \| F_{ID} \| "0...0"_{94} | K_{ID}') : SFE == 0x01$$

Table 36-85. F_{ID} & zero fill in M2 w/ SFE

PGMPART SFE field	M2 equation changes for LOAD_KEY	F _{ID}
SFE == 0x00 (VERIFY_ONLY flag not enabled, default SHE)	F _{ID} (5-bits) \ "0...0" ₉₅	{ WRITE_PROTECTION BOOT_PROTECTION DEBUGGER_PROTECTION KEY_USAGE WILDCARD }
SFE == 0x01 (VERIFY_ONLY flag is enabled, enhanced SHE)	F _{ID} (6-bits) \ "0...0" ₉₄	{ WRITE_PROTECTION BOOT_PROTECTION DEBUGGER_PROTECTION KEY_USAGE WILDCARD VERIFY_ONLY }

When the optional SFE bit is set in the PGMPART command to enable the VERIFY_ONLY flag for CSEc keys, the F_{ID} field will be extended by one bit with the VERIFY_ONLY flag, and the adjacent zero fill field is reduced by one bit to be a total of 94-bits.

If SFE enabled, then the VERIFY_ONLY flag should be set to 1'b1 for VERIFY_ONLY attribute to be enabled, and cleared to 1'b0 for the VERIFY_ONLY attribute to be disabled for the particular key.

Figure 36-42. Load key input parameters

	3	2	1	0	7	6	5	4	B	A	9	8	F	E	D	C
0	0x07	0x00	0x01	KeyID	Error Bits	Reserved										
1												M1				
2												M2				
3																
4												M3				
5												Reserved				
6																
7																

Figure 36-43. Load key output parameters

	3	2	1	0	7	6	5	4	B	A	9	8	F	E	D	C
0	0x07	0x00	0x01	KeyID	Error Bits		Reserved									
1											M1					
2											M2					
3																
4											M3					
5											M4					
6																
7											M5					

36.5.13.14 CMD_LOAD_PLAIN_KEY

The Load Plain Key command, loads a key 'KEY' without encryption and does a verification of the key. The key is handed over in plain text. A plain key can only be loaded into the RAM_KEY slot (per SHE specification). The command sets the plain key status bit for the RAM_KEY. There is no return value. The command header fields in Bytes [0,2] are ignored, while setting Byte[1] to 0x01 will create a sequence error.

Table 36-86. LOAD_PLAIN_KEY command details

Parameter	Direction	Width
KEY	IN	128
KEY _{RAM_KEY} = key		
RAM_KEY_PLAIN = 1		
Error Codes: ERC_NO_ERROR, ERC_SEQUENCE_ERROR, ERC_BUSY, ERC_GENERAL_ERROR		

Figure 36-44. Load Plain Key input parameters

	3	2	1	0	7	6	5	4	B	A	9	8	F	E	D	C
0	0x08	0x00	0x00	KeyID	Error Bits		Reserved									
1											Plain Key					
2											Reserved					
3																
4																
5																
6																
7																

This command has no return values

36.5.13.15 CMD_EXPORT_RAM_KEY

The Export RAM Key command exports the RAM_KEY into a format protected by the SECRET_KEY. The key may be imported again by using the CMD_LOAD_KEY command.

A RAM_KEY can only be exported if it was written as plain text, i.e., by CMD_LOAD_PLAIN_KEY.

This command is for loading and unloading a RAM_KEY. The reserved fields for security flags and the counter are set to '0'.

No values other than M1, may leave SHE/CSEc.

NOTE

Due to setting the counter and flags to '0' by definition in the case of RAM_KEY updates, the first block of the encrypted message M₂ will become a constant '0' block.

Table 36-87. Export RAM_KEY command details

Parameter	Direction	Width
M1	OUT	128
M2	OUT	256
M3	OUT	128
M4	OUT	256
M5	OUT	128
K1 = KDF(KEY _{SECRET_KEY} , KEY_UPDATE_ENC_C) K2 = KDF(KEY _{SECRET_KEY} , KEY_UPDATE_MAC_C) C _{ID} = 0 (28-bits) F _{ID} = 0 (5-bits) M1 = UID ID _{RAM_KEY} ID _{SECRET_KEY} M2 = ENC _{CBC, K1, IV=0} (C _{ID} F _{ID} "0...0" ₉₅ KEY _{RAM_KEY}) = ENC _{CBC, K1, IV=0} ("0 ...0" ₁₂₈ KEY _{RAM_KEY}) M3 = CMAC _{K2} (M1 M2) K3 = KDF (KEY _{RAM_KEY} , KEY_UPDATE_ENC_C) K4 = KDF (KEY _{RAM_KEY} , KEY_UPDATE_MAC_C) M4 = UID ID _{RAM_KEY} ID _{SECRET_KEY} ENC _{EBC, K3} (C _{ID}) M5 = CMAC _{K4} (M4)		
Error Codes: ERC_NO_ERROR, ERC_SEQUENCE_ERROR, ERC_KEY_INVALID, ERC_KEY_EMPTY, ERC_MEMORY_FAILURE, ERC_BUSY, ERC_GENERAL_ERROR		

Figure 36-45. Export RAM_KEY input parameters

	3	2	1	0	7	6	5	4	B	A	9	8	F	E	D	C
0	0x09	0x00	0x00	KeyID	Error Bits	Reserved										
1	Reserved															
2	Reserved															
3	Reserved															
4	Reserved															
5	Reserved															
6	Reserved															
7	Reserved															

Figure 36-46. Export RAM_KEY output parameters

	3	2	1	0	7	6	5	4	B	A	9	8	F	E	D	C
0	0x09	0x00	0x00	KeyID	Error Bits	Reserved										
1	M1															
2	M2															
3	M2															
4	M3															
5	M4															
6	M4															
7	M5															

36.5.13.16 CMD_INIT_RNG

The INIT_RNG command initializes and derives a key for the PRNG. It must be called before the CMD_RND command and after every power cycle or reset. Bytes [0:2] of the command header are ignored.

Table 36-88. INIT_RNG command details

Parameter	Direction	Width
NONE		
The command has to ignore active debugger protection or secure boot protection flags on SECRET_KEY.		
NOTE: The command may need several hundred ms to return		
Error Codes : ERC_NO_ERROR, ERC_SEQUENCE_ERROR, ERC_MEMORY_FAILURE, ERC_BUSY, ERC_GENERAL_ERROR		

Figure 36-47. INIT_RNG input parameters

Functional description

	3	2	1	0	7	6	5	4	B	A	9	8	F	E	D	C
0	0x0A	0x00	0x00	KeyID	Error Bits		Reserved									
1	Reserved															
2	Reserved															
3	Reserved															
4	Reserved															
5	Reserved															
6	Reserved															
7	Reserved															

The INIT_RNG command has no return values.

36.5.13.17 CMD_EXTEND_SEED

The EXTEND_SEED command extends the seed of the PRNG by compressing the former seed value and the supplied ENTROPY into a new seed. This new seed is then to be used to generate a random number by invoking the CMD_RND command. The random number generator must be initialized by CMD_INIT_RNG before the seed may be extended

Table 36-89. EXTEND_SEED command details

Parameter	Direction	Width
ENTROPY	IN	128
The command has to ignore active debugger protection or secure boot protection flags on SECRET_KEY.		
NOTE: The command may need several hundred ms to return		
Error Codes : ERC_NO_ERROR, ERC_SEQUENCE_ERROR, ERC_RNG_SEED, ERC_MEMORY_FAILURE, ERC_BUSY, ERC_GENERAL_ERROR		

Figure 36-48. EXTEND_SEED input parameters

	3	2	1	0	7	6	5	4	B	A	9	8	F	E	D	C
0	0x0B	0x00	0x00	KeyID	Error Bits		Reserved									
1	ENTROPY															
2	Reserved															
3	Reserved															
4	Reserved															
5	Reserved															
6	Reserved															
7	Reserved															

The EXTEND_SEED command has no return values.

36.5.13.18 CMD_RND

The CMD_RND command returns a vector of 128 random bits.

The random number generator has to be initialized by CMD_INIT_RNG before random numbers can be supplied.

The command header fields in Bytes [0,2] are ignored, while setting Byte[1] to 0x01 will generate a sequence error.

Table 36-90. CMD_RND command details

Parameter	Direction	Width
RND	OUT	128
IF (SREG _{RND_INIT} == 0) PRNG_STATE _i = ENC _{ECB,KEY} PRNG_KEY (PRNG_STATE _{i-1}) RND = PRNG_STATE _i END IF		
Error Codes : ERC_NO_ERROR, ERC_SEQUENCE_ERROR, ERC_RNG_SEED, ERC_MEMORY_FAILURE, ERC_BUSY, ERC_GENERAL_ERROR		

Figure 36-49. CMD_RND input parameters

	3	2	1	0	7	6	5	4	B	A	9	8	F	E	D	C
0	0x0C	0x00	0x00	KeyID	Error Bits	Reserved										
1	Reserved															
2	Reserved															
3	Reserved															
4	Reserved															
5	Reserved															
6	Reserved															
7	Reserved															

Table 36-91. CMD_RND Output Parameters

	3	2	1	0	7	6	5	4	B	A	9	8	F	E	D	C
0	0x0C	0x00	0x00	KeyID	Error Bits	Reserved										
1	RND [0:15]															
2	Reserved															
3	Reserved															

Table continues on the next page...

Table 36-91. CMD_RND Output Parameters (continued)

	3	2	1	0	7	6	5	4	B	A	9	8	F	E	D	C
4																
5																
6																
7																

36.5.13.19 CMD_SECURE_BOOT

This command is not supported by the FTFC/CSEc module. See the new command 'CMD_BOOT_DEFINE' which configures the type of secure boot to execute. Parts enabled with the CSEc feature will always execute the configured secure boot type upon reset.

The CSEc feature runs autonomously, reading custom parameters from the flash and verifies the MAC. The size of secure boot is defined by BOOT_SIZE. On CSEc enabled parts, secure boot is enabled by programming of the BOOT_MAC_KEY.

The secure boot parameters are entered via the CMD_BOOT_DEFINE command.

36.5.13.20 CMD_BOOT_FAILURE

This command may be used when checking additional blocks of information after the autonomous secure boot finishes (per CMD_BOOT_DEFINE configuration).

Table 36-92. CMD_BOOT_FAILURE Command Details

Parameter	Direction	Width
NONE		
<p>The command will impose the same sanctions as if CMD_SECURE_BOOT would detect a failure, but can be used in later stages of the boot process.</p> <p>CMD_BOOT_FAILURE may only be called once after every power cycle/reset and may only be called if SECURE_BOOT did not detect any errors before and if CME_BOOT_OK was not called.</p> <p>NOTE : CSEc module provides for the first autonomous stage of the secure boot process (if so configured with BOOT_DEFINE), thus this function can be used during the following stages to provide the boot status to CSEc.</p> <p>IF (SREG_SECURE_BOOT == 1 AND SREG_BOOT_OK == 1 AND SREG_BOOT_FINISHED == 0)</p> <p>SREG_BOOT_FINISHED = 1</p> <p>SREG_BOOT_OK = 0</p> <p>END IF</p>		
<p>Error Codes : ERC_NO_ERROR, ERC_SEQUENCE_ERROR, ERC_NO_SECURE_BOOT, ERC_BUSY, ERC_GENERAL_ERROR</p>		

Table 36-93. CMD_BOOT_FAILURE Input Parameters

	3	2	1	0	7	6	5	4	B	A	9	8	F	E	D	C
0	0x0E	0x00	0x00	KeyID	Error Bits	Reserved										
1	Reserved															
2	Reserved															
3	Reserved															
4	Reserved															
5	Reserved															
6	Reserved															
7	Reserved															

36.5.13.21 CMD_BOOT_OK

This command may be used when checking additional blocks of information after the autonomous secure boot finishes (per CMD_BOOT_DEFINE configuration).

Table 36-94. CMD_BOOT_OK Command Details

Parameter	Direction	Width
NONE		
<p>The command is used to mark successful boot verification for later stages than the autonomous SECURE_BOOT (operation defined by CMD_BOOT_DEFINE). In particular it is meant to lock the command CMD_BOOT_FAILURE.</p> <p>CMD_BOOT_OK may only be called once after every power cycle/reset and may only be called if SECURE_BOOT did not detect any errors before and if CME_BOOT_FAILIRE was not called.</p> <p>NOTE : CSEc module provides for the first autonomous stage of the secure boot process (if so configured with BOOT_DEFINE), thus this function can be used during the following stages to provide the boot status to CSEc.</p> <p>IF (SREG_SECURE_BOOT == 1 AND SREG_BOOT_OK == 1 AND SREG_BOOT_FINISHED == 0)</p> <p>SREG_BOOT_FINISHED = 1</p> <p>END IF</p>		
<p>Error Codes : ERC_NO_ERROR, ERC_SEQUENCE_ERROR, ERC_NO_SECURE_BOOT, ERC_BUSY, ERC_GENERAL_ERROR</p>		

Table 36-95. CMD_BOOT_OK Input Parameters

	3	2	1	0	7	6	5	4	B	A	9	8	F	E	D	C
0	0x0F	0x00	0x00	KeyID	Error Bits	Reserved										
1	Reserved															
2	Reserved															
3	Reserved															

Table continues on the next page...

Table 36-95. CMD_BOOT_OK Input Parameters (continued)

	3	2	1	0	7	6	5	4	B	A	9	8	F	E	D	C
4																
5																
6																
7																

36.5.13.22 CMD_GET_STATUS

This command is implemented via a STATUS register FCSESTAT

36.5.13.23 CMD_GET_ID

The GET_ID command returns the UID and the value of the status register (protected by a MAC over a challenge and the data). If the MASTER_ECU_KEY is empty, the MAC returned value is set to '0'.

The 'KeyID' input is ignored in this command, as the MASTER_ECU_KEY is the only valid key to be considered.

Table 36-96. GET_ID command details

Parameter	Direction	Width
CHALLENGE	IN	128
ID	OUT	120
SREG	OUT	8
MAC	OUT	128
ID = UID		
MAC = CMAC _{KEY_MASTER_ECU_KEY} (CHALLENGE ID SREG)		
Error Codes : ERC_NO_ERROR, ERC_SEQUENCE_ERROR, ERC_KEY_NOT_AVAILABLE, ERC_MEMORY_FAILURE, ERC_GENERAL_ERROR		

Figure 36-50. GET_ID input parameters

	3	2	1	0	7	6	5	4	B	A	9	8	F	E	D	C
0	0x10	0x00	0x00	KeyID	Error Bits	Reser ved	Reserved									
1	CHALLENGE															
2	Reserved															
3																

Table continues on the next page...

	3	2	1	0	7	6	5	4	B	A	9	8	F	E	D	C
4																
5																
6																
7																

Figure 36-51. GET_ID output parameters

	3	2	1	0	7	6	5	4	B	A	9	8	F	E	D	C
0	0x10	0x00	0x00	KeyID	Error Bits	Reserved										
1	CHALLENGE															
2	ID															SRE G
3	MAC															
4	Reserved															
5																
6																
7																

36.5.13.24 CMD_CANCEL

This command isn't strictly supported by the FTFC module. The user should manage software driven commands accordingly.

For any CSEc command that is executed in a series of continued commands, the command may be 'cancelled' by one of a few mechanisms.

For example, streams of CBC encode data that is processed through continuations of inputting data through the PRAM seven block input buffer, could be 'cancelled' by giving an illegal continuation of the next segment of data. Such as clearing the CallSeq field in the Command Header, or changing the FuncID to a different command. Each will generate a sequence error, which will kill/cancel the ongoing command.

Additionally, starting any FCCOB command in one of the pauses of continuation of a CSEc command will result in the FCCOB command executing to completion as expected, but will kill/cancel the current CSEc command.

36.5.13.25 CMD_BOOT_DEFINE

This is a non-SHE specified command, and is used in CSEc implementation to allow the user to define both the User BOOT_SIZE (boot code size of data is in the message length in number of bits to run CMAC on each POR), and the ‘flavor’ of boot (strict, serial, parallel, none).

The command header fields in Bytes [0:2] are ignored.

NOTE

1. **Warning:** If the 'Strict Boot' option is chosen and the CMAC supplied doesn't match the CMAC calculated, then the part will be hung in reset. Additionally since the boot flavor can't be changed once 'Strict' is chosen, this error will not be able to be reversed. Make sure to verify the CMAC and full boot process is completing and passing as expected BEFORE selecting the 'Strict' boot flavor.

Additionally, even though Strict Boot may not be changed once set, it is possible to change the CODE contents and associated BOOT_MAC & SIZE. But if a reset or any interruption of the part occurs between updating Code and matching SIZE, BOOT_MAC with the 'Strict Boot' option enabled, the result will be mismatch of BOOT_MAC to calculated CMAC, thus the part stuck in reset.

2. The autonomous Secure Boot is run on the PFlash block starting at address '0' and finishing at BOOT_SIZE # of bits later. Subsequent Boot Code checks at other addresses may be run later via CMD_VEFIFY_MAC command(s). With the end of the secure boot process being followed by either CMD_BOOT_OK or CMD_BOOT_FAILURE.
3. Once a quick write is started, user must finish the entire quick write activity prior to starting a BOOT_DEFINE command.

Table 36-97. BOOT_DEFINE command details

Parameter	Direction	Width
BOOT_SIZE (# Bytes * 8, or Number of Bits : maximum size is 512 KB)	IN	32
Boot Flavor	IN	8
2'b00 : Strict (SHE Optional boot - OTP : Once set can't be changed)		
2'b01 : Serial Boot method		
2'b10 : Parallel Boot method		

Table continues on the next page...

Table 36-97. BOOT_DEFINE command details (continued)

Parameter	Direction	Width
2'b11 : No Boot defined (MASTER_ECU_KEY) not initialized yet, or non-CSEc enabled part		
Error Codes: ERC_NO_ERROR, ERC_SEQUENCE_ERROR, , ERC_KEY_INVALID,, ERC_MEMORY_FAILURE, ERC_BUSY, ERC_GENERAL_ERROR		

Figure 36-52. BOOT DEFINE input parameter format

	3	2	1	0	7	6	5	4	B	A	9	8	F	E	D	C
0	0x11	0x00	0x00	KeyID	Error Bits	Reserved										
1	Reserved											Boot Flavor	BOOT_SIZE			
2	Reserved															
3	Reserved															
4	Reserved															
5	Reserved															
6	Reserved															
7	Reserved															

36.5.13.26 CMD_DBG_CHAL

The SHE CMD_DEBUG command is modified and split into two steps in CSEc commands: CMD_DBG_CHAL followed by CMD_DBG_AUTH. The CMD_DBG_CHAL/AUTH command pair must be followed by a subsequent reset before PGMPART command may be re-issued.

The CMD_DBG_CHAL command is issued to request a random number which the user will use along with the MASTER_ECU_KEY and UID to return a authorization request using the CMD_DBG_AUTH command.

NOTE

The CMD_DBG_CHAL command must be followed by the CMD_DBG_AUTH command, otherwise the CMD_DBG_CHAL command would be required to be re-issued before continuing.

Table 36-98. DEBUG command details

Parameter	Direction	Width
CHALLENGE	OUT	128

Table continues on the next page...

Table 36-98. DEBUG command details (continued)

Parameter	Direction	Width
Error Codes : ERC_NO_ERROR, ERC_SEQUENCE_ERROR, ERC_WRITE_PROTECTED, ERC_RNG_SEED, ERC_NO_DEBUGGING, ERC_MEMORY_FAILURE, ERC_BUSY, ERC_GENERAL_ERROR		

Figure 36-53. DEBUG input parameters

	3	2	1	0	7	6	5	4	B	A	9	8	F	E	D	C
0	0x12	0x00	0x00	KeyID	Error Bits		Reserved									
1	Reserved															
2	Reserved															
3	Reserved															
4	Reserved															
5	Reserved															
6	Reserved															
7	Reserved															

Figure 36-54. DEBUG output parameters

	3	2	1	0	7	6	5	4	B	A	9	8	F	E	D	C
0	0x12	0x00	0x00	KeyID	Error Bits		Reserved									
1	CHALLENGE															
2	Reserved															
3	Reserved															
4	Reserved															
5	Reserved															
6	Reserved															
7	Reserved															

36.5.13.27 CMD_DBG_AUTH

The CMD_DBG_AUTH command erases all keys (actual and outdated) stored in NVM memory.

NOTE

If the WRITE_PROTECTION flag has been set on any of the keys, the CMD_DEBUG does not execute the erase of any keys. This also implies that the ERSALL and ERSALLU and erase all that is triggered external to the FTFC will not be able to execute.

After CSEc confirms authentication, the Flash Keys are erased. If any key has the WRITE_PROTECTION flag set, the command will stop and not offer any failure analysis mode.

After SHE authentication of the process passes, the command will erase the Flash Keys (DFlash), placing the part back into factory status.

The command cannot be executed if authentication fails.

The command ignores active debugger protection and secure boot protection flags as well as empty keys.

After successful authentication the User IFR, (flash) keys (including DFlash & EERAM space) have been erased. Then, a reset must be performed. At this point, the FlexRAM is no longer configured as EEE and is now available as System RAM (EEERDY == 0, RAMRDY ==1).

Table 36-99. CMD_DBG_AUTH

Parameter	Direction	Width
AUTHORIZATION	IN	128
SHE & Backend: $K = KDF(\text{KEY}_{\text{MASTER_ECU_KEY}}, \text{DEBUG_KEY_C})$ SHE: CHALLENGE = CMD_RND() Backend: $\text{AUTHORIZATION} = \text{CMAC}_K(\text{CHALLENGE} \parallel \text{UID})$		
Error Codes: ERC_NO_ERROR, ERC_SEQUENCE_ERROR, ERC_WRITE_PROTECTED, ERC_RNG_SEED, ERC_NO_DEBUGGING, ERC_MEMORY_FAILURE, ERC_BUSY, ERC_GENERAL_ERROR		

Figure 36-55. DBG_AUTH input parameters

	3	2	1	0	7	6	5	4	B	A	9	8	F	E	D	C
0	0x13	0x00	0x00	KeyID	Error Bits		Reserved									
1	AUTHORIZATION															
2	Reserved															
3																
4																
5																
6																
7																

36.5.13.28 CMD_MP_COMPRESS

The MP_COMPRESS command accesses a Miyaguchi-Prenell compression feature with in the CSEc feature set. This function, provided with the AES as a block cipher, is used as a compression function. Messages must be pre-processed per SHE specification if they do not already meet the full 128-bit block size requirement, i.e., the user/application is responsible for padding if the message is not already 128-bits in length.

For this command the PAGE_LENGTH is to be input as the number of 128-bit pages, and the KeyID input is a don't care.

Table 36-100. MP Compress command details

Parameter	Direction	Width
DATA <n>	IN	n * 128
PAGE_LENGTH	IN	16
MP_COMPRESS	OUT	128
Error Codes : ERC_NO_ERROR, ERC_SEQUENCE_ERROR, ERC_GENERAL_ERROR		

Figure 36-56. MP compress input parameters

	3	2	1	0	7	6	5	4	B	A	9	8	F	E	D	C
0	0x16	0x00	0x00	KeyID	Error Bits		Reserved								PAGE_LENGTH	
1	DATA 1															
2	DATA 2															
3	DATA 3															
4	DATA 4															
5	DATA 5															
6	DATA 6															
7	DATA 7															

Figure 36-57. MP compress output parameters

	3	2	1	0	7	6	5	4	B	A	9	8	F	E	D	C
0	0x16	0x00	0x00	KeyID	Error Bits		Reserved								PAGE_LENGTH	
1	MP_COMPRESS															
2	DATA 2															
3	DATA 3															
4	DATA 4															
5	DATA 5															

Table continues on the next page...

	3	2	1	0	7	6	5	4	B	A	9	8	F	E	D	C
6	DATA 6															
7	DATA 7															

Figure 36-58. Continuation of input parameters

	3	2	1	0	7	6	5	4	B	A	9	8	F	E	D	C
0	0x16	0x00	0x01	KeyID	Error Bits	Reserved										PAGE_LENGTH
1	DATA 8															
2	DATA 9															
3	DATA 10															
4	DATA 11															
5	DATA 12															
6	DATA 13															
7	DATA 14															

Figure 36-59. Continuation of output parameters

	3	2	1	0	7	6	5	4	B	A	9	8	F	E	D	C
0	0x16	0x00	0x01	KeyID	Error Bits	Reserved										PAGE_LENGTH
1	MP_COMPRESS															
2	DATA 9															
3	DATA 10															
4	DATA 11															
5	DATA 12															
6	DATA 13															
7	DATA 14															

36.5.14 Reset sequence

On each system reset the FTFC module executes a sequence which establishes initial values for the flash block configuration parameters, FPROT, FDPROT, FEPROT, FOPT, and FSEC registers and the FCNFG[RAMRDY, EEERDY] bits.

Boot will proceed according to the configuration set by the BOOT_DEFINE command (secure boot or not, and what type of secure boot).

Functional description

CCIF is cleared throughout the reset sequence. The FTFC module holds off all CPU access for a portion of the reset sequence. Flash reads are possible when the hold is removed. Completion of the reset sequence is marked by setting CCIF which enables flash user commands.

If a reset occurs while any FTFC command is in progress, that command is immediately aborted. The state of the word being programmed or the sector/block being erased is not guaranteed. Commands and operations do not automatically resume after exiting reset.

Chapter 37

Flash Memory Module (FTFM)

37.1 Chip-specific FTFM information

FTFM is available in only S32K14xW series of devices.

37.2 Introduction

The FTFM module includes the following accessible memory regions:

- Program flash memory for vector space and code store
- FlexNVM for data store and additional code store
- FlexRAM for high-endurance data store or traditional RAM

Flash memory is ideal for single-supply applications, permitting in-the-field erase and reprogramming operations without the need for any external high voltage power sources.

The FTFM module includes a memory controller that executes commands to modify flash memory contents. An erased bit reads '1' and a programmed bit reads '0'. The programming operation is unidirectional; it can only move bits from the '1' state (erased) to the '0' state (programmed). Only the erase operation restores bits from '0' to '1'; bits cannot be programmed from a '0' to a '1'.

CAUTION

A flash memory location must be in the erased state before being programmed. Cumulative programming of bits (back-to-back program operations without an intervening erase) within a flash memory location is not allowed. Re-programming of existing 0s to 0 is not allowed as this overstresses the device.

The standard shipping condition for flash memory is erased with security disabled. Data loss over time may occur due to degradation of the erased ('1') states and/or programmed ('0')

states. Therefore, it is recommended that each flash block or sector be re-erased immediately prior to factory programming to ensure that the full data retention capability is achieved.

37.2.1 Features

The FTFM module includes the following features.

NOTE

See the device's Chip Configuration details for the exact amount of flash memory available on your device.

37.2.1.1 Program flash memory features

- Sector size of 4 KB
- Program flash protection scheme prevents accidental program or erase of stored data
- Automated, built-in, program and erase algorithms with verify
- Section programming for faster bulk programming times
- Read access to the program flash block is possible while programming or erasing data in the data flash block or FlexRAM

37.2.1.2 FlexNVM memory features

When FlexNVM is partitioned for data flash memory:

- Sector size of 2 KB
- Protection scheme prevents accidental program or erase of stored data
- Automated, built-in program and erase algorithms with verify
- Section programming for faster bulk programming times
- Read access to the data flash block possible while programming or erasing data in the program flash block

37.2.1.3 FlexRAM features

- Memory that can be used as traditional RAM or as high-endurance emulated EEPROM storage
- Up to 4 KB of FlexRAM configured for emulated EEPROM or traditional RAM operations
- Supports aligned writes of 4 bytes (32-bits) at a time
- When configured for emulated EEPROM:

- Protection scheme prevents accidental modification of emulated EEPROM
- Built-in hardware emulation scheme to automate emulated EEPROM record maintenance functions
- Programmable emulated EEPROM data set size and FlexNVM partition code facilitating emulated EEPROM memory endurance trade-offs
- Supports EEPROM quick writes to multiple FlexRAM addresses
- Read access to FlexRAM possible while programming or erasing data in the program or data flash memory
- When configured for traditional RAM:
 - Read and write access possible to the FlexRAM while phrase programming or erasing data in the program or data flash memory

37.2.1.4 CSE_PRAM features

- 128 bytes of memory dedicated for CSEc command operations
- Supports aligned writes of 4 bytes (32-bits) at a time

37.2.1.5 Cryptographic Services Engine (CSEc) module features

The FTFM module includes support for the SHE (Secure Hardware Extension) specification.

- Secure cryptographic key storage (up to 20 user keys)
- AES-128 encryption and decryption
- AES-128 CMAC (Cipher-based Message Authentication Code) calculation and authentication
- ECB (Electronic Cipher Book) Mode - encryption and decryption
- CBC (Cipher Block Chaining) Mode - encryption and decryption
- True and Pseudo random number generation
- Miyaguchi-Prenell compression function
- Secure Boot Mode (user configurable)
 - Sequential Boot Mode
 - Parallel Boot Mode
 - Strict Sequential Boot Mode (unchangeable once set)

37.2.1.6 Other FTFM module features

- Internal high-voltage supply generator for flash memory program and erase operations

- Optional interrupt generation upon flash and CSEc command completion
- Supports MCU security mechanisms which prevent unauthorized access to the flash memory contents
- ECC logic to correct single-bit faults and detect uncorrectable faults in each NVM flash phrase
- Executes recovery process to handle uncorrectable faults detected during the reset sequence, command operations, and EEPROM emulation

37.2.2 Block diagram

The block diagram of the FTFM module is shown in the following figure.

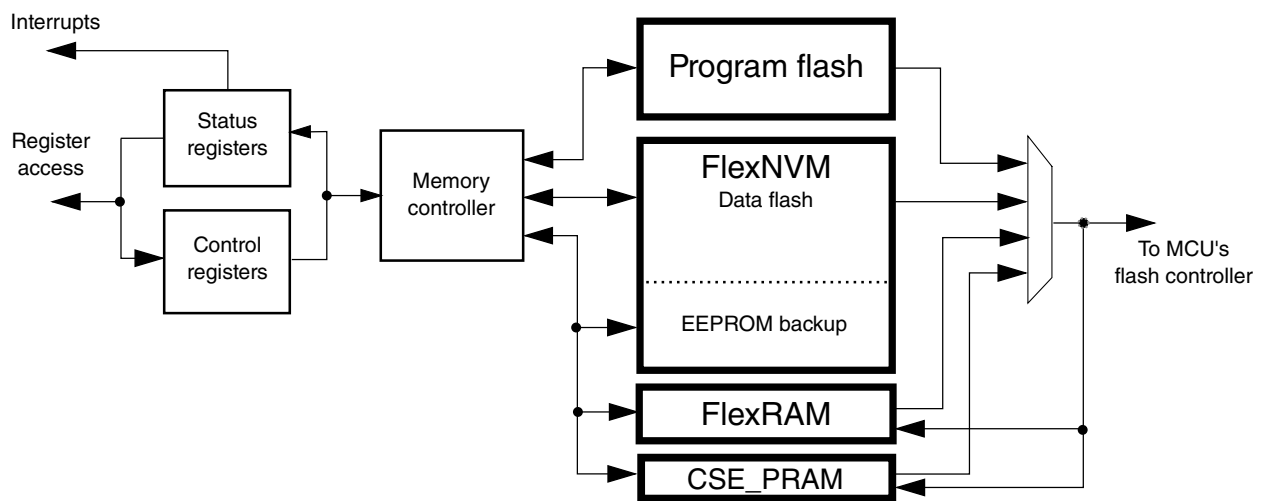

Figure 37-1. FTFM block diagram

37.2.3 Glossary

Command write sequence — A series of MCU writes to the Flash FCCOB register group that initiates and controls the execution of Flash algorithms that are built into the FTFM module.

Cryptographic Services Engine (CSEc) - Feature set for various encryption, decryption and authentication algorithms built to meet the SHE specification. CSEc is a 'compact' version of the CSE module

CSE_PRAM — RAM dedicated to the CSEc Parameter space. Used for all CSEc/SHE command requests and related data input / output.

Data flash memory — Partitioned from the FlexNVM block, the data flash memory provides nonvolatile storage for user data, boot code, and additional code store. Also known as DFlash.

Data flash sector — Smallest portion of the data flash memory that can be erased.

Double-Phrase — 128-bits of data with an aligned double-phrase having byte-address[3:0] == 0000.

EEPROM — Using a built-in filing system, the FTFM module emulates the characteristics of an EEPROM by effectively providing a high-endurance, 4 byte-writeable (program and erase) NVM.

EEPROM backup data header — Consists of a 64-bit field found in emulated EEPROM backup data memory which contains information used by the emulated EEPROM filing system to determine the status of a specific emulated EEPROM backup data sector.

EEPROM backup data record — Data found in emulated EEPROM backup data memory containing status, address, and data fields which are used by the emulated EEPROM filing system.

EEPROM backup data memory — Partitioned from the FlexNVM block, emulated EEPROM backup data memory provides nonvolatile storage for the emulated EEPROM filing system representing data written to the FlexRAM requiring highest endurance. Also known as EFlash and EEPROM backup.

EEPROM backup data sector — Contains one emulated EEPROM backup data header and up to 255 emulated EEPROM backup data records which are used by the emulated EEPROM filing system.

Endurance (cycling) — The number of times that a flash memory location can be erased and reprogrammed.

FCCOB (Flash Common Command Object) — A group of flash registers that are used to pass command, address, data, and any associated parameters to the memory controller in the FTFM module.

Flash block — A macro within the FTFM module which provides the nonvolatile memory storage.

FlexMemory — FTFM configuration that supports data flash, emulated EEPROM, and FlexRAM.

FlexNVM Block — The FlexNVM block can be configured to be used as data flash memory, emulated EEPROM backup data memory, or a combination of both.

FlexRAM — The FlexRAM refers to a RAM, dedicated to the FTFM module, that can be configured to store emulated EEPROM data or as traditional RAM. When configured for emulated EEPROM, a valid write to the FlexRAM generates a new emulated EEPROM backup data record stored in the emulated EEPROM backup data memory.

FTFM Module — All flash blocks plus a flash management unit providing high-level control and an interface to MCU buses.

IFR — Nonvolatile information register found in each flash block, separate from the main memory array.

Longword — 32 bits of data with an aligned longword having byte-address[1:0] = 00.

NVM — Nonvolatile memory. A memory technology that maintains stored data during power-off. The flash array is an NVM using NOR-type flash memory technology.

Phrase — 64 bits of data with an aligned phrase having byte-address[2:0] = 000.

Program flash memory — The program flash memory provides nonvolatile storage for vectors and code store. Also known as PFlash.

Program flash sector — The smallest portion of the program flash memory (consecutive addresses) that can be erased.

RWW— Read-While-Write. The ability to simultaneously read from one memory resource while command operations are active in another memory resource.

Section program buffer — Lower quarter of the FlexRAM allocated for storing large amounts of data for programming via the Program Section command.

Secure — An MCU state conveyed to the FTFM module as described in the Chip Configuration details for this device. In the secure state, reading and changing NVM contents is restricted.

Word — 16 bits of data with an aligned word having byte-address[0] = 0.

37.3 External signal description

The FTFM module contains no signals that connect off-chip.

37.4 Memory map and registers

This section describes the memory map and registers for the FTFM module. Data read from unimplemented memory space in the FTFM module is undefined. Writes to unimplemented or reserved memory space (registers) in the FTFM module are ignored.

37.4.1 Flash configuration field description

The program flash memory contains a 16-byte flash configuration field that stores default protection settings and security information that allows the MCU to restrict access to the FTFM module. The register portion of the flash configuration field is loaded into associated flash registers during the reset sequence.

Flash Configuration Field Offset Address	Size (Bytes)	Field Description
0x0_0400 - 0x0_0407	8	Backdoor Comparison Key. Refer to Verify Backdoor Access Key command and Un-securing the MCU using backdoor key access .
0x0_0408 - 0x0_040B	4	Program flash protection bytes. Refer to the description of the Program Flash Protection Registers (FPROT0-3).
0x0_040F	1	Data flash protection byte. Refer to the description of the Data Flash Protection Register (FDPROT).
0x0_040E	1	EEPROM protection byte. Refer to the description of the EEPROM Protection Register (FEPROT).
0x0_040D	1	Flash nonvolatile option byte. Refer to the description of the Flash Option Register (FOPT).
0x0_040C	1	Flash security byte. Refer to the description of the Flash Security Register (FSEC).

37.4.1.1 Flash configuration field fault handling

For each of the following register sets, if an uncorrectable ECC fault is detected while reading the containing address in the flash configuration field during the reset sequence (assuming no other more serious errors occur), fault recovery will not be taken but the register contents will be modified as follows:

- FSEC register will be loaded with 0xBB and FOPT register will be loaded with 0xFF

- FPROT3 and FPROT2 register will be loaded with all 0's
- FPROT1 and FPROT0 register will be loaded with all 0's
- FDPROT and FEPROT registers will be loaded with all 0's

If an uncorrectable ECC fault is detected while reading the flash configuration field, the MGSTAT0 flag in the FSTAT register will set.

37.4.2 Program flash 0 IFR map

The program flash 0 IFR is a 1 KB nonvolatile information memory, 64 bytes of which can be read, but the user has no erase and limited program capabilities (see [Read Once command](#) and [Program Once command](#)). The contents of the program flash 0 IFR are summarized in the following table and further described in the subsequent paragraph.

The program flash 0 IFR is located within the program flash 0 memory block.

Address Range	Size (Bytes)	Field Description
0x000 – 0x3BF	960	Reserved
0x3C0 – 0x3FF	64	Program Once Field

37.4.2.1 Program Once field

The Program Once field in the program flash 0 IFR provides 64 bytes of user data storage separate from the program flash 0 main array. The user can program the Program Once field one time only as there is no program flash IFR erase mechanism available to the user. The Program Once field can be read any number of times. This section of the program flash 0 IFR is accessed in 8 byte records using the Read Once and Program Once commands (see [Read Once command](#) and [Program Once command](#)).

37.4.3 Data flash 0 IFR map

The data flash 0 IFR is a 1 KB nonvolatile information memory that can be erased, but the user has limited program capabilities in the data flash 0 IFR (see [Erase All Blocks command](#), [Erase All Blocks Unsecure command](#), and [Program Partition command](#)). The contents of the data flash 0 IFR, located within the data flash 0 memory block, are summarized in the following table and further described in the subsequent paragraphs.

Address Range	Size (Bytes)	Field Description
0x00 – 0x3FB	1020	Reserved

Table continues on the next page...

Address Range	Size (Bytes)	Field Description
0x3FC	1	FlexNVM Partition Code (DEPART)
0x3FD	1	EEPROM Data Set Size {1'b1,EEERST,2'b11,EEESIZE}
0x3FE – 0x3FF	2	Reserved

37.4.3.1 EEPROM data set size

The emulated EEPROM data set size byte in the data flash 0 IFR defines the amount of FlexRAM used in the emulated EEPROM subsystem and indicates whether the FlexRAM is loaded with valid emulated EEPROM data during the flash reset sequence. To program the EEERST and EEESIZE values, see [Program Partition command](#). Also see the chip-specific information.

Refer to the SoC SIM (System Integration Module) for access to this information (EEERST, EEESIZE).

37.4.3.2 FlexNVM partition code

The FlexNVM partition code byte in the data flash 0 IFR supplies a code which specifies how to split the FlexNVM block between data flash memory and emulated EEPROM backup data memory supporting emulated EEPROM functions. To program the DEPART value, see [Program Partition command](#). Also see the chip-specific information.

Refer to the SoC SIM (System Integration Module) for access to this information (DEPART).

37.4.4 Register descriptions

The FTFM module contains a set of memory-mapped control and status registers.

NOTE

While a command is running (FSTAT[CCIF]=0), register writes are not accepted to any register except FCNFG, FSTAT, FERCNFG and FERSTAT. The no-write rule is relaxed during the start-up reset sequence, prior to the initial rise of CCIF. During this initialization period the user may write any register. All register writes are also disabled (except for FCNFG, FSTAT, FERCNFG and FERSTAT) whenever an erase suspend request is active (FCNFG[ERSSUSP]=1).

37.4.4.1 FTFM register descriptions

37.4.4.1.1 FTFM memory map

FTFM base address: 4002_0000h

Offset	Register	Width (In bits)	Access	Reset value
0h	Flash Status Register (FSTAT)	8	W1C	Table 37-
1h	Flash Configuration Register (FCNFG)	8	RW	Table 37-
2h	Flash Security Register (FSEC)	8	RO	Table 37-
3h	Flash Option Register (FOPT)	8	RO	Table 37-
4h	Flash Common Command Object Registers (FCCOB3)	8	RW	00h
5h	Flash Common Command Object Registers (FCCOB2)	8	RW	00h
6h	Flash Common Command Object Registers (FCCOB1)	8	RW	00h
7h	Flash Common Command Object Registers (FCCOB0)	8	RW	00h
8h	Flash Common Command Object Registers (FCCOB7)	8	RW	00h
9h	Flash Common Command Object Registers (FCCOB6)	8	RW	00h
Ah	Flash Common Command Object Registers (FCCOB5)	8	RW	00h
Bh	Flash Common Command Object Registers (FCCOB4)	8	RW	00h
Ch	Flash Common Command Object Registers (FCCOBB)	8	RW	00h
Dh	Flash Common Command Object Registers (FCCOBA)	8	RW	00h
Eh	Flash Common Command Object Registers (FCCOB9)	8	RW	00h
Fh	Flash Common Command Object Registers (FCCOB8)	8	RW	00h
10h	Program Flash Protection Registers (FPROT3)	8	RW	Table 37-
11h	Program Flash Protection Registers (FPROT2)	8	RW	Table 37-
12h	Program Flash Protection Registers (FPROT1)	8	RW	Table 37-
13h	Program Flash Protection Registers (FPROT0)	8	RW	Table 37-
16h	EEPROM Protection Register (FEPROT)	8	RW	Table 37-
17h	Data Flash Protection Register (FDPROT)	8	RW	Table 37-
2Ch	Flash CSEc Status Register 1 (FCSESTAT1)	8	RO	00h
2Dh	Flash CSEc Status Register 0 (FCSESTAT0)	8	RO	00h
2Eh	Flash Error Status Register (FERSTAT)	8	W1C	Table 37-1
2Fh	Flash Error Configuration Register (FERCNFG)	8	RW	0Dh

37.4.4.1.2 Flash Status Register (FSTAT)

37.4.4.1.2.1 Offset

Register	Offset
FSTAT	0h

37.4.4.1.2.2 Function

The FSTAT register reports the operational status of the FTFM module.

The CCIF, RDCOLERR, ACCERR, and FPVIOL flags are readable and writable. The MGSTATx flags are read only. The unassigned bits read 0 and are not writable.

NOTE

When set, the ACCERR and FPVIOL error flags prevent the launch of any more flash commands or writes to the FlexRAM (when EEERDY is set) until the error flag is cleared (by writing a one to it).

NOTE

If an uncorrectable ECC fault is detected during the reset sequence or command execution, one of the MGSTAT0/1/2/3 bits may set. When set, the MGSTAT1/2/3 status flags prevent the launch of any flash command (attempt to clear CCIF is ignored) and blocks access to the FlexRAM and CSE_PRAM. When set, the MGSTAT2/3 status flags also block access to the data flash. When set, the MGSTAT3 status flag also blocks access to the program flash.

37.4.4.1.2.3 Diagram

Bits	7	6	5	4	3	2	1	0
R	CCIF	RDCOLERR	ACCERR	FPVIOL	MGSTAT3	MGSTAT2	MGSTAT1	MGSTAT0
W	W1C	W1C	W1C	W1C				
Reset	1	0	0	0	u	u	u	u

37.4.4.1.2.4 Fields

Field	Function
7 CCIF	<p>Command Complete Interrupt Flag</p> <p>The CCIF flag indicates that a flash command, CSEc command, or emulated EEPROM file system operation has completed. The CCIF flag is cleared by writing a 1 to CCIF to launch a command, and CCIF stays low until command completion or command violation. The CCIF flag is also cleared by a successful write to the FlexRAM while enabled for emulated EEPROM, and CCIF stays low until the emulated EEPROM file system has created the associated EEPROM data record. The CCIF flag will also clear upon execution of any CSEc command and will set upon completion.</p> <p>The CCIF bit is reset to 0 but is set to 1 by the flash memory controller at the end of the reset sequence. Depending on how quickly the read occurs after reset release, the user may or may not see the 0 hardware reset value.</p> <p>0b - FTFM command or emulated EEPROM file system operation in progress 1b - FTFM command or emulated EEPROM file system operation has completed</p>
6 RDCOLERR	<p>FTFM Read Collision Error Flag</p> <p>The RDCOLERR error flag indicates that the MCU attempted a read from a flash resource that was being manipulated by a flash or CSEc command while CCIF is clear. Any simultaneous access is detected as a collision error by the block arbitration logic. The read data in this case cannot be guaranteed. The RDCOLERR flag is cleared by writing a 1 to RDCOLERR. Writing a 0 to the RDCOLERR flag has no effect.</p> <p>0b - No collision error detected 1b - Collision error detected</p>
5 ACCERR	<p>Flash Access Error Flag</p> <p>The ACCERR error flag indicates an illegal access has occurred to a flash resource caused by a violation of the command write sequence or issuing an illegal flash command. While ACCERR is set, the CCIF flag cannot be cleared to launch a command. The ACCERR flag is cleared by writing a 1 to ACCERR while CCIF is set. Writing a 0 to the ACCERR flag has no effect.</p> <p>0b - No access error detected 1b - Access error detected</p>
4 FPVIOL	<p>Flash Protection Violation Flag</p> <p>The FPVIOL error flag indicates an attempt was made to program or erase an address in a protected area of program flash or data flash memory during a command write sequence or a write was attempted to a protected area of the FlexRAM while enabled for emulated EEPROM. While FPVIOL is set, the CCIF flag cannot be cleared to launch a command. The FPVIOL flag is cleared by writing a 1 to FPVIOL while CCIF is set. Writing a 0 to the FPVIOL flag has no effect.</p> <p>0b - No protection violation detected 1b - Protection violation detected</p>
3 MGSTAT3	<p>Memory Controller Status Flag 3</p> <p>The MGSTAT3 status flag is set if an uncorrectable ECC fault is detected during the flash reset sequence unless the error occurred while reading the flash configuration field, the FlexNVM EEPROM partition field, or CSEc strict boot firmware.</p> <p>As a status flag, this bit cannot be cleared by the user like the error flags in this register. When the MGSTAT3 flag is set, the flash memory controller has executed a recovery procedure to block access to the program flash memory, data flash memory, FlexRAM, and CSE_PRAM space and will prevent the launch of flash and CSEc commands until after a reset of the flash module.</p> <p>The MGSTAT3 status flag can only be cleared by a reset of the flash module.</p>
2 MGSTAT2	<p>Memory Controller Status Flag 2</p>

Table continues on the next page...

Field	Function
	<p>The MGSTAT2 status flag is set if an uncorrectable ECC fault is detected during emulated EEPROM initialization or CSEc activity.</p> <p>As a status flag, this bit cannot be cleared by the user like the error flags in this register. When the MGSTAT2 flag is set, the flash memory controller has executed a recovery procedure to block access to the data flash memory, FlexRAM, and CSE_PRAM space and will prevent the launch of flash and CSEc commands until after a reset of the flash module.</p> <p>The MGSTAT2 status flag can only be cleared by a reset of the flash module.</p>
1 MGSTAT1	<p>Memory Controller Status Flag 1</p> <p>The MGSTAT1 status flag is set if an uncorrectable ECC fault is detected during execution of a flash command. The flag will also set if the MAC routine failed during the reset sequence or if the reset sequence finished successfully but failed to exit correctly.</p> <p>As a status flag, this bit cannot be cleared by the user like the error flags in this register. When the MGSTAT1 flag is set, the flash memory controller has executed a recovery procedure to block access to the FlexRAM and CSE_PRAM space and will prevent the launch of flash and CSEc commands until after a reset of the flash module.</p> <p>The MGSTAT1 status flag can only be cleared by a reset of the flash module.</p>
0 MGSTAT0	<p>Memory Controller Status Flag 0</p> <p>The MGSTAT0 status flag is set if a verify error is detected during execution of a flash command or an uncorrectable ECC fault is detected during the flash reset sequence while reading the Flash Configuration Field. As a status flag, this bit cannot be cleared by the user like the error flags in this register.</p> <p>The value of the MGSTAT0 status flag is valid only at the end of the reset sequence or flash command execution while CCIF is set. After the launch of any subsequent command, the MGSTAT0 status flag is cleared.</p>

37.4.4.1.3 Flash Configuration Register (FCNFG)

37.4.4.1.3.1 Offset

Register	Offset
FCNFG	1h

37.4.4.1.3.2 Function

The FCNFG register provides information on the current functional state of the FTFM module.

The erase control bits, ERSAREQ and ERSSUSP, have write restrictions. RAMRDY, and EEERDY are read-only status bits. The reset values for the RAMRDY and EEERDY bits are determined during the reset sequence.

37.4.4.1.3.3 Diagram

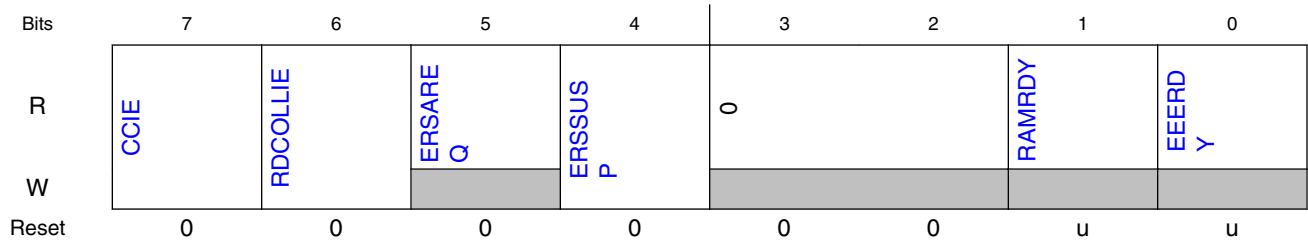

37.4.4.1.3.4 Fields

Field	Function
7 CCIE	<p>Command Complete Interrupt Enable</p> <p>The CCIE bit controls interrupt generation when a flash or CSEc command completes.</p> <p>0b - Command complete interrupt disabled 1b - Command complete interrupt enabled. An interrupt request is generated whenever the FSTAT[CCIF] flag is set.</p>
6 RDCOLLIE	<p>Read Collision Error Interrupt Enable</p> <p>The RDCOLLIE bit controls interrupt generation when an FTFM read collision error occurs.</p> <p>0b - Read collision error interrupt disabled 1b - Read collision error interrupt enabled. An interrupt request is generated whenever an FTFM read collision error is detected (see the description of FSTAT[RDCOLERR]).</p>
5 ERSAREQ	<p>Erase All Request</p> <p>This bit issues a request to the flash memory controller to execute the Erase All Blocks Unsecure command. ERSAREQ is not directly writable but is under indirect user control. Refer to the device's Chip Configuration details on how to request this command.</p> <p>The ERSAREQ bit sets when an erase all request is triggered external to the FTFM and CCIF is set (no command is currently being executed). ERSAREQ is cleared by the FTFM when the operation completes.</p> <p>0b - No request or request complete 1b - Request to run the Erase All Blocks Unsecure command.</p>
4 ERSSUSP	<p>Erase Suspend</p> <p>The ERSSUSP bit allows the user to suspend (interrupt) the Erase Flash Sector command while it is executing.</p> <p>0b - No suspend requested 1b - Suspend the current Erase Flash Sector command execution</p>
3-2 —	Reserved
1 RAMRDY	<p>RAM Ready</p> <p>This flag indicates the current status of the FlexRAM.</p> <p>The state of the RAMRDY flag is normally controlled by the Set FlexRAM Function command. During the reset sequence, the RAMRDY flag is cleared if the FlexNVM block is partitioned for emulated EEPROM with the option to load the FlexRAM during the reset sequence and will be set if the FlexNVM block is not partitioned for emulated EEPROM or if the FlexNVM block is partitioned for emulated EEPROM with the option to not load the FlexRAM during the reset sequence. The RAMRDY flag is cleared if the Program</p>

Table continues on the next page...

Field	Function
	<p>Partition command is run to partition the FlexNVM block for emulated EEPROM. The RAMRDY flag sets after completion of the Erase All Blocks command or the Erase All Blocks Unsecure command or execution of the erase-all operation triggered external to the FTFM.</p> <p>However, if FSTAT[MGSTAT1/2/3] are set, RAMRDY will be clear.</p> <p>0b - FlexRAM is not available for traditional RAM access 1b - FlexRAM is available as traditional RAM only; writes to the FlexRAM do not trigger EEPROM operations</p>
0 EEERDY	<p>EEE Ready</p> <p>This flag indicates if the EEPROM backup data has been copied to the FlexRAM and is therefore available for read access.</p> <p>During the reset sequence, the EEERDY flag remains clear while CCIF=0 and only sets if the FlexNVM block is partitioned for emulated EEPROM.</p> <p>However, if FSTAT[MGSTAT1/2/3] are set, EEERDY will be clear.</p> <p>0b - FlexRAM is not available for emulated EEPROM operation 1b - The FlexRAM is available for EEPROM operations where: (1) reads from the FlexRAM return data previously written to the FlexRAM in emulated EEPROM mode and (2) writes launch an EEPROM operation to store the written data in the FlexRAM and EEPROM backup data memory.</p>

37.4.4.1.4 Flash Security Register (FSEC)

37.4.4.1.4.1 Offset

Register	Offset
FSEC	2h

37.4.4.1.4.2 Function

The FSEC read-only register holds all bits associated with the security of the MCU and FTFM module.

During the reset sequence, the register is loaded with the contents of the flash security byte in the Flash Configuration Field located in program flash memory.

37.4.4.1.4.3 Diagram

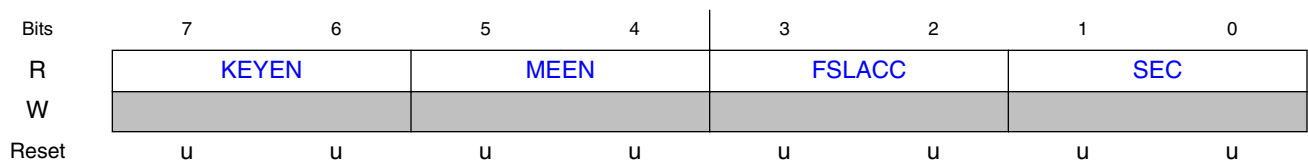

37.4.4.1.4.4 Fields

Field	Function
7-6 KEYEN	<p>Backdoor Key Security Enable</p> <p>These bits enable and disable backdoor key access to the FTFM module.</p> <p>00b - Backdoor key access disabled 01b - Backdoor key access disabled (preferred KEYEN state to disable backdoor key access) 10b - Backdoor key access enabled 11b - Backdoor key access disabled</p>
5-4 MEEN	<p>Mass Erase Enable Bits</p> <p>Enables and disables mass erase capability of the FTFM module. When the SEC field is set to unsecure, the MEEN setting does not matter.</p> <p>00b - Mass erase is enabled 01b - Mass erase is enabled 10b - Mass erase is disabled 11b - Mass erase is enabled</p>
3-2 FSLACC	<p>Factory Failure Analysis Access Code</p> <p>These bits control access to the flash memory contents during returned part failure analysis at the factory. The state of the FSLACC bits is only relevant when the SEC bits are set to secure. When the SEC field is set to unsecure, the FSLACC setting does not matter.</p> <p>When access is denied (SEC is secure and FSLACC is denied), any flash failure analysis performed during factory test must begin with a mass erase, with MEEN in the enabled state, to unsecure the part. In addition, the CSEc commands CMD_DBG_CHAL and CMD_DBG_AUTH are blocked from execution.</p> <p>When access is granted (SEC is unsecure, or SEC is secure and FSLACC is granted), factory testing has visibility of the current flash contents.</p> <p>00b - Factory access granted 01b - Factory access denied 10b - Factory access denied 11b - Factory access granted</p>
1-0 SEC	<p>Flash Security</p> <p>These bits define the security state of the MCU. In the secure state, the MCU limits access to FTFM module resources. The limitations are defined per device and are detailed in the Chip Configuration details. If the FTFM module is unsecured using backdoor key access, the SEC bits are forced to 10b.</p> <p>00b - MCU security status is secure 01b - MCU security status is secure 10b - MCU security status is unsecure (The standard shipping condition of the FTFM is unsecure.) 11b - MCU security status is secure</p>

37.4.4.1.5 Flash Option Register (FOPT)**37.4.4.1.5.1 Offset**

Register	Offset
FOPT	3h

37.4.4.1.5.2 Function

The FOPT read-only register allows the MCU to customize its operations by examining the state of these read-only bits.

During the reset sequence, the register is loaded from the flash nonvolatile option byte in the Flash Configuration Field located in program flash memory.

37.4.4.1.5.3 Diagram

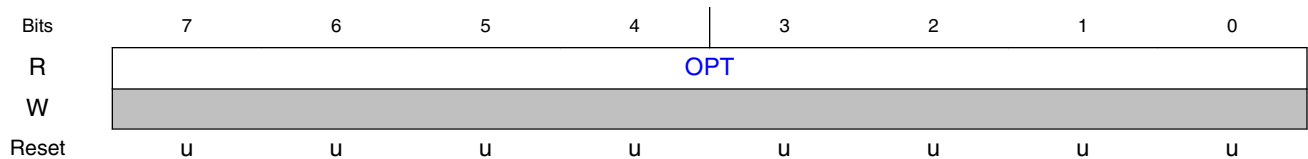

37.4.4.1.5.4 Fields

Field	Function
7-0	Nonvolatile Option
OPT	Refer to the device's Chip Configuration details for the definition and use of these bits.

37.4.4.1.6 Flash Common Command Object Registers (FCCOB0 - FCCOBB)

37.4.4.1.6.1 Offset

Register	Offset
FCCOB3	4h
FCCOB2	5h
FCCOB1	6h
FCCOB0	7h
FCCOB7	8h
FCCOB6	9h
FCCOB5	Ah
FCCOB4	Bh
FCCOBB	Ch
FCCOBA	Dh
FCCOB9	Eh
FCCOB8	Fh

37.4.4.1.6.2 Function

The FCCOB register group provides 12 bytes for command codes and parameters. The individual bytes within the set append a 0-B hex identifier to the FCCOB register name: FCCOB0, FCCOB1, ..., FCCOBB.

37.4.4.1.6.3 Diagram

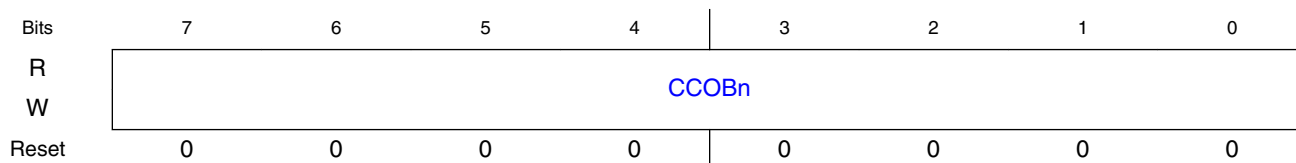

37.4.4.1.6.4 Fields

Field	Function																		
7-0 CCOBn	<p>CCOBn</p> <p>The FCCOB register group provides a command code and relevant parameters to the memory controller. The individual registers that compose the FCCOB register group can be written in any order, but you must provide all needed values, which vary from command to command. First, set up all required FCCOB fields and then initiate the command's execution by writing a 1 to the FSTAT[CCIF] bit. This clears the CCIF bit, which locks all FCCOB parameter fields and they cannot be changed by the user until the command completes (CCIF returns to 1). No command buffering or queueing is provided; the next command can be loaded only after the current command completes.</p> <p>Some commands return information to the FCCOB register group. Any values returned to FCCOB are available for reading after the FSTAT[CCIF] flag returns to 1 by the memory controller.</p> <p>The following table shows a generic FTFM command format. The first FCCOB register, FCCOB0, always contains the command code. This 8-bit value defines the command to be executed. The command code is followed by the parameters required for this specific FTFM command, typically an address and/or data values.</p> <p>NOTE: The command parameter table is written in terms of FCCOB Number (which is equivalent to the byte number). This number is a reference to the FCCOB register name and is not the register address.</p> <table border="1"> <thead> <tr> <th>FCCOB Number</th> <th>Typical Command Parameter Contents [7:0]</th> </tr> </thead> <tbody> <tr> <td>0</td> <td>FCMD (a code that defines the FTFM command)</td> </tr> <tr> <td>1</td> <td>Flash address [23:16]</td> </tr> <tr> <td>2</td> <td>Flash address [15:8]</td> </tr> <tr> <td>3</td> <td>Flash address [7:0]</td> </tr> <tr> <td>4</td> <td>Data Byte 0</td> </tr> <tr> <td>5</td> <td>Data Byte 1</td> </tr> <tr> <td>6</td> <td>Data Byte 2</td> </tr> <tr> <td>7</td> <td>Data Byte 3</td> </tr> </tbody> </table>	FCCOB Number	Typical Command Parameter Contents [7:0]	0	FCMD (a code that defines the FTFM command)	1	Flash address [23:16]	2	Flash address [15:8]	3	Flash address [7:0]	4	Data Byte 0	5	Data Byte 1	6	Data Byte 2	7	Data Byte 3
FCCOB Number	Typical Command Parameter Contents [7:0]																		
0	FCMD (a code that defines the FTFM command)																		
1	Flash address [23:16]																		
2	Flash address [15:8]																		
3	Flash address [7:0]																		
4	Data Byte 0																		
5	Data Byte 1																		
6	Data Byte 2																		
7	Data Byte 3																		

Field	Function	
	FCCOB Number	Typical Command Parameter Contents [7:0]
	8	Data Byte 4
	9	Data Byte 5
	A	Data Byte 6
	B	Data Byte 7
	<p>1. Refers to FCCOB register name, not register address</p> <p>FCCOB Endianness and Multi-Byte Access:</p> <p>The FCCOB register group uses a big endian addressing convention. For all command parameter fields larger than 1 byte, the most significant data resides in the lowest FCCOB register number. The FCCOB register group may be read and written as individual bytes, aligned words (2 bytes) or aligned longwords (4 bytes).</p>	

1. Refers to FCCOB register name, not register address

37.4.4.1.7 Program Flash Protection Registers (FPROT0 - FPROT3)

37.4.4.1.7.1 Offset

Register	Offset
FPROT3	10h
FPROT2	11h
FPROT1	12h
FPROT0	13h

37.4.4.1.7.2 Function

The FPROT registers define which program flash regions are protected from program and erase operations. Protected flash regions cannot have their content changed; that is, these regions cannot be programmed and cannot be erased by any FTFM command (except the Erase All Unsecure command and erase all operation that is triggered external to the FTFM). Unprotected regions can be changed by program and erase operations.

The four FPROT registers allow up to 32 protectable regions of equal memory size. The FPROT register bits are mapped to the protectable regions as follows:

- $region_size = total_program_flash_size / 32$
- Starting from the program flash base address, Region 0 refers to the first $region_size$ bytes, region 1 refers to the next $region_size$ bytes, and so on.

In other words:

- $region_n_start_address = program_flash_base_address + (n) * region_size$
- $region_n_end_address = program_flash_base_address + ((n+1) * region_size) - 1$

For example, if the total program flash size is 512 KB, the *region_size* is 16 KB. If the lowest program flash address is 0x000A_0000, the regions are defined as follows:

Region	Start Address	End Address
0	0x000A_0000	0x000A_3FFF
1	0x000A_4000	0x000A_7FFF
2	0x000A_8000	0x000A_BFFF
3	0x000A_C000	0x000A_FFFF
...
32	0x0011_C000	0x0011_FFFF

- A '0' in an FPROT[PROT] bit indicates its corresponding flash protection region is protected
- A '1' in an FPROT[PROT] bit indicates its corresponding flash protection region is unprotected

Program flash protection register	Program flash protection bits
FPROT0	PROT[31:24]
FPROT1	PROT[23:16]
FPROT2	PROT[15:8]
FPROT3	PROT[7:0]

During the reset sequence, the FPROT registers are loaded with the contents of the program flash protection bytes in the Flash Configuration Field as indicated in the following table.

Program flash protection register	Flash Configuration Field offset address
FPROT0	0x000B
FPROT1	0x000A
FPROT2	0x0009
FPROT3	0x0008

To change the program flash protection that is loaded during the reset sequence, unprotect the sector of program flash memory that contains the Flash Configuration Field. Then, reprogram the program flash protection byte.

37.4.4.1.7.3 Diagram

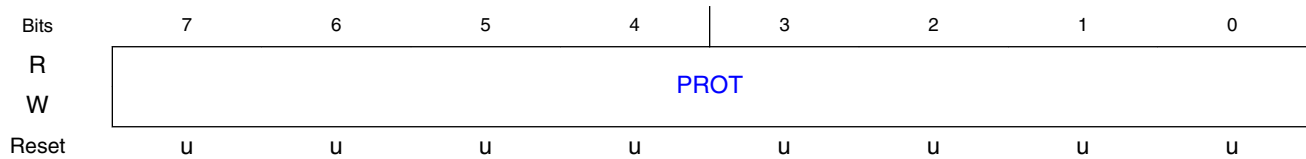

37.4.4.1.7.4 Fields

Field	Function
7-0 PROT	<p>Program Flash Region Protect</p> <p>Each program flash region can be protected from program and erase operations by setting the associated PROT bit to the protected state.</p> <p>The protection can only be increased, meaning that currently unprotected memory can be protected, but currently protected memory cannot be unprotected. Since unprotected regions are marked with a 1 and protected regions use a 0, only writes changing 1s to 0s are accepted. This 1-to-0 transition check is performed on a bit-by-bit basis. Those FPROT bits with 1-to-0 transitions are accepted while all bits with 0-to-1 transitions are ignored.</p> <p>Restriction: The user must never write to any FPROT register while a command is running (CCIF=0). Trying to alter data in any protected area in the program flash memory results in a protection violation error and sets the FSTAT[FPVIOL] bit unless the Erase All Unsecure command is executed or the erase all operation is triggered external to the FTFM. A full block erase of a program flash block is not possible if it contains any protected region.</p>

37.4.4.1.8 EEPROM Protection Register (FEPROT)

37.4.4.1.8.1 Offset

Register	Offset
FEPROT	16h

37.4.4.1.8.2 Function

The FEPROT register defines which emulated EEPROM regions of the FlexRAM are protected against program and erase operations (not including the CSEc DBG_AUTH command). Protected EEPROM regions cannot have their content changed by writing to it. Unprotected regions can be changed by writing to the FlexRAM.

37.4.4.1.8.3 Diagram

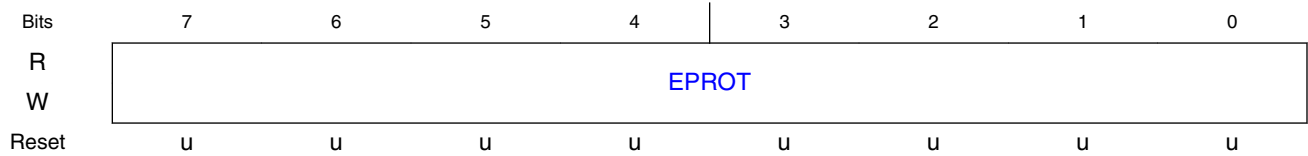

37.4.4.1.8.4 Fields

Field	Function
7-0 EPROM	<p>EEPROM Region Protect</p> <p>Individual emulated EEPROM regions can be protected from alteration by setting the associated EPROM bit to the protected state. The EPROM bits are not used when the FlexNVM Partition Code is set to data flash only. When the FlexNVM Partition Code is set to data flash and EEPROM or EEPROM only, each EPROM bit covers one-eighth of the configured EEPROM data (see the EEPROM Data Set Size parameter description).</p> <p>The protection can only be increased. This means that currently-unprotected memory can be protected, but currently-protected memory cannot be unprotected. Since unprotected regions are marked with a 1 and protected regions use a 0, only writes changing 1s to 0s are accepted. This 1-to-0 transition check is performed on a bit-by-bit basis. Those FEPROT bits with 1-to-0 transitions are accepted while all bits with 0-to-1 transitions are ignored.</p> <p>Restriction: The user must never write to the FEPROT register while a command is running (CCIF=0).</p> <p>During the reset sequence, the FEPROT register is loaded with the contents of the EEPROM protection byte in the Flash Configuration Field located in program flash memory. The flash basis for the reset values is signified by "u" in the register diagram. To change the EEPROM protection that will be loaded during the reset sequence, the sector of program flash that contains the Flash Configuration Field must be unprotected; then erase and reprogram the EEPROM protection byte.</p> <p>Trying to alter data by writing to any protected area in the emulated EEPROM region of the FlexRAM, including execution of the Erase All Blocks command, results in a protection violation error and sets the FSTAT[FPVIOL] bit.</p>

37.4.4.1.9 Data Flash Protection Register (FDPROT)

37.4.4.1.9.1 Offset

Register	Offset
FDPROT	17h

37.4.4.1.9.2 Function

The FDPROT register defines which data flash regions are protected against program and erase operations. Protected Flash regions cannot have their content changed; that is, these regions cannot be programmed and cannot be erased by any FTFM command (except the Erase All Unsecure command or CSEc DBG_AUTH command is executed or the erase all operation which is triggered external to the FTFM). Unprotected regions can be changed by both program and erase operations.

37.4.4.1.9.3 Diagram

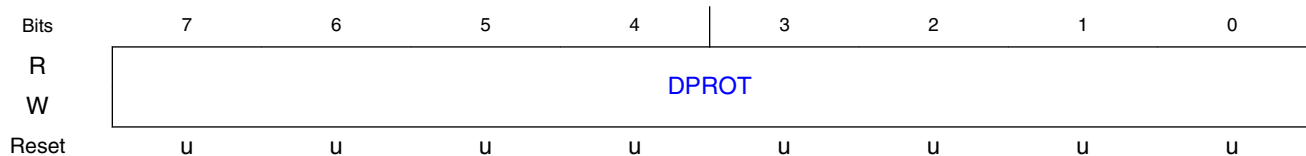

37.4.4.1.9.4 Fields

Field	Function
7-0 DPROT	<p>Data Flash Region Protect</p> <p>Individual data flash regions can be protected from program and erase operations by setting the associated DPROT bit to the protected state. Each DPROT bit protects one-eighth of the partitioned data flash memory space. The granularity of data flash protection cannot be less than the data flash sector size. If an unused DPROT bit is set to the protected state, the Erase All Blocks command does not execute and sets the FSTAT[FPVIOL] bit.</p> <p>The protection can only be increased, meaning that currently unprotected memory can be protected but currently protected memory cannot be unprotected. Since unprotected regions are marked with a 1 and protected regions use a 0, only writes changing 1s to 0s are accepted. This 1-to-0 transition check is performed on a bit-by-bit basis. Those FDPROT bits with 1-to-0 transitions are accepted while all bits with 0-to-1 transitions are ignored.</p> <p>Restriction: The user must never write to the FDPROT register while a command is running (CCIF=0).</p> <p>During the reset sequence, the FDPROT register is loaded with the contents of the data flash protection byte in the Flash Configuration Field located in program flash memory. The flash basis for the reset values is signified by "u" in the register diagram. To change the data flash protection that will be loaded during the reset sequence, unprotect the sector of program flash that contains the Flash Configuration Field; then, erase and reprogram the data flash protection byte.</p> <p>Trying to alter data with the program and erase commands in any protected area in the data flash memory results in a protection violation error and sets the FSTAT[FPVIOL] bit unless the Erase All Unsecure command or CSEc DBG_AUTH command is executed or the erase all operation is triggered external to the FTFM. A block erase of any data flash memory block (see the Erase Flash Block command description) is not possible if the data flash block contains any protected region or if the FlexNVM memory has been partitioned for emulated EEPROM.</p>

37.4.4.1.10 Flash CSEc Status Register 1 (FCSESTAT1)

37.4.4.1.10.1 Offset

Register	Offset
FCSESTAT1	2Ch

37.4.4.1.10.2 Function

The FCSESTAT1 register reports the status of the CSEc cryptographic related feature set operations.

Following is a quick reference mapping CSEc status flags from the FCSESTAT1 register.

Table 37-1. Boot/MAC map to CSEc Status Flags

	SB	BIN	BFN	BOK	Error Code
No Boot Type	0	0	0	0	0
MAC is Empty	1	1	1	0	NO_ERR
MAC Mismatch	1	0	1	0	NO_ERR
MAC Match	1	0	0	1	NO_ERR
MAC_KEY is empty	0	0	1	0	NO_SECURE_BOOT

37.4.4.1.10.3 Diagram

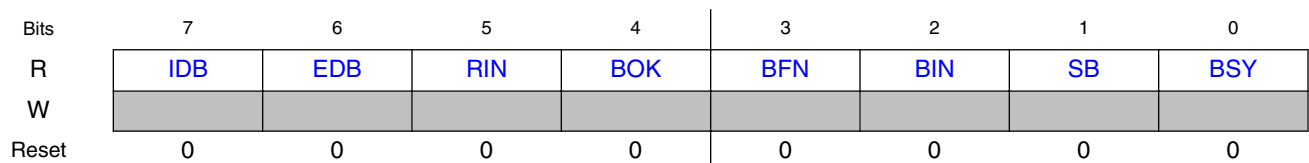

37.4.4.1.10.4 Fields

Field	Function
7 IDB	Internal Debug The IDB bit is set by the DBG_AUTH command when no Flash Keys are stored. It is cleared upon reset and by the LOAD_KEY command. 0b - Internal debug functions are disabled 1b - Internal debugger functions are enabled
6	External Debug

Table continues on the next page...

Field	Function
EDB	The EDB bit is set when the CPU debug port (BDM/JTAG/etc.) is activated. It is cleared upon reset. 0b - External debugger not attached 1b - External debugger is attached
5 RIN	Random Number Generator Initialized The RIN bit is set by the INIT_RNG command. It is cleared upon a POR and by the DBG_AUTH command. 0b - Random number generator is not initialized 1b - Random number generator is initialized
4 BOK	Secure Boot OK The BOK bit is set by the successful completion of the secure boot process. It is cleared upon reset or by the BOOT_FAILURE command. It will remain clear if the BOOT_MAC, BOOT_MAC_KEY, or boot flavor selection is absent. 0b - Secure boot is not complete, or secure boot failure 1b - Secure boot was successful
3 BFN	Secure Boot Finished The BFN bit is set by the following events assuming the boot flavor is configured as sequential, parallel or strict: <ul style="list-style-type: none"> • Completion of BOOT_FAILURE or BOOT_OK commands • BOOT_MAC_KEY is not present • Secure boot process when the BIN bit is set • BOOT_MAC value does not match • Fault recovery taken during sequential or parallel boot process prior to the BOK bit being set • Error has been encountered It is cleared upon reset. 0b - Secure Boot is not finished 1b - Secure Boot has finished
2 BIN	Secure Boot Initialization The BIN bit is set by the secure boot process if the BOOT_MAC memory slot is empty. It is cleared upon reset. Assumes BOOT_MAC_KEY is present. (autonomous boot per SHE section 10.3) 0b - Secure boot personalization not completed 1b - Secure boot personalization has completed
1 SB	Secure Boot The SB bit is set by the secure boot process if the BOOT_MAC_KEY slot is not empty. It is cleared upon reset. Assumes secure boot flavor is configured (sequential, parallel or strict). 0b - Secure boot not activated 1b - Secure boot is activated
0 BSY	Busy The BSY bit is set when a CSEc command is issued. It is cleared when the command process has completed. 0b - CSEc command processing has completed 1b - CSEc command processing is in progress

37.4.4.1.11 Flash CSEc Status Register 0 (FCSESTAT0)

37.4.4.1.11.1 Offset

Register	Offset
FCSESTAT0	2Dh

37.4.4.1.11.2 Function

The FCSESTAT0 register reports additional status of the CSEc cryptographic related feature set operations.

37.4.4.1.11.3 Diagram

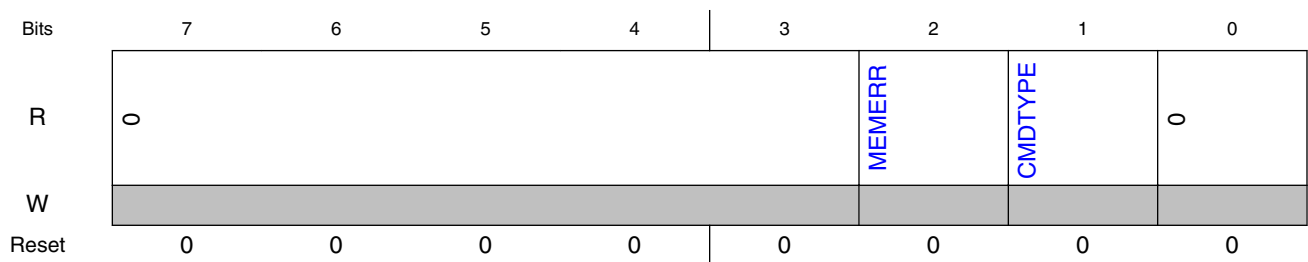

37.4.4.1.11.4 Fields

Field	Function
7-3 —	Reserved
2 MEMERR	<p>Memory Error</p> <p>The MEMERR bit indicates whether an uncorrectable ECC fault was detected during a CSEc operation which blocks access to the CSE_PRAM.</p> <p>0b - Uncorrectable ECC fault not detected, CSE_PRAM access not blocked 1b - Uncorrectable ECC fault detected, CSE_PRAM access blocked</p>
1 CMDTYPE	<p>Command Type</p> <p>The CMDTYPE bit indicates the type of command that was last executed by the flash module.</p> <p>0b - Flash command or no command 1b - CSEc command</p>
0 —	Reserved

37.4.4.1.12 Flash Error Status Register (FERSTAT)

37.4.4.1.12.1 Offset

Register	Offset
FERSTAT	2Eh

37.4.4.1.12.2 Function

The FERSTAT register reports the detection of uncorrected ECC faults during read access of the flash memory and RAMs in the FTFM module.

The assigned bits are readable and writable. The unassigned bits read 0 and are not writable.

37.4.4.1.12.3 Diagram

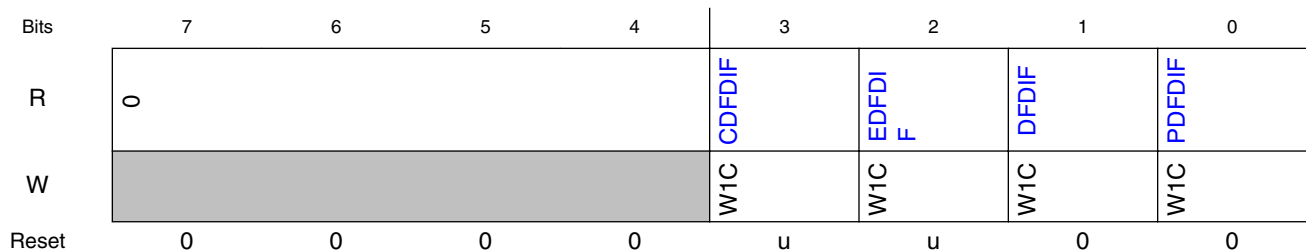

37.4.4.1.12.4 Fields

Field	Function
7-4 —	Reserved
3 CDFDIF	<p>Controller Flash Double Bit Fault Detect Interrupt Flag</p> <p>The CDFDIF flag indicates an uncorrectable ECC fault was detected during a valid internal RAM or flash read access from the flash memory controller. The CDFDIF flag is cleared by writing a 1 to CDFDIF. Writing a 0 to CDFDIF has no effect.</p> <p>0b - Fault not detected during a valid internal RAM or flash read access from the flash memory controller 1b - Fault detected (or FERCNFG[CFDFD] is set) during a valid internal RAM or flash read access from the flash memory controller</p>
2 EDFDIF	<p>Controller FlexRAM Double Bit Fault Detect Interrupt Flag</p> <p>The EDFDIF flag indicates an uncorrectable ECC fault was detected during a valid FlexRAM or CSE_PRAM read access from the flash memory controller. The EDFDIF flag is cleared by writing a 1 to EDFDIF. Writing a 0 to EDFDIF has no effect.</p> <p>0b - Fault not detected during a valid FlexRAM or CSE_PRAM read access from the flash memory controller</p>

Table continues on the next page...

Memory map and registers

Field	Function
	1b - Fault detected (or FERCNFG[EFDFD] is set) during a valid FlexRAM or CSE_PRAM read access from the flash memory controller
1 DFDIF	Platform Flash Double Bit Fault Detect Interrupt Flag The DFDIF flag indicates an uncorrectable ECC fault was detected during a valid flash read access from the platform flash controller. The DFDIF flag is cleared by writing a 1 to DFDIF. Writing a 0 to DFDIF has no effect. 0b - Fault not detected during a valid flash read access from the platform flash controller 1b - Fault detected (or FERCNFG[FDFD] is set) during a valid flash read access from the platform flash controller
0 PDFDIF	Platform FlexRAM Double Bit Fault Detect Interrupt Flag The PDFDIF flag indicates an uncorrectable ECC fault was detected during a valid FlexRAM or CSE_PRAM read access from the platform flash controller. The PDFDIF flag is cleared by writing a 1 to PDFDIF. Writing a 0 to PDFDIF has no effect. 0b - Fault not detected during a valid FlexRAM or CSE_PRAM read access from the platform flash controller 1b - Fault detected (or FERCNFG[PFDFD] is set) during a valid FlexRAM or CSE_PRAM read access from the platform flash controller

37.4.4.1.13 Flash Error Configuration Register (FERCNFG)

37.4.4.1.13.1 Offset

Register	Offset
FERCNFG	2Fh

37.4.4.1.13.2 Function

The FERCNFG register enables the force and interrupt of uncorrected ECC faults detected during read access of the flash memory and RAMs accessed by the FTFM module.

All assigned bits are readable and writable. The unassigned bits read 0 and are not writable. Setting the CFDFD or EFDFD force bits while a command is executing will force the operation to exit on the next event that matches the access type as if that event resulted in the detection of an uncorrectable ECC fault. Due to the variability in the command execution thread, the matching event may not occur depending on when the CFDFD or EFDFD force bits are set.

37.4.4.1.13.3 Diagram

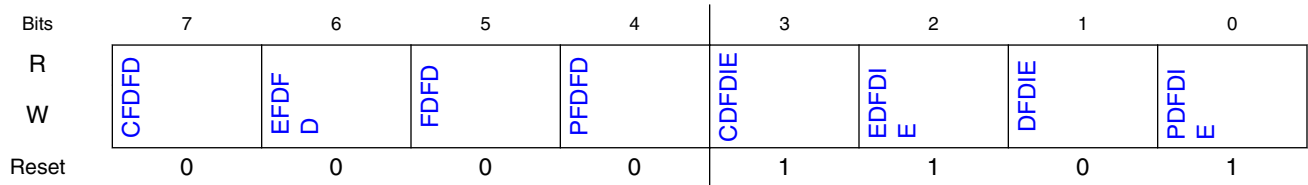

37.4.4.1.13.4 Fields

Field	Function
7 CFDFD	<p>Controller Flash Force Double Bit Fault Detect</p> <p>The CFDFD bit enables the user to emulate the setting of the FERSTAT[CFDFDIF] flag to check the associated interrupt routine. The CFDFD bit is cleared by writing a 0 to CFDFD.</p> <p>0b - FERSTAT[CFDFDIF] sets only if a fault is detected during a valid internal RAM or flash read access from the flash memory controller 1b - FERSTAT[CFDFDIF] sets during the next internal RAM or flash read access from the flash memory controller. An interrupt request is generated if the CDFDIE bit is set.</p>
6 EFD _D FD	<p>Controller FlexRAM Force Double Bit Fault Detect</p> <p>The EFD_DFD bit enables the user to emulate the setting of the FERSTAT[EDFDIF] flag to check the associated interrupt routine. The EFD_DFD bit is cleared by writing a 0 to EFD_DFD.</p> <p>0b - FERSTAT[EDFDIF] sets only if a fault is detected during a valid FlexRAM or CSE_PRAM read access from the flash memory controller 1b - FERSTAT[EDFDIF] sets during the next FlexRAM or CSE_PRAM read access from the flash memory controller. An interrupt request is generated if the EDFDIE bit is set.</p>
5 FDFD	<p>Force Double Bit Fault Detect</p> <p>The FDFD bit enables the user to emulate the setting of the FERSTAT[DFDIF] flag to check the associated interrupt routine. The FDFD bit is cleared by writing a 0 to FDFD.</p> <p>0b - FERSTAT[DFDIF] sets only if a fault is detected during a valid flash read access from the platform flash controller 1b - FERSTAT[DFDIF] sets during any valid flash read access from the platform flash controller. An interrupt request is generated if the DFDIE bit is set.</p>
4 PFD _D FD	<p>Platform FlexRAM Force Double Bit Fault Detect</p> <p>The PFD_DFD bit enables the user to emulate the setting of the FERSTAT[PDFDIF] flag to check the associated interrupt routine. The PFD_DFD bit is cleared by writing a 0 to PFD_DFD.</p> <p>0b - FERSTAT[PDFDIF] sets only if a fault is detected during a valid FlexRAM or CSE_PRAM read access from the platform flash controller 1b - FERSTAT[PDFDIF] sets during any valid FlexRAM or CSE_PRAM read access from the platform flash controller. An interrupt request is generated if the PDFDIE bit is set.</p>
3 CDFDIE	<p>Controller Flash Double Bit Fault Detect Interrupt Enable</p> <p>The CDFDIE bit controls interrupt generation when an uncorrectable ECC fault is detected during a valid internal RAM or flash read access from the flash memory controller.</p> <p>0b - Fault detect interrupt disabled 1b - Fault detect interrupt enabled. An interrupt request is generated whenever the FERSTAT[CFDFDIF] flag is set.</p>
2	Controller FlexRAM Double Bit Fault Detect Interrupt Enable

Table continues on the next page...

Functional description

Field	Function
EDFDIE	The EDFDIE bit controls interrupt generation when an uncorrectable ECC fault is detected during a valid FlexRAM or CSE_PRAM read access from the flash memory controller. 0b - Fault detect interrupt disabled 1b - Fault detect interrupt enabled. An interrupt request is generated whenever the FERSTAT[EDFDIF] flag is set.
1 DFDIE	Platform Flash Double Bit Fault Detect Interrupt Enable The DFDIE bit controls interrupt generation when an uncorrectable ECC fault is detected during a valid flash read access from the platform flash controller. 0b - Fault detect interrupt disabled 1b - Fault detect interrupt enabled. An interrupt request is generated whenever the FERSTAT[DFDIF] flag is set.
0 PDFDIE	Platform FlexRAM Double Bit Fault Detect Interrupt Enable The PDFDIE bit controls interrupt generation when an uncorrectable ECC fault is detected during a valid FlexRAM or CSE_PRAM read access from the platform RAM controller. 0b - Fault detect interrupt disabled 1b - Fault detect interrupt enabled. An interrupt request is generated whenever the FERSTAT[PDFDIF] flag is set.

37.5 Functional description

The following sections describe functional details of the FTFM module.

37.5.1 Flash protection

Individual regions within the flash memory can be protected from program and erase operations. Protection is controlled by the following registers:

- $FPROT_n$ — Four registers protect 32 regions of the program flash memory as shown in the following figure

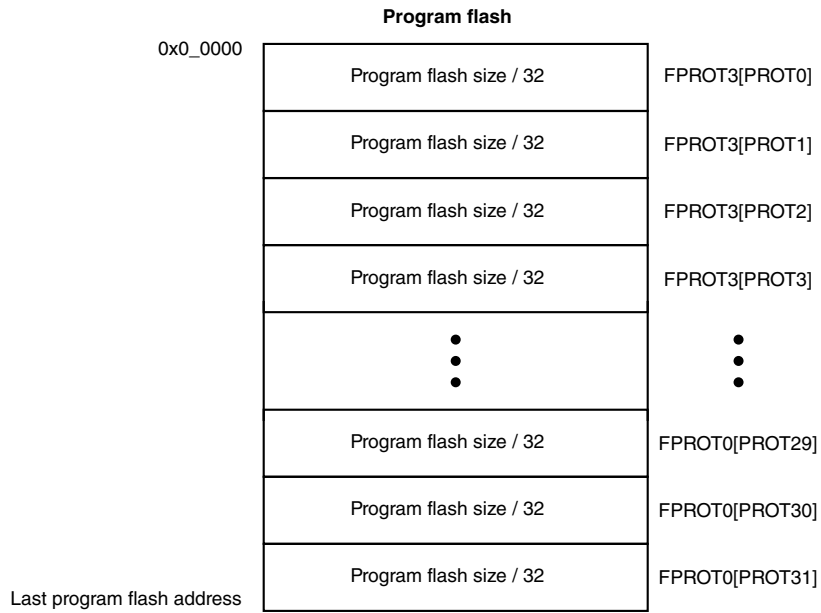

Figure 37-2. Program flash protection

- **FDPROT** — Protects eight regions of the data flash memory as shown in the following figure

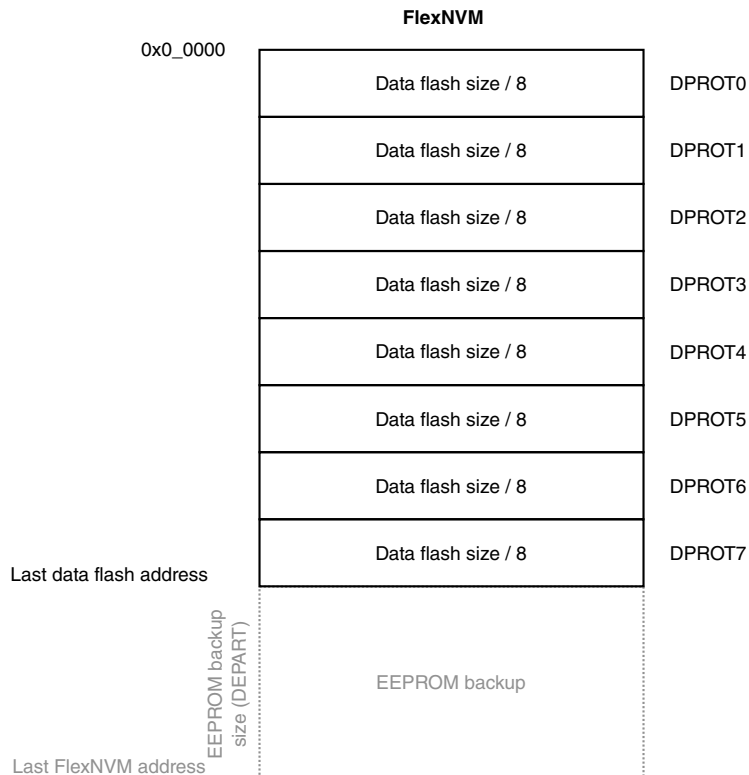

Figure 37-3. Data flash protection

- **FEPROT** — Protects eight regions of the emulated EEPROM memory as shown in the following figure

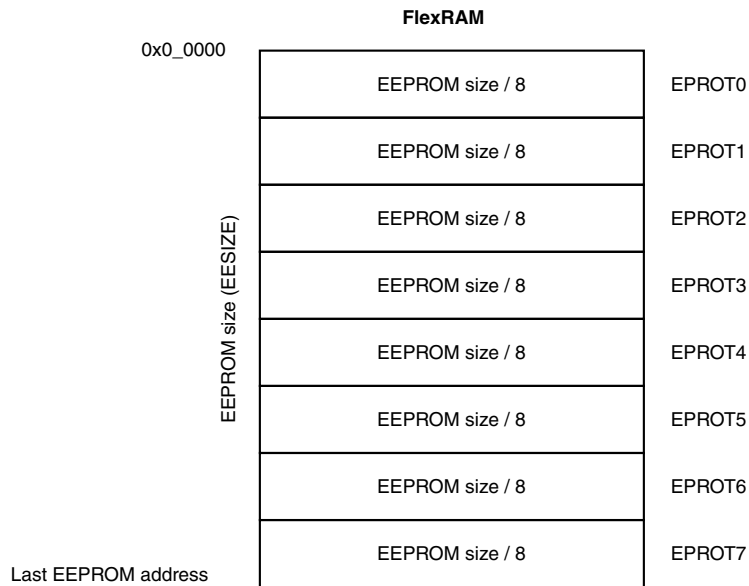

Figure 37-4. EEPROM protection

37.5.2 FlexMemory description

This section describes the FlexMemory features.

37.5.2.1 FlexNVM block partitioning for FlexRAM

The user can configure the FlexNVM block as:

- Basic data flash,
- EEPROM flash records to support the built-in emulated EEPROM feature, or
- A combination of both.

When using the CSEc feature set, the emulated EEPROM feature must be selected (EEPROM-backup size must be greater than 0).

The user's FlexNVM configuration choice is specified using the [Program Partition command](#).

CAUTION

While different partitions of the FlexNVM block are available, the intention is that a single partition choice is used throughout the entire lifetime of a given application. The FlexNVM partition code choices affect the endurance and data retention characteristics of the device.

37.5.2.2 EEPROM user perspective

The following figure shows the emulated EEPROM system. To handle varying customer requirements, the FlexRAM and FlexNVM blocks can be split into partitions as shown.

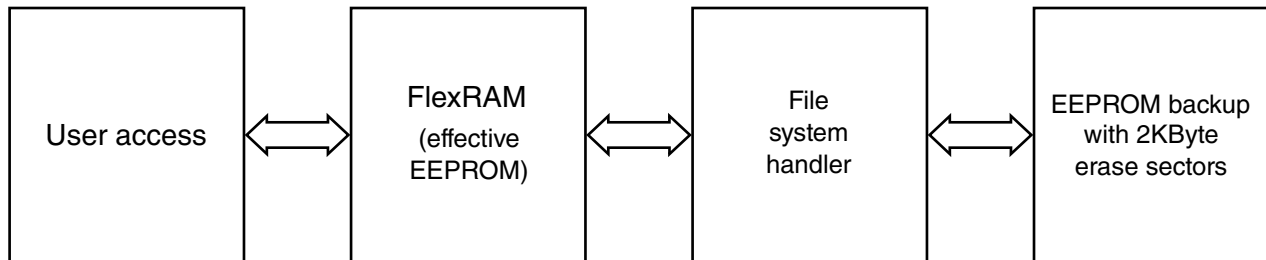

Figure 37-5. Top-level emulated EEPROM architecture

1. **EEPROM partition (EEESIZE)** — The amount of FlexRAM used for emulated EEPROM and CSEc keys can be set to either 0 Bytes (no EEPROM), or to the maximum FlexRAM size. The emulated EEPROM partition is located at the bottom of the FlexRAM address space with the CSEc keys at the top. Utilizing less FlexRAM space will increase the ratio of RAM to NVM, thus increasing the w/e cycle endurance. For FlexRAM usage other than EEPROM (see [Set FlexRAM Function command](#)).
2. **Data flash partition (DEPART)** — The amount of FlexNVM memory used for data flash can be programmed from 0 bytes (all of the FlexNVM block is available for emulated EEPROM backup) to the maximum size of the FlexNVM block.
3. **FlexNVM EEPROM partition** — The amount of FlexNVM memory used for emulated EEPROM backup (see [Block diagram](#)) and CSEc keys. In order to achieve specified w/e cycle endurance, the emulated EEPROM backup size must be at least 16 times the portion of the FlexRAM utilized for emulated EEPROM. The FlexNVM may be split according to the Program Partition command, allowing for part EFlash and part DFlash. For example a 64kB FlexNVM could be partitioned for 32kB EFlash and 32kB DFlash. To maintain the full specified w/e cycle endurance in the emulated EEPROM system, the number of bytes utilized in FlexRAM should be limited to maintain the 1:16 ratio of RAM to NVM. The management of this ratio is left to the user.

The partition information, including EEESIZE and DEPART, is stored in the data flash IFR and is programmed using the [Program Partition command](#)). Typically, the Program Partition command is executed only once in the lifetime of the device.

Data flash memory is useful for applications that need to quickly store large amounts of data or store data that is static. The emulated EEPROM partition in FlexRAM is useful for storing smaller amounts of data that will be changed often.

37.5.2.3 EEPROM implementation overview

Out of reset with the FSTAT[CCIF] bit clear, the partition settings for EEESIZE and DEPART are read from the data flash IFR and the emulated EEPROM file system is initialized unless optionally delayed. The emulated EEPROM file system locates all valid EEPROM data records in EEPROM backup and copies the newest data to the FlexRAM. The FSTAT[CCIF] and FCNFG[EEERDY] bits are set after data from all valid EEPROM data records is copied to the FlexRAM. After the CCIF bit is set, the FlexRAM is available for read or write access.

When configured for emulated EEPROM use, 32-bit aligned writes to an unprotected location in the FlexRAM invokes the emulated EEPROM file system to program a new EEPROM data record in the emulated EEPROM backup data memory in a round-robin fashion. As needed, the emulated EEPROM file system identifies the emulated EEPROM backup sector that is being erased for future use and partially erases that emulated EEPROM backup sector. After a write to the FlexRAM, the FlexRAM is not accessible until the FSTAT[CCIF] bit is set. The FCNFG[EEERDY] bit will also be set. If enabled, the interrupt associated with the FSTAT[CCIF] bit can be used to determine when the FlexRAM is available for read or write access. 8-bit and 16-bit writes to the FlexRAM generate a transfer error

After a sector in emulated EEPROM backup is full of EEPROM data records, EEPROM data records from the sector holding the oldest data are gradually copied over to a previously-erased emulated EEPROM backup sector. When the sector copy completes, the emulated EEPROM backup sector holding the oldest data is tagged for erase.

CAUTION

Interrupting an emulated EEPROM operation (due to power loss, reset, supplies out of specified operational ranges, or any other reasons) will leave the contents in an indeterminate state. The user must take appropriate counter measures to prevent data loss in case of an interrupted emulated EEPROM operation.

37.5.2.4 Write endurance to FlexRAM for emulated EEPROM

When the FlexNVM partition code is not set to full data flash, the emulated EEPROM data set size should be set to the non-zero value.

The bytes not assigned to data flash via the FlexNVM partition code are used by the FTFM to obtain an effective endurance increase for the EEPROM data. The built-in emulated EEPROM record management system raises the number of program/erase cycles that can be attained prior to device wear-out by cycling the EEPROM data through a larger emulated EEPROM NVM storage space.

While different partitions of the FlexNVM are available, the intention is that a single choice for the FlexNVM partition code and emulated EEPROM data set size is used throughout the entire lifetime of a given application.

Normal emulated EEPROM writes and quick writes to FlexRAM should not be used in an aggressive brownout environment (e.g., multiple back-to-back brownouts without recovery in between).

37.5.2.5 ECC implementation for FlexNVM

When the FlexNVM region is configured as data flash, single-bit ECC faults are automatically corrected, and uncorrectable ECC faults are reflected onto the FERSTAT[DFDIF] flag at the read access from data flash.

When a FlexNVM region is configured as emulated EEPROM, single-bit ECC faults are automatically corrected before copying data into the FlexRAM from emulated EEPROM while uncorrectable ECC faults on valid emulated EEPROM records containing data that need to be copied to the FlexRAM result in the corresponding data in the FlexRAM being left alone.

37.5.2.5.1 Emulated EEPROM fault handling

The flash memory controller handles all emulated EEPROM activities initiated by a write to the FlexRAM while EEERDY is set. The executable code for the controller is mainly stored in dedicated flash firmware space and is supported by a dedicated RAM.

Emulated EEPROM activities will terminate after experiencing certain uncorrectable ECC faults during firmware execution and crucial data transfers. Flags in both the FSTAT and FERSTAT registers will reflect the fault condition and the corresponding interrupt will be asserted, if enabled in the FERCNFG register. See the FSTAT flag descriptions to determine the impact of the fault on flash resource availability. If accessible, the contents of the FlexRAM will reflect the value of the last EEPROM backup record read without an uncorrectable ECC fault or the FlexRAM location will be marked as erased.

The impact of uncorrectable ECC faults detected during emulated EEPROM activities is shown in the following table.

Functional description

- Any fault detected while the controller is accessing the FlexRAM or internal RAM during emulated EEPROM activity will block user access to the FlexRAM, CSE_PRAM and the flash memory controller. The FSTAT[MGSTAT1] flag will set and the FERSTAT[EDFDIF] or FERSTAT[CDFDIF] flag will set along with a corresponding interrupt, if enabled.

Table 37-2. Emulated EEPROM Fault Handling

Condition (when uncorrectable ECC fault is detected during emulated EEPROM activity)	FSTAT Flag	FERSTAT Flag
While reading controller executable code	MGSTAT1	CDFDIF
While reading the FlexRAM	MGSTAT1	EDFDIF

37.5.3 Interrupts

The FTFM module can generate interrupt requests to the MCU upon the occurrence of various FTFM events. These interrupt events and their associated status and control bits are shown in the following table.

Table 37-3. FTFM interrupt sources

FTFM Event	Readable Status Bit	Interrupt Enable Bit
Flash or CSEc Command Complete	FSTAT[CCIF]	FCNFG[CCIE]
Flash Read Collision Error	FSTAT[RDCOLERR]	FCNFG[RDCOLLIE]
Platform Flash ECC Fault Detection	FERSTAT[DFDIF]	FERCNFG[DFDIE]
Platform FlexRAM ECC Fault Detection	FERSTAT[PDFDIF]	FERCNFG[PDFDIE]
Flash Controller FlexRAM ECC Fault Detection	FERSTAT[EDFDIF]	FERCNFG[EDFDIE]
Flash Controller Internal RAM/Flash ECC Fault Detection	FERSTAT[CDFDIF]	FERCNFG[CDFDIE]

Note

Vector addresses and their relative interrupt priority are determined at the MCU level.

37.5.4 Flash operation in low-power modes

37.5.4.1 Wait mode

When the MCU enters wait mode, the FTFM module is not affected. The FTFM module can recover the MCU from wait via the command complete interrupt (see [Interrupts](#)).

37.5.4.2 Stop mode

When the MCU requests stop mode, if an FTFM command is active (CCIF = 0) the command execution completes before the MCU is allowed to enter stop mode.

CAUTION

The MCU should never enter stop mode while any FTFM command is running (CCIF = 0).

NOTE

While the MCU is in very-low-power modes (VLPR, VLPW, VLPS), the FTFM module does not accept flash commands.

37.5.5 Flash memory reads and ignored writes

The FTFM module requires only the flash address to execute a flash memory read. MCU read access is available to all flash memory.

The MCU must not read from the flash memory while commands are running (as evidenced by CCIF=0) on that block. Read data cannot be guaranteed from a flash block while any command is processing within that block. The block arbitration logic detects any simultaneous access and reports this as a read collision error (see the FSTAT[RDCOLERR] bit).

37.5.6 Read while write (RWW)

The following simultaneous accesses are allowed for devices with FlexNVM:

- The user may read from program flash memory while commands (typically program and erase operations) are active in the data flash and FlexRAM memory space.
- The MCU can fetch instructions from program flash during both data flash program and erase operations and while emulated EEPROM backup data memory is maintained by the EEPROM system.
- Conversely, the user may read from data flash, FlexRAM, and CSE_PRAM space while program and erase commands are executing on the program flash.
- When configured as traditional RAM, writes to the FlexRAM are allowed during data flash operations.

Simultaneous data flash operations and FlexRAM or CSE_PRAM writes are not possible when FlexRAM is used for emulated EEPROM.

Simultaneous operations are further discussed in [Allowed simultaneous flash operations](#).

37.5.7 Flash program and erase

All flash functions except read require the user to setup and launch a flash command through a series of peripheral bus writes. The user cannot initiate any further FTFM commands until notified that the current command has completed. The FTFM command structure and operation are detailed in [Flash command operations](#).

CAUTION

Interrupting a program or erase operation (due to power loss, reset, supplies out of specified operational ranges, or any other reasons) will leave the contents in an indeterminate state. The user must take appropriate counter measures to prevent data loss in case of an interrupted program or erase operation.

37.5.8 Flash command operations

Flash command (not related to CSEc) operations are typically used to modify flash memory contents. The next sections describe:

- The command write sequence used to set flash command parameters and launch execution
- A brief description of all flash commands available
- Details of margin read commands

NOTE

1. For CSEc/SHE commands, refer to [Cryptographic Services Engine \(CSEc\)](#).
2. Warning: When running any flash command such as ERSALL that changes the flash configuration content, care must be taken with re-programming the configuration information prior to reset. Otherwise, the part may get locked up.

37.5.8.1 Command write sequence

Flash commands are specified using a command write sequence illustrated in [Figure 37-6](#). The FTFM module performs various checks on the command (FCCOB) content and continues with command execution if all requirements are fulfilled.

Before launching a command, the ACCERR and FPVIOL bits in the FSTAT register must be zero and the CCIF flag must read 1 to verify that any previous command has completed. If CCIF is zero, the previous command execution is still active, a new command write sequence cannot be started, and all writes to the FCCOB registers are ignored.

Attempts to launch a flash command in VLP mode will be ignored.

37.5.8.1.1 Load the FCCOB registers

The user must load the FCCOB registers with all parameters required by the desired flash command. The individual registers that make up the FCCOB register group can be written in any order. The user must be sure to provide all of the required parameters which may vary from command to command.

37.5.8.1.2 Launch the command by clearing CCIF

Once all relevant command parameters have been loaded, the user launches the command by clearing the FSTAT[CCIF] bit by writing a '1' to it. The CCIF flag remains zero until the FTFM command completes.

The FSTAT register contains a blocking mechanism which prevents a new command from launching (cannot clear CCIF) if the previous command resulted in an access error (FSTAT[ACCERR]=1) or a protection violation (FSTAT[FPVIOL]=1). In error scenarios, two writes to FSTAT are required to initiate the next command: the first write clears the error flags, the second write clears CCIF.

37.5.8.1.3 Command execution and error reporting

The command processing has several steps:

1. The flash memory controller reads the command code and performs a series of parameter checks and protection checks, if applicable, which are unique to each command.

Functional description

If the parameter check fails, the FSTAT[ACCERR] (access error) flag is set. ACCERR reports invalid instruction codes and out-of bounds addresses. Usually, access errors suggest that the command was not set-up with valid parameters in the FCCOB register group.

Program and erase commands also check the address to determine if the operation is requested to execute on protected areas. If the protection check fails, the FSTAT[FPVIOL] (protection error) flag is set.

Command processing never proceeds to execution when the parameter or protection step fails. Instead, command processing is terminated after setting the FSTAT[CCIF] flag.

2. If the parameter and protection checks pass, the command proceeds to execution. Run-time errors, such as failure to erase verify, may occur during the execution phase. Run-time errors are reported in the FSTAT[MGSTAT0] flag. A command may have access errors, protection errors, and run-time errors, but the run-time errors are not seen until all access and protection errors have been corrected.
3. Command execution results, if applicable, are reported back to the user via the FCCOB and FSTAT registers.
4. The flash memory controller sets the FSTAT[CCIF] flag signifying that the command has completed.

The flow for a generic command write sequence is illustrated in the following figure.

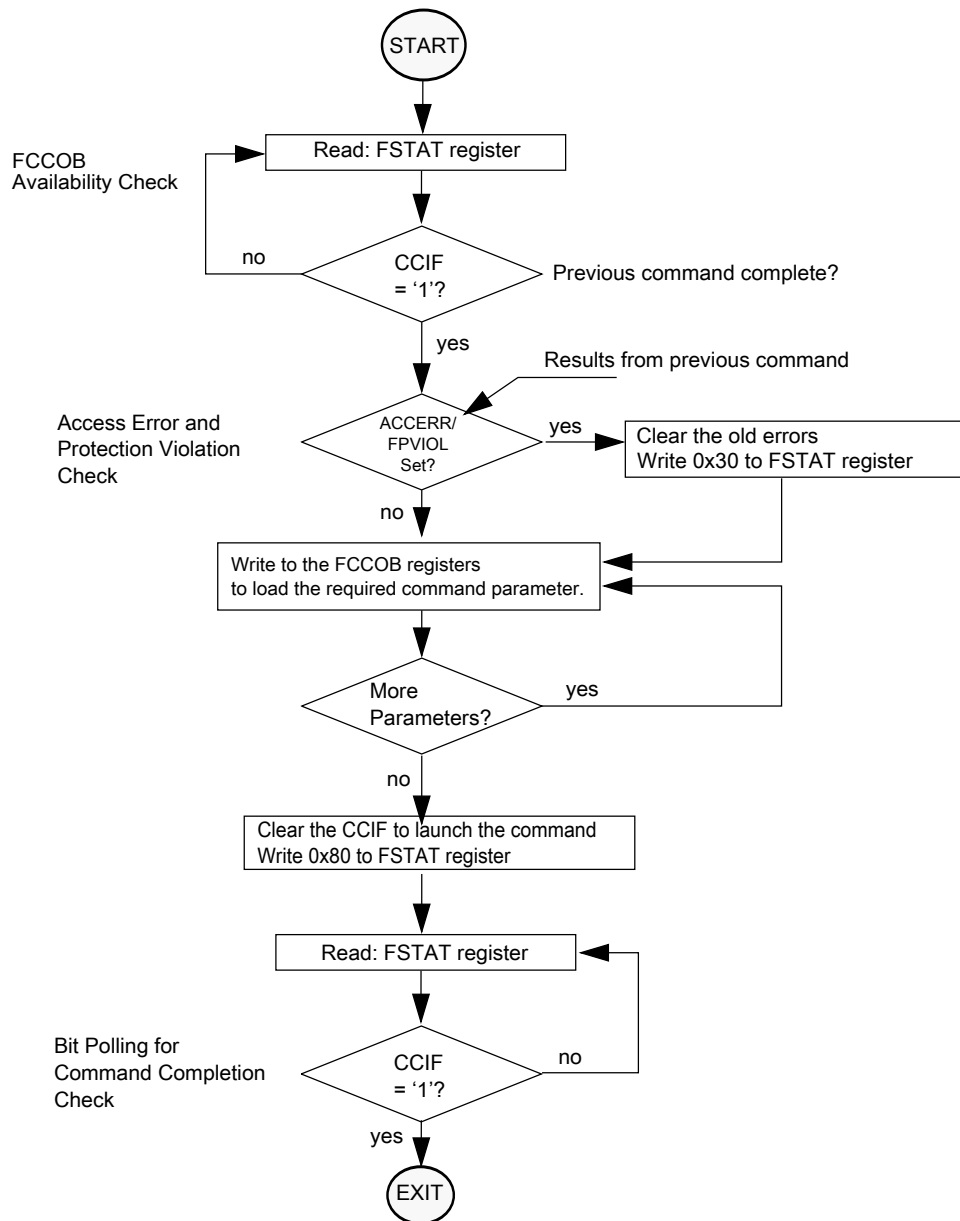

Figure 37-6. Generic flash command write sequence flowchart

37.5.8.1.4 Flash command fault handling

The flash memory controller handles all activity related to the execution of flash commands. The executable code for the controller is mainly stored in dedicated flash firmware space and is supported by a dedicated RAM.

Command execution will terminate after experiencing certain uncorrectable ECC faults during firmware execution and crucial data transfers. Flags in both the FSTAT and FERSTAT registers will reflect the fault condition and the corresponding interrupt will be asserted, if enabled in the FERCNFG register. See the FSTAT flag descriptions to determine the impact of the fault on flash resource availability.

Functional description

The handling of uncorrectable ECC faults detected during flash command operations is shown in the following table.

Table 37-4. Flash Command Fault Handling

Condition (when uncorrectable ECC fault is detected during flash command operation)	FSTAT Flag	FERSTAT Flag
While verifying flash contents	MGSTAT0	
While reading controller executable code	MGSTAT1	CDFDIF
While reading the FlexRAM	MGSTAT1	EDFDIF

37.5.8.2 Flash commands

The following table summarizes the function of all flash commands. If any column is marked with an 'X', the flash command is relevant to that particular memory resource.

Table 37-5. Flash commands

FCMD	Command	Program Flash	Data Flash	FlexRAM	Function
0x00	Read 1s Block	x	x		Verify that a program flash or data flash block is erased. FlexNVM block must not be partitioned for emulated EEPROM.
0x01	Read 1s Section	x	x		Verify that a given number of program flash or data flash locations from a starting address are erased.
0x02	Program Check	x	x		Tests previously-programmed phrases at margin read levels.
0x07	Program Phrase	x	x		Program 8 bytes in a program flash or a data flash block.
0x08	Erase Flash Block	x	x		Erase a program flash or data flash block. An erase of any flash block is only possible when unprotected. FlexNVM block must not be partitioned for emulated EEPROM.
0x09	Erase Flash Sector	x	x		Erase all bytes in a program flash or data flash sector.
0x0B	Program Section	x	x	x	Program data from the Section Program Buffer to a program flash or data flash block.
0x40	Read 1s All Blocks	x	x		Verify that all program flash blocks, data flash blocks, emulated EEPROM backup data memory, and data flash IFR are erased then release MCU security.
0x41	Read Once	IFR			Read 8 bytes of a dedicated 64 byte field in the program flash 0 IFR.
0x43	Program Once	IFR			One-time program of 8 bytes of a dedicated 64-byte field in the program flash 0 IFR.

Table continues on the next page...

Table 37-5. Flash commands (continued)

FCMD	Command	Program Flash	Data Flash	FlexRAM	Function
0x44	Erase All Blocks	×	×	×	Erase all program flash blocks, data flash blocks, FlexRAM, emulated EEPROM backup data memory, and data flash IFR. Then, verify-erase. The flash security byte is left erased (secured state). NOTE: An erase is only possible when all memory locations are unprotected.
0x45	Verify Backdoor Access Key	×			Release MCU security after comparing a set of user-supplied security keys to those stored in the program flash.
0x49	Erase All Blocks Unsecure	×	IFR, ×	×	Erase all program flash blocks, data flash blocks, FlexRAM, emulated EEPROM backup data memory, and data flash IFR. Then, verify-erase and program the security byte to the unsecure state.
0x80	Program Partition	1	IFR, ×	×	Program the FlexNVM Partition Code, emulated EEPROM Data Set Size, and CSEc Key Size into the data flash IFR. Format all emulated EEPROM backup data headers allocated for emulated EEPROM and initialize the FlexRAM.
0x81	Set FlexRAM Function		IFR, ×	×	Switches FlexRAM function between RAM and emulated EEPROM. When switching to emulated EEPROM, FlexNVM is not available while valid data records are being copied from emulated EEPROM backup data memory to FlexRAM. Also enables EEPROM quick writes, provides status of EEPROM cleanup operations, and the ability to force an EEPROM cleanup.

1. Resource not impacted but also not available while command is active

37.5.8.3 Flash commands by mode

The following table shows the flash commands that can be executed in each flash operating mode.

Table 37-6. Flash commands by mode

FCMD	Command	Unsecure	Secure	MEEN=10
0x00	Read 1s Block	×	×	×
0x01	Read 1s Section	×	×	×
0x02	Program Check	×	×	×
0x07	Program Phrase	×	×	×
0x08	Erase Flash Block	×	×	×

Table continues on the next page...

Table 37-6. Flash commands by mode (continued)

FCMD	Command	Unsecure	Secure	MEEN=10
0x09	Erase Flash Sector	×	×	×
0x0B	Program Section	×	×	×
0x40	Read 1s All Blocks	×	×	×
0x41	Read Once	×	×	×
0x43	Program Once	×	×	×
0x44	Erase All Blocks	×	×	×
0x45	Verify Backdoor Access Key	×	×	×
0x49	Erase All Blocks Unsecure	×	×	—
0x80	Program Partition	×	×	×
0x81	Set FlexRAM Function	×	×	×

37.5.8.4 Allowed simultaneous flash operations

Only the CCOB command operations marked 'OK' in the following table are permitted to run simultaneously on the program flash, data flash, and FlexRAM/CSE_PRAM memories. Some operations cannot be executed simultaneously because certain hardware resources are shared by the memories. The priority has been placed on permitting program flash reads while program and erase operations execute on the FlexNVM and FlexRAM/CSE_PRAM. This provides read (program flash) while write (FlexNVM, FlexRAM/CSE_PRAM) functionality. In general, none of these CCOB commands may be executed simultaneously with any CSEc command, and vice versa. Data flash, FlexRAM/CSE_PRAM reads are also not allowed when any CSEc command is running. In addition, program flash reads are not allowed when CSEc command CMD_VERIFY_MAC (pointer method) or CMD_GENERATE_MAC (pointer method) is running. See [Cryptographic Services Engine \(CSEc\)](#) for details.

Table 37-7. Allowed simultaneous memory operations

		Program flash			Data flash			FlexRAM/CSE_PRAM		
		Read	Program Phrase	Erase Flash Sector ¹	Read	Program Phrase	Erase Flash Sector ¹	Read	EE-Write ²	RAM-Write ³
Program flash	Read					OK	OK		OK	
	Program Phrase				OK			OK		OK
	Erase Flash Sector ¹				OK			OK		OK
Data flash	Read		OK	OK						

Table continues on the next page...

Table 37-7. Allowed simultaneous memory operations (continued)

		Program flash			Data flash			FlexRAM/CSE_PRAM		
		Read	Program Phrase	Erase Flash Sector ¹	Read	Program Phrase	Erase Flash Sector ¹	Read	EE-Write ²	RAM-Write ³
	Program Phrase	OK						OK		OK
	Erase Flash Sector ¹	OK						OK		OK
FlexRAM / CSE_PRAM	Read		OK	OK		OK	OK			
	EE-Write ²	OK								
	RAM-Write ³		OK	OK		OK	OK			

1. Also applies to Erase Flash Block
2. When FlexRAM configured for emulated EEPROM (EEERDY=1).
3. When FlexRAM configured as traditional RAM (RAMRDY=1); single cycle operation.

37.5.8.5 Margin read commands

The Read-1s commands (Read 1s All Blocks, Read 1s Block, Read 1s Section) and the Program Check command have a margin choice parameter that allows the user to apply non-standard read reference levels to the program flash and data flash array reads performed by these commands. Using the preset 'user' and 'factory' margin levels, these commands perform their associated read operations at tighter tolerances than a 'normal' read. These non-standard read levels are applied only during the command execution. All simple (un-commanded) flash array reads to the MCU always use the standard, un-margined, read reference level.

Only the 'normal' read level should be employed during normal flash usage. The non-standard, 'user' and 'factory' margin levels should be employed only in special cases. They can be used during special diagnostic routines to gain confidence that the device is not suffering from the end-of-life data loss customary of flash memory devices.

Erased ('1') and programmed ('0') bit states can degrade due to elapsed time and data cycling (number of times a bit is erased and re-programmed). The lifetime of the erased states is relative to the last erase operation. The lifetime of the programmed states is measured from the last program operation.

The 'user' and 'factory' levels become, in effect, a minimum margin, i.e., if the reads pass at the tighter tolerances of the 'user' and 'factory' margins, then the 'normal' reads have at least this much margin before they experience data loss.

The 'user' margin is a small delta to the normal read reference level. 'User' margin levels can be employed to check that flash memory contents have adequate margin for normal level read operations. If unexpected read results are encountered when checking flash memory contents at the 'user' margin levels, loss of information might soon occur during 'normal' readout.

The 'factory' margin is a bigger deviation from the norm, a more stringent read criteria that should only be attempted immediately (or very soon) after completion of an erase or program command, early in the cycling life. 'Factory' margin levels can be used to check that flash memory contents have adequate margin for long-term data retention at the normal level setting. If unexpected results are encountered when checking flash memory contents at 'factory' margin levels, the flash memory contents should be erased and reprogrammed.

CAUTION

Factory margin levels must only be used during verify of the initial factory programming.

37.5.9 Flash command descriptions

This section describes all flash commands that can be launched by a command write sequence. The FTFM sets the FSTAT[ACCERR] flag and aborts the command execution if any of the following illegal conditions occur:

- There is an unrecognized command code in the FCCOB FCMD field.
- There is an error in a FCCOB field for the specific commands. Refer to the error handling table provided for each command.

Ensure that the ACCERR and FPVIOL flags in the FSTAT register are cleared prior to starting the command write sequence. As described in [Launch the command by clearing CCIF](#), a new command cannot be launched while these error flags are set.

Do not attempt to read a flash block while the FTFM is running a command (CCIF = 0) on that same block. The FTFM may return invalid data to the MCU with the collision error flag (FSTAT[RDCOLERR]) set.

When required by the command, address bit 23 selects between program flash memory (=0) and data flash memory (=1).

CAUTION

Flash data must be in the erased state before being programmed. Cumulative programming of bits (adding more zeros) is not allowed.

37.5.9.1 Read 1s Block command

The Read 1s Block command checks to see if an entire program flash or data flash block has been erased to the specified margin level. The FCCOB flash address bits determine which block is erase-verified.

Table 37-8. Read 1s Block Command FCCOB requirements

FCCOB Number	FCCOB Contents [7:0]
0	0x00 (RD1BLK)
1	Flash address [23:16] in the flash block to be verified
2	Flash address [15:8] in the flash block to be verified
3	Flash address [7:0] ¹ in the flash block to be verified
4	Read-1 Margin Choice

1. Must be 128-bit aligned (Flash address [3:0] = 0000) for program flash, 64-bit aligned (Flash address [2:0] = 000) for data flash.

After clearing CCIF to launch the Read 1s Block command, the FTFM sets the read margin for 1s according to [Table 37-9](#) and then reads all locations within the selected program flash or data flash block.

When the data flash is targeted, DEPART must be set for no EEPROM, else the Read 1s Block command aborts setting the FSTAT[ACCERR] flag. If the FTFM fails to read all 1s (i.e., the flash block is not fully erased), the FSTAT[MGSTAT0] flag is set. The CCIF flag sets after the Read 1s Block operation has completed.

Table 37-9. Margin level choices for Read 1s Block

Read Margin Choice	Margin Level Description
0x00	Use the 'normal' read level for 1s
0x01	Apply the 'User' margin to the normal read-1 level
0x02	Apply the 'Factory' margin to the normal read-1 level

Table 37-10. Read 1s Block Command error handling

Error Condition	Error Bit
Command not available in current mode/security	FSTAT[ACCERR]
An invalid margin choice is specified	FSTAT[ACCERR]
Program flash is selected and the address is out of program flash range	FSTAT[ACCERR]
Data flash is selected and the address is out of data flash range	FSTAT[ACCERR]
Data flash is selected with emulated EEPROM enabled	FSTAT[ACCERR]
Flash address is not 128-bit aligned for program flash, 64-bit aligned for data flash	FSTAT[ACCERR]

Table continues on the next page...

Table 37-10. Read 1s Block Command error handling (continued)

Error Condition	Error Bit
Read-1s fails	FSTAT[MGSTAT0]
An uncorrectable ECC fault was detected while reading command executable code	FSTAT[MGSTAT1]

37.5.9.2 Read 1s Section command

The Read 1s Section command checks if a section of program flash or data flash memory is erased to the specified read margin level. The Read 1s Section command defines the starting address and the number of double-phrases to be verified for program flash, phrases for data flash.

Table 37-11. Read 1s Section command FCCOB requirements

FCCOB Number	FCCOB Contents [7:0]
0	0x01 (RD1SEC)
1	Flash address [23:16] of the first double-phrase to be verified for program flash, phrase for data flash
2	Flash address [15:8] of the first double-phrase to be verified for program flash, phrase for data flash
3	Flash address [7:0] ¹ of the first double-phrase to be verified for program flash, phrase for data flash
4	Number of double-phrases to be verified for program flash, phrases for data flash [15:8]
5	Number of double-phrases to be verified for program flash, phrases for data flash [7:0]
6	Read-1 Margin Choice

1. Must be 128-bit aligned (Flash address [3:0] = 0000) for program flash, 64-bit aligned (Flash address [2:0] = 000) for data flash.

Upon clearing CCIF to launch the Read 1s Section command, the FTFM sets the read margin for 1s according to [Table 37-12](#) and then reads all locations within the specified section of flash memory.

If the FTFM fails to read all 1s (i.e., the flash section is not erased), the FSTAT(MGSTAT0) flag is set. The CCIF flag sets after the Read 1s Section operation completes.

Table 37-12. Margin level choices for Read 1s Section

Read Margin Choice	Margin Level Description
0x00	Use the 'normal' read level for 1s
0x01	Apply the 'User' margin to the normal read-1 level
0x02	Apply the 'Factory' margin to the normal read-1 level

Table 37-13. Read 1s Section command error handling

Error Condition	Error Bit
Command not available in current mode/security	FSTAT[ACCERR]
An invalid margin code is supplied	FSTAT[ACCERR]
An invalid flash address is supplied	FSTAT[ACCERR]
Flash address is not 128-bit aligned for program flash, 64-bit aligned for data flash	FSTAT[ACCERR]
The requested section crosses a flash block boundary	FSTAT[ACCERR]
The requested number of double-phrases for program flash, phrases for data flash is zero	FSTAT[ACCERR]
Read-1s fails	FSTAT[MGSTAT0]
An uncorrectable ECC fault was detected while reading command executable code	FSTAT[MGSTAT1]

37.5.9.3 Program Check command

The Program Check command tests a previously programmed program flash or data flash longword to see if it reads correctly at the specified margin level.

Table 37-14. Program Check command FCCOB requirements

FCCOB Number	FCCOB Contents [7:0]
0	0x02 (PGMCHK)
1	Flash address [23:16]
2	Flash address [15:8]
3	Flash address [7:0] ¹
4	Margin Choice
8	Byte 0 expected data
9	Byte 1 expected data
A	Byte 2 expected data
B	Byte 3 expected data

1. Must be longword aligned (Flash address [1:0] = 00).

Upon clearing CCIF to launch the Program Check command, the FTFM sets the read margin for 1s based on the provided margin choice according to [Table 37-15](#). The Program Check operation then reads the specified longword, and compares the actual read data to the expected data provided by the FCCOB. If the comparison at margin-1 fails, the FSTAT[MGSTAT0] flag is set.

Functional description

The FTFM will then set the read margin for 0s based on the provided margin choice. The Program Check operation will then read the specified longword and compare the actual read data to the expected data provided by the FCCOB. If the comparison at margin-0 fails, the MGSTAT0 flag will be set. The CCIF flag will set after the Program Check operation has completed.

The starting address must be longword aligned (the lowest two bits of the byte address must be 00):

- Byte 0 data is expected at the supplied 32-bit aligned address,
- Byte 1 data is expected at byte address specified + 0b01,
- Byte 2 data is expected at byte address specified + 0b10, and
- Byte 3 data is expected at byte address specified + 0b11.

NOTE

See the description of margin reads, [Margin read commands](#)

Table 37-15. Margin level choices for Program Check

Read Margin Choice	Margin Level Description
0x01	Read at 'User' margin-1 and 'User' margin-0
0x02	Read at 'Factory' margin-1 and 'Factory' margin-0

Table 37-16. Program Check command error handling

Error Condition	Error Bit
Command not available in current mode/security	FSTAT[ACCERR]
An invalid flash address is supplied	FSTAT[ACCERR]
Flash address is not longword aligned	FSTAT[ACCERR]
An invalid margin choice is supplied	FSTAT[ACCERR]
Either of the margin reads does not match the expected data	FSTAT[MGSTAT0]
An uncorrectable ECC fault was detected while reading command executable code	FSTAT[MGSTAT1]

37.5.9.4 Program Phrase command

The Program Phrase command programs eight previously-erased bytes in the program flash memory or in the data flash memory using an embedded algorithm.

CAUTION

A Flash memory location must be in the erased state before being programmed. Cumulative programming of bits (back-to-back program operations without an intervening erase) within a

Flash memory location is not allowed. Re-programming of existing 0s to 0 is not allowed as this overstresses the device.

Table 37-17. Program Phrase Command FCCOB requirements

FCCOB Number	FCCOB Contents [7:0]
0	0x07 (PGM8)
1	Flash address [23:16]
2	Flash address [15:8]
3	Flash address [7:0] ¹
4	Byte 0 program value
5	Byte 1 program value
6	Byte 2 program value
7	Byte 3 program value
8	Byte 4 program value
9	Byte 5 program value
A	Byte 6 program value
B	Byte 7 program value

1. Must be 64-bit aligned (Flash address [2:0] = 000)

Upon clearing CCIF to launch the Program Phrase command, the FTFM programs the data bytes into the flash using the supplied address. The protection status is always checked. The targeted flash locations must be currently unprotected (see the description of the FPROT and FDPROT registers) to permit execution of the Program Phrase operation.

The programming operation is unidirectional. It can only move NVM bits from the erased state ('1') to the programmed state ('0'). Erased bits that fail to program to the '0' state are flagged with FSTAT[MGSTAT0] set. The CCIF flag is set after the Program Phrase operation completes.

The starting address must be 64-bit aligned (flash address [2:0] = 000):

- Byte 0 data is written to the starting address ('start'),
- Byte 1 data is programmed to byte address start+0b01,
- Byte 2 data is programmed to byte address start+0b10, and
- Byte 3 data is programmed to byte address start+0b11, etc.

Table 37-18. Program Phrase command error handling

Error Condition	Error Bit
Command not available in current mode/security	FSTAT[ACCERR]
An invalid flash address is supplied	FSTAT[ACCERR]
Flash address is not 64-bit aligned	FSTAT[ACCERR]

Table continues on the next page...

Table 37-18. Program Phrase command error handling (continued)

Error Condition	Error Bit
Flash address points to a protected area	FSTAT[FPVIOL]
Any errors have been encountered during the verify operation	FSTAT[MGSTAT0]
An uncorrectable ECC fault was detected while reading command executable code	FSTAT[MGSTAT1]

37.5.9.5 Erase Flash Block command

The Erase Flash Block operation erases all addresses in a single program flash or data flash block.

Table 37-19. Erase Flash Block command FCCOB requirements

FCCOB Number	FCCOB Contents [7:0]
0	0x08 (ERSBLK)
1	Flash address [23:16] in the flash block to be erased
2	Flash address [15:8] in the flash block to be erased
3	Flash address [7:0] ¹ in the flash block to be erased

1. Must be 128-bit aligned (Flash address [3:0] = 0000) for program flash, 64-bit aligned (Flash address [2:0] = 000) for data flash.

Upon clearing CCIF to launch the Erase Flash Block command, the FTFM erases the main array of the selected flash block and verifies that it is erased. When the data flash is targeted, DEPART must be set for no EEPROM (see [FlexNVM partition code](#)) else the Erase Flash Block command aborts setting the FSTAT[ACCERR] bit. The Erase Flash Block command aborts and sets the FSTAT[FPVIOL] flag if any region within the block is protected by the program flash protection (FPROT) registers or the data flash protection (FDPROT) register. If the erase verify fails, the FSTAT[MGSTAT0] flag is set. The CCIF flag will set after the Erase Flash Block operation has completed.

Table 37-20. Erase Flash Block command error handling

Error Condition	Error Bit
Command not available in current mode/security	FSTAT[ACCERR]
Program flash is selected and the address is out of program flash range	FSTAT[ACCERR]
Data flash is selected and the address is out of data flash range	FSTAT[ACCERR]
Data flash is selected with emulated EEPROM enabled	FSTAT[ACCERR]
Flash address is not 128-bit aligned for program flash, 64-bit aligned for data flash	FSTAT[ACCERR]
Any area of the selected flash block is protected	FSTAT[FPVIOL]
Any errors have been encountered during the verify operation ¹	FSTAT[MGSTAT0]
An uncorrectable ECC fault was detected while reading command executable code	FSTAT[MGSTAT1]

1. User margin read may be run using the Read 1s Block command to verify all bits are erased.

37.5.9.6 Erase Flash Sector command

The Erase Flash Sector operation erases all addresses in a flash sector.

Table 37-21. Erase Flash Sector command FCCOB requirements

FCCOB Number	FCCOB Contents [7:0]
0	0x09 (ERSSCR)
1	Flash address [23:16] in the flash sector to be erased
2	Flash address [15:8] in the flash sector to be erased
3	Flash address [7:0] ¹ in the flash sector to be erased

1. Must be 128-bit aligned (Flash address [3:0] = 0000) for program flash, 64-bit aligned (Flash address [2:0] = 000) for data flash.

After clearing CCIF to launch the Erase Flash Sector command, the FTFM erases the selected program flash or data flash sector and then verifies that it is erased. The Erase Flash Sector command aborts and sets the FSTAT[FPVIOL] flag if the selected sector is protected by the program flash protection (FPROT) registers or the data flash protection (FDPROT) register. If the erase-verify fails the FSTAT[MGSTAT0] flag is set. The CCIF flag is set after the Erase Flash Sector operation completes. The Erase Flash Sector command is suspendable (see the FCNFG[ERSSUSP] bit and [Figure 37-7](#)).

Table 37-22. Erase Flash Sector command error handling

Error Condition	Error Bit
Command not available in current mode/security	FSTAT[ACCERR]
An invalid Flash address is supplied	FSTAT[ACCERR]
Flash address is not 128-bit aligned for program flash, 64-bit aligned for data flash	FSTAT[ACCERR]
The selected program flash or data flash sector is protected	FSTAT[FPVIOL]
Any errors have been encountered during the verify operation ¹	FSTAT[MGSTAT0]
An uncorrectable ECC fault was detected while reading command executable code	FSTAT[MGSTAT1]

1. User margin read may be run using the Read 1s Section command to verify all bits are erased

37.5.9.6.1 Suspending an Erase Flash Sector operation

To suspend an Erase Flash Sector operation set the FCNFG[ERSSUSP] bit when CCIF, ACCERR, and FPVIOL are clear and the CCOB command field holds the code for the Erase Flash Sector command. During the Erase Flash Sector operation (see [Erase Flash Sector command](#)), the flash samples the state of the ERSSUSP bit at convenient points. If the FTFM detects that the ERSSUSP bit is set, the Erase Flash Sector operation is

suspended and the FTFM sets CCIF. While ERSSUSP is set, all writes to flash registers are ignored except for writes to the FSTAT, FCNFG, FERCNFG and FERSTAT registers.

If an Erase Flash Sector operation effectively completes before the FTFM detects that a suspend request has been made, the FTFM clears the ERSSUSP bit prior to setting CCIF. When an Erase Flash Sector operation has been successfully suspended, the FTFM sets CCIF and leaves the ERSSUSP bit set. The ERSSUSP bit can only be cleared while CCIF is set in order to prevent the withdrawal of a suspend request before the FTFM has acknowledged it.

37.5.9.6.2 Resuming a suspended Erase Flash Sector operation

If the ERSSUSP bit is still set when CCIF is cleared to launch the next command, the previous Erase Flash Sector operation resumes. The FTFM acknowledges the request to resume a suspended operation by clearing the ERSSUSP bit. A new suspend request can then be made by setting ERSSUSP. A single Erase Flash Sector operation can be suspended and resumed multiple times.

There is a minimum elapsed time limit of 4.3 msec between the request to resume the Erase Flash Sector operation (CCIF is cleared) and the request to suspend the operation again (ERSSUSP is set). This minimum time period is required to ensure that the Erase Flash Sector operation will eventually complete. If the minimum period is continually violated, i.e., the suspend requests come repeatedly and too quickly, no forward progress is made by the Erase Flash Sector algorithm. The resume/suspend sequence runs indefinitely without completing the erase.

37.5.9.6.3 Aborting a suspended Erase Flash Sector operation

The user may choose to abort a suspended Erase Flash Sector operation by clearing the ERSSUSP bit prior to clearing CCIF for the next command launch. When a suspended operation is aborted, the FTFM starts the new command using the new FCCOB contents.

While FCNFG[ERSSUSP] is set, a write to the FlexRAM while FCNFG[EEERDY] is set clears ERSSUSP and aborts the suspended operation. The FlexRAM write operation is executed by the FTFM.

Note

Aborting the erase leaves the bitcells in an indeterminate, partially-erased state. Data in this sector is not reliable until a new erase command fully completes.

The following figure shows how to suspend and resume the Erase Flash Sector operation.

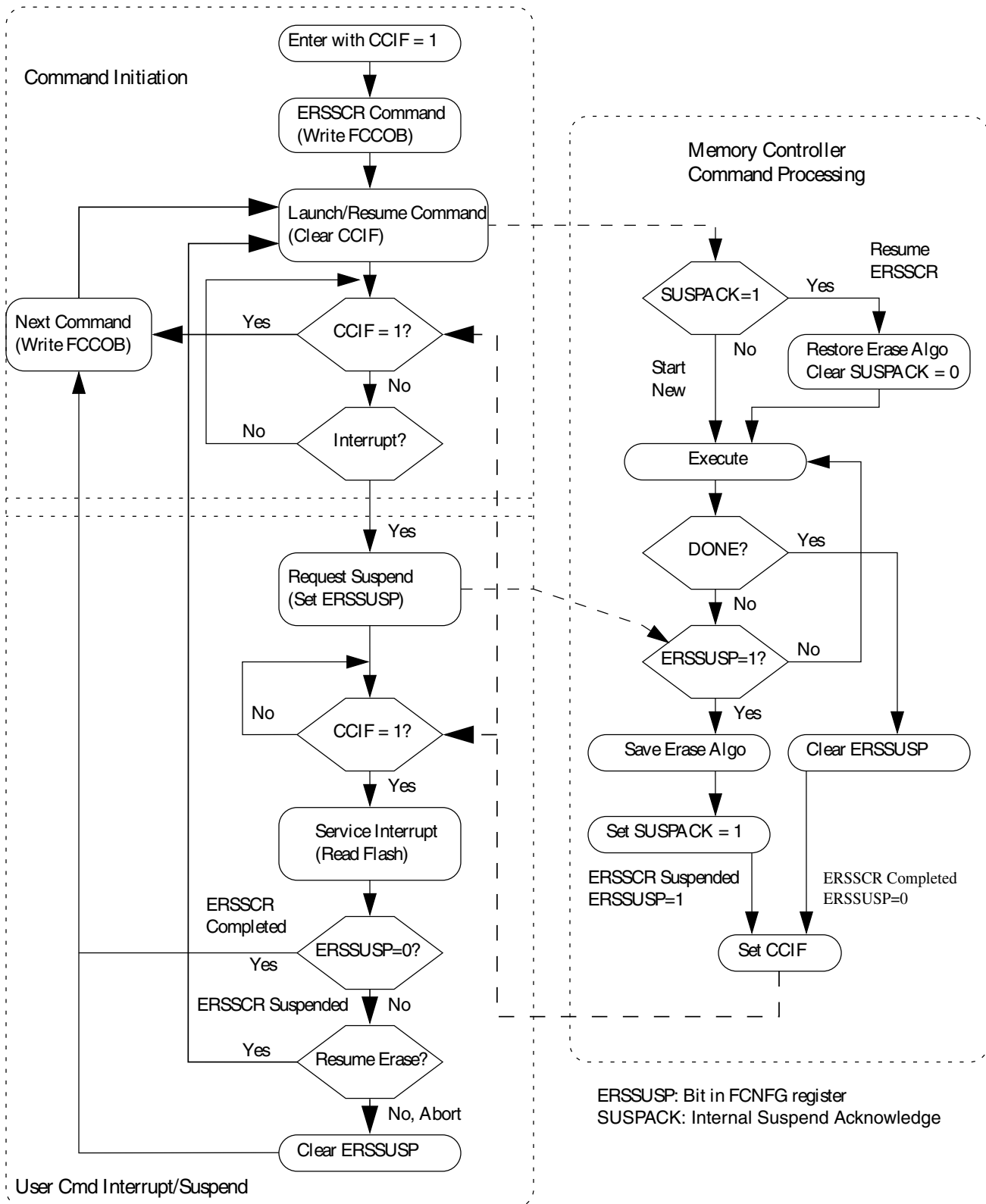

Figure 37-7. Suspend and resume of Erase Flash Sector operation

37.5.9.7 Program Section command

The Program Section operation programs the data found in the section program buffer to previously erased locations in the program flash or data flash blocks using an embedded algorithm. Data is preloaded into the section program buffer by writing to the FlexRAM while it is set to function as a programming acceleration RAM (see [Flash sector programming](#)).

The section program buffer is limited to the lower quarter of the programming acceleration RAM (byte addresses 0x0000 - 0x0400). Data written to the remainder of the programming acceleration RAM is ignored and may be overwritten during Program Section command execution.

CAUTION

A flash memory location must be in the erased state before being programmed. Cumulative programming of bits (back-to-back program operations without an intervening erase) within a flash memory location is not allowed. Re-programming of existing 0s to 0 is not allowed as this overstresses the device.

Table 37-23. Program Section command FCCOB requirements

FCCOB Number	FCCOB Contents [7:0]
0	0x0B (PGMSEC)
1	Flash address [23:16]
2	Flash address [15:8]
3	Flash address [7:0] ¹
4	Number of double-phrases for program flash, phrases for data flash to program [15:8]
5	Number of double-phrases for program flash, phrases for data flash to program [7:0]

1. Must be 128-bit aligned (Flash address [3:0] = 0000) for program flash, 64-bit aligned (Flash address [2:0] = 000) for data flash.

After clearing CCIF to launch the Program Section command, the FTFM will block access to the FlexRAM and program the data residing in the Section Program Buffer into the flash memory starting at the flash address provided. The starting address must be unprotected (see the description of the FPROT and FDPROT registers) to permit execution of the Program Section operation. Programming, which is not allowed to cross a flash sector boundary, continues until all requested double-phrases for program flash, phrases for data flash have been programmed. After the Program Section operation has completed, the CCIF flag will set and normal access to the FlexRAM is restored. The contents of the Section Program Buffer are not changed by the Program Section operation.

Table 37-24. Program Section command error handling

Error Condition	Error Bit
Command not available in current mode/security	FSTAT[ACCERR]
An invalid flash address is supplied	FSTAT[ACCERR]
Flash address is not 128-bit aligned for program flash, 64-bit aligned for data flash	FSTAT[ACCERR]
The requested section crosses a program flash sector boundary	FSTAT[ACCERR]
The requested number of double-phrases for program flash, phrases for data flash is zero	FSTAT[ACCERR]
The space required to store data for the requested number of double-phrases for program flash, phrases for data flash is more than one quarter the size of the FlexRAM	FSTAT[ACCERR]
The FlexRAM is not set to function as a traditional RAM, i.e., set if RAMRDY=0	FSTAT[ACCERR]
The SETRAM command (with control code FFh), ERSALL command, or ERSALLU command has not successfully completed since the last reset	FSTAT[ACCERR]
The flash address falls in a protected area	FSTAT[FPVIOL]
Any errors have been encountered during the verify operation	FSTAT[MGSTAT0]
An uncorrectable ECC fault was detected while reading command executable code	FSTAT[MGSTAT1]
An uncorrectable ECC fault was detected while reading the FlexRAM	FSTAT[MGSTAT1]

37.5.9.7.1 Flash sector programming

The process of programming an entire flash sector using the Program Section command is as follows:

1. If required, execute the Set FlexRAM Function command to make the FlexRAM available as traditional RAM and initialize the FlexRAM to all ones.
2. Launch the Erase Flash Sector command to erase the flash sector to be programmed.
3. Beginning with the starting address of the FlexRAM, sequentially write enough data to the RAM to fill an entire flash sector or one quarter of the FlexRAM, whichever is less. All writes must be 32-bit aligned writes, 8-bit and 16-bit writes generate a transfer error. This area of the RAM serves as the section program buffer.

NOTE

In step 1, the section program buffer was initialized to all ones, the erased state of the flash memory.

The section program buffer can be written to while the operation launched in step 2 is executing, i.e., while CCIF = 0.

4. Execute the Program Section command to program the contents of the section program buffer into the selected flash sector.
5. If a Flash sector is larger than one quarter of the FlexRAM, repeat steps 3 and 4 until the sector has been completely programmed.
6. To program additional flash sectors, repeat steps 2 through 4.

- To restore emulated EEPROM functionality, execute the Set FlexRAM Function command to make the FlexRAM available for emulated EEPROM.

37.5.9.8 Read 1s All Blocks command

The Read 1s All Blocks command checks if the program flash block, data flash block, data flash IFR, and any emulated EEPROM backup data memory have been erased to the specified read margin level, if applicable, and releases security if the readout passes, i.e. all data reads as '1'.

Table 37-25. Read 1s All Blocks command FCCOB requirements

FCCOB Number	FCCOB Contents [7:0]
0	0x40 (RD1ALL)
1	Read-1 Margin Choice

After clearing CCIF to launch the Read 1s All Blocks command, the FTFM:

- sets the read margin for 1s according to [Table 37-26](#),
- confirms the contents of the program flash block, data flash block, data flash IFR, and any emulated EEPROM backup data memory are in the erased state.

If the FTFM confirms that these memory resources are erased, security is released by setting the FSEC[SEC] field to the unsecure state. The security byte in the flash configuration field (see [Flash configuration field description](#)) remains unaffected by the Read 1s All Blocks command. If the read fails, i.e., all flash memory resources are not in the fully erased state, the FSTAT[MGSTAT0] flag is set.

The EEERDY and RAMRDY flags in the FCNFG register are clear during the Read 1s All Blocks operation and are restored at the end of the Read 1s All Blocks operation.

The CCIF flag sets after the Read 1s All Blocks operation has completed.

Table 37-26. Margin level choices for Read 1s All Blocks

Read Margin Choice	Margin Level Description
0x00	Use the 'normal' read level for 1s
0x01	Apply the 'User' margin to the normal read-1 level
0x02	Apply the 'Factory' margin to the normal read-1 level

Table 37-27. Read 1s All Blocks command error handling

Error Condition	Error Bit
An invalid margin choice is specified	FSTAT[ACCERR]
Read-1s fails	FSTAT[MGSTAT0]
An uncorrectable ECC fault was detected while reading command executable code	FSTAT[MGSTAT1]

37.5.9.9 Read Once command

The Read Once command provides read access to a reserved 64-byte field located in the program flash IFR (see [Program flash 0 IFR map](#) and [Program Once field](#)). Access to the Program Once field is via 8 records, each 8 bytes long. The Program Once field is programmed using the Program Once command described in [Program Once command](#).

Table 37-28. Read Once command FCCOB requirements

FCCOB Number	FCCOB Contents [7:0]
0	0x41 (RDONCE)
1	Program Once record index (0x00 - 0x07)
Returned Values	
4	Program Once byte 0 value
5	Program Once byte 1 value
6	Program Once byte 2 value
7	Program Once byte 3 value
8	Program Once byte 4 value
9	Program Once byte 5 value
A	Program Once byte 6 value
B	Program Once byte 7 value

After clearing CCIF to launch the Read Once command, an 8-byte Program Once record is read from the program flash IFR and stored in the FCCOB register. The CCIF flag is set after the Read Once operation completes. Valid record index values for the Read Once command range from 0x00 to 0x07. During execution of the Read Once command, any attempt to read addresses within the program flash block containing this 64-byte field returns invalid data. The Read Once command can be executed any number of times.

Table 37-29. Read Once command error handling

Error Condition	Error Bit
Command not available in current mode/security	FSTAT[ACCERR]
An invalid record index is supplied	FSTAT[ACCERR]

Table continues on the next page...

Table 37-29. Read Once command error handling (continued)

Error Condition	Error Bit
An uncorrectable ECC fault was detected while reading the Program Once record	FSTAT[MGSTAT0]
An uncorrectable ECC fault was detected while reading command executable code	FSTAT[MGSTAT1]

37.5.9.10 Program Once command

The Program Once command enables programming to a reserved 64-byte field in the program flash IFR (see [Program flash 0 IFR map](#) and [Program Once field](#)). Access to the Program Once field is via 8 records, each 8 bytes long. The Program Once field can be read using the Read Once command (see [Read Once command](#)). Each Program Once record can be programmed only once since the program flash IFR cannot be erased.

Table 37-30. Program Once command FCCOB requirements

FCCOB Number	FCCOB Contents [7:0]
0	0x43 (PGMONCE)
1	Program Once record index (0x00 - 0x07)
2	Not Used
3	Not Used
4	Program Once Byte 0 value
5	Program Once Byte 1 value
6	Program Once Byte 2 value
7	Program Once Byte 3 value
8	Program Once Byte 4 value
9	Program Once Byte 5 value
A	Program Once Byte 6 value
B	Program Once Byte 7 value

After clearing CCIF to launch the Program Once command, the FTFM first verifies that the selected record is erased. If erased, then the selected record is programmed using the values provided. The Program Once command also verifies that the programmed values read back correctly. The CCIF flag is set after the Program Once operation has completed.

The reserved program flash IFR location accessed by the Program Once command cannot be erased and any attempt to program one of these records when the existing value is not all Fs (erased) is not allowed. Valid record index values for the Program Once command range from 0x00 to 0x07. During execution of the Program Once command, any attempt to read addresses within program flash returns invalid data.

Table 37-31. Program Once command error handling

Error Condition	Error Bit
Command not available in current mode/security	FSTAT[ACCERR]
An invalid record index is supplied	FSTAT[ACCERR]
The requested record has already been programmed to a non-erased value ¹	FSTAT[ACCERR]
Any errors have been encountered during the verify operation	FSTAT[MGSTAT0]
An uncorrectable ECC fault was detected while reading command executable code	FSTAT[MGSTAT1]

1. If a Program Once record is initially programmed to 0xFFFF_FFFF_FFFF_FFFF, the Program Once command is allowed to execute again on that same record.

37.5.9.11 Erase All Blocks command

The Erase All Blocks operation erases all flash memory, initializes the FlexRAM, verifies all memory contents, and releases MCU security.

Table 37-32. Erase All Blocks command FCCOB requirements

FCCOB Number	FCCOB Contents [7:0]
0	0x44 (ERSALL)

After clearing CCIF to launch the Erase All Blocks command, the FTFM erases all program flash memory, data flash memory, data flash IFR space, emulated EEPROM backup data memory, and FlexRAM, then verifies that all are erased.

If the FTFM verifies that all flash memories and the FlexRAM were properly erased, MCU security is released by setting the FSEC[SEC] field to the unsecure state and the FCNFG[RAMRDY] bit is set. The Erase All Blocks command aborts if any flash memory is protected by the FPROT register or FDPROT register or if the FlexRAM region is protected by the FEPROT register. The security byte and all other contents of the flash configuration field (see [Flash configuration field description](#)) are erased by the Erase All Blocks command. If the erase-verify fails, the FSTAT[MGSTAT0] flag is set. The CCIF flag is set after the Erase All Blocks operation completes.

NOTE

For CSEc enabled parts, once Flash Keys are allocated (regardless of being initialized or not), the Erase All Blocks command is blocked from executing. Refer to the commands CMD_DBG_CHAL and CMD_DBG_AUTH for the procedures to pass a challenge/authentication process which will first remove the keys, then (assuming successful execution) allow this command to be executed.

Table 37-33. Erase All Blocks command error handling

Error Condition	Error Bit
Command not available in current mode/security, or CSEc key allocation being non-zero keys	FSTAT[ACCERR]
Any region of the program flash memory, data flash memory, or FlexRAM is protected	FSTAT[FPVIOL]
Any errors have been encountered during the verify operation ¹	FSTAT[MGSTAT0]
An uncorrectable ECC fault was detected while reading command executable code	FSTAT[MGSTAT1]

1. User margin read may be run using the Read 1s All Blocks command to verify all bits are erased

37.5.9.11.1 Triggering an erase all external to the flash module

The functionality of the Erase All Blocks/Erase All Blocks Unsecure command is also available in an un-commanded fashion outside of the flash memory. Refer to the device's Chip Configuration details for information on this functionality.

Before invoking the external erase all function, the FCCOB0 register must not contain 0x44. When invoked, the erase-all function erases all program flash memory, data flash memory, data flash IFR space, emulated EEPROM backup, and FlexRAM regardless of the state of the FSTAT[ACCERR and FPVIOL] flags or the protection settings. If the post-erase verify passes, the routine releases security by setting the FSEC[SEC] field register to the unsecure state and the FCNFG[RAMRDY] bit sets. The security byte in the Flash Configuration Field is also programmed to the unsecure state. The status of the erase-all request is reflected in the FCNFG[ERSAREQ] bit. The FCNFG[ERSAREQ] bit is cleared once the operation completes and the normal FSTAT error reporting, except FPVIOL, is available as described in [Erase All Blocks command](#).

37.5.9.12 Verify Backdoor Access Key command

Execution of the Verify Backdoor Access Key command is qualified by the FSEC[KEYEN] bits. The Verify Backdoor Access Key command releases security if user-supplied keys in the FCCOB match those stored in the Backdoor Comparison Key bytes of the Flash Configuration Field. The column labeled Flash Configuration Field offset address shows the location of the matching byte in the Flash Configuration Field.

Table 37-34. Verify Backdoor Access Key command FCCOB requirements

FCCOB Number	FCCOB Contents [7:0]	Flash Configuration Field Offset Address
0	0x45 (VFYKEY)	
1-3	Not Used	
4	Key Byte 0	0x0_0003
5	Key Byte 1	0x0_0002
6	Key Byte 2	0x0_0001

Table continues on the next page...

Table 37-34. Verify Backdoor Access Key command FCCOB requirements (continued)

FCCOB Number	FCCOB Contents [7:0]	Flash Configuration Field Offset Address
7	Key Byte 3	0x0_0000
8	Key Byte 4	0x0_0007
9	Key Byte 5	0x0_0006
A	Key Byte 6	0x0_0005
B	Key Byte 7	0x0_0004

After clearing CCIF to launch the Verify Backdoor Access Key command, the FTFM checks the FSEC[KEYEN] bits to verify that this command is enabled. If not enabled, the FTFM sets the FSTAT[ACCERR] flag and terminates. If the command is enabled, the FTFM compares the key provided in FCCOB to the backdoor comparison key in the Flash Configuration Field. If the backdoor keys match, the FSEC[SEC] field is changed to the unsecure state and security is released. If the backdoor keys do not match, security is not released and all future attempts to execute the Verify Backdoor Access Key command are immediately aborted and the ACCERR flag is set until a reset of the FTFM module occurs. If the entire 8-byte key is all zeros or all ones, the Verify Backdoor Access Key command fails with the ACCERR flag set. The CCIF flag is set after the Verify Backdoor Access Key operation completes.

Table 37-35. Verify Backdoor Access Key command error handling

Error Condition	Error Bit
Command not available in current mode/security	FSTAT[ACCERR]
The supplied key is all-0s or all-Fs	FSTAT[ACCERR]
An incorrect backdoor key is supplied	FSTAT[ACCERR]
Backdoor key access has not been enabled (see the description of the FSEC register)	FSTAT[ACCERR]
This command is launched and the backdoor key has mismatched since the last reset	FSTAT[ACCERR]
An uncorrectable ECC fault was detected while reading command executable code	FSTAT[MGSTAT1]

37.5.9.13 Erase All Blocks Unsecure command

The Erase All Blocks Unsecure operation erases all flash memory, initializes the FlexRAM, verifies all memory contents, programs the security byte in the Flash Configuration Field to the unsecure state, and releases MCU security.

Table 37-36. Erase All Blocks Unsecure command FCCOB requirements

FCCOB Number	FCCOB Contents [7:0]
0	0x49 (ERSALLU)

After clearing CCIF to launch the Erase All Blocks Unsecure command, the FTFM erases all program flash memory, data flash memory, data flash IFR space, emulated EEPROM backup data memory, and FlexRAM, then verifies that all are erased.

If the FTFM verifies that all flash memories and the FlexRAM were properly erased, MCU security is released by setting the FSEC[SEC] field to the unsecure state, the security byte (see [Flash configuration field description](#)) is programmed to the unsecure state by the Erase All Blocks Unsecure command, and the FCNFG[RAMRDY] bit is set. If the erase or program verify fails, the FSTAT[MGSTAT0] flag is set. The CCIF flag is set after the Erase All Blocks Unsecure operation completes.

NOTE

For CSEc enabled parts, once Flash Keys are allocated (regardless of being initialized or not), the Erase All Blocks Unsecure command is blocked from executing. Refer to the commands CMD_DBG_CHAL and CMD_DBG_AUTH for the procedures to pass a challenge/authentication process which will first remove the keys, then (assuming successful execution) allow this command to be executed.

Table 37-37. Erase All Blocks Unsecure command error handling

Error Condition	Error Bit
Command not available in current mode/security, or CSEc key allocation being non-zero keys	FSTAT[ACCERR]
Any errors have been encountered during erase or program verify operations	FSTAT[MGSTAT0]
An uncorrectable ECC fault was detected while reading command executable code	FSTAT[MGSTAT1]

37.5.9.14 Program Partition command

The Program Partition command prepares the FlexNVM block for use as data flash, emulated EEPROM backup data memory, or a combination of both and initializes the FlexRAM. The Program Partition command must not be launched from flash memory, since flash memory resources are not accessible during Program Partition command execution. After partitioning for emulated EEPROM activity, the flash module must be reset before any emulated EEPROM activity can be performed.

The Program Partition command is expected to be run on fresh parts before other FTFM and CSEc commands are launched.

CAUTION

While different partitions of the FlexNVM are available, the intention is that a single partition choice is used throughout the entire lifetime of a given application. The FlexNVM Partition

Code choices affect the endurance and data retention characteristics of the device.

Interrupting a Program Partition operation (due to power loss, reset, supplies out of specified operational ranges, or any other reasons) can leave the partition codes in an indeterminate state. The user must take appropriate counter measures to prevent data loss in case of an interrupted Program Partition operation.

Table 37-38. Program Partition command FCCOB requirements

FCCOB Number	FCCOB Contents [7:0]
0	0x80 (PGMPART)
1	CSEc Key Size
2	SFE
3	EEERST - FlexRAM load during reset option (only bit 0 used): 0 - FlexRAM loaded with valid EEPROM data during reset sequence 1 - FlexRAM not loaded during reset sequence unless CSEc feature is enabled
4	EEPROM Data Set Size Code
5	FlexNVM Partition Code

Table 37-39. Valid CSEc/SHE key size codes

Key Size Code KEYSIZE FCCOB1[2:0] ¹	Number of Flash Keys {MASTER_ECU_KEY, BOOT_MAC_KEY, BOOT_MAC, KEY_<n>}	Number of Bytes Allocated (subtracts from the total FlexRAM space)
000	0	0
001	1 to 5	128
010	1 to 10	256
011	1 to 20	512
111	1 to 23	512

1. FCCOB1[7:3] = 00000.

For non-CSEc enabled parts, the number of Flash Keys must be set to 0 (no keys).

For CSEc enabled parts, the number of Flash Keys is user configurable and the allocated space will assume that the MASTER_ECU_KEY, BOOT_MAC_KEY and BOOT_MAC are there if any keys are enabled. These keys will occupy 3 key slots of the allocated space leaving up to 20 key slots available for user keys (KEY_<n>).

NOTE

For CSEc enabled parts, once Flash Keys are allocated (regardless of being initialized or not), the SHE spec requirement of not erasing Flash Keys without authentication

will apply. This will mean Authentication (DBG_CHAL and DBG_AUTH) commands must be run and pass (removing all Flash Keys) before erase of the FlexNVM (all Flash Keys are backed up in EFlash). Thus, the Erase All Blocks and Erase All Blocks Unsecure commands will not work, nor will the Erase Flash Block command if the FlexNVM is selected. Additionally if any Flash Keys are write protected, they cannot be erased/ removed, thus the FlexNVM cannot be erased and the Authentication process will not pass.

Table 37-40. Security Flag Extension (SFE)

Security Flag Extension Code SFE (FCCOB2[7:0]) ¹	Results
0x00	Flash Key 'Verify Only' attribute not enabled
0x01	Flash Key 'Verify Only' attribute enabled

1. FCCOB2[7:1] is ignored

The enhanced Security Flag Extension (SFE) feature is an extension to the SHE specification. For standard SHE usage model, the user should configure this feature as 'not enabled' (SFE set to 0x00). This addition is to provide capability to flag a key as 'VERIFY_ONLY'. That is, the user can configure SFE set to 0x01 and then use the LOAD_KEY command to add a new attribute to the key which would tell the GENERATE_MAC command that the key is to be used only by the VERIFY_MAC command (by configuring SFE as 'enabled' and then using LOAD_KEY to set the new VERIFY_ONLY attribute on that key).

The VERIFY_ONLY attribute has no effect if the KEY_USAGE attribute is '0'.

See the CMD_LOAD_KEY command for more information on the new attribute.

Table 37-41. Valid emulated EEPROM data set size codes

EEPROM Data Set Size Code EEESIZE (FCCOB4[3:0]) ¹	EEPROM Data Set Size (KB)
0010	4
1111	0 ²

1. FCCOB4[7:4] = 0000

2. EEPROM Data Set Size must be set to 0 Bytes when the FlexNVM Partition Code is set for no EEPROM.

Table 37-42. Valid FlexNVM partition codes

FlexNVM Partition Code DEPART (FCCOB5[3:0]) ¹	Data flash Size (KB)	EEPROM-backup Size (KB)
0000	64	0
0011	32	32
0100	0	64
1000	0	64
1010	16	48
1011	32	32
1100	64	0

1. FCCOB5[7:4] = 0000

After clearing CCIF to launch the Program Partition command, the FTFM first verifies that the EEPROM Data Set Size Code and FlexNVM Partition Code in the data flash IFR are erased. If erased, the Program Partition command erases the contents of the FlexNVM memory. If the FlexNVM is to be partitioned for emulated EEPROM backup, the allocated emulated EEPROM backup data sectors are formatted for emulated EEPROM use. Finally, the partition codes are programmed into the data flash IFR using the values provided. The Program Partition command also verifies that the partition codes read back correctly after programming. The CCIF flag is set after the Program Partition operation completes.

Prior to launching the Program Partition command, the data flash IFR must be in an erased state, which can be accomplished by executing the Erase All Blocks command, the Erase All Blocks Unsecure command, or by an external request (see [Triggering an erase all external to the flash module](#)).

Table 37-43. Program Partition command error handling

Error Condition	Error Bit
Command not available in current mode/security	FSTAT[ACCERR]
Invalid Key Size Code is entered (see Table 37-39 for valid codes)	FSTAT[ACCERR]
FCCOB1[7:3] != 00000	FSTAT[ACCERR]
FCCOB1[7:0] > 0 for non-CSEc enabled parts	FSTAT[ACCERR]
FCCOB1[7:0] > 0, when EEPROM-backup size is 0 KB	FSTAT[ACCERR]
FCCOB1[7:0] > 0, when SFE = 0x01	FSTAT[ACCERR]
FCCOB1[7:0] > 0, when FCCOB3[0] = 1	FSTAT[ACCERR]
FCCOB3[0] = 1 for CSEc enabled parts with Flash Keys allocated	FSTAT[ACCERR]
The EEPROM data size and FlexNVM partition code bytes are not initially 0xFFFF	FSTAT[ACCERR]
Invalid EEPROM Data Set Size Code is entered (see Table 37-41 for valid codes)	FSTAT[ACCERR]
Invalid FlexNVM Partition Code is entered (see Table 37-42 for valid codes)	FSTAT[ACCERR]

Table continues on the next page...

Table 37-43. Program Partition command error handling (continued)

Error Condition	Error Bit
FlexNVM Partition Code = full data flash (no emulated EEPROM) and EEPROM Data Set Size Code allocates FlexRAM for emulated EEPROM	FSTAT[ACCERR]
FlexNVM Partition Code allocates space for emulated EEPROM backup, but EEPROM Data Set Size Code allocates no FlexRAM for emulated EEPROM	FSTAT[ACCERR]
FCCOB4[7:4] != 0000	FSTAT[ACCERR]
FCCOB5[7:4] != 0000	FSTAT[ACCERR]
Any errors have been encountered during the verify operation	FSTAT[MGSTAT0]
An uncorrectable ECC fault was detected while reading command executable code	FSTAT[MGSTAT1]
An uncorrectable ECC fault was detected while reading the FlexRAM	FSTAT[MGSTAT1]

37.5.9.15 Set FlexRAM Function command

The Set FlexRAM Function command changes the function of the FlexRAM:

- When not partitioned for emulated EEPROM, the FlexRAM is typically used as traditional RAM.
- When partitioned for emulated EEPROM, the FlexRAM is typically used to store EEPROM data.

Table 37-44. Set FlexRAM Function command FCCOB requirements

FCCOB Number	FCCOB Contents [7:0]
0	0x81 (SETRAM)
1	FlexRAM Function Control Code (see Table 37-45)
2	Reserved
3	Reserved
4	Number of FlexRAM bytes allocated for EEPROM quick writes [15:8]
5	Number of FlexRAM bytes allocated for EEPROM quick writes [7:0]
Returned Values	
5	Brown-out (BO) Detection Codes <ul style="list-style-type: none"> • 0x00 - No EEPROM issues detected • 0x01 - BO detected before completing EEPROM quick write maintenance • 0x02 - BO detected before completing EEPROM quick writes • 0x04 - BO detected during normal EEPROM write activity
6	Number of EEPROM quick write records requiring maintenance [15:8]
7	Number of EEPROM quick write records requiring maintenance [7:0]
8	EEPROM sector erase count [15:8]
9	EEPROM sector erase count [7:0]
A	Reserved
B	Reserved

Table 37-45. FlexRAM Function control

FlexRAM Function Control Code	Action
0xFF	Make FlexRAM available as RAM: <ul style="list-style-type: none"> • Clear the FCNFG[RAMRDY] and FCNFG[EEERDY] flags • Write a background of ones to all FlexRAM locations • Set the FCNFG[RAMRDY] flag
0xAA	Complete interrupted EEPROM quick write process <ul style="list-style-type: none"> • Clear the FCNFG[EEERDY] flag (and FCNFG[RAMRDY] flag) • Complete maintenance on interrupted EEPROM quick write operations • Set the FCNFG[EEERDY] flag
0x77	EEPROM status query <ul style="list-style-type: none"> • Clear the FCNFG[EEERDY] flag (and FCNFG[RAMRDY] flag) • Report emulated EEPROM status • Set the FCNFG[EEERDY] flag
0x55	Make FlexRAM available for EEPROM quick writes <ul style="list-style-type: none"> • Clear the FCNFG[EEERDY] flag (and FCNFG[RAMRDY] flag) • Enable the emulated EEPROM system for EEPROM quick writes • Set the FCNFG[EEERDY] flag
0x00	Make FlexRAM available for emulated EEPROM: <ul style="list-style-type: none"> • Clear the FCNFG[RAMRDY] and FCNFG[EEERDY] flags • Write a background of ones to all FlexRAM locations • Copy-down existing EEPROM data to FlexRAM • Set the FCNFG[EEERDY] flag

After clearing CCIF to launch the Set FlexRAM Function command, the FTFM sets the function of the FlexRAM based on the FlexRAM Function Control Code.

When making the FlexRAM available as traditional RAM, the FTFM clears the FCNFG[EEERDY] and FCNFG[RAMRDY] flags, overwrites the contents of the entire FlexRAM with a background pattern of all ones, and sets the FCNFG[RAMRDY] flag. The state of the FEPROT register does not prevent the FlexRAM from being overwritten. When the FlexRAM is set to function as a RAM, normal read and write accesses to the FlexRAM are available. When large sections of flash memory need to be programmed, e.g. during factory programming, the FlexRAM can be used as the Section Program Buffer for the Program Section command (see [Program Section command](#)).

When the FlexRAM Function Control Code is 0x55 or 0xAA, after clearing the EEERDY flag, all EEPROM normal or quick write activity not previously completed will be processed. If the EEPROM quick write activity did not complete writing all requested records, the records written will be cleared, effectively restoring previously valid records. If all EEPROM quick write records were written but maintenance activities were not completed, maintenance will complete on the remaining quick write records. The CCIF and EEERDY flags will remain negated until all EEPROM maintenance activities have been completed.

When the FlexRAM Function Control Code is 0x77, after clearing the EEERDY flag, the emulated EEPROM system will be interrogated, and EEPROM cleanup requirements and EEPROM sector erase count will be reported. If EEPROM normal write activity is interrupted by a reset or loss of power before finalizing the record, BO detection code 0x04 will be returned. If the EEPROM quick write activity is interrupted by a reset before writing all quick write records requested with control code 0x55, BO detection code 0x02 will be returned. If the interruption occurs after all quick writes requested have been written but before quick write maintenance has completed, BO detection code 0x01 will be returned. The CCIF and EEERDY flag will remain negated until the EEPROM status has been loaded into the FCCOB registers.

NOTE

For optimum emulated EEPROM performance, it is best to run control code 0x77 followed by control code 0x55 or 0xAA as soon as possible after a reset to cleanup any data impacted by interrupted EEPROM activity.

When making the FlexRAM available for EEPROM quick writes, the contents of the FlexRAM will be left as is and the emulated EEPROM system will be prepared for quick write activities. After the EEERDY flag in the FCNFG register is set, the emulated EEPROM system is ready for quick writes. When the FlexRAM is set to accept the EEPROM quick writes, read and write access to the FlexRAM is available but each 32-bit write to the FlexRAM will invoke EEPROM quick write activity. The CCIF and EEERDY flag will negate on each 32-bit write and assert after the associated EEPROM quick write activity has completed. After the last 32-bit write to the FlexRAM, specified by the contents of FCCOB4 and FCCOB5, the emulated EEPROM system will create the data record for the last write (~150uSec) and begin the EEPROM maintenance activities on the entire block of quick write data. The CCIF and EEERDY flag will remain negated until all EEPROM quick write maintenance activities have completed.

Once started, all required EEPROM quick write activity must be completed before attempting a flash or CSEc command.

When making the FlexRAM available for emulated EEPROM, the FTFM clears the RAMRDY and EEERDY flags, overwrites the contents of the FlexRAM allocated for emulated EEPROM with a background pattern of all ones, and copies the existing EEPROM data from the EEPROM backup record space to the FlexRAM. After completion of the EEPROM copy-down, the EEERDY flag is set. When the FlexRAM is set to function as emulated EEPROM, normal read and write access to the FlexRAM is available, but writes to the FlexRAM also invoke emulated EEPROM activity.

The CCIF flag will be set after the Set FlexRAM Function operation has completed.

Table 37-46. Set FlexRAM Function command error handling

Error Condition	Error Bit
Command not available in current mode/security	FSTAT[ACCERR]
FlexRAM Function Control Code is not defined	FSTAT[ACCERR]
FlexRAM Function Control Code is set to make the FlexRAM available for emulated EEPROM, but FlexNVM is not partitioned for emulated EEPROM	FSTAT[ACCERR]
Set if FlexRAM Function Control Code is set to 0xAA, 0x77 or 0x55 but FCNFG.[EEERDY] =0 (FlexRAM not in emulated EEPROM mode)	FSTAT[ACCERR]
Set if FlexRAM is in EEPROM quick write mode, i.e. all EEPROM quick writes to the FlexRAM have not been completed	FSTAT[ACCERR]
Set if FlexRAM Function Control Code is set to make FlexRAM available for EEPROM quick writes but the number of bytes allocated for quick write is less than 16, more than 512, or not divisible by 4 (only 32-bit quick writes are allowed)	FSTAT[ACCERR]
Set if emulated EEPROM system is in quick write mode and writes to the FlexRAM are not 32-bits	FSTAT[ACCERR]
An uncorrectable ECC fault was detected while reading command executable code	FSTAT[MGSTAT1]
An uncorrectable ECC fault was detected while reading the FlexRAM	FSTAT[MGSTAT1]

37.5.10 Security

The FTFM module provides security information to the MCU based on contents of the FSEC security register. The MCU then limits access to FTFM resources as defined in the device's Chip Configuration details. During the reset sequence, the FTFM module initializes the FSEC register using data read from the security byte of the Flash Configuration Field (see [Flash configuration field description](#)).

The following fields are available in the FSEC register. Details of the settings are described in the FSEC register description.

Table 37-47. FSEC fields

FSEC field	Description
KEYEN	Backdoor Key Security Enable
MEEN	Mass Erase Enable
FSLACC	Factory Failure Analysis Access
SEC	Flash/MCU security

37.5.10.1 Changing the security state

The security state out of reset can be permanently changed by programming the security byte of the flash configuration field. This assumes that you are starting from a mode where the necessary program flash erase and program commands are available and that the region of the program flash containing the flash configuration field is unprotected. If the flash security byte is successfully programmed, its new value takes effect after the next MCU reset.

37.5.10.1.1 Un-securing the MCU using backdoor key access

The MCU can be unsecured by using the backdoor key access feature which requires knowledge of the contents of the 8-byte backdoor key value stored in the Flash Configuration Field (see [Flash configuration field description](#)). If the FSEC[KEYEN] bits are in the enabled state, the Verify Backdoor Access Key command (see [Verify Backdoor Access Key command](#)) can be run which allows the user to present prospective keys for comparison to the stored keys. If the keys match, the FSEC[SEC] bits are changed to unsecure the MCU. The entire 8-byte key cannot be all 0s or all 1s, i.e., 0x0000_0000_0000_0000 and 0xFFFF_FFFF_FFFF_FFFF are not accepted by the Verify Backdoor Access Key command as valid comparison values. While the Verify Backdoor Access Key command is active, program flash memory is not available for read access and returns invalid data.

The user code stored in the program flash memory must have a method of receiving the backdoor keys from an external stimulus. This external stimulus would typically be through one of the on-chip serial ports.

If the KEYEN bits are in the enabled state, the MCU can be unsecured by the backdoor key access sequence described below:

1. Follow the command sequence for the Verify Backdoor Access Key command as explained in [Verify Backdoor Access Key command](#)
2. If the Verify Backdoor Access Key command is successful, the MCU is unsecured and the FSEC[SEC] bits are forced to the unsecure state

An illegal key provided to the Verify Backdoor Access Key command prohibits future use of the Verify Backdoor Access Key command. A reset of the MCU is the only method to re-enable the Verify Backdoor Access Key command when a comparison fails.

After the backdoor keys have been correctly matched, the MCU is unsecured by changing the FSEC[SEC] bits. A successful execution of the Verify Backdoor Access Key command changes the security in the FSEC register only. It does not alter the security byte or the keys stored in the Flash Configuration Field ([Flash configuration field](#)

[description](#)). After the next reset of the MCU, the security state of the FTFM module reverts back to the Flash security byte in the Flash Configuration Field. The Verify Backdoor Access Key command sequence has no effect on the program and erase protections defined in the program flash protection registers.

If the backdoor keys successfully match, the unsecured MCU has full control of the contents of the Flash Configuration Field. The MCU may erase the sector containing the Flash Configuration Field and reprogram the flash security byte to the unsecure state and change the backdoor keys to any desired value. If a brownout occurs while erasing or programming the FSEC portion of the Flash Configuration Field, an uncorrectable ECC fault may occur when the FSEC portion is read during the reset sequence leaving the FSEC register loaded with 0xBB and FSTAT[MGSTAT0] set.

37.5.11 Cryptographic Services Engine (CSEc)

The FTFM module has features to comply with the SHE¹ specification. It is assumed that the user is familiar with the SHE specification, therefore we do not replicate the document here.

By using an embedded processor, firmware and hardware assisted AES-128 sub-block, the FTFM macro enables encryption, decryption and message generation and authentication algorithms for secure messaging applications. Additionally, TRNG and Miyaguchi-Prenell compression sub-blocks enable true random number generation (entropy generator for PRNG in AES sub-block).

To access the command feature set, the part must be configured for emulated EEPROM operation using the PGMPART command. See more in [Program Partition command](#). By enabling security features and configuring a number of CSEc keys, the total size of the accessible FlexRAM will be reduced by the space required to store the keys. The user key space will then be un-addressable space in the FlexRAM.

The CCOB command set is effectively extended to include SHE commands related to ECB, CBC and CMAC features. Secure storage of security keys is enabled within the FTFM module, including up to 20 user keys (MASTER_ECU_KEY, BOOT_MAC_KEY, BOOT_MAC are assumed to be allocated). These commands are referred to as the CSEc command set. The CSEc command set requires input data and command to be entered as described in [User CSEc command interface and command set](#).

1. HIS SHE Specification - Secure Hardware Extension Functional Specification; Version 1.0.1; Rev429 from 23.03.2009

NOTE

1. Only one emulated EEPROM operation, CCOB command operation, or CSEc command operation may be in progress at any given time.
2. Execution of a CSEc command while an Erase Flash Sector command is suspended (FCNFG[ERSSUSP]=1) will result in the suspended erase operation being aborted which may leave the sector contents in an indeterminate state.
3. It is also not possible to execute a different CSEc command in the middle of a continuation of an ongoing CSEc command.
4. It is possible to execute a CCOB command in the middle of a continuation of an ongoing CSEc command, BUT the result is the existing CSEc command will be canceled.
5. Starting execution of CCOB commands or CSEc commands will lock out the CCOB interface with the FlexRAM not available for emulated EEPROM writes and CSE_PRAM not available to launch CSEc commands. The lock is in place until the requested command completes.

CAUTION

Interrupting a CSEc key update operation (due to power loss, reset, supplies out of specified operational ranges, or any other reasons) can leave the contents in an indeterminate state. The user must take appropriate counter measures to prevent data loss in case of an interrupted CSEc key update operation.

For security reasons some features will be disabled upon any type of debugger (JTAG, DP, SDB, etc.) connection to the SoC, per SHE specification requirements according to user configurations.

All message data blocks are to be provided as 128-bit blocks with a minimum block size of one. If data messages contain less than 128-bits, the message must be padded (according to SHE spec) to the required 128-bit block size before passing data to the FTFM module.

Internal to the FTFM module are stored the required Secret Key (SECRET_KEY) and the Unique ID (UID), both residing in unaddressable and unalterable space, programmed in Factory Final Test to establish a part as CSEC enabled. Also supported are the CSEc Keys as described. The Flash Keys are stored in the FlexRAM space, with a configurable amount of space for Flash Keys. The space is subtracted from the end address range of the FlexRAM. Anywhere from 1 to 23 Flash Keys (20 user keys) may be configured as

described in the following table with the assumption that the first three keys are occupied by MASTER_ECU_KEY, BOOT_MAC_KEY and BOOT_MAC leaving anywhere from 1 to 20 KEY_<n> keys to be configured.

Table 37-48. Non-Volatile keys and RAM_KEY

Key Name	KeyID[4:0]		Type	Size (Bytes)	Comments
	{KBS, KeyIDx[3:0]}				
SECRET_KEY	X	0x0	ROM	16	
UID	X	0x0	ROM	15	
MASTER_ECU_KEY	X	0x1	Flash	16	
BOOT_MAC_KEY	X	0x2	Flash	16	
BOOT_MAC	X	0x3	Flash	16	
KEY_01 - KEY_02	0	0x4 - 0x5	Flash	16	
KEY_03 - KEY_10	0	0x6 - 0xD	Flash	16	invalid if up to 5 Flash Keys enabled
KEY_11 - KEY_17	1	0x4 - 0xA	Flash	16	invalid if up to 10 Flash Keys enabled
KEY_18 - KEY_20	1	0xB - 0xD	Flash	16	invalid if up to 20 Flash Keys enabled
RESERVED	X	0xE	RESERVED	16	
RAM_KEY	X	0xF	Volatile (RAM_KEY)	16	

Table 37-49. Other volatile keys

Key Name	ADDRESS	Type	Size (Bytes)	Comments
PRNG_KEY	N/A	RAM	16	
PRNG_STATE	N/A	RAM	16	

Table 37-50. ROM keys

Key Name	ADDRESS	Type	Size (Bytes)	Comments
SECRET_KEY	N/A	ROM	16	
UID	N/A	ROM	15	accessible via the GET_ID command

37.5.11.1 Key/seed/random number generation

This is the high level flow in which to initialize and generate random numbers.

1. Run CMD_INIT_RNG to initialize a random seed from the internal TRNG

NOTE

- a. CMD_INIT_RNG must be run after every reset, and before the first execution of CMD_RND
 - b. If the seed is run through compression before the seed is used in the PRNG, then CSESTAT[RIN] will be set
 - c. Note that if the next step (run CMD_RND) is run without initializing the seed, an error (ERC_RNG_SEED) will be set.
2. Run CMD_RND to generate a random number
The PRNG uses the PRNG_STATE/KEY and Seed per SHE spec and the AIS20 standard as follows:
- $PRNG_STATE_i = ENC_{ECB, PRNG_KEY}(PRNG_STATE_{i-1})$
 - $RND = PRNG_STATE_i$
3. For additional random numbers the user may continue executing CMD_RND unless a reset event occurred. Each time a reset occurs, the CMD_INIT_RNG command must first be run before attempting to regenerate new random numbers

37.5.11.2 Secure boot mode

Three user selectable boot modes (as described in the SHE specification) are supported. The boot modes are configured in the command 'CMD_BOOT_DEFINE'

- Sequential Boot Mode
 - a. Flash system comes out of RESET and main Core stays in RESET, or may execute from ROM code
 - b. FTFM verifies customer firmware block (via CMAC calculation)
 - c. Depending on the firmware verification result (CMAC verify pass/fail), FTFM and security keys are available for security tasks or not (per pass/fail result and individual key attributes)
 - d. Main Core comes out of reset and starts execution of customer firmware
- Strict Sequential Boot Mode
 - a. Flash system comes out of RESET and main Core stays in RESET, or may execute from ROM code
 - b. FTFM verifies customer firmware block (via CMAC calculation)
 - c. Depending on the firmware verification result (CMAC verify pass/fail), FTFM and security keys are available for security tasks or not (per pass/fail result and individual key attributes)
 - d. If the MAC compare fails, then the main Core stays in RESET (no customer code is executed), or may execute ROM code

NOTE

1. The correct BOOT_MAC must be stored before selecting 'Strict' sequential boot mode. Otherwise the boot check will fail and the part will be stuck in reset.
 2. If any key is write protected then DBG_CHALLENGE/AUTH will not pass due to the write protected key blocking erase of all keys. This also hinders the capability of Failure Analysis to evaluate a return. Care must be taken if write protecting any keys is to be used in the application.
- Parallel Boot Mode
 - a. Flash system and main Core come out of RESET
 - b. Main Core starts execution of customer firmware
 - c. In parallel to main Core code execution, the FTFM module verifies customer firmware block (via CMAC calculation)
 - d. Depending on the firmware verification result (CMAC verify pass/fail), FTFM and security keys are available for security related tasks or not (per pass/fail result and individual key attributes)

Non-volatile keys may be disabled (each key has an attribute to decide the response for that key) when secure boot detects manipulation of software or the secure boot process. Boot failure sensitive memory slots will only be re-activated on the next successful boot. Additionally, non-volatile keys may be disabled (again, each key has an attribute to dictate this behavior) when a debugger is attached (JTAG, BDM, etc.), and will only be re-activated upon the next successful boot.

37.5.11.3 User CSEc command interface and command set

The following sections will describe the SHE compliant commands implemented in the CSEc command set as well as the command interface, data structure and protocol related to all operations.

The commands follow a similar protocol to the CCOB commands in that once a command has started the CCOB interface will be locked and no further commands may be initiated until completion of the ongoing command.

This results in one SHE command (CMD_CANCEL) not being implemented in the CSE command feature set of this module. Also, the CMD_STATUS isn't strictly supported as we may not interrupt an ongoing command. But the intent of the CMD_STATUS command is met by user accessible status registers (FCSESTAT1, FCSESTAT0).

All cryptographic functions are processed by an AES-128 engine. Encryption and decryption of data are supported by Electronic Cipher Book (ECB) mode for single blocks (128-bits) of data, and by Cipher Block Chaining (CBC) mode for integer multiples of 128-bit block sized data.

Cipher-based Message Authentication Code (CMAC) generation and verification is also supported by the AES-128 engine, in addition with use of Miyaguchi-Prenell compression function.

Usage of (most of) the CSEc command set is constructed by writing the data (plain text or cipher text) to the CSE_PRAM followed by writing the command word to the CSE_PRAM at address offsets as specified below. The act of writing the command word to the CSE_PRAM will trigger the CCOB interface to be locked down and the CSEc command operation execution to start. All writes to the CSE_PRAM must be 32-bit aligned writes, 8-bit and 16-bit writes generate a transfer error.

NOTE

1. The usage model requires writing the CSE_PRAM data contents **BEFORE** writing the Command Header contents.
Write the Command Header LAST!
2. A write to the command word in the Command Header will lock out the interface until completion of the command.
3. In general, commands that start with CallSeq set to 0x01 but is the first call to that command will result in a Sequence Error (ERC_SEQUENCE_ERROR).
4. For continued commands (CallSeq=0x01), any data changes in FuncFormat, KeyID, MAC_LENGTH, MESSAGE_LENGTH or PAGE_LENGTH will be ignored as these are only captured on the first command (CallSeq=0x00) execution.

Execution of CSEc commands can be thought of as transferring blocks of system memory contents into CSE_PRAM space for command execution, then transferring CSE_PRAM space contents back into system memory for use. Each transfer will consist of data in the form of a number of 'n' 128-bit blocks followed by the command header. The number 'n' may vary from none to 7, as there is space allocated in CSE_PRAM for up to 7, 128-bit blocks of data. Additionally, 128-bits for the command header and associated parameters (like message length) for the command are also allocated. The format is graphically shown in each of the command descriptions below.

The SHE specification lists a set of error codes and which error condition may apply to which key.

Below is the overall general priority order in which the error codes are implemented in this macro (highest priority to lowest). Additionally there is a rough list of examples that may be the source of the error (Note that the list of examples is not exhaustive). Please refer to each command to see which particular ERC_* codes apply to it:

- ERC_GENERAL_ERROR. Example: FuncID is not valid
- ERC_SEQUENCE_ERROR. Example: CalSeq invalid: continuation a command error - changed command type
- ERC_GENERAL_ERROR. Example: Message Length is ==0
- ERC_KEY_INVALID. Example: key slot doesn't qualify per key map to command; KeyID[7:5] are set; KBS==0 and KeyIDx==0xE
- ERC_KEY_NOT_AVAILABLE. Example: key has DBG Attached flag and debugger is active
- ERC_KEY_EMPTY. Example: key slot is empty (not initialized)/not present or higher slot (not partitioned) than partitioned; For RAM_KEY if plain attribute is set
- ERC_NO_SECURE_BOOT. N/A for FTFM - BOOT_DEFINE once configured, will automatically run secure boot
- ERC_KEY_WRITE_PROTECTED. Example : update a write protected key slot, or activate debugger with write protected key(s)
- ERC_KEY_UPDATE_ERROR. Example: key update authentication failed; for LOAD_KEY : M3 != M3* or UID is empty and AuthID isn't the same key slot
- ERC_RNG_SEED. Example: didn't initialize the seed using the TRNG, i.e., CSESTAT1[RIN] != 1
- ERC_NO_DEBUGGING. Example: DEBUG command authentication failed
- ERC_BUSY. N/A for FTFM (CSEc command active if FCSESTAT0[CMDTYPE] = 1 and FSTAT[CCIF] = 1)
- ERC_MEMORY_FAILURE. Example: general memory technology failure (uncorrectable ECC fault, common fault detected)
- ERC_GENERAL_ERROR. Example: general catch all for error not defined above; also for 'pointer method GENERATE_MAC if the message length would cause the sequence to cross a read partition boundary (maximum CMAC can be calculated on 512KB program flash block)
- ERC_NO_ERROR. Example: No error - command will execute

37.5.11.3.1 CSEc command header

Each command may have varying amounts of data associated with it, but each command has a standard command header. The command word header is as follows:

Table 37-51. CSEc command header

Bytes					
3	2	1	0	7	6
Command Word				Error Bits	
FuncID	FuncFormat	CallSeq	KeyID		

The **FuncID** (Function ID) is 8-bits long. Valid values range from 0x01 to 0x16. The following figure lists the available CSEc commands.

The **FuncFormat** (Function Format) specifies how the data is transferred to/from the CSEc. There are two use cases. One (most common) is a copy all data and the command function call method and the other is a pointer and function call method. In the ‘copy’ method, the main core or DMA will first copy the data and then the function call into the CSE_PRAM. For the ‘pointer’ case (for the two CSEc MAC commands), the main core or DMA will provide the pointer information followed by the command function call.

- Copy method : 0x00
- Pointer method : 0x01

The **CallSeq** (Call Sequence) specifies if the information is the first or a following function call. The use case is to provide ongoing data in cases where the full data set can not be provided to CSE_PRAM space along with one command function call. For example a CMAC Verify of a set of 128-bit blocks where there are more than seven 128-bit blocks. This field is not applicable for the pointer method.

- 0x00 : 1st Function Call
- 0x01 : 2nd through nth Function Call

The **KeyID** is divided into two parts. the KeyIDx which is a 4-bit value representing the SHE specification key index. Then the KBS (Key Block Select - not used in all commands) which is a 1-bit value allowing the customer to switch between key banks. $KEY_ID = KeyID[4:0] = \{KBS, KeyIDx[3:0]\}$.

NOTE

KeyIDx is a 4-bit value. Writing 1's to the upper 4-bits of the KeyID byte may result in addressing the incorrect key index/slot.

Finally the command header also contains 16-bits of Error information.

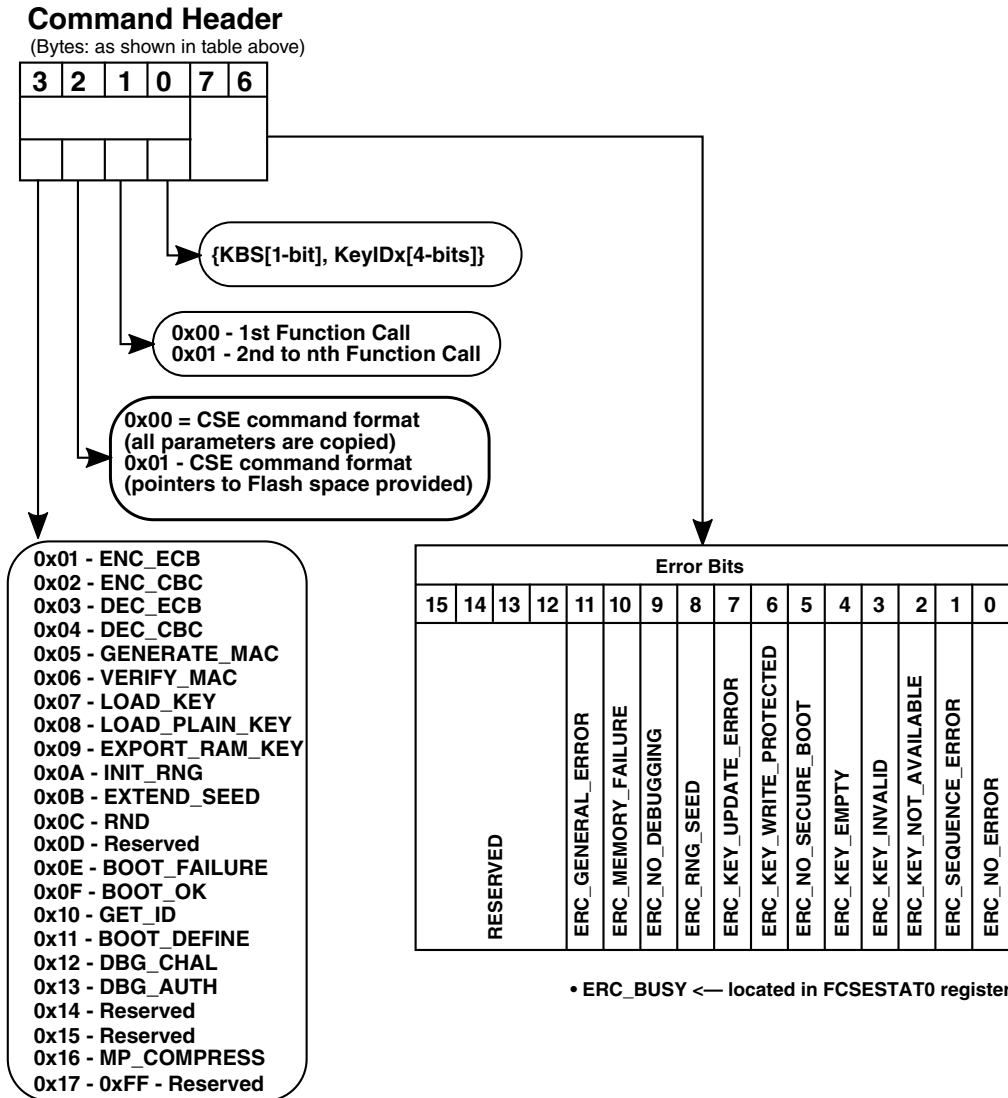

Figure 37-8. CSEc command header details

37.5.11.3.2 CSEc command fault handling

The flash memory controller supervises CSEc command activities. The controller executable code is mainly stored in dedicated flash firmware space and is supported by a dedicated RAM.

CSEc command activities will terminate after experiencing certain uncorrectable ECC faults during firmware execution and crucial data transfers. Flags in both the FSTAT and FERSTAT registers will reflect the fault condition and the corresponding interrupt will be asserted, if enabled in the FERCNFG register. See the FSTAT flag descriptions to determine the impact of the fault on flash resource availability.

Functional description

The handling of uncorrectable ECC faults detected during CSEc command operations is shown in the following table.

Table 37-52. CSEc Command Fault Handling

Condition (when uncorrectable ECC fault is detected during CSEc command operation)	FSTAT Flag	FERSTAT Flag
While reading controller executable code	MGSTAT1	CDFDIF
While reading EEPROM data in the FlexRAM	MGSTAT1	EDFDIF
While reading the CSE_PRAM ¹	MGSTAT1	EDFDIF

1. FCSESTAT0[MEMERR] bit is also set.

37.5.11.4 Generic CSE_PRAM interface description

The CSE_PRAM interface can be thought of as a 128-bit wide SRAM with eight 128-bit pages. The diagrams are shown in little endian format. The first ‘page’ always starts with the command header and this must be the last data written in a sequence of data written to the CSE_PRAM. This is because writing to the command word triggers the macro to lock the CSE_PRAM interface so CSEc operation may start.

Figure 37-9. Generic CSE_PRAM interface

Bits	[127:0]															
Bits	31:2 4	23:1 7	15:8	7:0	31:2 4	23:1 7	15:8	7:0	31:2 4	23:1 7	15:8	7:0	31:2 4	23:1 7	15:8	7:0
WD	Word 0				Word 1				Word 2				Word 3			
Page	Byte															
	3	2	1	0	7	6	5	4	B	A	9	8	F	E	D	C
0	Func D	Func Form at	CallS eq	KeyID	Error Bits		Command Specific									
1	Data Input to CSEc OR Data Output from CSEc															
2																
3																
4																
5																
6																
7																

To setup a CSEc command, the user should first enter the data as required, in 128-bit blocks, as many blocks as desired (within the seven pages allowed at one given time). Followed by any associated command specific information such as MESSAGE_LENGTH. Followed by the last write which is to the command word.

The operation will start as indicated by CCIF transitioning from 1 to 0. The operation will complete and set CCIF to 1 again. At this point the user may read the CSE_PRAM to verify or transfer results as applicable.

If the same command is to be continued, the user should write the remaining data in as applicable, followed by an updated command word (same FuncID but CallSeq changed 0x01 to indicate this is a continuation of the same command). For continuation of any command, the FuncFormat, KeyID, MAC_LENGTH, MESSAGE_LENGTH and PAGE_LENGTH inputs are only captured on the first command written.

NOTE

1. If while continuing a command with a change in the FuncID field, a sequence error will occur. The FuncID field must stay consistent throughout the continuation of a command.
2. A general statement about all MAC and ENC/DEC commands:

Per SHE specification, the User/Application must manage any potential padding (blocks of bit length less than the 128-bit block length) for all ENC/DEC commands. While the CSEc module will manage all potential padding for the MAC commands.

37.5.11.5 CMD_ENC_ECB

The Encrypt ECB command operates on a single 128-bit block of data. The function encrypts a given PLAIN_TEXT (128-bits) with the key identified by the KEY_ID (5-bits), and returns CIPHER_TEXT (128-bits). The 'PAGE_LENGTH' is used to tell the operation how many 128-bit pages are to be processed. All data must be presented in 128-bit blocks (all padding must be done by the application). This command may also be extended by setting the CallSeq field to 0x01 for continued pages of data.

Table 37-53. Encrypt ECB command details

Parameter	Direction	Width
KEY_ID	IN	5
PAGE_LENGTH	IN	16
PLAIN_TEXT	IN	n * 128
CIPHER_TEXT	OUT	n * 128
CIPHER_TEXT = ENC _{ECB,KEY, KEY_ID} (PLAIN_TEXT)		
Error Codes: ERC_NO_ERROR, ERC_SEQUENCE_ERROR, ERC_KEY_NOT_AVAILABLE, ERC_KEY_INVALID, ERC_KEY_EMPTY, ERC_MEMORY_FAILURE, ERC_BUSY, ERC_GENERAL_ERROR		

Functional description

CSEc Command and Data Structure for CSE_PRAM content writes/reads is as follows:

Figure 37-10. Encrypt ECB input parameter format

	3	2	1	0	7	6	5	4	B	A	9	8	F	E	D	C
0	0x01	0x00	0x00	KeyID	Error Bits	Reserved										PAGE_LENGTH
1	PLAIN_TEXT 1															
2	PLAIN_TEXT 2															
3	PLAIN_TEXT 3															
4	PLAIN_TEXT 4															
5	PLAIN_TEXT 5															
6	PLAIN_TEXT 6															
7	PLAIN_TEXT 7															

Figure 37-11. Encrypt ECB output parameter format

	3	2	1	0	7	6	5	4	B	A	9	8	F	E	D	C
0	0x01	0x00	0x00	KeyID	Error Bits	Reserved										
1	CIPHER_TEXT 1															
2	CIPHER_TEXT 2															
3	CIPHER_TEXT 3															
4	CIPHER_TEXT 4															
5	CIPHER_TEXT 5															
6	CIPHER_TEXT 6															
7	CIPHER_TEXT 7															

37.5.11.6 CMD_ENC_CBC

The Encrypt CBC command operates on multiple 128-bit blocks of data. The function encrypts a number of PLAIN_TEXT (128-bits) blocks with the key identified by the KEY_ID (5-bits) and Initialization vector (IV), then returns CIPHER_TEXT (128-bits) blocks for each input block.

All data presented must be in 128-bit blocks (any padding must be done by the application).

Table 37-54. Encrypt CBC command details

Parameter	Direction	Width
KEY_ID	IN	5

Table continues on the next page...

Table 37-54. Encrypt CBC command details (continued)

Parameter	Direction	Width
PAGE_LENGTH	IN	16
PLAIN_TEXT	IN	n * 128
IV	IN	128
CIPHER_TEXT	OUT	n* 128
CIPHER_TEXT = ENC _{CBC,KEY, KEY_ID,IV} (PLAIN_TEXT)		
Error Codes: ERC_NO_ERROR, ERC_SEQUENCE_ERROR, ERC_KEY_NOT_AVAILABLE, ERC_KEY_INVALID, ERC_KEY_EMPTY, ERC_MEMORY_FAILURE, ERC_BUSY, ERC_GENERAL_ERROR		

Figure 37-12. Encrypt CBC input parameter format

	3	2	1	0	7	6	5	4	B	A	9	8	F	E	D	C
0	0x02	0x00	0x00	KeyID	Error Bits		Reserved									PAGE_LENGTH
1	IV															
2	PLAIN_TEXT 1															
3	PLAIN_TEXT 2															
4	PLAIN_TEXT 3															
5	PLAIN_TEXT 4															
6	PLAIN_TEXT 5															
7	PLAIN_TEXT 6															

Figure 37-13. Encrypt CBC output parameter format

	3	2	1	0	7	6	5	4	B	A	9	8	F	E	D	C
0	0x02	0x00	0x00	KeyID	Error Bits		Reserved									
1	IV															
2	CIPHER_TEXT 1															
3	CIPHER_TEXT 2															
4	CIPHER_TEXT 3															
5	CIPHER_TEXT 4															
6	CIPHER_TEXT 5															
7	CIPHER_TEXT 6															

Subsequent pages of information are provided, with the CallSeq field of the CSec Command Header indicating an ongoing operation is to be continued (i.e., change the CallSeq field from 0x00 to 0x01).

Figure 37-14. Continuation of input parameters

Functional description

	3	2	1	0	7	6	5	4	B	A	9	8	F	E	D	C
0	0x02	0x00	0x01	KeyID	Error Bits	Reserved										
1	PLAIN_TEXT 7															
2	PLAIN_TEXT 8															
3	PLAIN_TEXT 9															
4	PLAIN_TEXT 10															
5	PLAIN_TEXT 11															
6	PLAIN_TEXT 12															
7	PLAIN_TEXT 13															

Figure 37-15. Continuation of output parameters

	3	2	1	0	7	6	5	4	B	A	9	8	F	E	D	C
0	0x02	0x00	0x01	KeyID	Error Bits	Reserved										
1	CIPHER_TEXT 7															
2	CIPHER_TEXT 8															
3	CIPHER_TEXT 9															
4	CIPHER_TEXT 10															
5	CIPHER_TEXT 11															
6	CIPHER_TEXT 12															
7	CIPHER_TEXT 13															

Then continue transferring data in and out until the full CBC operation is complete.

37.5.11.7 CMD_DEC_ECB

The Decrypt ECB command operates on a single 128-bit block of data. The function decrypts a given CIPHER_TEXT (128-bits) with the key identified by the KEY_ID (5-bits), and returns PLAIN_TEXT (128-bits). This command may also be extended by using the CallSeq field to 0x01 for continued pages of data.

All data presented must be in 128-bit blocks (any padding must be done by the application).

Table 37-55. Decrypt ECB command details

Parameter	Direction	Width
KEY_ID	IN	5
PAGE_LENGTH	IN	16
CIPHER_TEXT	IN	n * 128
PLAIN_TEXT	OUT	n * 128

Table continues on the next page...

Table 37-55. Decrypt ECB command details (continued)

Parameter	Direction	Width
PLAIN_TEXT = DEC _{ECB,KEY, KEY_ID} (CIPHER_TEXT)		
Error Codes: ERC_NO_ERROR, ERC_SEQUENCE_ERROR, ERC_KEY_NOT_AVAILABLE, ERC_KEY_INVALID, ERC_KEY_EMPTY, ERC_MEMORY_FAILURE, ERC_BUSY, ERC_GENERAL_ERROR		

Figure 37-16. Decrypt ECB input parameter format

	3	2	1	0	7	6	5	4	B	A	9	8	F	E	D	C
0	0x03	0x00	0x00	KeyID	Error Bits	Reserved										PAGE_LENGTH
1	CIPHER_TEXT															
2	CIPHER_TEXT 2															
3	CIPHER_TEXT 3															
4	CIPHER_TEXT 4															
5	CIPHER_TEXT 5															
6	CIPHER_TEXT 6															
7	CIPHER_TEXT 7															

Figure 37-17. Decrypt ECB output parameter format

	3	2	1	0	7	6	5	4	B	A	9	8	F	E	D	C
0	0x03	0x00	0x00	KeyID	Error Bits	Reserved										
1	PLAIN_TEXT 1															
2	PLAIN_TEXT 2															
3	PLAIN_TEXT 3															
4	PLAIN_TEXT 4															
5	PLAIN_TEXT 5															
6	PLAIN_TEXT 6															
7	PLAIN_TEXT 7															

37.5.11.8 CMD_DEC_CBC

The Decrypt CBC command operates on multiple 128-bit blocks of data. The function decrypts a number of CIPHER_TEXT (128-bits) blocks with the key identified by the KEY_ID (5-bits) and Initialization vector (IV), then returns PLAIN_TEXT (128-bits) blocks for each input block.

Functional description

All data must be presented in 128-bit blocks (any padding must be done by the application).

Table 37-56. Decrypt CBC command details

Parameter	Direction	Width
KEY_ID	IN	5
PAGE_LENGTH	IN	16
IV	IN	128
CIPHER_TEXT	IN	n * 128
PLAIN_TEXT	OUT	n * 128
PLAIN_TEXT = DEC _{CBC,KEY, KEY_ID,IV} (CIPHER_TEXT)		
Error Codes : ERC_NO_ERROR, ERC_SEQUENCE_ERROR, ERC_KEY_NOT_AVAILABLE, ERC_KEY_INVALID, ERC_KEY_EMPTY, ERC_MEMORY_FAILURE, ERC_BUSY, ERC_GENERAL_ERROR		

Figure 37-18. Decrypt CBC input parameters

	3	2	1	0	7	6	5	4	B	A	9	8	F	E	D	C
0	0x04	0x00	0x00	KeyID	Error Bits	Reserved										PAGE_LENGTH
1	IV [0:15]															
2	CIPHER_TEXT 1															
3	CIPHER_TEXT 2															
4	CIPHER_TEXT 3															
5	CIPHER_TEXT 4															
6	CIPHER_TEXT 5															
7	CIPHER_TEXT 6															

Figure 37-19. Decrypt CBC output parameters

	3	2	1	0	7	6	5	4	B	A	9	8	F	E	D	C
0	0x04	0x00	0x00	KeyID	Error Bits	Reserved										
1	IV															
2	PLAIN_TEXT 1															
3	PLAIN_TEXT 2															
4	PLAIN_TEXT 3															
5	PLAIN_TEXT 4															
6	PLAIN_TEXT 5															
7	PLAIN_TEXT 6															

Subsequent pages of information are provided, with the CallSeq field of the CSEc Command Header indicating an ongoing operation is to be continued (i.e., change the CallSeq field from 0x00 to 0x01).

Figure 37-20. Continuation of input parameters

	3	2	1	0	7	6	5	4	B	A	9	8	F	E	D	C
0	0x04	0x00	0x01	KeyID	Error Bits	Reserved										
1	CIPHER_TEXT 7															
2	CIPHER_TEXT 8															
3	CIPHER_TEXT 9															
4	CIPHER_TEXT 10															
5	CIPHER_TEXT 11															
6	CIPHER_TEXT 12															
7	CIPHER_TEXT 13															

Figure 37-21. Continuation of output parameters

	3	2	1	0	7	6	5	4	B	A	9	8	F	E	D	C
0	0x04	0x00	0x01	KeyID	Error Bits	Reserved										
1	PLAIN_TEXT 7															
2	PLAIN_TEXT 8															
3	PLAIN_TEXT 9															
4	PLAIN_TEXT 10															
5	PLAIN_TEXT 11															
6	PLAIN_TEXT 12															
7	PLAIN_TEXT 13															

37.5.11.9 CMD_GENERATE_MAC

The Generate MAC command operates on a MESSAGE of length in bits of MESSAGE_LENGTH. The function uses a key (KEY_ID) to encode a MAC value (128-bits) for the full message body.

Data is processed in 128-bit blocks through MESSAGE_LENGTH number of bits, with padding done internally on the last block if not an integer divide by 128-bit.

Functional description

Output does not reflect the CMAC value until the full message has been processed, at which point it overwrites the second page of data as indicated in [Figure 37-25](#).

Table 37-57. Generate MAC command details

Parameter	Direction	Width
KEY_ID	IN	5
MESSAGE_LENGTH	IN	32
MESSAGE (DATA <n>)	IN	n * 128
MAC	OUT	128
MAC = CMAC _{KEY, KEY_ID} (MESSAGE, MESSAGE_LENGTH)		
Error Codes: ERC_NO_ERROR, ERC_SEQUENCE_ERROR, ERC_KEY_NOT_AVAILABLE, ERC_KEY_INVALID, ERC_KEY_EMPTY, ERC_MEMORY_FAILURE, ERC_BUSY, ERC_GENERAL_ERROR		

Figure 37-22. Generate MAC input parameters

	3	2	1	0	7	6	5	4	B	A	9	8	F	E	D	C
0	0x05	0x00	0x00	KeyID	Error Bits		Reserved					MESSAGE_LENGTH				
1	DATA 1															
2	DATA 2															
3	DATA 3															
4	DATA 4															
5	DATA 5															
6	DATA 6															
7	DATA 7															

Figure 37-23. Generate MAC output parameters

	3	2	1	0	7	6	5	4	B	A	9	8	F	E	D	C
0	0x05	0x00	0x00	KeyID	Error Bits		Reserved					MESSAGE_LENGTH				
1	DATA 1															
2	DATA 2															
3	DATA 3															
4	DATA 4															
5	DATA 5															
6	DATA 6															
7	DATA 7															

Figure 37-24. Continuation of input parameters

	3	2	1	0	7	6	5	4	B	A	9	8	F	E	D	C
0	0x05	0x00	0x01	KeyID	Error Bits		Reserved					MESSAGE_LENGTH				

Table continues on the next page...

	3	2	1	0	7	6	5	4	B	A	9	8	F	E	D	C
1	DATA 8															
2	DATA 9															
3	DATA 10															
4	DATA 11															
5	DATA 12															
6	DATA 13															
7	DATA 14															

Figure 37-25. Continuation of output parameters

	3	2	1	0	7	6	5	4	B	A	9	8	F	E	D	C
0	0x05	0x00	0x01	KeyID	Error Bits	Reserved						MESSAGE_LENGTH				
1	DATA 8															
2	MAC															
3	DATA 10															
4	DATA 11															
5	DATA 12															
6	DATA 13															
7	DATA 14															

37.5.11.10 CSEc format for CMD_GENERATE_MAC (pointer method)

For data that is contained fully within the NVM macro, the ‘pointer’ method of communication is used. For internal NVM space, the maximum size of data is limited to be no more than one read partition (512 KB max), or less if the starting address is not the start of the read partition (i.e., the address sequence cannot cross boundaries of read partitions). The 'Flash Start Address' must be 128-bit aligned (the same is true for CMD_VERIFY_MAC pointer method).

If CMD_GENERATE_MAC pointer method is executed on non-PFlash locations, the result will be unpredictable (the same is true for CMD_VERIFY_MAC pointer method).

Figure 37-26. CSEc format for GENERATE_MAC input parameters

	3	2	1	0	7	6	5	4	B	A	9	8	F	E	D	C
0	0x05	0x01	0x00	KeyID	Error Bits	Reserved						MESSAGE_LENGTH				
1	Flash Start Address				Reserved											
2	Reserved															
3	Reserved															

Table continues on the next page...

Functional description

	3	2	1	0	7	6	5	4	B	A	9	8	F	E	D	C
4																
5																
6																
7																

Figure 37-27. CSEc format for CMD_GENERATE_MAC output parameters

	3	2	1	0	7	6	5	4	B	A	9	8	F	E	D	C
0	0x05	0x01	0x00	KeyID	Error Bits	Reserved						MESSAGE_LENGTH				
1	Flash Start Address				Reserved											
2	MAC															
3	Reserved															
4																
5																
6																
7																

37.5.11.11 CMD_VERIFY_MAC

The Verify MAC command verifies a MAC of a given MESSAGE, which can be multiple 128-bit blocks of data, against a provided for MAC. The MESSAGE to compare, starting with the leftmost bit of the MAC, are given in the MESSAGE_LENGTH. The value 0 is not allowed and is interpreted by SHE to compare all bits of the MAC. The function returns an error if the length provided for message has another length than stated in MESSAGE_LENGTH. Input DATA1-DATAn until all messages are entered, with the expected MAC being the last entry after all DATA are input, i.e., MAC will be the position of block N+1 for 'N' number of DATA blocks.

All padding is to be done according to SHE specification using MESSAGE_LENGTH.

$$n = \text{CEIL}(\text{MESSAGE_LENGTH} / 128)$$

The first example shows 6 DATA blocks followed by the expected MAC, with the output overwriting the DATA1 block at the end of the operation with the MAC verification status.

The continuation examples show DATA1-10 by continuing from the first example but DATA7 would be written in place of the CMAC from the first example, followed by continuation with DATA8 which follows on the next page. Finally ending in DATA10 for this example, following with the expected CMAC value after the DATA 10 entry.

Table 37-58. Verify MAC command details

Parameter	Direction	Width
KEY_ID	IN	5
MESSAGE_LENGTH	IN	32
MESSAGE (DATA <n>)	IN	n * 128
MAC	IN	128
MAC_LENGTH (MAC Length[6:0])	IN	7
VERIFICATION_STATUS (Verification Status[0])	OUT	1
$MAC_{calc} = TRUNCATE(CMAC_{KEY, KEY_ID} (MESSAGE, MESSAGE_LENGTH), MAC_LENGTH)$ $MAC_{ref} = TRUNCATE (MAC, MAC_LENGTH)$ $VERIFICATION_STATUS = (0 \sim (MAC_{calc} - MAC_{ref}))$		
Error Codes: ERC_NO_ERROR, ERC_SEQUENCE_ERROR, ERC_KEY_NOT_AVAILABLE, ERC_KEY_INVALID, ERC_KEY_EMPTY, ERC_MEMORY_FAILURE, ERC_BUSY, ERC_GENERAL_ERROR		

Figure 37-28. Verify MAC input parameters

	3	2	1	0	7	6	5	4	B	A	9	8	F	E	D	C
0	0x06	0x00	0x00	KeyID	Error Bits		Reserved		MAC_LENGTH		Reserved		MESSAGE_LENGTH			
1	DATA 1															
2	DATA 2															
3	DATA 3															
4	DATA 4															
5	DATA 5															
6	DATA 6															
7	MAC															

Figure 37-29. Verify MAC output parameters

	3	2	1	0	7	6	5	4	B	A	9	8	F	E	D	C
0	0x06	0x00	0x00	KeyID	Error Bits		Reserved		MAC_LENGTH		Reserved		MESSAGE_LENGTH			
1					Verification Status	DATA 1										
2	DATA 2															
3	DATA 3															
4	DATA 4															

Table continues on the next page...

Functional description

	3	2	1	0	7	6	5	4	B	A	9	8	F	E	D	C
5	DATA 5															
6	DATA 6															
7	MAC															

Figure 37-30. Continuation of input parameters

	3	2	1	0	7	6	5	4	B	A	9	8	F	E	D	C
0	0x06	0x00	0x01	KeyID	Error Bits	Reserved	MAC_LENGTH		Reserved	MESSAGE_LENGTH						
1	DATA 8															
2	DATA 9															
3	DATA 10															
4	MAC															
5																
6																
7																

Figure 37-31. Continuation of output parameters

	3	2	1	0	7	6	5	4	B	A	9	8	F	E	D	C
0	0x06	0x00	0x01	KeyID	Error Bits	Reserved	MAC_LENGTH		Reserved	MESSAGE_LENGTH						
1					Verification Status	DATA 8										
2	DATA 9															
3	DATA 10															
4	MAC															
5																
6																
7																

37.5.11.12 CMD_VERIFY_MAC - CSEc format (pointer method)

Figure 37-32. Verify MAC (pointer method) input parameters

	3	2	1	0	7	6	5	4	B	A	9	8	F	E	D	C
0	0x06	0x01	0x00	KeyID	Error Bits	Reserved	MAC_LENGTH		Reserved	MESSAGE_LENGTH						
1	Flash Start Address				Reserved											

Table continues on the next page...

	3	2	1	0	7	6	5	4	B	A	9	8	F	E	D	C
2	MAC															
3	Reserved															
4																
5																
6																
7																

Figure 37-33. Verify MAC (pointer method) output parameters

	3	2	1	0	7	6	5	4	B	A	9	8	F	E	D	C
0	0x06	0x01	0x00	KeyID	Error Bits	Reserved	Reserved	MAC_LENGTH	Reserved	Reserved	MESSAGE_LENGTH					
1	Flash Start Address				Verification Status	Reserved										
2	MAC															
3	Reserved															
4																
5																
6																
7																

37.5.11.13 CMD_LOAD_KEY

The LOAD KEY command updates an internal key per the SHE specification. If a protected key is loaded into the RAM_KEY, the function has to disable the plain key status bit.

Table 37-59. LOAD_KEY command details

Parameter	Direction	Width
KEY_ID	IN	5
M1	IN	128
M2	IN	256
M3	IN	128
M4	OUT	256
M5	OUT	128
Error Codes: ERC_NO_ERROR, ERC_SEQUENCE_ERROR, ERC_KEY_NOT_AVAILABLE, ERC_KEY_INVALID, ERC_KEY_WRITE_PROTECTED, ERC_KEY_UPDATE_ERROR, ERC_KEY_EMPTY, ERC_MEMORY_FAILURE, ERC_BUSY, ERC_GENERAL_ERROR		

NOTE

1. Due to extension of the maximum number of keys (beyond SHE specification) and the usage of KBS to identify the higher and lower order keys, M1 entry will follow the traditional SHE specifications (requiring the two 4-bit ID and AuthID entries along with UID), but the command will need more information showing which KBS (0 or 1) is requested. This will be communicated by an additional requirement of entering the KEY_ID ({KBS,KeyIDx[3:0]}). Lastly, the KeyIDx[3:0] in M1 must be consistent with the KeyIDx[3:0] in the 5-bit KEY_ID entry in the command header.
2. If the key AuthID is empty, the key update can work with AuthID = ID and Auth_value = all Fs; otherwise ERC_KEY_UPDATE_ERROR is returned.
3. When updating BOOT_MAC, KBS must be set to 0 (KBS=1 will generate an error).
4. Once started, all required EEPROM quick write activities must be completed before executing this command. ERC_GENERAL_ERROR will be returned if this command is attempted while the EEPROM file system is awaiting quick write activity.

The PGMPART configuration (see Program Partition Command) allows for an extension to the SHE specification in which the user may enable a VERIFY_ONLY flag for the GENERATE_MAC to take into consideration. For the VERIFY_ONLY attribute, if set, the associated memory key slot will be treated as invalid by the CMD_GENERATE_MAC command (only valid for CMD_VERIFY_MAC). The VERIFY_ONLY attribute has no effect if KEY_USAGE == 0.

The SHE specification defines M2 as:

M2 - ENC_{CBD,K1,IV=0} (C_{ID}'F_{ID}'"0...0"₉₅ | K_{ID}') : SFE == 0x00

M2 - ENC_{CBD,K1,IV=0} (C_{ID}'F_{ID}'"0...0"₉₄ | K_{ID}') : SFE == 0x01

Table 37-60. F_{ID} & zero fill in M2 w/ SFE

PGMPART SFE field	M2 equation changes for LOAD_KEY	F _{ID}
SFE == 0x00 (VERIFY_ONLY flag not enabled, default SHE)	F _{ID} (5-bits)"0...0" ₉₅	{ WRITE_PROTECTION BOOT_PROTECTION DEBUGGER_PROTECTION KEY_USAGE WILDCARD }

Table continues on the next page...

Table 37-60. F_{ID} & zero fill in M2 w/ SFE (continued)

PGMPART SFE field	M2 equation changes for LOAD_KEY	F _{ID}
SFE == 0x01 (VERIFY_ONLY flag is enabled, enhanced SHE)	F _{ID} (6-bits) "0...0" ₉₄	{ WRITE_PROTECTION BOOT_PROTECTION DEBUGGER_PROTECTION KEY_USAGE WILDCARD VERIFY_ONLY }

When the optional SFE bit is set in the PGMPART command to enable the VERIFY_ONLY flag for CSEc keys, the F_{ID} field will be extended by one bit with the VERIFY_ONLY flag, and the adjacent zero fill field is reduced by one bit to be a total of 94-bits.

If SFE enabled, then the VERIFY_ONLY flag should be set to 1 for VERIFY_ONLY attribute to be enabled, and cleared to 0 for the VERIFY_ONLY attribute to be disabled for the particular key.

Figure 37-34. Load key input parameters

	3	2	1	0	7	6	5	4	B	A	9	8	F	E	D	C
0	0x07	0x00	0x01	KeyID	Error Bits	Reserved										
1												M1				
2												M2				
3																
4												M3				
5												Reserved				
6																
7																

Figure 37-35. Load key output parameters

	3	2	1	0	7	6	5	4	B	A	9	8	F	E	D	C
0	0x07	0x00	0x01	KeyID	Error Bits	Reserved										
1												M1				
2												M2				
3																
4												M3				
5												M4				
6																
7												M5				

37.5.11.14 CMD_LOAD_PLAIN_KEY

The Load Plain Key command, loads a key ‘KEY’ without encryption and does a verification of the key. The key is handed over in plain text. A plain key can only be loaded into the RAM_KEY slot (per SHE specification). The command sets the plain key status bit for the RAM_KEY. There is no return value. The FuncFormat and KeyID fields in the command header are ignored, while setting CallSeq to 0x01 will create a sequence error.

Table 37-61. LOAD_PLAIN_KEY command details

Parameter	Direction	Width
KEY	IN	128
KEY _{RAM_KEY} = key		
RAM_KEY_PLAIN = 1		
Error Codes: ERC_NO_ERROR, ERC_SEQUENCE_ERROR, ERC_BUSY, ERC_GENERAL_ERROR		

Figure 37-36. Load Plain Key input parameters

	3	2	1	0	7	6	5	4	B	A	9	8	F	E	D	C
0	0x08	0x00	0x00	KeyID	Error Bits	Reserved										
1	Plain Key															
2	Reserved															
3																
4																
5																
6																
7																

This command has no return values

37.5.11.15 CMD_EXPORT_RAM_KEY

The Export RAM Key command exports the RAM_KEY into a format protected by the SECRET_KEY. The key may be imported again by using the CMD_LOAD_KEY command.

A RAM_KEY can only be exported if it was written as plain text, i.e., by CMD_LOAD_PLAIN_KEY.

This command is for loading and unloading a RAM_KEY. The reserved fields for security flags and the counter are set to '0'.

No values other than M1, may leave SHE/CSEc.

NOTE

Due to setting the counter and flags to '0' by definition in the case of RAM_KEY updates, the first block of the encrypted message M_2 will become a constant '0' block.

Table 37-62. Export RAM_KEY command details

Parameter	Direction	Width
M1	OUT	128
M2	OUT	256
M3	OUT	128
M4	OUT	256
M5	OUT	128
K1 = KDF(KEY _{SECRET_KEY} , KEY_UPDATE_ENC_C) K2 = KDF(KEY _{SECRET_KEY} , KEY_UPDATE_MAC_C) C _{ID} = 0 (28-bits) F _{ID} = 0 (5-bits) M1 = UID ID _{RAM_KEY} ID _{SECRET_KEY} M2 = ENC _{CBC, K1, IV=0} (C _{ID} F _{ID} "0...0" ₉₅ KEY _{RAM_KEY}) = ENC _{CBC, K1, IV=0} ("0...0" ₁₂₈ KEY _{RAM_KEY}) M3 = CMAC _{K2} (M1 M2) K3 = KDF(KEY _{RAM_KEY} , KEY_UPDATE_ENC_C) K4 = KDF(KEY _{RAM_KEY} , KEY_UPDATE_MAC_C) M4 = UID ID _{RAM_KEY} ID _{SECRET_KEY} ENC _{EBC, K3} (C _{ID}) M5 = CMAC _{K4} (M4)		
Error Codes: ERC_NO_ERROR, ERC_SEQUENCE_ERROR, ERC_KEY_INVALID, ERC_KEY_EMPTY, ERC_MEMORY_FAILURE, ERC_BUSY, ERC_GENERAL_ERROR		

Figure 37-37. Export RAM_KEY input parameters

	3	2	1	0	7	6	5	4	B	A	9	8	F	E	D	C
0	0x09	0x00	0x00	KeyID	Error Bits		Reserved									
1	Reserved															
2	Reserved															
3	Reserved															
4	Reserved															
5	Reserved															
6	Reserved															
7	Reserved															

Figure 37-38. Export RAM_KEY output parameters

	3	2	1	0	7	6	5	4	B	A	9	8	F	E	D	C
0	0x09	0x00	0x00	KeyID	Error Bits		Reserved									
1											M1					
2											M2					
3																
4											M3					
5											M4					
6																
7											M5					

37.5.11.16 CMD_INIT_RNG

The INIT_RNG command initializes and derives a key for the PRNG. It must be called before the CMD_RND command and after every power cycle or reset. The FuncFormat, CallSeq, and KeyID fields of the command header are ignored.

Table 37-63. INIT_RNG command details

Parameter	Direction	Width
NONE		
The command has to ignore active debugger protection or secure boot protection flags on SECRET_KEY.		
NOTE: The command may need several hundred ms to return		
Error Codes : ERC_NO_ERROR, ERC_SEQUENCE_ERROR, ERC_MEMORY_FAILURE, ERC_BUSY, ERC_GENERAL_ERROR		

Figure 37-39. INIT_RNG input parameters

	3	2	1	0	7	6	5	4	B	A	9	8	F	E	D	C
0	0x0A	0x00	0x00	KeyID	Error Bits		Reserved									
1	Reserved															
2																
3																
4																
5																
6																
7																

The INIT_RNG command has no return values.

37.5.11.17 CMD_EXTEND_SEED

The EXTEND_SEED command extends the seed of the PRNG by compressing the former seed value and the supplied ENTROPY into a new seed. This new seed is then to be used to generate a random number by invoking the CMD_RND command. The random number generator must be initialized by CMD_INIT_RNG before the seed may be extended

Table 37-64. EXTEND_SEED command details

Parameter	Direction	Width
ENTROPY	IN	128
The command has to ignore active debugger protection or secure boot protection flags on SECRET_KEY.		
NOTE: The command may need several hundred ms to return		
Error Codes : ERC_NO_ERROR, ERC_SEQUENCE_ERROR, ERC_RNG_SEED, ERC_MEMORY_FAILURE, ERC_BUSY, ERC_GENERAL_ERROR		

Figure 37-40. EXTEND_SEED input parameters

	3	2	1	0	7	6	5	4	B	A	9	8	F	E	D	C
0	0x0B	0x00	0x00	KeyID	Error Bits		Reserved									
1	ENTROPY															
2	Reserved															
3																
4																
5																
6																
7																

The EXTEND_SEED command has no return values.

37.5.11.18 CMD_RND

The CMD_RND command returns a vector of 128 random bits.

The random number generator has to be initialized by CMD_INIT_RNG before random numbers can be supplied.

Functional description

The FuncFormat and KeyID fields in the command header are ignored, while setting CallSeq to 0x01 will generate a sequence error.

Table 37-65. CMD_RND command details

Parameter	Direction	Width
RND	OUT	128
IF (SREG _{RND_INIT} == 0) PRNG_STATE _i = ENC _{ECB,KEY PRNG_KEY} (PRNG_STATE _{i-1}) RND = PRNG_STATE _i END IF		
Error Codes : ERC_NO_ERROR, ERC_SEQUENCE_ERROR, ERC_RNG_SEED, ERC_MEMORY_FAILURE, ERC_BUSY, ERC_GENERAL_ERROR		

Figure 37-41. CMD_RND input parameters

	3	2	1	0	7	6	5	4	B	A	9	8	F	E	D	C
0	0x0C	0x00	0x00	KeyID	Error Bits		Reserved									
1	Reserved															
2	Reserved															
3	Reserved															
4	Reserved															
5	Reserved															
6	Reserved															
7	Reserved															

Table 37-66. CMD_RND Output Parameters

	3	2	1	0	7	6	5	4	B	A	9	8	F	E	D	C
0	0x0C	0x00	0x00	KeyID	Error Bits		Reserved									
1	RND															
2	Reserved															
3	Reserved															
4	Reserved															
5	Reserved															
6	Reserved															
7	Reserved															

37.5.11.19 CMD_SECURE_BOOT

This command is not supported by the FTFM/CSEc module. See the new command 'CMD_BOOT_DEFINE' which configures the type of secure boot to execute. Parts enabled with the CSEc feature will always execute the configured secure boot type upon reset.

The CSEc feature runs autonomously, reading custom parameters from the flash and verifies the MAC. The size of secure boot is defined by BOOT_SIZE. On CSEc enabled parts with Flash Keys allocated, secure boot is enabled by programming of the BOOT_MAC_KEY.

The secure boot parameters are entered via the CMD_BOOT_DEFINE command.

37.5.11.20 CMD_BOOT_FAILURE

This command may be used when checking additional blocks of information after the autonomous secure boot finishes (per CMD_BOOT_DEFINE configuration).

Table 37-67. CMD_BOOT_FAILURE Command Details

Parameter	Direction	Width
NONE		
<p>The command will impose the same sanctions as CMD_SECURE_BOOT would if it detects a failure, but can be used in later stages of the boot process.</p> <p>CMD_BOOT_FAILURE may only be called once after every power cycle/reset and may only be called if SECURE_BOOT did not detect any errors before and if CMD_BOOT_OK was not called.</p> <p>NOTE : CSEc module provides for the first autonomous stage of the secure boot process (if so configured with BOOT_DEFINE), thus this function can be used during the following stages to provide the boot status to CSEc.</p> <p>IF (SREG_SECURE_BOOT == 1 AND SREG_BOOT_OK == 1 AND SREG_BOOT_FINISHED == 0)</p> <p>SREG_BOOT_FINISHED = 1</p> <p>SREG_BOOT_OK = 0</p> <p>END IF</p>		
<p>Error Codes : ERC_NO_ERROR, ERC_SEQUENCE_ERROR, ERC_NO_SECURE_BOOT, ERC_BUSY, ERC_GENERAL_ERROR</p>		

Table 37-68. CMD_BOOT_FAILURE Input Parameters

	3	2	1	0	7	6	5	4	B	A	9	8	F	E	D	C
0	0x0E	0x00	0x00	KeyID	Error Bits		Reserved									
1	Reserved															
2	Reserved															

Table continues on the next page...

Table 37-68. CMD_BOOT_FAILURE Input Parameters (continued)

	3	2	1	0	7	6	5	4	B	A	9	8	F	E	D	C
3																
4																
5																
6																
7																

37.5.11.21 CMD_BOOT_OK

This command may be used when checking additional blocks of information after the autonomous secure boot finishes (per CMD_BOOT_DEFINE configuration).

Table 37-69. CMD_BOOT_OK Command Details

Parameter	Direction	Width
NONE		
<p>The command is used to mark successful boot verification for later stages than the autonomous SECURE_BOOT (operation defined by CMD_BOOT_DEFINE). In particular it is meant to lock the command CMD_BOOT_FAILURE.</p> <p>CMD_BOOT_OK may only be called once after every power cycle/reset and may only be called if SECURE_BOOT did not detect any errors before and if CMD_BOOT_FAILURE was not called.</p> <p>NOTE : CSEc module provides for the first autonomous stage of the secure boot process (if so configured with BOOT_DEFINE), thus this function can be used during the following stages to provide the boot status to CSEc.</p> <p>IF (SREG_SECURE_BOOT == 1 AND SREG_BOOT_OK == 1 AND SREG_BOOT_FINISHED == 0)</p> <p>SREG_BOOT_FINISHED = 1</p> <p>END IF</p> <p>Error Codes : ERC_NO_ERROR, ERC_SEQUENCE_ERROR, ERC_NO_SECURE_BOOT, ERC_BUSY, ERC_GENERAL_ERROR</p>		

Table 37-70. CMD_BOOT_OK Input Parameters

	3	2	1	0	7	6	5	4	B	A	9	8	F	E	D	C
0	0x0F	0x00	0x00	KeyID	Error Bits	Reserved										
1	Reserved															
2	Reserved															
3	Reserved															
4	Reserved															
5	Reserved															
6	Reserved															
7	Reserved															

37.5.11.22 CMD_GET_STATUS

This command is implemented via STATUS registers FCSESTAT1 and FCSESTAT0.

37.5.11.23 CMD_GET_ID

The GET_ID command returns the UID and the value of the status register (protected by a MAC over a challenge and the data). If the MASTER_ECU_KEY is empty, the MAC returned value is set to '0'.

The KeyID field in the command header is ignored as the MASTER_ECU_KEY is the only valid key to be considered.

Table 37-71. GET_ID command details

Parameter	Direction	Width
CHALLENGE	IN	128
ID	OUT	120
SREG	OUT	8
MAC	OUT	128
ID = UID		
MAC = CMAC _{KEY_MASTER_ECU_KEY} (CHALLENGE ID SREG)		
Error Codes : ERC_NO_ERROR, ERC_SEQUENCE_ERROR, ERC_KEY_NOT_AVAILABLE, ERC_MEMORY_FAILURE, ERC_GENERAL_ERROR		

Figure 37-42. GET_ID input parameters

	3	2	1	0	7	6	5	4	B	A	9	8	F	E	D	C
0	0x10	0x00	0x00	KeyID	Error Bits	Reser ved	Reserved									
1	CHALLENGE															
2	Reserved															
3																
4																
5																
6																
7																

Figure 37-43. GET_ID output parameters

Functional description

	3	2	1	0	7	6	5	4	B	A	9	8	F	E	D	C
0	0x10	0x00	0x00	KeyID	Error Bits		Reserved									
1	CHALLENGE															
2	ID															SRE G
3	MAC															
4	Reserved															
5																
6																
7																

37.5.11.24 CMD_CANCEL

This command is not strictly supported by the FTFM module. The user should manage software driven commands accordingly.

For any CSEc command that is executed in a series of continued commands, the command may be 'cancelled' by one of a few mechanisms.

For example, streams of CBC encode data that is processed through continuations of inputting data through the CSE_PRAM seven block input buffer, could be 'cancelled' by giving an illegal continuation of the next segment of data by clearing the CallSeq field in the command header, or changing the FuncID to a different command. Each will generate a sequence error which will kill/cancel the ongoing command.

Additionally, starting any CCOB command in one of the pauses of continuation of a CSEc command will result in the CCOB command executing to completion as expected, but will kill/cancel the current CSEc command.

37.5.11.25 CMD_BOOT_DEFINE

This is a non-SHE specified command that allows the user to define both the User BOOT_SIZE (boot code size of data is in the message length in number of bits to run CMAC on each reset), and the 'flavor' of boot (strict, sequential, parallel, none).

The FuncFormat, CallSeq, and KeyID fields in the command header are not used.

NOTE

1. **Warning:** If the 'Strict Boot' option is chosen and the CMAC supplied doesn't match the CMAC calculated, then the part will be hung in reset. Additionally since the boot

flavor can't be changed once 'Strict' is chosen, this error will not be able to be reversed. Make sure to verify the CMAC and full boot process is completing and passing as expected BEFORE selecting the 'Strict' boot flavor.

Additionally, even though Strict Boot may not be changed once set, it is possible to change the code contents and associated BOOT_MAC and BOOT_SIZE. But if a reset or any interruption of the part occurs between updating code and matching BOOT_MAC and BOOT_SIZE with the 'Strict Boot' option enabled, the result will be a mismatch of BOOT_MAC to calculated CMAC and the part will be stuck in reset.

2. The autonomous Secure Boot is run on the PFlash block starting at address '0' and finishing at BOOT_SIZE # of bits later. Subsequent Boot Code checks at other addresses may be run later via CMD_VEFIFY_MAC command(s) with the end of the secure boot process being followed by either CMD_BOOT_OK or CMD_BOOT_FAILURE.
3. Once started, all required EEPROM quick write activities must be completed before executing this command. ERC_GENERAL_ERROR will be returned if this command is attempted while the EEPROM file system is awaiting quick write activity.

Table 37-72. BOOT_DEFINE command details

Parameter	Direction	Width
BOOT_SIZE (# Bytes * 8, or Number of Bits : minimum size is 1 bit : maximum size is 512 KB)	IN	32
Boot Flavor 00 : Strict Sequential Boot method (SHE Optional boot - OTP: Once set, cannot be changed) 01 : Sequential Boot method 10 : Parallel Boot method 11 : No Boot defined, not initialized yet	IN	8
Error Codes: ERC_NO_ERROR, ERC_SEQUENCE_ERROR, ERC_KEY_INVALID, ERC_MEMORY_FAILURE, ERC_BUSY, ERC_GENERAL_ERROR		

Figure 37-44. BOOT DEFINE input parameter format

Functional description

	3	2	1	0	7	6	5	4	B	A	9	8	F	E	D	C	
0	0x11	0x00	0x00	KeyID	Error Bits		Reserved										
1	Reserved											Boot Flavor	BOOT_SIZE				
2	Reserved																
3	Reserved																
4	Reserved																
5	Reserved																
6	Reserved																
7	Reserved																

37.5.11.26 CMD_DBG_CHAL

The SHE CMD_DEBUG command is modified and split into two steps in CSEc commands: CMD_DBG_CHAL followed by CMD_DBG_AUTH. The CMD_DBG_CHAL/AUTH command pair must be followed by a subsequent reset before PGMPART command may be re-issued.

The CMD_DBG_CHAL command is issued to request a random number which the user will use along with the MASTER_ECU_KEY and UID to return a authorization request using the CMD_DBG_AUTH command.

NOTE

The CMD_DBG_CHAL command must be followed by the CMD_DBG_AUTH command, otherwise the CMD_DBG_CHAL command would be required to be re-issued before continuing.

Table 37-73. DEBUG command details

Parameter	Direction	Width
CHALLENGE	OUT	128

Error Codes : ERC_NO_ERROR, ERC_SEQUENCE_ERROR, ERC_WRITE_PROTECTED, ERC_RNG_SEED, ERC_NO_DEBUGGING, ERC_MEMORY_FAILURE, ERC_BUSY, ERC_GENERAL_ERROR

Figure 37-45. DEBUG input parameters

	3	2	1	0	7	6	5	4	B	A	9	8	F	E	D	C
0	0x12	0x00	0x00	KeyID	Error Bits		Reserved									
1	Reserved															
2	Reserved															

Table continues on the next page...

	3	2	1	0	7	6	5	4	B	A	9	8	F	E	D	C
3																
4																
5																
6																
7																

Figure 37-46. DEBUG output parameters

	3	2	1	0	7	6	5	4	B	A	9	8	F	E	D	C
0	0x12	0x00	0x00	KeyID	Error Bits	Reserved										
1	CHALLENGE															
2	Reserved															
3																
4																
5																
6																
7																

37.5.11.27 CMD_DBG_AUTH

The CMD_DBG_AUTH command, executed after completion of a CMD_DBG_CHAL command, erases all keys (actual and outdated) stored in NVM memory.

NOTE

If the WRITE_PROTECTION flag has been set on any of the keys, the CMD_DEBUG does not execute the erase of any keys. This also implies that the ERSALL and ERSALLU commands and the erase all operation that is triggered external to the FTFM will not be able to execute.

After CSEc confirms authentication, the Flash Keys are erased. If any key has the WRITE_PROTECTION flag set, the command will stop and not offer any failure analysis mode.

After SHE authentication of the process passes, the command will erase the Flash Keys (EFlash), placing the part back into factory status.

The command cannot be executed if authentication fails.

The command ignores active debugger protection and secure boot protection flags as well as empty keys.

Functional description

After successful authentication, the DFlash User IFR, DFlash space, and Flash Keys (including EFlash and FlexRAM space) have been erased. Then, a reset must be performed. At this point, the FlexRAM is no longer configured for emulated EEPROM and is now available as traditional RAM (EEERDY=0, RAMRDY=1).

Table 37-74. CMD_DBG_AUTH

Parameter	Direction	Width
AUTHORIZATION	IN	128
SHE & Backend: $K = KDF(\text{KEY}_{\text{MASTER_ECU_KEY}}, \text{DEBUG_KEY_C})$ SHE: $\text{CHALLENGE} = \text{CMD_RND}()$ Backend: $\text{AUTHORIZATION} = \text{CMAC}_K(\text{CHALLENGE} \parallel \text{UID})$		
Error Codes: ERC_NO_ERROR, ERC_SEQUENCE_ERROR, ERC_WRITE_PROTECTED, ERC_RNG_SEED, ERC_NO_DEBUGGING, ERC_MEMORY_FAILURE, ERC_BUSY, ERC_GENERAL_ERROR		

Figure 37-47. DBG_AUTH input parameters

	3	2	1	0	7	6	5	4	B	A	9	8	F	E	D	C
0	0x13	0x00	0x00	KeyID	Error Bits		Reserved									
1	AUTHORIZATION															
2	Reserved															
3																
4																
5																
6																
7																

37.5.11.28 CMD_MP_COMPRESS

The MP_COMPRESS command accesses a Miyaguchi-Prenell compression feature within the CSEc feature set. This function, provided with the AES as a block cipher, is used as a compression function. Messages must be pre-processed per SHE specification if they do not already meet the full 128-bit block size requirement, i.e., the user/application is responsible for padding if the message is not already 128-bits in length.

For this command the PAGE_LENGTH is to be input as the number of 128-bit pages and the KeyID field is ignored.

Table 37-75. MP Compress command details

Parameter	Direction	Width
DATA <n>	IN	n * 128
PAGE_LENGTH	IN	16
MP_COMPRESS	OUT	128
Error Codes : ERC_NO_ERROR, ERC_SEQUENCE_ERROR, ERC_GENERAL_ERROR		

Figure 37-48. MP compress input parameters

	3	2	1	0	7	6	5	4	B	A	9	8	F	E	D	C
0	0x16	0x00	0x00	KeyID	Error Bits		Reserved								PAGE_LENGTH	
1	DATA 1															
2	DATA 2															
3	DATA 3															
4	DATA 4															
5	DATA 5															
6	DATA 6															
7	DATA 7															

Figure 37-49. MP compress output parameters

	3	2	1	0	7	6	5	4	B	A	9	8	F	E	D	C
0	0x16	0x00	0x00	KeyID	Error Bits		Reserved								PAGE_LENGTH	
1	MP_COMPRESS															
2	DATA 2															
3	DATA 3															
4	DATA 4															
5	DATA 5															
6	DATA 6															
7	DATA 7															

Figure 37-50. Continuation of input parameters

	3	2	1	0	7	6	5	4	B	A	9	8	F	E	D	C
0	0x16	0x00	0x01	KeyID	Error Bits		Reserved								PAGE_LENGTH	

Table continues on the next page...

Functional description

	3	2	1	0	7	6	5	4	B	A	9	8	F	E	D	C
1	DATA 8															
2	DATA 9															
3	DATA 10															
4	DATA 11															
5	DATA 12															
6	DATA 13															
7	DATA 14															

Figure 37-51. Continuation of output parameters

	3	2	1	0	7	6	5	4	B	A	9	8	F	E	D	C
0	0x16	0x00	0x01	KeyID	Error Bits	Reserved									PAGE_LENGTH	
1	MP_COMPRESS															
2	DATA 9															
3	DATA 10															
4	DATA 11															
5	DATA 12															
6	DATA 13															
7	DATA 14															

37.5.12 Reset sequence

On each system reset the FTFM module executes a sequence which establishes initial values for the flash block configuration parameters, FPROT, FDPROT, FEPROT, FOPT, and FSEC registers and the FCNFG[RAMRDY, EEERDY] flags. The FlexRAM is initialized to all 1s while the CSE_PRAM is initialized to all 0s.

Boot will proceed according to the configuration set by the BOOT_DEFINE command (secure boot or not, and what type of secure boot).

CCIF is cleared throughout the reset sequence. The FTFM module holds off all CPU access for a portion of the reset sequence. Flash reads are possible when the hold is removed. Completion of the reset sequence is marked by setting CCIF which enables flash user commands.

If a reset occurs while any FTFM command is in progress, that command is immediately aborted. The state of the data being programmed or the sector/block being erased is not guaranteed. Commands and operations do not automatically resume after exiting reset.

37.5.12.1 Reset sequence fault handling

The flash memory controller handles all reset sequence activities. The controller executable code is mainly stored in dedicated flash firmware space and is supported by a dedicated RAM.

The flash reset sequence will terminate after experiencing certain uncorrectable ECC faults during firmware execution and crucial data transfers. Flags in both the FSTAT and FERSTAT registers will reflect the fault condition and the corresponding interrupt will be asserted, if enabled in the FERCNFG register. See the FSTAT flag descriptions to determine the impact of the fault on flash resource availability.

The handling of uncorrectable ECC faults detected during the reset sequence is shown in the following table.

Table 37-76. Reset Sequence Fault Handling

Condition (when uncorrectable ECC fault is detected during the reset sequence)	FSTAT Flag	FERSTAT Flag
While reading the Flash Configuration Field ¹	MGSTAT0	
While reading the partition information in the DFlash User IFR		
Prior to or during EEPROM determination (except while reading the Flash Configuration Field or the partition information in the DFlash User IFR)	MGSTAT3	CDFDIF
After determining EEPROM is not present	MGSTAT1	CDFDIF
During EEPROM initialization with the CSEc feature disabled	MGSTAT2	CDFDIF or EDFDIF
During EEPROM initialization with the CSEc feature enabled	MGSTAT3	CDFDIF or EDFDIF
After EEPROM initialization with the CSEc feature disabled	MGSTAT1	CDFDIF
After EEPROM initialization and CSEc boot type determination unless during MAC compare operation in CSEc strict sequential boot mode	MGSTAT1	CDFDIF or EDFDIF
During MAC compare operation in CSEC strict sequential boot mode ²		

1. See [Flash configuration field fault handling](#).

2. While flags are not set, access to the PFlash, DFlash, FlexRAM, CSE_PRAM and the memory controller will be blocked.

Chapter 38

Quad Serial Peripheral Interface (QuadSPI)

38.1 Chip-specific QuadSPI information

38.1.1 Overview

S32K148 has one instance of QuadSPI. Other products in the S32K1xx series do not have QuadSPI.

See the device Data Sheet for details about target frequencies.

The Quad Serial Peripheral Interface (QuadSPI) block acts as an interface to external serial flash device. It supports SDR and HyperRAM modes upto 4 and 8 bidirectional data lines respectively.

NOTE

The following are not supported:

- AHB Write
- Data learning feature
- Breakpoint and Watchpoint memory regions
- QuadSPI in 100-pin LQFP

38.1.2 Memory size requirement

QuadSPI memory size requirement for AHB Buffers is : 128x64 , i.e. 1 KB.

38.1.3 QuadSPI register reset values

Table 38-1. QuadSPI register reset values

Register	Reset value
Module Configuration Register (QuadSPI_MCR)	000F_400C
Buffer0 Configuration Register (QuadSPI_BUF0CR)	0000_0003
Buffer1 Configuration Register (QuadSPI_BUF1CR)	0000_0002
Buffer2 Configuration Register (QuadSPI_BUF2CR)	0000_0001
Buffer3 Configuration Register (QuadSPI_BUF3CR)	0000_0000
Serial Flash A1 Top Address (QuadSPI_SFA1AD)	6C00_0000
Serial Flash A2 Top Address (QuadSPI_SFA2AD)	6C00_0000
Serial Flash B1 Top Address (QuadSPI_SFB1AD)	7000_0000
Serial Flash B2 Top Address (QuadSPI_SFB2AD)	7000_0000

38.1.4 Use case

The primary application use-cases for the QuadSPI and external memory are:

- Handwriting recognition – External flash acts a store for font/character data.
- RDS Radio – External RAM used for temporary storage of RDS data.

38.1.5 Supported read modes

Read modes		QuadSPI_MC R[DDR_EN]	QuadSPI_MC R[DQS_EN]	Mode supported	Data learning support	
SDR Mode (Flash A)	Internal sampling (N/1)	0	0	Yes	No	
	DQS sampling method	Internally generated DQS	0	1	Yes	No
		External DQS	0	1	No	No
		Loopback DQS	0	1	Yes	No
SDR Mode (Flash B)	Internal sampling (N/1)	0	0	Yes	No	
	DQS sampling method	Internally generated DQS	0	1	No	No
		External DQS	0	1	No	No
		Loopback DQS	0	1	No	No
HyperRAM (DDR)	Internal sampling (4x method)	1	0	No	No	
	DQS sampling method	Internally generated DQS	1	1	No	No
		External DQS	1	1	Yes	No
		Loopback DQS	1	1	No	No

38.1.6 External memory options

The QuadSPI supports an A-side and a B-side. The A-side of the QuadSPI is connected to the fast pads (80 MHz) while the B-side connects to the 20 MHz pads. See datasheet for operating values.

Only one external memory will be supported in any given application and it will not be permitted to run the A-side and the B-side of the QuadSPI simultaneously. As such the following external memory options can be supported:

- A single Quad Flash on the A-side or
- A single HyperRAM on the B-side or
- A single Quad Flash on the B-side.

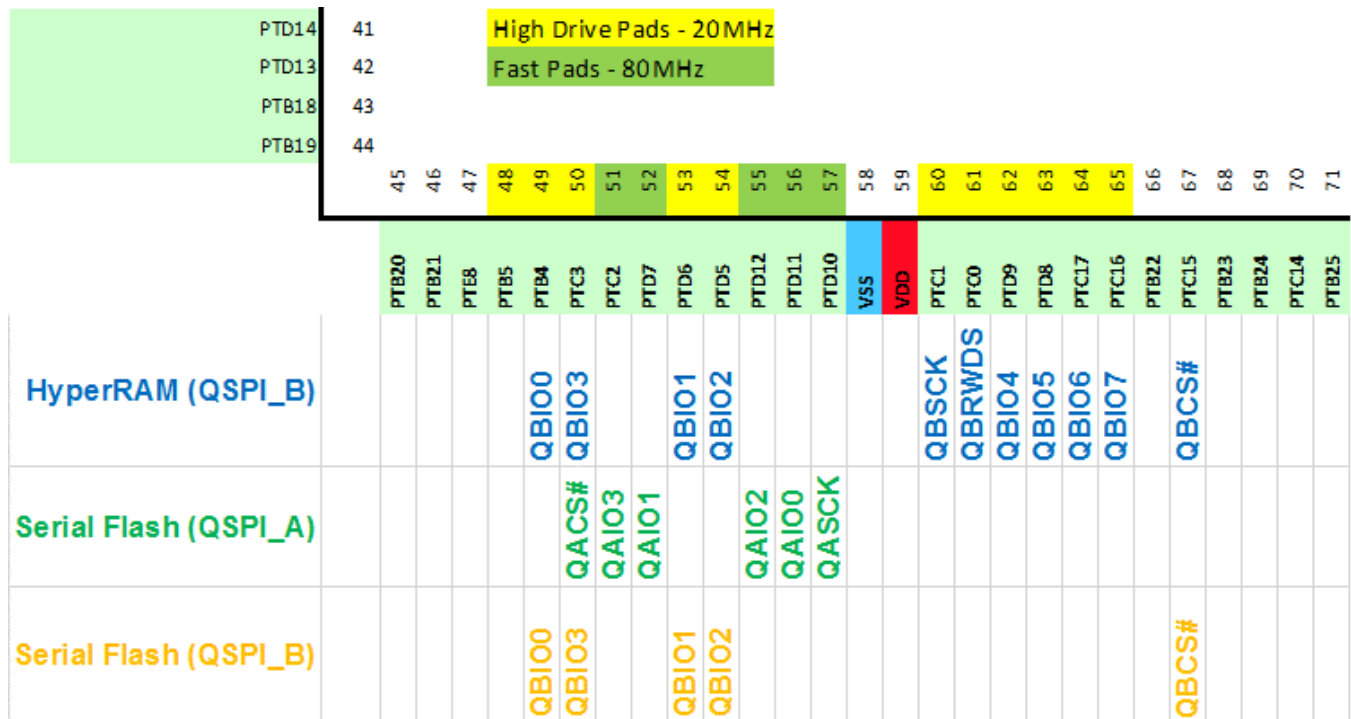

Figure 38-1. External memory options

38.1.7 Recommended software configuration

- QuadSPI operation is restricted to system clock as SPLL.
- When switching the system modes between HSRUN and RUN, QuadSPI should be disabled and then re-enabled.

- The software configuration options provided for QuadSPI through registers SOC_CONFIG and SCLK_CONFIG should be done before enabling clock of QuadSPI.
- Configure the QuadSPI module before configuring the ALT mode selection for selecting QuadSPI pads.

NOTE

- User should ensure that communication is complete on QuadSPI before low power mode entry is initiated.
- Divider values of programmable divider (see QuadSPI clocking diagram in [Module clocks](#) for details) should be programmed before enabling it. The divider is enabled by default.

38.1.8 Recommended programming sequence

Following is the recommended programming sequence:

1. Enable PCC_QSPI[CGC]
2. Program QuadSPI_MCR[SCLKCFG] and QuadSPI_SOCCR[SOCCFG]
3. Program QuadSPI_MCR[MDIS] to 0

38.1.9 Clock ratio between QuadSPI clocks

Below clock relationship should be maintained between SFIF_CLK (flash internal reference clock) and AHB read interface clock (bus clock) of QuadSPI :

- $SFIF_CLK \leq AHB \text{ read interface clock}$

38.1.10 QuadSPI_MCR[SCLKCFG] implementation

Table 38-2. QuadSPI_MCR[SCLKCFG] bit field description

Bit field name	Bit field description
SCLKCFG[7]	Enables input buffer of QSPI pads for SDR and HyperRAM modes 0: ibe of all QSPI pads disabled 1: ibe of all QSPI pads enabled
SCLKCFG[6]	Quadspi Clocking mode selection. Always program SCLKCFG[6] twice while configuring mode selection. 0: Selecting SYS_CLK as AHB read interface Clock and module clock. Mandatory for HSRUN 80/RUN 64/RUN 80 configurations.

Table continues on the next page...

**Table 38-2. QuadSPI_MCR[SCLKCFG] bit field description
(continued)**

Bit field name	Bit field description
	1: Selecting BUS_CLK as AHB read interface clock and module clock. Mandatory for HSRUN 112 configuration.
SCLKCFG[5]	<p>HyperRAM selection for Flash B - Reference clock selection for DQS for Flash-B</p> <p>0: Clock from SCLKCFG [3] selected as DQS (HyperRAM Disabled)</p> <p>1: External RWDS from Flash B selected as DQS (HyperRAM Enabled)</p> <p>NOTE: When HyperRAM is enabled , the 2 x Internal reference clock clock is also required by QuadSPI apart from sfif clock as HyperRAM is a DDR protocol. If user has configured PLAT_CLK at 80 MHz then the PCC divider for Quadspi asynchronous clock selection must be programmed to divby2 and SCLKCFG[5] must be programmed to 1 for HyperRAM functional operation.</p>
SCLKCFG[4]	<p>Internal reference clock (async clock domain) source selection for Quadspi</p> <p>0: PLL_DIV1 is clock source of Quadspi Internal reference Clock</p> <p>1: FIRC_DIV1 is clock source of Quadspi Internal reference Clock</p>
SCLKCFG[3]	<p>Reference clock selection for DQS for Flash-B</p> <p>0: Inverted Clock from SCLKCFG [2] selected as DQS</p> <p>1: Clock from SCLKCFG [2] selected as DQS</p>
SCLKCFG[2]	<p>Reference clock selection for DQS for Flash-B</p> <p>0: Internal Reference Clock selected as DQS</p> <p>1: Loopback clock from PAD SCKB selected as DQS</p>
SCLKCFG[1]	<p>Reference clock selection for DQS for Flash-A</p> <p>0: Inverted Clock from SCLKCFG [0] selected as DQS</p> <p>1: Clock from SCLKCFG [0] selected as DQS</p>
SCLKCFG[0]	<p>Reference clock selection for DQS for Flash-A</p> <p>0: Internal Reference Clock selected as DQS</p> <p>1: Loopback clock from PAD SCKA selected as DQS</p>

38.1.11 QuadSPI_SOCCR[SOC CFG] implementation

Table 38-3. QuadSPI_SOCCR[SOC CFG] bit field description

Bit field name	Bit field description
SOC CFG[7:0]	<p>SOC configuration: Fine delay chain configuration for Flash A</p> <p>7F: Delay of 127 buffers and 128 muxes</p> <p>7E :Delay of 126 buffers and 127 muxes</p> <p>7D :Delay of 125 buffers and 126 muxes</p> <p>-</p> <p>-</p> <p>-</p>

Table continues on the next page...

**Table 38-3. QuadSPI_SOCCR[SOCCFG] bit field description
(continued)**

Bit field name	Bit field description
	3F: Delay of 63 buffers and 64 muxes 3E: Delay of 62 buffers and 63 muxes 3D: Delay of 61 buffers and 62 muxes - - - 0: Delay of 0 buffer and 1 mux
SOCCFG[15:8]	SOC configuration: Fine delay chain configuration for Flash B 7F: Delay of 127 buffers and 128 muxes 7E :Delay of 126 buffers and 127 muxes 7D :Delay of 125 buffers and 126 muxes - - - 3F: Delay of 63 buffers and 64 muxes 3E: Delay of 62 buffers and 63 muxes 3D: Delay of 61 buffers and 62 muxes - - - 0: Delay of 0 buffer and 1 mux
SOCCFG[16]	Pending read enable controls the bus gasket’s handling of pending read transactions. 0: Pending reads are disabled. 1: Pending reads are enabled, yielding a performance improvement through the gasket.
SOCCFG[17]	Burst read enable controls the bus gasket’s handling of burst read transactions. 0: Burst reads are converted into a series of single transactions on the slave side of the gasket. 1: Burst reads are optimized for best system performance.
SOCCFG[18]	Burst writes enable controls the bus gasket’s handling of burst read transactions. 0: Burst writes are converted into a series of single transactions on the slave side of the gasket. 1: Burst writes are optimized for best system performance. Note this setting treats writes as “imprecise” such that an error response on any beat of the burst is reported on the last beat.
SOCCFG[28]	Programmable Divider Disable. 0: Divider enabled 1: Divider disabled
SOCCFG[31:29]	Programmable divider configuration selection. 000 : Div by 1 001 : Div by 2

Table 38-3. QuadSPI_SOCCR[SOCCFG] bit field description

Bit field name	Bit field description
	010 : DIV by 3 011 : DIV by 4 100 : DIV by 5 101 : DIV by 6 110 : DIV by 7 111 : DIV by 8

38.2 Introduction

The Quad Serial Peripheral Interface (QuadSPI) block acts as an interface to a single or two external serial flash devices, each with up to eight bidirectional data lines.

38.2.1 Features

The QuadSPI supports the following features:

- Flexible sequence engine to support various flash vendor devices. As there is no specific standard, the module supports various kind of flashes from different vendors. Refer [Serial Flash Devices](#) for example sequences.
- Single, dual, quad and octal modes of operation.
- Double data rate (DDR)/Double transfer rate (DTR) mode wherein the data is generated on every edge of the serial flash clock.
- Support for flash data strobe signal for data sampling in DDR and Single data rate (SDR) mode.
- Support for HyperRAM.
- AHB master to read RX Buffer data via AMBA AHB bus (64-bit width interface) or IP registers space (32-bit access) and fill TX Buffer via IPS register space (32-bit access).
 - AHB master can be a DMA with configurable inner loop size.
- Multimaster accesses with priority
 - Flexible and configurable buffer for each master

- Multiple interrupt conditions (see [Table 38-12](#))
- All AHB accesses to flash devices are directly memory mapped to the chip system memory.
- Programmable sequence engine to cater to future command/protocol changes and able to support all existing vendor commands and operations. Software needs to select the corresponding sequence according to the connected flash device.
 - Supports all types of addressing.

38.2.2 Block Diagram

The following figure is a block diagram of the Quad Serial Peripheral Interface (QuadSPI) module.

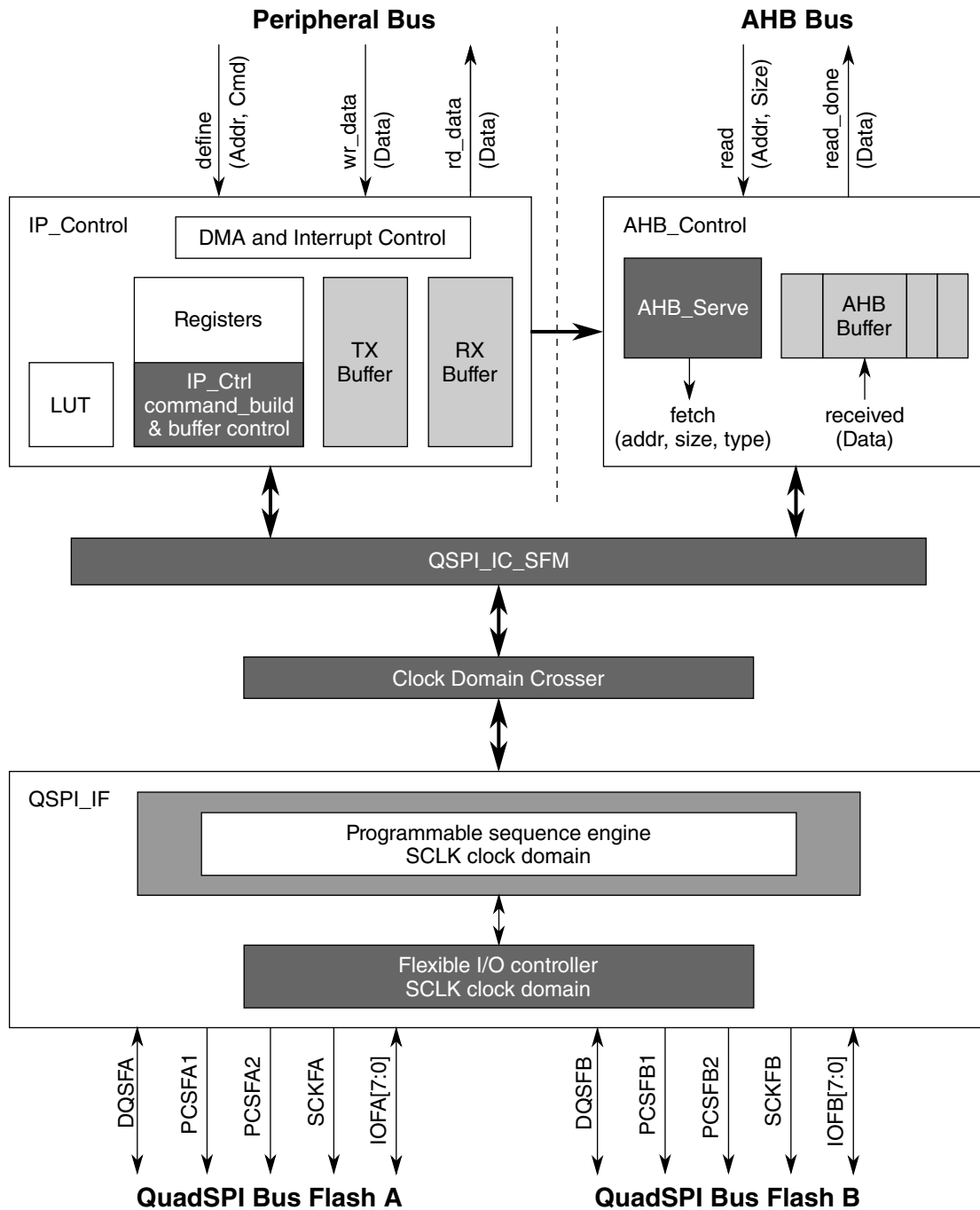

Figure 38-2. QuadSPI Block Diagram

38.2.3 QuadSPI Modes of Operation

For power management through IPS interface access and correct config register programming sequences, QuadSPI supports three modes: normal, module disable and stop mode.

- Normal Mode can be used for write or read accesses to an external serial flash device.
 - Serial Flash Write: Data can be programmed into the flash via the IP interface only. Refer to [Flash Programming](#) for further details.
 - Serial Flash Read: Read the contents of the serial flash device. Two separate read channels are available via RX Buffer and AHB Buffer, see [Flash Read](#).
- Stop Mode: The mode is used for power management. When a request is made to enter Stop Mode, the QuadSPI block acknowledges the request and completes the SFM Command in progress, then the system clocks to the QuadSPI block may be shut off
- Module Disable Mode: The mode is used for power management. The clock to the non-memory mapped logic in the QuadSPI can be stopped while in Module Disable Mode. The module enters the mode by setting QSPI_MCR[MDIS] or when a request is asserted by an external controller while QSPI_MCR[DOZE] is set.

38.2.4 Acronyms and Abbreviations

The following table contains acronyms and abbreviations used in this document.

Table 38-4. Acronyms and Abbreviations

Terms	Description
AHB	Advanced High-performance Bus, version of AMBA
AMBA	Advanced Microcontroller Bus Architecture
BE	Big Endian Byte Ordering
CS	Chip Select
DMA	Direct Memory Access
MB	Megabyte. Each MB is 1024 * 1024 bytes
IFM	Individual Flash Mode
LSB	Least Significant Bit
MSB	Most Significant Bit
PCS	Peripheral Chip Select
QSPI, QuadSPI	Quad Serial Peripheral Interface
SCK	Serial Communications Clock
w1c	Write 1 to clear, writing a 1 to this field resets the flag
I/O	Input output. In this document, I/O lines are also referred as pads .

38.2.5 Glossary for QuadSPI module

Table 38-5. Glossary

Term	Definition
AHB Command	An AHB Command is a SFM Command triggered by a read access to the address range belonging to the memory mapped access defined in Table 38-10 . Refer to AHB Commands for details.
Asserted	A signal that is asserted is in its active state. An active low signal changes from logic level one to logic level zero when asserted, and an active high signal changes from logic level zero to logic level one.
Clear	To clear a bit or bits means to establish logic level zero on the bit or bits.
Clock Phase	Determines when the data should be sampled relative to the active edge of SCK
Clock Polarity	Determines the idle state of the SCK signal.
Drain	To remove entries from a FIFO by software or hardware.
Endianness	Byte Ordering scheme.
Field	Two or more register bits grouped together.
Fill	To add entries to a FIFO by software or hardware.
Host	Refers to another functional block in the device containing the QuadSPI module
Instruction Code	8 bits defining the type of command to be executed.
IP Command	An IP Command is a SFM Command triggered by writing into the QSPI_IPCR[SEQID] field.
Logic level one	The voltage that corresponds to Boolean true (1) state.
Logic level zero	The voltage that corresponds to Boolean false (0) state.
Negated	A signal that is negated is in its inactive state. An active low signal changes from logic level 0 to logic level 1 when negated, and an active high signal changes from logic level 1 to logic level 0.
QSPI_AMBA_BASE	The first address of the serial flash device as presented to the QuadSPI controller. This may be the base of the serial flash in the system address map or it may be a remapping, for instance to 0x0, done by the system. Refer to the system address map.
QSPI_ARDB_BASE	First address of QuadSPI Rx Buffer on system memory map.
Set	To set a bit or bits means to establish logic level one on the bit or bits.
RX Buffer PUSH Event	<p>Addition of valid entries into the RX Buffer. In the default case each Buffer PUSH Event adds 2 entries to the RX Buffer since the interface to the serial clock domain is 64 bits in width. Depending on the number of bytes read from the serial flash device it is possible for the very last Buffer PUSH Event that only one entry is added.</p> <p>The QSPI_RBSR[RDBFL] field is incremented by the number of entries added to the RX Buffer.</p>
RX Buffer POP Event	Removal of valid entries from the RX Buffer. Each Buffer POP Event removes (QSPI_RBCT[WMRK] + 1) valid entries from the buffer. The QSPI_RBSR[RDBFL] field is decremented by the same number and the QSPI_RBSR[RDCTR] field is incremented accordingly.
Individual Flash Mode	Access to a single, individual serial flash device. Refer to Serial Flash Access Schemes for details.
SFM Command	Serial Flash Memory Command. A SFM command consists of an instruction code and all other parameters (for example, size or mode bytes) needed for that specific instruction code. Triggering a command either initiates a transaction on the external serial flash or results in an error. Refer to Table 38-19 for details on errors.
Single/Dual/Quad/Octal Instructions	<p>Depending on the serial flash device connected to the QuadSPI module there will be instructions using a different number of data lines.</p> <ul style="list-style-type: none"> • Single pad: Single line I/O with one data out and one data in line to/from the serial flash device. • Dual pad: Dual line I/O with two bidirectional I/O lines, driven alternatively by the serial flash device or the QuadSPI module

Table continues on the next page...

Table 38-5. Glossary (continued)

Term	Definition
	<ul style="list-style-type: none"> Quad pad: Quad line I/O with 4 bidirectional I/O lines, driven alternatively by the serial flash device or the QuadSPI Octal pad: Octal line I/O with 8 bidirectional I/O lines, driven alternatively by the serial flash device or the QuadSPI
Transaction	A transaction consists of all flags, data and signals in either direction to execute a command for an attached serial flash device. It is a combination of chip select, sclk, instruction code, address, mode-and/or dummy bytes, transmit and/or receive data.
LUT	Look-up table.

38.3 External Signal Description

This section provides the external signal information of the QuadSPI module.

The following table lists the external signals belonging to the module in conjunction with the different modes of operation.

Table 38-6. Signal Properties

Signal Name	Function	Direction	Description
PCSFA1	Peripheral Chip Select Flash A1	O	This signal is the chip select for the serial flash device A1. A1 represents the first of the two flash devices that share IOFA.
PCSFA2	Peripheral Chip Select Flash A2	O	This signal is the chip select for the serial flash device A2. A2 represents the the second of the two flash devices that share IOFA.
PCSFB1	Peripheral Chip Select Flash B1	O	This signal is the chip select for the serial flash device B1. B1 represents the first of the two flash devices that share IOFB.
PCSFB2	Peripheral Chip Select Flash B2	O	This signal is the chip select for the serial flash device B2. B2 represents the second of the two flash devices that share IOFB.
SCKFA	Serial Clock Flash A	O	This signal is the serial clock output to the serial flash device A.
SCKFB	Serial Clock Flash B	O	This signal is the serial clock output to the serial flash device B.
IOFA[7:0]	Serial I/O Flash A	I/O	These signals are the data I/O lines to/from the serial flash device A. Refer to Driving External Signals for details about the signal drive and timing behavior. Note that the signal pins of the serial flash device may change their function according to the SFM Command executed, leaving them as control inputs when Single and Dual Instructions are executed. The module supports driving these inputs to dedicated values. In single I/O mode, QuadSPI drives data on IOFA[0] and expects data on IOFA[1].
IOFB[7:0]	Serial I/O Flash B	I/O	These signals are the data I/O lines to/from the serial flash device B. Refer to Driving External Signals for details about the signal drive and timing behavior. Note that the signal pins of the serial flash device may change their function according to the SFM Command executed, leaving them as control inputs when Single and Dual Instructions are executed. The module supports driving these inputs to dedicated values. In single I/O mode, QuadSPI drives data on IOFB[0] and expects data on IOFB[1].

Table continues on the next page...

Table 38-6. Signal Properties (continued)

Signal Name	Function	Direction	Description
DQSFA	Data Strobe signal Flash A	I/O	Data strobe signal for port A. Some flash vendors provide the DQS signal to which the read data is aligned in DDR mode. It is also provided as an output signal during write data phase.
DQSFB	Data Strobe signal Flash B	I/O	Data strobe signal for port B. Some flash vendors provide the DQS signal to which the read data is aligned in DDR mode. It is also provided as an output signal during write data phase.

38.3.1 Driving External Signals

The different phases of the serial flash access scheme are shown in the following figure.

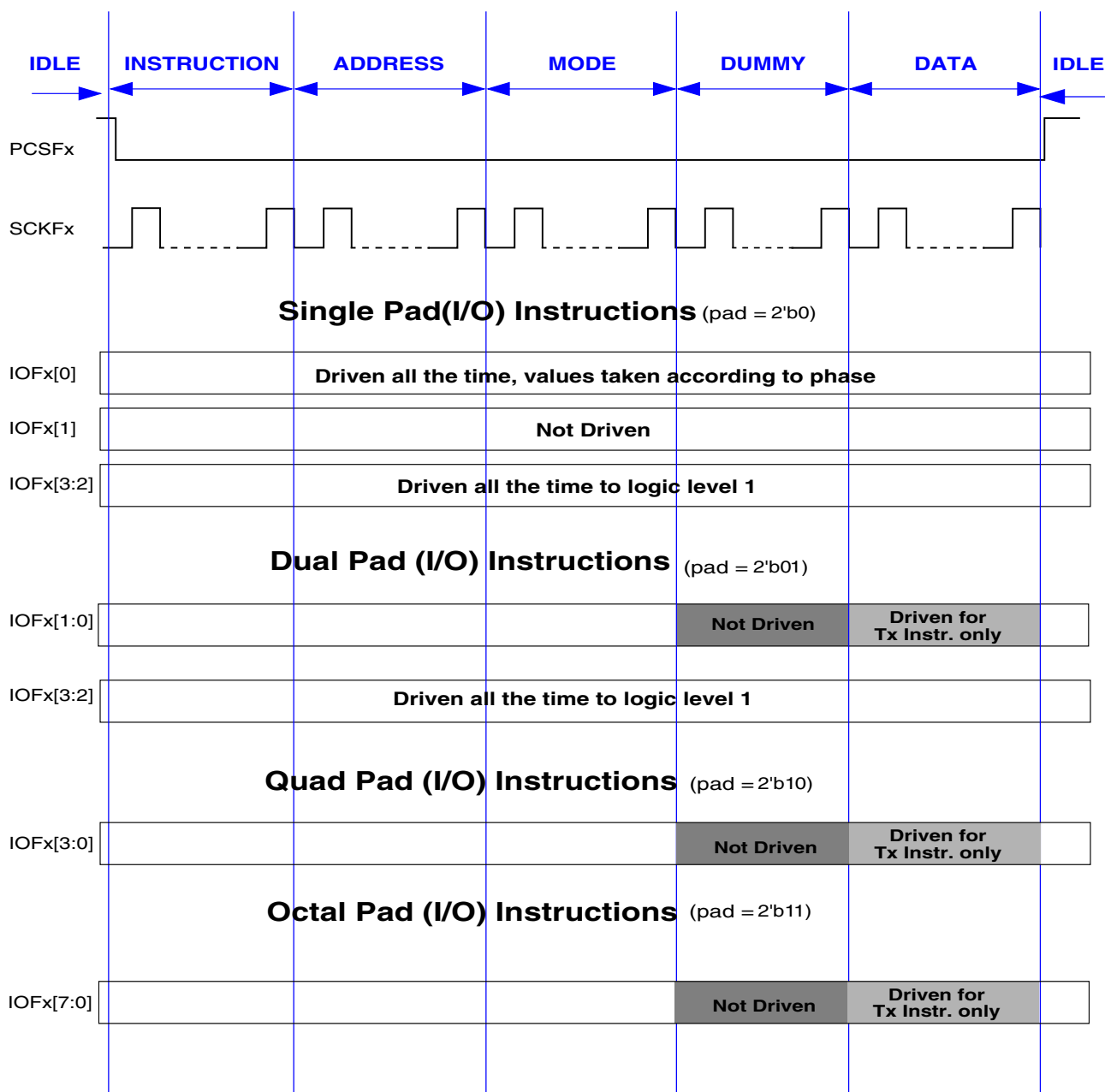

Figure 38-3. Serial Flash Access Scheme

The different phases and the I/O driving characteristics of the QuadSPI module are characterized in the following way:

- **IDLE:** Serial flash device not selected. No interaction with the serial flash device. All IOFx signals driven.
- **INSTRUCTION:** Serial flash device selected. The instruction is sent to the serial flash device. All IOFx signals are driven.

- **ADDRESS:** Serial Flash Address is sent to the device. All IOFx signals are driven. Note that this phase is not applicable for all SFM Commands.
- **MODE:** Mode bytes are sent to the serial flash device. All IOFx signals are driven. Note that this phase is not applicable for all SFM Commands.
- **DUMMY:** Dummy clocks are provided to the serial flash device. Refer to the [Figure 38-3](#) for the IOFx signals driven. The actual data lines required for the SFM Command executed are not driven for data read commands. Note that this phase is not applicable for all SFM Commands.
- **DATA:** Serial flash data are sent to or received from the serial flash device. Refer to the preceding figure for the IOFx signals driven. The actual data lines required for the SFM Command executed are not driven for data read commands. Note that this phase is not applicable for all SFM Commands.

The PCSFx and SCKFx signals are driven permanently throughout all the phases.

In Individual Flash Mode this applies to the selected flash device.

38.4 Memory Map and Register Definition

This section provides the memory map and register definitions of the QuadSPI module.

38.4.1 Register Write Access

This section describes the write access restriction terms that apply to all registers, which can be one of the following:

- **Register Write Access Restriction**

For each register bit and register field, the write access conditions are specified in the detailed register description. A description of the write access conditions is given in the following table. If, for a specific register bit or field, none of the given write access conditions is fulfilled, any write attempt to this register bit or field is ignored without any notification. The values of the bits or fields are not changed.

The condition term [A or B] indicates that the register or field can be written to if at least one of the conditions is fulfilled.

Table 38-7. Register Write Access Restrictions

Condition	Description
Anytime	No write access restriction.
Disabled Mode	Write access only if <i>QSPI_MCR[MDIS] = 1</i> .
Normal Mode	Write access only if the module is in <i>Normal Mode</i> .

- **Register Write Access Requirements**

All registers can be accessed with 8-bit, 16-bit, and 32-bit wide operations. For some of the registers, at least a 16/32-bit wide write access is required to ensure correct operation. This write access requirement is stated in the detailed register description for each register affected.

38.4.2 Peripheral Bus Register Descriptions

This section provides the memory map and register definitions of the QuadSPI module.

NOTE

Access to location and 0x190 does not give transfer error.

QuadSPI memory map

Address offset (hex)	Register name	Width (in bits)	Access	Reset value	Section/page
0	Module Configuration Register (QuadSPI_MCR)	32	R/W	See section	38.4.2.1/ 1050
8	IP Configuration Register (QuadSPI_IPCR)	32	R/W	0000_0000h	38.4.2.2/ 1054
C	Flash Configuration Register (QuadSPI_FLSHCR)	32	R/W	0000_0303h	38.4.2.3/ 1055
10	Buffer0 Configuration Register (QuadSPI_BUF0CR)	32	R/W	See section	38.4.2.4/ 1056
14	Buffer1 Configuration Register (QuadSPI_BUF1CR)	32	R/W	See section	38.4.2.5/ 1057
18	Buffer2 Configuration Register (QuadSPI_BUF2CR)	32	R/W	See section	38.4.2.6/ 1057
1C	Buffer3 Configuration Register (QuadSPI_BUF3CR)	32	R/W	See section	38.4.2.7/ 1058
20	Buffer Generic Configuration Register (QuadSPI_BFGENCR)	32	R/W	0000_0000h	38.4.2.8/ 1059

Table continues on the next page...

QuadSPI memory map (continued)

Address offset (hex)	Register name	Width (in bits)	Access	Reset value	Section/page
24	SOC Configuration Register (QuadSPI_SOCCR)	32	R/W	0000_0000h	38.4.2.9/1060
30	Buffer0 Top Index Register (QuadSPI_BUF0IND)	32	R/W	0000_0000h	38.4.2.10/1061
34	Buffer1 Top Index Register (QuadSPI_BUF1IND)	32	R/W	0000_0000h	38.4.2.11/1061
38	Buffer2 Top Index Register (QuadSPI_BUF2IND)	32	R/W	0000_0000h	38.4.2.12/1062
100	Serial Flash Address Register (QuadSPI_SFAR)	32	R/W	0000_0000h	38.4.2.13/1063
104	Serial Flash Address Configuration Register (QuadSPI_SFACR)	32	R/W	0000_0000h	38.4.2.14/1063
108	Sampling Register (QuadSPI_SMPR)	32	R/W	0000_0000h	38.4.2.15/1064
10C	RX Buffer Status Register (QuadSPI_RBBSR)	32	R	0000_0000h	38.4.2.16/1066
110	RX Buffer Control Register (QuadSPI_RBCT)	32	R/W	0000_0000h	38.4.2.17/1066
150	TX Buffer Status Register (QuadSPI_TBBSR)	32	R	0000_0000h	38.4.2.18/1068
154	TX Buffer Data Register (QuadSPI_TBDR)	32	R/W	0000_0000h	38.4.2.19/1068
158	Tx Buffer Control Register (QuadSPI_TBCT)	32	R/W	0000_0000h	38.4.2.20/1069
15C	Status Register (QuadSPI_SR)	32	R	0200_3800h	38.4.2.21/1070
160	Flag Register (QuadSPI_FR)	32	w1c	0800_0000h	38.4.2.22/1073
164	Interrupt and DMA Request Select and Enable Register (QuadSPI_RSER)	32	R/W	0000_0000h	38.4.2.23/1076
168	Sequence Suspend Status Register (QuadSPI_SPNDST)	32	R	0000_0000h	38.4.2.24/1080
16C	Sequence Pointer Clear Register (QuadSPI_SPTRCLR)	32	R/W	0000_0000h	38.4.2.25/1082
180	Serial Flash A1 Top Address (QuadSPI_SFA1AD)	32	R/W	See section	38.4.2.26/1083
184	Serial Flash A2 Top Address (QuadSPI_SFA2AD)	32	R/W	See section	38.4.2.27/1083
188	Serial Flash B1 Top Address (QuadSPI_SFB1AD)	32	R/W	See section	38.4.2.28/1084
18C	Serial Flash B2 Top Address (QuadSPI_SFB2AD)	32	R/W	See section	38.4.2.29/1084
200	RX Buffer Data Register (QuadSPI_RBDR0)	32	R	0000_0000h	38.4.2.30/1085

Table continues on the next page...

QuadSPI memory map (continued)

Address offset (hex)	Register name	Width (in bits)	Access	Reset value	Section/ page
204	RX Buffer Data Register (QuadSPI_RBDR1)	32	R	0000_0000h	38.4.2.30/1085
208	RX Buffer Data Register (QuadSPI_RBDR2)	32	R	0000_0000h	38.4.2.30/1085
20C	RX Buffer Data Register (QuadSPI_RBDR3)	32	R	0000_0000h	38.4.2.30/1085
210	RX Buffer Data Register (QuadSPI_RBDR4)	32	R	0000_0000h	38.4.2.30/1085
214	RX Buffer Data Register (QuadSPI_RBDR5)	32	R	0000_0000h	38.4.2.30/1085
218	RX Buffer Data Register (QuadSPI_RBDR6)	32	R	0000_0000h	38.4.2.30/1085
21C	RX Buffer Data Register (QuadSPI_RBDR7)	32	R	0000_0000h	38.4.2.30/1085
220	RX Buffer Data Register (QuadSPI_RBDR8)	32	R	0000_0000h	38.4.2.30/1085
224	RX Buffer Data Register (QuadSPI_RBDR9)	32	R	0000_0000h	38.4.2.30/1085
228	RX Buffer Data Register (QuadSPI_RBDR10)	32	R	0000_0000h	38.4.2.30/1085
22C	RX Buffer Data Register (QuadSPI_RBDR11)	32	R	0000_0000h	38.4.2.30/1085
230	RX Buffer Data Register (QuadSPI_RBDR12)	32	R	0000_0000h	38.4.2.30/1085
234	RX Buffer Data Register (QuadSPI_RBDR13)	32	R	0000_0000h	38.4.2.30/1085
238	RX Buffer Data Register (QuadSPI_RBDR14)	32	R	0000_0000h	38.4.2.30/1085
23C	RX Buffer Data Register (QuadSPI_RBDR15)	32	R	0000_0000h	38.4.2.30/1085
240	RX Buffer Data Register (QuadSPI_RBDR16)	32	R	0000_0000h	38.4.2.30/1085
244	RX Buffer Data Register (QuadSPI_RBDR17)	32	R	0000_0000h	38.4.2.30/1085
248	RX Buffer Data Register (QuadSPI_RBDR18)	32	R	0000_0000h	38.4.2.30/1085
24C	RX Buffer Data Register (QuadSPI_RBDR19)	32	R	0000_0000h	38.4.2.30/1085
250	RX Buffer Data Register (QuadSPI_RBDR20)	32	R	0000_0000h	38.4.2.30/1085
254	RX Buffer Data Register (QuadSPI_RBDR21)	32	R	0000_0000h	38.4.2.30/1085
258	RX Buffer Data Register (QuadSPI_RBDR22)	32	R	0000_0000h	38.4.2.30/1085

Table continues on the next page...

QuadSPI memory map (continued)

Address offset (hex)	Register name	Width (in bits)	Access	Reset value	Section/page
25C	RX Buffer Data Register (QuadSPI_RBDR23)	32	R	0000_0000h	38.4.2.30/1085
260	RX Buffer Data Register (QuadSPI_RBDR24)	32	R	0000_0000h	38.4.2.30/1085
264	RX Buffer Data Register (QuadSPI_RBDR25)	32	R	0000_0000h	38.4.2.30/1085
268	RX Buffer Data Register (QuadSPI_RBDR26)	32	R	0000_0000h	38.4.2.30/1085
26C	RX Buffer Data Register (QuadSPI_RBDR27)	32	R	0000_0000h	38.4.2.30/1085
270	RX Buffer Data Register (QuadSPI_RBDR28)	32	R	0000_0000h	38.4.2.30/1085
274	RX Buffer Data Register (QuadSPI_RBDR29)	32	R	0000_0000h	38.4.2.30/1085
278	RX Buffer Data Register (QuadSPI_RBDR30)	32	R	0000_0000h	38.4.2.30/1085
27C	RX Buffer Data Register (QuadSPI_RBDR31)	32	R	0000_0000h	38.4.2.30/1085
300	LUT Key Register (QuadSPI_LUTKEY)	32	R/W	5AF0_5AF0h	38.4.2.31/1086
304	LUT Lock Configuration Register (QuadSPI_LCKCR)	32	R/W	0000_0002h	38.4.2.32/1086
310	Look-up Table register (QuadSPI_LUT0)	32	R/W	See section	38.4.2.33/1087
314	Look-up Table register (QuadSPI_LUT1)	32	R/W	See section	38.4.2.33/1087
318	Look-up Table register (QuadSPI_LUT2)	32	R/W	See section	38.4.2.33/1087
31C	Look-up Table register (QuadSPI_LUT3)	32	R/W	See section	38.4.2.33/1087
320	Look-up Table register (QuadSPI_LUT4)	32	R/W	See section	38.4.2.33/1087
324	Look-up Table register (QuadSPI_LUT5)	32	R/W	See section	38.4.2.33/1087
328	Look-up Table register (QuadSPI_LUT6)	32	R/W	See section	38.4.2.33/1087
32C	Look-up Table register (QuadSPI_LUT7)	32	R/W	See section	38.4.2.33/1087
330	Look-up Table register (QuadSPI_LUT8)	32	R/W	See section	38.4.2.33/1087
334	Look-up Table register (QuadSPI_LUT9)	32	R/W	See section	38.4.2.33/1087
338	Look-up Table register (QuadSPI_LUT10)	32	R/W	See section	38.4.2.33/1087

Table continues on the next page...

QuadSPI memory map (continued)

Address offset (hex)	Register name	Width (in bits)	Access	Reset value	Section/page
33C	Look-up Table register (QuadSPI_LUT11)	32	R/W	See section	38.4.2.33/ 1087
340	Look-up Table register (QuadSPI_LUT12)	32	R/W	See section	38.4.2.33/ 1087
344	Look-up Table register (QuadSPI_LUT13)	32	R/W	See section	38.4.2.33/ 1087
348	Look-up Table register (QuadSPI_LUT14)	32	R/W	See section	38.4.2.33/ 1087
34C	Look-up Table register (QuadSPI_LUT15)	32	R/W	See section	38.4.2.33/ 1087
350	Look-up Table register (QuadSPI_LUT16)	32	R/W	See section	38.4.2.33/ 1087
354	Look-up Table register (QuadSPI_LUT17)	32	R/W	See section	38.4.2.33/ 1087
358	Look-up Table register (QuadSPI_LUT18)	32	R/W	See section	38.4.2.33/ 1087
35C	Look-up Table register (QuadSPI_LUT19)	32	R/W	See section	38.4.2.33/ 1087
360	Look-up Table register (QuadSPI_LUT20)	32	R/W	See section	38.4.2.33/ 1087
364	Look-up Table register (QuadSPI_LUT21)	32	R/W	See section	38.4.2.33/ 1087
368	Look-up Table register (QuadSPI_LUT22)	32	R/W	See section	38.4.2.33/ 1087
36C	Look-up Table register (QuadSPI_LUT23)	32	R/W	See section	38.4.2.33/ 1087
370	Look-up Table register (QuadSPI_LUT24)	32	R/W	See section	38.4.2.33/ 1087
374	Look-up Table register (QuadSPI_LUT25)	32	R/W	See section	38.4.2.33/ 1087
378	Look-up Table register (QuadSPI_LUT26)	32	R/W	See section	38.4.2.33/ 1087
37C	Look-up Table register (QuadSPI_LUT27)	32	R/W	See section	38.4.2.33/ 1087
380	Look-up Table register (QuadSPI_LUT28)	32	R/W	See section	38.4.2.33/ 1087
384	Look-up Table register (QuadSPI_LUT29)	32	R/W	See section	38.4.2.33/ 1087
388	Look-up Table register (QuadSPI_LUT30)	32	R/W	See section	38.4.2.33/ 1087
38C	Look-up Table register (QuadSPI_LUT31)	32	R/W	See section	38.4.2.33/ 1087
390	Look-up Table register (QuadSPI_LUT32)	32	R/W	See section	38.4.2.33/ 1087

Table continues on the next page...

QuadSPI memory map (continued)

Address offset (hex)	Register name	Width (in bits)	Access	Reset value	Section/page
394	Look-up Table register (QuadSPI_LUT33)	32	R/W	See section	38.4.2.33/ 1087
398	Look-up Table register (QuadSPI_LUT34)	32	R/W	See section	38.4.2.33/ 1087
39C	Look-up Table register (QuadSPI_LUT35)	32	R/W	See section	38.4.2.33/ 1087
3A0	Look-up Table register (QuadSPI_LUT36)	32	R/W	See section	38.4.2.33/ 1087
3A4	Look-up Table register (QuadSPI_LUT37)	32	R/W	See section	38.4.2.33/ 1087
3A8	Look-up Table register (QuadSPI_LUT38)	32	R/W	See section	38.4.2.33/ 1087
3AC	Look-up Table register (QuadSPI_LUT39)	32	R/W	See section	38.4.2.33/ 1087
3B0	Look-up Table register (QuadSPI_LUT40)	32	R/W	See section	38.4.2.33/ 1087
3B4	Look-up Table register (QuadSPI_LUT41)	32	R/W	See section	38.4.2.33/ 1087
3B8	Look-up Table register (QuadSPI_LUT42)	32	R/W	See section	38.4.2.33/ 1087
3BC	Look-up Table register (QuadSPI_LUT43)	32	R/W	See section	38.4.2.33/ 1087
3C0	Look-up Table register (QuadSPI_LUT44)	32	R/W	See section	38.4.2.33/ 1087
3C4	Look-up Table register (QuadSPI_LUT45)	32	R/W	See section	38.4.2.33/ 1087
3C8	Look-up Table register (QuadSPI_LUT46)	32	R/W	See section	38.4.2.33/ 1087
3CC	Look-up Table register (QuadSPI_LUT47)	32	R/W	See section	38.4.2.33/ 1087
3D0	Look-up Table register (QuadSPI_LUT48)	32	R/W	See section	38.4.2.33/ 1087
3D4	Look-up Table register (QuadSPI_LUT49)	32	R/W	See section	38.4.2.33/ 1087
3D8	Look-up Table register (QuadSPI_LUT50)	32	R/W	See section	38.4.2.33/ 1087
3DC	Look-up Table register (QuadSPI_LUT51)	32	R/W	See section	38.4.2.33/ 1087
3E0	Look-up Table register (QuadSPI_LUT52)	32	R/W	See section	38.4.2.33/ 1087
3E4	Look-up Table register (QuadSPI_LUT53)	32	R/W	See section	38.4.2.33/ 1087
3E8	Look-up Table register (QuadSPI_LUT54)	32	R/W	See section	38.4.2.33/ 1087

Table continues on the next page...

QuadSPI memory map (continued)

Address offset (hex)	Register name	Width (in bits)	Access	Reset value	Section/ page
3EC	Look-up Table register (QuadSPI_LUT55)	32	R/W	See section	38.4.2.33/ 1087
3F0	Look-up Table register (QuadSPI_LUT56)	32	R/W	See section	38.4.2.33/ 1087
3F4	Look-up Table register (QuadSPI_LUT57)	32	R/W	See section	38.4.2.33/ 1087
3F8	Look-up Table register (QuadSPI_LUT58)	32	R/W	See section	38.4.2.33/ 1087
3FC	Look-up Table register (QuadSPI_LUT59)	32	R/W	See section	38.4.2.33/ 1087
400	Look-up Table register (QuadSPI_LUT60)	32	R/W	See section	38.4.2.33/ 1087
404	Look-up Table register (QuadSPI_LUT61)	32	R/W	See section	38.4.2.33/ 1087
408	Look-up Table register (QuadSPI_LUT62)	32	R/W	See section	38.4.2.33/ 1087
40C	Look-up Table register (QuadSPI_LUT63)	32	R/W	See section	38.4.2.33/ 1087

38.4.2.1 Module Configuration Register (QuadSPI_MCR)

The QuadSPI_MCR holds configuration data associated with QuadSPI operation.

Write:

- *SCLKCFG: Disabled Mode*
- *ISD3FB, ISD2FB, ISD3FA, ISD2FA: Disabled Mode*
- *All other fields: Anytime*

Address: 0h base + 0h offset = 0h

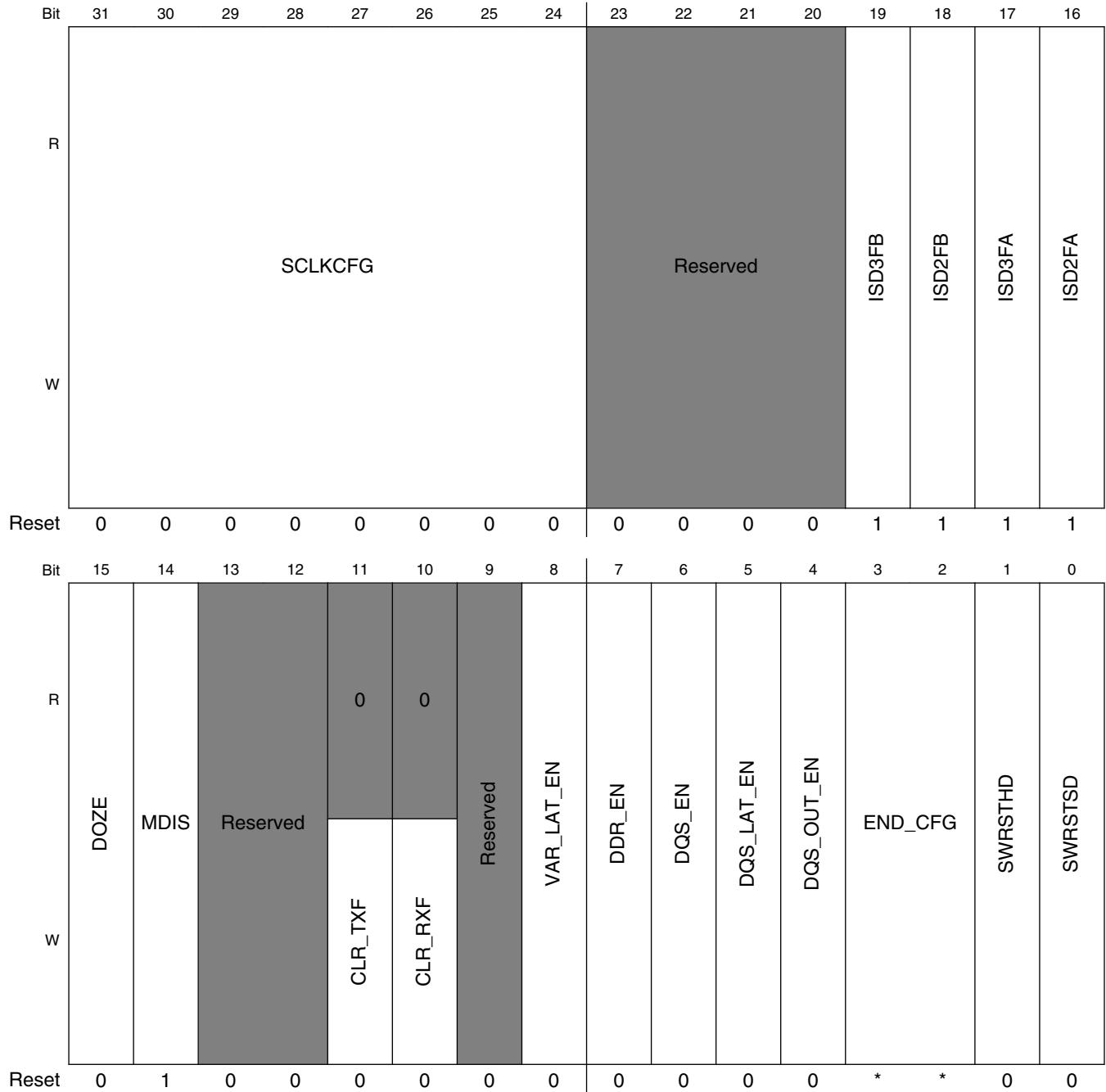

* Notes:

- END_CFG field: See the module configuration for the device specific reset value.

QuadSPI_MCR field descriptions

Field	Description
31–24 SCLKCFG	Serial Clock Configuration. This field configuration is chip specific. For details, refer to chip-specific QuadSPI information. It may be used for dividing clocks.

Table continues on the next page...

QuadSPI_MCR field descriptions (continued)

Field	Description
23–20 Reserved	This field is reserved.
19 ISD3FB	Idle Signal Drive IOFB[3] Flash B. This bit determines the logic level the IOFB[3] output of the QuadSPI module is driven to in the inactive state. Refer to Driving Flash Control Signals in Single and Dual Mode . 0 IOFB[3] is driven to logic L 1 IOFB[3] is driven to logic H
18 ISD2FB	Idle Signal Drive IOFB[2] Flash B. This bit determines the logic level the IOFB[2] output of the QuadSPI module is driven to in the inactive state. Refer to Driving Flash Control Signals in Single and Dual Mode . 0 IOFB[2] is driven to logic L 1 IOFB[2] is driven to logic H
17 ISD3FA	Idle Signal Drive IOFA[3] Flash A. This bit determines the logic level the IOFA[3] output of the QuadSPI module is driven to in the inactive state. Refer to Driving Flash Control Signals in Single and Dual Mode . 0 IOFA[3] is driven to logic L 1 IOFA[3] is driven to logic H
16 ISD2FA	Idle Signal Drive IOFA[2] Flash A. This bit determines the logic level the IOFA[2] output of the QuadSPI module is driven to in the inactive state. Refer to Driving Flash Control Signals in Single and Dual Mode . 0 IOFA[2] is driven to logic L 1 IOFA[2] is driven to logic H
15 DOZE	Doze Enable. The DOZE bit provides support for externally controlled Doze Mode power-saving mechanism. 0 A doze request will be ignored by the QuadSPI module 1 A doze request will be processed by the QuadSPI module
14 MDIS	Module Disable. The MDIS bit allows the clock to the non-memory mapped logic in the QuadSPI to be stopped, putting the QuadSPI in a software controlled power-saving state. 0 Enable QuadSPI clocks. 1 Allow external logic to disable QuadSPI clocks.
13–12 Reserved	This field is reserved.
11 CLR_TXF	Clear TX FIFO/Buffer. Invalidates the TX Buffer content. This is a self-clearing field. 0 No action. 1 Read and write pointers of the TX Buffer are reset to 0. QSPI_TBSR[TRCTR] is reset to 0.
10 CLR_RXF	Clear RX FIFO. Invalidates the RX Buffer. This is a self-clearing field. 0 No action. 1 Read and write pointers of the RX Buffer are reset to 0. QSPI_RBSR[RDBFL] is reset to 0.
9 Reserved	This field is reserved.
8 VAR_LAT_EN	This field is used to enable variable latency feature in the controller. This field is valid for HyperRAM where Data strobe acts as an output from the memory during the command and address (CA) cycles of a read or

Table continues on the next page...

QuadSPI_MCR field descriptions (continued)

Field	Description
	<p>write transaction, to indicate whether additional initial access latency is needed to perform a dynamic memory refresh operation. For more details, refer HyperRAM Support.</p> <p>0 Fixed latency: Twice + 1 latency enable 1 Variable latency: 'once' or 'twice + 1' the initial latency based on Data strobe during CA phase. If enabled also need to ensure QSPI_FLSHCR[TCSS] must be >= 2.</p>
7 DDR_EN	<p>DDR mode enable</p> <p>0 2x clock are disabled for SDR instructions only 1 2x clock are enabled supports both SDR and DDR instruction.</p>
6 DQS_EN	<p>DQS enable. This field is valid for both SDR and DDR mode. For more details, refer to Data Strobe (DQS) sampling method.</p> <p>0 DQS disabled. 1 DQS enabled. When enabled, the incoming data is sampled on both the edges of DQS input when QSPI_MCR[DDR_EN] is set, else, on only one edge when QSPI_MCR[DDR_EN] is 0. The QSPI_SMPR[DDR_SMP] values are ignored.</p>
5 DQS_LAT_EN	<p>DQS Latency Enable. This field is valid when latency is included in between read access from flash memory in cases when QSPI_MCR[DQS_EN] is 1. For more details, refer to Data Strobe (DQS) sampling method.</p> <p>0 DQS Latency disabled 1 DQS feature with latency included enabled</p>
4 DQS_OUT_EN	<p>This field is valid when Data Strobe is also used as an output from controller during Write data phase. This is valid for HyperRAM where Data strobe acts as a Read Write Data Strobe (RWDS). For more details, refer HyperRAM Support.</p> <p>0 DQS as an output from controller is disabled 1 DQS as an output from controller is enabled</p>
3–2 END_CFG	<p>Defines the endianness of the QuadSPI module. For more details refer to Byte Ordering Endianness</p>
1 SWRSTHD	<p>Software reset for AHB domain</p> <p>0 No action 1 AHB domain flops are reset. Does not reset configuration registers.</p> <p>It is advisable to reset both the serial flash domain and AHB domain at the same time. Resetting only one domain might lead to side effects.</p> <p>NOTE: The software resets need the clock to be running to propagate to the design. The MCR[MDIS] should therefore be set to 0 when the software reset bits are asserted. Also, before they can be deasserted again (by setting MCR[SWRSTHD] to 0), it is recommended to set the MCR[MDIS] bit to 1. Once the software resets have been deasserted, the normal operation can be started by setting the MCR[MDIS] bit to 0.</p>
0 SWRSTSD	<p>Software reset for serial flash domain</p> <p>0 No action 1 Serial Flash domain flops are reset. Does not reset configuration registers.</p> <p>It is advisable to reset both the serial flash domain and AHB domain at the same time. Resetting only one domain might lead to side effects.</p>

Table continues on the next page...

QuadSPI_MCR field descriptions (continued)

Field	Description
	NOTE: The software resets need the clock to be running to propagate to the design. The MCR[MDIS] should therefore be set to 0 when the software reset bits are asserted. Also, before they can be deasserted again (by setting MCR[SWRSTSD] to 0), it is recommended to set the MCR[MDIS] bit to 1. Once the software resets have been deasserted, the normal operation can be started by setting the MCR[MDIS] bit to 0.

38.4.2.2 IP Configuration Register (QuadSPI_IPCR)

The IP configuration register provides all the configuration required for an IP initiated command. An IP command can be triggered by writing in the SEQID field of this register. If the SEQID field is written successfully, a new command to the external serial flash is started as per the sequence pointed to by the SEQID field. Refer to [Normal Mode](#) , for details about the command triggering and command execution.

Write:

- *QSPI_SR[IP_ACC]=0*

Address: 0h base + 8h offset = 8h

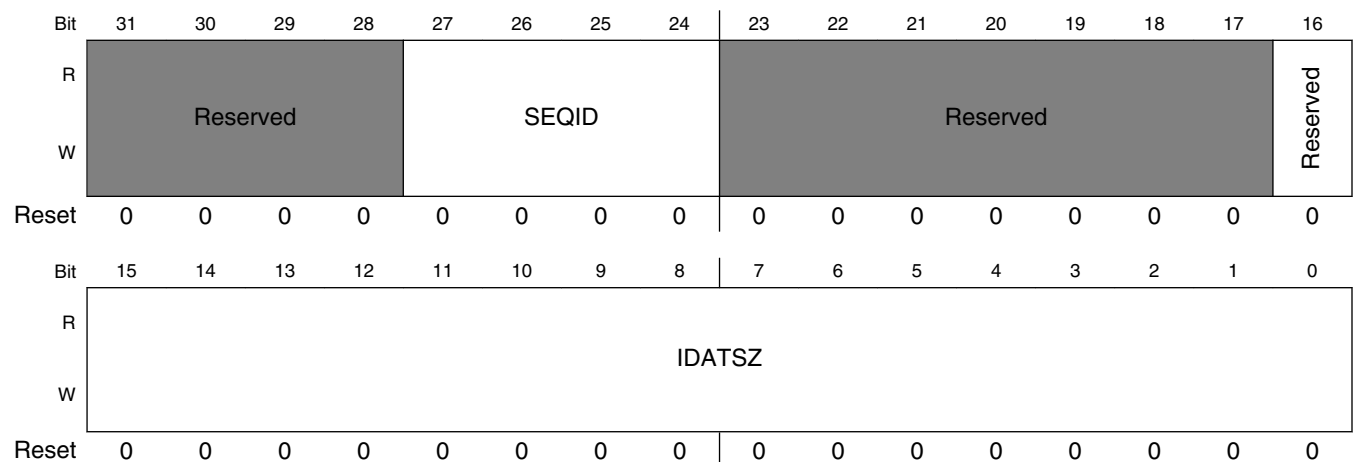

QuadSPI_IPCR field descriptions

Field	Description
31–28 Reserved	This field is reserved.
27–24 SEQID	Points to a sequence in the Look-up table. This field defines bits [6:2] of the LUT index. The bits [1:0] are always assumed to be 0. Refer to Look-up Table for more details. A write to this field triggers a transaction on the serial flash interface.
23–17 Reserved	This field is reserved.
16 Reserved	This field is reserved.
IDATSZ	IP data transfer size. Defines the data transfer size in bytes of the IP command.

38.4.2.3 Flash Configuration Register (QuadSPI_FLSHCR)

The Flash configuration register contains the flash device specific timings that must be met by the QuadSPI controller for the device to function correctly.

Write:

- $QSPI_SR[AHB_ACC] = 0$
- $QSPI_SR[IP_ACC] = 0$

Address: 0h base + Ch offset = Ch

Bit	31	30	29	28	27	26	25	24	23	22	21	20	19	18	17	16	15	14	13	12	11	10	9	8	7	6	5	4	3	2	1	0
R	Reserved																TDH	Reserved				TCSH		Reserved				TCSS				
W	Reserved																TDH	Reserved				TCSH		Reserved				TCSS				
Reset	0	0	0	0	0	0	0	0	0	0	0	0	0	0	0	0	0	0	0	0	0	0	1	1	0	0	0	0	0	0	1	1

QuadSPI_FLSHCR field descriptions

Field	Description
31–18 Reserved	This field is reserved.
17–16 TDH	Serial flash data in hold time. This helps in meeting the Data In Hold time requirement of a flash. This is valid only in DDR mode. NOTE: This field should be set to 0x00 in SDR mode (QuadSPI_MCR[DDR_EN]=0). Refer to Data input hold requirement of Flash for details. The valid TDH programming options are shown below. Other combinations are invalid. 00 Data aligned with the posedge of Internal reference clock of QuadSPI 01 Data aligned with 2x serial flash half clock
15–12 Reserved	This field is reserved.
11–8 TCSH	Serial flash CS hold time in terms of serial flash clock cycles. Default value '3' should be used in case AHB prefetch size is less than or equal to 32-bytes DDR/16-bytes SDR. NOTE: The actual delay between chip select and clock is defined as: • $TCSH = 1 \text{ SCK clk}$ if $N = 0/1$ else, $N \text{ SCK clk}$ if $N > 1$, where N is the setting of TCSH.
7–4 Reserved	This field is reserved. Reserved.
TCSS	Serial flash CS setup time in terms of serial flash clock cycles. NOTE: 1. The actual delay between chip select and clock is defined as: • $TCSS = 0.5 \text{ SCK clk}$ if $N = 0/1$ else, $N + 0.5 \text{ SCK clk}$ if $N > 1$, where N is the setting of TCSS. 2. Any update to the TCSS register bits is visible on the flash interface only from the second transaction following the update.

38.4.2.4 Buffer0 Configuration Register (QuadSPI_BUF0CR)

This register provides the configuration for any access to buffer0. An access is routed to buffer0 when the master port number of the incoming AHB request matches the MSTRID field of BUF0CR. Any buffer "miss" leads to a serial flash transaction being triggered as per the sequence pointed to the SEQID field. Buffer0 may also be configured as a high priority buffer by setting the HP_EN field of this register.

Write:

- $QSPI_SR[AHB_ACC] = 0$

Address: 0h base + 10h offset = 10h

Bit	31	30	29	28	27	26	25	24	23	22	21	20	19	18	17	16
R																
W	HP_EN	Reserved														
Reset	0	0	0	0	0	0	0	0	0	0	0	0	0	0	0	0
Bit	15	14	13	12	11	10	9	8	7	6	5	4	3	2	1	0
R																
W	ADATSZ								Reserved				MSTRID			
Reset	0	0	0	0	0	0	0	0	0	0	0	0	*	*	*	*

* Notes:

- MSTRID field: See the module configuration for reset value.

QuadSPI_BUF0CR field descriptions

Field	Description
31 HP_EN	High Priority Enable. When set, the master associated with this buffer is assigned a priority higher than the rest of the masters. An access by a high priority master will suspend any ongoing prefetch by another AHB master and will be serviced on high priority. Refer to Flexible AHB Buffers for details.
30–16 Reserved	This field is reserved.
15–8 ADATSZ	AHB data transfer size Defines the data transfer size in 8 bytes of an AHB triggered access to serial flash. For example, a value of 0x2 will set transfer size to 16 bytes. When ADATSZ = 0, the data size mentioned the sequence pointed to by the SEQID field overrides this value. Software should ensure that this transfer size is not greater than the size of this buffer.
7–4 Reserved	This field is reserved.
MSTRID	Master ID. The ID of the AHB master associated with BUFFER0. Any AHB access with this master port number is routed to this buffer. It must be ensured that the master IDs associated with all buffers must be different.

38.4.2.5 Buffer1 Configuration Register (QuadSPI_BUF1CR)

This register provides the configuration for any access to buffer1. An access is routed to buffer1 when the master port number of the incoming AHB request matches the MSTRID field of BUF1CR. Any buffer "miss" leads to the buffer being flushed and a serial flash transaction being triggered as per the sequence pointed to by the SEQID field.

Write:

- $QSPI_SR[AHB_ACC] = 0$

Address: 0h base + 14h offset = 14h

Bit	31	30	29	28	27	26	25	24	23	22	21	20	19	18	17	16	15	14	13	12	11	10	9	8	7	6	5	4	3	2	1	0	
R	Reserved																ADATSZ				Reserved				MSTRID								
W	Reserved																ADATSZ				Reserved				MSTRID								
Reset	0	0	0	0	0	0	0	0	0	0	0	0	0	0	0	0	0	0	0	0	0	0	0	0	0	0	0	0	0	*	*	*	*

* Notes:

- MSTRID field: See the module configuration for reset value.

QuadSPI_BUF1CR field descriptions

Field	Description
31–16 Reserved	This field is reserved.
15–8 ADATSZ	AHB data transfer size Defines the data transfer size in 8 bytes of an AHB triggered access to serial flash. For example, a value of 0x2 will set transfer size to 16 bytes. When ADATSZ = 0, the data size mentioned the sequence pointed to by the SEQID field overrides this value. Software should ensure that this transfer size is not greater than the size of this buffer.
7–4 Reserved	This field is reserved.
MSTRID	Master ID. The ID of the AHB master associated with BUFFER1. Any AHB access with this master port number is routed to this buffer. It must be ensured that the master IDs associated with all buffers must be different.

38.4.2.6 Buffer2 Configuration Register (QuadSPI_BUF2CR)

This register provides the configuration for any access to buffer2. An access is routed to buffer2 when the master port number of the incoming AHB request matches the MSTRID field of BUF2CR. Any buffer "miss" leads to the buffer being flushed and a serial flash transaction being triggered as per the sequence pointed to by the SEQID field.

Write:

- $QSPI_SR[AHB_ACC] = 0$

Memory Map and Register Definition

Address: 0h base + 18h offset = 18h

Bit	31	30	29	28	27	26	25	24	23	22	21	20	19	18	17	16	15	14	13	12	11	10	9	8	7	6	5	4	3	2	1	0
R	Reserved																ADATSZ								Reserved				MSTRID			
W	Reserved																ADATSZ								Reserved				MSTRID			
Reset	0	0	0	0	0	0	0	0	0	0	0	0	0	0	0	0	0	0	0	0	0	0	0	0	0	0	0	0	*	*	*	*

* Notes:

- MSTRID field: See the module configuration for the device specific reset value.

QuadSPI_BUF2CR field descriptions

Field	Description
31–16 Reserved	This field is reserved. Reserved.
15–8 ADATSZ	AHB data transfer size Defines the data transfer size in 8 bytes of an AHB triggered access to serial flash. For example, a value of 0x2 will set transfer size to 16 bytes. When ADATSZ = 0, the data size mentioned the sequence pointed to by the SEQID field overrides this value. Software should ensure that this transfer size is not greater than the size of this buffer.
7–4 Reserved	This field is reserved. Reserved.
MSTRID	Master ID. The ID of the AHB master associated with BUFFER2. Any AHB access with this master port number is routed to this buffer. It must be ensured that the master IDs associated with all buffers must be different.

38.4.2.7 Buffer3 Configuration Register (QuadSPI_BUF3CR)

This register provides the configuration for any access to buffer3. An access is routed to buffer3 when the master port number of the incoming AHB request matches the MSTRID field of BUF3CR. Any buffer "miss" leads to the buffer being flushed a serial flash transaction being triggered as per the sequence pointed to by the SEQID field.

In the case that the ALLMST field is not set, any such transaction (where master port number does not match any of the MSTRID fields) will be returned an ERROR response.

Write:

- $QSPL_SR[AHB_ACC] = 0$

Address: 0h base + 1Ch offset = 1Ch

Bit	31	30	29	28	27	26	25	24	23	22	21	20	19	18	17	16
R	Reserved															
W	ALLMST	Reserved														
Reset	1	0	0	0	0	0	0	0	0	0	0	0	0	0	0	0

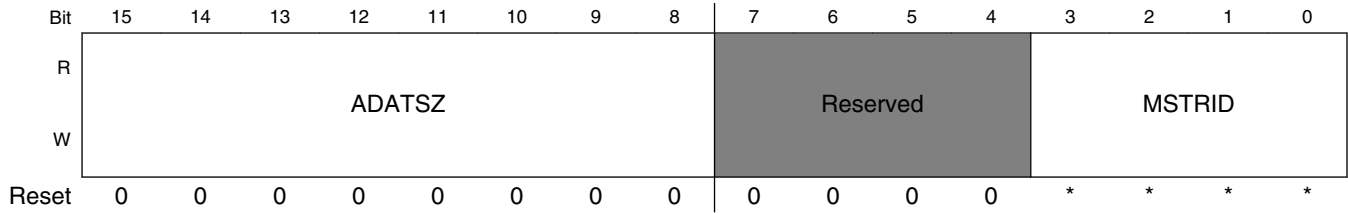

* Notes:

- MSTRID field: See the module configuration for the device specific reset value.

QuadSPI_BUF3CR field descriptions

Field	Description
31 ALLMST	All master enable. When set, buffer3 acts as an all-master buffer. Any AHB access with a master port number not matching with the master ID of buffer0 or buffer1 or buffer2 is routed to buffer3. When set, the MSTRID field of this register is ignored.
30–16 Reserved	This field is reserved. Reserved.
15–8 ADATSZ	AHB data transfer size Defines the data transfer size in 8 Bytes of an AHB triggered access to serial flash. When ADATSZ = 0, the data size mentioned the sequence pointed to by the SEQID field overrides this value. Software should ensure that this transfer size is not greater than the size of this buffer.
7–4 Reserved	This field is reserved.
MSTRID	Master ID. The ID of the AHB master associated with BUFFER3. Any AHB access with this master port number is routed to this buffer. It must be ensured that the master IDs associated with all buffers must be different.

38.4.2.8 Buffer Generic Configuration Register (QuadSPI_BFGENCR)

This register provides the generic configuration to any of the buffer accesses. Any buffer "miss" leads to the buffer being flushed and a serial flash transaction being triggered as per the sequence pointed to by the SEQID field.

Write:

- $QSPI_SR[AHB_ACC] = 0$

Address: 0h base + 20h offset = 20h

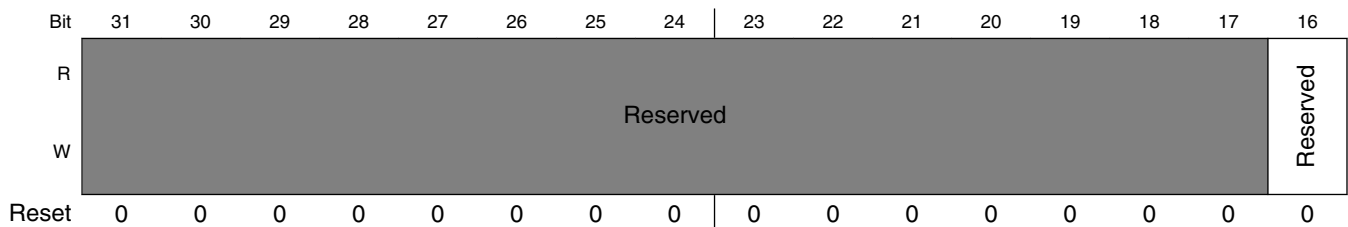

Memory Map and Register Definition

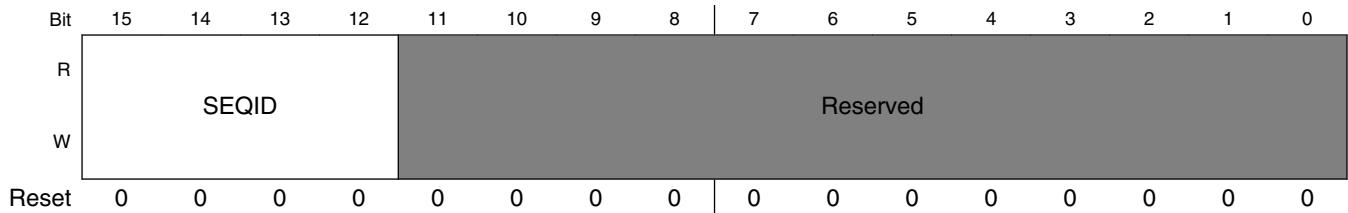

QuadSPI_BFGENCR field descriptions

Field	Description
31–17 Reserved	This field is reserved.
16 Reserved	This field is reserved.
15–12 SEQID	Points to a sequence in the Look-up-table. The SEQID defines the bits [6:2] of the LUT index. The bits [1:0] are always assumed to be 0. Refer to Look-up Table . NOTE: If the sequence pointer differs between the new and previous sequence then the user should reset this. See QSPI_SPTRCLR for more information.
Reserved	This field is reserved.

38.4.2.9 SOC Configuration Register (QuadSPI_SOCCR)

This register is programmed at chip level for QuadSPI delay chain configuration. For details, refer to chip-specific QuadSPI information.

Write:

- $QSPI_SR[AHB_ACC] = 0$

Address: 0h base + 24h offset = 24h

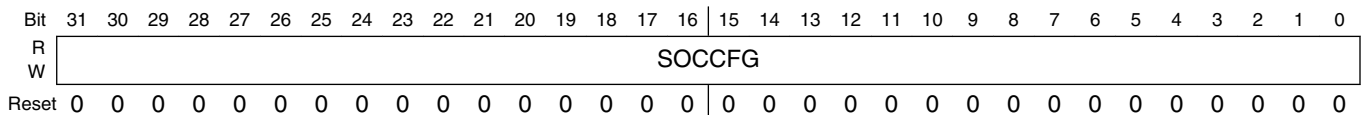

QuadSPI_SOCCR field descriptions

Field	Description
SOCCFG	SOC Configuration For details, refer to chip-specific QuadSPI information.

38.4.2.10 Buffer0 Top Index Register (QuadSPI_BUF0IND)

This register specifies the top index of buffer0, which defines its size. Note that the 3 LSBs of this register are set to zero. This ensures that the buffer is 64-bit aligned, as each buffer entry is 64 bits long.

The register value should be set to the desired number of bytes. For example, setting BUF0IND[31:3] to 0 gives 0 bytes, 1 gives 8 bytes etc.

The size of buffer0 is the difference between BUF0IND and 0.

Software should ensure that BUF0IND value is not greater than the overall size of the buffer. The hardware does not provide any protection against illegal programming.

Write:

- $QSPI_SR[AHB_ACC] = 0$

Address: 0h base + 30h offset = 30h

Bit	31	30	29	28	27	26	25	24	23	22	21	20	19	18	17	16	15	14	13	12	11	10	9	8	7	6	5	4	3	2	1	0
R	TPINDX0																Reserved															
W	TPINDX0																Reserved															
Reset	0	0	0	0	0	0	0	0	0	0	0	0	0	0	0	0	0	0	0	0	0	0	0	0	0	0	0	0	0	0	0	0

QuadSPI_BUF0IND field descriptions

Field	Description
31–3 TPINDX0	Top index of buffer 0.
Reserved	This field is reserved. Reserved.

38.4.2.11 Buffer1 Top Index Register (QuadSPI_BUF1IND)

This register specifies the top index of buffer1, which defines its size. Note that the 3 LSBs of this register are set to zero. This ensures that the buffer is 64-bit aligned as each buffer entry is 64 bits long.

The size of buffer1 is the difference between BUF1IND and BUF0IND. The register value should be entered in bytes. For example, If BUF0IND = 0x100 then setting BUF1IND = 0x130 will set buffer1 size to 0x30 bytes.

It is the responsibility of the software to ensure that BUF1IND value is not greater than the overall size of the buffer. The hardware does not provide any protection against illegal programming.

Write:

- $QSPI_SR[AHB_ACC] = 0$

Address: 0h base + 34h offset = 34h

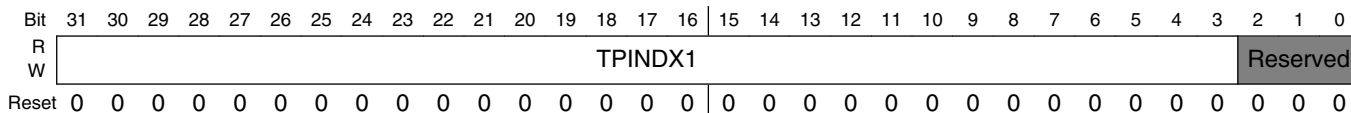

QuadSPI_BUF1IND field descriptions

Field	Description
31–3 TPINDX1	Top index of buffer 1.
Reserved	This field is reserved.

38.4.2.12 Buffer2 Top Index Register (QuadSPI_BUF2IND)

This register specifies the top index of buffer2, which defines its size. Note that that the 3 LSBs of this register are set to zero. This ensures that the buffer is 64-bit aligned as each buffer entry is 64 bits long.

The size of buffer2 is the difference between the BUF2IND and BUF1IND. The register value should be entered in bytes. For example, if BUF1IND = 0x130 then setting BUF2IND = 0x180 will set buffer2 size to 0x50 bytes.

It is the responsibility of the software to ensure that BUF2IND value is not greater than the overall size of the buffer. The hardware does not provide any protection against illegal programming.

Write:

- $QSPI_SR[AHB_ACC] = 0$

Address: 0h base + 38h offset = 38h

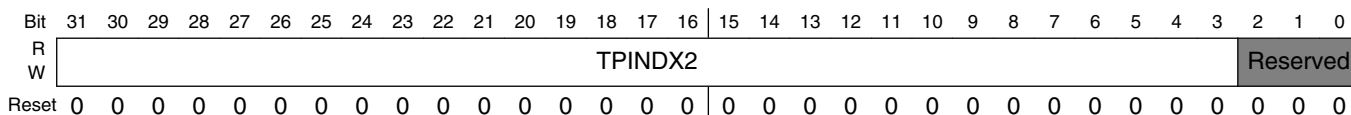

QuadSPI_BUF2IND field descriptions

Field	Description
31–3 TPINDX2	Top index of buffer 2.
Reserved	This field is reserved.

38.4.2.13 Serial Flash Address Register (QuadSPI_SFAR)

The module automatically translates this address on the memory map to the address on the flash itself. When operating in 24-bit mode, only bits 23-0 are sent to the flash. In 32-bit mode, bits 27-0 are used with bits 31-28 driven to 0 when QSPI_SFACR[CAS] is set to 0. Say, if QSPI_SFACR[CAS] is 3 then bits 26-3 are sent to flash as it page address in case flash is operating in 24-bit mode. Total number of address bits request by flash as it page and column address must not be more than 32 bit. Refer to [Table 38-8](#) for the mapping between the access mode and the QSPI_SFAR content and to [Normal Mode](#) for details about the command triggering and command execution. The software should ensure that the serial flash address provided in the QSPI_SFAR register lies in the valid flash address range as defined in [Table 38-8](#).

Write:

- $QSPI_SR[IP_ACC] = 0$

Address: 0h base + 100h offset = 100h

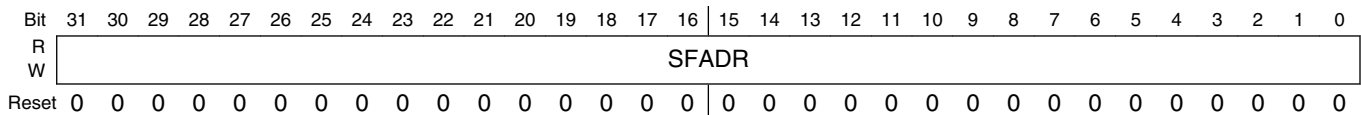

QuadSPI_SFAR field descriptions

Field	Description
SFADR	Serial Flash Address. The register content is used as byte address for all following IP Commands.

38.4.2.14 Serial Flash Address Configuration Register (QuadSPI_SFACR)

This register contains the serial flash specific address requirements that must be configured according to the flash connected, for the controller to function properly. The module automatically translates the address QSPI_SFAR on the memory map or the incoming address on the AHB bus to the column address on the flash itself. Say, a flash needs 3 bits as its column address than only the lower 3 bits of QSPI_SFAR/AHB address are send to flash as its column address. The software should ensure that the serial flash address provided in the QSPI_SFAR register or the incoming AHB address lies in the valid flash address range.

Write:

- $QSPI_SR[IP_ACC] = 0$
- $QSPI_SR[AHB_ACC] = 0$

Memory Map and Register Definition

Address: 0h base + 104h offset = 104h

Bit	31	30	29	28	27	26	25	24		23	22	21	20	19	18	17	16	
R	Reserved																WA	
W	Reserved																	
Reset	0	0	0	0	0	0	0	0		0	0	0	0	0	0	0	0	0
Bit	15	14	13	12	11	10	9	8		7	6	5	4	3	2	1	0	
R	Reserved												CAS					
W	Reserved																	
Reset	0	0	0	0	0	0	0	0		0	0	0	0	0	0	0	0	0

QuadSPI_SFACR field descriptions

Field	Description
31–17 Reserved	This field is reserved.
16 WA	<p>Word Addressable</p> <p>Defines whether the serial flash is a byte addressable flash or a word addressable flash. According to this bit configuration the address is re-mapped to the flash interface. Refer to Address scheme for details.</p> <p>0 Byte addressable serial flash mode. 1 Word (2 byte) addressable serial flash mode.</p>
15–4 Reserved	This field is reserved.
CAS	<p>Column Address Space</p> <p>Defines the width of the column address. If the coulmn address is say [2:0] of QSPI_SFAR/AHB address, then CAS must be 3. If there is no column address separation in any serial flash this bit must be programmed to 0.</p>

38.4.2.15 Sampling Register (QuadSPI_SMPR)

The Sampling Register allows configuration of how the incoming data from the external serial flash devices are sampled in the QuadSPI module.

Write: Disabled Mode

Address: 0h base + 108h offset = 108h

Bit	31	30	29	28	27	26	25	24		23	22	21	20	19	18	17	16	
R	0												Reserved					
W	Reserved																	
Reset	0	0	0	0	0	0	0	0		0	0	0	0	0	0	0	0	0

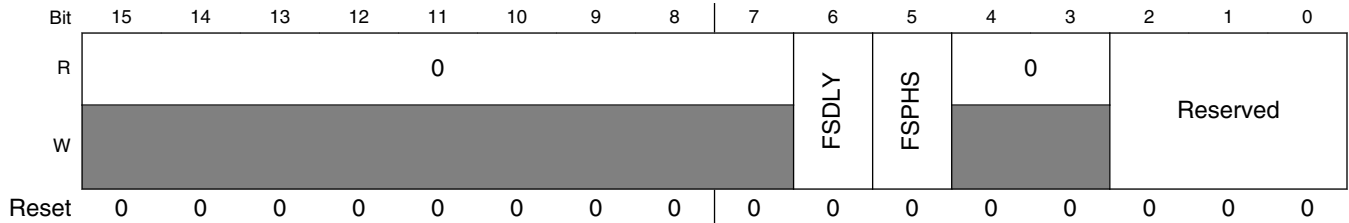

QuadSPI_SMPR field descriptions

Field	Description
31–19 Reserved	This field is reserved. This read-only field is reserved and always has the value 0.
18–16 Reserved	This field is reserved.
15–7 Reserved	This field is reserved. This read-only field is reserved and always has the value 0.
6 FSDLY	Full Speed Delay selection for SDR instructions. Select the delay with respect to the reference edge for the sample point valid for full speed commands. 0 One clock cycle delay 1 Two clock cycles delay.
5 FSPHS	Full Speed Phase selection for SDR instructions. Select the edge of the sampling clock valid for full speed commands. 0 Select sampling at non-inverted clock 1 Select sampling at inverted clock.
4–3 Reserved	This field is reserved. This read-only field is reserved and always has the value 0.
Reserved	This field is reserved.

38.4.2.16 RX Buffer Status Register (QuadSPI_RBSR)

This register contains information related to the receive data buffer.

Address: 0h base + 10Ch offset = 10Ch

Bit	31	30	29	28	27	26	25	24	23	22	21	20	19	18	17	16
R	RDCTR															
W																
Reset	0	0	0	0	0	0	0	0	0	0	0	0	0	0	0	0
Bit	15	14	13	12	11	10	9	8	7	6	5	4	3	2	1	0
R	Reserved		RDBFL						Reserved							
W																
Reset	0	0	0	0	0	0	0	0	0	0	0	0	0	0	0	0

QuadSPI_RBSR field descriptions

Field	Description
31–16 RDCTR	Read Counter. Indicates how many entries of 4 bytes have been removed from the RX Buffer. For example, a value of 0x2 would indicate 8 bytes have been removed. It is incremented by the number (QSPI_RBCT[WMRK] + 1) on RX Buffer POP event. The RX Buffer can be popped using DMA or pop flag QSPI_FR[RBDP]. The QSPI_RSER[RBDDE] defines which pop has to be done. For further details, refer to AHB RX Data Buffer (QSPI_ARDB0 to QSPI_ARDB31) and "Data Transfer from the QuadSPI Module Internal Buffers" section in Flash Read .
15–14 Reserved	This field is reserved.
13–8 RDBFL	RX Buffer Fill Level. Indicates how many entries of 4 bytes are still available in the RX Buffer. For example, a value of 0x2 would indicate 8 bytes are available.
Reserved	This field is reserved.

38.4.2.17 RX Buffer Control Register (QuadSPI_RBCT)

This register contains control data related to the receive data buffer.

Write:

- $QSPI_SR[IP_ACC] = 0$

Address: 0h base + 110h offset = 110h

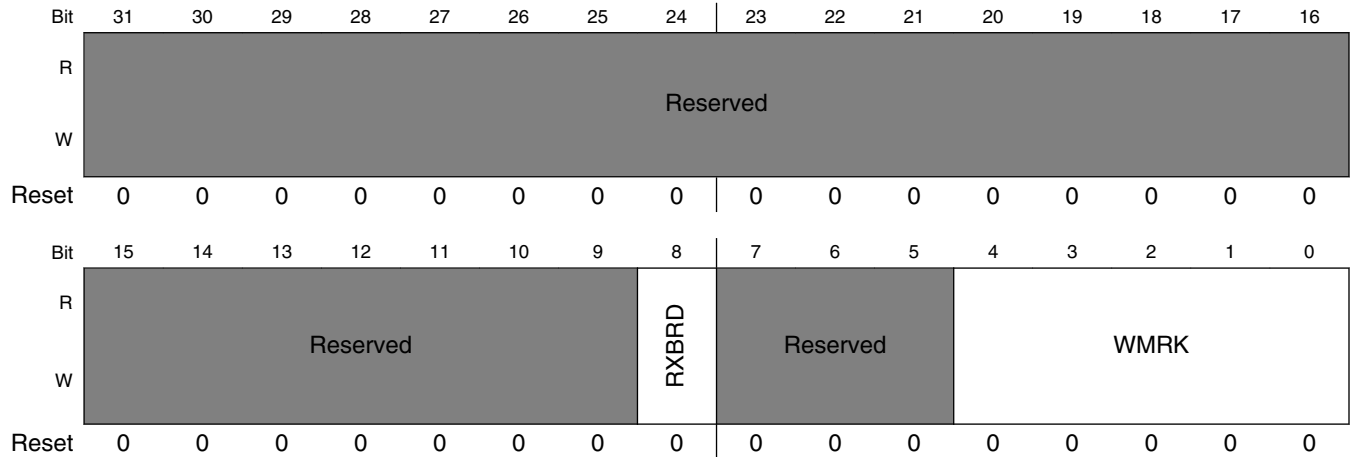

QuadSPI_RBCT field descriptions

Field	Description
31–9 Reserved	This field is reserved.
8 RXBRD	RX Buffer Readout. This field specifies the access scheme for the RX Buffer readout. 0 RX Buffer content is read using the AHB Bus registers QSPI_ARDB0 to QSPI_ARDB31. 1 RX Buffer content is read using the IP Bus registers QSPI_RBDR0 to QSPI_RBDR31.
7–5 Reserved	This field is reserved.
WMRK	RX Buffer Watermark. This field determines when the readout action of the RX Buffer is triggered. When the number of valid entries in the RX Buffer is equal to or greater than the number given by (WMRK+1) the QSPI_SR[RXWE] flag is asserted. The value should be entered as the number of 4-byte entries minus 1. For example, a value of 0x0 would set the watermark to 4 bytes, 1 to 8 bytes, 2 to 12 bytes, and so on. For details, refer to DMA Usage .

38.4.2.18 TX Buffer Status Register (QuadSPI_TBSR)

This register contains information related to the transmit data buffer.

Address: 0h base + 150h offset = 150h

Bit	31	30	29	28	27	26	25	24		23	22	21	20	19	18	17	16
R	TRCTR																
W	[Reserved]																
Reset	0	0	0	0	0	0	0	0		0	0	0	0	0	0	0	0
Bit	15	14	13	12	11	10	9	8		7	6	5	4	3	2	1	0
R	Reserved		TRBFL						Reserved								
W	[Reserved]		[Reserved]						[Reserved]								
Reset	0	0	0	0	0	0	0	0		0	0	0	0	0	0	0	0

QuadSPI_TBSR field descriptions

Field	Description
31–16 TRCTR	Transmit Counter. This field indicates how many entries of 4 bytes have been written into the TX Buffer by host accesses. It is reset to 0 when a 1 is written to QSPI_MCR[CLR_TXF]. It is incremented on each write access to the QSPI_TBDR register when another word has been pushed onto the TX Buffer. When it is not cleared the TRCTR field wraps around to 0. Refer to TX Buffer Data Register (QuadSPI_TBDR) for details.
15–14 Reserved	This field is reserved.
13–8 TRBFL	TX Buffer Fill Level. The TRBFL field contains the number of entries of 4 bytes each available in the TX Buffer for the QuadSPI module to transmit to the serial flash device.
Reserved	This field is reserved.

38.4.2.19 TX Buffer Data Register (QuadSPI_TBDR)

The QSPI_TBDR register provides access to the circular TX Buffer of depth 128 bytes. This buffer provides the data written into it as write data for the page programming commands to the serial flash device. Refer to [Table 38-16](#) for the byte ordering scheme. A write transaction on the flash with data size of less than 32 bits will lead to the removal of four data entry from the TX buffer. The valid bits will be used and the rest of the bits will be discarded.

Write:

- $QSPI_SR[TXFULL] = 0$

32-bit write access required

Address: 0h base + 154h offset = 154h

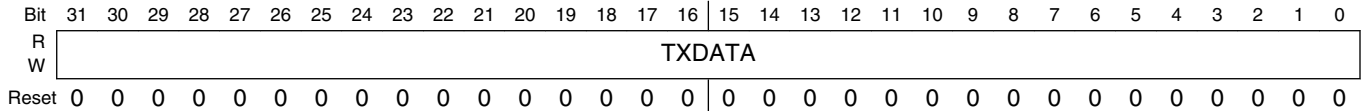

QuadSPI_TBDR field descriptions

Field	Description
TXDATA	TX Data On write access the data is written into the next available entry of the TX Buffer and the QPSI_TBSR[TRBFL] field is updated accordingly. On a read access, the last data written to the register is returned.

38.4.2.20 Tx Buffer Control Register (QuadSPI_TBCT)

This register contains control information for transmit data buffer.

Address: 0h base + 158h offset = 158h

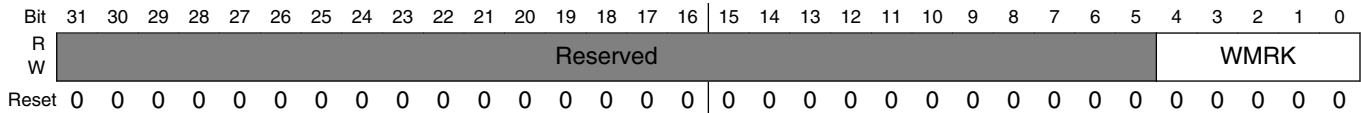

QuadSPI_TBCT field descriptions

Field	Description
31–5 Reserved	This field is reserved.
WMRK	Determines the watermark for the TX Buffer. When the number of available space in TX Buffer is greater than the number given by (WMRK+1), QSPI_SR[TXWA] is asserted. The values should be entered as the number of 4Bytes entries minus 1. For example, a value of 0x0 would set the watermark to 4 bytes, 1 to 8 bytes, 2 to 12 Bytes, and so on. For details, refer to DMA Usage .

38.4.2.21 Status Register (QuadSPI_SR)

The QSPI_SR register provides all available status information about SFM command execution and arbitration, the RX Buffer, TX Buffer, and the AHB Buffer.

Address: 0h base + 15Ch offset = 15Ch

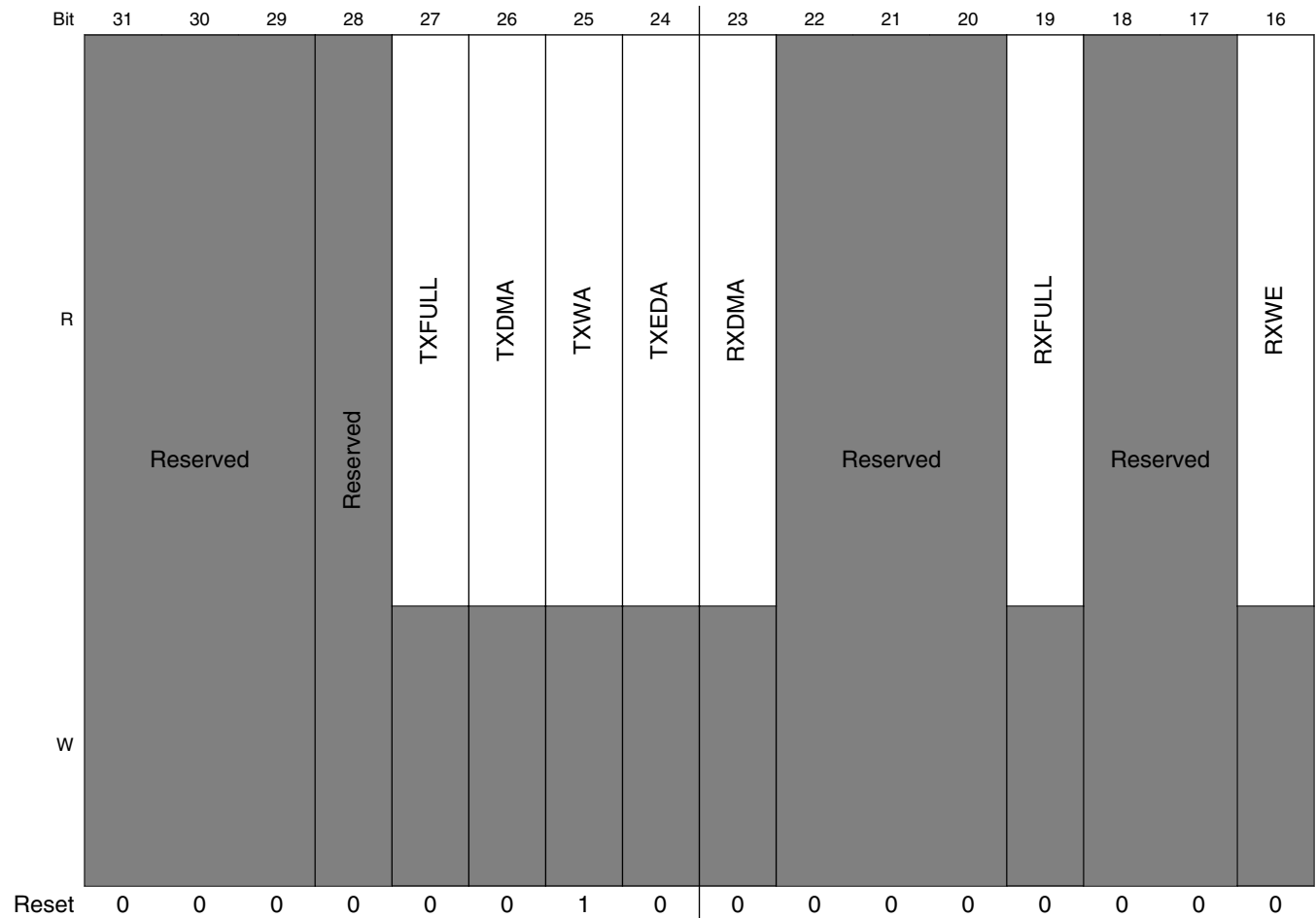

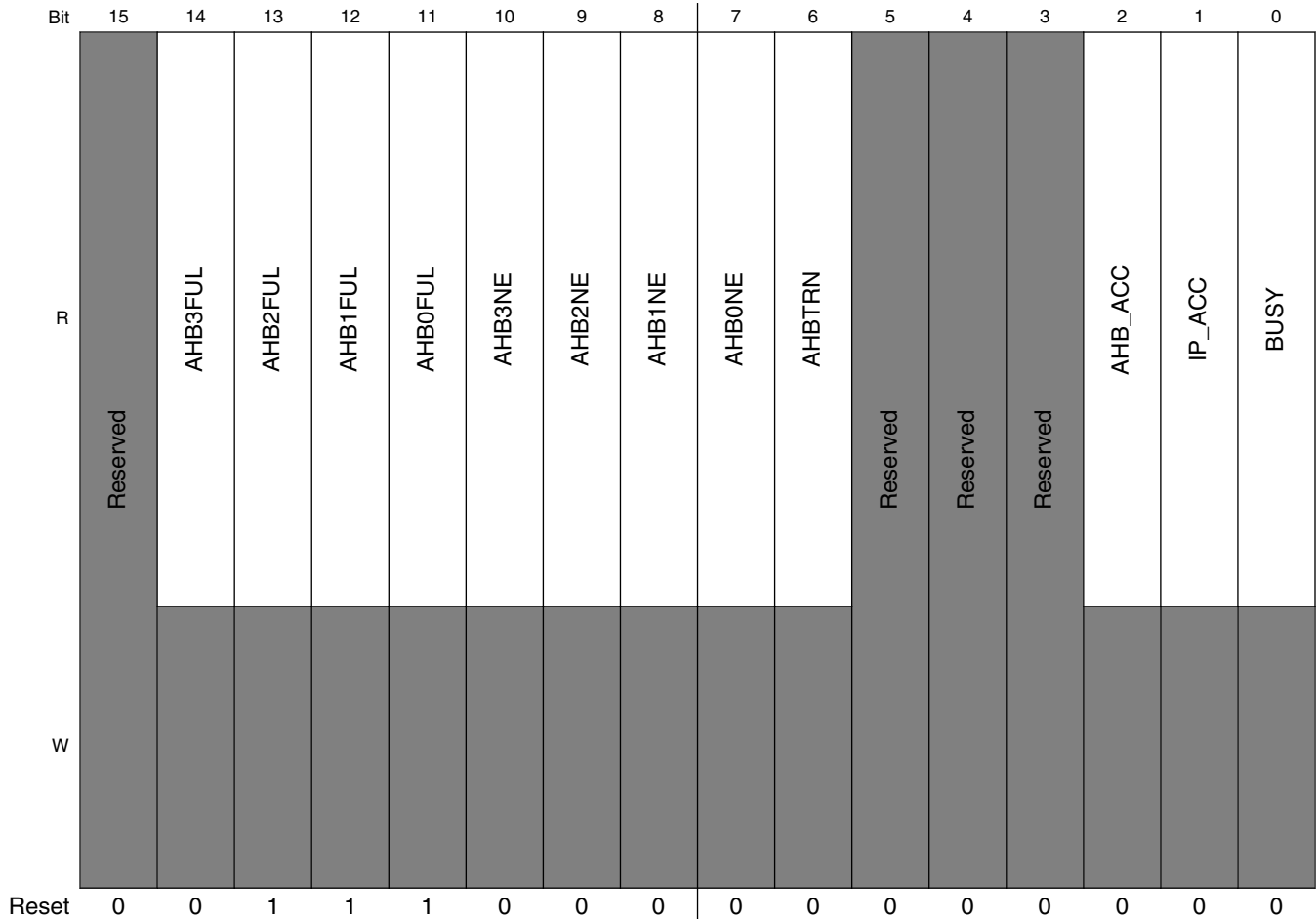

QuadSPI_SR field descriptions

Field	Description
31–29 Reserved	This field is reserved.
28 Reserved	This field is reserved.
27 TXFULL	TX Buffer Full. Asserted when no more data can be stored.
26 TXDMA	TXDMA Asserted when TXFIFO fill via DMA is active i.e. DMA is requested or running
25 TXWA	TX Buffer watermark Available Asserted when the number of available spaces in TX buffer is greater than or equal to the value give by QSPI_TBCT[WMRK].
24 TXEDA	Tx Buffer Enough Data Available Asserted when TX Buffer contains enough data for any pop operation to take place. There must be at least 128 bit data available in TX FIFO for any pop operation; otherwise, QSPI_FR[TBUF] will be set.
23 RXDMA	RX Buffer DMA. Asserted when RX Buffer read out via DMA is active i.e DMA is requested or running.

Table continues on the next page...

QuadSPI_SR field descriptions (continued)

Field	Description
22–20 Reserved	This field is reserved.
19 RXFULL	RX Buffer Full. Asserted when the RX Buffer is full, i.e. that QSPI_RBSR[RDBFL] field is equal to 32.
18–17 Reserved	This field is reserved.
16 RXWE	RX Buffer Watermark Exceeded. Asserted when the number of valid entries in the RX Buffer exceeds the number given in the QSPI_RBCT[WMRK] field.
15 Reserved	This field is reserved.
14 AHB3FUL	AHB 3 Buffer Full. Asserted when AHB 3 buffer is full.
13 AHB2FUL	AHB 2 Buffer Full. Asserted when AHB 2 buffer is full.
12 AHB1FUL	AHB 1 Buffer Full. Asserted when AHB 1 buffer is full.
11 AHB0FUL	AHB 0 Buffer Full. Asserted when AHB 0 buffer is full.
10 AHB3NE	AHB 3 Buffer Not Empty. Asserted when AHB 3 buffer contains data.
9 AHB2NE	AHB 2 Buffer Not Empty. Asserted when AHB 2 buffer contains data.
8 AHB1NE	AHB 1 Buffer Not Empty. Asserted when AHB 1 buffer contains data.
7 AHB0NE	AHB 0 Buffer Not Empty. Asserted when AHB 0 buffer contains data.
6 AHBTRN	AHB Access Transaction pending. Asserted when there is a pending request on the AHB interface. Refer to the AMBA specification for details.
5 Reserved	This field is reserved.
4 Reserved	This field is reserved.
3 RESERVED	This field is reserved.
2 AHB_ACC	AHB Access. Asserted when the transaction currently executed was initiated by AHB bus.
1 IP_ACC	IP Access. Asserted when transaction currently executed was initiated by IP bus.
0 BUSY	Module Busy. Asserted when module is currently busy handling a transaction to an external flash device.

38.4.2.22 Flag Register (QuadSPI_FR)

The QSPI_FR register provides all available flags about SFM command execution and arbitration which may serve as source for the generation of interrupt service requests. Note that the error flags in this register do not relate directly to the execution of the transaction in the serial flash device itself but only to the behavior and conditions visible in the QuadSPI module.

Write: Enabled Mode

Address: 0h base + 160h offset = 160h

Bit	31	30	29	28	27	26	25	24	23	22	21	20	19	18	17	16	
R	Reserved			Reserved	TBFF	TBUF	Reserved		ILLINE	Reserved						RBOF	RBDF
W	Reserved			Reserved	w1c	w1c	Reserved		w1c	Reserved						w1c	w1c
Reset	0	0	0	0	1	0	0	0	0	0	0	0	0	0	0	0	

Memory Map and Register Definition

Bit	15	14	13	12	11	10	9	8	7	6	5	4	3	2	1	0
R	ABSEF	AITEF	AIBSEF	ABOF	Reserved	Reserved			IPAEF	PIEF	Reserved	Reserved	Reserved			TFF
W	w1c	w1c	w1c	w1c	w1c	Reserved			w1c	w1c	Reserved	Reserved	Reserved			w1c
Reset	0	0	0	0	0	0	0	0	0	0	0	0	0	0	0	0

QuadSPI_FR field descriptions

Field	Description
31 Reserved	This field is reserved.
30–29 RESERVED	This field is reserved.
28 Reserved	This field is reserved.
27 TBFF	TX Buffer Fill Flag. Before writing to the TX buffer, this bit should be cleared. Then this bit has to be read back. If the bit is set, the TX Buffer can take more data. If the bit remains cleared, the TX buffer is full. Refer to Tx Buffer Operation for details.
26 TBUF	TX Buffer Underrun Flag. Set when the module tried to pull data although TX Buffer was empty or the buffer contains less than 128 bits of data. The application must ensure that the buffer never goes empty during a transaction except for the last data fetch. The IP Command leading to the TX Buffer underrun is continued (data sent to the serial flash device is all F in case of valid TX underrun). Here valid 'underrun' means that, it should have occurred during the transacting such that few bytes (i.e., less than 4 bytes) are left in FIFO and remaining are filled with "FFFFh". Software should start TX transaction only when 128-bits are written in TX buffer. The application must clear the TX Buffer in response to this event by writing a '1' to the QSPI_MCR[CLR_TXF].
25–24 Reserved	This field is reserved.
23 ILLINE	Illegal Instruction Error Flag. Set when an illegal instruction is encountered by the controller in any of the sequences. As soon as this flag is set, user should assert QSPI_MCR[SWRSTSD], QSPI_MCR[SWRSTHD] and after software resets de-assertion in normal mode, QSPI_MCR[CLR_TXF] and QSPI_MCR[CLR_RXF] should be set to clear any remaining data in buffers i.e., reset to flash and AHB domain after re-configuring the correct sequence instruction. Refer to Table 38-14 for a list of legal instructions.
22–18 Reserved	This field is reserved.

Table continues on the next page...

QuadSPI_FR field descriptions (continued)

Field	Description
17 RBOF	<p>RX Buffer Overflow Flag. Set when not all the data read from the serial flash device could be pushed into the RX Buffer.</p> <p>The IP Command leading to this condition is continued until the number of bytes according to the QSPI_IPCR[IDATSZ] field has been read from the serial flash device.</p> <p>The content of the RX Buffer is not changed.</p>
16 RBDF	<p>RX Buffer Drain Flag. Will be set if the QuadSPI_SR[RXWE] status bit is asserted.</p> <p>Writing 1 into this bit triggers one of the following actions:</p> <ul style="list-style-type: none"> • If the RX Buffer has up to QuadSPI_RBCT[WMRK] valid entries then the flag is cleared. • If the RX Buffer has more than QuadSPI_RBCT[WMRK] valid entries and the QuadSPI_RSER[RBDDE] bit is not set (flag driven mode) a RX Buffer POP event is triggered. <p>The flag remains set if the RX Buffer contains more than QuadSPI_RBCT[WMRK] valid entries after the RX Buffer POP event is finished.</p> <p>The flag is cleared if the RX Buffer contains less than or equal to QuadSPI_RBCT[WMRK] valid entries after the RX Buffer POP event is finished.</p> <p>Refer to "Receive Buffer Drain Interrupt or DMA Request" section in Normal Mode Interrupt and DMA Requests, for details.</p>
15 ABSEF	<p>AHB Sequence Error Flag. Set when the execution of an AHB Command is started with a WRITE or WRITE_DDR Command in the sequence pointed to by the QSPI_BUFxCR register. (QSPI_BUFxCR implies any one of QSPI_BUF0CR/QSPI_BUF1CR/QSPI_BUF2CR/QSPI_BUF3CR.)</p> <p>Communication with the serial flash device is terminated before the execution of WRITE/WRITE_DDR command by the QuadSPI module.</p> <p>The AHB bus request which triggered this command is answered with an ERROR response.</p>
14 AITEF	<p>AHB Illegal transaction error flag. Set whenever there is no response generated from QSPI to AHB bus in case of illegal transaction and the watchdog timer expires. The timer value is taken as parameter.</p>
13 AIBSEF	<p>AHB Illegal Burst Size Error Flag. Set whenever the total burst size (size x beat) of an AHB transaction is greater than the prefetch data size. The prefetch data size is defined by QSPI_BUFxCR[ADATSZ] or data size mentioned in the sequence pointed to by the SEQID field in case ADATSZ = 0. Refer to HBURST Support for more details on HBURST feature.</p>
12 ABOF	<p>AHB Buffer Overflow Flag. Set when the size of the AHB access exceeds the size of the AHB buffer. This condition can occur only if the QSPI_BUFxCR[ADATSZ] field is programmed incorrectly.</p> <p>The AHB Command leading to this condition is continued until the number of entries according to the QSPI_BUFxCR[ADATSZ] field has been read from the serial flash device.</p> <p>The content of the AHB Buffer is not changed.</p>
11 Reserved	This field is reserved.
10–8 Reserved	This field is reserved.
7 IPAIEF	<p>IP Command Trigger during AHB Access Error Flag. Set when the following condition occurs:</p> <ul style="list-style-type: none"> • A write access occurs to the QSPI_IPCR[SEQID] field and the QSPI_SR[AHB_ACC] bit is set. Any command leading to the assertion of the IPAIEF flag is ignored.
6 IPIEF	<p>IP Command Trigger could not be executed Error Flag. Set when the QSPI_SR[IP_ACC] bit is set (i.e. an IP triggered command is currently executing) and any of the following conditions occurs:</p> <ul style="list-style-type: none"> • Write access to the QSPI_IPCR register. Any command leading to the assertion of the IPIEF flag is ignored • Write access to the QSPI_SFAR register. • Write access to the QSPI_RBCT register.

Table continues on the next page...

QuadSPI_FR field descriptions (continued)

Field	Description
5 Reserved	This field is reserved.
4 Reserved	This field is reserved.
3–1 Reserved	This field is reserved.
0 TFF	IP Command Transaction Finished Flag. Set when the QuadSPI module has finished a running IP Command. If an error occurred the related error flags are valid, at the latest, in the same clock cycle when the TFF flag is asserted.

38.4.2.23 Interrupt and DMA Request Select and Enable Register (QuadSPI_RSER)

The QuadSPI_RSER register provides enables and selectors for the interrupts in the QuadSPI module.

NOTE

Each flag of the QuadSPI_FR register enabled as source for an interrupt prevents the QuadSPI module from entering Stop Mode or Module Disable Mode when this flag is set.

Write: Anytime

Address: 0h base + 164h offset = 164h

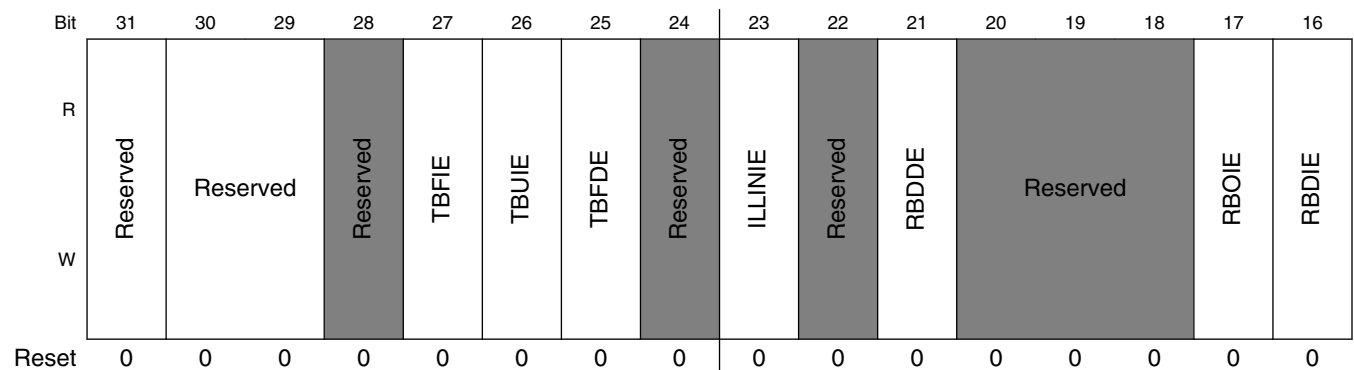

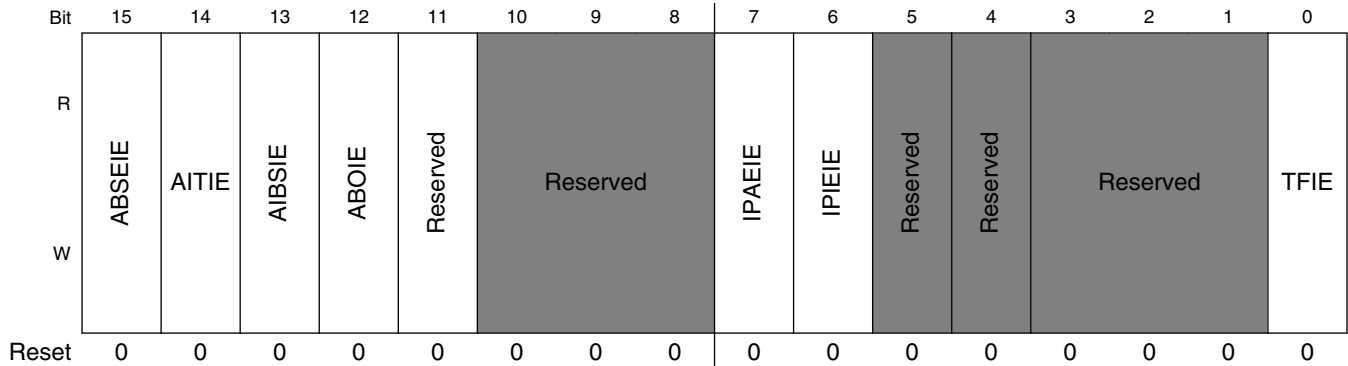

QuadSPI_RSER field descriptions

Field	Description
31 Reserved	Reserved This field is reserved.
30–29 Reserved	This field is reserved.
28 Reserved	This field is reserved.
27 TBFIE	TX Buffer Fill Interrupt Enable 0 No TBFF interrupt will be generated 1 TBFF interrupt will be generated
26 TBUIE	TX Buffer Underrun Interrupt Enable 0 No TBUF interrupt will be generated 1 TBUF interrupt will be generated
25 TBFDE	TX Buffer Fill DMA Enable Enables generation of DMA requests for TX Buffer fill. When this is set, DMA requests are generated as long as the QuadSPI_SR[TXWA] status bit is set. NOTE: <ul style="list-style-type: none"> Once set, writing a zero does not impact DMA transfers, even though the bit gets written a zero. After QuadSPI_MCR[SWRSTHD] is used to do software reset for AHB Domain, this bit takes effect and needs to be written a 1 to re-enable DMA transfers. 0 No DMA request will be generated 1 DMA request will be generated
24 Reserved	This field is reserved.
23 ILLINIE	Illegal Instruction Error Interrupt Enable. Triggered by ILLINE flag in QSPI_FR 0 No ILLINE interrupt will be generated 1 ILLINE interrupt will be generated
22 Reserved	This field is reserved.
21 RBDDE	RX Buffer Drain DMA Enable: Enables generation of DMA requests for RX Buffer Drain. When this bit is set DMA requests are generated as long as the QSPI_SR[RXWE] status bit is set.

Table continues on the next page...

QuadSPI_RSER field descriptions (continued)

Field	Description
	0 No DMA request will be generated 1 DMA request will be generated
20–18 Reserved	This field is reserved.
17 RBOIE	RX Buffer Overflow Interrupt Enable 0 No RBOF interrupt will be generated 1 RBOF interrupt will be generated
16 RBDIE	RX Buffer Drain Interrupt Enable: Enables generation of IRQ requests for RX Buffer Drain. When this bit is set the interrupt is asserted as long as the QuadSPI_SR[RBDF] flag is set. 0 No RBDF interrupt will be generated 1 RBDF Interrupt will be generated
15 ABSEIE	AHB Sequence Error Interrupt Enable: Triggered by ABSEF flags of QSPI_FR 0 No ABSEF interrupt will be generated 1 ABSEF interrupt will be generated
14 AITIE	AHB Illegal transaction interrupt enable. 0 No AITEF interrupt will be generated 1 AITEF interrupt will be generated
13 AIBSIE	AHB Illegal Burst Size Interrupt Enable 0 No AIBSEF interrupt will be generated 1 AIBSEF interrupt will be generated
12 ABOIE	AHB Buffer Overflow Interrupt Enable 0 No ABOF interrupt will be generated 1 ABOF interrupt will be generated
11 Reserved	This field is reserved.
10–8 Reserved	This field is reserved.
7 IPAEIE	IP Command Trigger during AHB Access Error Interrupt Enable 0 No IPAIEF interrupt will be generated 1 IPAIEF interrupt will be generated
6 IPIEIE	IP Command Trigger during IP Access Error Interrupt Enable 0 No IPIEF interrupt will be generated 1 IPIEF interrupt will be generated
5 Reserved	This field is reserved.
4 Reserved	This field is reserved.
3–1 Reserved	This field is reserved. Reserved.

Table continues on the next page...

QuadSPI_RSER field descriptions (continued)

Field	Description
0 TFIE	Transaction Finished Interrupt Enable 0 No TFF interrupt will be generated 1 TFF interrupt will be generated

38.4.2.24 Sequence Suspend Status Register (QuadSPI_SPNDST)

The sequence suspend status register provides information specific to any suspended sequence. An AHB sequence may be suspended when a high priority AHB master makes an access before the AHB sequence completes the data transfer requested.

Address: 0h base + 168h offset = 168h

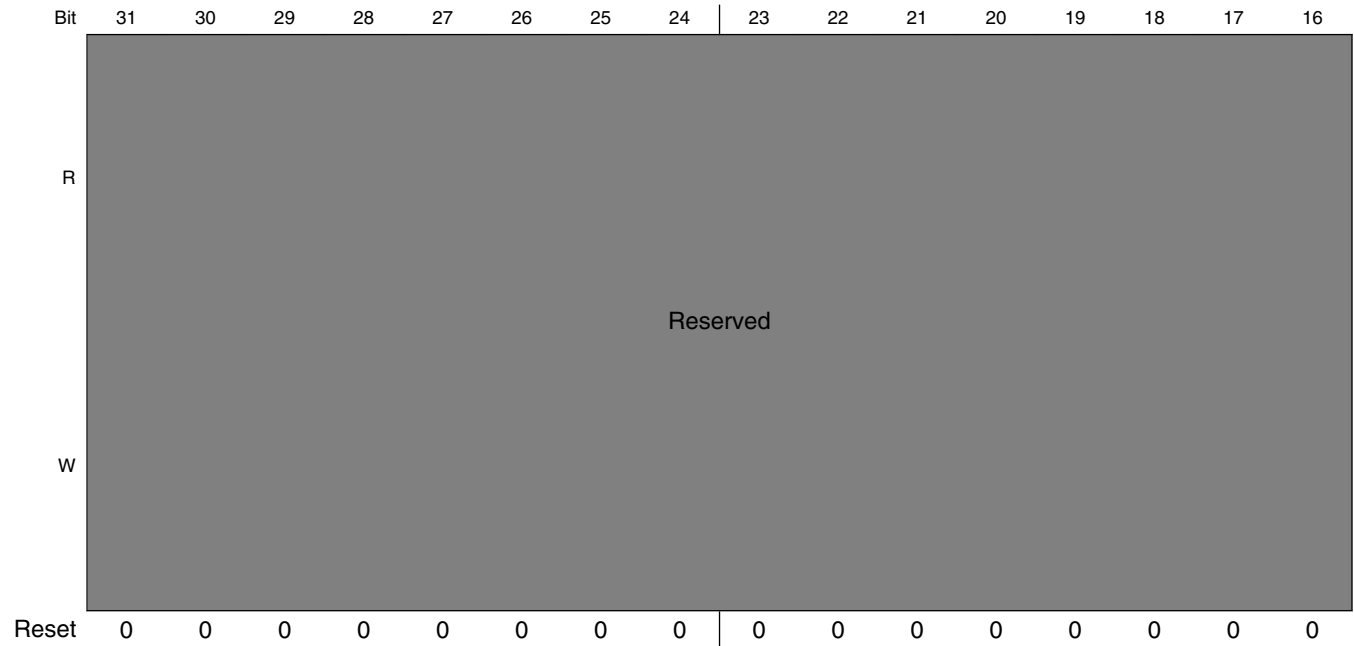

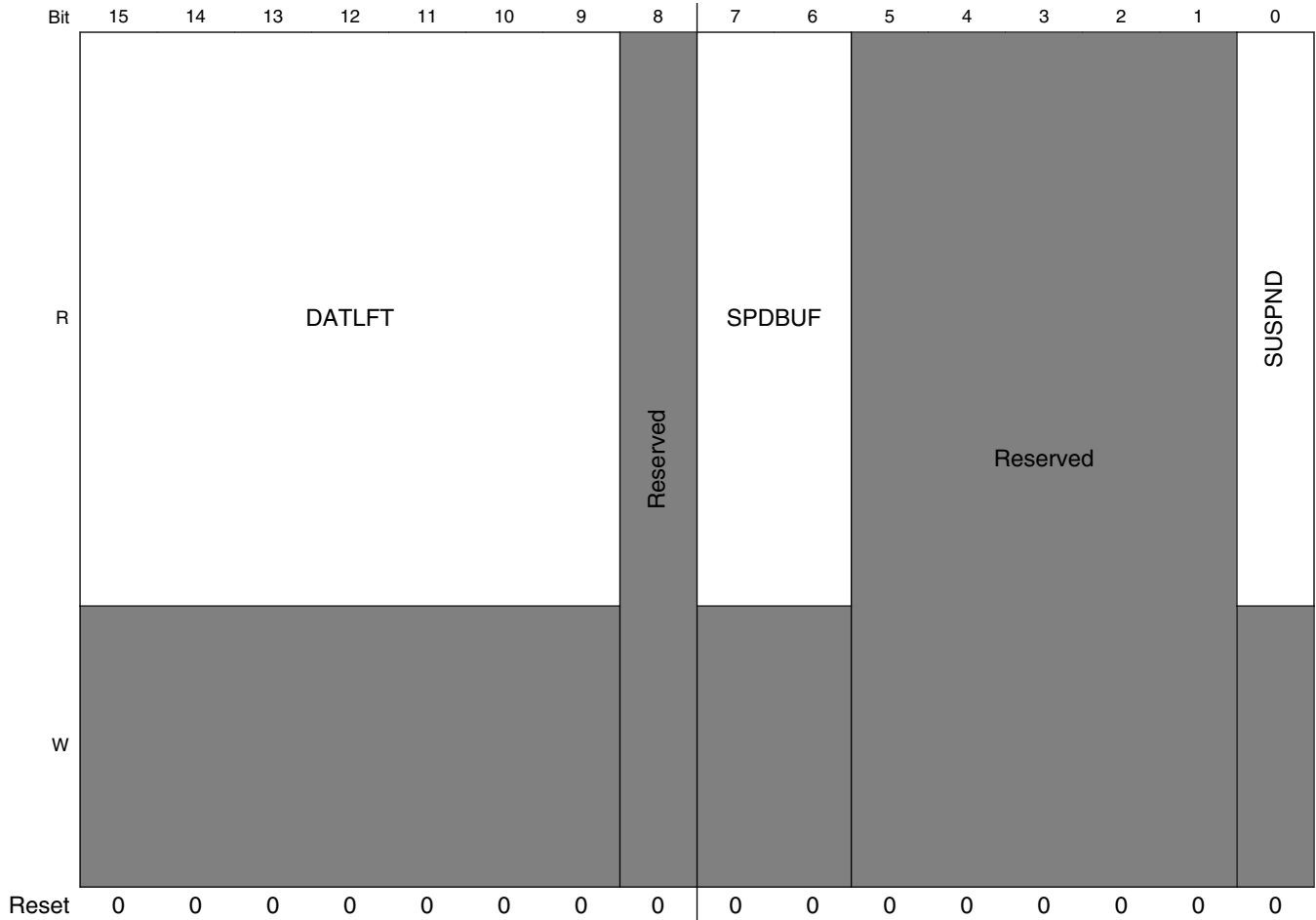

QuadSPI_SPNDST field descriptions

Field	Description
31–16 Reserved	This field is reserved.
15–9 DATLFT	Data left: Provides information about the amount of data left to be read in the suspended sequence. Valid only when SUSPND is set to 1'b1. Value in terms of 64 bits or 8 bytes
8 Reserved	This field is reserved.
7–6 SPDBUF	Suspended Buffer: Provides the suspended buffer number. Valid only when SUSPND is set to 1'b1
5–1 Reserved	This field is reserved.
0 SUSPND	When set, it signifies that a sequence is in suspended state

38.4.2.25 Sequence Pointer Clear Register (QuadSPI_SPTRCLR)

The sequence pointer clear register provides bits to reset the IP and Buffer sequence pointers. The sequence pointer contains the index of which instruction within the LUT entry is to be executed next. For example, if the LUT entry ends on a JMP_ON_CS value of 2, the index will be stored as 2.

The software should reset the sequence pointers whenever the sequence ID is changed by updating the SEQID field in QSPI_IPCR or QSPI_BFGENCR.

Address: 0h base + 16Ch offset = 16Ch

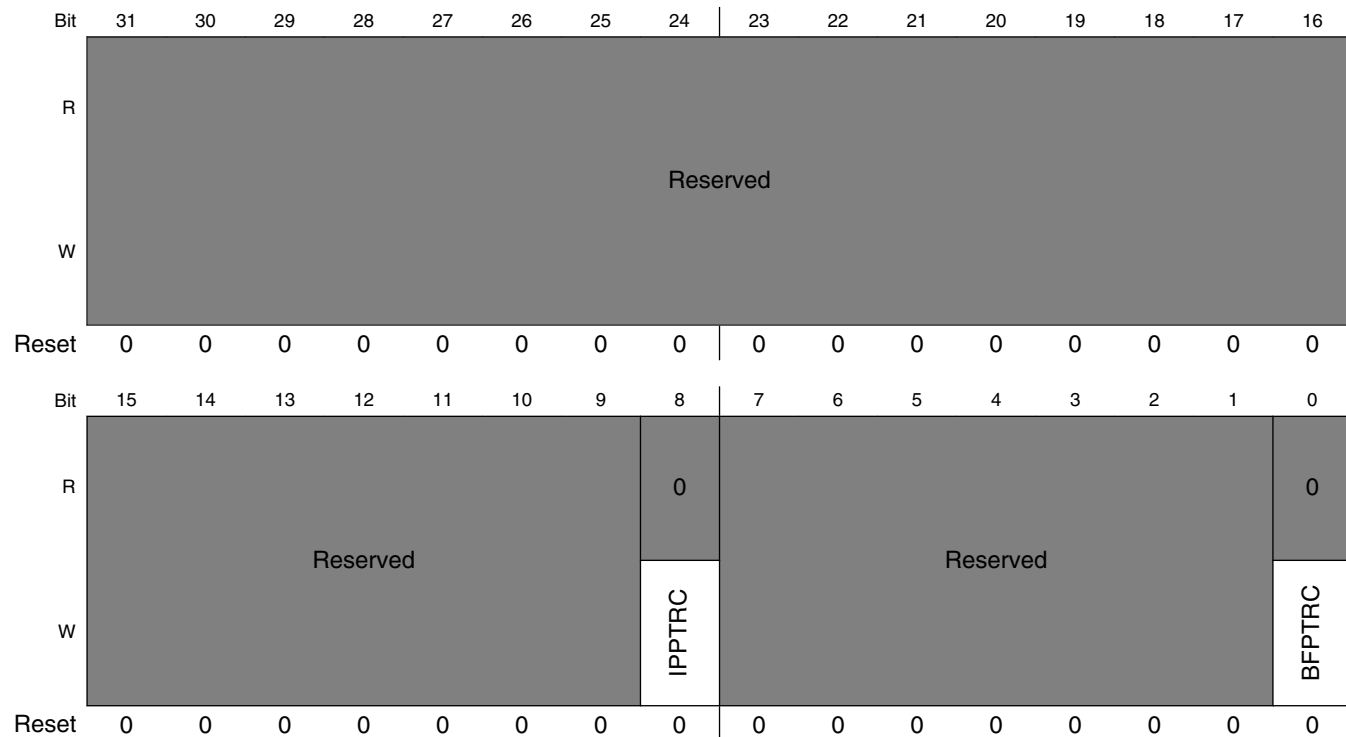

QuadSPI_SPTRCLR field descriptions

Field	Description
31–9 Reserved	This field is reserved.
8 IPPTRC	IP Pointer Clear: 1: Clears the sequence pointer for IP accesses as defined in QuadSPI_IPCR This is a self-clearing field. This bit should be programmed two times to clear the sequence pointers.
7–1 Reserved	This field is reserved. Reserved.
0 BFPTRC	Buffer Pointer Clear: 1: Clears the sequence pointer for AHB accesses as defined in QuadSPI_BFGENCR. This is a self-clearing field. This bit should be programmed two times to clear the sequence pointers.

38.4.2.26 Serial Flash A1 Top Address (QuadSPI_SFA1AD)

The QSPI_SFA1AD register provides the address mapping for the serial flash A1. The difference between QSPI_SFA1AD[TPADA1] and QSPI_AMBA_BASE defines the size of the memory map for serial flash A1.

Write:

- $QSPI_SR[IP_ACC] = 0$
- $QSPI_SR[AHB_ACC] = 0$

Address: 0h base + 180h offset = 180h

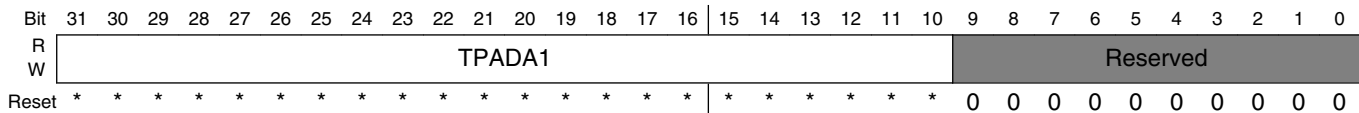

* Notes:

- TPADA1 field: See the module configuration for the device specific reset values.

QuadSPI_SFA1AD field descriptions

Field	Description
31–10 TPADA1	Top address for Serial Flash A1. In effect, TPADxx is the first location of the next memory.
Reserved	This field is reserved.

38.4.2.27 Serial Flash A2 Top Address (QuadSPI_SFA2AD)

The QSPI_SFA2AD register provides the address mapping for the serial flash A2. The difference between QSPI_SFA2AD[TPADA2] and QSPI_SFA1AD[TPADA1] defines the size of the memory map for serial flash A2.

Write:

- $QSPI_SR[IP_ACC] = 0$
- $QSPI_SR[AHB_ACC] = 0$

Address: 0h base + 184h offset = 184h

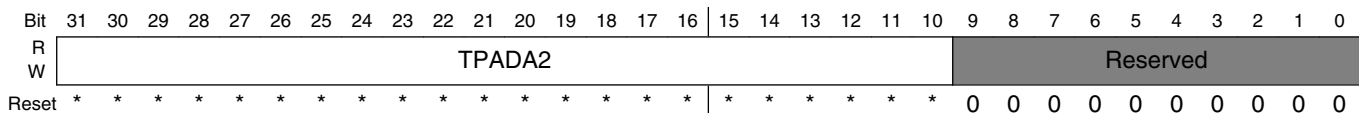

* Notes:

- TPADA2 field: See the module configuration for the device specific reset values.

QuadSPI_SFA2AD field descriptions

Field	Description
31–10 TPADA2	Top address for Serial Flash A2. In effect, TPxxAD is the first location of the next memory.
Reserved	This field is reserved.

38.4.2.28 Serial Flash B1 Top Address (QuadSPI_SFB1AD)

The QSPI_SFB1AD register provides the address mapping for the serial flash B1. The difference between QSPI_SFB1AD[TPADB1] and QSPI_SFA2AD[TPADA2] defines the size of the memory map for serial flash B1.

Write:

- $QSPI_SR[IP_ACC] = 0$
- $QSPI_SR[AHB_ACC] = 0$

Address: 0h base + 188h offset = 188h

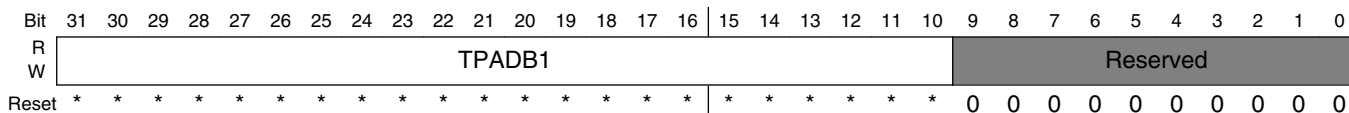

* Notes:

- TPADB1 field: See the module configuration for the device specific reset values.

QuadSPI_SFB1AD field descriptions

Field	Description
31–10 TPADB1	Top address for Serial Flash B1. In effect, TPxxAD is the first location of the next memory.
Reserved	This field is reserved.

38.4.2.29 Serial Flash B2 Top Address (QuadSPI_SFB2AD)

The QSPI_SFB2AD register provides the address mapping for the serial flash B2. The difference between QSPI_SFB2AD[TPADB2] and QSPI_SFB1AD[TPADB1] defines the size of the memory map for serial flash B2.

Write:

- $QSPI_SR[IP_ACC] = 0$
- $QSPI_SR[AHB_ACC] = 0$

Address: 0h base + 18Ch offset = 18Ch

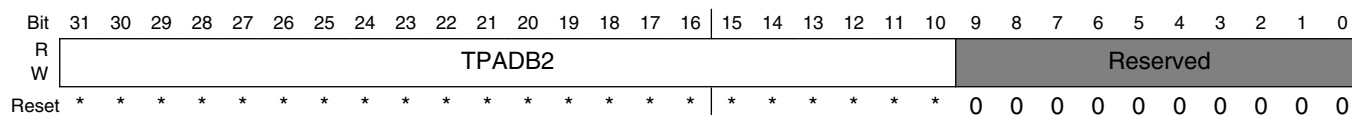

* Notes:

- TPADB2 field: See the module configuration for the device specific reset values.

QuadSPI_SFB2AD field descriptions

Field	Description
31–10 TPADB2	Top address for Serial Flash B2. In effect, TPxxAD is the first location of the next memory.
Reserved	This field is reserved.

38.4.2.30 RX Buffer Data Register (QuadSPI_RBDR_n)

The QuadSPI_RBDR registers provide access to the individual entries in the RX Buffer. Refer to [Table 38-16](#) for the byte ordering scheme.

QuadSPI_RBDR0 corresponds to the actual position of the read pointer within the RX Buffer. The number of valid entries available depends from the number of RX Buffer entries implemented and from the number of valid buffer entries available in the RX Buffer.

Example 1, RX Buffer filled completely with 32 words: In this case the address range for valid read access extends from QuadSPI_RBDR0 to QuadSPI_RBDR31.

Example 2, RX Buffer filled with 5 valid words: RX Buffer fill level QuadSPI_RBSR[RDBFL] is 5. In this case an access to QuadSPI_RBDR4 provides the last valid entry.

Any access beyond the range of valid RX Buffer entries provides undefined results.

Address: 0h base + 200h offset + (4d × i), where i=0d to 31d

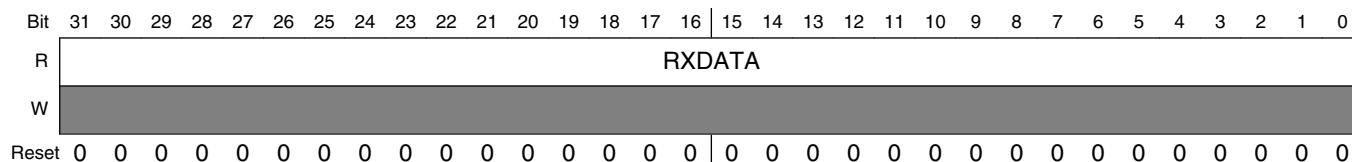

QuadSPI_RBDR_n field descriptions

Field	Description
RXDATA	RX Data. The RXDATA field contains the data associated with the related RX Buffer entry. Data format and byte ordering is given in Byte Ordering of Serial Flash Read Data .

38.4.2.31 LUT Key Register (QuadSPI_LUTKEY)

The LUT Key register contains the key to lock and unlock the Look-up-table. Refer to [Look-up Table](#) for details.

Write: Anytime

Address: 0h base + 300h offset = 300h

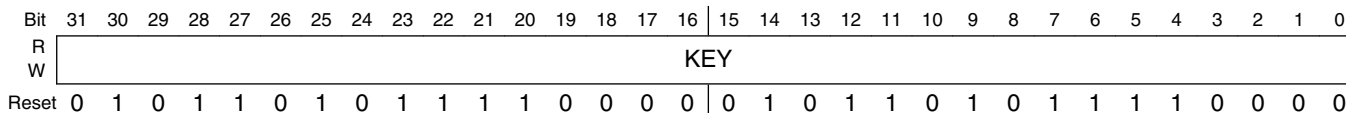

QuadSPI_LUTKEY field descriptions

Field	Description
KEY	The key to lock or unlock the LUT. The KEY is 0x5AF05AF0. The read value is always 0x5AF05AF0

38.4.2.32 LUT Lock Configuration Register (QuadSPI_LCKCR)

The LUT lock configuration register is used along with QSPI_LUTKEY register to lock or unlock the LUT. This register has to be written immediately after QSPI_LUTKEY register for the lock or unlock operation to be successful. Refer to [Look-up Table](#) for details. Setting both the LOCK and UNLOCK bits as "00" or "11" is not allowed.

Write: Just after writing the LUT Key Register

(QSPI_LUTKEY)

Address: 0h base + 304h offset = 304h

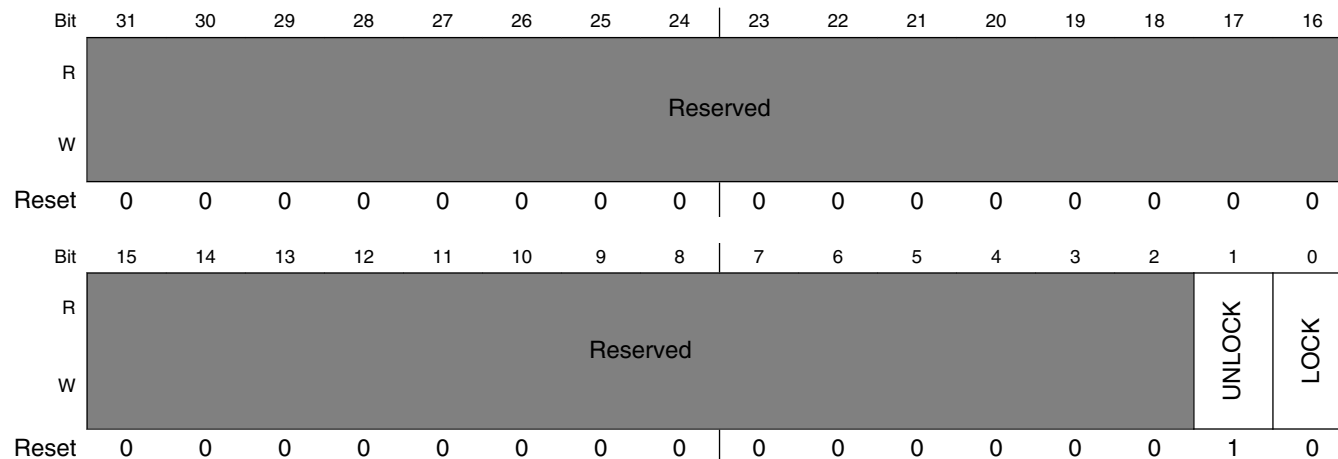

QuadSPI_LCKCR field descriptions

Field	Description
31–2 Reserved	This field is reserved.
1 UNLOCK	Unlocks the LUT when the following two conditions are met: 1. This register is written just after the LUT Key Register (QuadSPI_LUTKEY) 2. The LUT key register was written with 0x5AF05AF0 key
0 LOCK	Locks the LUT when the following condition is met: 1. This register is written just after the LUT Key Register (QuadSPI_LUTKEY) 2. The LUT key register was written with 0x5AF05AF0 key

38.4.2.33 Look-up Table register (QuadSPI_LUTn)

A sequence of instruction-operand pairs may be pre-populated in the LUT according to the device connected on board. Each instruction-operand pair is of 16 bits (2 bytes) each. Every sequence pre-programmed by [Program Sequence Engine](#) in the LUT is referred to by its index. The LUT registers are a look-up-table for sequences of instructions. The programmable sequence engine executes the instructions in these sequences to generate a valid serial flash transaction. There are a total of 64 LUT registers. These 64 registers are divided into groups of 4 registers that make a valid sequence. Therefore, QSPI_LUT[0], QSPI_LUT[4], QSPI_LUT[8] QSPI_LUT[60] are the starting registers of a valid sequence. Each of these sets of 4 registers can have a maximum of 8 instructions. Reset value of the register shown below is only applicable to LUT2 to LUT63. A maximum of 16 sequences can be defined at one time. [Look-up Table](#) describes the LUT registers in detail.

NOTE

The reset values for LUT0 and LUT1 are 0818_0403h and 2400_1C08h, respectively.

Write: Once the LUT is unlocked

Address: 0h base + 310h offset + (4d × i), where i=0d to 63d

Bit	31	30	29	28	27	26	25	24	23	22	21	20	19	18	17	16
R																
W	INSTR1								PAD1		OPRND1					
Reset	0*	0*	0*	0*	0*	0*	0*	0*	0*	0*	0*	0*	0*	0*	0*	0*
Bit	15	14	13	12	11	10	9	8	7	6	5	4	3	2	1	0
R																
W	INSTR0								PAD0		OPRND0					
Reset	0*	0*	0*	0*	0*	0*	0*	0*	0*	0*	0*	0*	0*	0*	0*	0*

* Notes:

- The reset values for LUT0 and LUT1 are 0818_0403h and 2400_1C08h respectively.

QuadSPI_LUTn field descriptions

Field	Description
31–26 INSTR1	Instruction 1
25–24 PAD1	Pad information for INSTR1. 00 1 Pad 01 2 Pads 10 4 Pads 11 8 Pads
23–16 OPRND1	Operand for INSTR1.
15–10 INSTR0	Instruction 0
9–8 PAD0	Pad information for INSTR0. 00 1 Pad 01 2 Pads 10 4 Pads 11 8 Pads
OPRND0	Operand for INSTR0.

38.4.3 Serial Flash Address Assignment

The serial flash address assignment may be modified by writing into [Serial Flash A1 Top Address \(QuadSPI_SFA1AD\)](#) and [Serial Flash A2 Top Address \(QuadSPI_SFA2AD\)](#) for device A and into [Serial Flash B1 Top Address \(QuadSPI_SFB1AD\)](#) and [Serial Flash B2 Top Address \(QuadSPI_SFB2AD\)](#) for device B. The following table shows how different access modes are related to the address specified for the next SFM Command. Note that this address assignment is valid for both IP and AHB commands.

Table 38-8. Serial Flash Address Assignment

Parameter	Function	Access Mode
QSPI_AMBA_BASE (31:10) - 22 bits)	QuadSPI AHB base address	
TOP_ADDR_MEMA1(T PADA1)	Top address for the external flash A1 (the first of the two independent flashes sharing the IOFA)	Any access to the address space between TOP_ADDR_MEMA1 and QSPI_AMBA_BASE will be routed to Serial Flash A1
TOP_ADDR_MEMA2(T PADA2)	Top address for the external flash A2 (the second of the two independent flashes sharing the IOFA).	Any access to the address space between TOP_ADDR_MEMA2 and TOP_ADDR_MEMA1 will be routed to Serial Flash A2
TOP_ADDR_MEMB1(T PADB1)	Top address for the external flash B1 (the first of the two independent flashes sharing the IOFB)	Any access to the address space between TOP_ADDR_MEMB1 and TOP_ADDR_MEMA2 will be routed to Serial Flash B1

Table continues on the next page...

Table 38-8. Serial Flash Address Assignment (continued)

Parameter	Function	Access Mode
TOP_ADDR_MEMB2(TPADB2)	Top address for the external flash B2 (the second of the two independent flashes sharing the IOFB)	Any access to the address space between TOP_ADDR_MEMB2 and TOP_ADDR_MEMB1 will be routed to Serial Flash A2

38.5 Flash memory mapped AMBA bus

QSPI_AMBA_BASE defines the address to be used as start address of the serial flash device as defined by the system memory map. Note that this may be a remapping of the physical address of the serial flash in the system. Refer to the system address map. Note that this may be a remapping of the physical address of the serial flash in the system. Refer to the system address map.

Table 38-9. QuadSPI AMBA Bus Memory Map

Address	Register Name
Memory Mapped Serial Flash Data - Individual Flash Mode on Flash A	
QSPI_AMBA_BASE to (TOP_ADDR_MEMA2 - 0x01)	Memory Mapped Serial Flash Data - Individual Flash Mode on Flash A Refer to Memory Mapped Serial Flash Data - Individual Flash Mode on Flash A for details and to Table 38-16 and Table 38-17 for information about the byte ordering.
Memory Mapped Serial Flash Data - Individual Flash Mode on Flash B	
TOP_ADDR_MEMA2 to (TOP_ADDR_MEMB2 - 0x01)	Memory Mapped Serial Flash Data - Individual Flash Mode on Flash B Refer to Memory Mapped Serial Flash Data - Individual Flash Mode on Flash B for details and to Table 38-16 and Table 38-17 for information about the byte ordering.
AHB RX Data Buffer (QSPI_ARDB0 to QSPI_ARDB31)	
QSPI_ARDB_BASE to... (32 * 4 Byte) QSPI_ARDB_BASE + 0x0000_01FF	AHB RX Data Buffer (QSPI_ARDB0 to QSPI_ARDB31) Refer to Table 38-16 for information about the byte ordering.

Note

Any read access to non-implemented addresses will provide undefined results.

In case of single-die flash devices, TOP_ADDR_MEMA2 and TOP_ADDR_MEMB2 should be initialized/programmed to TOP_ADDR_MEMA1 and TOP_ADDR_MEMB1 respectively (in effect, setting the size of these devices to 0). This would ensure that the complete memory map is assigned to only one flash device.

In 'Individual Flash Modes', the 3/4 address bytes (as programmed in the instruction/operand in the sequence) available for the flash address is determined by SFADR [23:0] or SFADR [31:0] as given in the table above.

38.5.1 AHB Bus Access Considerations

It has to be noted that all logic in the QuadSPI module implementing the AHB Bus access is designed to read the content of an external serial flash device. Therefore, the following restrictions apply to the QuadSPI module with respect to accesses to the AHB bus.

- At present, the QuadSPI does not support AHB writes so any write access is answered with the ERROR condition according to the AMBA AHB Specification. No write occurs.
- Any AHB Command resulting in the assertion of the QSPI_FR[ABSEF] flag is answered with the ERROR condition according to the AMBA_AHB specification. The resulting AHB Command is ignored.
- AHB Bus access types fully supported are NONSEQ and BUSY.
- AHB access type SEQ is treated in the same way like NONSEQ. Refer to the AMBA AHB Specification for further details.

38.5.2 Memory Mapped Serial Flash Data - Individual Flash Mode on Flash A

Starting with address QSPI_AMBA_BASE the content of the first external serial flash devices is mapped into the address space of the device containing the QuadSPI module. Serial flash address byte address 0x0 corresponds to bus address QSPI_AMBA_BASE with increasing order. Refer to the following table for the address mapping. The byte ordering for 32 bit access is given in [Table 38-16](#) and for 64 bit read access the byte ordering is given in [Table 38-17](#).

Table 38-10. Memory Mapped Individual Flash Mode - Flash A Address Scheme

Memory Mapped Address 32 Bit Access	Memory Mapped Address 64 Bit Access	Serial Flash Byte Address	Flash Device
QSPI_AMBA_BASE + 0x00	QSPI_AMBA_BASE + 0x00	0x00_0000 to 0x00_0003	A1
QSPI_AMBA_BASE + 0x04		0x00_0004 to 0x00_0007	
...	

Table continues on the next page...

Table 38-10. Memory Mapped Individual Flash Mode - Flash A Address Scheme (continued)

Memory Mapped Address 32 Bit Access	Memory Mapped Address 64 Bit Access	Serial Flash Byte Address	Flash Device
TOP_ADDR_MEMA1 - 0x08	TOP_ADDR_MEMA1 - 0x08	(TOP_ADDR_MEMA1 - 0x08) to (TOP_ADDR_MEMA1 - 0x04 - 0x01)	
TOP_ADDR_MEMA1 - 0x04		(TOP_ADDR_MEMA1 - 0x04) to (TOP_ADDR_MEMA1 - 0x01)	
TOP_ADDR_MEMA1 + 0x00	TOP_ADDR_MEMA1 + 0x00_0000	0x00_0000 to 0x00_0003	A2
TOP_ADDR_MEMA1 + 0x04		0x00_0004 to 0x00_0007	
.....	
TOP_ADDR_MEMA2 - 0x08	TOP_ADDR_MEMA2 - 0x08	(TOP_ADDR_MEMA2 - 0x08) to (TOP_ADDR_MEMA2 - 0x04 - 0x01)	
TOP_ADDR_MEMA2 - 0x04		(TOP_ADDR_MEMA2 - 0x04) to (TOP_ADDR_MEMA2 - 0x01)	

The available address range depends from the size of the external serial flash device. Any access beyond the size of the external serial flash provides undefined results.

For details concerning the read process refer to [Flash Read](#).

38.5.3 Memory Mapped Serial Flash Data - Individual Flash Mode on Flash B

Starting with address TOP_ADDR_MEMA2 the content of the first external serial flash devices is mapped into the address space of the device containing the QuadSPI module. Serial flash address byte address 0x0 corresponds to bus address TOP_ADDR_MEMA2 with increasing order. Refer the following table for the address mapping. The byte ordering for 32 bit access is given in [Table 38-16](#) and for 64 bit read access the byte ordering is given in [Table 38-17](#).

Table 38-11. Memory Mapped Individual Flash Mode - Flash B Address Scheme

Memory Mapped Address 32 Bit Access	Memory Mapped Address 64 Bit Access	Serial Flash Byte Address	Flash Device
TOP_ADDR_MEMA2 + 0x00	TOP_ADDR_MEMA2 + 0x00	0x00_0000 to 0x00_0003	B1
TOP_ADDR_MEMA2 + 0x04		0x00_0004 to 0x00_0007	
...	
TOP_ADDR_MEMB1 - 0x08	TOP_ADDR_MEMB1 - 0x08	(TOP_ADDR_MEMB1 - TOP_ADDR_MEMA2 - 0x08) to (TOP_ADDR_MEMB1 - TOP_ADDR_MEMA2 - 0x04 - 0x01)	

Table continues on the next page...

Table 38-11. Memory Mapped Individual Flash Mode - Flash B Address Scheme (continued)

Memory Mapped Address 32 Bit Access	Memory Mapped Address 64 Bit Access	Serial Flash Byte Address	Flash Device
TOP_ADDR_MEMB1 - 0x04		(TOP_ADDR_MEMB1 - TOP_ADDR_MEMA2 - 0x04) to (TOP_ADDR_MEMB1 - TOP_ADDR_MEMA2 - 0x01)	
TOP_ADDR_MEMB1 + 0x00	TOP_ADDR_MEMB1 + 0x00_0000	0x00_0000 to 0x00_0003	B2
TOP_ADDR_MEMB1 + 0x04		0x00_0004 to 0x00_0007	
.....	
TOP_ADDR_MEMB2 - 0x08	TOP_ADDR_MEMA2 - 0x08	(TOP_ADDR_MEMB2 - TOP_ADDR_MEMB1 - 0x08) to (TOP_ADDR_MEMB2 - TOP_ADDR_MEMB1 - 0x04 - 0x01)	
TOP_ADDR_MEMB2 - 0x04		(TOP_ADDR_MEMB2 - TOP_ADDR_MEMB1 - 0x04) to (TOP_ADDR_MEMB2 - TOP_ADDR_MEMB1 - 0x01)	

The available address range depends from the size of the external serial flash device. Any access beyond the size of the external serial flash provides undefined results.

For details concerning the read process refer to [Flash Read](#).

38.5.4 AHB RX Data Buffer (QSPI_ARDB0 to QSPI_ARDB31)

NOTE

See the System Memory map in this document for the base address of the QSPI AHB RX Data Buffer.

memory map

Address offset (hex)	Register name	Width (in bits)	Access	Reset value	Section/page
0	AHB RX Data Buffer register (ARDB0)	32	R/W	0000_0000h	38.5.4.1/1092
4	AHB RX Data Buffer register (ARDB1)	32	R/W	0000_0000h	38.5.4.1/1092
8	AHB RX Data Buffer register (ARDB2)	32	R/W	0000_0000h	38.5.4.1/1092
C	AHB RX Data Buffer register (ARDB3)	32	R/W	0000_0000h	38.5.4.1/1092

Table continues on the next page...

memory map (continued)

Address offset (hex)	Register name	Width (in bits)	Access	Reset value	Section/page
10	AHB RX Data Buffer register (ARDB4)	32	R/W	0000_0000h	38.5.4.1/1092
14	AHB RX Data Buffer register (ARDB5)	32	R/W	0000_0000h	38.5.4.1/1092
18	AHB RX Data Buffer register (ARDB6)	32	R/W	0000_0000h	38.5.4.1/1092
1C	AHB RX Data Buffer register (ARDB7)	32	R/W	0000_0000h	38.5.4.1/1092
20	AHB RX Data Buffer register (ARDB8)	32	R/W	0000_0000h	38.5.4.1/1092
24	AHB RX Data Buffer register (ARDB9)	32	R/W	0000_0000h	38.5.4.1/1092
28	AHB RX Data Buffer register (ARDB10)	32	R/W	0000_0000h	38.5.4.1/1092
2C	AHB RX Data Buffer register (ARDB11)	32	R/W	0000_0000h	38.5.4.1/1092
30	AHB RX Data Buffer register (ARDB12)	32	R/W	0000_0000h	38.5.4.1/1092
34	AHB RX Data Buffer register (ARDB13)	32	R/W	0000_0000h	38.5.4.1/1092
38	AHB RX Data Buffer register (ARDB14)	32	R/W	0000_0000h	38.5.4.1/1092
3C	AHB RX Data Buffer register (ARDB15)	32	R/W	0000_0000h	38.5.4.1/1092
40	AHB RX Data Buffer register (ARDB16)	32	R/W	0000_0000h	38.5.4.1/1092
44	AHB RX Data Buffer register (ARDB17)	32	R/W	0000_0000h	38.5.4.1/1092
48	AHB RX Data Buffer register (ARDB18)	32	R/W	0000_0000h	38.5.4.1/1092
4C	AHB RX Data Buffer register (ARDB19)	32	R/W	0000_0000h	38.5.4.1/1092
50	AHB RX Data Buffer register (ARDB20)	32	R/W	0000_0000h	38.5.4.1/1092
54	AHB RX Data Buffer register (ARDB21)	32	R/W	0000_0000h	38.5.4.1/1092
58	AHB RX Data Buffer register (ARDB22)	32	R/W	0000_0000h	38.5.4.1/1092
5C	AHB RX Data Buffer register (ARDB23)	32	R/W	0000_0000h	38.5.4.1/1092
60	AHB RX Data Buffer register (ARDB24)	32	R/W	0000_0000h	38.5.4.1/1092
64	AHB RX Data Buffer register (ARDB25)	32	R/W	0000_0000h	38.5.4.1/1092

Table continues on the next page...

memory map (continued)

Address offset (hex)	Register name	Width (in bits)	Access	Reset value	Section/page
68	AHB RX Data Buffer register (ARDB26)	32	R/W	0000_0000h	38.5.4.1/1092
6C	AHB RX Data Buffer register (ARDB27)	32	R/W	0000_0000h	38.5.4.1/1092
70	AHB RX Data Buffer register (ARDB28)	32	R/W	0000_0000h	38.5.4.1/1092
74	AHB RX Data Buffer register (ARDB29)	32	R/W	0000_0000h	38.5.4.1/1092
78	AHB RX Data Buffer register (ARDB30)	32	R/W	0000_0000h	38.5.4.1/1092
7C	AHB RX Data Buffer register (ARDB31)	32	R/W	0000_0000h	38.5.4.1/1092

38.5.4.1 AHB RX Data Buffer register (ARDBn)

The AHB RX Data Buffer register 0 to 31 can be used to read the buffer content of the RX Buffer from successive addresses. QSPI_ARDB0 corresponds to the RX Buffer register entry corresponding to the current value of the read pointer with increasing order.

The increment of the read pointer depends from the access scheme (DMA or flag-driven). Refer to "Data Transfer from the QuadSPI Module Internal Buffers" section in [Flash Read](#) section, RX Buffer, data read via register interface and AHB read, for the description of successive accesses to the RX Buffer content. Refer also to [Byte Ordering of Serial Flash Read Data](#) for the byte ordering scheme.

Valid address range accessible in the QSPI_ARDBn range depends from the number of RX Buffer entries implemented and from the number of valid buffer entries available in the RX Buffer.

- Example 1, RX Buffer filled completely with 32 words: In this case the address range for valid read access extends from QSPI_ARDB0 to QSPI_ARDB31.
- Example 2, RX Buffer filled with 5 valid words, RX Buffer fill level QSPI_RBSR[RDBFL] is 5. In this case an access to QSPI_ARDB4 provides the last valid entry.

Address: 0h base + 0h offset + (4d × i), where i=0d to 31d

Bit	31	30	29	28	27	26	25	24	23	22	21	20	19	18	17	16	15	14	13	12	11	10	9	8	7	6	5	4	3	2	1	0	
R																																	
W																																	
Reset	0	0	0	0	0	0	0	0	0	0	0	0	0	0	0	0	0	0	0	0	0	0	0	0	0	0	0	0	0	0	0	0	0

ARDB_n field descriptions

Field	Description
ARXD	ARDB provided RX Buffer Data. Byte order (endianness) is identical to the RX Buffer Data Registers.

38.6 Interrupt Signals

The interrupt request lines of the QuadSPI module are mapped to the internal flags according to the following table.

Table 38-12. Assignment of Interrupt Request Lines

IRQ/DMA line	QSPI_FR Flag	Interrupt Description
ipi_int_tfff	TBFF	TX Buffer Fill
ipi_int_tcf	TFF	Peripheral Command Transaction Finished
ipi_int_rfdf	RBDF	RX Buffer Drain
ipi_int_overrun		Buffer Overflow/Underrun Error Logical OR from:
	RBOF	RX Buffer Overrun
	TBUF	TX Buffer Underrun
	ABOF	AHB Buffer Overflow
ipi_int_cerr		Serial Flash Command Error Logical OR from:
	IPAEF	Peripheral access while AHB busy Error
	IPIEF	Peripheral Command could not be triggered Error
	IUEF	Peripheral Command Usage Error
ipi_int_ored	TBFF, TFF, ILLINE, RBDF, RBOF, TBUF, ABSEF, ABOF, IPAEF, IPIEF, IUEF, AITEF, AIBSEF	Logical OR from all the QSPI_FR flags mentioned

38.7 Functional Description

This section provides the functional information of the QuadSPI module.

38.7.1 Serial Flash Access Schemes

The following access schemes are possible, depending on the serial flash devices attached to the QuadSPI module.

Table 38-13. Access Schemes for Serial Flash Data Access

Access Scheme	One Flash Device on Port A	One Flash Device on Port B	Two identical Flash Devices connected on Port A and Port B
Individual Flash Mode: Access to Flash A	Yes	N/a	Yes
Individual Flash Mode: Access to Flash B	N/a	Yes	Yes

Note

If two different flash devices are attached, they can be operated only in Individual Flash Mode.

In the Individual Flash Mode, all supported commands are available.

Unless explicitly noted, all the following descriptions relate to the Individual Flash Mode.

38.7.2 Normal Mode

This mode is used to allow communication with an external serial flash device. Compared to the standard SPI protocol, this communication method uses up to 4 bidirectional data lines operating at high data rates. The communication to the external serial flash device consists of an instruction code and optional address, mode, dummy and data transfers. The flexible programmable core engine described below is immune to a wide variety of command/protocol differences in the serial flash devices provided by various flash vendors.

38.7.2.1 Programmable Sequence Engine

The core of the QuadSPI module is a programmable sequence engine that works on "instruction-operand" pairs. The core controller executes each programmed instruction sequentially. The complete list of instructions and the corresponding operands is given in the following table.

Table 38-14. Instruction set

Instruction	Instruction encoding	Pins	Operand	Action on Serial Flash(es)
CMD	6'd1	N=2'd{0,1,2,3} 2'd0 - One pad	8 bit command value	Provide the serial flash with operand on the number of pads specified
ADDR	6'd2	2'd1 - Two pads 2'd2 - Four pads 2'd3- Eight pads	Number of address bits to be sent (for example, 8'd24 => 24 address bits required)	Provide the serial flash with address cycles according to the operand on the number of pads specified. The actual address to be provided will be derived from the incoming address in case of AHB initiated transactions and the value of SFAR in case of IPS initiated transactions , if QSPI_SFACR[CAS] is set to 0, else the actual address will take CAS into consideration.
DUMMY	6'd3		Number of dummy clock cycles (should be <= 64 cycles)	Provide the serial flash with dummy cycles as per the operand. The PAD information defines the number of pads in input mode. (for example, one pad implies that pad 1 is not driven, rest all are driven)
MODE	6'd4		8 bit mode value	Provide the serial flash with 8 bit operand on the number of pads specified
MODE2	6'd5	N=2'd{0,1}	2 bit mode value	Provide the serial flash with 2 bit operand on the number of pads ¹ specified
MODE4	6'd6	N=2'd{0,1,2}	4 bit mode value	Provide the serial flash with 4 bit operand on the number of pads ² specified
READ	6'd7	N=2'd{0,1,2,3} 2'd0 - One pad 2'd1 - Two pads 2'd2 - Four pads 2'd3- Eight pads	Read data size in bytes (for AHB transactions, the user's application should ensure that data size is a multiple of 8 bytes)	Read data from flash on the number of pads specified. The data size may be overwritten by writing to the ADATSZ field of the QSPI_BUFxCR registers for AHB initiated transactions and IDATSZ field of IP Configuration Register (QuadSPI_IPCR) for IP initiated transactions.
WRITE	6'd8		Write data size in bytes	Write data on number of pads specified. The data size may be overwritten by writing to the IDATSZ field of IP Configuration Register (QuadSPI_IPCR) register
JMP_ON_CS	6'd9	NA	Instruction number	Every time the chip select (CS) is deasserted, jump to the instruction pointed to by the operand. This instruction allows the programmer to specify the behavior of the controller when a new read transaction is initiated following a CS deassertion.
ADDR_DDR	6'd10	N=2'd{0,1,2,3} 2'd0 - One pad 2'd1 - Two pads 2'd2 - Four pads	Number of address bits to be sent (for example, 8'd24 => 24 address bits required)	Provide the serial flash with address cycles according to the operand on the number of pads specified at each clock edge of serial flash clock. The actual address to be provided will be derived from the incoming address in case of AHB initiated transactions and the value of QSPI_SFAR in case of IPS initiated transactions , if QSPI_SFACR[CAS] is set to 0, else the actual address will take CAS into consideration.
MODE_DDR	6'd11	2'd3- Eight pads	8 bit mode value	Provide the serial flash with 8 bit operand on the number of pads specified at each clock edge of serial flash.

Table continues on the next page...

Table 38-14. Instruction set (continued)

Instruction	Instruction encoding	Pins	Operand	Action on Serial Flash(es)
MODE2_DDR	6'd12	N=2'd{0}	2 bit mode value	Provide the serial flash with 2 bit operand on the number of pads specified at each clock edge of serial flash ³
MODE4_DDR	6'd13	N=2'd{0,1}	4 bit mode value	Provide the serial flash with 4 bit operand on the number of pads specified at each clock edge of serial flash ⁴ .
READ_DDR	6'd14	N=2'd{0,1,2,3} 2'd0 - One pad 2'd1 - Two pads 2'd2 - Four pads 2'd3- Eight pads	Read data size in bytes (for AHB transactions, the user's application should ensure that data size is in multiple of 8 bytes)	Read data from flash on the number of pads specified at each clock edge of serial flash. The data size may be overwritten by writing to the ADATSZ field of the QSPI_BUFxCR registers for AHB initiated transactions and IDATSZ field of IP Configuration Register (QuadSPI_IPCR) for IP initiated transactions
WRITE_DDR	6'd15		Write data size in bytes	Write data on the number of pads specified at each clock edge of serial flash. The data size may be overwritten by writing to the IDATSZ field of IP Configuration Register (QuadSPI_IPCR) register
CMD_DDR	6'd17	N=2'd{0,1,2,3} 2'd0 - One pad	8 bit command value	Provide the serial flash with the operand with number of pads specified at each clock edge of the serial flash
CADDR	6'd18	2'd1 - Two pads 2'd2 - Four pads 2'd3- Eight pads	Number of Column address bits to be sent(8'd8 means 8 bits of column address is to be sent)	Provide the serial flash with column address cycles according to the operand on the number of pads specified. The actual address to be provided to flash will depend on value of QSPI_SFACR[CAS]. For example, if QSPI_SFACR[CAS] is 3, then the address to flash will be [2:0] of incoming address in case of AHB and the value of QSPI_SFAR in case of IP. This will be appended with zero if QSPI_SFACR[CAS] is less than number of pads for a Flash.
CADDR_DDR	6'd19		Number of Column address bits to be sent(8'd8 means 8 bits of column address is to be sent)	Provide the serial flash with column address cycles according to the operand on the number of pads specified at each clock edge of the serial flash. The actual address to be provided to flash will depend on value of QSPI_SFACR[CAS]. For example, if CAS is 3, then the address to flash will be [2:0] of incoming address in case of AHB and the value of QSPI_SFAR in case of IP. This will be appended with zero if CAS is less than number of pads for a Flash.
STOP	8'd0	NA	NA	Stop execution; deassert CS

1. For a one pad instruction, MODE2 will take 2 serial flash clock cycles on the flash interface.
2. For a one pad instruction, MODE4 will take 4 serial flash clock cycles on the flash interface. For a 4 pad instruction, MODE4 will take 1 serial flash clock cycle on the flash interface.
3. For a one pad instruction, MODE2_DDR will take 1 serial flash clock cycle on the flash interface.
4. For a one pad instruction, MODE4_DDR will take 2 serial flash clock cycles on the flash interface. For a 4 pad instruction MODE4_DDR will take half a cycle on the serial flash interface.

The programmable sequence engine allows the user to configure the QuadSPI module according to the serial flash connected on board. The flexible structure is easily adaptable to new command/protocol changes from different vendors.

38.7.2.2 Flexible AHB buffers

In order to reduce the latency of the reads for AHB masters, the data read from the serial flash is buffered in flexible AHB buffers. There are four such flexible buffers. The size of each of these buffers is configurable with the minimum size being 0 Bytes and maximum size being the size of the complete buffer instantiated. The size of buffer 0 is defined as being from 0 to QSPI_BUF0IND. The Size of buffer 1 is from QSPI_BUF0IND to QSPI_BUF1IND, buffer2 is from QSPI_BUF1IND to QSPI_BUF2IND and buffer 3 is from QSPI_BUF2IND to the size of the complete buffer, which is given in the chip-specific QuadSPI information.

Each flexible AHB buffer is associated with the following

1. An AHB master. Optionally, buffer3 may be configured as an "all master" buffer by setting the QSPI_BUF3CR[ALLMST] bit. When buffer3 is configured in such a way, any access from a master not associated with any other buffer is routed to buffer3.
2. A datasize field representing the amount of data to be fetched from the flash on every "missed" access.

The master port number of every incoming request is checked and the data is returned/fetched into the corresponding associated buffer. Every "missed" access to the buffer causes the controller to clear the buffer and fetch QSPI_BUFxCR[ADATSZ] amount of data from the serial flash. As such, there is no benefit in configuring a buffer size of greater than ADATSZ, as the locations greater than ADATSZ will never be used. For any AHB access, the sequence pointed to by the QSPI_BFGENCR[SEQID] field is used for the flash transaction initiated. The data is returned to the master as soon as the requested amount is read from the serial flash. The controller however, continues to prefetch the rest of the data in anticipation of a next consecutive request. [Figure 38-4](#) shows the flexible AHB buffers.

The QSPI_BFGENCR[SEQID] field points to an index of the LUT. Refer to [Look-up Table](#) for details.

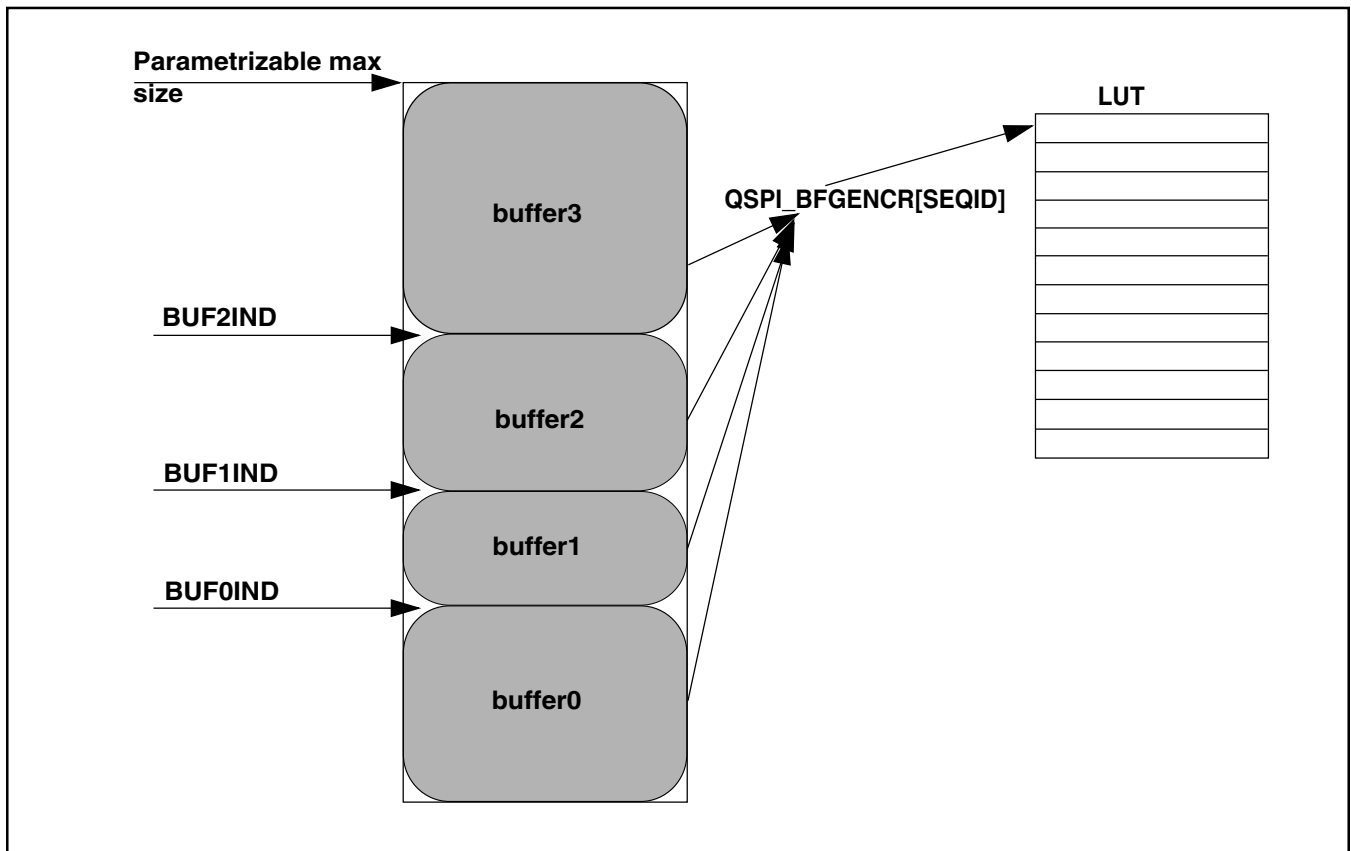

Figure 38-4. Flexible AHB Buffers

Buffer0 may optionally be configured to be associated with a high priority master by setting the QSPU_BUF0CR[HP_EN] bit. An access by a high priority master suspends any ongoing prefetch to any of the other buffers. The ongoing prefetch is suspended and the high priority master is serviced first. Once the high priority masters access completes, the suspended transaction is resumed (before any other AHB access is entertained). The status of the suspended buffer can be read from [Sequence Suspend Status Register \(QuadSPI_SPNDST\)](#).

38.7.2.3 Suspend-Abort Mechanism

Any low priority AHB access can be suspended by a high priority AHB master request. The ongoing transaction is suspended at 64 bit boundary. The suspended transaction is restarted after the high priority master is served and the high priority transaction including data prefetch is completed. While a transaction is in suspended state, it may be aborted if a transaction by the same suspended master is made to a location which is different from the location of the suspended transaction.

Any ongoing transaction is aborted if a request from the same master arrives for a location other than the location at which the transaction is going on. The abort can happen at any point of time.

38.7.2.4 HBURST Support

QuadSPI controller supports HBURST and HSIZE on the AHB interface. HBURST indicates if the transfer forms part of a burst. Four, eight and sixteen beat bursts are supported and the burst may be either incrementing or wrapping. HSIZE indicates the size of the transfer. 8, 16, 32 and 64 bit data size are supported. In case of WRAP accesses, QuadSPI generates aligned accesses to Serial Flash if there is no buffer hit for any incoming non-sequential AHB access. In case there is a buffer hit, the incoming address in the haddr line is latched as it is. If the total burst size is more than the data prefetch size an error response is generated and QSPI_FR[AIBSEF] is set. The data prefetch size can be defined by QSPI_BUFxCR[ADATSZ] or data size mentioned in the sequence pointed to by the SEQID field when ADATSZ is programmed as zero. A few examples are shown in the figure below:

HADDR = 0x38 HBURST = WRAP4 HSIZE = 64 bits Flash xsaction start = 0x20 Incoming AHB access= 0x38, 0x20, 0x28, 0x30	HADDR = 0x38 HBURST = INCR4 HSIZE = 64 bits Flash xsaction start = 0x38 Incoming AHB access= 0x38, 0x40, 0x48, 0x50
HADDR = 0x50 HBURST = WRAP8 HSIZE = 64 bits Flash xsaction start = 0x40 Incoming AHB access= 0x50, 0x58, 0x60, 0x68, 0x70, 0x78, 0x40, 0x48	
HADDR = 0xD0 HBURST = WRAP16 HSIZE = 64 bits Flash xsaction start = 0x80 Incoming AHB access= 0xD0, 0xD8, 0xE0, ...0xF8, 0x80, 0x88, ... 0xC8	
HADDR = 0xD4 HBURST = WRAP8 HSIZE = 32bits Flash xsaction start = 0xC0 Incoming AHB access= 0xD4, 0xD8, 0xDC, 0xC0, 0xC4, 0xC8,0xCC, 0xD0	
HADDR = 0x54 HBURST = INCR8 HSIZE = 32bits Flash xsaction start = 0x54 Incoming AHB access= 0x54, 0x58, 0x5C, 0x60, 0x64, 0x68,0x6C, 0x70	

Figure 38-5. QuadSPI HBURST support

NOTE

The software must take care that the prefetch size should never be set less than the minimum data needed by any external interface to start processing.

NOTE

Whenever a core access QuadSPI memory with cache enabled, prefetch size must be configured equal or more than the cache line size, otherwise QSPI_FR[AIBSEF] error gets set.

38.7.2.5 Look-up Table

The Look-up-table or LUT consists of a number of pre-programmed sequences. Each sequence is basically a sequence of instruction-operand pairs which when executed sequentially generates a valid serial flash transaction. Each sequence can have a maximum of 8 instruction-operand pairs. The LUT can hold a maximum of 16 sequences. The figure below shows the basic structure of the sequence in the LUT.

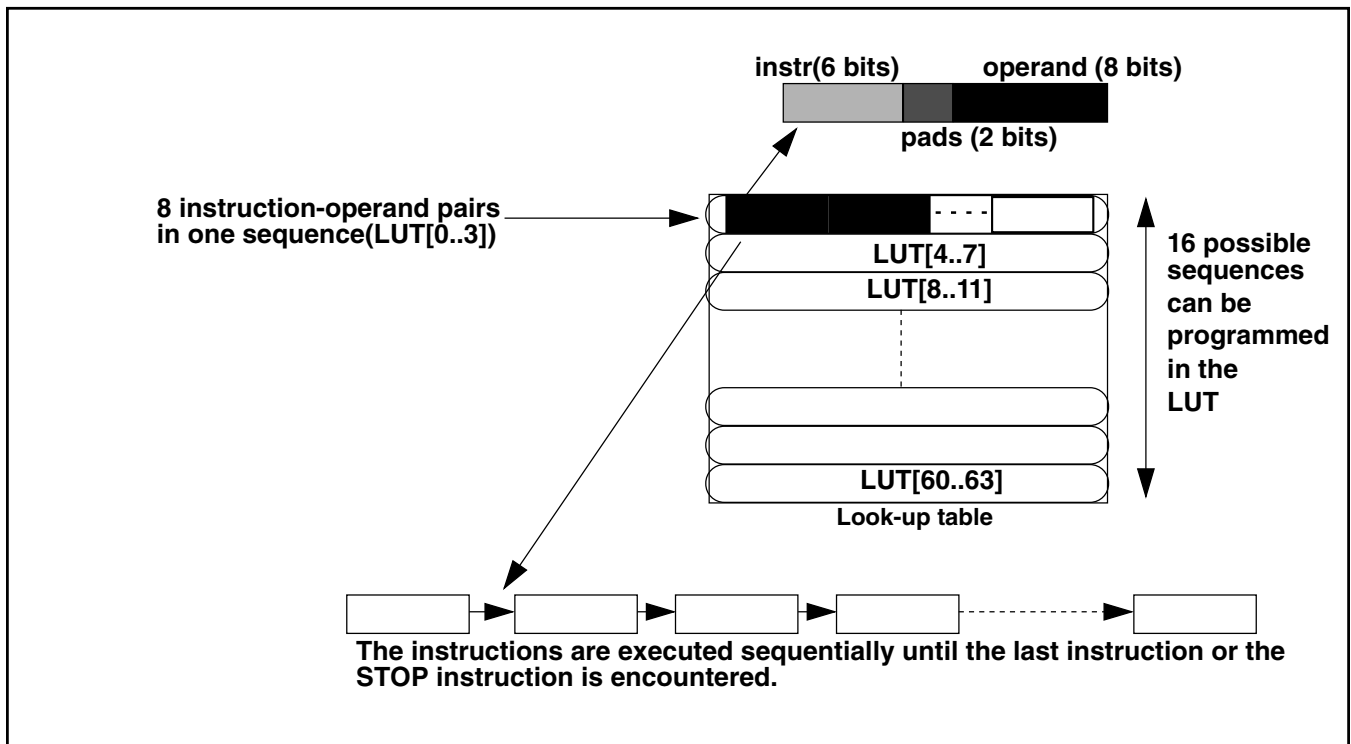

Figure 38-6. LUT and sequence structure

At reset, the index 0 of the look-up-table (LUT[0..3]) is programmed with a basic read sequence as given in [Table 38-15](#). After reset the complete LUT may be reprogrammed according to the device connected on board. In order to protect its contents during a code

runover the LUT may be locked, after which a write to the LUT will not be successful until it has been unlocked again. The key for locking or unlocking the LUT is **0x5AF05AF0**. The process for locking and un-locking the LUT is as follows:

Locking the LUT

1. Write the key (**0x5AF05AF0**) in to the [LUT Key Register \(QuadSPI_LUTKEY\)](#).
2. Write 0b01 to the [LUT Lock Configuration Register \(QuadSPI_LCKCR\)](#). Note that this IPS transaction should immediately follow the above IPS transaction (no other IPS transaction can be issued in between). A successful write into this register locks the LUT.

Unlocking the LUT

1. Write the key (**0x5AF05AF0**) into the [LUT Key Register \(QuadSPI_LUTKEY\)](#)
2. Write 0b10 to the [LUT Lock Configuration Register \(QuadSPI_LCKCR\)](#). Note that this IPS transaction should immediately follow the above IPS transaction (no other IPS transaction can be issued in between). A successful write into this register unlocks the LUT.

The lock status of the LUT can be read from `QSPI_LCKCR[UNLOCK]` and `QSPI_LCKCR[LOCK]` bit.

Some example sequences are defined in [Example Sequences](#). The reset sequence at LUT index 0 is given in the following table.

Table 38-15. Reset sequence

Instruction	Pad	Operand	Comment
CMD	0x00	0x03	Read Data byte command on one pad
ADDR	0x00	0x18	24 Addr bits to be sent on one pad
READ	0x00	0x08	Read 64 bits
JMP_ON_CS	0x00	0x00	Jump to instruction 0 (CMD)

38.7.2.6 Issuing Serial Flash Memory (SFM) Commands

Each access to the external device follows the same sequence:

1. The user must pre-populate the LUT with the serial flash command sequences that are required for the flash device being used.

2. The QuadSPI module starts executing the instructions in the sequence one by one. The transaction starts and the status bit `QSPI_SR[BUSY]` is set.
3. Communication with the external serial flash device is started and the transaction is executed.
4. When the transaction is finished (all transmit- and receive operations with the external serial flash device are finished) the status bit `QSPI_SR[BUSY]` is reset. In case of an IP Command the `QSPI_FR[TFF]` flag is asserted.

Further details are given in below in [Flash Programming](#) and [Flash Read](#).

You can trigger the processing of SFM commands in the QuadSPI module in one of the following ways:

- **Using IP commands**

For IP Commands the required components need to be written into the following registers:

- Write the serial flash address to be used by the instruction into `QSPI_SFAR`, refer to [Serial Flash Address Register \(QSPI_SFAR\)](#). For IP Commands not related to specific addresses, the base address of the related flash need to be programmed. For example, for an instruction which does not require an address (i.e. write enable instruction) the SFAR should be programmed with the base address of the memory the command is to be sent to.
- Write the sequence ID and data size details in the [IP Configuration Register \(QSPI_IPCR\)](#).
- Note that the write into the `QSPI_IPCR[SEQID]` field must be the last step of the sequence. It is possible to combine all fields of the `QSPI_IPCR` into one single write. Refer to [IP Configuration Register \(QSPI_IPCR\)](#) for details.

- **Using AHB commands**

Any AHB memory mapped access is routed to one of the buffers depending on the master port number of the request. If the access is a "miss", a new serial flash transaction is started. The transaction is based on the sequence pointed to by the `BFGENCR[SEQID]` field as described in [Flexible AHB buffers](#).

An AHB access is termed memory mapped when the access is to the memory mapped serial flashes, as described in [Memory Mapped Serial Flash Data - Individual Flash Mode on Flash A](#) and [Memory Mapped Serial Flash Data - Individual Flash Mode on Flash B](#).

38.7.2.7 Flash Programming

In all cases the memory sector to be written needs to be erased first. The programming sequence itself is then initiated in the following way:

1. Check QuadSPI_SR[BUSY] is de-asserted or '0'. Check that the TX buffer is empty. If it is required to discard the data present in the TX buffer (QSPI_SR[TXEDA]) bit is set, then the TX buffer must be cleared by writing '1' into the QSPI_MCR[CLR_TXF] bit.
2. Program the address related to the command in the QSPI_SFAR register. Program the QSPI_SFACR[CAS] if required to desired value else to 0. Program the QSPI_SFACR[WA] to 1 if the serial flash is a word addressable flash else to 0 in case serial flash is byte addressable.
3. Provide initial data for the program command into the circular buffer via register TX Buffer Data Register (QSPI_TBDR) . At least four word of data must be written into the TX Buffer up to a maximum of 32.
4. Program the QSPI_IPCR register to trigger the command. The QSPI_IPCR[SEQID] should point to an index of the LUT which has the flash program sequence pre-programmed. The IDATSZ field should be set to denote the size of the write.
5. Depending on the amount of data required, step 3 must be repeated until all the required data have been written into the QSPI_TBDR register. The QSPI_SR[TXFULL] can be used to check if the buffer is ready to receive more data. At any time, the QSPI_TBSR[TRCTR] field can be read to check how many words have been written actually into the TX Buffer.

Upon writing the QSPI_IPCR[SEQID] field (refer to step 4) the QuadSPI module will start to execute the programmed sequence. It is the responsibility of the software to ensure that a correct sequence is programmed into the LUT in accordance with the flash memory connected to the module. The data is fetched from the TX Buffer. It consists of **32** entries of 32-bits and is organized as a circular FIFO, whose read pointer is incremented by four after each fetch. When all data are transmitted, the QuadSPI module will return from 'busy' to 'idle'. However, this is not true for the external device since the internal programming is still ongoing. It is up to the user to monitor the relevant status information available from the serial flash device and to ensure that the programming is finished properly.

38.7.2.8 Flash Read

Host access to the data stored in the external serial flash device is done in two steps. First, the data must be read into the internal buffers and in the second step these internal buffers can be read by the host.

1. Reading Serial Flash Data into the QuadSPI Module Internal Buffers

A read access to the external serial flash device can be triggered in two different ways:

- **IP Command Read:** For **reading flash data into the RX Buffer** the user must provide the correct sequence ID in the QuadSPI_IPCR[SEQID] register. The sequence ID points to a sequence in the LUT. It is the responsibility of the software to ensure that a correct read sequence is programmed in the LUT in accordance with the serial flash device connected on board. The user should program the Serial Flash Address Register (QSPI_SFAR), QSPI_SFACR[CAS] and the IP Configuration Register (QSPI_IPCR) registers. All available read commands supported by the external serial flash are possible.

Optionally it is possible to clear the RX Buffer pointer prior to triggering the IP Command by writing a 1 into the QuadSPI_MCR[CLR_RXF] field.

From these inputs, the complete transaction is built when the QSPI_IPCR[SEQID] field is written. The transaction related to the read access starts and the requested number of bytes is fetched from the external serial flash device into the RX Buffer. Since the read access is triggered by an IP command, the IP_ACC status bit and the BUSY bit are both set (both are located in the Status Register (QSPI_SR)). A count of the number of entries currently in the Rx Buffer can be obtained from QSPI_RBSR[RDBFL].

The communication with the external serial flash is stopped when the specified number of bytes has been read (successful completion of the transaction).

- **AHB Command Read:** For **reading flash data into the AHB Buffer** the user must set up a read access by a master to the address range in the system memory map which the external serial flash devices are mapped to. The user should program the QSPI_SFACR[CAS], if required, to desired value else to 0. The user should also program the buffer registers corresponding to the AHB master initiating the request, this depends on the configuration of the QSPI_RBCT[RXBRD]. The user should provide the correct sequence ID into the buffer generic configuration register (QSPI_BFGENCR). It is the responsibility of the software to ensure that a correct read sequence is programmed in the LUT in accordance with the serial flash device connected on board. Flash device selection and access mode are determined by the address

accessed in the AHB address space associated to the QuadSPI module (refer to [Memory Mapped Serial Flash Data - Individual Flash Mode on Flash A](#), [Memory Mapped Serial Flash Data - Individual Flash Mode on Flash B](#)

On each AHB read access to the memory mapped area the valid data in the AHB Buffer is checked against the address requested in the actual read. When the AHB read request can't be served from the content of the AHB Buffer, the buffer is flushed and the sequence pointed to by the sequence ID is executed by the controller. The requested number of buffer entries defined in the `QSPI_BUFxCR[ADATSZ]` field is then fetched from the external serial flash device into the internal AHB Buffer. Since the read access is triggered via the AHB bus, the `QSPI_SR[AHB_ACC]` status bit is set driving in turn the `QSPI_SR[BUSY]` bit until the transaction is finished. The communication with the external serial flash is stopped when the specified number of entries has been filled.

2. Data Transfer from the QuadSPI Module Internal Buffers

The data read out from the external serial flash device by the QuadSPI module is stored in the internal buffers. The means of accessing the data from the buffer differs depending on which buffer the data has been loaded to. Refer to [Block Diagram](#) for details about the two available buffers, the RX Buffer and the AHB Buffer, in the QuadSPI module:

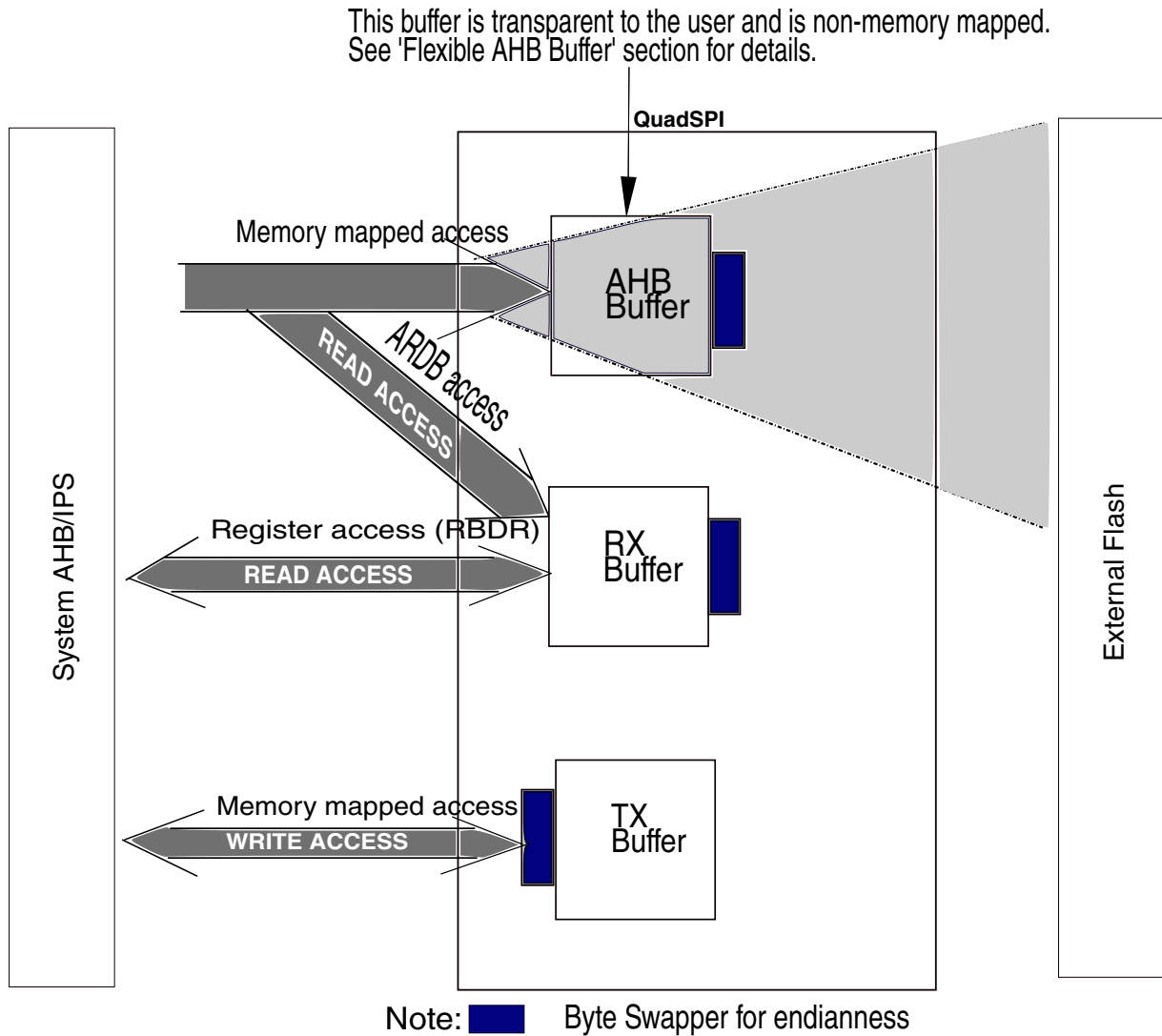

Figure 38-7. QuadSPI memory map

- The RX Buffer is implemented as FIFO of depth 32 entries of 4 bytes. Its content is accessible in two different address areas both referring to the identical data and the same physical memory.

In the IPS address space in the area associated to QSPI_RBDR0 to QSPI_RBDR31
 In the AHB address space in the area associated to QSPI_ARDB0 to QSPI_ARDB31. Two successive entries are accessed with one single 64 bit AHB read operation.

RX Buffer operation can be summarized as follows: The QSPI_RBCT[WMRK] field determines at which fill level the RXWE bit is asserted and how many entries are removed from the RX Buffer on each Buffer POP operation. So the QSPI_SR[RXWE] bit indicates that the configured number of data entries is available in the RX Buffer and the QSPI_RBSR[RDBFL] field indicates how

many valid entries are available in total. Note that the first entry (QSPI_RBDR0 or QSPI_ARDB0) always corresponds to the first valid entry in the RX Buffer. The software needs to manage the number of valid data bytes itself.

Further details can be found in [RX Buffer Data Register \(QuadSPI_RBDR \$n\$ \)](#) and in [AHB RX Data Buffer \(QSPI_ARDB0 to QSPI_ARDB31\)](#).

- **Flag-based Data Read of the RX Buffer** is done by polling the QSPI_SR[RXWE] bit. When it is asserted the valid entries can be read either via the IPS address space (QSPI_RBDR n) or the AHB address space (QSPI_ARDB n). A Buffer POP operation must be triggered by the application by writing a 1 into the QSPI_FR[RBDF] bit - this automatically updates the FIFO to point to the next entry as defined by RBCT[WMRK]. For example, if WMRK is set to 3, then the buffer will discard 16 bytes of data.
- **DMA controlled Data Read of the RX Buffer** is done by using the DMA module. The application must ensure that the DMA controller of the related device is programmed appropriately like it is described in [DMA Usage](#).

DMA controlled read out is triggered fully automatically by the assertion of the QSPI_SR[RXWE] bit. The related Buffer POP operation is also handled completely inside the QuadSPI module. Like in the case above, accessing the RX Buffer content either on QSPI_RBDR n or QSPI_ARDB n related addresses is equivalent.

- **AHB Buffer data read via memory mapped access:** This kind of access is done by reading one of the addresses assigned to the external serial flash device(s) within the range given in [Table 38-9](#) table *under the condition that the data requested are already present in the AHB Buffer or it is currently being read from the serial flash device by the instruction in progress*. If this is not the case a memory mapped AHB command read is triggered as described above. If the requested data is already available in the AHB Buffer they are provided directly to the host.

When AHB access are made to the flash memory mapped address, the data will be fetched and returned to the AHB interface. Till the data is being fetched the AHB interface would be stalled. As soon as the data from the requested address has been read by the QuadSPI module the AHB read access is served. So it is possible to run sequential reads from the AHB buffer at arbitrary speed without the need to monitor any information about the availability of the data.

Nevertheless this access scheme stalls the AHB bus for the time required to read the data from the serial flash device. A better way is (when it is known the

access is sequential) to have a prefetch enabled (by programming the ADATSZ field) such that before the next sequential AHB access come, the data is already fetched into the buffer.

As long as the host restricts its accesses to the data already in the buffer and the data currently fetched from the serial flash, it is possible to run the host read from the AHB Buffer in parallel to the serial flash read into the AHB Buffer.

38.7.2.9 Byte Ordering of Serial Flash Read Data

In this paragraph the byte ordering of the serial flash data is given. The basic scheme is that the **first** byte read out of the serial flash device - which is addressed by the QSPI_SFAR[SFADR] field - corresponds to bit position QSPI_RBDR0[31:24] register for IP Command read. In contrast to that for AHB Command read the bytes are always positioned according to the byte ordering of the AHB bus.

- **Byte Ordering in Individual Flash Mode**

The following table gives the byte ordering scheme of how the byte oriented data space of the serial flash device is mapped into one single 32 bit entry of the RX Buffer or the AHB Buffer. The table is valid within the following context:

- Flash A or Flash B in Individual Flash Mode
- All AHB data read commands with access size of 32 bit

Table 38-16. Byte Ordering in Individual Flash Mode

Serial Flash Byte Numbering	3	2	1	0
Buffer Entry Bit Position [31:0] (32 Bit data width)	[31:24]	[23:16]	[15:8]	[7:0]

Note

For IP Commands the read size can be given in number of bytes. If this number is not a multiple of 4, then the last buffer entry is not completely filled with the missing higher numbered bytes at undefined values.

For AHB Commands, reads, starting from an address not aligned to 32 bit boundaries, the requested bytes are given at the appropriate positions according to the AMBA AHB specification.

- **Buffer Entry Ordering for 64 Bit Read Access**

For read access via the AHB interface 64 bit access is possible. Each 64 bit access reads 2 32 bit entries simultaneously. The ordering of these 32 bit entries within the 64 bit word is given in the following table.

Table 38-17. 64 Bit Read Access Buffer Entry Ordering

AHB Read Data Bit Position [63:0]	[63:32]	[31:0]
Buffer Entry #	Odd (1, 3, 5, ...)	Even (0, 2, 4, ...)

38.7.2.10 Normal Mode Interrupt and DMA Requests

The QuadSPI module has different flags that can only generate interrupt requests and one flag that can generate interrupt as well as DMA requests. The following table lists the eight conditions. Note that the flags mentioned in the table are related to the [Flag Register \(QSPI_FR\)](#).

Table 38-18. Interrupt and DMA Request Conditions

Condition	Flag(QSPI_FR)	DMA
TX Buffer Fill	TBFF	-
TX Buffer Underrun	TBUF	-
Illegal Instruction Error	ILLINE	-
RX Buffer Drain	RBDF	X
RX Buffer Overflow	RBOF	-
AHB Buffer Overflow	ABOF	-
AHB Sequence Error	ABSEF	-
AHB Illegal Transaction Error	AITEF	-
AHB Illegal Burst Size Error	AIBSEF	-
IP Command Trigger during AHB Access Error	IPAEF	-
IP Command Trigger could not be executed Error	IPIEF	-
IP Command related Transaction Finished	TFF	-

Each condition has a flag bit in the [Flag Register \(QSPI_FR\)](#) and a Request Enable bit in the [DMA Request Select and Enable Register \(QSPI_RSER\)](#) . The RX Buffer Drain Flag (RBDF) has separate enable bits for generating IRQ and DMA requests. Note that not all flags have an individual IRQ line. Check the devices Interrupt Vector Table for more details.

- **Transmit Buffer Fill Interrupt Request:**

The Transmit Buffer Fill IRQ indicates that the TX Buffer can accept new data. It is asserted if the QSPI_FR[TBFF] flag is asserted and if the corresponding enable bit (QSIP_RSER[TBFIE]) is set. Refer to [TX Buffer Operation](#), for details about the assertion of the QSPI_FR[TBFF] flag.

Aside from IRQ it is possible to handle TX Buffer fill by DMA. If the QSPI_RSER[TBFDE] bit is set, a DMA request will be triggered when the number of available space in the TX Buffer is more than the QSPI_TBCT[WMRK] valid entries and QSPI_SR[TXWA] is set. The application must set the environment appropriately (eg. the DMA controller) for the DMA transfer.

- **Receive Buffer Drain Interrupt or DMA Request:**

The Receive Buffer Drain IRQ derived from the QSPI_FR[RBDF] flag indicates that the RX Buffer of the QuadSPI module has data available from the serial flash device to be read by the host. It remains set as long as the QSPI_RBSR[RXWE] bit is set. The QSPI_RSER[RBDIE] bit enables the related IRQ.

Aside from the IRQ it is possible to handle RX Buffer drain by DMA. If the QSPI_RSER[RBDDE] bit is set, a DMA request will be triggered when the RX Buffer contains more than QSPI_RBCT[WMRK] valid entries. The application must set the environment appropriately (for example, the DMA controller) for the DMA transfers.

- **Buffer Overflow/Underrun Interrupt Request:**

The Buffer Overflow/Underrun IRQ is a combination of the following flags (all located in the QSPI_FR register with the related enable bits in the QSPI_RSER register):

- TBUF - TX Buffer Underrun, enabled by TBUIE
- RBOF - RX Buffer Overflow, enabled by RBOIE
- ABOF - AHB Buffer Overflow, enabled by ABOIE

The Transmit Buffer Underrun indicates that an underrun condition in the TX Buffer has occurred. It is generated when a write instruction is triggered whilst the Tx Buffer is empty and the QSPI_RSER[TBUIE] bit is set.

The Receive Buffer Overflow indicates that an overflow condition in the RX Buffer has occurred. It is generated when the RX Buffer is full, an additional read transfer attempts to write into the RX Buffer and the QSPI_RSER[RBOIE] bit is set.

The AHB Buffer Overflow indicates that an overflow condition in the AHB Buffer has occurred. It is generated when the AHB Buffer is full, an additional read transfer attempts to write into the AHB Buffer and the QSPI_RSER[ABOIE] bit is set.

The data from the transfers that generated the individual overflow conditions is ignored.

- Serial Flash Command Error Interrupt Request

If the IPAEF, IPIEF flags in the QSPI_FR are set, and the related interrupt enable bits in the QSPI_RSER are also set, then an interrupt is requested.

- Transaction Finished Interrupt Request

The IP Command Transaction Finished IRQ indicates the completion of the current IP Command. It is triggered by the QSPI_FR[TFF] flag and is masked by the QSPI_RSER[TFIE] bit.

38.7.2.11 TX Buffer Operation

The TX Buffer provides the data used for page programming. For proper operation it is required to provide at least four entry in the TX Buffer prior to starting the execution of the page programming command. The application must ensure that the required number of data bytes is written into the TX Buffer fast enough as long as the command is executed without a TX Buffer overflow or underrun.

The QuadSPI module sets the QSPI_FR[TBFF] flag so long as the TX Buffer is not full and can accept more data.

When the QuadSPI module tries to pull data out of an empty TX Buffer the TX Buffer underrun is signaled by the QSPI_FR[TBUF] flag. The TX buffer underrun flag is also asserted when TX buffer contains less than 128 bits of data and QuadSPI module tries to pull out data from it. The current IP Command leading to the underrun condition is continued until the specified number of bytes has been sent to the serial flash device, in the underrun condition when QuadSPI module tries to pull out data of empty TX buffer, the data transferred is all F's i.e. once the underrun flag is set under this condition, it will return F's until the required number of bytes are not sent. This has been done to ensure that the software need not to erase whole sector after underrun, just reprogramming from

failure point will serve the purpose. When this Sequence Command is finished, the QSPI_FR[TBFF] flag is asserted indicating that the Tx Buffer is ready to be written again.

The TX Buffer overflow isn't signaled explicitly, but the TX Buffer fill level can be monitored by the QSPI_TBSR[TRBFL] field.

Refer to [TX Buffer Status Register \(QuadSPI_TBSR\)](#) and [Flag Register \(QuadSPI_FR\)](#) for details about the TX Buffer related registers.

38.7.2.12 Address scheme

Earlier serial flash memories supported only 24-bit address space hence restricting the maximum memory size of the serial flash as 16 MB. The new memory specification supports two types of 32-bit addressing mode in addition to legacy 24-bit address mode. It also supports segregation of address programmed, into Row address and Column address of the Flash, as per requirement.

- **Extended Address Mode**

In this mode, the legacy 24-bit commands are converted to accept 32-bit address commands. The flash memory needs to be configured for 32-bit address mode. Also, while programming the LUT sequence in QuadSPI for 32-bit mode, the ADDR and ADDR_DDR command should be programmed with 8'd32 as the operand value with QSPI_SFACR[CAS] programmed to 0. If a flash needs some bits of the address as its column address, then it must always be considered that the total bits required by the Flash should not exceed 32, as maximum address supported by QuadSPI is 32 bits. Each of the memory vendors have a different way of enabling this mode (Refer to the memory specification from memory vendors). For example, the command B7h sent to Macronix flash will enable it for 32-bit address mode.

- **Extended Address register**

In this mode, the upper 8-bit of the 32-bit address is provided by the Extended address register in the memory itself. The memory provides a specific register which is updated according to the address to be accessed. This effectively converts the legacy 24-bit address command into 32-bit address commands. The memories greater in size than 16 MB, consists of banks of 16 MB. The 8-bit written in the extended address register effectively enables a bank. For example in Spansion memory, when the extended address register is updated with a value of 0x01 with the help of the command 17h, it will open Bank1 of the memory. The consequent 24-bit address

commands will lead to Bank1. The extended address register needs to be update with the respective value for access to other banks. This effectively converts the legacy 24-bit address command into 32-bit address commands.

- **Separation of address into row and column address**

This mode has been introduced for flashes which needs addresses segregated into Row and Column. The value in QSPI_SFACR[CAS] defines the width of the column address required by a flash. The actual address to be provided will be derived from the incoming address in case of AHB initiated transactions and the value of SFAR in case of IPS initiated transactions , if QSPI_SFACR[CAS] is set to 0, else the actual address will take CAS into consideration. If QSPI_SFACR[CAS] is 3 then bits 26-3 of the address programmed are sent to flash as its page address in case flash is operating in 24bit mode and bits 2-0 are sent as its column address. If a flash requirement for column address is less than the number of pads in which address has to be sent than the remaining bits are appended with 0 by QuadSPI. The user must program the operand value in CADDR and CADDR_DDR command accordingly. It must be ensured that the total number of address bits request by flash as its page and column address must not be more than 32 bits.

- **Word addressable mode for Flash**

This mode has been introduced for flashes which has word addressable memory i.e. each address of the flash contains one word (two bytes) of data. The QSPI_SFACR [WA] is set to 1 to enter this mode. QuadSPI internally divides the incoming address in the AHB bus or the address in the QSPI_SFAR to map it to a valid flash location. For example, if the incoming address is 0x2004, the controller re-maps this address to access the flash location 0x1002. If not in this mode, the incoming address 0x2004 will be mapped to flash location 0x2004.

38.7.3 HyperRAM Support

The QuadSPI supports HyperRAM memories and by virtue of this protocol, QuadSPI supports the following functionalities.

- Bidirectional data strobe/read write data strobe (RWDS)
 - When QuadSPI is configured to use the HyperRAM mode, the RWDS pad should be pulled down.
- Variable refresh latency
 - If QuadSPI_MCR[VAR_LAT_EN] field is set, based on the status of RWDS from HyperRAM during Command/Address phase, QuadSPI includes additional initial access latency. If RWDS is high, QuadSPI will include twice + 1 the

latency mentioned in the DUMMY phase. If RWDS is low, latency mentioned in the DUMMY phase will only be included.

- During QuadSPI configuration register read/write DUMMY will not be the part of LUT programming and hence the status of RWDS will not be considered by QuadSPI.
- If QuadSPI_MCR[VAR_LAT_EN] is not set, fixed latency mentioned in the DUMMY phase will be included.
- Read data strobe to latch data from HyperRAM
- Data masking during write
 - Enabled if QuadSPI_MCR[DQS_OUT_EN].
 - RWDS is driven low by QuadSPI during Write data phase.
 - Data masking is not supported as the write data size is supposed to be 16 bit aligned.

38.8 Initialization/Application Information

This section provides the initialization and application information of the QuadSPI module.

38.8.1 Power Up and Reset

Note that the serial flash devices connected to the QuadSPI module may require special voltage characteristics of their inputs during power up or reset. It is the responsibility of the application to ensure this.

38.8.2 Available Status/Flag Information

This paragraph gives an overview of the different status and flag information available and their interdependencies for different use cases. Related registers are QSPI_SR and QSPI_FR. Refer to the related descriptions how to set up the QuadSPI module appropriately.

38.8.2.1 IP Commands

Refer to [IP Configuration Register \(QuadSPI_IPCR\)](#) for additional details not explicitly covered in this paragraph.

- **IP Commands - Normal Operation**

Writing the QSPI_IPCR[SEQID] field triggers the execution of a new IP Command. Given that this is a legal command the QSPI_SR[IPACC] and the QSPI_SR[BUSY] bits are asserted simultaneously, immediately after the execution is started.

When the instruction on the serial flash device has been finished these bits are de-asserted and the QSPI_FR[TFF] flag is set.

- **IP Commands - Error Situations**

Refer to [Table 38-19](#) below.

38.8.2.2 AHB Commands

Refer to Section 1, Reading Serial Flash Data into the QuadSPI Module, in [Flash Read](#) for additional details not explicitly covered in this paragraph.

- **AHB Commands - Normal Operation**

Memory mapped read access to a serial flash address not contained in the AHB Buffer, triggers the execution of an AHB Command. Given that this is a legal command the QSPI_SR[AHBACC] and the QSPI_SR[BUSY] bits are asserted simultaneously immediately after the execution is started. When the instruction on the serial flash device has been finished these bits are de-asserted.

- **IP Commands - Error Situations**

Refer to [Table 38-19](#) below.

38.8.2.3 Overview of Error Flags

The following table gives an overview of the different error flags in the QSPI_FR register and additional error-related details.

Table 38-19. Overview of QSPI_FR Error Flags

Error Category	Error Flag in QSPI_FR	Command Execution on Serial Flash Device TFF Behavior (in case of IP commands only)	Description
AHB Error Flag	ABSEF	Flash transaction is aborted	AHB sequence contains <ul style="list-style-type: none"> • WRITE instruction • WRITE_DDR instruction
AHB Error Flag	ABOF	Flash transaction continues until it finishes	Set when the module tried to push data into the AHB buffer that

Table continues on the next page...

Table 38-19. Overview of QSPI_FR Error Flags (continued)

Error Category	Error Flag in QSPI_FR	Command Execution on Serial Flash Device TFF Behavior (in case of IP commands only)	Description
			exceeded the size of the AHB buffer. Only occurs due to wrong programming of the QSPI_BUFxCR[ADATSZ].
AHB Error Flag	AIBSEF	Flash transaction is aborted	Total burst size of AHB transaction is greater than prefetch data size
AHB Error Flag	AITEF	Flash transaction is aborted	No response generated from QSPI to AHB bus in case of illegal transaction and the watchdog timer expires
Miscellaneous Error Flag	ILLINE	Flash transaction aborted	Illegal instruction Error Flag – Set when an illegal instruction is encountered by the controller in any of the sequences.
Command Arbitration Error	IPIEF	TFF not asserted in conjunction with that command	IP Command Error - caused when IP access is currently in progress (IP_ACC set) and <ul style="list-style-type: none"> • write attempt to QSPI_IPCR register. • write attempt to QSPI_SFAR register. • write attempt to QSPI_RBCT register.
Command Arbitration Error	IPAEF		<ul style="list-style-type: none"> • AHB Command already running, another IP Command could not be executed. • AHB Command already running, write attempt to QSPI_IPCR[SEQID] field.
Buffer Related Error	RBOF	TFF is asserted on completion	<ul style="list-style-type: none"> • RX Buffer Overrun
Buffer Related Error	TBUF		<ul style="list-style-type: none"> • TX Buffer Underrun

Note that only the buffer related errors are related to a transaction on the external serial flash. All the other errors do not trigger an actual transaction.

38.8.2.4 IP Bus and AHB Access Command Collisions

There are two flags related to this topic, the QSPI_FR[IPAEF] and QSPI_FR[PIEF]. Refer to sub-section "Reading Serial Flash Data into the QuadSPI Module" of [Flash Read](#) section, for a description of the flags.

38.8.3 Flash Device Selection

Regardless of the SFM Command (IP or AHB) the access mode is selected by specifying the 32 bit address value for the following SFM Command.

For IP Commands the access mode is selected with the address programmed into the QSPI_SFAR register. Refer to [Serial Flash Address Register \(QuadSPI_SFAR\)](#) for details.

For AHB Commands the access mode is determined by the memory mapped address which is accessed Refer to [Flash memory mapped AMBA bus](#) for details.

38.8.4 DMA Usage

For the complete description of the DMA module refer to the related DMA Controller chapter. In this paragraph only the details specific to the DMA usage related to the QuadSPI module are given.

38.8.4.1 DMA Usage in Normal Mode

38.8.4.1.1 Bandwidth considerations

Careful consideration of the throughput rate of the entire chain (serial flash -> AHB bus / IP Bus -> DMA controller) involved in the read/write data process is essential for proper operation. Such analysis must take into account not only the data rate provided by the serial flash but also the data rate of the AHB bus and the performance of the DMA controller in reading/writing data from/to the RX/TX buffer.

Two figures must match for proper operation, that means that the data rate provided by the serial flash device must not exceed the average RX Buffer readout data rate. Otherwise, the longer this state persists, a RX Buffer overflow will result. Similarly, the data consumed by the serial flash device must not exceed the average TX buffer fill rate. If this persists, it would eventually lead to an underrun.

AHB Bus Side (data read):

The following table gives some examples for typical use cases:

Case 1: DMA need to read 4 bytes from SRAM and provide to QuadSPI. It costs total 4 BUS clock cycles. Then DMA handshake added additional 6 BUS clock cycles. Total $[6 + 4 * (32/4) = 38]$ BUS clock cycles.

Table 38-20. Access Duration Examples - Bus Clock Side

QSPI_TBCT[WMRK]	Number of Bytes per DMA Loop	Number of Bus Clock cycles for DMA Minor Loop	Time Duration of DMA Minor Loop for 60Mhz Bus clock Frequency
3	16	$6+(16/4)*4 = 22$	~366ns
7	32	$6+(32/4)*4 = 38$	~633ns
11	48	$6+(48/4)*4 = 54$	~900ns
15	64	$6+(64/4)*4 = 70$	~1166ns

Case2: DMA need to read 32 bytes from SRAM and provide to QuadSPI DMA handshake takes additional 6 BUS cycles, with 32byte DMA read from SRAM costs $(8 + 3)$ CORE clock cycles. DMA write 32 byte to QSPI takes $2 * (32/4) = 16$ BUS cycles with one additional CPU access to QuadSPI, costing 2 BUS clock cycles. Total $6 + (8+3)/2 + 2 * (32/4) + 2 = 30$ BUS clock cycles.

Table 38-21. Access Duration Examples - Bus Clock Side

QSPI_TBCT[WMRK]	Number of Bytes per DMA Loop >	Number of Bus Clock cycles for DMA Minor Loop	Time Duration of DMA Minor Loop for 80Mhz Bus clock Frequency
3	16	$6 + (4+3) /2 + (16/4)*2 + 2 = 20$	~333ns
7	32	$6 + (8+3) /2 + (32/4)*2 + 2 = 30$	~500ns
11	48	$6 + (4+3)/2*3 + (48/4)*2 + 2 = 44$	~733ns
15	64	$6 + (8+3) + (64/4)*2 + 2 = 51$	~810ns

NOTE

The table figure represents ideal scenario, actual performance will depend on how the system is integrated.

Serial Flash Device Side (data read):

The number of serial flash cycles can be determined in the following way:

- Number of serial flash clock cycles required to read 4 bytes, corresponding to one RX Buffer entry (setup of command and address not considered): , 2 cycles for Octal

DDR mode (Hyperflash/HyperRAM) in individual flash mode , 8 cycles for Quad Mode (SDR) instructions in Individual Flash Mode etc.

- Overhead due to clock domain crossing : 1 cycle.

The following table lists the number of clock cycles required to read the data from the serial flash corresponding to the different settings of the QSPI_RBCT[WMRK] field:

Table 38-22. Access Duration Examples - Serial Flash side

QSPI_RBCT[WMRK] setting	Num Bytes per DMA Loop ¹	Num SCKF _x for 80MHz SCKF _x		Time duration of Flash data readout for 80MHz SCKF _x (~12.5ns period)	
		IFM ² Quad	IFM Quad DDR	IFM Quad	IFM Quad DDR
0	4	8	4	~100ns	~50ns
1	8	16	8	~200ns	~100ns
3	16	32	16	~400ns	~200ns
7	32	64	32	~800ns	~400ns
11	48	96	48	~1200ns	~600ns

1. DMA Loop means one Minor loop completion which is equivalent to one Major Loop iteration.
2. Individual flash mode.

NOTE

The table figure represents ideal scenario, actual performance will depend on how the system is integrated.

A complementary example would be when the watermark is set to be too high. In such a case, the time taken by the DMA to read out the RX buffer entries should be smaller than the time taken by the controller to push in the remaining entries in the buffer.

IPS Bus Side (data write):

The total number of bus cycles for each DMA Minor Loop completion is added from the following components:

- Overhead for each minor loop, given by DMA controller: Assume 10 cycles
- Overhead due to clock domain crossing: Assume 2 cycles
- Number of bus clock cycles required for 16 bytes (128 bit write size): Assume 4 cycles (read/write sequence of DMA controller)

Note that the size of the minor loop is determined by the size of the QSPI_TBCT[WMRK] field, therefore the overhead given above distributes among (QSPI_TBCT[WMRK]+1) write accesses of 32 bit each.

The following table gives some examples for typical use cases:

Table 38-23. Access Duration Examples - Bus Clock Side

QSPI_TBCT[WMRK]	Number of Bytes per DMA Loop ¹	Number of Bus Clock cycles for DMA Minor Loop	Time Duration of DMA Minor Loop for 80Mhz Bus clock Frequency
3	16	12+4 = 16	~200ns
7	32	12+8 = 20	~250ns
11	48	12+12 = 24	~300ns
15	64	12+16 = 28	~350ns
19	80	12+20 = 32	~400ns

1. DMA Loop means one Minor Loop Completion which is equivalent to one.

NOTE

The table figure represents ideal scenario, actual performance will depend on how the system is integrated.

Serial Flash Device Side (data write):

The number of serial flash cycles can be determined in the following way:

- Number of serial flash clock cycles required to write 16 bytes, corresponding to four TX Buffer entry(setup of command and address not considered): 8 cycles for Octal DDR mode (Hyperflash/HyperRAM) instructions in Individual Flash Mode, 32 cycles for Quad SDR writes in individual flash mode.
- Overhead due to clock domain crossing : 1 cycle.

The following table lists the number of clock cycles required to read the data from the serial flash corresponding to the different settings of the QSPI_TBCT[WMRK] field:

Table 38-24. Access Duration Examples - Serial Flash side

QSPI_TBCT[WMRK] setting	Num Bytes per DMA Loop ¹	Num SCKFx		Time duration for consuming data at Flash interface 100MHz SCKFx (10ns period) ²		Time for fifo to get empty ³	
		IFM ⁴ Quad	IFM Octal DDR	IFM Quad	IFM Octal DDR	IFM Quad	IFM Octal DDR
3	16	32	8	320ns	80ns	2240ns	560ns
7	32	64	16	640ns	160ns	1920ns	480ns
15	64	128	32	1280ns	320ns	1280ns	320ns
23	96	192	48	1920ns	480ns	640ns	160ns

1. DMA Loop means one Minor loop completion which is equivalent to one Major Loop iteration.
2. Not all flash devices support writes at 100Mhz. Please refer to the flash datasheet for the actual page program frequency supported.
3. The assumption for these timings is that the TX Fifo was full when the transaction was initiated
4. Individual flash mode.

NOTE

The tables mentioned above are only examples which must be correlated with the DMA in the system.

From the examples given in the two tables above for TX fifo, it can be seen that depending on the relationship between the Bus clock and Serial flash clock frequencies, there are settings possible where the serial flash consumes data faster than the IPS bus can write data in TX buffer. In these cases, a TX buffer underrun situation will occur. To avoid TX Buffer underrun, the data transaction size should be large enough.

38.9 Byte Ordering - Endianness

QuadSPI provides support for swapping the flash read/write data based on the configuration of the QSPI_MCR[END_CFG]. By default the data is always returned in 64 bit LE format on the AHB bus and 32 bit LE format on the IPS interface when read via the RX buffer and written in 32 bit LE format when written via the TX buffer.

The table(QSPI_MCR[END_CFG]) below shows the complete bit ordering. BE signifies Big Endian which means the high order bits of the associated data vectors are associated with low order address positions. LE signifies Little Endian which means the lower order bits of the associated data vectors are associated with low order address positions. Refer to figure [Figure 38-7](#)

Table 38-25. QSPI_MCR[END_CFG]

00	64 bit BE
01	32 bit LE
10	32 bit BE
11	64 bit LE

The tables below (Byte ordering configuration in AHB) and (Byte ordering configuration in IPS) show how this configuration is implemented in QSPI AHB and IPS interfaces respectively. B in the table signifies Byte and the index 1-8 refers to the byte position i.e. 1 refer to bits[7:0], 8 refer to bits[63:56] and so on.

Table 38-26. Byte ordering configuration in AHB

64 bit BE	B1	B2	B3	B4	B5	B6	B7	B8
64 bit LE	B8	B7	B6	B5	B4	B3	B2	B1
32 bit BE	B5	B6	B7	B8	B1	B2	B3	B4
32 bit LE	B4	B3	B2	B1	B8	B7	B6	B5

Table 38-27. Byte ordering configuration in IPS

32BE	B1	B2	B3	B4
32LE	B4	B3	B2	B1

The examples below show the byte ordering in 64 bit BE configuration for AHB Buffer and 32 bit BE for TX/RX Buffer:

38.9.1 Programming Flash Data

CPU write instructions to the QSPI_TBDR register like

- Write QSPI_TBDR -> 0x01_02_03_04
- Write QSPI_TBDR -> 0x05_06_07_08

result in the following content of the TX Buffer:

Table 38-28. Example of QuadSPI TX Buffer

TX Buffer Entry	Content
0	32'h01_02_03_04
1	32'h05_06_07_08

Programming the TX Buffer into the external serial flash device results in the following byte order to be sent to the serial flash:

- 01...02...03...04...05...06...07...08

38.9.2 Reading Flash Data into the RX Buffer

Reading the content from the same address provides the following sequence of bytes, identical to the write case:

- 01...02...03...04...05...06...07...08

This results in the RX Buffer filled with:

Table 38-29. Resulting RX Buffer Content

RX Buffer Entry	Content
0	32'h01_02_03_04
1	32'h05_06_07_08

38.9.2.1 Readout of the RX Buffer via QSPI_RBDRn

The RX Buffer content appears at CPU read access via the Peripheral bus interface in the following order:

- Read QSPI_RBDR0 <- 0x01_02_03_04
- Read QSPI_RBDR1 <- 0x05_06_07_08

38.9.2.2 Readout of the RX Buffer via ARDBn

The RX Buffer content appears at read access on the AMBA AHB interface at the QuadSPI module boundary:

- (1a): 32 Bit Access: Read QSPI_ARDB0 <- 0x01_02_03_04
- (2a): 32 Bit Access: Read QSPI_ARDB1 <- 0x05_06_07_08
- (1b/2b): 64 Bit Access: Read QSPI_ARDB0 <- 0x01_02_03_04_05_06_07_08

38.9.3 Reading Flash Data into the AHB Buffer

Reading the content from the same address as it was written to provides the following sequence of bytes, identical to the write case:

- 01...02...03...04...05...06...07...08

This results in the AHB Buffer filled with:

Table 38-30. Resulting AHB Buffer Content

AHB Buffer Entry	Content
0	64'h01_02_03_04_05_06_07_08

38.9.3.1 Readout of the AHB Buffer via Memory Mapped Read

The AHB Buffer content appears at read access on the AMBA AHB interface at the QuadSPI module boundary:

- (1a): 32 Bit Read Access: <- 0x01_02_03_04
- (2a): 32 Bit Read Access: <- 0x05_06_07_08
- (1/2): 64 Bit Read Access: <- 0x01_02_03_04_05_06_07_08

38.10 Driving Flash Control Signals in Single and Dual Mode

In single and dual mode the serial flash devices which can connect to the QuadSPI module expect additional control signals on the inputs which are connected to IOFA[3], IOFA[2], IOFB[3] and IOFB[2] in quad mode. For easy interfacing the outputs IOFA[3:2] for Flash A and the IOFB[3:2] for Flash B are driven to the logic state given by the configuration bits QSPI_MCR[ISD3FA], QSPI_MCR[ISD2FA], QSPI_MCR[ISD3FB] and QSPI_MCR[ISD2FB].

These outputs are driven all the time to the logic level programmed in the QSPI_MCR register except the time when quad commands of the serial flash are executed. Refer to the specification of the related serial flash device for details about the inactive level.

38.11 Serial Flash Devices

Several different vendors make flash devices with a QuadSPI interface. At present there is no set standard for the QuadSPI instruction set. Most common commands currently have the same instruction code for all vendors, however some commands are unique to specific vendors. Some example sequences are provided below.

38.11.1 Example Sequences

This section provides the example sequences of the QuadSPI module.

Table 38-31. Exit 4 x I/O Read Enhance Performance Mode (XIP) (Macronix) and Read Status

INSTR	PAD	OPERAND	COMMENT
CMD	0x0	0xEB	4xIO Read Command
ADDR	0x2	0x18	24 Bit address to be send on 4 pads
MODE	0x2	0x00	2 mode cycles (exit XIP)
DUMMY	0x0	0x04	4 dummy cycles
READ	0x2	0x08	Read 64 bits
CMD	0x0	0x05	Read Status register
READ	0x0	0x01	Status register data
STOP	0x0	0x00	STOP, Instruction over

38.11.1.1 Read Command (Spansion Hyperflash/HyperRAM)

This section provides the read command sequences (Spansion Hyperflash/HyperRAM) of the QuadSPI module.

Table 38-32. Read Command (Spansion Hyperflash/HyperRAM)

INSTR	PAD	OPERAND	COMMENT
CMD_DDR	0x3	0xA0	Read command with continuous burst type
ADDR_DDR	0x3	0x18	24 bit row address
CADDR_DDR	0x3	0x10	16 bit column address with lower 3 bits valid rest 0
DUMMY	0x3	0x0F	15 dummy cycles
READ_DDR	0x3	0x4	32 bit data read on 8 pads
STOP	0x3	0x00	STOP, Instruction over

Hyperflash/HyperRAM is a word addressable flash i.e. each address accesses a word wide (2 bytes) data value, the software should ensure that when Hyperflash/HyperRAM is connected to the controller, the QSPI_SFACR [WA] bit must be set. If this bit is set the controller remaps a byte addressable access to a word addressable access.

38.11.1.2 Read Status Register(Spansion Hyperflash/HyperRAM)

This section provides the read status register of the QuadSPI module.

Table 38-33. Read Status register (Spansion Hyperflash/HyperRAM)

INSTR	INSTR SEQUENCE	PAD	OPERAND	COMMENT
CMD_DDR	Read Pre Comman	0x3	0x00	Write command with wrapped burst type.
ADDR_DDR		0x3	0x18	24 bit row address(0000AAh)
CADDR_DDR		0x3	0x10	16 bit column address with lower 3 bits valid rest 0(0005h),treated as command
CMD_DDR		0x3	0x00	Write command with wrapped burst type
CMD_DDR		0x3	0x70	Write data to be sent to flash as pre-command
CMD_DDR	Command phase (fourth/final chip select phase)	0x3	0xA0	Read command with continuous burst type
ADDR_DDR		0x3	0x18	24 bit row address
CADDR_DDR		0x3	0x10	16 bit column address with lower 3 bits valid rest 0
DUMMY		0x3	0x0F	15 dummy cycles
READ_DDR		0x3	0x4	32 bit data read on 8 pads
STOP		0x3	0x00	STOP, Instruction over

38.11.1.3 Word Program (Spansion Hyperflash/HyperRAM)

This section provides the Word Program (Spansion Hyperflash/HyperRAM) of the QuadSPI module.

Table 38-34. Word Program (Spansion Hyperflash/HyperRAM)

INSTR	INSTR SEQUENCE	PAD	OPERAND	COMMENT
CMD_DDR	Unlock Sequence 1 (first chip select phase)	0x3	0x00	Write command with wrapped burst type
CMD_DDR		0x3	0x00	8 bit address 00h treated as command
CMD_DDR		0x3	0x00	8 bit address 00h treated as command
CMD_DDR		0x3	0xAA	8 bit address AAh treated as command

Table continues on the next page...

Table 38-34. Word Program (Spansion Hyperflash/HyperRAM) (continued)

CADDR_DDR		0x3	0x10	16 bit column address with lower 3 bits valid rest 0(0005h), treated as command
CMD_DDR		0x3	0x00	Write command with wrapped burst type.
CMD_DDR		0x3	0xAA	Write data to be sent to flash as pre-command.
CMD_DDR	Unlock Sequence 2 (second chip select phase)	0x3	0x00	Write command with wrapped burst type
CMD_DDR		0x3	0x00	8 bit address 00h treated as command
CMD_DDR		0x3	0x00	8 bit address 00h treated as command
CMD_DDR		0x3	0x55	8 bit address 55h treated as command
CADDR_DDR		0x3	0x10	16 bit column address with lower 3 bits valid rest 0(0002h), treated as command
CMD_DDR		0x3	0x00	Write command with wrapped burst type
CMD_DDR	Program setup phase (third chip select phase)	0x3	0x55	Write data to be sent to flash as pre-command
CMD_DDR		0x3	0x00	Write command with wrapped burst type
CMD_DDR		0x3	0x00	8 bit address 00h treated as command
CMD_DDR		0x3	0x00	8 bit address 00h treated as command
CMD_DDR		0x3	0xAA	8 bit address AAh treated as command
CADDR_DDR		0x3	0x10	16 bit column address with lower 3 bits valid rest 0(0005h), treated as command
CMD_DDR	Command phase (fourth/final chip select phase)	0x3	0x00	Write command with wrapped burst type
CMD_DDR		0x3	0xA0	Write data to be sent to flash as pre-command
CMD_DDR		0x3	0x00	Write command with wrapped burst type
ADDR_DDR		0x3	0x18	24 bit row address
CADDR_DDR		0x3	0x10	16 bit column address with lower 3 bits valid rest 0
WRITE_DDR		0x3	0x2	2 bytes data written on 8 pads (D1D2)

Table continues on the next page...

Table 38-34. Word Program (Spansion Hyperflash/HyperRAM) (continued)

STOP		0x3	0x00	STOP, Instruction over
------	--	-----	------	------------------------

38.11.1.4 Fast Read Sequence (Macronix/Numonyx/Spansion/Winbond)

The following table shows the fast read sequence for Macronix/Numonyx/Spansion/Winbond flashes.

Table 38-35. Fast Read sequence

Instruction	Pad	Operand	Comment
CMD	0x0	0x0B	Fast Read command = 0x0B
ADDR	0x0	0x18	24 Addr bits to be sent on one pad
DUMMY	0x0	0x08	8 Dummy cycles
READ	0x0	0x04	Read 32 Bits on one pad
JMP_ON_CS	0x0	0x00	Jump to instruction 0 (CMD)

38.11.1.5 Fast Dual I/O DT Read Sequence (Macronix)

The following table shows the Fast Dual I/O DT read sequence for Macronix flashes.

Table 38-36. Fast Dual I/O DT Read sequence

Instruction	Pad	Operand	Comment
CMD	0x0	0xBD	Fast Dual I/O DT read command = 0xBD
ADDR_DDR	0x1	0x18	24 Addr bits to be sent on 2 pads in DDR mode
MODE4_DDR	0x1	0x00	P2=P0 or P3=P1 is necessary. Refer to Macronix datasheet for details. One clock cycle for mode.
DUMMY	0x0	0x06	6 Dummy cycles
READ_DDR	0x1	0x04	Read 32 Bits on 2 pads in DDR mode
JMP_ON_CS	0x0	0x00	Jump to instruction 0 (CMD)

38.11.1.6 Fast Read Quad Output (Winbond)

The following table shows the Fast read quad output sequence for Winbond memories

Table 38-37. Fast Read Quad output sequence

Instruction	Pad	Operand	Comment
CMD	0x0	0x6B	Fast read quad output command = 0x6B
ADDR	0x0	0x18	24 Addr bits to be sent on 1 pad
DUMMY	0x0	0x08	8 Dummy cycles
READ	0x2	0x04	Read 32 Bits on 4 pads
JMP_ON_CS	0x0	0x00	Jump to instruction 0 (CMD)

38.11.1.7 4 x I/O Read Enhance Performance Mode (XIP) (Macronix)

The following table shows the 4 x I/O Read Enhance Performance Mode for Macronix flashes. The enhanced performance mode is also known as XIP mode.

Table 38-38. Fast Read Quad output sequence

Instruction	Pad	Operand	Comment
CMD	0x0	0xEB	4xI/O Read command = 0xEB
ADDR	0x2	0x18	24 Addr bits to be sent on 4 pads
MODE	0x2	0xA5	2 mode cycles
DUMMY	0x0	0x04	4 Dummy cycles
READ	0x2	0x04	Read 32 Bits on 4 pads
JMP_ON_CS	0x0	0x01	Jump to instruction 1 (ADDR)

When in XIP mode the software should ensure that all the flashes connected to the controller are in XIP mode. As a part of initializing the controller, all the flashes may be enabled with XIP by carrying out dummy reads.

38.11.1.8 Dual Command Page Program (Numonyx)

The following table shows the Dual command page program sequence for Numonyx flashes.

Table 38-39. Dual Command Page Program sequence

Instruction	Pad	Operand	Comment
CMD	0x1	0x02	Dual command page program = 0x02 on 2 pads
ADDR	0x1	0x18	24 Addr bits to be sent on 2 pads
WRITE	0x1	0x20	Write 32 Bytes on 2 pads
STOP	0x0	0x00	STOP, Instruction over

38.11.1.9 Sector Erase (Macronix/Spansion/Numonyx)

The following table shows the Sector erase sequence for Macronix/Spansion/Numonyx flashes

Table 38-40. Sector Erase sequence

Instruction	Pad	Operand	Comment
CMD	0x0	0xD8	Sector erase command = 0xD8
ADDR	0x0	0x18	24 Addr bits to be sent on 1 pad
STOP	0x0	0x00	STOP, Instruction over

38.11.1.10 Read Status Register (Macronix/Spansion/Numonyx/Winbond)

The following table shows the Read status register sequence for Macronix/Spansion/Numonyx/Winbond flashes.

Table 38-41. Read Status Register Sequence

Instruction	Pad	Operand	Comment
CMD	0x0	0x05	Read status register command = 0x05
READ	0x0	0x01	Read status register data
STOP	0x0	0x00	STOP, Instruction over

38.12 Sampling of Serial Flash Input Data

38.12.1 Basic Description

QuadSPI is used to read data from the serial flash device. Depending on the actual implementation, there is a delay between the internal clocking in the QuadSPI module and the external serial flash device. Refer to the following figure for an overview of this scheme.

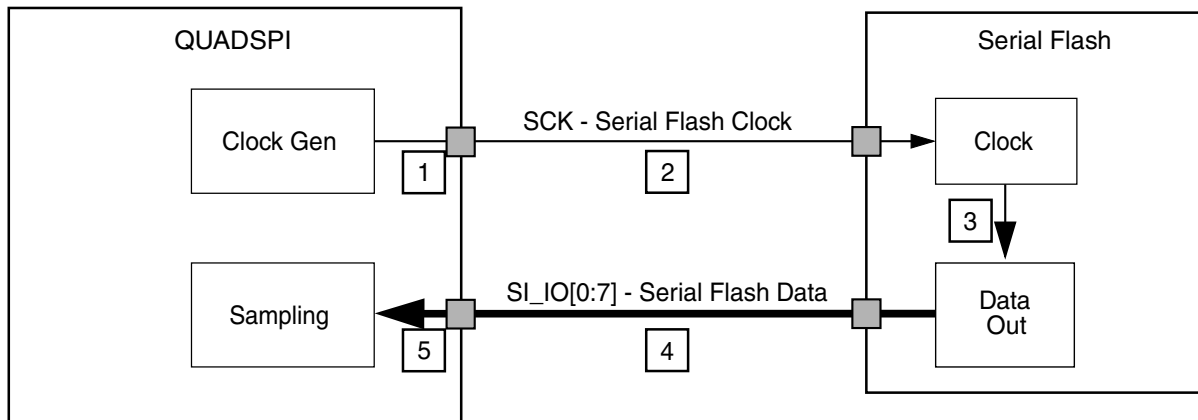

Figure 38-8. Serial Flash Sampling Clock Overview

The rising edge of the internal reference clock is taken as timing reference for the data output of the serial flash. After a time of $t_{Del,total}$ the data arrives at the internal sampling stage of the QuadSPI module. According to the Serial Flash Sampling Clock Overview figure, the following parts of the delay chain contribute to $t_{Del,total}$:

1. Output delay of the serial flash clock output of the device containing the QuadSPI module
2. Wire delay of application/PCB from the device containing the QuadSPI module to the external serial flash device
3. Clock to data out delay of the external serial flash device, including input and output delays
4. Wire delay of application/PCB from the external serial flash device to the device containing the QuadSPI module
5. Device delay corresponding to the input data

NOTE

The amount of total delay $t_{Del,total}$ is specific to the characteristics of the actual implementation. Also, the serial flash device clock (SCK) is inverted with respect to the QuadSPI internal reference clock.

38.12.2 Supported read modes

Some modes listed here may not be available on this chip. See the chip-specific QuadSPI information for the read modes that this chip supports.

38.12.2.1 SDR mode

Most flash memories operate in single data rate (SDR) mode. In SDR mode, the data is transferred only on one edge of the clock signal. The SDR serial flash memories sample the incoming data on the rising edge of serial flash clock and drive the output data on the falling edge of the serial flash clock.

38.12.2.1.1 Internal sampling

NOTE

This mode may not be available on this chip. See the chip-specific QuadSPI information for the read modes that this chip supports.

QuadSPI uses different edges of the internal reference clock for sampling the input data in SDR mode.

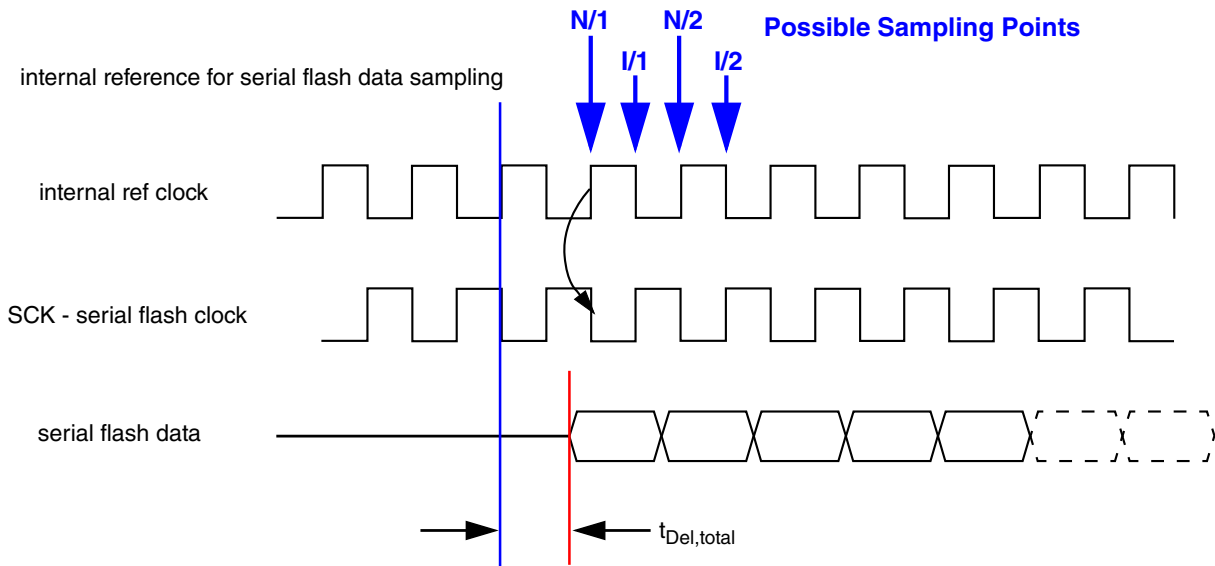

Figure 38-9. Internal sampling in SDR mode

The possible points in time for sampling incoming data are denoted as N/1, I/1, N/2 and I/2 above. The sampling point relevant for the internal sampling is configured in the QSPI_SMPR register. Refer to [Sampling Register \(QuadSPI_SMPR\)](#) for details. The following table gives an overview of the available configurations for the commands running at regular (full) speed:

Table 38-42. Sampling Configuration

Sampling Point	Description	Delay [FSDLY]	Phase [FSPHS]	QSPI_SMPR for Full Speed Setting ¹
N/1	sampling with non-inverted clock, 1 sample delay	0	0	0x0000000x
I/1	sampling with inverted clock, 1 sample delay	0	1	0x0000002x
N/2	sampling with non-inverted clock, 2 samples delay	1	0	0x0000004x
I/2	sampling with inverted clock, 2 samples delay	1	1	0x0000006x

1. 'x' is not considered here

Depending on the actual delay and the serial flash clock frequency, the appropriate sampling point can be chosen. The following remarks should be considered when selecting the appropriate setting:

- Theoretically there should be two settings possible to capture the correct data, since the serial flash output is valid for 1 clock cycle, disregarding rise and fall times and timing uncertainties.
- Depending on the timing uncertainties, it may turn out in actual applications that only one possible sample position remains. This is subject to careful consideration depending on the actual implementation.
- The delay $t_{Del,total}$ is an absolute size to shift the point in time when the serial flash data get valid at the QuadSPI input.
- For decreasing frequency of the serial flash clock the distance between the edges increases. So for large differences in the frequency the required setting may change.

38.12.2.1.2 DQS sampling method

NOTE

This mode may not be available on this chip. See the chip-specific QuadSPI information for the read modes that this chip supports.

Data sampling in SDR mode can be supported using the DQS sampling method. Refer to [Data Strobe \(DQS\) sampling method](#) for more details.

38.12.2.2 DDR Mode

The increasing requirement of improved throughput has introduced the double data rate (DDR) mode. In DDR mode, the data is transferred on both the rising and falling edges of the serial flash clock. The DDR serial flashes sample as well as drive the data on both rising and falling edges of serial flash clock.

38.12.2.2.1 DQS sampling method

NOTE

This mode may not be available on this chip. See the chip-specific QuadSPI information for the read modes that this chip supports.

Data sampling in DDR mode can be supported using DQS method. Refer to [Data Strobe \(DQS\) sampling method](#) for more details.

38.12.3 Data Strobe (DQS) sampling method

38.12.3.1 Basic Description

In DQS mode, the data strobe signal (DQS/RWDS) is used to sample the read data. Here, both DQS and the data sent by the flash move in the same direction, so it is relatively easier to achieve at higher frequencies.

When using DQS for SDR reads, QuadSPI internally samples the incoming data on rising edge of the strobe signal.

The figure below shows sampling read data in SDR mode using DQS.

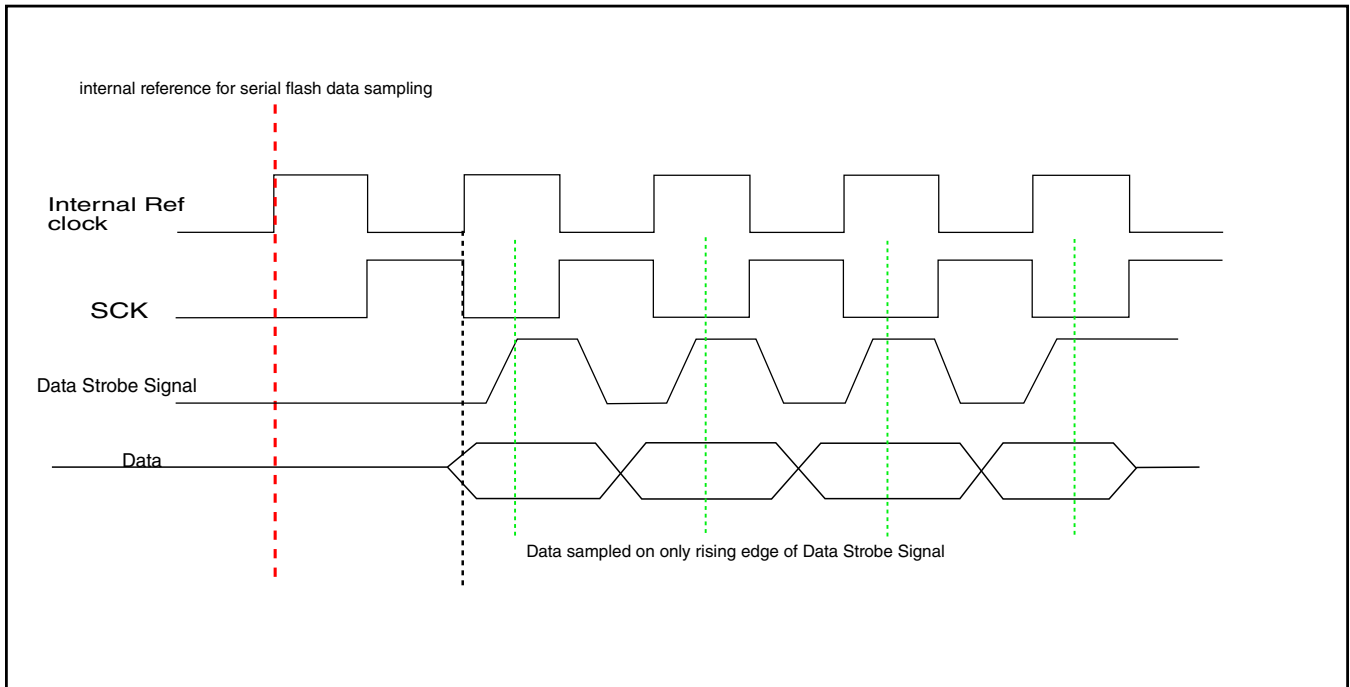

Figure 38-10. Data Strobe functionality in SDR mode

When using DQS for DDR reads, QuadSPI internally samples the incoming data on both the edges of the strobe signal. Refer to the figure below for more detail.

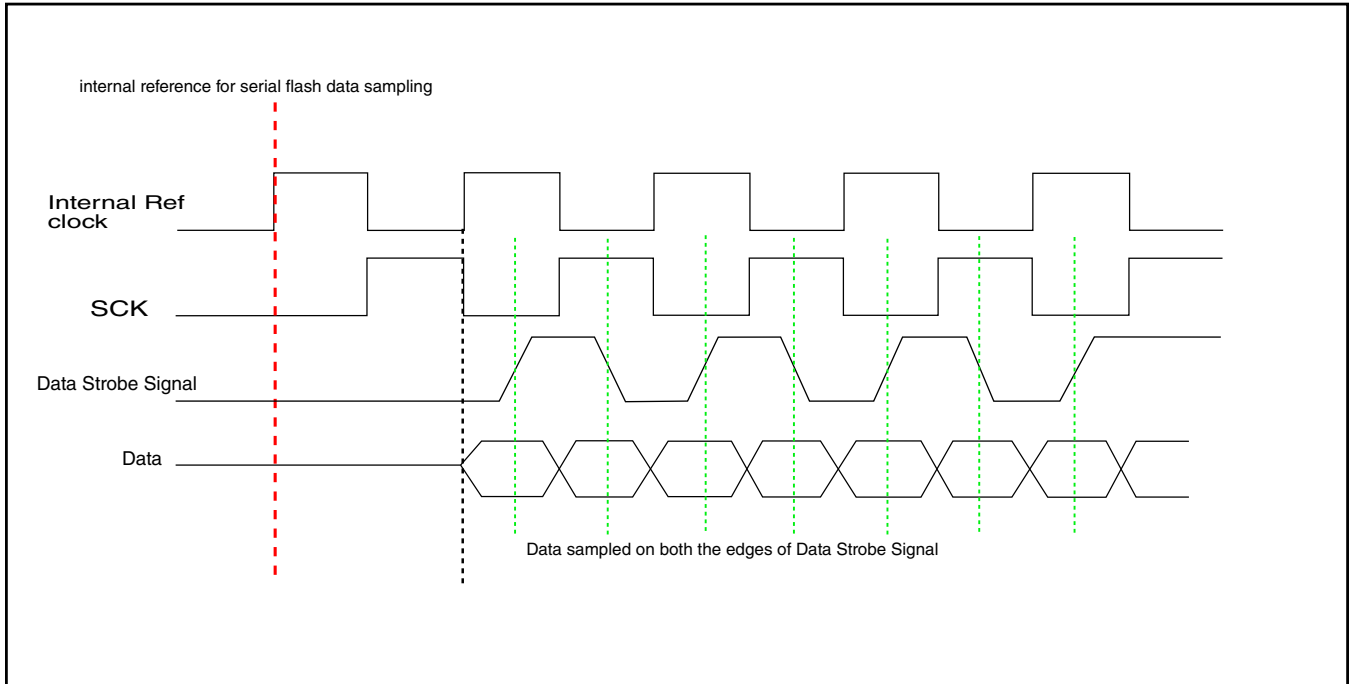

Figure 38-11. Data Strobe functionality in DDR mode

38.12.3.2 Internally generated DQS

NOTE

This mode may not be available on this chip. See the chip-specific QuadSPI information for the read modes that this chip supports.

In this mode, the internal reference clock is fed as a strobe to QuadSPI for read data sampling. The data strobe must be generated in a way such that the data is correctly sampled by the QuadSPI module. This internally generated data strobe signal can be used by QuadSPI to capture the data in:

- SDR mode
- DDR mode

Refer to QuadSPI chip-specific information for additional details about internally generated DQS.

38.12.3.3 External DQS

NOTE

This mode may not be available on this chip. See the chip-specific QuadSPI information for the read modes that this chip supports.

In serial flash memories supporting DQS, the data strobe signal is an output from the flash device that indicates when data is being transferred from the flash to the host controller. The data is then captured by the controller on:

- Only one edge (either rising or falling edge) of DQS signal in SDR mode
- Both rising/falling edge of the DQS signal in DDR mode

Some serial flash memories (for example, HyperFlash) provide the data strobe output (RWDS) with latency cycles included in between the ongoing read transaction. The data is sampled on both the edges of this signal taking into consideration that when no signal is provided by flash between ongoing transaction, data is not sampled then and at the end of transaction the required number of data to be fetched remains the same. Refer to the figure below for more detail.

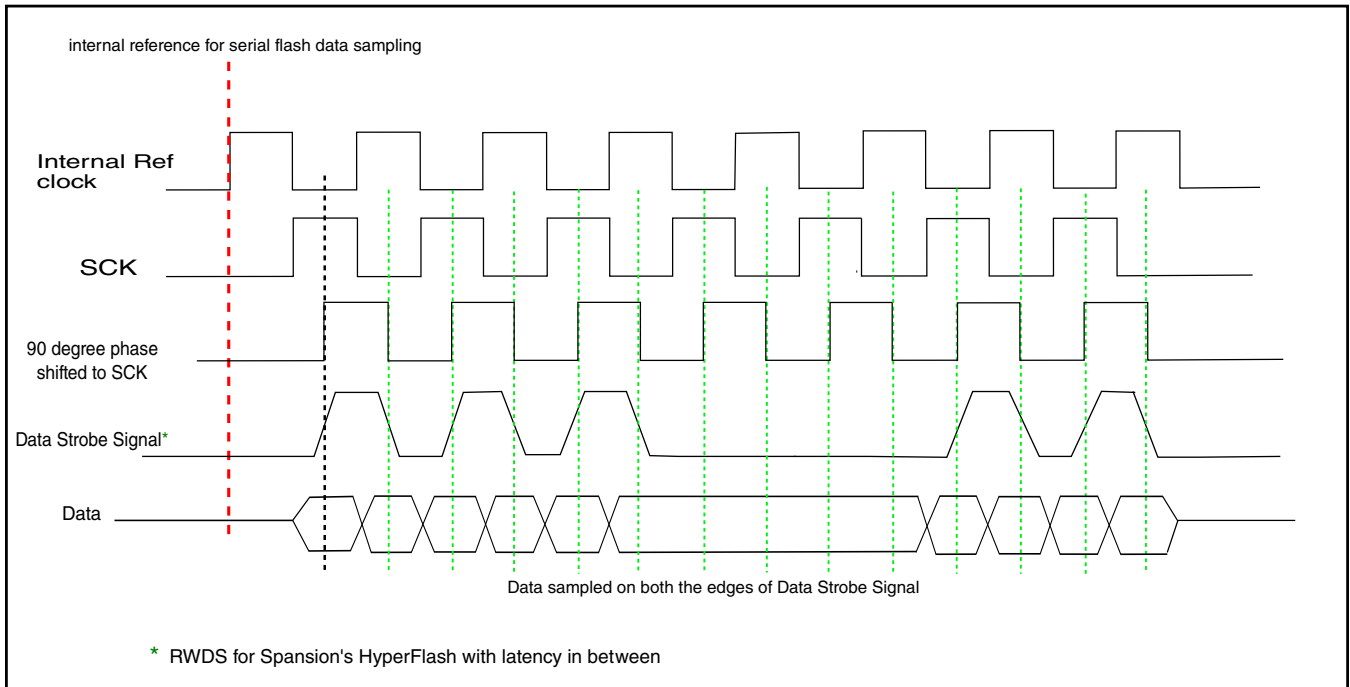

Figure 38-12. Data Strobe functionality with latency included

38.13 Data Input Hold Requirement of Flash

In DDR mode, the data is valid only for half clock cycle. It is difficult to meet the data input hold time requirement of flash. QuadSPI internally delays the data sent to flash so that it will be easy to meet the hold requirement. The `QSPI_FLSHCR[TDH]` is used for this purpose. If `QSPI_FLSHCR[TDH]` is configured to 0, the data sent to flash is aligned with the internal reference clock of QuadSPI, if it is 1, then, the data is aligned to 2x internal reference half clock.

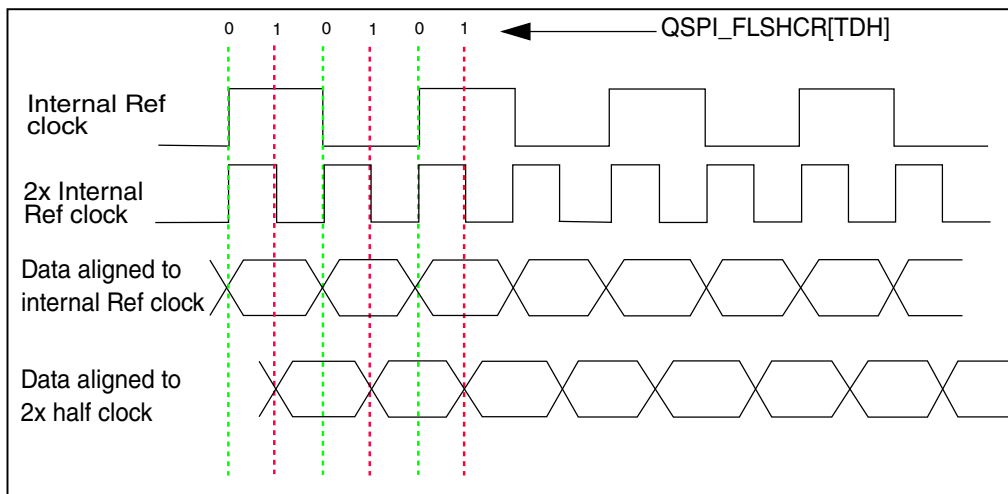

Figure 38-13. Data Hold

Chapter 39

Power Management

39.1 Introduction

This chapter describes the various chip power modes and functionality of the individual modules in these modes.

39.2 Power modes description

The Power Management Controller (PMC) provides multiple power options allowing users to optimize power consumption for the level of functionality needed.

Depending on the stop requirements of the user application, a variety of stop modes are available that provide state retention, partial power down or full power down of certain logic and/or memory. I/O states are maintained during all power modes. The following table compares the various power modes available.

For Run and Very Low Power Run (VLPR) modes there are corresponding Stop modes. Stop modes (VLPS, STOP1, STOP2) are similar to Arm sleep deep mode. VLPR operating mode can reduce runtime power when maximum bus frequency is not required to support application needs.

This chip cannot enter a stop mode directly from High Speed Run (HSRUN) mode. To enter a stop mode from HSRUN, the chip must first transition to Normal Run mode. After that, it can enter a stop mode.

The two primary modes of operation are Run, Stop. The Wait For Interrupt (WFI) instruction invokes Stop modes for the chip. The available power modes allow an application to consume only the power that is necessary for execution.

NOTE

See Arm documentation for more details on WFI instructions.

Table 39-1. Chip power modes

Chip mode	Description	Core mode	Normal recovery method
Normal Run	Default mode out of reset; on-chip voltage regulator is on.	Run	-
High Speed Run (HSRUN) ¹	Allows maximum performance of the chip. In this mode, the chip can operate at a higher frequency as compared to Normal Run mode but with restricted functionalities. See Module operation in available power modes for more details. See Internal clocking requirements for more details.	Run	-
Normal Stop (via WFI instruction)	Places the chip in static state. In this power mode, all registers are retained and LVD protection is maintained. <ul style="list-style-type: none"> • NVIC is disabled. • AWIC is used to wake up from interrupt. • Some peripheral clocks are stopped. See Module operation in available power modes for more details.	Sleep Deep	Interrupt
Very Low Power Run (VLPR)	On-chip voltage regulator is in a low power mode that supplies only enough power to run the chip at a reduced frequency. <ul style="list-style-type: none"> • Reduced-frequency flash memory access mode (1 MHz) • LVD off • SIRC provides a low power 4 MHz source for the core, the bus, and the peripheral clocks 	Run	-
Very Low Power Stop (VLPS, via WFI instruction)	Places the chip in a static state with Low Voltage Detect (LVD) operation off. This is the lowest-power mode in which pin interrupts are functional. <ul style="list-style-type: none"> • Some peripheral clocks are stopped. See Module operation in available power modes. • The LPTMR, RTC, and CMP can be used. • The NVIC is disabled. • The AWIC is used to wake from interrupt. • The on-chip voltage regulator is in a low power mode that supplies only the power needed to run the chip at a reduced frequency. • All SRAM is operational (content is retained and I/O states are maintained). 	Sleep Deep	Interrupt

1. HSRUN mode is not available in S32K14xW and S32K11x series of devices.

NOTE

Before disabling a module, its interrupts and DMA requests should be disabled.

39.3 Entering and exiting power modes

The WFI instruction invokes stop modes for the chip. The processor exits the low-power mode via an interrupt. See [Nested Vectored Interrupt Controller \(NVIC\) Configuration](#) for a description of interrupt operation and which peripherals can cause interrupts.

39.4 Clocking modes

The following sections describe the supported clocking modes on this chip.

39.4.1 Clock gating

To conserve power, most module clocks can be turned off by configuring the CGC field of the peripheral control registers in the PCC module. These fields are cleared after any reset, which disables the Protocol clock of the corresponding module. Before initializing a module, the corresponding field in the PCC peripheral control register needs to be set to enable the module clock. Be sure to disable the module before turning off the clock (see [Clock Distribution](#) and [PCC](#) for details).

39.4.2 Stop mode options

This chip has two Stop modes:

- STOP1
- STOP2

See the [STOPO](#) field in [Stop Control Register \(SMC_STOPCTRL\)](#) for more details.

When configured for STOP1, the core clocks, system clocks, and bus clocks are all gated.

When configured for STOP2, only the core and system clocks are gated, but the bus clock remains active. The bus masters and bus slaves clocked by the system clock enter Stop mode, but the bus slaves clocked by the bus clock remain in Run mode. The clock generators in the SCG and the PMC's on-chip regulator also remain in Run mode. The following can initiate an exit from STOP.

- Reset
- An asynchronous interrupt from a bus master (valid for STOP1)
- A synchronous interrupt from a bus slave clocked by the bus clock (valid for STOP2)

If configured, a DMA request (using the asynchronous DMA wake-up) can also be used to exit Stop for the duration of a DMA transfer before the chip transitions back into STOP2.

39.4.3 DMA wake-up

The DMA can be configured to wake up the device on a DMA request after it is placed in Stop mode. If this is supported by a peripheral instance then it is said to support Async DMA in the RM attachment 'S32K1xx_DMA_Interrupt_mapping.xlsx'. Wake-up is configured per DMA channel and is supported in the following low-power modes:

- Compute Operation
- Stop
- VLPS

When a DMA wake-up is detected in Stop, or VLPS, the chip initiates a normal exit from the low-power mode. This can include:

- Restoring the internal regulator and internal power switches
- Enabling the clock generators in the SCG
- Enabling the system, bus clocks and flash clock (but not the core clock)
- Negating the stop mode signal to the bus masters and bus slaves

The only difference is that the CPU will remain in low-power mode with the CPU clock disabled.

During Compute Operation, a DMA wake-up will initiate a normal exit. This includes enabling the clocks and negating the Stop mode signal to the bus masters and bus slaves. The core clock always remains enabled during Compute Operation.

Since the DMA wake-up will enable clocks and negate Stop-mode signals to all bus masters and slaves, software must ensure that bus masters and slaves that are not involved with the DMA wake-up and transfer remain in a known state. This can be accomplished by disabling the modules before entry into the low-power mode or by setting the Doze enable bit in selected modules.

After the DMA request that initiated the wake-up negates, and the DMA completes the current transfer, the chip transitions back to the original low-power mode. This includes requesting all non-CPU bus masters to enter Stop mode, then requesting bus slaves to enter Stop mode. In Stop and VLPS modes, the SCG and PMC would then also enter their appropriate modes.

NOTE

If the requested DMA transfer cannot cause the DMA request to negate, the device will remain in a higher power state until the low power mode is fully exited.

An enabled DMA wake-up can cause an aborted entry into low-power mode if the DMA request asserts during the Stop-mode entry sequence (or reentry if the request asserts during a DMA wake-up) and can cause the SMC to assert its Stop Abort flag in case VLPS mode entry was happening. After the DMA wake-up completes, entry into low power mode starts.

See [Aborted very low power stop mode entry](#) for details on aborted low power mode entry.

An interrupt that occurs during a DMA wake-up causes an immediate exit from the low-power mode (this is optional for Compute Operation) without impacting the DMA transfer.

A DMA wake-up can be generated by either a synchronous or asynchronous DMA request. Not all peripherals can generate an asynchronous DMA request in stop modes. In general, if a peripheral can generate synchronous DMA requests and also supports asynchronous interrupts in stop modes, it can generate an asynchronous DMA request.

NOTE

DMA Enable Asynchronous Request in Stop Register (DMA_EARS) is used to configure asynchronous DMA request for each channel.

39.4.4 Compute Operation (CPO)

Compute Operation (CPO) is an execution or compute-only mode of operation that keeps the CPU enabled with full access to the SRAM and flash memory read port, but places all other bus masters and bus slaves into their stop mode. CPO can be enabled in Run, HSRUN, or VLPR modes.

NOTE

Do not enter any stop mode without first exiting CPO. Before entering to CPO mode, software should make sure that all ongoing communication should be completed.

Because CPO reuses stop-mode logic (including the staged entry with bus masters disabled before bus slaves), any bus master or bus slave that can remain functional in Stop mode also remains functional in CPO. This includes generation of asynchronous interrupts and DMA requests. When enabling CPO in Run mode, module functionality

for bus masters and slaves is the equivalent of Stop mode. When enabling CPO in VLPR mode, module functionality for bus masters and slaves is the equivalent of VLPS mode. CPO does not affect the SCG, PMC, SRAM, and flash memory read port, although the flash memory register interface is disabled.

During CPO, the AIPS peripheral space is disabled, and attempted accesses generate bus errors. The Private Peripheral Bus (PPB) — including the MCM, System Control Space (SCS) (for NVIC), and SysTick — remains accessible during CPO. Although access to the GPIO registers is supported, the GPIO port data input registers do not return valid data since clocks to the Port Control and Interrupt modules are disabled. By writing to the GPIO port data output registers, it is possible to control those GPIO ports that are configured as output pins.

CPO is controlled by the MCM's CPO register, which can be accessed only by CPU in K14x. DMA can also access it in K11x since MCM is out of PPB memory map of CM0+ Core in K11x. Setting or clearing the MCM's CPOREQ field initiates entry or exit into CPO. CPO can also be configured to exit automatically when it detects an interrupt, which is required in order to service most interrupts. Only the core system interrupts (NMI and SysTick are exceptions) and any edge sensitive interrupts can be serviced without exiting CPO.

When entering CPO, the CPOACK status field indicates when entry has completed. When exiting CPO in Run mode, CPOACK negates immediately. When exiting CPO in VLPR mode, the exit is delayed. This allows the PMC to manage the change in power consumption. This delay means CPOACK is polled to determine when the AIPS peripheral space can be accessed without generating a bus error.

The DMA wake-up is also supported during CPO and causes CPOACK status to clear and the AIPS peripheral space to be accessible for the duration of the DMA wake-up. After the DMA wake-up completes, the chip transitions back into CPO.

NOTE

Peripherals (like External QSPI flash memory) operating on SYS_CLK should not be accessed in CPO mode.

39.4.5 Peripheral Doze

Several peripherals support Peripheral Doze mode. In this mode, a register field can be used to disable the peripheral for the duration of a low-power mode.

Peripheral Doze is defined to include all of the modes of operation as follows:

- The CPU is in Stop mode, including the entry sequence and for the duration of a DMA wake-up.
- The CPU is in Compute Operation, including the entry sequence and for the duration of a DMA wake-up.

It can also be used to disable selected bus slaves immediately on entry into any stop mode (or CPO), instead of waiting for the bus masters to acknowledge the entry as part of the stop entry sequence. Finally, it can be used to disable selected bus masters or slaves that should remain inactive during a DMA wake-up.

39.5 Power mode transitions

The following figure shows the power mode transitions. Any reset always brings the chip back to the Normal Run state. In run, stop modes active power regulation is enabled. The VLPR modes offer a lower power operating mode than normal modes. VLPR is limited in frequency.

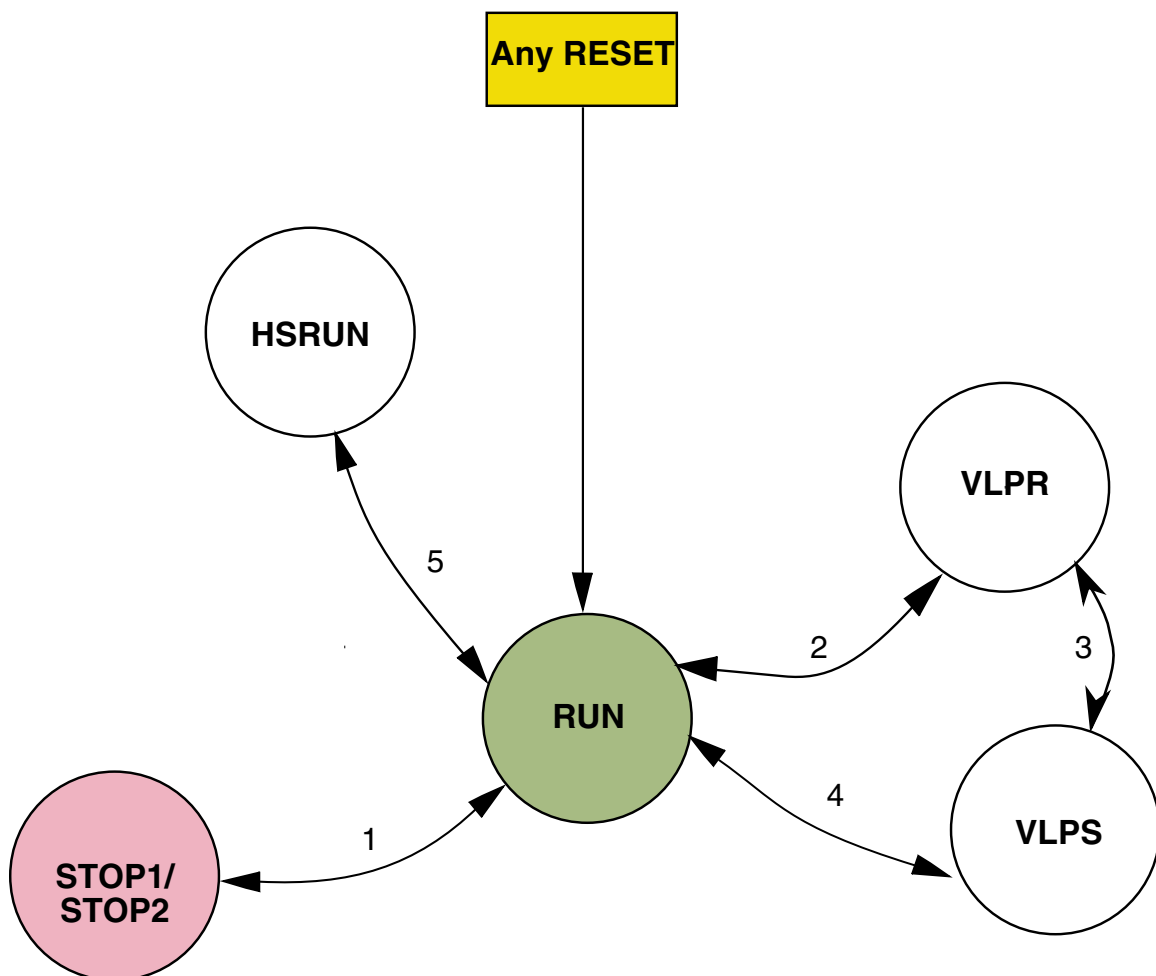

Figure 39-1. Power mode state transition diagram

NOTE

See [Figure 40-1](#) in the SMC chapter for more detailed mode transition conditions.

39.6 Shutdown sequencing for power modes

When entering stop or other low-power mode, clocks are shut off in an orderly sequence to safely place the chip in the targeted low-power state. All low-power entry sequences are initiated by the core executing a WFI instruction. The Arm core's outputs, SLEEPDEEP and SLEEPING, trigger entry to the various low-power modes:

- Low power modes equate to: SLEEPING & SLEEPDEEP

When entering low power modes, the chip performs the following sequence:

Table 39-2. Low power entry sequence

Step	Action
1	The chip immediately shuts off core and system clocks to the Arm Cortex-M4 core.
2	The chip polls the stop-acknowledge indications from the non-core crossbar masters (DMA), supporting peripherals (SPI, PIT), and the flash memory controller for indications that system clocks, bus clock, and/or flash memory clock need to be left enabled to complete a previously initiated operation, effectively stalling entry to the targeted low power mode. When all acknowledges are detected, system clock, bus clock and flash memory clock are turned off simultaneously.
3	The SCG and Mode Controller shut off clock sources and/or the internal supplies driven from the internal regulator as defined for the targeted low power mode.

The debugger modules support transitions from Stop, VLPS back to a halted state when the debugger is enabled. This transition is initiated by setting the Debug Request field in the MDM-AP control register. As part of this transition, system clocking is reestablished and is equivalent to Normal Run/VLPR mode clocking configuration.

39.7 Power mode restrictions on flash memory programming

The flash memory should not be programmed or erased while the chip is operating in:

- VLPR mode
- HSRUN mode

No FTFC commands of any type, including CSE commands (for CSEc parts), are available when the chip is in these modes.

39.8 Module operation in available power modes

Table 39-4 illustrates module functionality in each of the available modes.

Debug modules are discussed separately; see [Debug in low-power modes](#).

NOTE

S32K1xx device does not support WAIT, VLPW and low leakage modes (power gating mode).

Table 39-3 defines some frequently-used terms and abbreviations in Table 39-4.

Table 39-3. Terms and abbreviations

Term	Definition
Async operation	Fully functional with alternate clock source (if the selected clock source remains enabled).
FF	Full functionality. In VLPR the system frequency is limited, but if a module does not have a functional limitation, it is still listed as FF.
Low power	Memory is powered to retain contents in a lower-power state.
OFF	Module and clock sources are disabled.
Powered	Memory is powered to retain contents.
Wake-up	Modules can serve as a wake-up source for the chip.

Table 39-4. Module operation in available power modes

Modules	VLPR ¹	STOP(STOP1/ STOP2)	VLPS ¹	RUN	HSRUN
Core Modules					
NVIC	FF	OFF	OFF	FF	FF
SYSTICK module	FF	OFF	OFF	FF	FF
System Modules					
System Mode Controller/ Power Mangement Controller	FF	FF	FF	FF	FF
Regulator	Low power mode (LPM)	Full performance Mode (FPM)	Low power mode (LPM)	Full performance Mode (FPM)	Full performance Mode (FPM)
LVD/LVR	LVD Disabled/LVR active	Both Active	LVD Disabled/LVR Active	Both Active	Both Active
Brown-out Detection	FF	FF	FF	FF	FF
DMA	FF	Async operation	Async operation	FF	FF
Watchdog	FF	Async operation (STOP bit	Async operation (STOP bit needs to be set). Async Wakeup	FF	FF

Table continues on the next page...

Table 39-4. Module operation in available power modes (continued)

Modules	VLPR ¹	STOP(STOP1/ STOP2)	VLPS ¹	RUN	HSRUN
	(Only SIRC and LPO Clock as source)	needs to be set) STOP1, FF in STOP2			
EWM	FF (LPO Clock as source)	Static in STOP1, FF in STOP2	OFF	FF	FF
Clocks					
128 kHz LPO	FF	FF	FF	FF	FF
PLL	OFF ²	FF	OFF ²	FF	FF
SIRC	FF	FF	FF	FF	FF
FIRC	OFF ²	FF	OFF ²	FF	FF
System oscillator (OSC)	OFF ²	FF	OFF ²	FF	FF
SCG	Only SIRC is available	All clock sources are available	Only SIRC is available	All clock sources are available	All clock sources are available
Core clock	f _{SYS} (VLPR) ³ (SIRC as source)	OFF	OFF	f _{SYS} (Normal RUN mode) ³	f _{SYS} (High Speed RUN mode) ³
Flash clock	f _{Flash} (VLPR) ³ (SIRC as source)	OFF in STOP1, Available in STOP2	OFF	f _{Flash} (Normal RUN mode) ³	f _{Flash} (High Speed RUN mode) ³
System clock	f _{SYS} (VLPR) ³ (SIRC as source)	OFF	OFF	f _{SYS} (Normal RUN mode) ³	f _{SYS} (High Speed RUN mode) ³
Bus clock	f _{BUS} (VLPR) ³ (SIRC as source)	OFF in STOP1, Available in STOP2	OFF	f _{BUS} (Normal RUN mode) ³	f _{BUS} (High Speed RUN mode) ³
Memory and memory interfaces					
Flash memory	Only read operation can be done (1 MHz max). No FTFC commands of any type, including CSE commands (for CSEc parts), are available.	Low power (no read and program/erase)	Low power (no read and program/erase)	FF	Only read operation can be done. No FTFC commands of any type, including CSE commands (for CSEc parts), are available.
System RAM (SRAM_U and SRAM_L)	Low power (read and write operation)	Low power (no read and write)	Low power (no read and write)	FF	FF
Cache	Low power (read and write operation)	Low power (no read and write)	Low power (no read and write)	FF	FF

Table continues on the next page...

Table 39-4. Module operation in available power modes (continued)

Modules	VLPR ¹	STOP(STOP1/ STOP2)	VLPS ¹	RUN	HSRUN
FlexMemory as EEPROM Emulation	Low power (read and write operation). Only read operation can be done. No FTFC commands.	Low power (no read and write)	Low power (no read and write)	FF	Only read operation can be done. No FTFC commands.
FlexMemory (FlexRAM as traditional SRAM)	Low power (read and write operation)	Low power (no read and write)	Low power (no read and write)	FF	FF
ENET	FF (only SIRC as a source)	Magic Packet Wakeup supported in both STOP1 and STOP1	OFF	FF	FF
QuadSPI	FF (only SIRC as a source)	OFF in STOP1 , FF in STOP2(when BUS_CLK clock source is selected)	OFF	FF	FF
SAI	FF (only SIRC as a source)	OFF in STOP1 , FF in STOP2	OFF	FF	FF
Communication interfaces					
LPUART	FF (only SIRC as a source)	Async operation in STOP1, FF in STOP2	Async operation	FF	FF
LPSPi	FF (only SIRC as a source)	Async operation in STOP1, FF in STOP2	Async operation	FF	FF
LPI2C	FF (only SIRC as a source)	Async operation in STOP1, FF in STOP2	Async operation	FF	FF
FlexIO	FF (only SIRC as a source)	Async operation in STOP1, FF in STOP2	OFF	FF	FF
CAN	FF (only SIRC as a source)	PNET supported in both STOP1 and STOP2 for CAN0	OFF	FF	FF
Safety					
CRC	FF	OFF in STOP1 Available in STOP2	OFF	FF	FF

Table continues on the next page...

Table 39-4. Module operation in available power modes (continued)

Modules	VLPR ¹	STOP(STOP1/ STOP2)	VLPS ¹	RUN	HSRUN
Timers					
FTM	FF (Only SIRC as a source)	OFF	OFF	FF	FF
LPIT	FF (Only SIRC and LPO clock as source)	Async operation in STOP1, FF in STOP2	Async operation	FF	FF
PDB	FF (Only SIRC as source)	OFF	OFF	FF	FF
LPTMR	FF (Only SIRC as a source)	Async operation in STOP1, FF in STOP2	Async operation	FF	FF
RTC	FF (Only SIRC as a source)	Async operation in STOP1, FF in STOP2	FF	FF	FF
Analog					
12-bit ADC	FF (Only SIRC as a source)	OFF in STOP1, FF in STOP2	OFF	FF	FF
CMP	LS compare only	HS or LS compare FF in STOP2	LS compare only	FF	FF
Human Machine Interface					
GPIO/PORT	FF	Async operation in STOP1, FF in STOP2	OFF ⁴	FF	FF

1. PMC_REGSC[BIASEN] must be set to 1 when using VLP* modes.
2. Module must be disabled by software in RUN mode before any mode transition.
3. See device datasheet for details
4. Device can support ASYNC wakeup from VLPS through GPIO. Refer to table [AWIC stop and VLPS wake-up sources for details](#)

39.9 QuadSPI, Ethernet, and SAI operation

The application should ensure that the voltage is in the range of 3.3 V \pm 10% during a running application of QuadSPI, Ethernet, and SAI. If the external supply voltage is not in the range of 3.3 V \pm 10%, then it could lead to erroneous communication. In case S32K148 is being used for an application not using QuadSPI, Ethernet, and SAI, then the on chip voltage monitor ensures the operation as per the specifications present in the S32K1xx Datasheet (See table LVR, LVD and POR operating requirements).

Chapter 40

System Mode Controller (SMC)

40.1 Introduction

The System Mode Controller (SMC) is responsible for sequencing the system into and out of all low-power Stop and Run modes.

Specifically, it monitors events to trigger transitions between power modes while controlling the power, clocks, and memories of the system to achieve the power consumption and functionality of that mode.

This chapter describes all the available low-power modes, the sequence followed to enter/exit each mode, and the functionality available while in each of the modes.

The SMC is able to function during even the deepest low power modes.

See [AN4503: Power Management for Kinetis MCUs](#) for further details on using the SMC.

40.2 Modes of operation

The Arm CPU has three primary modes of operation:

- Run
- Sleep
- Deep Sleep

The WFI instruction is used to invoke Sleep and Deep Sleep modes. Run and Stop are the common terms used for the primary operating modes. The following table shows the translation between the Arm CPU mode and the MCU power modes. RUN is mapped to RUN/VLPR and Deep Sleep is mapped to STOP/VLPS.

Modes of operation

Arm CPU mode	MCU mode
RUN	RUN/VLPR
Deep Sleep	Stop/VLPS

In addition, MCUs also augment Stop and Run modes in a number of ways. The power management controller (PMC) contains a run and a stop mode regulator. Run regulation is used in normal run and stop modes. Stop mode regulation is used during all very low power and low leakage modes. During stop mode regulation, the bus frequencies are limited in the very low power modes.

The SMC provides the user with multiple power options. The Very Low Power Run (VLPR) mode can drastically reduce run time power when maximum bus frequency is not required to handle the application needs. From Normal Run mode, the Run Mode (RUNM) field can be modified to change the MCU into VLPR mode when limited frequency is sufficient for the application. From VLPR mode, a corresponding stop (VLPS) mode can be entered.

Depending on the needs of the user application, a variety of stop modes are available that allow the state retention, partial power down or full power down of certain logic and/or memory. I/O states are held in all modes of operation. Several registers are used to configure the various modes of operation for the device.

The following table describes the power modes available for the device.

Table 40-1. Power modes

Mode	Description
RUN	The MCU can be run at full speed and the internal supply is fully regulated, that is, in run regulation. This mode is also referred to as Normal Run mode.
HSRUN	The MCU can be run at a faster frequency compared with RUN mode and the internal supply is fully regulated. See the Power Management chapter for details about the maximum allowable frequencies.
STOP	The core clock is gated off. There are two variants of stop mode - STOP1 and STOP2 . In STOP1 system clock as well as bus clocks are gated . In STOP2 bus clocks keep running whereas system clocks are gated.
VLPR	The core, system, bus, and flash clock maximum frequencies are restricted in this mode. See the Power Management chapter for details about the maximum allowable frequencies.
VLPS	The core clock is gated off. System clocks to other masters and bus clocks are gated off after all stop acknowledge signals from supporting peripherals are valid.

NOTE

If the system clock is changed during the mode transition, the recommendation is to stall the communications for all the peripherals.

40.3 Memory map and register descriptions

Information about the registers related to the system mode controller can be found here.

NOTE

- Bit fields related to HSRUN are Reserved for S32K14xW and S32K11x variants.
- The read of the SMC registers is affected during EEERAM commands. For more information see note 'During execution of the SetRAM 0xFF' in [Chip-specific FTFC information](#).

Different SMC registers reset on different reset types. Each register's description provides details. For more information about the types of reset on this chip, refer to the Reset section details.

NOTE

The SMC registers can be written only in supervisor mode. Write accesses in user mode are blocked and will result in a bus error.

NOTE

Before executing the WFI instruction, the last register written to must be read back. This ensures that all register writes associated with setting up the low power mode being entered have completed before the MCU enters the low power mode. Failure to do this may result in the low power mode not being entered correctly.

SMC memory map

Address offset (hex)	Register name	Width (in bits)	Access	Reset value	Section/ page
0	SMC Version ID Register (SMC_VERID)	32	R	0100_0000h	40.3.1/1156
4	SMC Parameter Register (SMC_PARAM)	32	R	See section	40.3.2/1157
8	Power Mode Protection register (SMC_PMPROT)	32	R/W	0000_0000h	40.3.3/1158
C	Power Mode Control register (SMC_PMCTRL)	32	R/W	0000_0000h	40.3.4/1159
10	Stop Control Register (SMC_STOPCTRL)	32	R/W	0000_0003h	40.3.5/1161
14	Power Mode Status register (SMC_PMSTAT)	32	R	0000_0001h	40.3.6/1163

40.3.1 SMC Version ID Register (SMC_VERID)

Address: 0h base + 0h offset = 0h

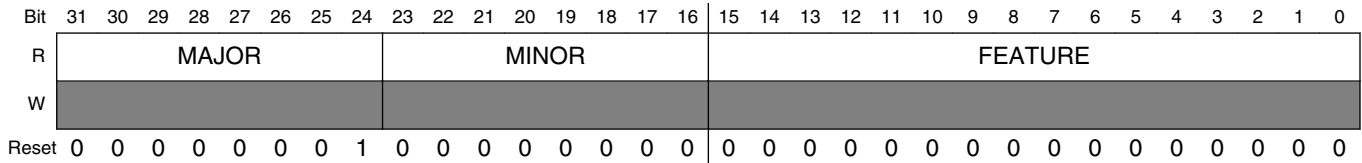

SMC_VERID field descriptions

Field	Description
31–24 MAJOR	Major Version Number This read only field returns the major version number for the module specification.
23–16 MINOR	Minor Version Number This read only field returns the minor version number for the module specification.
FEATURE	Feature Specification Number This read only field returns the feature set number. 0x0000 Standard features implemented

40.3.2 SMC Parameter Register (SMC_PARAM)

Address: 0h base + 4h offset = 4h

Bit	31	30	29	28	27	26	25	24	23	22	21	20	19	18	17	16
R	0															
W	[Reserved]															
Reset	0	0	0	0	0	0	0	0	0	0	0	0	0	0	0	0
Bit	15	14	13	12	11	10	9	8	7	6	5	4	3	2	1	0
R	0								0	EVLLS0	ELLS2	0	ELLS	0	EHSRUN	
W	[Reserved]								[Reserved]	[Reserved]	[Reserved]	[Reserved]	[Reserved]	[Reserved]	[Reserved]	[Reserved]
Reset	0	0	0	0	0	0	0	0	0	0	0	0	0	0	0	1

SMC_PARAM field descriptions

Field	Description
31–8 Reserved	This field is reserved. This read-only field is reserved and always has the value 0.
7 Reserved	This field is reserved. This read-only field is reserved and always has the value 0.
6 EVLLS0	Existence of VLLS0 feature This static bit states whether or not the feature is available on the device. 0 The feature is not available. 1 The feature is available.
5 ELLS2	Existence of LLS2 feature This static bit states whether or not the feature is available on the device. 0 The feature is not available. 1 The feature is available.

Table continues on the next page...

SMC_PARAM field descriptions (continued)

Field	Description
4 Reserved	This field is reserved. This read-only field is reserved and always has the value 0.
3 ELLS	Existence of LLS feature This static bit states whether or not the feature is available on the device. 0 The feature is not available. 1 The feature is available.
2-1 Reserved	This field is reserved. This read-only field is reserved and always has the value 0.
0 EHSRUN	Existence of HSRUN feature This static bit states whether or not the feature is available on the device. 0 The feature is not available. 1 The feature is available.

40.3.3 Power Mode Protection register (SMC_PMPROT)

This register provides protection for entry into any low-power run or stop mode. The enabling of the low-power run or stop mode occurs by configuring the Power Mode Control register (PMCTRL).

The PMPROT register can be written only once after any system reset.

If the MCU is configured for a disallowed or reserved power mode, the MCU remains in its current power mode. For example, if the MCU is in normal RUN mode and AVLP is 0, an attempt to enter VLPR mode using PMCTRL[RUNM] is blocked and PMCTRL[RUNM] remains 00b, indicating the MCU is still in Normal Run mode.

NOTE

This register is reset on Chip Reset and by reset types that trigger Chip Reset. It is unaffected by reset types that do not trigger Chip Reset. See the Reset section details for more information.

Address: 0h base + 8h offset = 8h

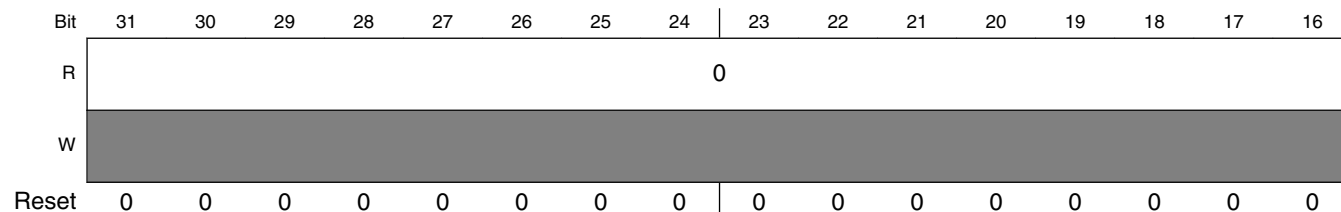

Bit	15	14	13	12	11	10	9	8	7	6	5	4	3	2	1	0
R	0								AHSRUN	0	AVLP	0	0	0	0	0
W	0								0	0	0	0	0	0	0	0
Reset	0	0	0	0	0	0	0	0	0	0	0	0	0	0	0	0

SMC_PMPROT field descriptions

Field	Description
31–8 Reserved	This field is reserved. This read-only field is reserved and always has the value 0.
7 AHSRUN	Allow High Speed Run mode Provided the appropriate control bits are set up in PMCTRL, this write-once field allows the MCU to enter High Speed Run mode (HSRUN). 0 HSRUN is not allowed 1 HSRUN is allowed
6 Reserved	This field is reserved. This read-only field is reserved and always has the value 0.
5 AVLP	Allow Very-Low-Power Modes Provided the appropriate control bits are set up in PMCTRL, this write-once field allows the MCU to enter any very-low-power mode (VLPR and VLPS). 0 VLPR and VLPS are not allowed. 1 VLPR and VLPS are allowed.
4 Reserved	This field is reserved. This read-only field is reserved and always has the value 0.
3 Reserved	This field is reserved. This read-only field is reserved and always has the value 0.
2 Reserved	This field is reserved. This read-only field is reserved and always has the value 0.
1 Reserved	This field is reserved. This read-only field is reserved and always has the value 0.
0 Reserved	This field is reserved. This read-only field is reserved and always has the value 0.

40.3.4 Power Mode Control register (SMC_PMCTRL)

The PMCTRL register controls entry into low-power Run and Stop modes, provided that the selected power mode is allowed via an appropriate setting of the protection (PMPROT) register.

NOTE

This register is reset on Chip POR and by reset types that trigger Chip POR. It is unaffected by reset types that do not

Memory map and register descriptions

trigger Chip POR. See the Reset section details for more information.

Address: 0h base + Ch offset = Ch

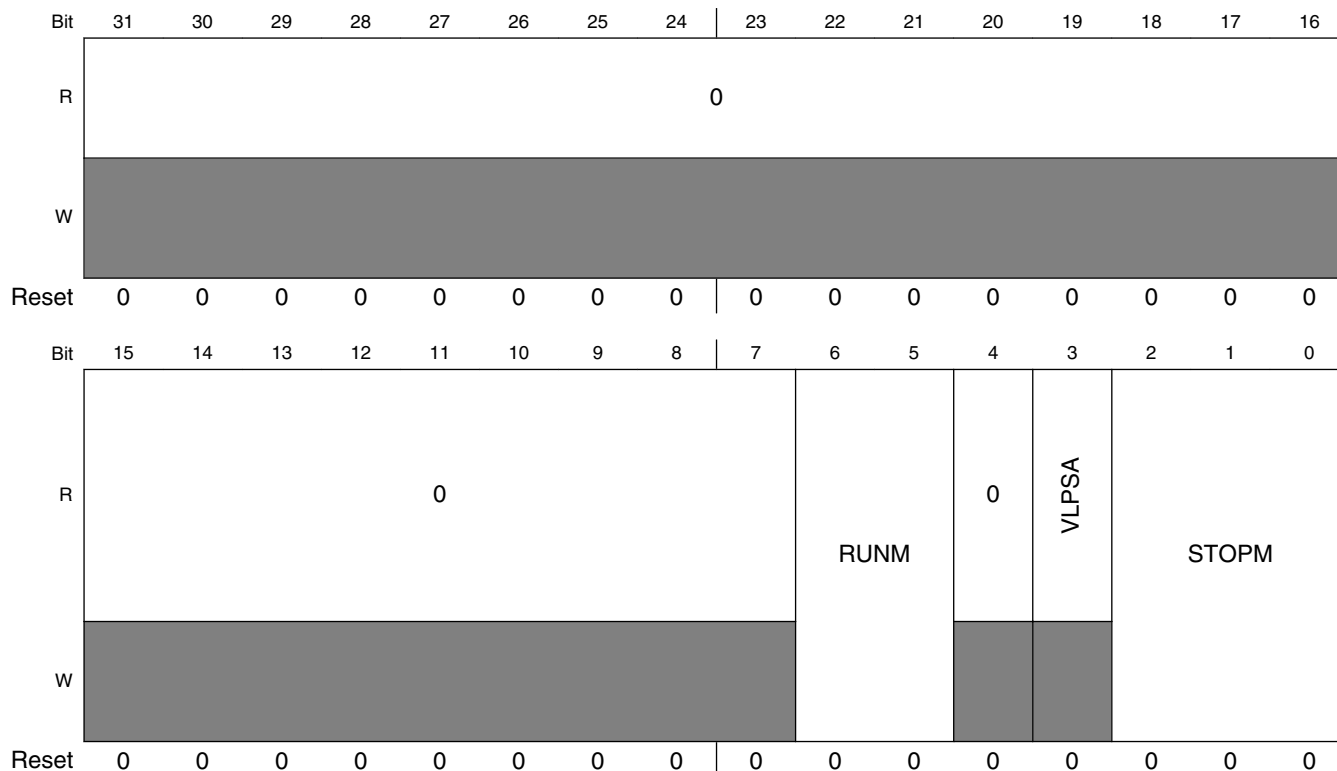

SMC_PMCTRL field descriptions

Field	Description
31–7 Reserved	This field is reserved. This read-only field is reserved and always has the value 0.
6–5 RUNM	<p>Run Mode Control</p> <p>When written, causes entry into the selected run mode. Writes to this field are blocked if the protection level has not been enabled using the PMPROT register.</p> <p>NOTE: RUNM may be set to VLPR only when PMSTAT=RUN. After being written to VLPR, RUNM should not be written back to RUN until PMSTAT=VLPR.</p> <p>NOTE: RUNM may be set to HSRUN only when PMSTAT=RUN. After being programmed to HSRUN, RUNM should not be programmed back to RUN until PMSTAT=HSRUN. Also, stop mode entry should not be attempted while RUNM=HSRUN or PMSTAT=HSRUN.</p> <p>When in any mode, any reset clears RUNM and causes the system to exit to normal RUN mode after the MCU exits its reset flow.</p> <p>00 Normal Run mode (RUN) 01 Reserved 10 Very-Low-Power Run mode (VLPR) 11 High Speed Run mode (HSRUN)</p>

Table continues on the next page...

SMC_PMCTRL field descriptions (continued)

Field	Description
4 Reserved	This field is reserved. This read-only field is reserved and always has the value 0.
3 VLPSA	Very Low Power Stop Aborted When set, this read-only status bit indicates an interrupt occurred during the previous stop mode entry sequence, preventing the system from entering that mode. This field is cleared by reset or by hardware at the beginning of any stop mode entry sequence and is set if the sequence was aborted. NOTE: This bit will not get set if STOP1/STOP2 get aborted. 0 The previous stop mode entry was successful. 1 The previous stop mode entry was aborted.
STOPM	Stop Mode Control When written, controls entry into the selected stop mode when Sleep-Now or Sleep-On-Exit mode is entered with SLEEPDEEP=1 . Writes to this field are blocked if the protection level has not been enabled using the PMPROT register. After any system reset, this field is cleared by hardware on any successful write to the PMPROT register. NOTE: When set to STOP, the STOPO bits in the STOPCTRL register must be used to select the variants of stop - STOP1/STOP2. 000 Normal Stop (STOP) 001 Reserved 010 Very-Low-Power Stop (VLPS) 011 Reserved 101 Reserved 110 Reseved 111 Reserved

40.3.5 Stop Control Register (SMC_ STOPCTRL)

The STOPCTRL register provides various control bits allowing the user to fine tune power consumption during the stop mode selected by the STOPM field.

NOTE

This register is reset on Chip POR and by reset types that trigger Chip POR. It is unaffected by reset types that do not trigger Chip POR. See the Reset section details for more information.

Memory map and register descriptions

Address: 0h base + 10h offset = 10h

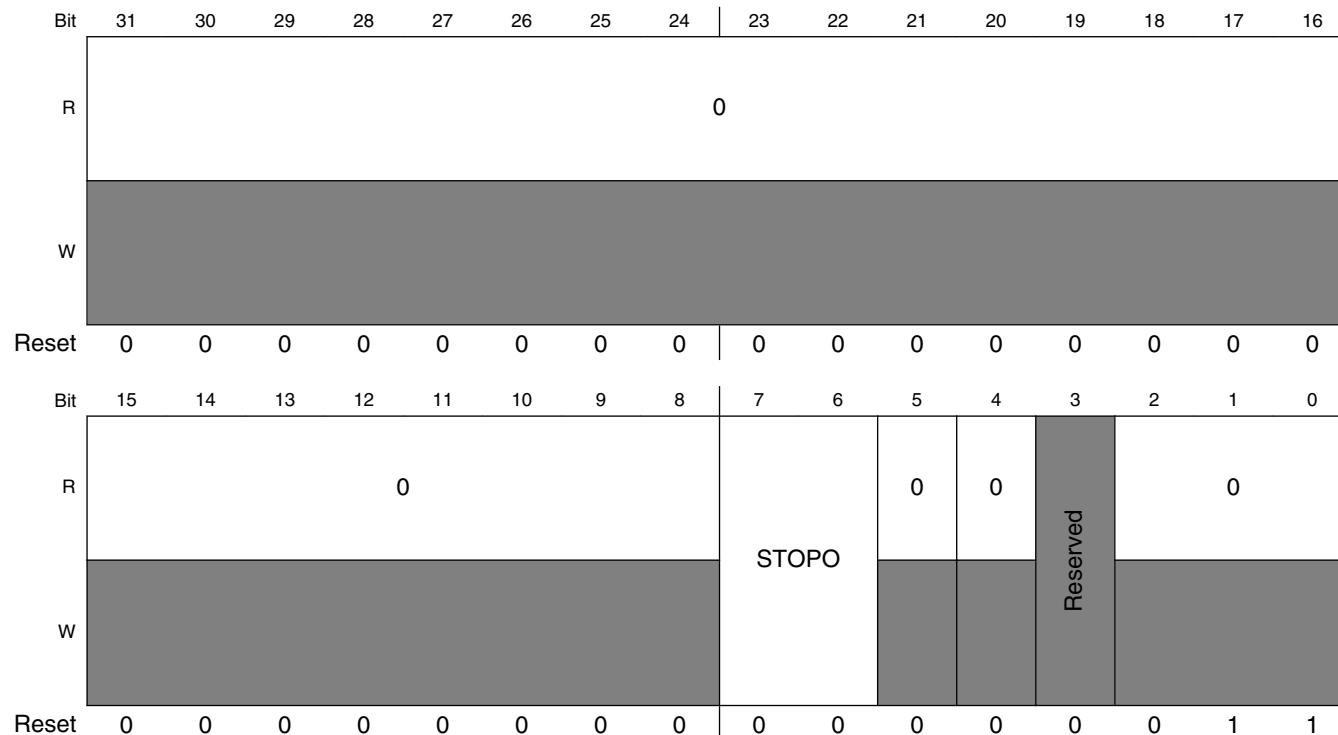

SMC_STOPCTRL field descriptions

Field	Description
31–8 Reserved	This field is reserved. This read-only field is reserved and always has the value 0.
7–6 STOPO	Stop Option These bits control stop operation when STOPM=STOP. When entering Stop mode from RUN mode, the PMC, SCG and flash remain fully powered, allowing the device to wakeup almost instantaneously at the expense of higher power consumption. In STOP2, only system clocks are gated allowing peripherals running on bus clock to remain fully functional. In STOP1, both system and bus clocks are gated. 00 Reserved 01 STOP1 - Stop with both system and bus clocks disabled 10 STOP2 - Stop with system clock disabled and bus clock enabled 11 Reserved
5 Reserved	This field is reserved. This read-only field is reserved and always has the value 0.
4 Reserved	This field is reserved. This read-only field is reserved and always has the value 0.
3 Reserved	This field is reserved. This bit is reserved for future expansion. Software should write 0 to this bit to maintain compatibility.
Reserved	This field is reserved. This read-only field is reserved and always has the value 0.

40.3.6 Power Mode Status register (SMC_PMSTAT)

PMSTAT is a read-only, one-hot register which indicates the current power mode of the system.

NOTE

This register is reset on Chip POR and by reset types that trigger Chip POR. It is unaffected by reset types that do not trigger Chip POR. See the Reset section details for more information.

When in any mode, any reset causes the system to exit to normal RUN mode after the MCU exits its reset flow. The PMSTAT field is then automatically updated to show RUN as the current power mode.

Address: 0h base + 14h offset = 14h

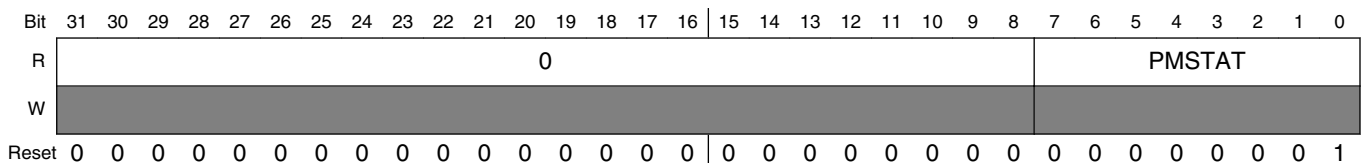

SMC_PMSTAT field descriptions

Field	Description
31–8 Reserved	This field is reserved. This read-only field is reserved and always has the value 0.
PMSTAT	<p>Power Mode Status</p> <p>NOTE: When debug is enabled, the PMSTAT will not update to STOP or VLPS NOTE: When a STOP mode is enabled, the PMSTAT will not update to STOP</p> <p>0000_0001 Current power mode is RUN. 0000_0010 Reserved. 0000_0100 Current power mode is VLPR. 0000_1000 Reserved. 0001_0000 Current power mode is VLPS. 0010_0000 Reserved 0100_0000 Reserved 1000_0000 Current power mode is HSRUN</p>

40.4 Functional description

40.4.1 Power mode transitions

The following figure shows the power mode state transitions available on the chip. Any reset always brings the MCU back to the normal RUN state.

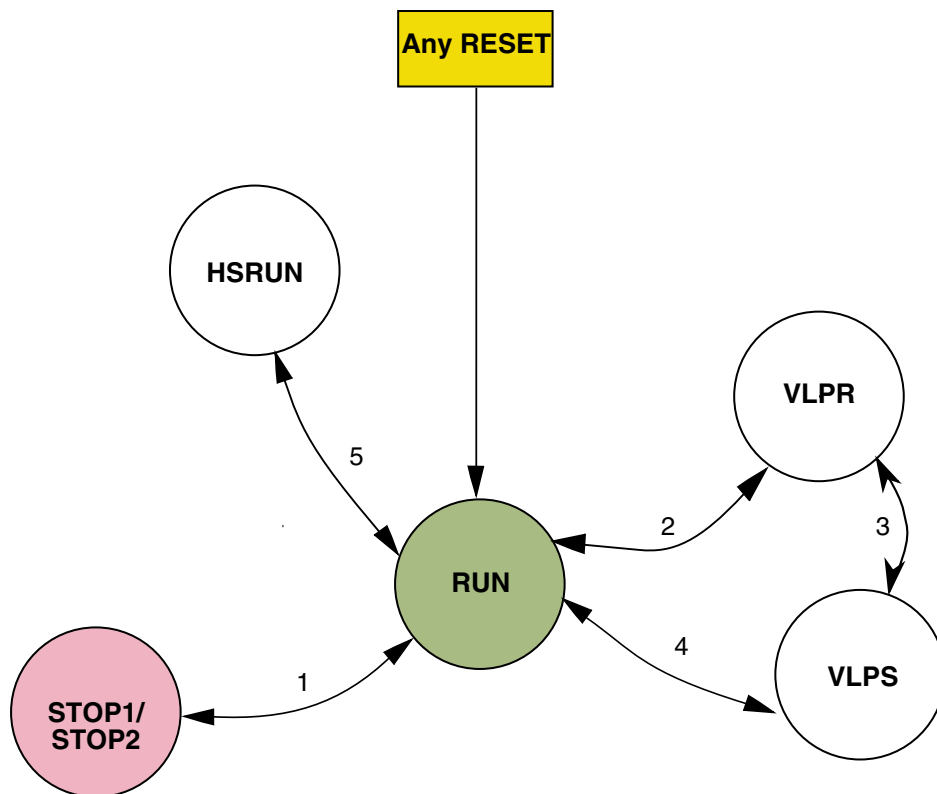

Figure 40-1. Power mode state diagram

The following table defines triggers for the various state transitions shown in the previous figure.

Table 40-2. Power mode transition triggers

Transition #	From	To	Trigger conditions
1	RUN	STOP	PMCTRL[RUNM]=00, PMCTRL[STOPM]=000 ¹ Sleep-now or sleep-on-exit modes entered with SLEEPDEEP set, which is controlled in System Control Register in Arm core.
	STOP	RUN	Interrupt or Reset
2	RUN	VLPR	The core, system, bus and flash clock frequencies and SCG clocking mode are restricted in this mode. See the Power Management chapter for the maximum allowable frequencies and SCG modes supported. Set PMPROT[AVLP]=1, PMCTRL[RUNM]=10.
	VLPR	RUN	Set PMCTRL[RUNM]=00 or

Table continues on the next page...

Table 40-2. Power mode transition triggers (continued)

Transition #	From	To	Trigger conditions
			Reset.
3	VLPR	VLPS	PMCTRL[STOPM]=000 or 010, Sleep-now or sleep-on-exit modes entered with SLEEPDEEP set, which is controlled in System Control Register in Arm core.
	VLPS	VLPR	Interrupt NOTE: If VLPS was entered directly from RUN (transition #4), hardware forces exit back to RUN and does not allow a transition to VLPR.
4	RUN	VLPS	PMPROT[AVLP]=1, PMCTRL[STOPM]=010, Sleep-now or sleep-on-exit modes entered with SLEEPDEEP set, which is controlled in System Control Register in Arm core.
	VLPS	RUN	Interrupt and VLPS mode was entered directly from RUN or Reset
5	RUN	HSRUN	Set PMPROT[AHSRUN]=1, PMCTRL[RUNM]=11.
	HSRUN	RUN	Set PMCTRL[RUNM]=00 or Reset

1. STOPO register must be configured to select the stop mode variant.

40.4.2 Power mode entry/exit sequencing

When entering or exiting low-power modes, the system must conform to an orderly sequence to manage transitions safely.

The SMC manages the system's entry into and exit from all power modes. This diagram illustrates the connections of the SMC with other system components in the chip that are necessary to sequence the system through all power modes.

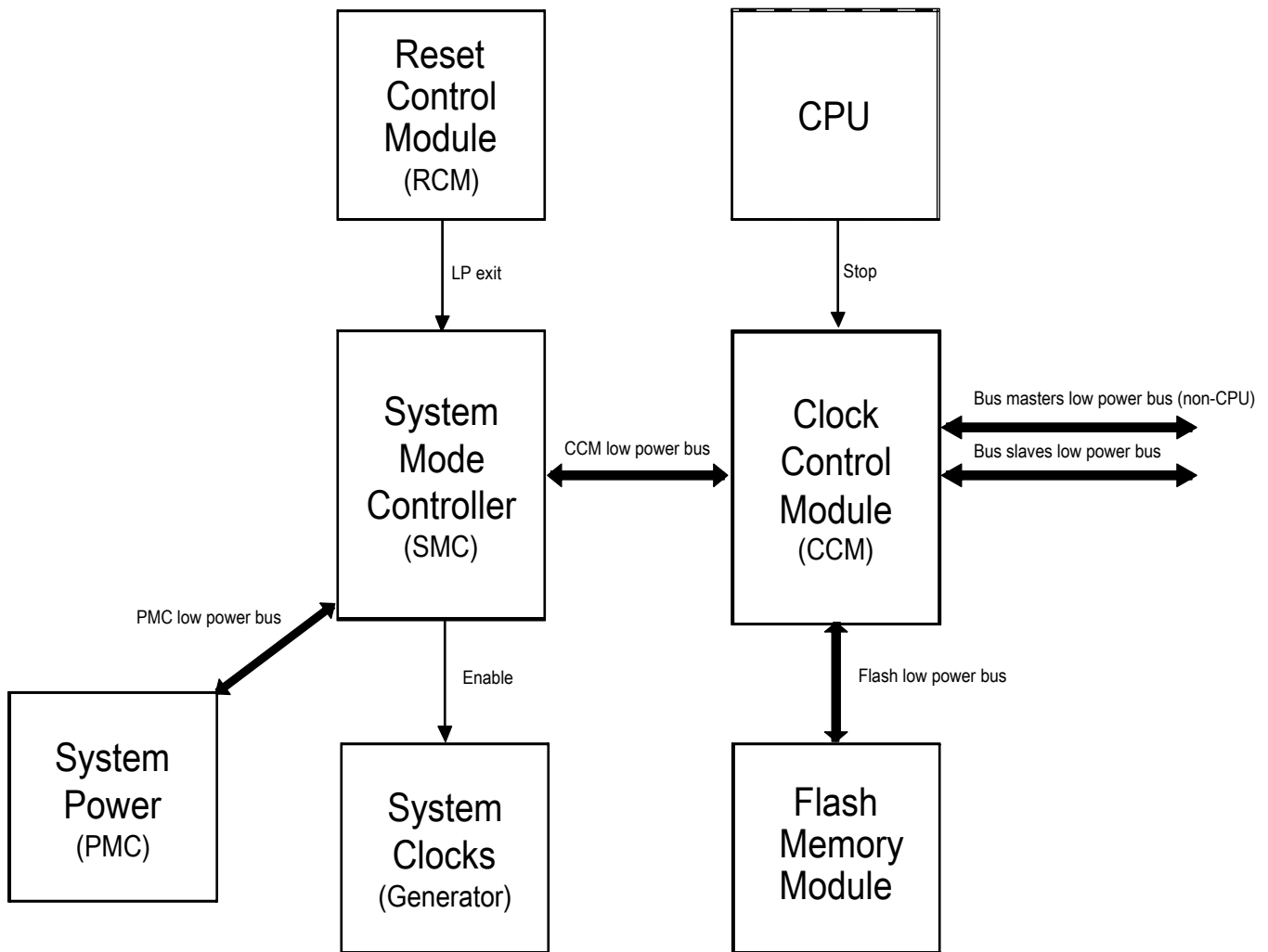

Figure 40-2. Low-power system components and connections

40.4.2.1 VLPS/Stop mode entry sequence

Entry into a low-power stop mode (Stop, VLPS) is initiated by a CPU executing the WFI instruction. After the instruction is executed, the following sequence occurs:

1. The CPU clock is gated off immediately.
2. Requests are made to all non-CPU bus masters to enter Stop mode.
3. After all masters have acknowledged they are ready to enter Stop mode, requests are made to all bus slaves to enter Stop mode.
4. After all slaves have acknowledged they are ready to enter stop mode, system and bus clocks are gated off depending on the target mode—VLPS/STOP1/STOP2. Note that, in STOP2 mode bus clocks will not be gated.
5. Additionally, for VLPS mode, clock generators are disabled in the SCG unless configured to be enabled. See [SCG](#) for the programming options.

- The on-chip regulator in the PMC and internal power switches are configured to meet the power consumption goals for the targeted low-power mode. This step is valid only for VLPS and not for STOP as in STOP mode the PMC is in Run regulation.

NOTE

Ensure that CMU is gated by its PCC.CGC before entering STOP/VLPS/CPO mode.

40.4.2.2 VLPS/Stop mode exit sequence

Exit from a low-power stop mode is initiated either by a reset or an interrupt event. The following sequence then executes to restore the system to a run mode (RUN or VLPR):

- The on-chip regulator in the PMC, clock generators and internal power switches are restored. This step is valid only for VLPS and not for STOP as in STOP mode the PMC is in Run regulation.
- System and bus clocks are enabled to all masters and slaves.
- The CPU clock is enabled and the CPU begins servicing the reset or interrupt that initiated the exit from the low-power stop mode.

40.4.2.3 Aborted very low power stop mode entry

If an interrupt occurs during a stop entry sequence, the SMC can abort the transition early and return to RUN mode without completely entering the stop mode. An aborted entry is possible only if the interrupt occurs before the PMC begins the transition to stop mode regulation. After this point, the interrupt is ignored until the PMC has completed its transition to stop mode regulation. When an aborted very low power stop mode entry sequence occurs, SMC_PMCTRL[VLPSA] is set to 1.

In case if the interrupt occurrence coincides with the device VLPS entry (or re-entry in async DMA), the VLPS will be aborted and device will enter RUN mode.

For example: Consider a scenario wherein async DMA feature is used to periodically transfer data using DMA and device is configured to wakeup after some particular amount of data transferred by DMA major loop interrupt. Herein as shown in below waveforms, after the last transfer device will face an abort scenario (as after the last async DMA transfer completion, the VLPS re-entry will happen, while DMA major loop interrupt will also occur at same time, thereby causing VLPS abort). It is to be noted here that the VLPS abort is happening due to interrupt while VLPS re-entry, there is no error or data loss in DMA transfer.

Functional description

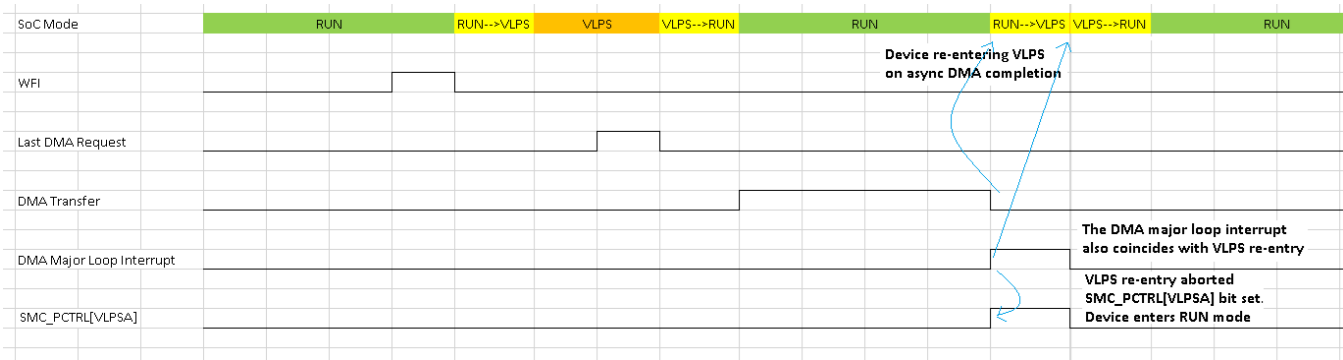

40.4.2.4 Transition from stop modes to Debug mode

The debugger module supports a transition from STOP and VLPS back to a Halted state when the debugger has been enabled. As part of this transition, system clocking is re-established and is equivalent to the normal RUN and VLPR mode clocking configuration.

40.4.3 Run modes

The run modes supported by this device can be found here.

- Run (RUN)
- Very Low-Power Run (VLPR)
- High Speed Run (HSRUN)

40.4.3.1 RUN mode

This is the normal operating mode for the device.

This mode is selected after any reset. When the Arm processor exits reset, it sets up the stack, program counter (PC), and link register (LR):

- The processor reads the start SP (SP_main) from vector-table offset 0x000
- The processor reads the start PC from vector-table offset 0x004
- LR is set to 0xFFFF_FFFF.

To reduce power in this mode, disable the clocks to unused modules.

40.4.3.2 Very-Low Power Run (VLPR) mode

In VLPR mode, the on-chip voltage regulator is put into a stop mode regulation state. In this state, the regulator is designed to supply enough current to the MCU over a reduced frequency. To further reduce power in this mode, disable the clocks to unused modules using their corresponding clock gating control bits in the PCC's registers.

Before entering this mode, the following conditions must be met:

- All clock monitors in the SCG must be disabled.
- The maximum frequencies of the system, bus, flash, and core are restricted. See the Power Management details about which frequencies are supported.
- Mode protection must be set to allow VLP modes, that is, PMPROT[AVLP] is 1.
- PMCTRL[RUNM] must be set to 10b to enter VLPR.
- Flash programming/erasing is not allowed.

NOTE

Do not increase the clock frequency while in VLPR mode, because the regulator is slow in responding and cannot manage fast load transitions. In addition, do not modify the clock source in the SCG module or any clock divider registers. Module clock enables in the PCC can be set, but not cleared.

To reenter Normal Run mode, clear PMCTRL[RUNM]. PMSTAT is a read-only status register that can be used to determine when the system has completed an exit to RUN mode. When PMSTAT=RUN, the system is in run regulation and the MCU can run at full speed in any clock mode. If a higher execution frequency is desired, poll PMSTAT until it is set to RUN when returning from VLPR mode.

Any reset always causes an exit from VLPR and returns the device to RUN mode after the MCU exits its reset flow.

40.4.3.3 High Speed Run (HSRUN) mode

In HSRUN mode, the on-chip voltage regulator remains in a run regulation state, but with a slightly elevated voltage output. In this state, the MCU is able to operate at a faster frequency compared to normal RUN mode. For the maximum allowable frequencies, see the Power Management chapter.

While in this mode, the following restrictions must be adhered to:

- The ratio of frequency between HSRUN mode and RUN mode for each system, bus, and flash clocks respectively must be less than or equal to 3.
- Stop mode entry is not supported from HSRUN.

Functional description

- Modifications to clock gating control bits are prohibited.
- Flash programming/erasing is not allowed.

To enter HSRUN mode (with 112 MHz SPLL as clock source):

1. Disable SPLL. Configure FIRC as the RUN mode and HSRUN mode clock source by writing 0011 to SCG_RCCR[SCS] and SCG_HCCR[SCS].
2. Configure PMPROT[AHSRUN] to allow HSRUN.
3. Write 11 to SMC_PMCTRL[RUNM] to enter HSRUN. (Now system will enter HSRUN mode with FIRC configured as system clock source).
4. Reconfigure PLL for 112MHz and enable it.
5. Switch to PLL as the clock source by configuring SCG_HCCR[SCS] as 0110.

Entry to HSRUN mode (with 80 MHz SPLL as clock source):

1. Configure SPLL at 80MHz as the RUN mode and HSRUN mode clock source by writing 0110 to SCG_RCCR[SCS] and SCG_HCCR[SCS].
2. Configure PMPROT[AHSRUN] to allow HSRUN.
3. Write 11 to SMC_PMCTRL[RUNM] to enter HSRUN.

Before increasing clock frequencies, the PMSTAT register should be polled to determine when the system has completed entry into HSRUN mode. To reenter normal RUN mode, clear PMCTRL[RUNM]. Any reset also clears PMCTRL[RUNM] and causes the system to exit to normal RUN mode after the MCU exits its reset flow.

40.4.4 Stop modes

The various stop modes are selected by setting the appropriate fields in PMPROT and PMCTRL. The selected stop mode is entered during the sleep-now or sleep-on-exit entry with the SLEEPDEEP bit set in the System Control Register in the ARM core.

The available stop modes are:

- Normal Stop (STOP)
- Very-Low Power Stop (VLPS)

40.4.4.1 STOP mode

STOP mode is entered via the sleep-now or sleep-on-exit with the SLEEPDEEP bit set in the System Control Register in the Arm core.

The SCG module can be configured to leave the reference clocks running.

A module capable of providing an asynchronous interrupt to the device takes the device out of STOP mode and returns the device to normal RUN mode. Refer to the device's Power Management chapter for peripheral, I/O, and memory operation in STOP mode. When an interrupt request occurs, the CPU exits STOP mode and resumes processing, beginning with the stacking operations leading to the interrupt service routine.

A system reset will cause an exit from STOP mode, returning the device to normal RUN mode via an MCU reset.

40.4.4.2 Very-Low-Power Stop (VLPS) mode

The two ways in which VLPS mode can be entered are listed here.

- Entry into stop via the sleep-now or sleep-on-exit with the SLEEPDEEP bit set in the System Control Register in the Arm core while the MCU is in VLPR mode and $PMCTRL[STOPM] = 010$ or 000 .
- Entry into stop via the sleep-now or sleep-on-exit with the SLEEPDEEP bit set in the System Control Register in the Arm core while the MCU is in normal RUN mode and $PMCTRL[STOPM] = 010$. When VLPS is entered directly from RUN mode, exit to VLPR is disabled by hardware and the system will always exit back to RUN.

In VLPS, the on-chip voltage regulator remains in its stop regulation state as in VLPR.

A module capable of providing an asynchronous interrupt to the device takes the device out of VLPS and returns the device to VLPR mode.

A system reset will also cause a VLPS exit, returning the device to normal RUN mode.

40.4.5 Debug in low power modes

When the MCU is secure, the device disables/limits debugger operation. When the MCU is unsecure, the Arm debugger can assert two power-up request signals:

- System power up, via SYSPWR in the Debug Port Control/Stat register
- Debug power up, via CDBGPWRUPREQ in the Debug Port Control/Stat register

When asserted while in RUN or VLPR, the mode controller drives a corresponding acknowledge for each signal, that is, both CDBGPWRUPACK and CSYSPWRUPACK. When both requests are asserted, the mode controller handles attempts to enter STOP and VLPS by entering an emulated stop state. In this emulated stop state:

- the regulator is in run regulation,
- the SCG-generated clock source is enabled,

Functional description

- all system clocks, except the core clock, are disabled,
- the debug module has access to core registers, and
- access to the on-chip peripherals is blocked.

Chapter 41

Power Management Controller (PMC)

41.1 Chip-specific PMC information

This module is available only in S32K1xx series of devices.

41.2 Modes supported

Wait and VLPW modes are not supported on this device. See [Module operation in available power modes](#) for details on available power modes.

41.2.1 LVD, LVW and LVR threshold levels

See section 'LVR, LVD and POR operating requirements' in *S32K1xx Datasheet* for LVD, LVW and LVR threshold levels.

41.3 Introduction

The PMC contains the internal voltage regulator, power on reset (POR) and the low voltage detect (LVD) system.

41.4 Features

The PMC features include:

- Internal voltage regulator offering a variety of power modes
- Active POR providing brown-out detect
- Low voltage reset (LVR)

- Low voltage detect supporting two low voltage trip points and interrupt
- Low power oscillator (LPO) with a typical frequency of 128 kHz

41.5 Modes of Operation

41.5.1 Full Performance Mode (FPM)

For the following Chip Power Modes, the internal voltage regulator is in full performance mode: HSRUN, RUN, STOP1, STOP2.

41.5.2 Low Power Mode (LPM)

For the following Chip Power Modes, the internal voltage regulator is in low power mode: VLPR and VLPS.

41.6 Low Voltage Detect (LVD) System

NOTE

The low voltage detect system (Low voltage detect flag, Low voltage warning flag and Low voltage detect reset generation) is disabled in low power mode.

This device includes a system to guard against low voltage conditions. This protects memory contents and controls MCU system states during supply voltage variations. The system is comprised of a power-on reset (POR) circuit and a LVD circuit with two trip points. The LVD is disabled upon entering low power mode.

Two flags are available to indicate the status of the low voltage detect system:

- The low voltage detect flag (LVDF) operates in a level sensitive manner. The LVDF bit is set when the supply voltage falls below the trip point (V_{LVD}). The LVDF bit is cleared by writing one to the LVDACK bit, but only if the internal supply has returned above the trip point; otherwise, the LVDF bit remains set. This flag gets

cleared on reset. The flag is only valid after the device has come out of the reset, at which point the flag will be set accordingly to the voltage level. If supply level is higher than LVD threshold then this flag stay cleared, else this flag gets set.

- The low voltage warning flag (LVWF) operates in a level sensitive manner. The LVWF bit is set when the supply voltage falls below the selected monitor trip point (V_{LVW}). The LVWF bit is cleared by writing one to the LVWACK bit, but only if the internal supply has returned above the trip point; otherwise, the LVWF bit remains set. This flag gets cleared on reset. The flag is only valid after the device has come out of the reset, at which point the flag will be set accordingly to the voltage level. If supply level is higher than LVW threshold then this flag stay cleared, else this flag gets set.

41.6.1 Low Voltage Reset (LVR) Operation

If the supply voltage falls below the reset trip point (V_{LVR}), a system reset will be generated.

NOTE

This device includes a system to guard against low voltage conditions. This protects memory contents and controls MCU system states during supply voltage variations.

If PMC_LVDSC1[LVDRE] is set and the supply voltage falls below V_{LVD} , a system reset will be generated.

PMC_LVDSC1[LVDF] will be cleared by system reset, so after recovery PMC_LVDSC1[LVDF] will read zero. Usage of PMC_LVDSC1[LVDF] is intended for LVD interrupt operation only (for example, PMC_LVDSC1[LVDIE] = 1 and PMC_LVDSC1[LVDRE] = 0).

41.6.2 LVD Interrupt Operation

By configuring the LVD circuit for interrupt operation (LVDIE set), PMC_LVDSC1[LVDF] is set and an LVD interrupt request occurs upon detection of a low voltage condition. The LVDF bit is cleared by writing one to the PMC_LVDSC1[LVDACK] bit, when the supply returns to above the trip point.

41.6.3 Low-voltage warning (LVW) interrupt operation

The LVD system contains a low-voltage warning flag (LVWF) to indicate that the supply voltage is approaching, but is above, the LVD voltage. The LVW also has an interrupt, which is enabled by setting the PMC_LVDSC2[LVWIE] bit. If enabled, an LVW interrupt request occurs when the LVWF is set. LVWF is cleared by writing one to the PMC_LVDSC2[LVWACK] bit, when the supply returns to above the trip point.

41.7 Memory Map and Register Definition

This sections provides the detailed information of all registers for the PMC module.

41.7.1 PMC register descriptions

NOTE

Different portions of PMC registers are reset only by particular reset types. Each register's description provides details.

NOTE

The PMC registers can be written only in supervisor mode. Write accesses in user mode are blocked and will result in a bus error.

41.7.1.1 PMC memory map

PMC base address: 4007_D000h

Offset	Register	Width (In bits)	Access	Reset value
0h	Low Voltage Detect Status and Control 1 Register (LVDSC1)	8	RW	Table 41-
1h	Low Voltage Detect Status and Control 2 Register (LVDSC2)	8	RW	00h
2h	Regulator Status and Control Register (REGSC)	8	RW	Table 41-
4h	Low Power Oscillator Trim Register (LPOTRIM)	8	RW	Table 41-1

41.7.1.2 Low Voltage Detect Status and Control 1 Register (LVDSC1)

41.7.1.2.1 Offset

Register	Offset
LVDSC1	0h

41.7.1.2.2 Function

This register contains status and control bits to support the low voltage detect function.

NOTE

When the internal voltage regulator is in low power mode, the LVD system is disabled, regardless of the PMC_LVDSC1 settings.

41.7.1.2.3 Diagram

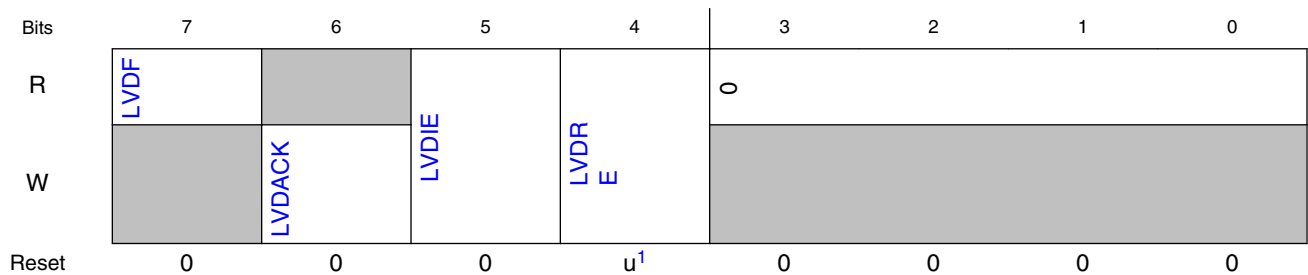

1. LVDRE = 0b after POR. Unaffected by reset.

41.7.1.2.4 Fields

Field	Function
7 LVDF	Low Voltage Detect Flag This bit's read-only status bit indicates a low-voltage detect event. The threshold voltage is V_{LVD} . 0b - Low-voltage event not detected 1b - Low-voltage event detected
6 LVDACK	Low Voltage Detect Acknowledge This write-only bit is used to acknowledge low voltage detection errors. Write 1 to clear LVDF. Read always return 0.
5 LVDIE	Low Voltage Detect Interrupt Enable This bit enables hardware interrupt requests for LVDF. 0b - Hardware interrupt disabled (use polling) 1b - Request a hardware interrupt when LVDF = 1

Table continues on the next page...

Memory Map and Register Definition

Field	Function
4 LVDRE	Low Voltage Detect Reset Enable This bit enables the low voltage detect events to generate a system reset. 0b - No system resets on low voltage detect events. 1b - If the supply voltage falls below V_{LVD} , a system reset will be generated.
3-0 —	Reserved

41.7.1.3 Low Voltage Detect Status and Control 2 Register (LVDSC2)

41.7.1.3.1 Offset

Register	Offset
LVDSC2	1h

41.7.1.3.2 Function

This register contains status and control bits to support the low voltage warning (LVW) function.

NOTE

When the internal voltage regulator is in low power mode, the LVD system is disabled regardless of the PMC_LVDSC2 settings.

41.7.1.3.3 Diagram

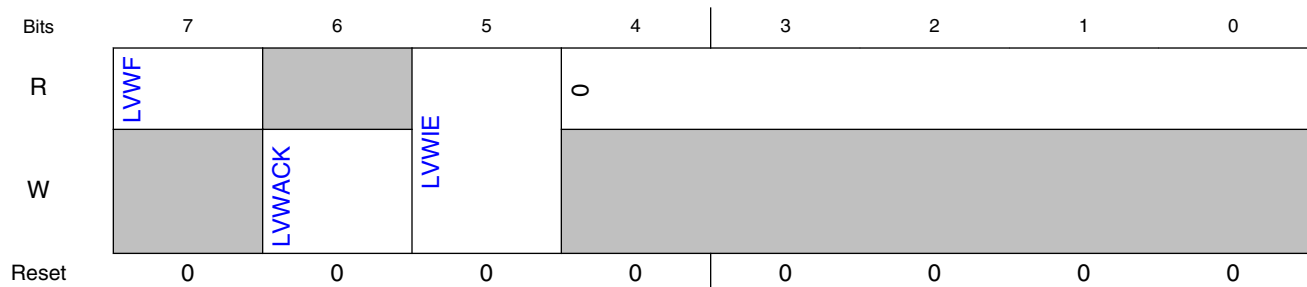

41.7.1.3.4 Fields

Field	Function
7 LVWF	Low-Voltage Warning Flag This bit read-only status bit indicates a low-voltage detect event. The threshold voltage is V_{LVW} . 0b - Low-voltage warning event not detected 1b - Low-voltage warning event detected
6 LVWACK	Low-Voltage Warning Acknowledge This write-only bit is used to acknowledge low voltage warning errors. Write 1 to clear LVWF. Reads always return 0.
5 LVWIE	Low-Voltage Warning Interrupt Enable This bit enables hardware interrupt requests for LVWF. 0b - Hardware interrupt disabled (use polling) 1b - Request a hardware interrupt when LVWF=1
4-0 —	Reserved

41.7.1.4 Regulator Status and Control Register (REGSC)

41.7.1.4.1 Offset

Register	Offset
REGSC	2h

41.7.1.4.2 Function

This register contains general control and status bits for the regulator and the LPO.

41.7.1.4.3 Diagram

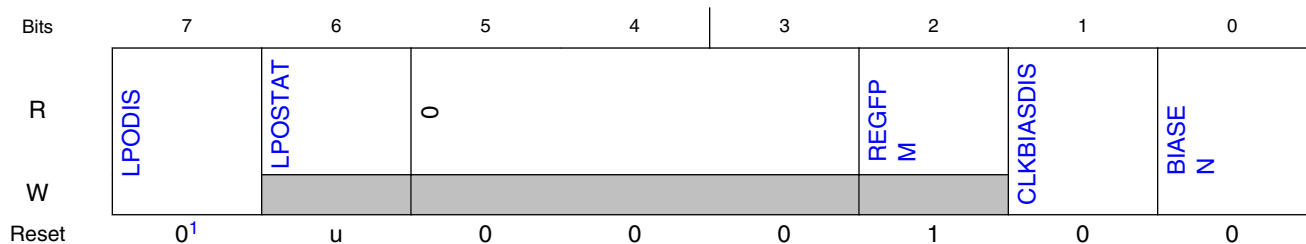

1. Cleared on power on reset, unaffected by other reset.

41.7.1.4.4 Fields

Field	Function
7 LPODIS	<p>LPO Disable Bit</p> <p>This bit enables or disable the low power oscillator.</p> <p>NOTE: After disabling the LPO a time of 2 LPO clock cycles is required before it is allowed to enable it again. Violating this waiting time of 2 cycles can result in malfunction of the LPO.</p> <p>0b - Low power oscillator enabled 1b - Low power oscillator disabled</p>
6 LPOSTAT	<p>LPO Status Bit</p> <p>This bit shows the status of the LPO clock to be either in high phase (logic 1) or low phase (logic 0) of the clock period. Software can poll this status bit to measure actual LPO clock frequency and eventually use the LPOTRIM[4:0] register to change the LPO frequency.</p> <p>0b - Low power oscillator in low phase 1b - Low power oscillator in high phase</p>
5-3 —	Reserved
2 REGFPM	<p>Regulator in Full Performance Mode Status Bit</p> <p>This read-only bit provides the current status of the internal voltage regulator.</p> <p>0b - Regulator is in low power mode or transition to/from 1b - Regulator is in full performance mode</p>
1 CLKBIASDIS	<p>Clock Bias Disable Bit</p> <p>This bit disables the bias currents and reference voltages for some clock modules in order to further reduce power consumption in VLPS mode.</p> <p>Note: While using this bit, it must be ensured that respective clock modules are disabled in VLPS mode. Else, severe malfunction of clock modules will happen.</p> <p>0b - No effect 1b - In VLPS mode, the bias currents and reference voltages for the following clock modules are disabled: SIRC, FIRC, PLL. (if available on device)</p>
0 BIASEN	<p>Bias Enable Bit</p> <p>This bit enables source and well biasing for the core logic in low power mode. In full performance mode this bit has no effect. This is useful to further reduce MCU power consumption in low power mode. This bit must be set to 1 when using VLP* modes.</p> <p>0b - Biasing disabled, core logic can run in full performance 1b - Biasing enabled, core logic is slower and there are restrictions in allowed system clock speed (see Data Sheet for details)</p>

41.7.1.5 Low Power Oscillator Trim Register (LPOTRIM)

41.7.1.5.1 Offset

Register	Offset
LPOTRIM	4h

41.7.1.5.2 Function

This register contains the period trimming bits for the low power oscillator.

Table 41-1. Trimming effect of LPOTRIM[4:0]

LPOTRIM[4:0]	Decimal	Period of LPO clock
10000	-16	lowest
10001	-15	increasing
...	...	
11110	-2	
11111	-1	
00000	0	typical 128 kHz
00001	+1	increasing
...	...	
01110	+14	
01111	+15	highest

NOTE

The LPO trimming bits represent signed values. Starting from -16 the period of the LPO clock will increase monotonically (for example, frequency decreases monotonically).

41.7.1.5.3 Diagram

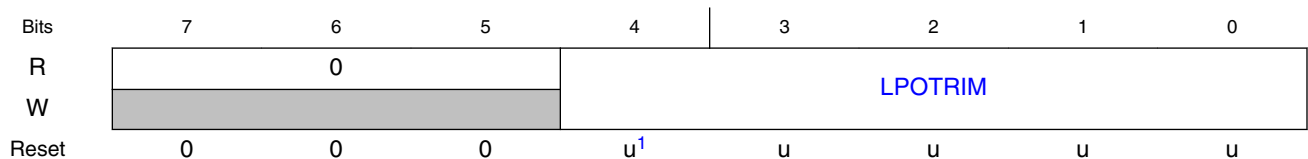

1. Automatically loaded from flash memory IFR after any reset.

41.7.1.5.4 Fields

Field	Function
7-5 —	Reserved
4-0 LPOTRIM	LPO trimming bits These bits are used for trimming the frequency of the low power oscillator. See the table above for trimming effect.

Chapter 42

Power Management Controller (PMC)

42.1 Chip-specific PMC information

This module is available only in S32K14xW series of devices. For chip-specific modes related information see [Modes supported](#)

42.2 Introduction

The PMC contains the internal voltage regulator, power on reset (POR) and the low voltage detect (LVD) system.

42.3 Features

The PMC features include:

- Internal voltage regulator offering a variety of power modes
- Active POR providing brown-out detect
- Low voltage reset (LVR)
- Low voltage detect supporting one trip point and interrupt
- Low power oscillator (LPO) with a typical frequency of 128 kHz

42.4 Modes of Operation

42.4.1 Full Performance Mode (FPM)

For the following Chip Power Modes, the internal voltage regulator is in full performance mode: RUN, STOP1, STOP2.

42.4.2 Low Power Mode (LPM)

For the following Chip Power Modes, the internal voltage regulator is in low power mode: VLPR and VLPS.

42.5 Low Voltage Reset and Detect System

This device includes a system to guard against low voltage conditions. This protects memory contents and controls MCU system states during supply voltage variations. The system is comprised of a power-on reset (POR) circuit, a low voltage reset (LVR) circuit and a low voltage detect (LVD) circuit. The LVD is disabled upon entering low power mode.

One flag is available to indicate the status of the low voltage detect system (LVD):

- The low voltage warning flag (LVWF) operates in a level sensitive manner. The LVWF bit is set when the supply voltage falls below the selected monitor trip point (V_{LVW}). The LVWF bit is cleared by writing one to the LVWACK bit, but only if the internal supply has returned above the trip point; otherwise, the LVWF bit remains set. This flag gets cleared on reset. The flag is only valid after the device has come out of the reset, at which point the flag will be set accordingly to the voltage level. If supply level is higher than LVW threshold then this flag stay cleared, else this flag gets set.

42.5.1 Low Voltage Reset (LVR) Operation

If the supply voltage falls below the reset trip point (V_{LVR}), a system reset will be generated.

42.5.2 Low-voltage warning (LVW) interrupt operation

The LVD system contains a low-voltage warning flag (LVWF) to indicate that the supply voltage is approaching, but is above, the LVD voltage. The LVW also has an interrupt, which is enabled by setting the PMC_LVDSC2[LVWIE] bit. If enabled, an LVW interrupt request occurs when the LVWF is set. LVWF is cleared by writing one to the PMC_LVDSC2[LVWACK] bit, when the supply returns to above the trip point.

42.6 Memory Map and Register Definition

This sections provides the detailed information of all registers for the PMC module.

42.6.1 PMC register descriptions

NOTE

Different portions of PMC registers are reset only by particular reset types. Each register's description provides details.

NOTE

The PMC registers can be written only in supervisor mode. Write accesses in user mode are blocked and will result in a bus error.

42.6.1.1 PMC memory map

PMC base address: 4007_D000h

Offset	Register	Width (In bits)	Access	Reset value
1h	Low Voltage Detect Status and Control 2 Register (LVDSC2)	8	RW	00h
2h	Regulator Status and Control Register (REGSC)	8	RW	Table 42-
3h	Low Voltage Reset Flags Register (LVRFLG)	8	W1C	Table 42-
4h	Low Power Oscillator Trim Register (LPOTRIM)	8	RW	Table 42-1

42.6.1.2 Low Voltage Detect Status and Control 2 Register (LVDSC2)

42.6.1.2.1 Offset

Register	Offset
LVDSC2	1h

42.6.1.2.2 Function

This register contains status and control bits to support the low voltage warning (LVW) function.

NOTE

When the internal voltage regulator is in low power mode, the LVD system is disabled regardless of the PMC_LVDSC2 settings.

42.6.1.2.3 Diagram

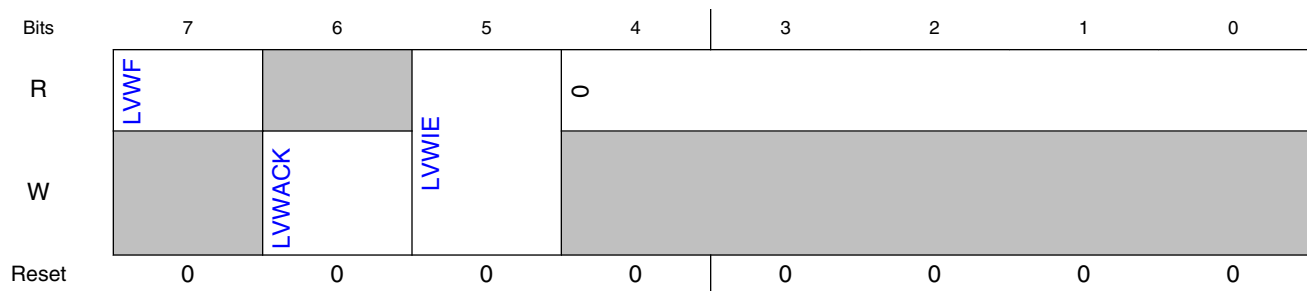

42.6.1.2.4 Fields

Field	Function
7 LVWF	Low-Voltage Warning Flag This bit read-only status bit indicates a low-voltage detect event. The threshold voltage is V_{LVW} . 0b - Low-voltage warning event not detected 1b - Low-voltage warning event detected
6 LVWACK	Low-Voltage Warning Acknowledge This write-only bit is used to acknowledge low voltage warning errors. Write 1 to clear LVWF. Reads always return 0.
5 LVWIE	Low-Voltage Warning Interrupt Enable This bit enables hardware interrupt requests for LVWF. 0b - Hardware interrupt disabled (use polling) 1b - Request a hardware interrupt when LVWF=1
4-0 —	Reserved

42.6.1.3 Regulator Status and Control Register (REGSC)

42.6.1.3.1 Offset

Register	Offset
REGSC	2h

42.6.1.3.2 Function

This register contains general control and status bits for the regulator and the LPO.

42.6.1.3.3 Diagram

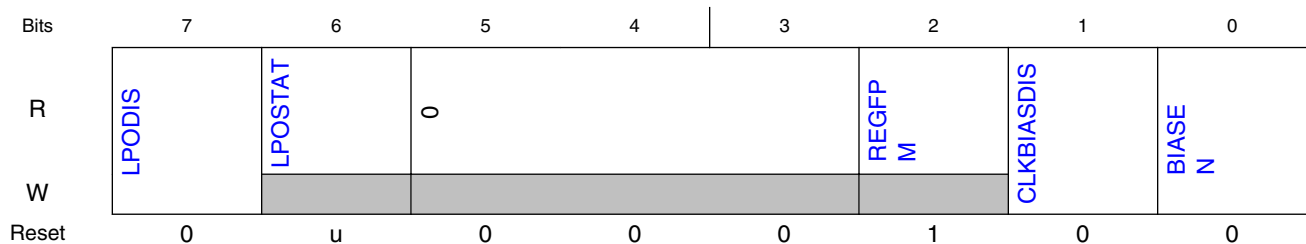

42.6.1.3.4 Fields

Field	Function
7 LPODIS	LPO Disable Bit This bit enables or disable the low power oscillator. NOTE: After disabling the LPO a time of 2 LPO clock cycles is required before it is allowed to enable it again. Violating this waiting time of 2 cycles can result in malfunction of the LPO. 0b - Low power oscillator enabled 1b - Low power oscillator disabled
6 LPOSTAT	LPO Status Bit This bit shows the status of the LPO clock to be either in high phase (logic 1) or low phase (logic 0) of the clock period. Software can poll this status bit to measure actual LPO clock frequency and eventually use the LPOTRIM[4:0] register to change the LPO frequency. 0b - Low power oscillator in low phase 1b - Low power oscillator in high phase
5-3 —	Reserved
2 REGFPM	Regulator in Full Performance Mode Status Bit This read-only bit provides the current status of the internal voltage regulator. 0b - Regulator is in low power mode or transition to/from 1b - Regulator is in full performance mode
1 CLKBIASDIS	Clock Bias Disable Bit This bit disables the bias currents and reference voltages for some clock modules in order to further reduce power consumption in VLPS mode.

Table continues on the next page...

Memory Map and Register Definition

Field	Function
	<p>Note: While using this bit, it must be ensured that respective clock modules are disabled in VLPS mode. Else, severe malfunction of clock modules will happen.</p> <p>0b - No effect 1b - In VLPS mode, the bias currents and reference voltages for the following clock modules are disabled: SIRC, FIRC, PLL. (if available on device)</p>
0 BIASEN	<p>Bias Enable Bit</p> <p>This bit enables source and well biasing for the core logic in low power mode. In full performance mode this bit has no effect. This is useful to further reduce MCU power consumption in low power mode. This bit must be set to 1 when using VLP* modes.</p> <p>0b - Biasing disabled, core logic can run in full performance 1b - Biasing enabled, core logic is slower and there are restrictions in allowed system clock speed (see Data Sheet for details)</p>

42.6.1.4 Low Voltage Reset Flags Register (LVRFLG)

42.6.1.4.1 Offset

Register	Offset
LVRFLG	3h

42.6.1.4.2 Function

This register shows with sticky flags on which power domains a low voltage reset has occurred.

NOTE

For all Flags that are not affected by Reset (POR flag, all LVR flags) in case a Reset occurs at the exact same time while trying to clear the flags (write 1), then the flag value is not exactly defined. So please clear again after exit from Reset.

42.6.1.4.3 Diagram

Bits	7	6	5	4	3	2	1	0
R	PORF	0	LVR3FLS F	LVR3F	LVRXLP F	LVRX F	LVRLP F	LVR F
W	W1C		W1C	W1C	W1C	W1C	W1C	W1C
Reset	u	0	u	u	u	u	u	u

42.6.1.4.4 Fields

Field	Function
7 PORF	POR Flag Flags that a power on reset event has occurred. Writing 1 clears it. Other reset sources have no effect.
6 —	Reserved
5 LVR3FLSF	LVR 3V Flash memory Flag Flags that a low voltage reset event has occurred on the internal 3.3V power domain of flash memory in full performance mode (FPM) or VLPR mode. Writing 1 clears it. Other reset sources have no effect.
4 LVR3F	LVR 3V Flag Flags that a low voltage reset event has occurred on the internal 3.3V power domain in full performance mode (FPM) or VLPR mode. Writing 1 clears it. Other reset sources have no effect.
3 LVRXLPF	LVR external in low power mode flag Flags that a low voltage reset event has occurred on the external 5V/3.3V power domain domain (FPM or LPM). Writing 1 clears it. Other reset sources have no effect.
2 LVRXF	LVR External Flag Flags that a low voltage reset event has occurred on the external 5V/3.3V power domain domain in full performance mode (FPM). Writing 1 clears it. Other reset sources have no effect.
1 LVRLPF	LVR in low power mode core Flag Flags that a low voltage reset event has occurred on internal core logic power domain domain (FPM or LPM). Writing 1 clears it. Other reset sources have no effect.
0 LVRF	LVR Core Flag Flags that a low voltage reset event has occurred on internal core logic power domain domain in full performance mode (FPM). Writing 1 clears it. Other reset sources have no effect.

42.6.1.5 Low Power Oscillator Trim Register (LPOTRIM)

42.6.1.5.1 Offset

Register	Offset
LPOTRIM	4h

42.6.1.5.2 Function

NOTE

All trimming bits represent a signed number. So 10000 = lowest level, 00000 = mid level, 01111 highest level

Memory Map and Register Definition

In the reset phase the factory trim values are loaded from Flash Memory. This register is read always and write only with `ipt_mode_non_user=1`.

NOTE

Before Trim is loaded from Flash the Trim register has the following POR reset value: hex 00

This register contains the period trimming bits for the low power oscillator.

Table 42-1. Trimming effect of LPOTRIM[4:0]

LPOTRIM[4:0]	Decimal	Period of LPO clock
10000	-16	lowest
10001	-15	increasing
...	...	
11110	-2	
11111	-1	
00000	0	typical 128 kHz
00001	+1	increasing
...	...	
01110	+14	
01111	+15	highest

NOTE

The LPO trimming bits represent signed values. Starting from -16 the period of the LPO clock will increase monotonically (for example, frequency decreases monotonically).

42.6.1.5.3 Diagram

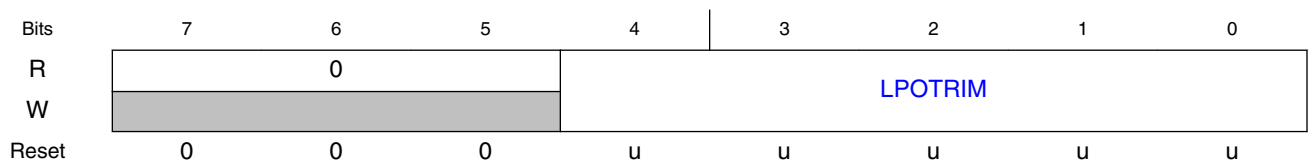

42.6.1.5.4 Fields

Field	Function
7-5	Reserved
—	
4-0	LPO trimming bits

Field	Function
LPOTRIM	These bits are used for trimming the frequency of the low power oscillator. See the table above for trimming effect.

Chapter 43

ADC Configuration

43.1 Instantiation information

S32K14x and S32K14xW contains two 12-bit ADC modules, ADC0 and ADC1.

S32K11x contains one 12-bit ADC modules, ADC0.

Wait/VLPW mode is not supported on this device. See [Module operation in available power modes](#) for details on available power modes.

NOTE

Bandgap voltage will not be available in VLP modes.

43.1.1 Number of ADC channels

Each ADC supports up to 32 external analog input channels, but the exact ADC channel number present on the device is different with packages as indicated in following table.

For details regarding a specific ADC channel available on a particular package, see [Introduction](#).

Table 43-1. ADC external channels per package

Chip	Package	ADC0	ADC1
S32K116	32 QFN	9	NA
	48 LQFP	13	NA
S32K118	48 LQFP	13	NA
	64 LQFP	16	NA
S32K142	48 LQFP	14	9
	64 LQFP	16	13
	100 LQFP	16	16
S32K144	48 LQFP	14	9
	64 LQFP	16	13

Table continues on the next page...

Table 43-1. ADC external channels per package (continued)

Chip	Package	ADC0	ADC1
	100 LQFP	16	16
	100 MAPBGA	16	16
S32K142W	48 LQFP	14	9
	64 LQFP	16	13
S32K144W	48 LQFP	14	9
	64 LQFP	16	13
S32K146	64 LQFP	16	13
	100 LQFP	16	16
	144 LQFP	24	24
	100 MAPBGA	16	16
S32K148	100 LQFP	16	16
	144 LQFP	32	32
	100 MAPBGA	16	16
	176 LQFP	32	32

ADCx_SC1n[ADCH] bit field configurations for a chip are as per the maximum channel configuration for that chip across packages as mentioned in the below table:

Table 43-2. ADCx_SC1n[ADCH] field configurations

Chip	ADCx_SC1n[ADCH] range	ADCx_SC1n[ADCH] configuration for module disabled
S32K116	00000 b - 11111 b	11111 b
S32K118	00000 b - 11111 b	11111 b
S32K142	00000 b - 11111 b	11111 b
S32K144	00000 b - 11111 b	11111 b
S32K142W	00000 b - 11111 b	11111 b
S32K144W	00000 b - 11111 b	11111 b
S32K146	000000 b - 111111 b	111111 b
S32K148	000000 b - 111111 b	111111 b

Unavailable channels in a particular package are Reserved for the corresponding package.

NOTE

See IO Signal Description Input Multiplexing sheet(s) attached to the Reference Manual for channel details on specific packages.

43.1.2 ADC Connections/Channel Assignment

See IO Signal Description Input Multiplexing sheet(s) attached to the Reference Manual for details on ADC channel connectivity.

Note that ADCx ADy and ADCx_SEy both refer to Channel y of ADCx.

Table 43-3. Internal channel availability

ADC internal channel	ADC0	ADC1
Channel 0	Used for supply monitoring (see ADC internal supply monitoring for details.)	Reserved
Channel 1	Reserved	Reserved
Channel 2	Reserved	Reserved
Channel 3	Reserved	Reserved

43.2 Register implementation

Not all the registers shown in memory map of ADC are implemented in each variant of S32K1xx. See the below table for register implementation.

Table 43-4. S32K1xx register implementation

Register/Offset	S32K116/ S32K118/ S32K142/S32K142W/ S32K144/S32K144W	S32K146	S32K148
aSC1A - aSC1P/108 - 144 aRA - aRP / 188 - 1C4	Reserved/Not implemented	Available/Implemented	Available/Implemented
SC1Q - SC1X /148 - 164 RQ - RX / 1C8 - 1E4	Reserved/Not implemented	Available/Implemented	Available/Implemented
SC1Y - SC1AF / 168 - 184 RY - RAF / 1E8 - 204	Reserved/Not Implemented	Reserved/Not Implemented	Available/Implemented

43.3 DMA Support on ADC

Applications may require continuous sampling of the ADC (4K samples/sec) that may have considerable load on the CPU. Though using the Programmable Delay Block (PDB) to trigger the ADC may reduce some CPU load, the ADC supports DMA request

functionality for higher performance when the ADC is sampled at a very high rate or in cases where the PDB is bypassed. The ADC can trigger the DMA (via DMA request) upon conversion completion.

For most cases, the DMA request can be directly triggered from ADC conversion completion. The device also supports another way to trigger DMA: via the TRGMUX. The TRGMUX will provide user a more flexible DMA triggering scheme using software based on different application requirements, for example, the DMA can be triggered after multiple ADC conversion completion instead of every ADC conversion completion.

43.4 ADC Hardware Interleaved Channels

On devices with two ADCs, there are several special ADC channels which support hardware interleave between multiple ADCs. Taking ADC0_SE4 and ADC1_SE14 channels as an example, these two channels can work independently, but they can also be hardware interleaved as following diagram. In the hardware interleaved mode, a signal on the pin PTB0 can be sampled by both ADC0 and ADC1. The interleaved mode is enabled by SIM_CHIPCTL[ADC_INTERLEAVE_EN] bits.

The hardware interleave implementation on this device is as following:

- ADC0_SE4 and ADC1_SE14 channels are interleaved on PTB0 pin
- ADC0_SE5 and ADC1_SE15 channels are interleaved on PTB1 pin
- ADC1_SE8 and ADC0_SE8 channels are interleaved on PTB13 pin
- ADC1_SE9 and ADC0_SE9 channels are interleaved on PTB14 pin

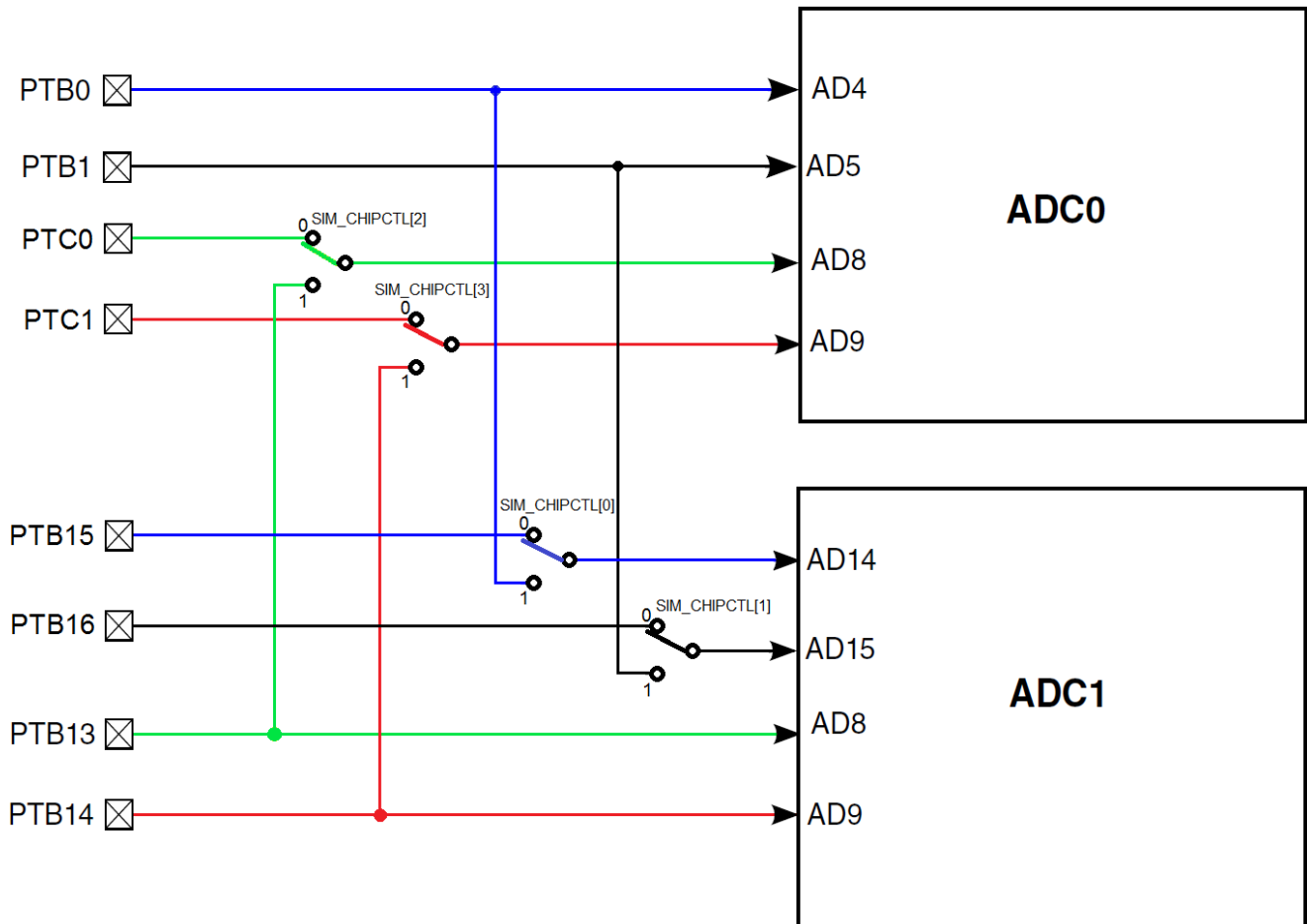

Figure 43-1. ADC0 and ADC1 hardware interleaved channels integration

NOTE

ADC interleaving is not supported in S32K11x devices.

43.5 ADC internal supply monitoring

Internal supplies are monitored on ADC0 internal channel 0 (configured by selecting `ADC0_SC1n[ADCH]` as 010101b). Please refer to `SIM_CHIPCTL[ADC_SUPPLY]` and `SIM_CHIPCTL[ADC_SUPPLYEN]` bits.

43.6 ADC Reference Options

The ADC supports the following references:

- VREFH/VREFL - connected as the primary reference option
- VALTH/VREFL - connected as an alternate reference option

ADCx_SC2[REFSEL] bit selects the voltage reference sources for ADC. Refer to REFSEL description in ADC chapter for more details.

In all S32K1xx devices, VALTH is same as V_{DDA} . In packages where dedicated V_{REFH} / V_{REFL} pins are not available, V_{REFH} is connected in package to V_{DDA} and V_{REFL} to V_{SSA} . If externally available, the positive reference should be connected to the same potential as V_{DDA} or may be driven by an external source to a level between the minimum V_{REFH} and the V_{DDA} potential. V_{REFH} must never exceed V_{DDA} . V_{REFL} should be connected to the same voltage potential as V_{SSA} .

43.7 ADC Trigger Sources

- Triggers are connected through PDB or TRGMUX to provide flexible trigger schemes
- PDB generate triggers and pre-triggers for ADC (the ADC and PDB operate in pairs, as PDB0; ADC0 and PDB1; ADC1), each PDB channel will have up to 8 pre-triggers for ADC channel control, which provides an automatically trigger scheme so that the CPU involvement is not necessary.
- Minimum one external pin per ADC (supported via the TRGMUX)
 - Software must determine relative priority
 - Starts conversion after a single ongoing conversion complete
- CMP out, LPIT, RTC, and LPTMR are capable of triggering each ADC via TRGMUX. See TRGMUX module interconnectivity in TRGMUX section for the modules which are capable of triggering ADC.
- LPIT supports up to 4 pre-triggers, which are limited to be used only on the ADHWTS0–ADHWTS3 of each ADC. For the rest of the peripherals, software configuration is required to provide pre-triggers. See SIM_ADCCOPT[ADCxSWPRETRG] for configuring the software pre-trigger.

The following specification and diagram are just giving an example to help understanding the ADC trigger scheme. Generally, the ADC supports two kinds of hardware triggering schemes:

- The default hardware triggering scheme uses the PDB to trigger the ADC (suggested).
- Another optional hardware triggering scheme is to use the TRGMUX.
- The SIM_ADCCOPT[ADCxTRGSEL] field is used to control the ADC triggering source/scheme.

- When $ADCxTRGSEL=0$, the ADC pre-trigger comes from PDB directly.
- When $ADCxTRGSEL=1$, the ADC pre-trigger comes from TRGMUX, as in the case of LPIT.

NOTE

For the TRGMUX triggering, only up to 4 pre-triggers are supported.

NOTE

Each PDB supports 4 slots/4 triggers channel, and each channel supports 8 pre-triggers. The triggers of PDB channels can be OR'ed together to support up to 32 pre-triggers if necessary.

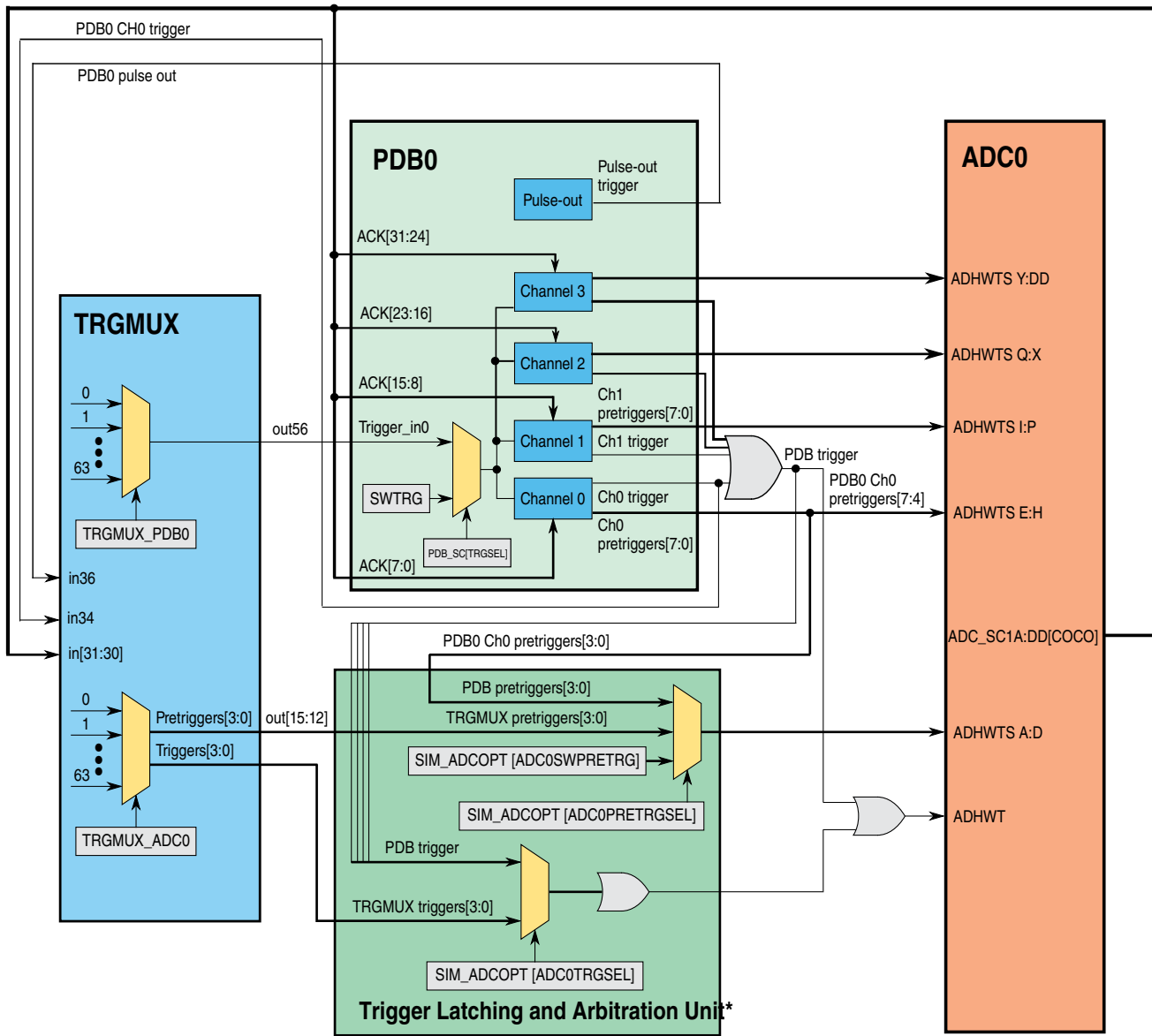

* The block depicts simplified schematic and doesn't show detailed latching. See section 'Trigger Latching and Arbitration' of ADC chapter for details

Figure 43-2. ADC0_PDB0 ADC Triggering scheme example

NOTE

While using TRGMUX, only LPIT supports pretriggers. For other peripherals, software pretriggers need to be configured using SIM_ADCOPT[ADCxSWPRETRG].

43.7.1 PDB triggering scheme

The PDB triggering scheme is the default and the suggested trigger method for the ADC. One ADC and one PDB work as one pair: PDB0-ADC0, PDB1-ADC1. The trigger sources for PDB0 and PDB1 can be configured through TRGMUX_PDB0 and TRGMUX_PDB1, respectively. Here we take PDB0-ADC0 as an example to specify the triggering scheme.

- Set `SIM_ADCOPT[ADCxTRGSEL]=0`. PDB0 channel 0 is selected as the ADC trigger source.
- PDB0 pre-triggers will connect directly to the ADC0 ADHWTS port to control the channels.
- The ADC0 COCO signals are fed directly back to PDB0 to deactivate the PDB lock state.

The following figures illustrate typical cases for ADC triggering using the PDB:

Case 1:

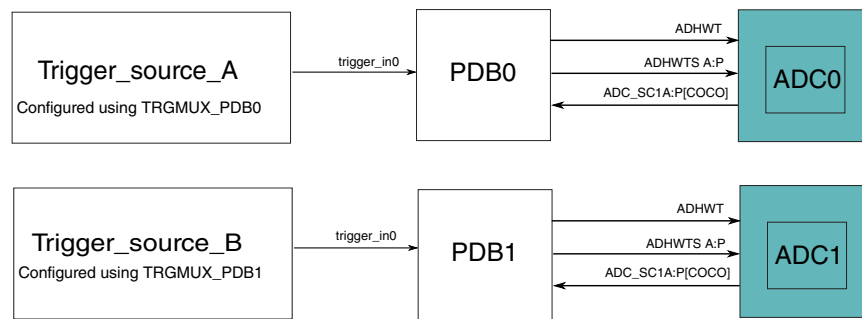

Figure 43-3. ADCs triggering with independent sources

Case 2:

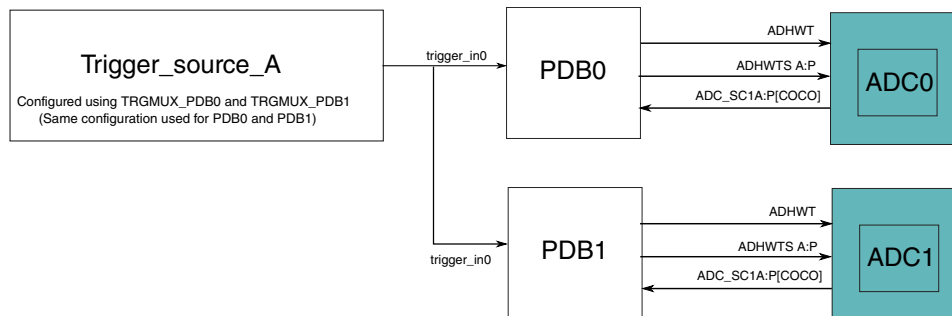

Figure 43-4. ADC triggering with same source

43.7.2 TRGMUX trigger scheme

TRGMUX supports many trigger sources. Here we take LPIT as a typical example, but the trigger source can also be others which are mentioned above. LPIT supports up to 4 channels, with each channel having a trigger and a pre-trigger.

- Set `SIM_ADCOPT[ADCxTRGSEL]=1`. TRGMUX out is selected as the ADC trigger source.
- Configure TRGMUX to select LPIT triggers as the ADC trigger and pre-trigger sources.
- TRGMUX only supports up to 4 pre-triggers for each ADC (pre-trigger0–pre-trigger3; the other pre-triggers cannot be used with TRGMUX).
- ADC COCO is not required in this case. Software must accommodate the intermission time between each ADC conversion.
- Using TRGMUX allows a single LPIT to be used to trigger two ADCs simultaneously. This is one of the benefits of using TRGMUX triggering instead of PDB triggering.

NOTE

For trigger sources other than PDB and LPIT, software is required to provide ADC pre-triggers.

43.8 Trigger Selection

Any combination of trigger enable and trigger can be selected; they are independent of each other. But after it has been selected, it cannot be changed on-the-fly. There are defined steps to change the trigger and enable sources (trigger and pretrigger source). Changing of trigger source can be done anytime by any of the two ways below.

Way 1

1. Stop the current trigger generation unit .
2. Wait for a time period equals to total of 2.5 cycle of ADC operating clock and 1.5 cycles of ADC host interface clock, to give time to latch the last trigger, if any
3. Poll the status of `ADC_SC2[TRGSTLAT]` for all 0, it will come to 0 after completing all conversions enqueued till that time
4. Change the selections for desired source and then
5. Start the new trigger generation units

If it is required to switch immediately

1. Stop the current trigger generation unit

2. Flush all the queued triggers of trigger handler block by setting ADC_CFG1[CLRLTRG], this will flush all queued triggers except the one under process by ADC, if any
3. Wait for a time period equals to total of 2.5 cycle of ADC operating clock
4. Wait for the status of ADC_SC2[TRGSTLAT] to become all 0
5. Change the selections for desired source and then
6. Start the new trigger generation units

NOTE

If the above restriction is not followed then the trigger missed by this process might not be reported.

43.9 Trigger Latching and Arbitration

The four lower triggers have the capability to be latched. Irrespective of which source combination is selected, the trigger requests from that source are latched and processed. Latched trigger requests are presented to the ADC one at a time. The next request is given only when the processing of the current trigger request is completed by the ADC. Therefore, only one request is processed at any given time and all other requests are latched. If a trigger request appears again on any of the 0–3 enables/triggers while it is either being processed by the ADC or already latched in the trigger handler, the new request is ignored and an error is indicated for that trigger in register ADC_SC2[TRGSTERR].

The relationship among the trigger requests from the selected source can randomly be (a) one-hot, or (b) simultaneous. However, they will be serviced on a round-robin basis. For example, after the Pth request is processed [$0 < P < (N-1)$], searching will resume with (P + 1), followed by (P+2), until the next latched request is found. This searching then rolls over to 0 after (N-1)th trigger and continues until P is reached.

To work with the ADC using multiplexed triggers, you need to follow the below sequences of programming for different cases:

Case 1: Initialization/start of conversion:	<ol style="list-style-type: none"> a. Initialize/reprogram (in case of intermediate start) the SAR ADC for desired operation (see the ADC section for details). b. Select the trigger source for the trigger handler block (configuration for this resides in a separate module on the chip; refer to the SIM_ADCCOPT register in the SIM chapter). c. Configure and start the trigger generation module (PDB or TRGMUX).
Case 2: Changing the trigger source/multiplexer control:	<ol style="list-style-type: none"> a. Stop the trigger generation module (PDB or TRGMUX). b. Do one of the following options:

Table continues on the next page...

Trigger Latching and Arbitration

	<p>Option 1:</p> <ol style="list-style-type: none"> 1. Wait for a duration equals to total of 2.5 cycle of ADC operating clock and 1.5 cycles of ADC host interface clock, to give time to latch the last trigger, if any 2. Wait for the latched triggers to be processed and trigger handler to be idle (poll the status of ADC_SC2[TRGSTLAT] for all 0). <p>Option 2:</p> <ol style="list-style-type: none"> 1. Flush the latched trigger requests in trigger handler block(Write a 1b to the ADC_CFG1[CLRLTRG]). 2. Wait for a time period equals to total of 2.5 cycle of ADC operating clock 3. Wait for the idle status of trigger handler (poll the status of ADC_SC2[TRGSTLAT] for all 0). <p>c. Reselect the trigger source for the trigger handler block (configuration for this resides in a separate module on the chip; see the chip-specific section).</p> <p>d. Configure and start the trigger generation module (PDB or TRGMUX).</p>
Case 3: Stopping of conversion	<p>a. Stop the trigger generation module (PDB or TRGMUX).</p> <p>b. Wait for a duration equals to total of 2.5 cycle of ADC operating clock plus 1.5 cycles of ADC host interface clock, to give time to latch the last trigger, if any.</p> <p>c. Wait for the latched triggers to be processed and the trigger handler to be idle (poll the status of ADC_SC2[TRGSTLAT] for all 0s).</p> <p>d. Stop the SAR ADC and clear interrupts after required processing (see the ADC section for details).</p>
Case 4: Changing trigger source/multiplexer control in case of ongoing continuous conversion	<p>a. Stop the trigger generation module (PDB or TRGMUX).</p> <p>b. Read any configuration register of the ADC.</p> <p>c. Write the read value from above in the same register.</p> <p>d. This write will abort the ongoing continuous conversion.</p> <p>e. Reselect the trigger source for the trigger handler block (configuration for this resides in a separate module on the chip; refer to the SIM_ADCCOPT register in the SIM chapter).</p> <p>f. Configure and start the trigger generation module (PDB or TRGMUX).</p>
Case 5: Clearing the error status (applicable for the TRGMUX case only)	<p>a. Read the error status (ADC_SC2[TRGSTERR]).</p> <p>b. If any above register bit is 1, then stop the trigger generation module (TRGMUX).</p> <p>c. Wait for a duration equals to total of 2.5 cycle of ADC operating clock plus 1.5 cycles of ADC host interface clock, to give time to latch the last trigger, if any.</p> <p>d. Wait for the idle status of the trigger handler (poll the status of ADC_SC2[TRGSTLAT] for all 0s).</p> <p>e. Clear the above register bit by writing 1 to it.</p> <p>f. Wait for the latched triggers to be processed and the trigger handler to be idle (poll the status of ADC_SC2[TRGSTLAT] for all 0s).</p>

Table continues on the next page...

- | |
|---|
| g. Reselect the trigger source for the trigger handler block (configuration for this resides in a separate module on the chip; refer to the SIM_ADCCOPT register in the SIM chapter). |
| h. Configure and start the trigger generation module (PDB or TRGMUX). |

NOTE

Latched status clearing by writing 1 to ADC_CFG1[CLRLTRG] should not be done while PDB triggering through the trigger handler, as the PDB works in a closed loop with the COCO flag from the ADC and provides one trigger at a time. Clearing the latched status while it is being processed within the trigger handler (before being launched to the ADC) will stop its future conversion and there will be no COCO flag. In such case, the PDB might enter an indeterminate state.

43.10 ADC triggering configurations

The ADC supports two triggering schemes as already described in previous sections through below two paths (See ADC0_PDB0 ADC triggering example):

1. Direct Triggering path through PDB on channel number 4 onward.
2. Multiplexed triggering path through PDB/TRGMUX on channels 0 to 3 through trigger latching gasket.

Out of these, the user should either use direct triggering path on channel 4 onward with PDB triggering on channels 0 to 3 or only TRGMUX path on channel 0 to 3. When using direct triggering scheme through PDB, the pretriggers should be minimum 4 bus clock cycles apart. Accordingly, following table shows the ADC triggering configurations and behavior:

Table 43-5. ADC triggering configurations and behavior

S.No.	Configuration	Delay in between pretriggers, t (in bus clk cycles)	PDB triggering on all channels (SIM_ADCCOPT[ADC0TRGSEL] = 1'b0, SIM_ADCCOPT[ADC0PRETRGSEL] = 2'b00)		Triggering through trigger latching gasket on channel 0 to 3 (SIM_ADCCOPT[ADC0TRGSEL] = 1'b1, SIM_ADCCOPT[ADC0PRETRGSEL] = 2'b01/2'b10)
			Channel 0 to 3	Channel 4 onwards	Channel 0 to 3
1	Zero pretrigger delay	t = 0	No conversion	No conversion	No conversion

Table continues on the next page...

Table 43-5. ADC triggering configurations and behavior (continued)

S.No.	Configuration	Delay in between pretriggers, t (in bus clk cycles)	PDB triggering on all channels (SIM_ADCCOPT[ADC0TRGSEL] = 1'b0, SIM_ADCCOPT[ADC0PRETRGSEL] = 2'b00)		Triggering through trigger latching gasket on channel 0 to 3 (SIM_ADCCOPT[ADC0TRGSEL] = 1'b1, SIM_ADCCOPT[ADC0PRETRGSEL] = 2'b01/2'b10)
2	Pretrigger delay less than 4 bus clk cycles	$0 < t \leq 4$	ADC results are valid (due to trigger latching gasket) for both conversions.	ADC results are invalid for both conversions.	ADC results are valid (due to trigger latching gasket) for both conversions.
3	Pretrigger delay is greater than 4 bus clk cycles but less than ADC conversion time	$4 < t < t_{ADC}$	ADC results are valid (due to trigger latching gasket) for both conversions.	ADC results are valid for first conversion, invalid for second.	ADC results are valid (due to trigger latching gasket) for both conversions.
4	Pretrigger delay configured greater than ADC conversion time	$t > t_{ADC}$	ADC results are valid for both conversions	ADC results are valid for both conversions	ADC results are valid for both conversions.

(If ADC conversion time < 4 bus clk cycles, configuration 3 in the table above will not be applicable)

NOTE

PDB provides sequence error only if the corresponding two pretriggers belong to same PDB channel. When different PDB channels are used, the software should ensure that the delays in between two pretriggers is atleast four bus clock cycles apart, otherwise the conversion results will be invalid for both conversions.

The pretriggers, trigger, COCO, sequence error and result status are mentioned below for different configurations mentioned in the table above:

1. Zero delay configured:

Trigger is not raised. The sequence error is reported on both the channels. The ADC result register consists of junk information.

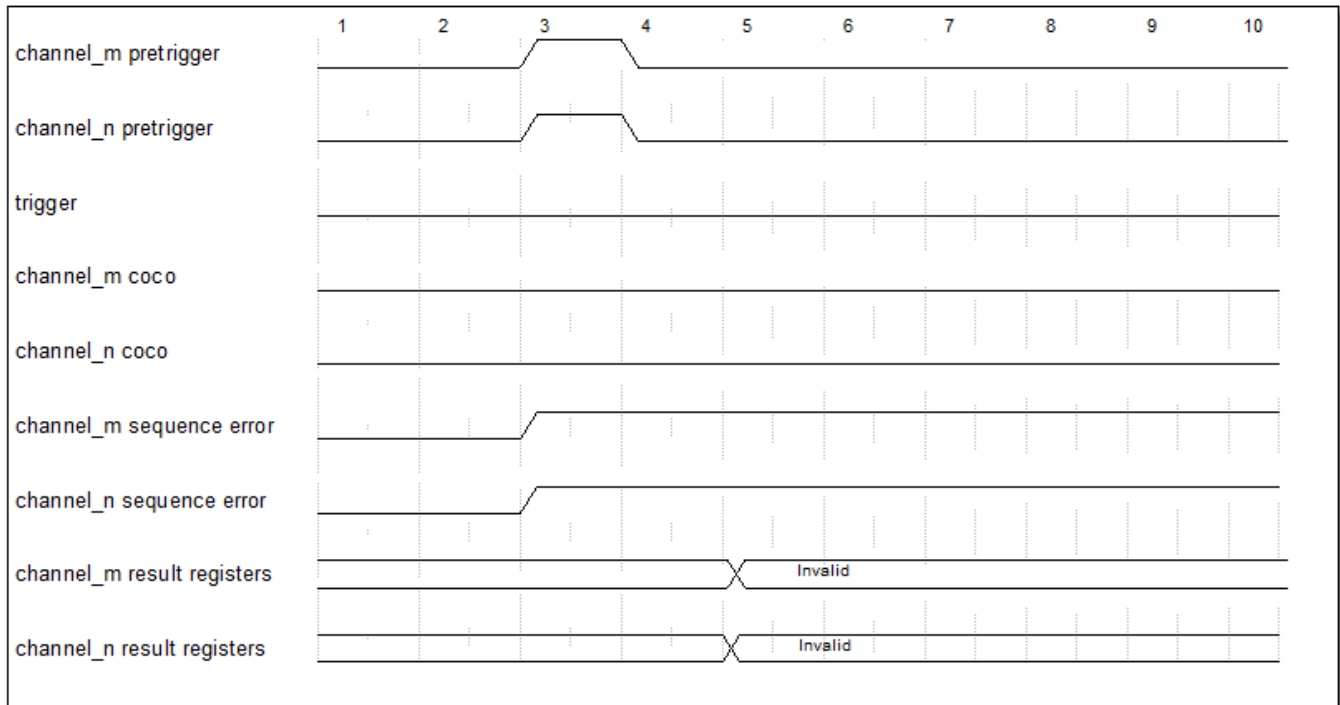

Figure 43-5.

2. Delay configured is less than 4 bus clk cycles:

a. Direct Triggering on channel number 4 onwards through same PDB channel:

Sequence error for second conversion, COCO might be received or might not. Both the conversion results are invalid.

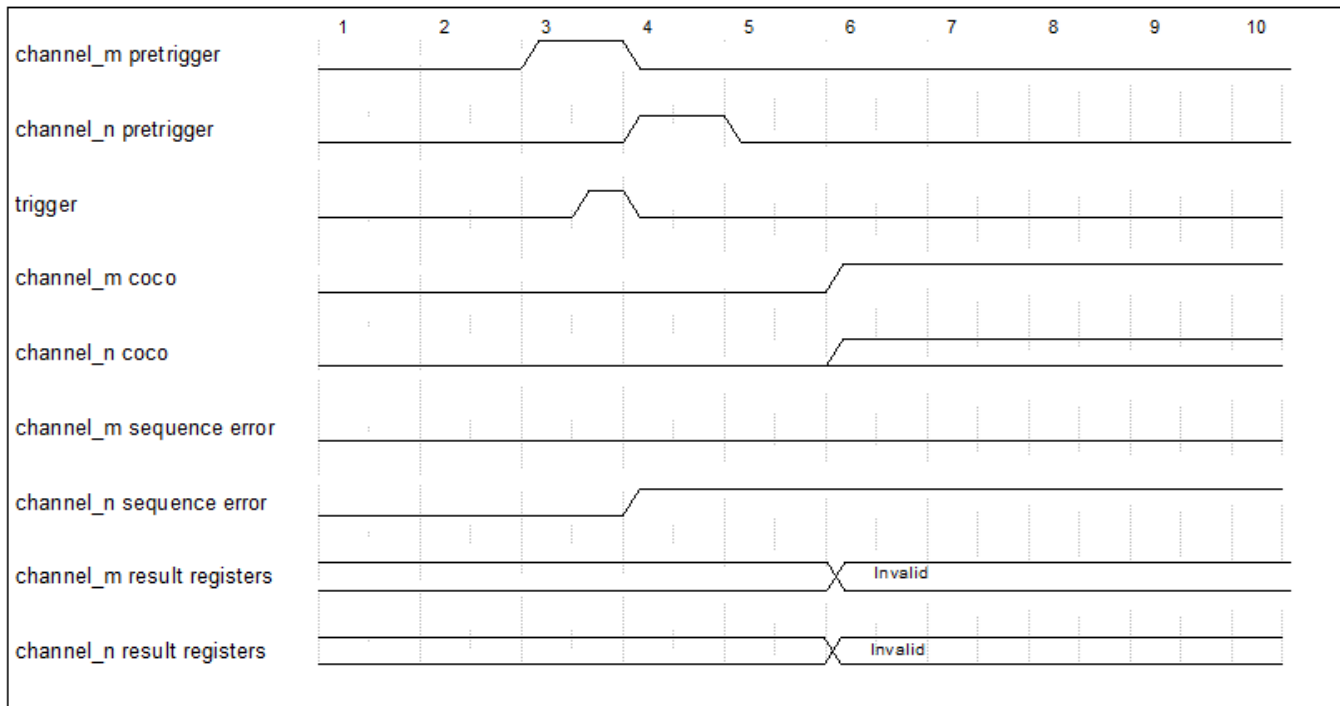

Figure 43-6.

- b. Direct Triggering on channel number 4 onwards through different PDB channels:

Sequence error for second conversion is not reported, COCO might be received or might not. Both the conversion results are invalid.

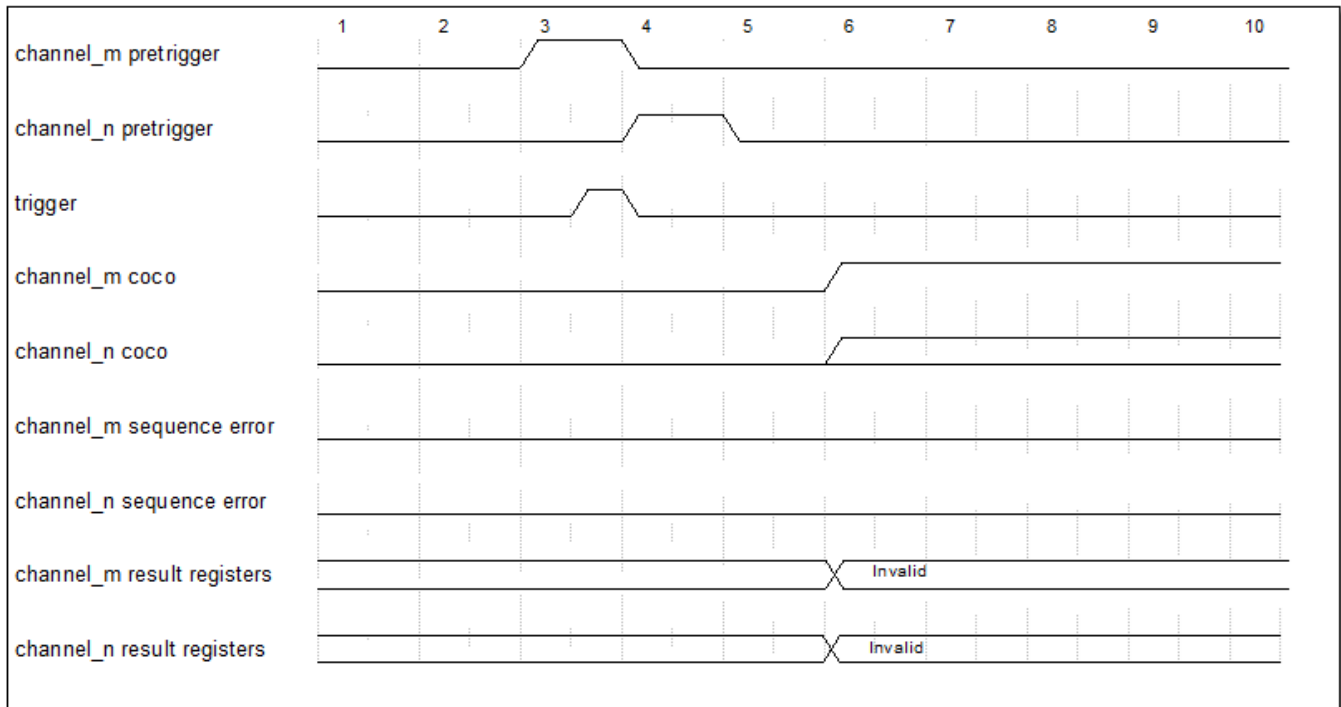

Figure 43-7.

- c. Triggering on channels 0-3 through trigger latching gasket:

Sequence error for second conversion is reported, COCO will be received for both channels. Both the conversion results are valid. This is due to the virtue of trigger latching gasket, which latches the trigger requests.

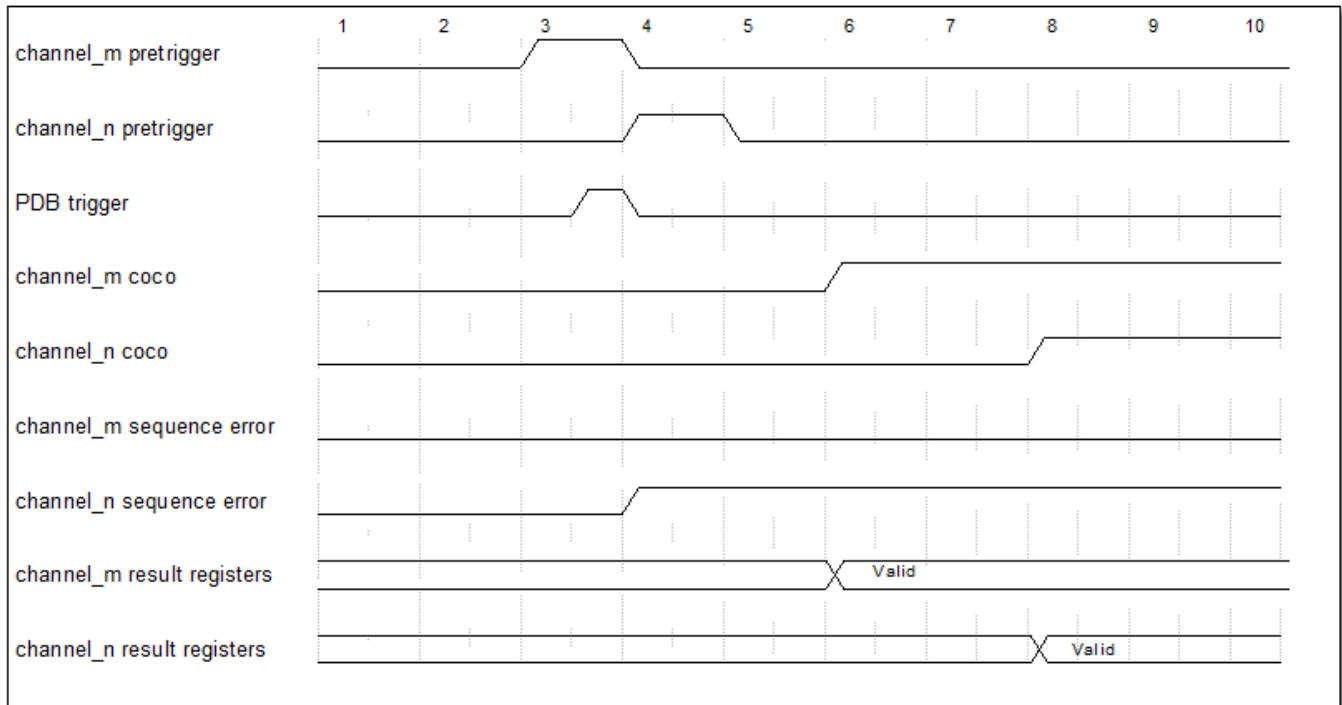

Figure 43-8.

3. Delay configured is less than ADC conversion time and greater than 4 bus clk cycles:
 - a. Direct Triggering on channel number 4 onwards through same PDB channel:

Sequence error for second conversion, COCO will not be received. First conversion results are valid and second conversion results are invalid.

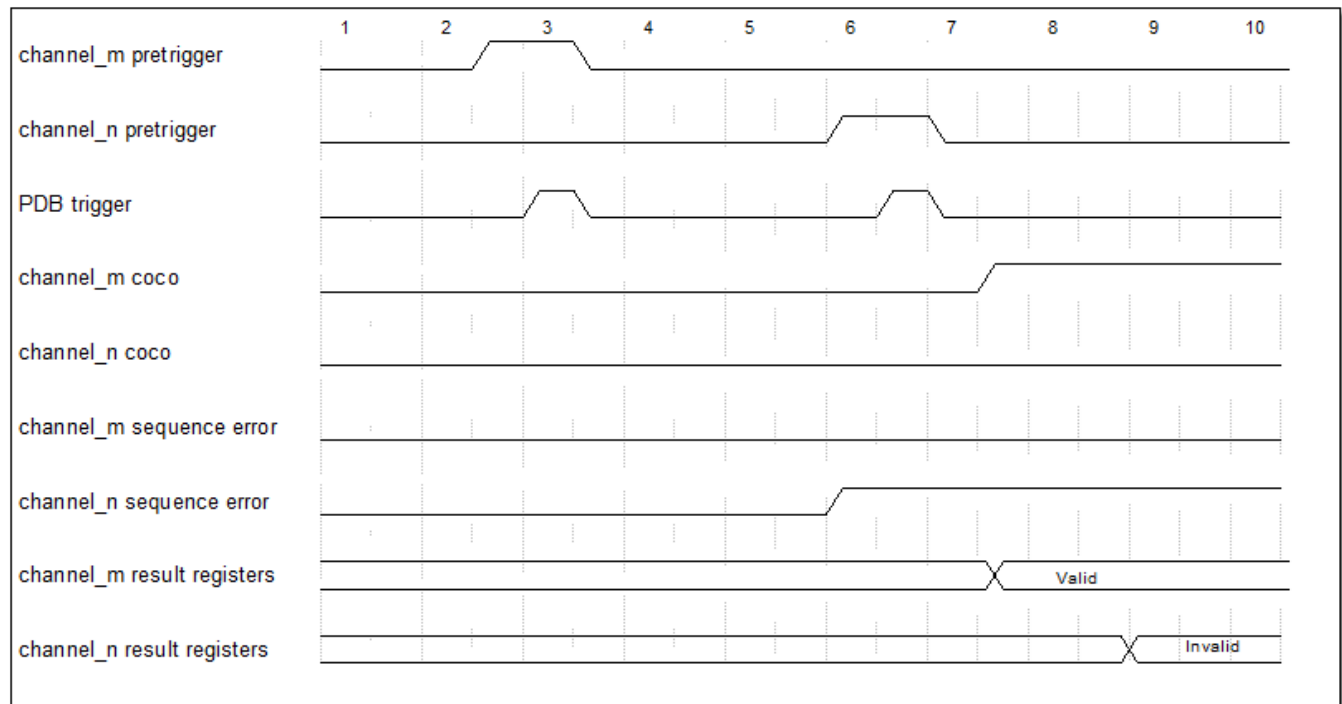

Figure 43-9.

- b. Direct Triggering on channel number 4 onwards through different PDB channel:
 No sequence error for second conversion, COCO will not be received. First conversion results are valid and second conversion results are invalid.

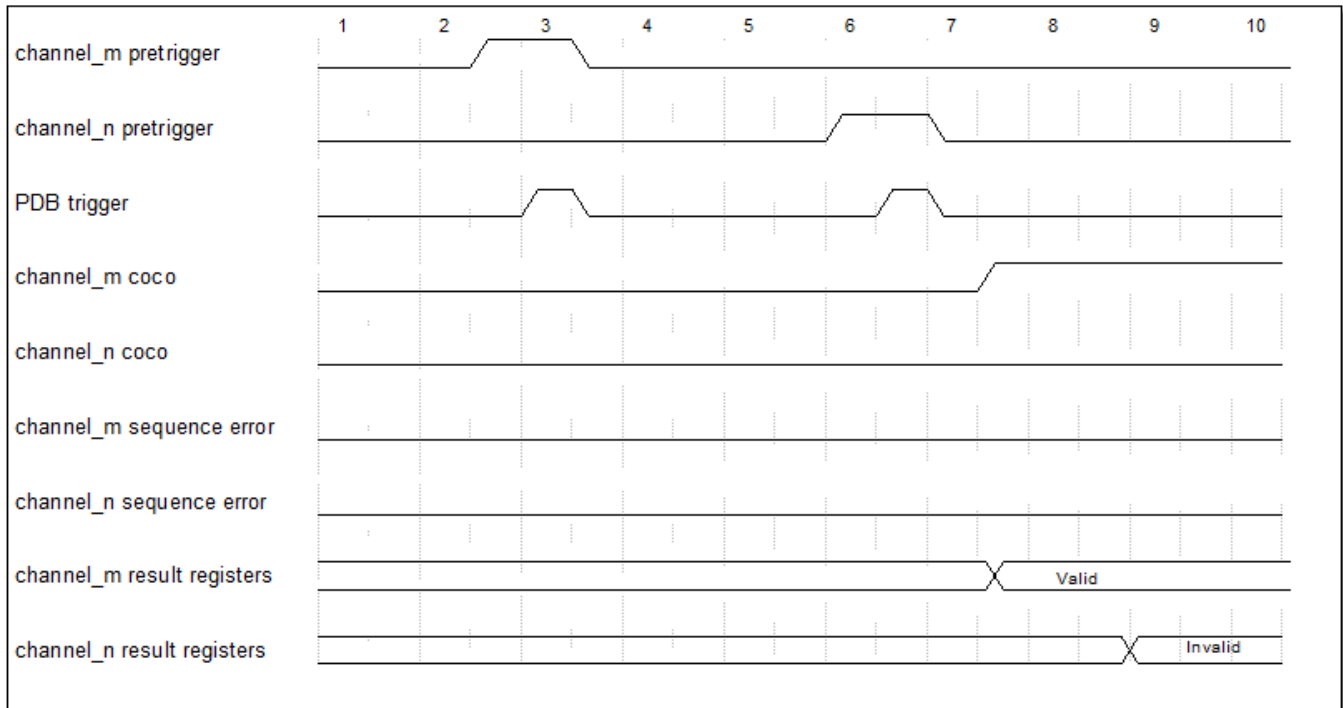

Figure 43-10.

- c. Triggering on channels 0-3 through trigger latching gasket:
 Sequence error for second conversion is reported, COCO will be received for both channels. Both the conversion results are valid. This is due to the virtue of trigger latching gasket, which latches the trigger requests.

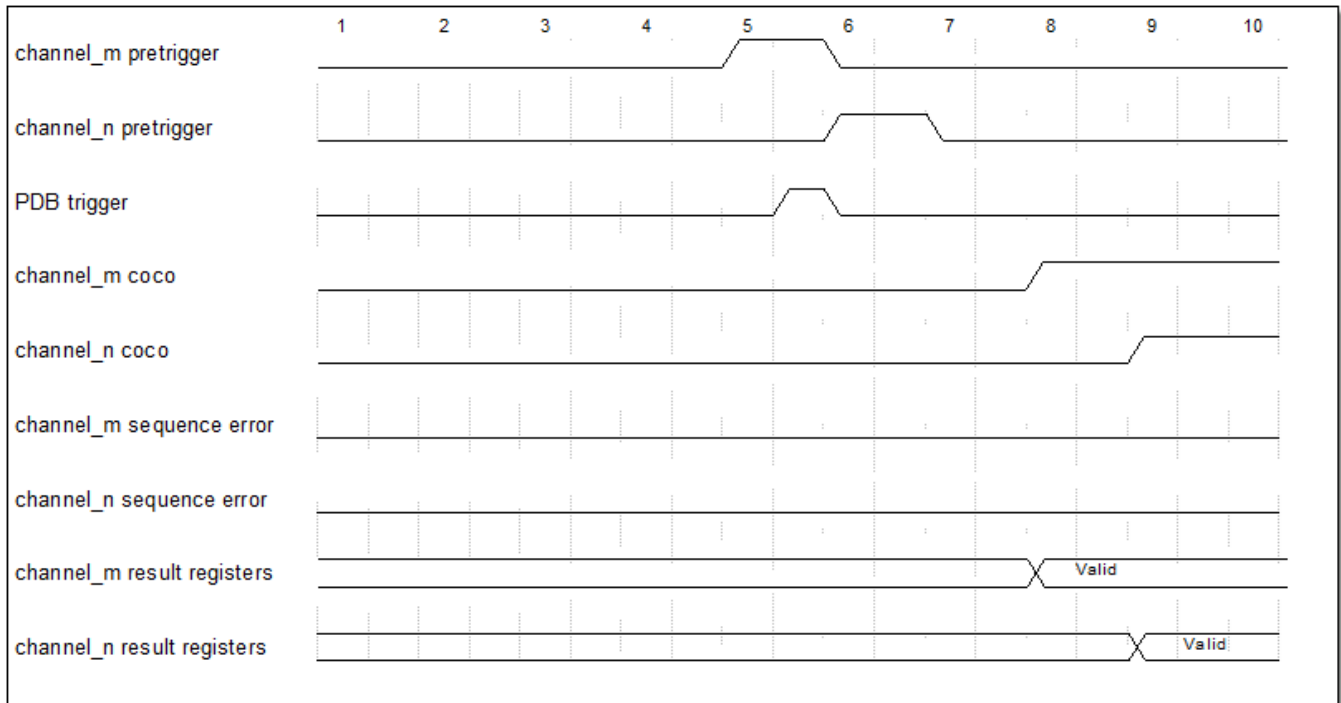

Figure 43-11.

4. Delay configured is greater than ADC conversion time:

No sequence error, Both COCOs received. Both conversions are valid.

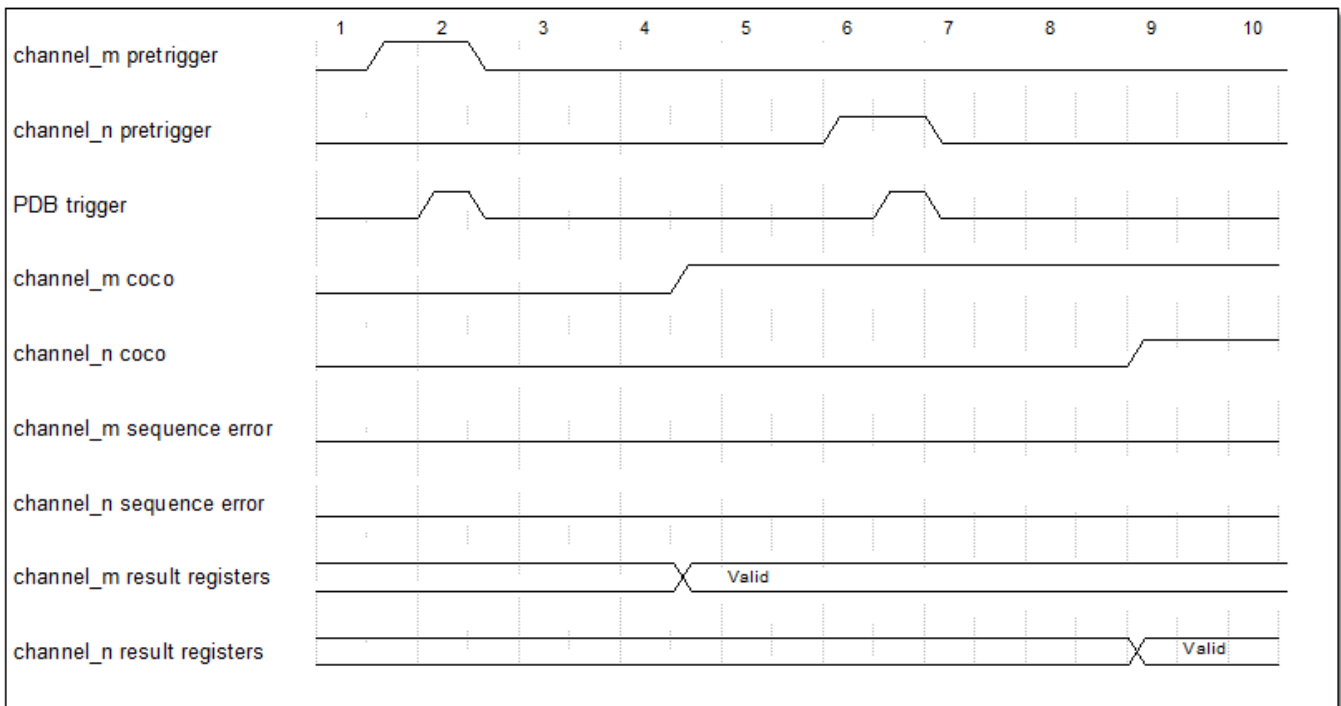

Figure 43-12.

43.11 ADC low-power modes

The ADC will be available in STOP2 mode.

43.12 ADC Trigger Concept – Use Case

The FlexTimer Module (FTM) supports the counter init trigger and channel match trigger, which could be used as a trigger input of the PDB. The PDB could then be used to trigger other modules such as the ADC. Each ADC channel in the PDB module supports up to 8 pre-triggers, which could be used as the ADC hardware channel selection to precondition the ADC block prior to an actual trigger. After a pre-trigger, the ADC trigger initiates the ADC conversion. The waveforms shown in the following diagram illustrate the pre-trigger and trigger output of the PDB to ADC. When a PDB pre-trigger and trigger output starts an ADC conversion, an internal lock associated with the corresponding pre-trigger is activated. This lock becomes inactive when receiving the COCO signal from the ADC.

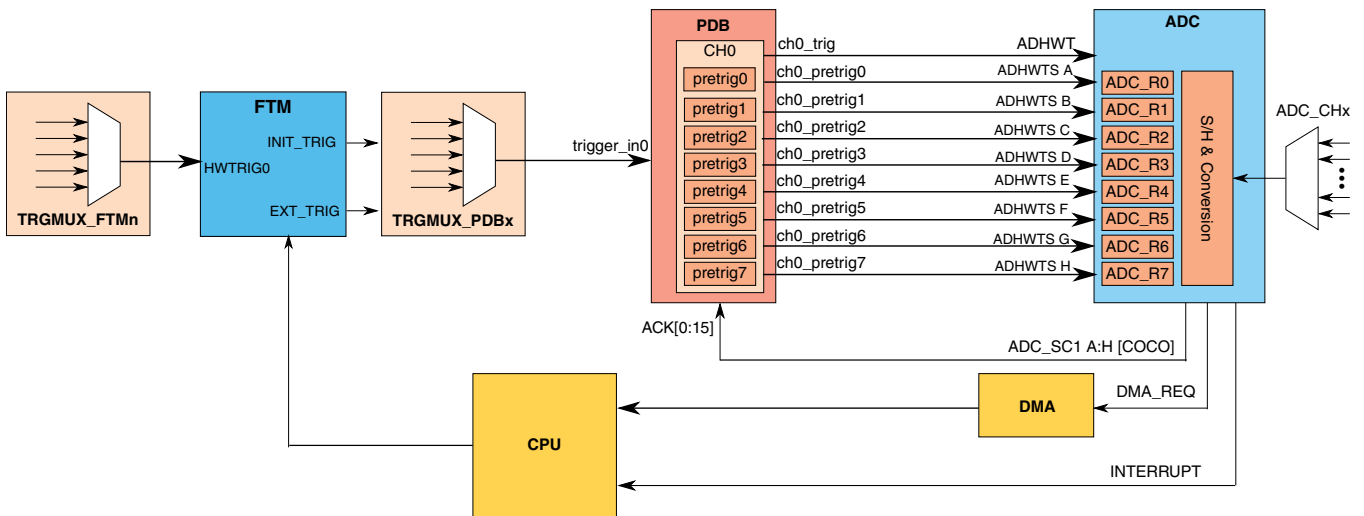

Figure 43-13. PWM Load Diagnosis – ADC Trigger Concept (block diagram)

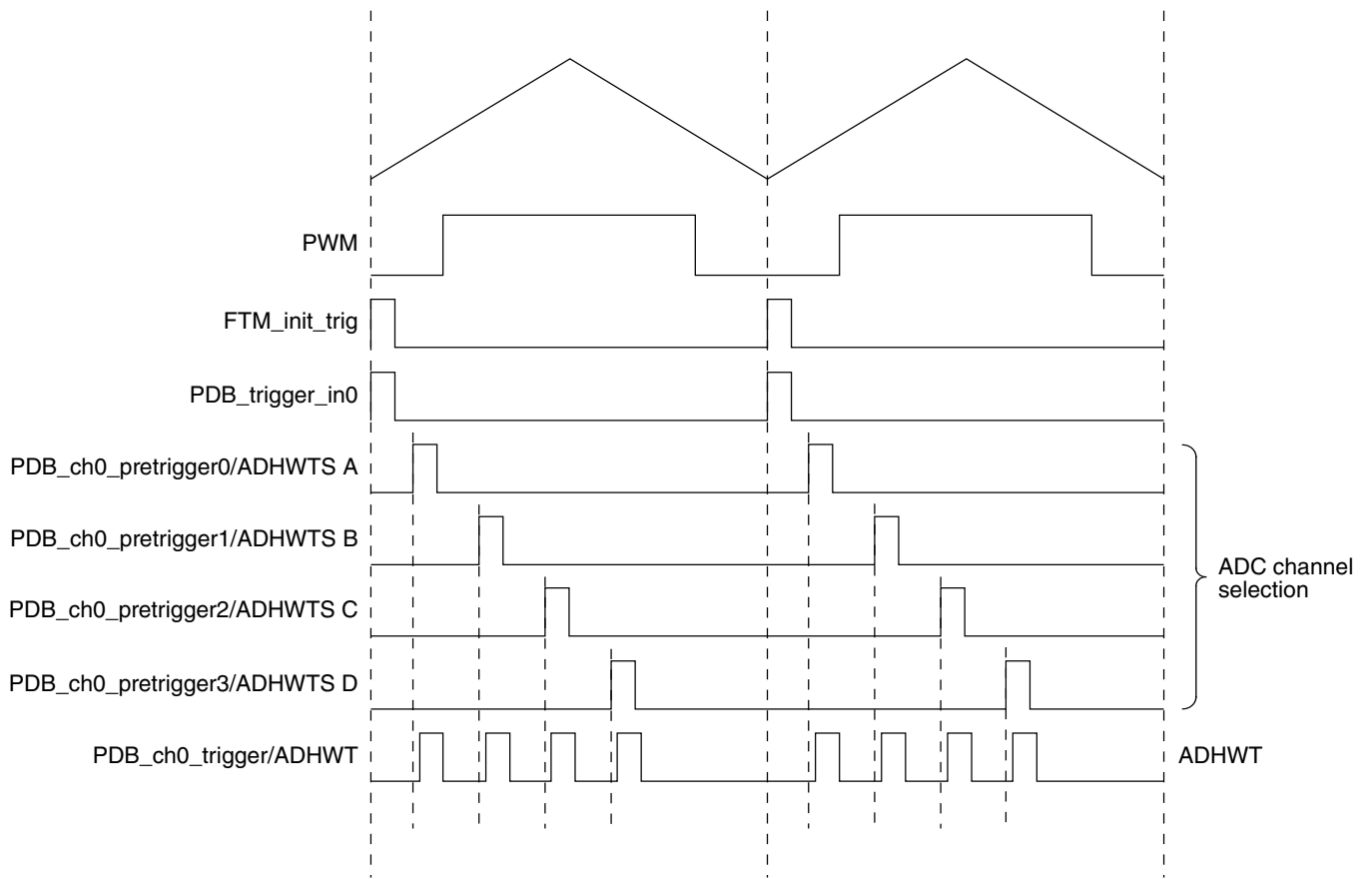

Figure 43-14. Example: PWM Load Diagnosis – ADC Trigger Concept 1 (Timing)

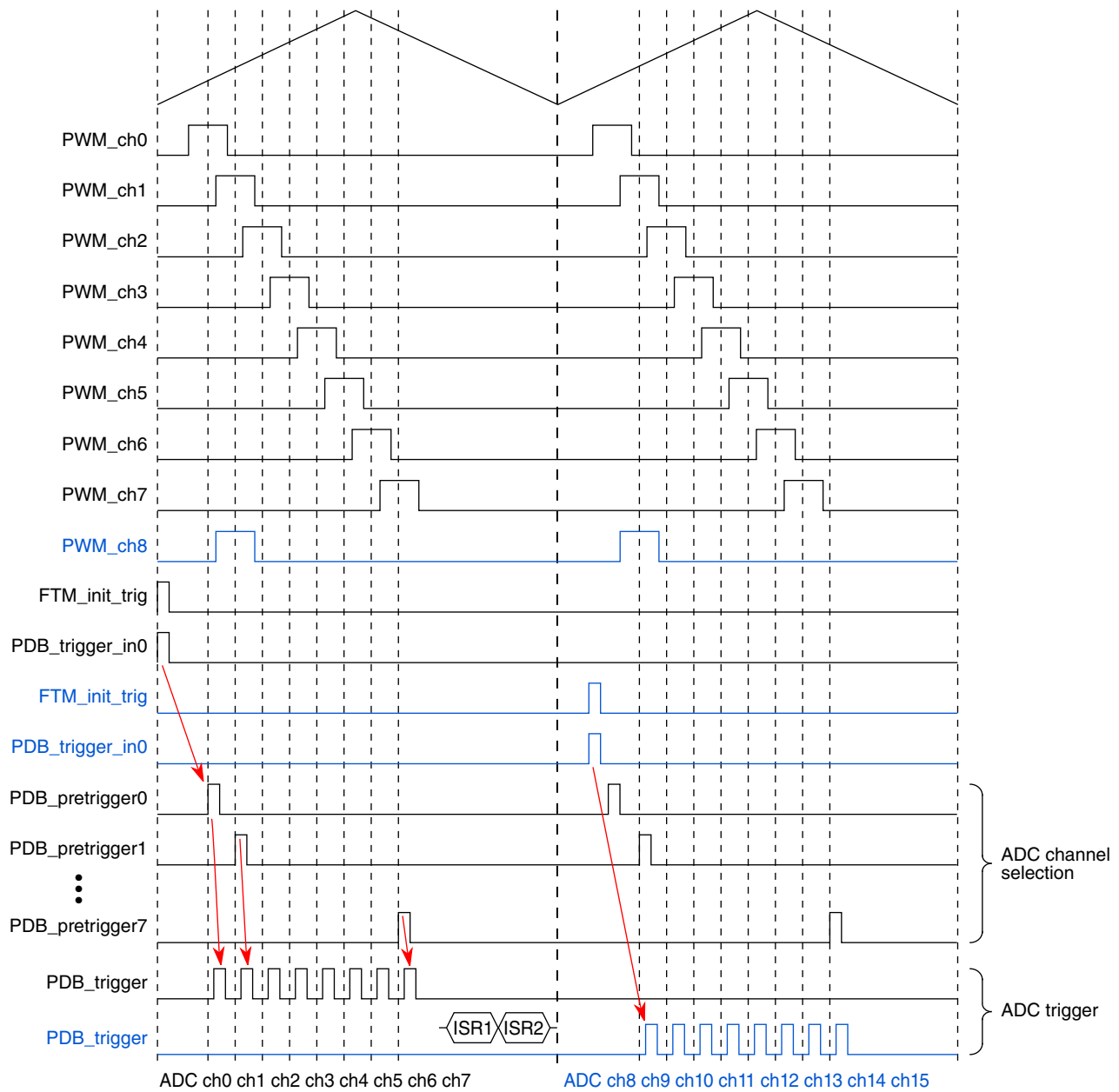

Figure 43-15. Example: PWM Load Diagnosis – ADC Trigger Concept 2 (Timing)

43.13 ADC calibration scheme

The ADC calibration must be executed by using the ADC Status and Control Register 3 ([SC3\[CAL\]](#) field) after each reset.

NOTE

In order to reduce the calibration overhead and time, the user can run calibration once after each Power On Reset and save the calibration registers in non-volatile memory. The calibration data from non-volatile memory can be used for subsequent calibration after functional resets.

Upon subsequent exits from power mode STOP2, re-calibration is not required. Since the power is continuous in all of the device power modes (STOP2, RUN, and HSRUN), all of the ADC specifications are maintained as per the data sheet.

43.14 S32K11X to S32K14X difference

See [Differences between S32K14x/S32K14xW, and S32K11x](#), for differences arising out of CPU and interrupt latency impacting timed events when comparing S32K14X and S32K11X variants.

Chapter 44

Analog-to-Digital Converter (ADC)

44.1 Chip-specific ADC information

See the [ADC Configuration](#) chapter.

44.2 Introduction

The 12-bit analog-to-digital converter (ADC) is a successive approximation ADC designed for operation within an integrated microcontroller system-on-chip.

NOTE

For the chip specific modes of operation, see the power management information of the device.

44.2.1 Features

Following are the features of the ADC module:

- Linear successive approximation algorithm with up to 12-bit resolution
- Up to 32 single-ended external analog inputs
- Single-ended 12-bit, 10-bit, and 8-bit output modes
- Output in right-justified unsigned format for single-ended
- Single or continuous conversion modes
- Automatic return to idle after single conversion
- Configurable sample time and conversion speed/power
- Conversion complete/hardware average complete flag and interrupt
- Input clock selectable from up to four sources
- Operation in low-power modes for lower noise
- Selectable hardware conversion trigger with hardware channel select

Introduction

- Automatic compare with interrupt for less-than, greater-than or equal-to, within range, or out-of-range, programmable value
- Hardware average function
- Selectable voltage reference: external or alternate
- Self-Calibration mode

44.2.2 Block diagram

The following figure is the ADC module block diagram.

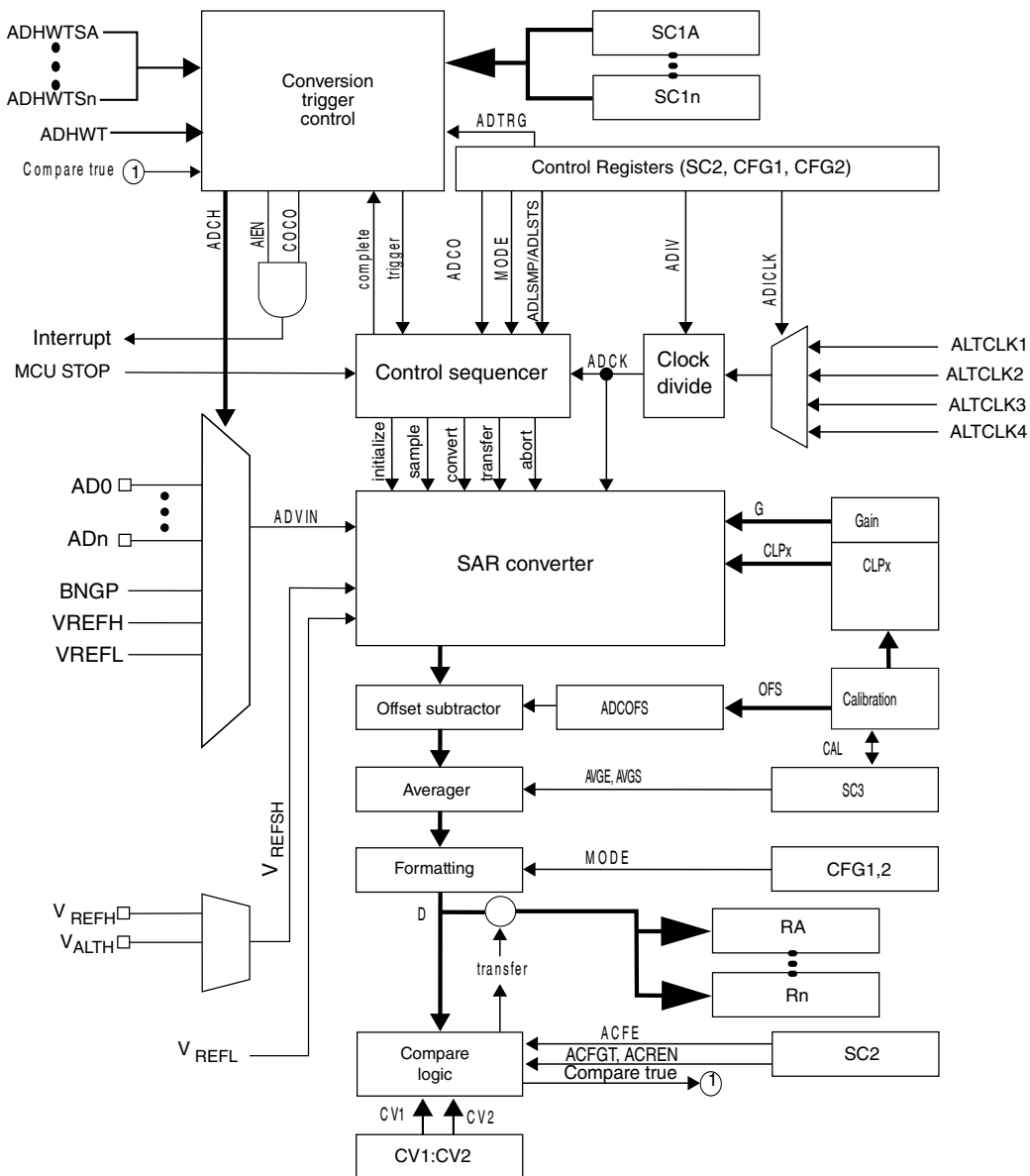

Figure 44-1. ADC block diagram

44.3 ADC signal descriptions

Each ADC module supports up to 32 single-ended inputs.

The ADC also requires four supply/reference/ground connections.

NOTE

For the number of channels supported on this device, see the chip-specific ADC information.

The ADC does not produce any output signals.

Table 44-1. ADC input signal descriptions

Signal	Description
ADn	Single-Ended Analog Channel Inputs
V_{REFSH}	Voltage Reference Select High
V_{REFSL}	Voltage Reference Select Low
V_{DDA}	Analog Power Supply
V_{SSA}	Analog Ground

44.3.1 Analog Power (V_{DDA})

The ADC analog portion uses V_{DDA} as its power connection. In some packages, V_{DDA} is connected internally to V_{DD} . If externally available, connect the V_{DDA} pin to the same voltage potential as V_{DD} . External filtering may be necessary to ensure clean V_{DDA} for good results.

44.3.2 Analog Ground (V_{SSA})

The ADC analog portion uses V_{SSA} as its ground connection. In some packages, V_{SSA} is connected internally to V_{SS} . If externally available, connect the V_{SSA} pin to the same voltage potential as V_{SS} .

44.3.3 Voltage Reference Select

V_{REFSH} and V_{REFSL} are the high and low reference voltages for the ADC module.

The ADC can be configured to accept one of the voltage reference pairs for V_{REFSH} and V_{REFSL} by configuring V_{REFSH} as V_{REFH} or V_{ALTH} . Each pair contains a positive reference that must be between the minimum Ref Voltage High and V_{DDA} , and a ground reference that must be at the same potential as V_{SSA} . The two pairs are external (V_{REFH} and V_{REFL}) alternate (V_{ALTLH} and V_{REFL}). These voltage references are selected by configuring $SC2[REFSEL]$. The alternate voltage reference, V_{ALTH} may select additional external pin or internal source depending on MCU configuration. See the chip configuration information on the Voltage References specific to this MCU.

In some packages, V_{REFH} is internally connected to V_{DDA} and V_{REFL} to V_{SSA} . If externally available, the positive reference(s) may be connected to the same potential as V_{DDA} or may be driven by an external source to a level between the minimum V_{REFH} and the V_{DDA} potential. V_{REFH} must never exceed V_{DDA} . Connect the ground references to the same voltage potential as V_{SSA} .

44.3.4 Analog Channel Inputs (ADx)

The ADC module supports up to 32 analog inputs. An analog input is selected for conversion through the $SC1[ADCH]$ channel select field.

44.4 ADC register descriptions

This section describes the ADC registers. All ADC registers support 8-bit, 16-bit, and 32-bit reads, but only 32-bit writes are supported. Executing an 8-bit or a 16-bit write will result in a transfer error.

44.4.1 ADC Memory map

ADC0 base address: 4003_B000h

ADC1 base address: 4002_7000h

Offset	Register	Width (In bits)	Access	Reset value
0h - 3Ch (alias)	ADC Status and Control Register 1 (SC1A - SC1P)	32	RW	0000_003Fh
40h	ADC Configuration Register 1 (CFG1)	32	RW	0000_0000h

Table continues on the next page...

Offset	Register	Width (In bits)	Access	Reset value
44h	ADC Configuration Register 2 (CFG2)	32	RW	0000_000Ch
48h - 84h (alias)	ADC Data Result Registers (RA - RP)	32	RO	0000_0000h
88h - 8Ch	Compare Value Registers (CV1 - CV2)	32	RW	0000_0000h
90h	Status and Control Register 2 (SC2)	32	RW	0000_0000h
94h	Status and Control Register 3 (SC3)	32	RW	0000_0000h
98h	BASE Offset Register (BASE_OFS)	32	RW	0000_0040h
9Ch	ADC Offset Correction Register (OFS)	32	RW	Table 44-2
A0h	USER Offset Correction Register (USR_OFS)	32	RW	0000_0000h
A4h	ADC X Offset Correction Register (XOFS)	32	RW	0000_0030h
A8h	ADC Y Offset Correction Register (YOFS)	32	RW	0000_0037h
ACh	ADC Gain Register (G)	32	RW	Table 44-2
B0h	ADC User Gain Register (UG)	32	RW	0000_0004h
B4h	ADC General Calibration Value Register S (CLPS)	32	RW	Table 44-2
B8h	ADC Plus-Side General Calibration Value Register 3 (CLP3)	32	RW	Table 44-2
BCh	ADC Plus-Side General Calibration Value Register 2 (CLP2)	32	RW	Table 44-2
C0h	ADC Plus-Side General Calibration Value Register 1 (CLP1)	32	RW	Table 44-2
C4h	ADC Plus-Side General Calibration Value Register 0 (CLP0)	32	RW	Table 44-2
C8h	ADC Plus-Side General Calibration Value Register X (CLPX)	32	RW	Table 44-2
CCh	ADC Plus-Side General Calibration Value Register 9 (CLP9)	32	RW	Table 44-2
D0h	ADC General Calibration Offset Value Register S (CLPS_OFS)	32	RW	0000_0000h
D4h	ADC Plus-Side General Calibration Offset Value Register 3 (CLP3_OFS)	32	RW	0000_0000h
D8h	ADC Plus-Side General Calibration Offset Value Register 2 (CLP2_OFS)	32	RW	0000_0000h
DCh	ADC Plus-Side General Calibration Offset Value Register 1 (CLP1_OFS)	32	RW	0000_0000h
E0h	ADC Plus-Side General Calibration Offset Value Register 0 (CLP0_OFS)	32	RW	0000_0000h
E4h	ADC Plus-Side General Calibration Offset Value Register X (CLPX_OFS)	32	RW	0000_0440h
E8h	ADC Plus-Side General Calibration Offset Value Register 9 (CLP9_OFS)	32	RW	0000_0240h
108h - 144h (alias)	ADC Status and Control Register 1 (aSC1A - aSC1P)	32	RW	0000_003Fh
148h	ADC Status and Control Register 1 (SC1Q)	32	RW	0000_003Fh
14Ch	ADC Status and Control Register 1 (SC1R)	32	RW	0000_003Fh
150h	ADC Status and Control Register 1 (SC1S)	32	RW	0000_003Fh
154h	ADC Status and Control Register 1 (SC1T)	32	RW	0000_003Fh
158h	ADC Status and Control Register 1 (SC1U)	32	RW	0000_003Fh
15Ch	ADC Status and Control Register 1 (SC1V)	32	RW	0000_003Fh
160h	ADC Status and Control Register 1 (SC1W)	32	RW	0000_003Fh

Table continues on the next page...

ADC register descriptions

Offset	Register	Width (In bits)	Access	Reset value
164h	ADC Status and Control Register 1 (SC1X)	32	RW	0000_003Fh
168h	ADC Status and Control Register 1 (SC1Y)	32	RW	0000_003Fh
16Ch	ADC Status and Control Register 1 (SC1Z)	32	RW	0000_003Fh
170h	ADC Status and Control Register 1 (SC1AA)	32	RW	0000_003Fh
174h	ADC Status and Control Register 1 (SC1AB)	32	RW	0000_003Fh
178h	ADC Status and Control Register 1 (SC1AC)	32	RW	0000_003Fh
17Ch	ADC Status and Control Register 1 (SC1AD)	32	RW	0000_003Fh
180h	ADC Status and Control Register 1 (SC1AE)	32	RW	0000_003Fh
184h	ADC Status and Control Register 1 (SC1AF)	32	RW	0000_003Fh
188h - 1C4h (alias)	ADC Data Result Registers (aRA - aRP)	32	RO	0000_0000h
1C8h	ADC Data Result Registers (RQ)	32	RO	0000_0000h
1CCh	ADC Data Result Registers (RR)	32	RO	0000_0000h
1D0h	ADC Data Result Registers (RS)	32	RO	0000_0000h
1D4h	ADC Data Result Registers (RT)	32	RO	0000_0000h
1D8h	ADC Data Result Registers (RU)	32	RO	0000_0000h
1DCh	ADC Data Result Registers (RV)	32	RO	0000_0000h
1E0h	ADC Data Result Registers (RW)	32	RO	0000_0000h
1E4h	ADC Data Result Registers (RX)	32	RO	0000_0000h
1E8h	ADC Data Result Registers (RY)	32	RO	0000_0000h
1ECh	ADC Data Result Registers (RZ)	32	RO	0000_0000h
1F0h	ADC Data Result Registers (RAA)	32	RO	0000_0000h
1F4h	ADC Data Result Registers (RAB)	32	RO	0000_0000h
1F8h	ADC Data Result Registers (RAC)	32	RO	0000_0000h
1FCh	ADC Data Result Registers (RAD)	32	RO	0000_0000h
200h	ADC Data Result Registers (RAE)	32	RO	0000_0000h
204h	ADC Data Result Registers (RAF)	32	RO	0000_0000h

44.4.2 ADC Status and Control Register 1 (SC1A - aSC1P)

44.4.2.1 Offset

For a = A to P (0 to 15):

Register	Offset
SC1a	0h + (a × 4h)
aSC1a (alias for SC1a)	108h + (a × 4h)

44.4.2.2 Function

SC1A is used for both software and hardware trigger modes of operation.

At any one point in time, only one of the SC1n registers is actively controlling ADC sequential conversions. Updating SC1A while SC1n is actively controlling a conversion is allowed, and vice versa for any of the SC1n registers specific to this MCU.

Writing to the SC1A register while SC1A is actively controlling a conversion aborts the current conversion. In Software Trigger mode (when SC2[ADTRG]=0), writes to SC1A initiate a new conversion. This is valid for all values of SC1A[ADCH] other than all 1s (module disabled).

Writing any of the SC1n registers while that specific SC1n register is actively controlling a conversion aborts the current conversion. None of the SC1B-SC1n registers are used for software trigger operation and therefore writes to the SC1BSC1n registers do not initiate a new conversion.

44.4.2.3 Diagram

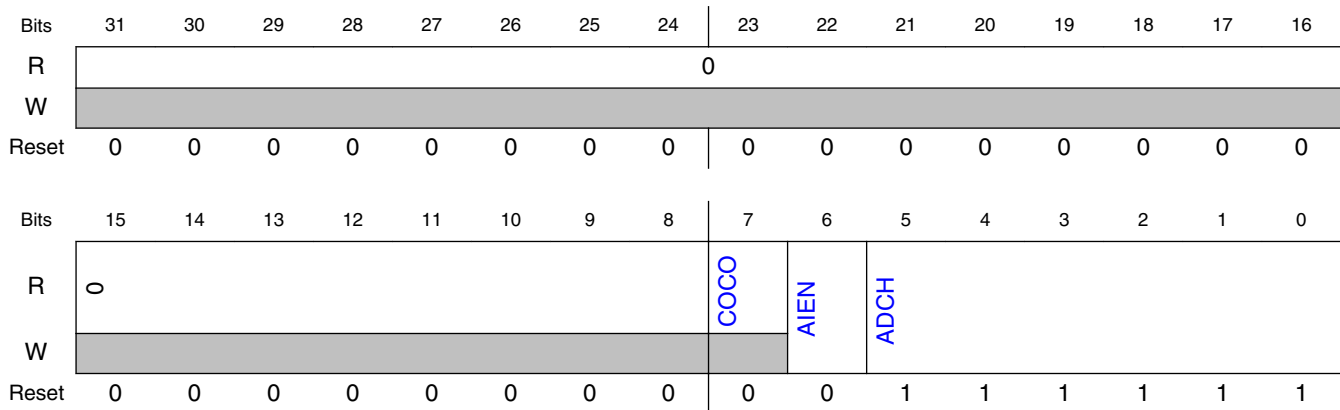

44.4.2.4 Fields

Field	Function
31-8	Reserved
7	Conversion Complete Flag

Table continues on the next page...

ADC register descriptions

Field	Function
COCO	<p>This is a read-only field that is set each time a conversion is completed when one or more of the following is true:</p> <ul style="list-style-type: none"> • The compare function is disabled • SC2[ACFE]=0 and the hardware average function is disabled • SC3[AVGE]=0 <p>If the compare result is true, then COCO is set upon completion of a conversion if one or more of the following is true:</p> <ul style="list-style-type: none"> • The compare function is enabled • SC2[ACFE]=1 <p>COCO is set upon completion of the selected number of conversions (determined by AVGS) if one or more of the following is true:</p> <ul style="list-style-type: none"> • The hardware average function is enabled • SC3[AVGE]=1 <p>COCO in SC1A is also set at the completion of a calibration sequence.</p> <p>COCO is cleared when one of the following is true:</p> <ul style="list-style-type: none"> • The respective SC1n register is written • The respective Rn register is read <p>0b - Conversion is not completed. 1b - Conversion is completed.</p>
6 AIEN	<p>Interrupt Enable</p> <p>Enables conversion complete interrupts. When COCO becomes set while the respective AIEN is high, an interrupt is asserted.</p> <p>0b - Conversion complete interrupt is disabled. 1b - Conversion complete interrupt is enabled.</p>
5-0 ADCH	<p>Input channel select</p> <p>Selects one of the input channels.</p> <p>NOTE: Some of the input channel options in the bitfield-setting descriptions might not be available for your chip. For the actual ADC channel assignments for your device, see the chip-specific information.</p> <p>The successive approximation converter subsystem is turned off when the channel bits are all set (i.e. ADCH set to all 1s). This feature allows explicit disabling of the ADC and isolation of the input channel from all sources. Terminating continuous conversions this way prevents an additional single conversion from being performed. It is not necessary to set ADCH to all 1s to place the ADC in a low-power state when continuous conversions are not enabled because the module automatically enters a low-power state when a conversion completes.</p> <p>00000b - External channel 0 is selected as input. 000001b - External channel 1 is selected as input. 000010b - External channel 2 is selected as input. 000011b - External channel 3 is selected as input. 000100b - External channel 4 is selected as input. 000101b - External channel 5 is selected as input. 000110b - External channel 6 is selected as input. 000111b - External channel 7 is selected as input. 001000b - External channel 8 is selected as input. 001001b - External channel 9 is selected as input. 001010b - External channel 10 is selected as input. 001011b - External channel 11 is selected as input. 001100b - External channel 12 is selected as input. 001101b - External channel 13 is selected as input. 001110b - External channel 14 is selected as input.</p>

Field	Function
	001111b - External channel 15 is selected as input.
	010000b - Reserved
	010001b - Reserved
	010010b - Reserved
	010011b - Reserved
	010100b - Reserved
	010101b - Internal channel 0 is selected as input.
	010110b - Internal channel 1 is selected as input.
	010111b - Internal channel 2 is selected as input.
	011000b - Reserved
	011001b - Reserved
	011010b - Reserved
	011011b - Band Gap
	011100b - Internal channel 3 is selected as input.
	011101b - V_{REFSH} is selected as input. Voltage reference selected is determined by SC2[REFSEL].
	011110b - V_{REFSL} is selected as input. Voltage reference selected is determined by SC2[REFSEL].
	011111b - Reserved
	100000b - External channel 16 is selected as input.
	100001b - External channel 17 is selected as input.
	100010b - External channel 18 is selected as input.
	100011b - External channel 19 is selected as input.
	100100b - External channel 20 is selected as input.
	100101b - External channel 21 is selected as input.
	100110b - External channel 22 is selected as input.
	100111b - External channel 23 is selected as input.
	101000b - External channel 24 is selected as input.
	101001b - External channel 25 is selected as input.
	101010b - External channel 26 is selected as input.
	101011b - External channel 27 is selected as input.
	101100b - External channel 28 is selected as input.
	101101b - External channel 29 is selected as input.
	101110b - External channel 30 is selected as input.
	101111b - External channel 31 is selected as input.
	110000b - Reserved
	110001b - Reserved
	110010b - Reserved
	110011b - Reserved
	110100b - Reserved
	110101b - Reserved
	110110b - Reserved
	110111b - Reserved
	111000b - Reserved
	111001b - Reserved
	111010b - Reserved
	111011b - Reserved
	111100b - Reserved
	111101b - Reserved
	111110b - Reserved
	111111b - Module is disabled

44.4.3 ADC Configuration Register 1 (CFG1)

44.4.3.1 Offset

Register	Offset
CFG1	40h

44.4.3.2 Function

Configuration Register 1 (CFG1) selects the mode of operation, clock source, clock divide.

44.4.3.3 Diagram

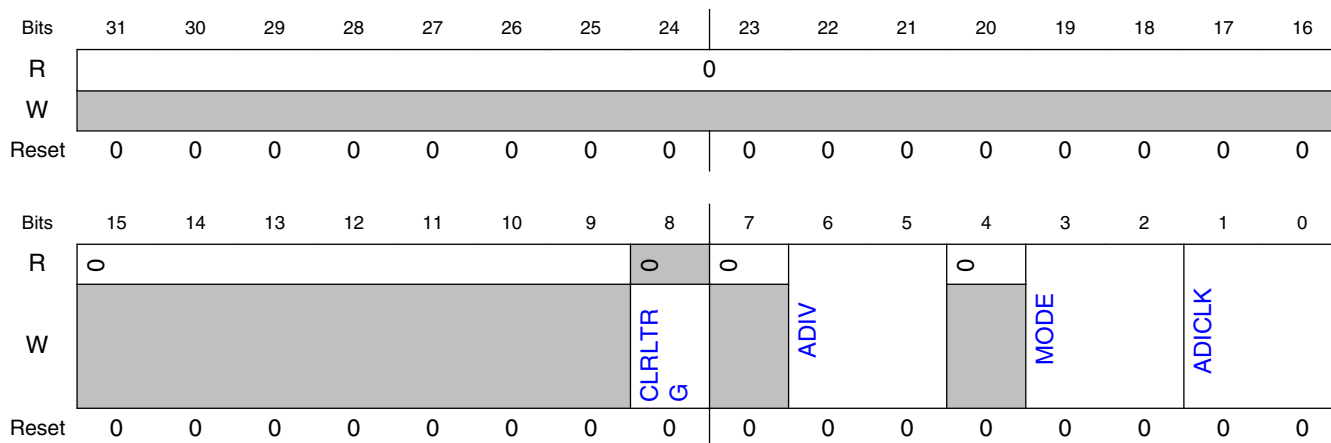

44.4.3.4 Fields

Field	Function
31-9 —	Reserved
8 CLRLTRG	<p>Clear Latch Trigger in Trigger Handler Block</p> <p>Writing a 1 to this field clears all the latched triggers inside the trigger handler except the one under processing. Writing 0 has no effect. This is a write-only-one bit that self-clears immediately.</p> <p>NOTE: You need to wait a time period equal to a total of 2.5 cycles of ADC operating clock after writing 1 to the CLRLTRG field to ensure that all latched triggers are cleared.</p> <p>NOTE: This field is not supported in every instance. The following table includes only supported registers.</p>

Table continues on the next page...

Field	Function	
	Field supported in	Field not supported in
	—	ADC0_CFG1
	ADC1_CFG1	—
7 —	Reserved	
6-5 ADIV	Clock Divide Select Selects the divide ratio used by the ADC to generate the internal clock ADCK. 00b - The divide ratio is 1 and the clock rate is input clock. 01b - The divide ratio is 2 and the clock rate is (input clock)/2. 10b - The divide ratio is 4 and the clock rate is (input clock)/4. 11b - The divide ratio is 8 and the clock rate is (input clock)/8.	
4 —	Reserved	
3-2 MODE	Conversion mode selection Selects the ADC resolution. 00b - 8-bit conversion. 01b - 12-bit conversion. 10b - 10-bit conversion. 11b - Reserved	
1-0 ADICLK	Input Clock Select Selects the input clock source to generate the internal clock, ADCK. See the clock distribution/clocking chapter of your device for details on which alternate clocks are supported. 00b - Alternate clock 1 (ALTCLK1) 01b - Alternate clock 2 (ALTCLK2) 10b - Alternate clock 3 (ALTCLK3) 11b - Alternate clock 4 (ALTCLK4)	

44.4.4 ADC Configuration Register 2 (CFG2)

44.4.4.1 Offset

Register	Offset
CFG2	44h

44.4.4.2 Function

Configuration Register 2 (CFG2) selects the long sample time duration during long sample mode.

NOTE

Writing 0 is not supported on this register.

44.4.4.3 Diagram

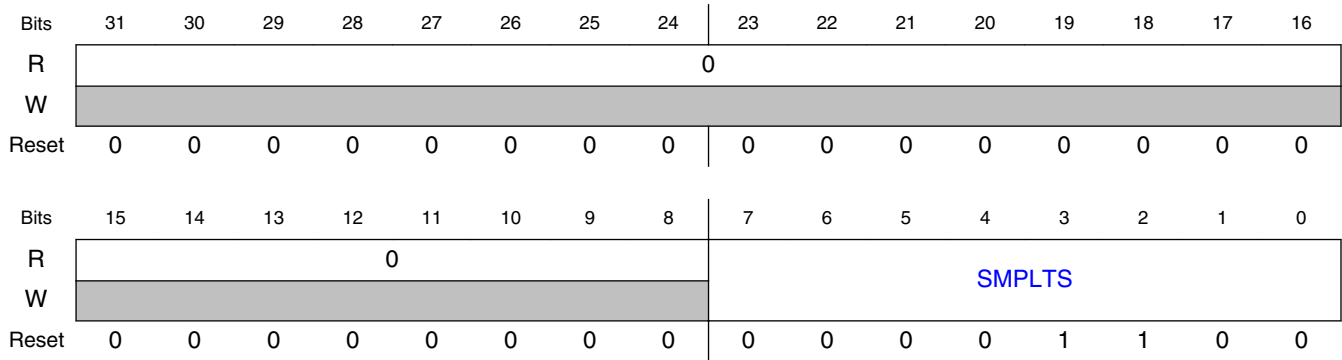

44.4.4.4 Fields

Field	Function
31-8 —	Reserved
7-0 SMPLTS	Sample Time Select Selects a sample time of 2 to 256 ADCK clock cycles. The value written to this register field is the desired sample time minus 1. A sample time of 1 is not supported. Allows higher impedance inputs to be accurately sampled or conversion speed to be maximized for lower impedance inputs. Longer sample times can also be used to lower overall power consumption when continuous conversions are enabled if high conversion rates are not required.

44.4.5 ADC Data Result Registers (RA - aRP)

44.4.5.1 Offset

For a = A to P (0 to 15):

Register	Offset
Ra	48h + (a × 4h)
aRa (alias for Ra)	188h + (a × 4h)

44.4.5.2 Function

The data result registers (Rn) contain the result of an ADC conversion of the channel selected by the corresponding status and channel control register (SC1A:SC1n). For every status and channel control register, there is a corresponding data result register.

Unused bits in Rn are cleared.

The following table describes the behavior of the data result registers in the different modes of operation.

Table 44-2. Data result register description

Conversion mode	D11	D10	D9	D8	D7	D6	D5	D4	D3	D2	D1	D0	Format
12-bit single-ended	D												Unsigned right-justified
10-bit single-ended	0	D											
8-bit single-ended	0				D								

D: Data. The data result registers are read-only; writing to these registers generates a transfer error.

44.4.5.3 Diagram

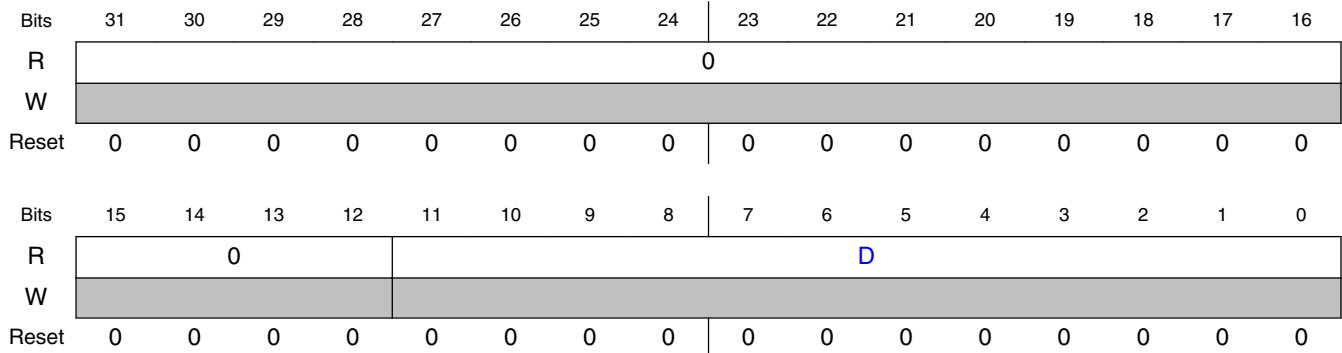

44.4.5.4 Fields

Field	Function
31-12	Reserved
—	

Table continues on the next page...

ADC register descriptions

Field	Function
11-0 D	Data result

44.4.6 Compare Value Registers (CV1 - CV2)

44.4.6.1 Offset

Register	Offset
CV1	88h
CV2	8Ch

44.4.6.2 Function

The Compare Value Registers (CV1 and CV2) contain a compare value used to compare the conversion result when the compare function is enabled, that is, SC2[ACFE]=1. This register is formatted in the same way as the Rn registers. Therefore, the compare function uses only the CVn fields that are related to the ADC mode of operation. CV2 is used only when the compare range function is enabled, that is, SC2[ACREN]=1.

44.4.6.3 Diagram

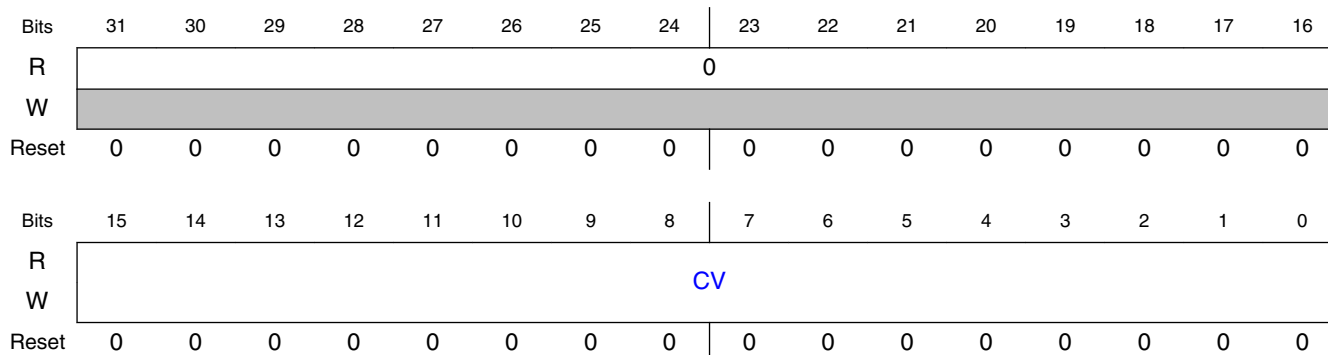

44.4.6.4 Fields

Field	Function
31-16 —	Reserved
15-0 CV	Compare Value.

44.4.7 Status and Control Register 2 (SC2)

44.4.7.1 Offset

Register	Offset
SC2	90h

44.4.7.2 Function

The status and control register 2 (SC2) contains the conversion active, hardware/software trigger select, compare function, and voltage reference select of the ADC module.

44.4.7.3 Diagram

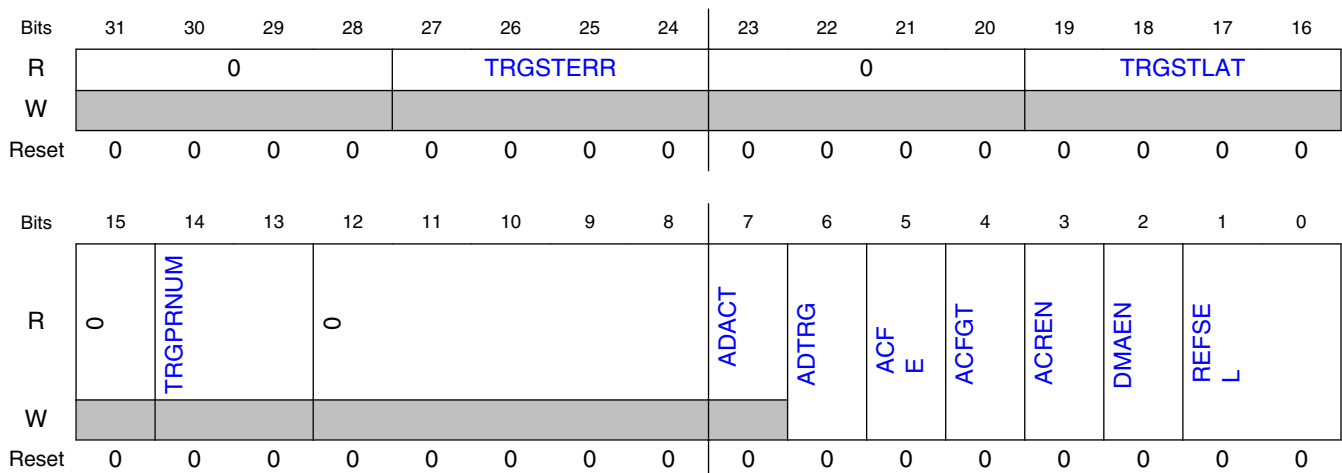

44.4.7.4 Fields

Field	Function						
31-28 —	Reserved						
27-24 TRGSTERR	<p>Error in Multiplexed Trigger Request</p> <p>Each of these error signals indicate that a multiplexed hardware trigger request from a source has been missed, in which case the request has already been latched or is being serviced. Each bit in this field can be cleared by writing a 1 to it, and each bit corresponds to an individual trigger request:</p> <ul style="list-style-type: none"> • Bit 24 corresponds to trigger request 0 • Bit 25 corresponds to trigger request 1 • Bit 26 corresponds to trigger request 2 • Bit 27 corresponds to trigger request 3 <p>The read value of each bit in this field is interpreted individually as follows:</p> <p>NOTE: This field is not supported in every instance. The following table includes only supported registers.</p> <table border="1"> <thead> <tr> <th>Field supported in</th> <th>Field not supported in</th> </tr> </thead> <tbody> <tr> <td>—</td> <td>ADC0_SC2</td> </tr> <tr> <td>ADC1_SC2</td> <td>—</td> </tr> </tbody> </table> <p>0000b - No error has occurred 0001b - An error has occurred</p>	Field supported in	Field not supported in	—	ADC0_SC2	ADC1_SC2	—
Field supported in	Field not supported in						
—	ADC0_SC2						
ADC1_SC2	—						
23-20 —	Reserved						
19-16 TRGSTLAT	<p>Trigger Status</p> <p>Each of these status bits indicate that a multiplexed hardware trigger request from a source has been latched. Each bit in this field corresponds to an individual trigger request:</p> <ul style="list-style-type: none"> • Bit 16 corresponds to trigger request 0 • Bit 17 corresponds to trigger request 1 • Bit 18 corresponds to trigger request 2 • Bit 19 corresponds to trigger request 3 <p>The read value of each bit in this field is interpreted individually as follows:</p> <p>NOTE: This field is not supported in every instance. The following table includes only supported registers.</p> <table border="1"> <thead> <tr> <th>Field supported in</th> <th>Field not supported in</th> </tr> </thead> <tbody> <tr> <td>—</td> <td>ADC0_SC2</td> </tr> <tr> <td>ADC1_SC2</td> <td>—</td> </tr> </tbody> </table> <p>0000b - No trigger request has been latched 0001b - A trigger request has been latched</p>	Field supported in	Field not supported in	—	ADC0_SC2	ADC1_SC2	—
Field supported in	Field not supported in						
—	ADC0_SC2						
ADC1_SC2	—						
15 —	Reserved						

Table continues on the next page...

Field	Function						
14-13 TRGPRNUM	<p>Trigger Process Number</p> <p>Indicates the trigger number that is being serviced. This has to be qualified with the 1-bit value for the corresponding trigger latch status.</p> <ul style="list-style-type: none"> • TRGPRNUM=00 is valid only if TRGSTLAT[16]=1 • TRGPRNUM=01 is valid only if TRGSTLAT[17]=1 • TRGPRNUM=10 is valid only if TRGSTLAT[18]=1 • TRGPRNUM=11 is valid only if TRGSTLAT[19]=1 <p>NOTE: Occasionally there may be a mismatch between the TRGPRNUM and the ideal trigger to be selected as per TRGSTLAT by Round Robin algorithm. This happens because of different operating clocks of the TRGSTLAT and the hardware logic. The TRGSTLAT is updated first with arrival of triggers, and then it is synchronized into the hardware clock. So, the hardware uses a delayed version of TRGSTLAT. Any trigger that arrives during the synchronization time is not presented to hardware immediately, but shows in TRGSTLAT.</p> <p>NOTE: This field is not supported in every instance. The following table includes only supported registers.</p> <table border="1"> <thead> <tr> <th>Field supported in</th> <th>Field not supported in</th> </tr> </thead> <tbody> <tr> <td>—</td> <td>ADC0_SC2</td> </tr> <tr> <td>ADC1_SC2</td> <td>—</td> </tr> </tbody> </table>	Field supported in	Field not supported in	—	ADC0_SC2	ADC1_SC2	—
Field supported in	Field not supported in						
—	ADC0_SC2						
ADC1_SC2	—						
12-8 —	Reserved						
7 ADACT	<p>Conversion Active</p> <p>Indicates that a conversion or hardware averaging is in progress. ADACT is set when a conversion is initiated and cleared when a conversion is completed or aborted.</p> <p>0b - Conversion not in progress. 1b - Conversion in progress.</p>						
6 ADTRG	<p>Conversion Trigger Select</p> <p>Selects the type of trigger used for initiating a conversion. Two types of triggers can be selected:</p> <ul style="list-style-type: none"> • Software trigger: When software trigger is selected, a conversion is initiated following a write to SC1A. • Hardware trigger: When hardware trigger is selected, a conversion is initiated following the assertion of the ADHWT input after a pulse of the ADHWTSn input. <p>0b - Software trigger selected. 1b - Hardware trigger selected.</p>						
5 ACFE	<p>Compare Function Enable</p> <p>Enables the compare function.</p> <p>0b - Compare function disabled. 1b - Compare function enabled.</p>						
4 ACFGT	<p>Compare Function Greater Than Enable</p> <p>Configures the compare function to check the conversion result relative to CV1 and CV2 based upon the value of ACREN. ACFE must be set for ACFGT to have any effect. See Table 44-5 "Compare modes" for further details.</p>						
3 ACREN	<p>Compare Function Range Enable</p> <p>Configures the compare function to check if the conversion result of the input being monitored is either between or outside the range formed by CV1 and CV2 determined by the value of ACFGT. ACFE must be set for ACFGT to have any effect. See Table 44-5 "Compare modes" for further details.</p>						

Table continues on the next page...

ADC register descriptions

Field	Function
2 DMAEN	DMA Enable 0b - DMA is disabled. 1b - DMA is enabled and will assert the ADC DMA request during an ADC conversion complete event , which is indicated when any SC1n[COCO] flag is asserted.
1-0 REFSEL	Voltage Reference Selection Selects the voltage reference source used for conversions. 00b - Default voltage reference pin pair, that is, external pins V_{REFH} and V_{REFL} 01b - Alternate reference voltage, that is, V_{ALTH} . This voltage may be additional external pin or internal source depending on the MCU configuration. See the chip configuration information for details specific to this MCU. 10b - Reserved 11b - Reserved

44.4.8 Status and Control Register 3 (SC3)

44.4.8.1 Offset

Register	Offset
SC3	94h

44.4.8.2 Function

The Status and Control Register 3 (SC3) controls the calibration, continuous conversion, and hardware averaging functions of the ADC module.

44.4.8.3 Diagram

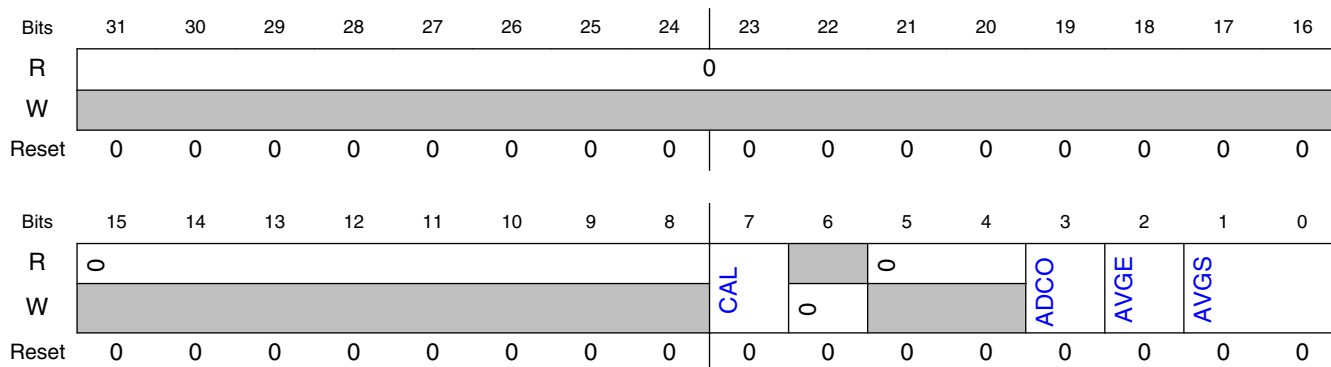

44.4.8.4 Fields

Field	Function
31-8 —	Reserved
7 CAL	<p>Calibration</p> <p>When CAL=1, the ADC begins the calibration sequence. This field stays set while the calibration is in progress and is cleared when the calibration sequence is completed. After it is started, the calibration routine cannot be interrupted by writes to the ADC registers or the results will be invalid. Setting CAL will abort any current conversion.</p> <p>NOTE: For calibration, it is mandatory to use averaging and average number 32.</p> <p>NOTE: If several ADCs are on a device, they should be calibrated sequentially. No parallel calibrations of ADCs are allowed because they will disturb each other.</p>
6 —	Reserved
5-4 —	Reserved
3 ADCO	<p>Continuous Conversion Enable</p> <p>Enables continuous conversions.</p> <p>0b - One conversion will be performed (or one set of conversions, if AVGE is set) after a conversion is initiated.</p> <p>1b - Continuous conversions will be performed (or continuous sets of conversions, if AVGE is set) after a conversion is initiated.</p>
2 AVGE	<p>Hardware Average Enable</p> <p>Enables the hardware average function of the ADC.</p> <p>0b - Hardware average function disabled.</p> <p>1b - Hardware average function enabled.</p>
1-0 AVGS	<p>Hardware Average Select</p> <p>Determines how many ADC conversions will be averaged to create the ADC average result.</p> <p>00b - 4 samples averaged.</p> <p>01b - 8 samples averaged.</p> <p>10b - 16 samples averaged.</p> <p>11b - 32 samples averaged.</p>

44.4.9 BASE Offset Register (BASE_OFS)

44.4.9.1 Offset

Register	Offset
BASE_OFS	98h

44.4.9.2 Function

The BASE Offset Register (BASE_OFS) contains the offset value used by the calibration algorithm to determine the Offset Calibration Value (OFS).

44.4.9.3 Diagram

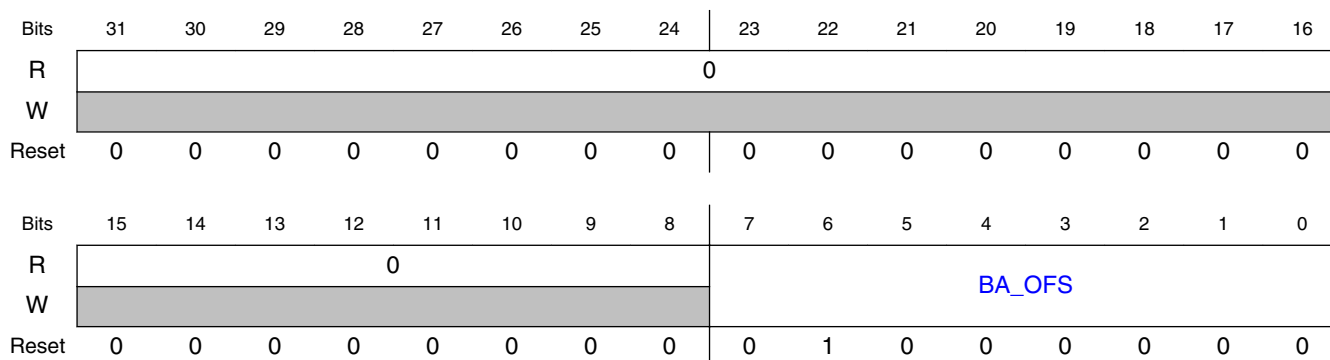

44.4.9.4 Fields

Field	Function
31-8 —	Reserved
7-0 BA_OFS	Base Offset Error Correction Value

44.4.10 ADC Offset Correction Register (OFS)

44.4.10.1 Offset

Register	Offset
OFS	9Ch

44.4.10.2 Function

The ADC Offset Correction Register (OFS) contains the calibration-generated offset error correction value (OFS). The value in BA_OFS is used in the calibration algorithm to calculate the offset correction value that gets stored in the OFS register. The value in OFS is subtracted from the conversion and the result is transferred into the result registers, Rn. If the result is greater than the maximum or less than the minimum result value, it is forced to the appropriate limit for the current mode of operation.

NOTE

If offset register is set to a negative value and it is lower than or equal to 0xFFFF8, the ADC will not result code 0. If offset register is set to a negative value and it is lower than or equal to 0xFFFF0, the ADC will not result code 1.

44.4.10.3 Diagram

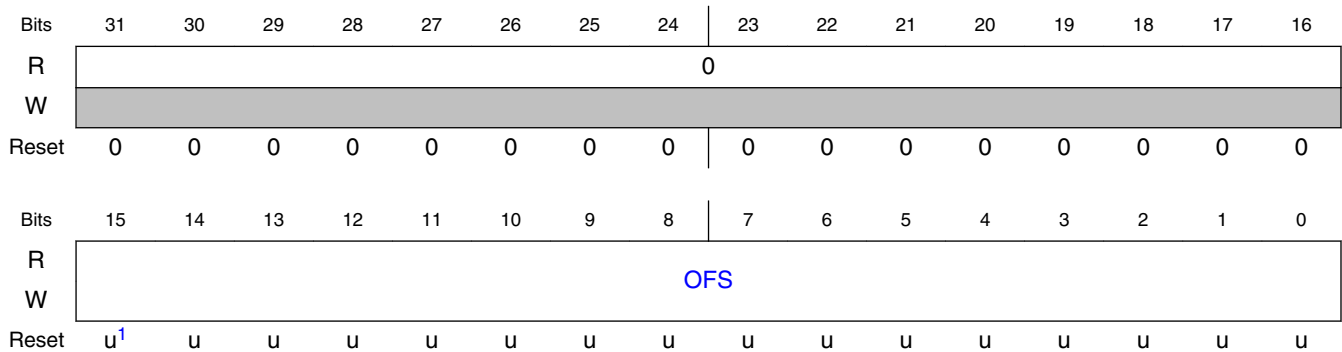

1. Reset values are loaded out of IFR.

44.4.10.4 Fields

Field	Function
31-16 —	Reserved
15-0 OFS	Offset Error Correction Value

44.4.11 USER Offset Correction Register (USR_OFS)

44.4.11.1 Offset

Register	Offset
USR_OFS	A0h

44.4.11.2 Function

The ADC USER Offset Correction Register (USR_OFS) contains the user defined offset error correction value used in the conversion result error correction algorithm.

44.4.11.3 Diagram

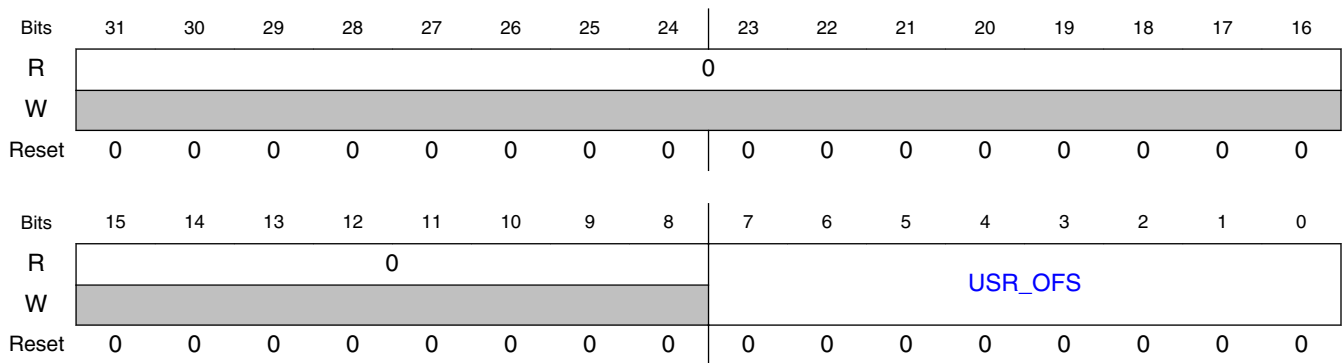

44.4.11.4 Fields

Field	Function
31-8 —	Reserved
7-0 USR_OFS	USER Offset Error Correction Value

44.4.12 ADC X Offset Correction Register (XOFS)

44.4.12.1 Offset

Register	Offset
XOFS	A4h

44.4.12.2 Function

The ADC X Offset Correction Register (XOFS) contains the X offset used in the conversion result error correction algorithm.

44.4.12.3 Diagram

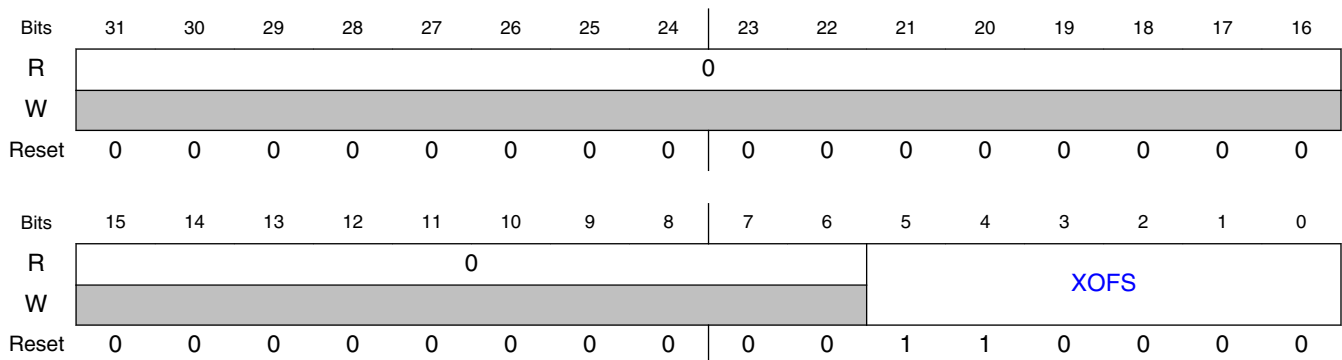

44.4.12.4 Fields

Field	Function
31-6 —	Reserved
5-0 XOFS	X offset error correction value

44.4.13 ADC Y Offset Correction Register (YOFS)

44.4.13.1 Offset

Register	Offset
YOFS	A8h

44.4.13.2 Function

The ADC Y Offset Correction Register (YOFS) contains the Y offset used in the conversion result error correction algorithm.

44.4.13.3 Diagram

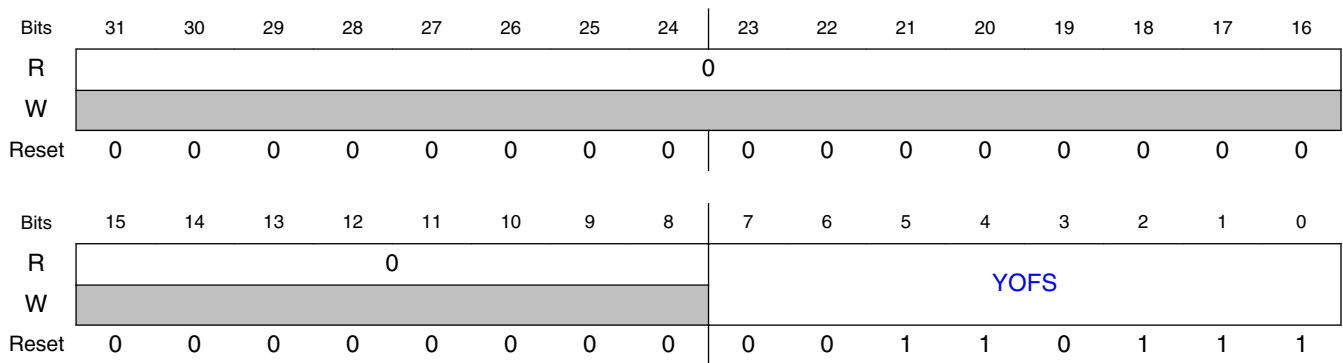

44.4.13.4 Fields

Field	Function
31-8 —	Reserved
7-0 YOFS	Y offset error correction value

44.4.14 ADC Gain Register (G)

44.4.14.1 Offset

Register	Offset
G	ACh

44.4.14.2 Function

The Gain Register (G) contains the gain error correction for the overall conversion. G, a 11-bit real number in binary format, is the gain adjustment factor. This register value is determined and uploaded by the calibration algorithm.

44.4.14.3 Diagram

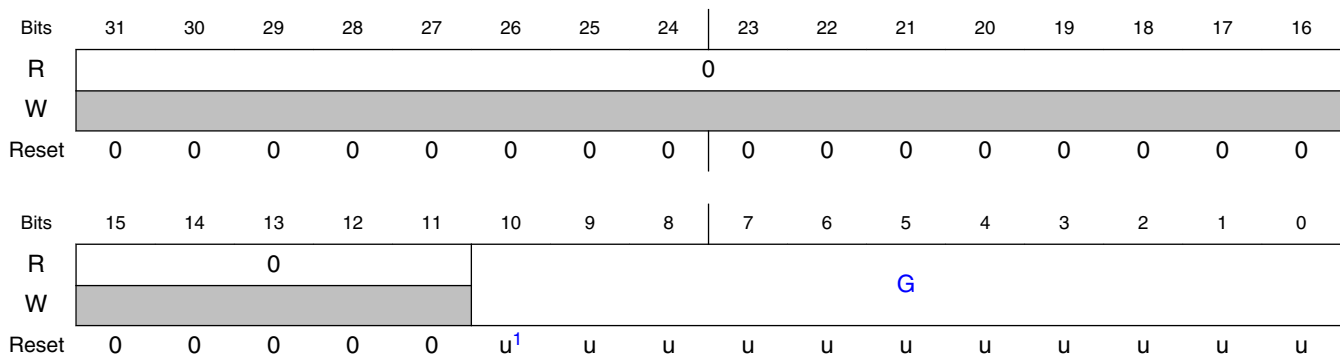

1. Reset values are loaded out of IFR.

44.4.14.4 Fields

Field	Function
31-11	Reserved
—	
10-0	G
G	Gain error adjustment factor for the overall conversion

44.4.15 ADC User Gain Register (UG)

44.4.15.1 Offset

Register	Offset
UG	B0h

44.4.15.2 Function

The User Gain Register (UG) contains the user gain error correction. It allows you to adjust the final calibration gain value. This register must be written before calibrating the ADC.

44.4.15.3 Diagram

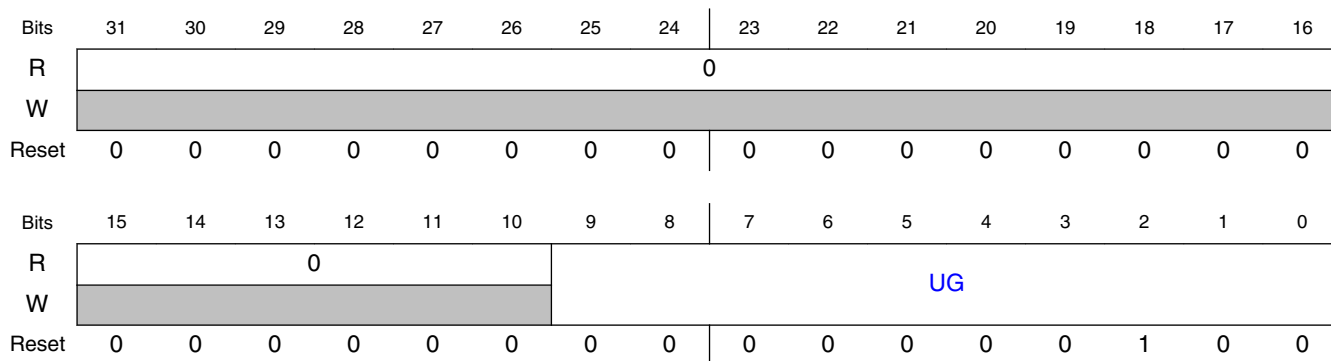

44.4.15.4 Fields

Field	Function
31-10	Reserved
—	
9-0	UG
UG	User gain error correction value

44.4.16 ADC General Calibration Value Register S (CLPS)

44.4.16.1 Offset

Register	Offset
CLPS	B4h

44.4.16.2 Function

The General Calibration Value Registers (CLP_x) contain calibration information that is generated by the calibration function. These registers contain seven signed calibration values of varying widths in two's complement format. CLP_x are automatically set when the self-calibration sequence is done, that is, CAL is cleared. If these registers are written by the user after calibration, the linearity error specifications may not be met.

44.4.16.3 Diagram

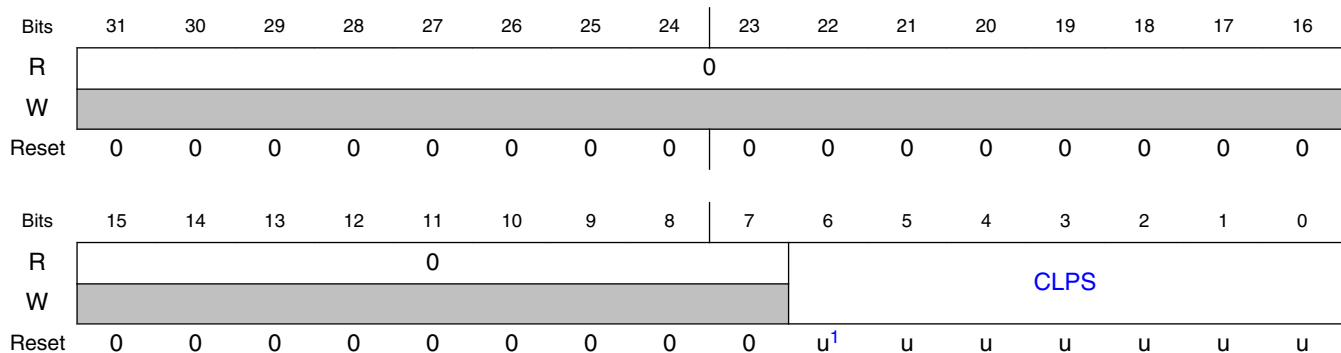

1. Reset values are loaded out of IFR.

44.4.16.4 Fields

Field	Function
31-7	Reserved
—	

Table continues on the next page...

ADC register descriptions

Field	Function
6-0	CLPS
CLPS	Calibration Value

44.4.17 ADC Plus-Side General Calibration Value Register 3 (CLP3)

44.4.17.1 Offset

Register	Offset
CLP3	B8h

44.4.17.2 Diagram

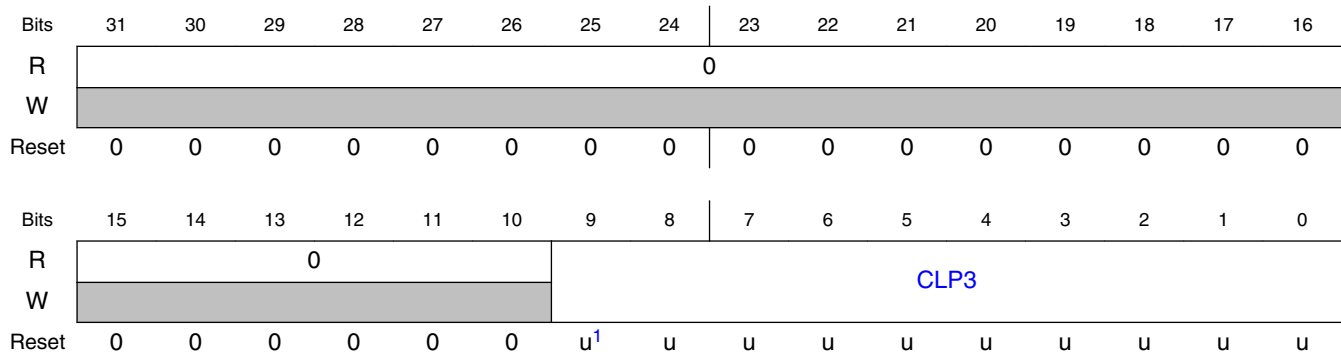

1. Reset values are loaded out of IFR.

44.4.17.3 Fields

Field	Function
31-10	Reserved
—	
9-0	CLP3
CLP3	Calibration Value

44.4.18 ADC Plus-Side General Calibration Value Register 2 (CLP2)

44.4.18.1 Offset

Register	Offset
CLP2	BCh

44.4.18.2 Diagram

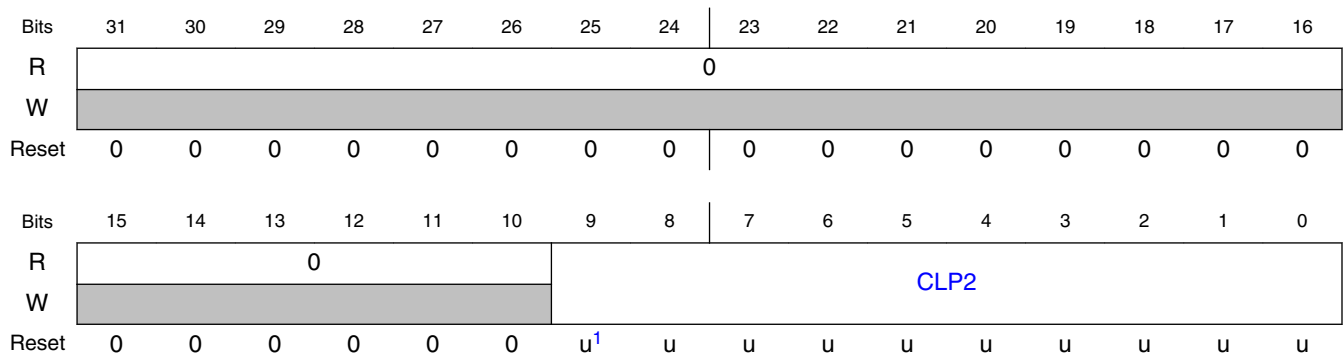

1. Reset values are loaded out of IFR.

44.4.18.3 Fields

Field	Function
31-10	Reserved
—	
9-0	CLP2
CLP2	Calibration Value

44.4.19 ADC Plus-Side General Calibration Value Register 1 (CLP1)

44.4.19.1 Offset

Register	Offset
CLP1	C0h

44.4.19.2 Diagram

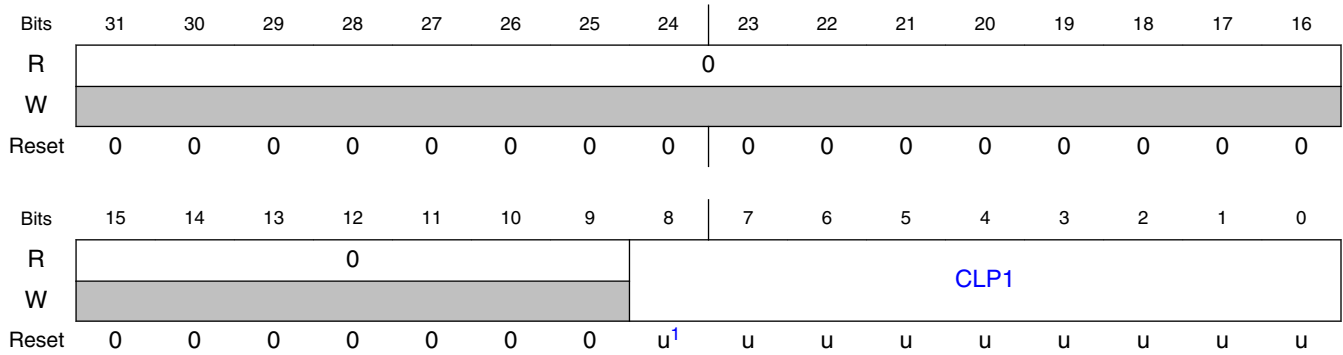

1. Reset values are loaded out of IFR.

44.4.19.3 Fields

Field	Function
31-9	Reserved
—	
8-0	CLP1
CLP1	Calibration Value

44.4.20 ADC Plus-Side General Calibration Value Register 0 (CLP0)

44.4.20.1 Offset

Register	Offset
CLP0	C4h

44.4.20.2 Diagram

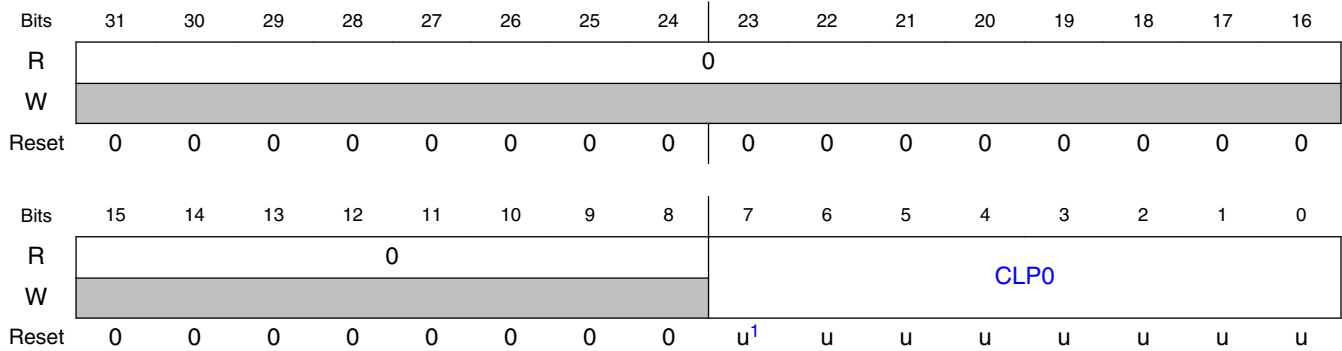

1. Reset values are loaded out of IFR.

44.4.20.3 Fields

Field	Function
31-8 —	Reserved
7-0 CLP0	CLP0 Calibration Value

44.4.21 ADC Plus-Side General Calibration Value Register X (CLPX)

44.4.21.1 Offset

Register	Offset
CLPX	C8h

44.4.21.2 Diagram

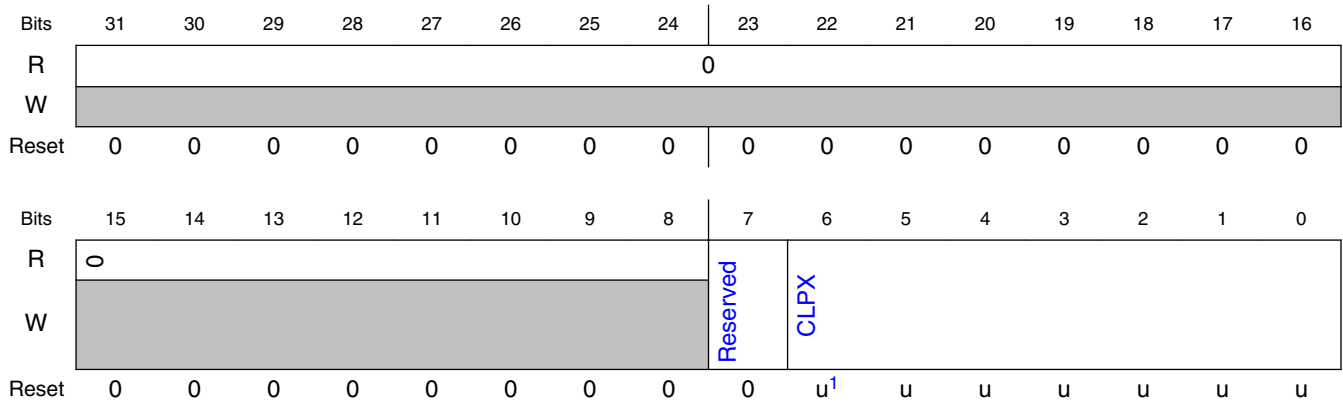

1. Reset values are loaded out of IFR.

44.4.21.3 Fields

Field	Function
31-8 —	Reserved
7 —	Reserved
6-0 CLPX	CLPX Calibration Value

44.4.22 ADC Plus-Side General Calibration Value Register 9 (CLP9)

44.4.22.1 Offset

Register	Offset
CLP9	CCh

44.4.22.2 Diagram

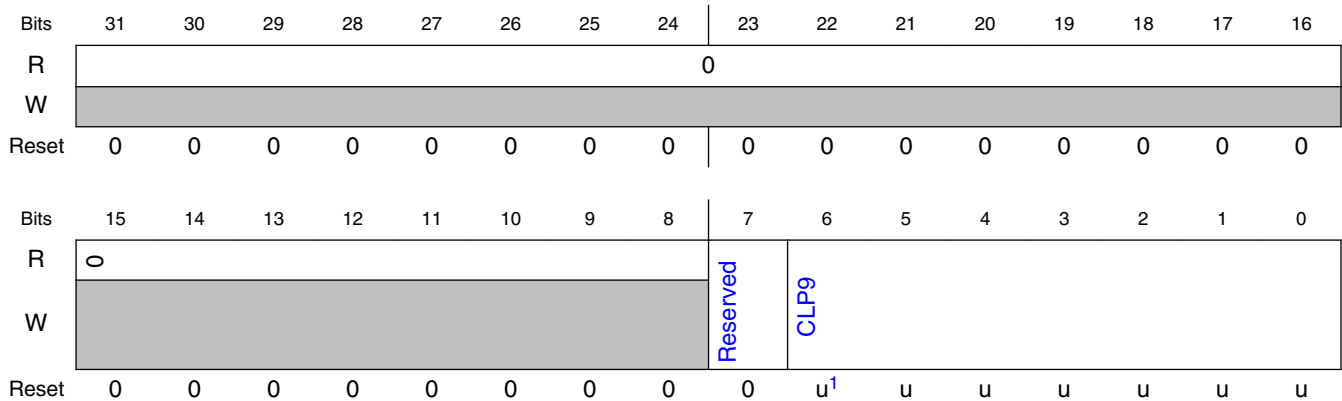

1. Reset values are loaded out of IFR.

44.4.22.3 Fields

Field	Function
31-8 —	Reserved
7 —	Reserved
6-0 CLP9	CLP9 Calibration Value

44.4.23 ADC General Calibration Offset Value Register S (CLPS_OFS)

44.4.23.1 Offset

Register	Offset
CLPS_OFS	D0h

44.4.23.2 Function

44.4.23.3 Diagram

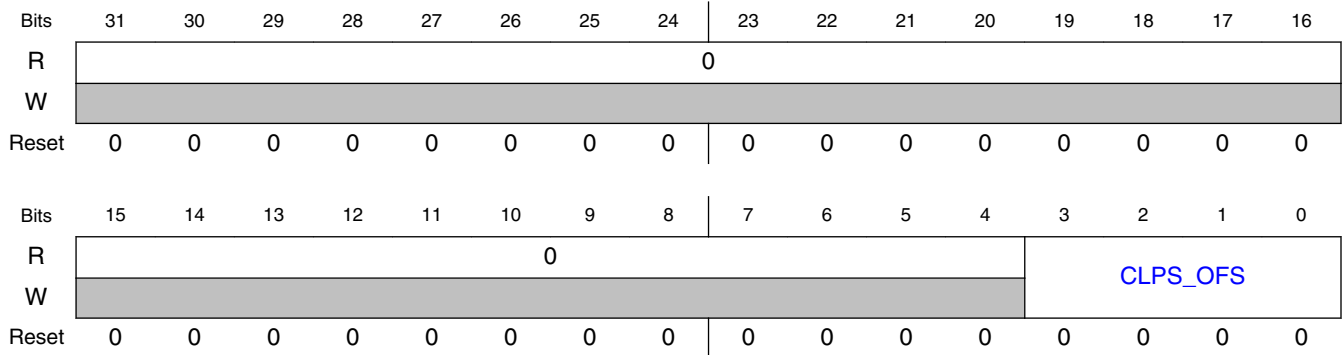

44.4.23.4 Fields

Field	Function
31-4 —	Reserved
3-0 CLPS_OFS	CLPS Offset Capacitor offset correction value

44.4.24 ADC Plus-Side General Calibration Offset Value Register 3 (CLP3_OFS)

44.4.24.1 Offset

Register	Offset
CLP3_OFS	D4h

44.4.24.2 Diagram

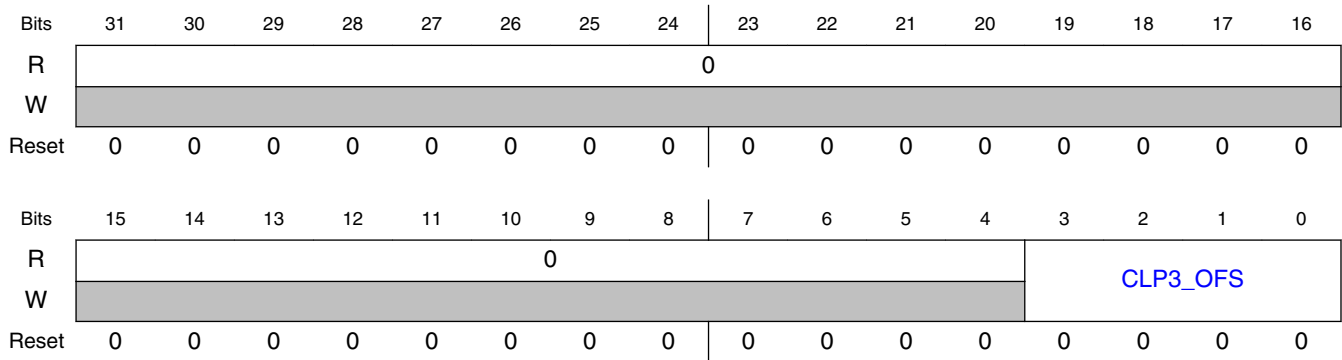

44.4.24.3 Fields

Field	Function
31-4 —	Reserved
3-0 CLP3_OFS	CLP3 Offset Capacitor offset correction value

44.4.25 ADC Plus-Side General Calibration Offset Value Register 2 (CLP2_OFS)

44.4.25.1 Offset

Register	Offset
CLP2_OFS	D8h

44.4.25.2 Diagram

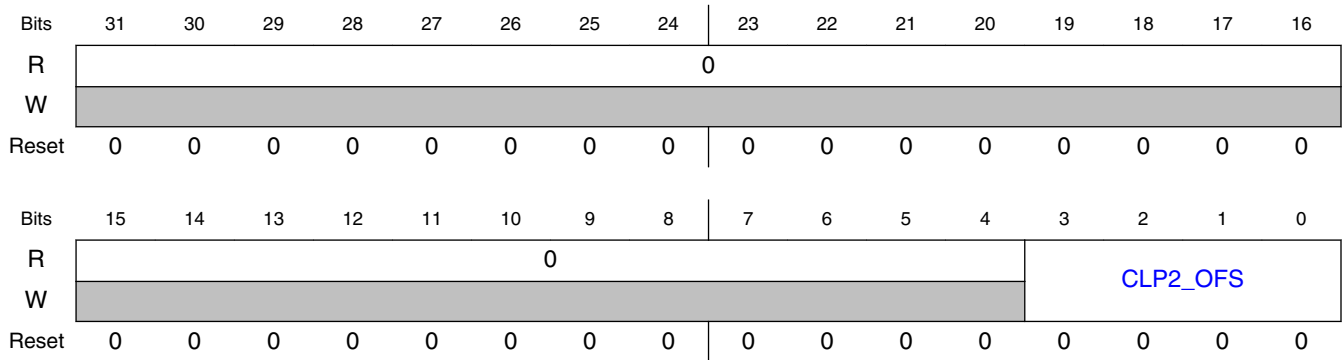

44.4.25.3 Fields

Field	Function
31-4 —	Reserved
3-0 CLP2_OFS	CLP2 Offset Capacitor offset correction value

44.4.26 ADC Plus-Side General Calibration Offset Value Register 1 (CLP1_OFS)

44.4.26.1 Offset

Register	Offset
CLP1_OFS	DCh

44.4.26.2 Diagram

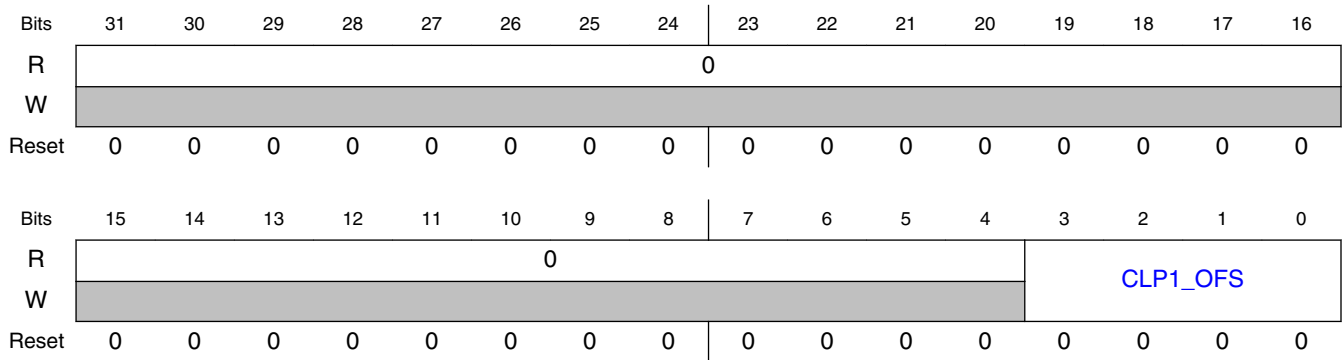

44.4.26.3 Fields

Field	Function
31-4 —	Reserved
3-0 CLP1_OFS	CLP1 Offset Capacitor offset correction value

44.4.27 ADC Plus-Side General Calibration Offset Value Register 0 (CLP0_OFS)

44.4.27.1 Offset

Register	Offset
CLP0_OFS	E0h

44.4.27.2 Diagram

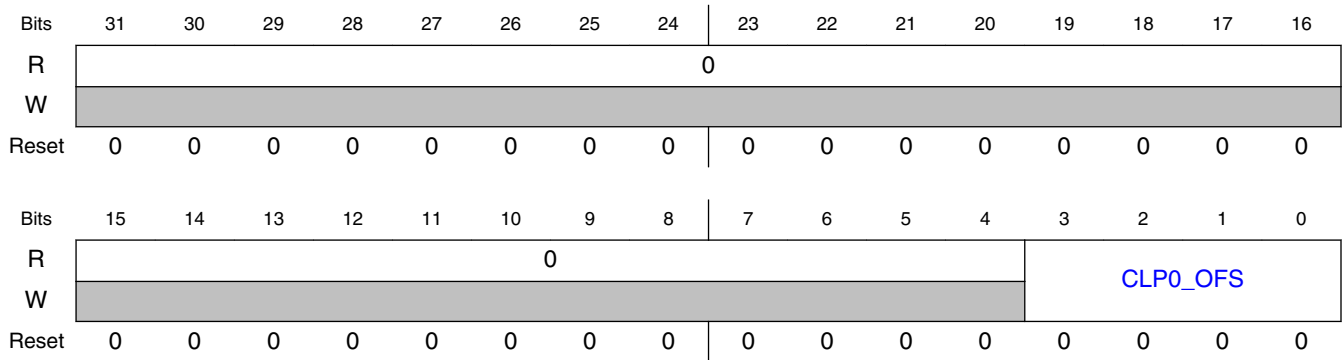

44.4.27.3 Fields

Field	Function
31-4 —	Reserved
3-0 CLP0_OFS	CLP0 Offset Capacitor offset correction value

44.4.28 ADC Plus-Side General Calibration Offset Value Register X (CLPX_OFS)

44.4.28.1 Offset

Register	Offset
CLPX_OFS	E4h

44.4.28.2 Diagram

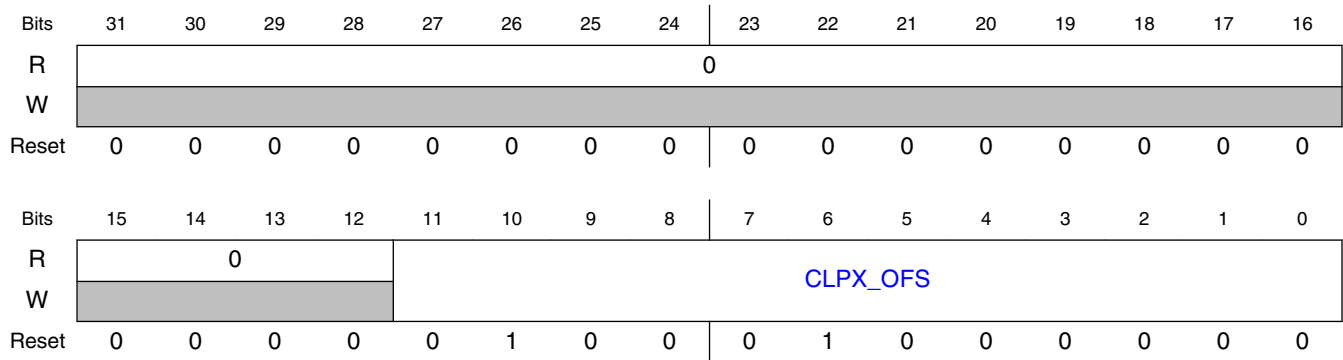

44.4.28.3 Fields

Field	Function
31-12 —	Reserved
11-0 CLPX_OFS	CLPX Offset Capacitor offset correction value

44.4.29 ADC Plus-Side General Calibration Offset Value Register 9 (CLP9_OFS)

44.4.29.1 Offset

Register	Offset
CLP9_OFS	E8h

44.4.29.2 Diagram

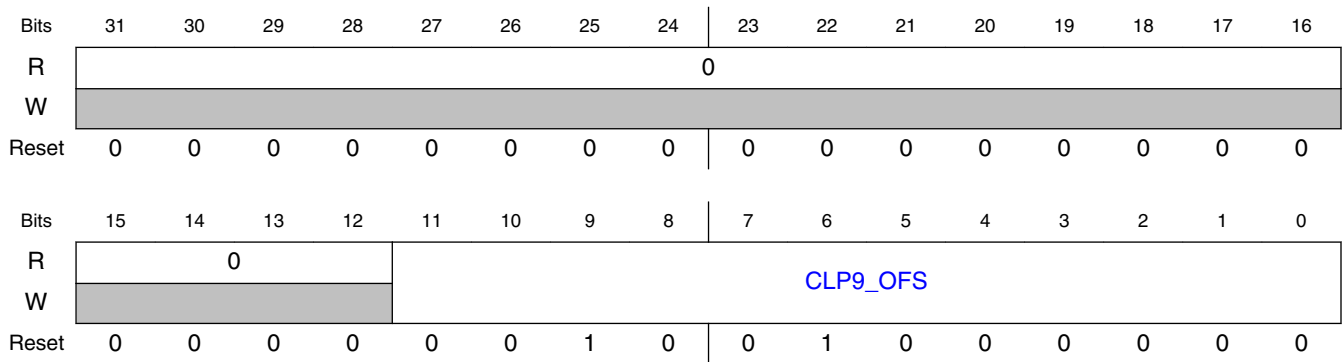

44.4.29.3 Fields

Field	Function
31-12 —	Reserved
11-0 CLP9_OFS	CLP9 Offset Capacitor offset correction value

44.4.30 ADC Status and Control Register 1 (SC1AA - SC1Z)

44.4.30.1 Offset

Register	Offset
SC1Q	148h
SC1R	14Ch
SC1S	150h
SC1T	154h
SC1U	158h
SC1V	15Ch
SC1W	160h
SC1X	164h
SC1Y	168h
SC1Z	16Ch

Table continues on the next page...

Register	Offset
SC1AA	170h
SC1AB	174h
SC1AC	178h
SC1AD	17Ch
SC1AE	180h
SC1AF	184h

44.4.30.2 Function

SC1A is used for both software and hardware trigger modes of operation.

At any one point in time, only one of the SC1 n registers is actively controlling ADC sequential conversions. Updating SC1A while SC1 n is actively controlling a conversion is allowed, and vice versa for any of the SC1 n registers specific to this MCU.

Writing to the SC1A register while SC1A is actively controlling a conversion aborts the current conversion. In Software Trigger mode (when SC2[ADTRG]=0), writes to SC1A initiate a new conversion. This is valid for all values of SC1A[ADCH] other than all 1s (module disabled).

Writing any of the SC1 n registers while that specific SC1 n register is actively controlling a conversion aborts the current conversion. None of the SC1B-SC1 n registers are used for software trigger operation and therefore writes to the SC1BSC1 n registers do not initiate a new conversion.

44.4.30.3 Diagram

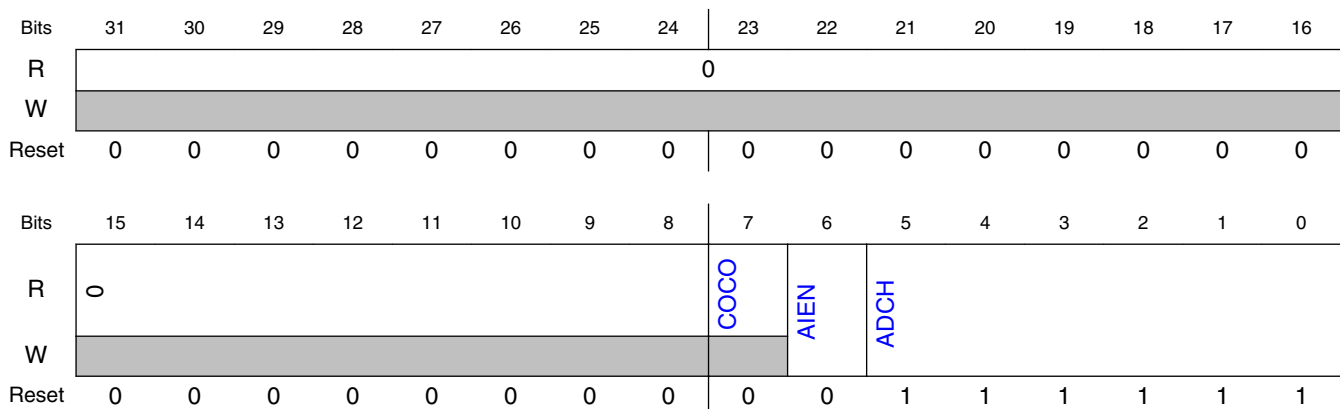

44.4.30.4 Fields

Field	Function
31-8 —	Reserved
7 COCO	Conversion Complete Flag 0b - Conversion is not completed. 1b - Conversion is completed.
6 AIEN	Interrupt Enable 0b - Conversion complete interrupt is disabled. 1b - Conversion complete interrupt is enabled.
5-0 ADCH	Input channel select 000000b - External channel 0 is selected as input. 000001b - External channel 1 is selected as input. 000010b - External channel 2 is selected as input. 000011b - External channel 3 is selected as input. 000100b - External channel 4 is selected as input. 000101b - External channel 5 is selected as input. 000110b - External channel 6 is selected as input. 000111b - External channel 7 is selected as input. 001000b - External channel 8 is selected as input. 001001b - External channel 9 is selected as input. 001010b - External channel 10 is selected as input. 001011b - External channel 11 is selected as input. 001100b - External channel 12 is selected as input. 001101b - External channel 13 is selected as input. 001110b - External channel 14 is selected as input. 001111b - External channel 15 is selected as input. 010000b - Reserved 010001b - Reserved 010010b - Reserved 010011b - Reserved 010100b - Reserved 010101b - Internal channel 0 is selected as input. 010110b - Internal channel 1 is selected as input. 010111b - Internal channel 2 is selected as input. 011000b - Reserved 011001b - Reserved 011010b - Reserved 011011b - Band Gap 011100b - Internal channel 3 is selected as input. 011101b - V_{REFSH} is selected as input. Voltage reference selected is determined by SC2[REFSEL]. 011110b - V_{REFSL} is selected as input. Voltage reference selected is determined by SC2[REFSEL]. 011111b - Reserved 100000b - External channel 16 is selected as input. 100001b - External channel 17 is selected as input. 100010b - External channel 18 is selected as input. 100011b - External channel 19 is selected as input. 100100b - External channel 20 is selected as input. 100101b - External channel 21 is selected as input. 100110b - External channel 22 is selected as input. 100111b - External channel 23 is selected as input. 101000b - External channel 24 is selected as input. 101001b - External channel 25 is selected as input. 101010b - External channel 26 is selected as input.

Field	Function
	101011b - External channel 27 is selected as input.
	101100b - External channel 28 is selected as input.
	101101b - External channel 29 is selected as input.
	101110b - External channel 30 is selected as input.
	101111b - External channel 31 is selected as input.
	110000b - Reserved
	110001b - Reserved
	110010b - Reserved
	110011b - Reserved
	110100b - Reserved
	110101b - Reserved
	110110b - Reserved
	110111b - Reserved
	111000b - Reserved
	111001b - Reserved
	111010b - Reserved
	111011b - Reserved
	111100b - Reserved
	111101b - Reserved
	111110b - Reserved
	111111b - Module is disabled

44.4.31 ADC Data Result Registers (RAA - RZ)

44.4.31.1 Offset

Register	Offset
RQ	1C8h
RR	1CCh
RS	1D0h
RT	1D4h
RU	1D8h
RV	1DCh
RW	1E0h
RX	1E4h
RY	1E8h
RZ	1ECh
RAA	1F0h
RAB	1F4h
RAC	1F8h
RAD	1FCh
RAE	200h
RAF	204h

44.4.31.2 Function

The data result registers (Rn) contain the result of an ADC conversion of the channel selected by the corresponding status and channel control register (SC1A:SC1n). For every status and channel control register, there is a corresponding data result register.

Unused bits in Rn are cleared.

The following table describes the behavior of the data result registers in the different modes of operation.

Table 44-3. Data result register description

Conversion mode	D11	D10	D9	D8	D7	D6	D5	D4	D3	D2	D1	D0	Format
12-bit single-ended	D												Unsigned right-justified
10-bit single-ended	0	D											
8-bit single-ended	0				D								

D: Data. The data result registers are read-only; writing to these registers generates a transfer error.

44.4.31.3 Diagram

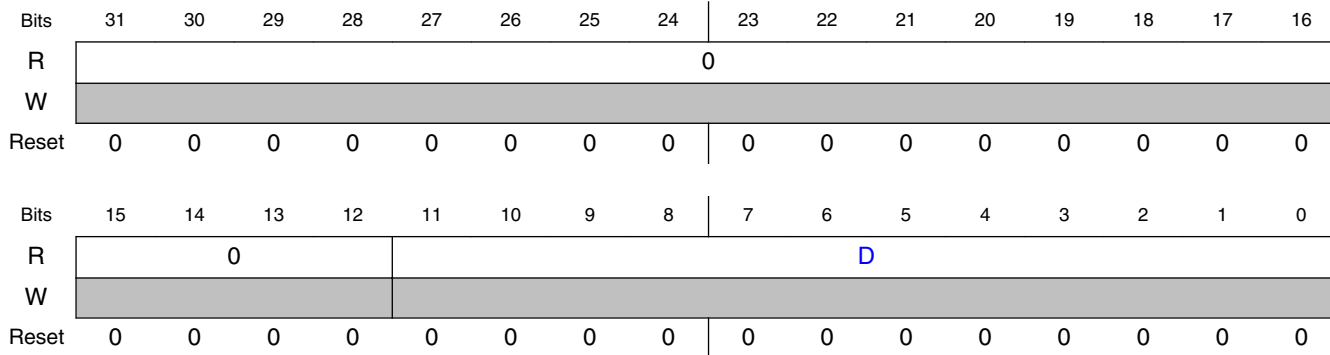

44.4.31.4 Fields

Field	Function
31-12	Reserved
—	

Table continues on the next page...

Field	Function
11-0 D	Data result

44.5 Functional description

The ADC module is disabled during reset, or when $SC1n[ADCH]$ are all high; see the power management information for details. The module is idle when a conversion has completed and another conversion has not been initiated. When it is idle the module is in its lowest power state. The ADC can perform an analog-to-digital conversion on any of the software selectable channels. All modes perform conversion by a successive approximation algorithm.

To meet accuracy specifications, the ADC module must be calibrated using the on-chip calibration function.

See [Calibration function](#) for details on how to perform calibration.

When the conversion is completed, the result is placed in the Rn data registers. The respective $SC1n[COCO]$ is then set and an interrupt is generated if the respective conversion complete interrupt has been enabled, or when $SC1n[AIEN]=1$.

The ADC module has the capability of automatically comparing the result of a conversion with the contents of the CV1 and CV2 registers. The compare function is enabled by setting $SC2[ACFE]$ and operates in any of the conversion modes and configurations.

The ADC module has the capability of automatically averaging the result of multiple conversions. The hardware average function is enabled by setting $SC3[AVGE]$ and operates in any of the conversion modes and configurations.

NOTE

For the chip-specific modes of operation, see the power management information of this chip.

44.5.1 Clock select and divide control

One of four clock sources can be selected as the clock source for the ADC module. This clock source is then divided by a configurable value to generate the input clock ADCK, to the module. The clock is selected by configuring $CFG1[ADICLK]$. $ALTCLKx$, as

defined for this MCU. See the chip configuration information. Conversions are possible using $ALTCLK_x$ as the input clock source while the MCU is in Normal Stop mode. $ALTCLK1$ is the default selection following reset.

Whichever clock is selected, its frequency must fall within the specified frequency range for $ADCK$. If the available clocks are too slow, the ADC may not perform as in the specifications. If the available clocks are too fast, the clock must be divided to the appropriate frequency. This divider is specified by $CFG1[ADIV]$ and can be divided by 1, 2, 4, or 8. The ADC bus clock frequency must be greater than or equal to the ADC ALT clock frequency. Please refer to the device *Data Sheet* for ADC specifications.

44.5.2 Voltage reference selection

The ADC can be configured to accept one of the two voltage reference pairs as the reference voltage (V_{REFSH} and V_{REFSL}) used for conversions.

Each pair contains a positive reference that must be between the minimum Ref Voltage High and V_{DDA} , and a ground reference that must be at the same potential as V_{SSA} . The two pairs are external (V_{REFH} and V_{REFL}) and alternate (V_{ALTH}). These voltage references are selected using $SC2[REFSEL]$. The alternate V_{ALTH} voltage reference may select additional external pin or internal source depending on MCU configuration. See the chip configuration information for the voltage references specific to this MCU.

44.5.3 Hardware trigger and channel selects

The ADC module has a selectable asynchronous hardware conversion trigger, $ADHWT$, that is enabled when $SC2[ADTRG]$ is set and a hardware trigger select event, $ADHWTS_n$, has occurred. This source is not available on all MCUs. See the chip-specific ADC information for information on the $ADHWT$ source and the $ADHWTS_n$ configurations specific to this MCU.

When an $ADHWT$ source is available and hardware trigger is enabled, that is $SC2[ADTRG] = 1$, a conversion is initiated on the rising edge of $ADHWT$ after a hardware trigger select event, $ADHWTS_n$, has occurred. If a conversion is in progress when a rising edge of a trigger occurs, the rising edge is ignored. In continuous conversion configuration, only the initial rising edge to launch continuous conversions is observed, and until conversion is aborted, the ADC continues to do conversions on the same SC_n register that initiated the conversion. The hardware trigger function operates in conjunction with any of the conversion modes and configurations.

The hardware trigger select event, $ADHWTSn$, must be set prior to the receipt of the ADHWT signal. If these conditions are not met, the converter may ignore the trigger or use an incorrect configuration. If a hardware trigger select event is asserted during a conversion, it must stay asserted until the end of current conversion and remain set until the receipt of the ADHWT signal to trigger a new conversion. The channel and status fields selected for the conversion depend on the active trigger select signal:

- ADHWTSA active selects SC1A.
- $ADHWTSn$ active selects SC1n.

When the conversion is completed, the result is placed in the Rn registers associated with the $ADHWTSn$ received. For example:

- ADHWTSA active selects RA register
- $ADHWTSn$ active selects Rn register

The conversion complete flag associated with the $ADHWTSn$ received, that is, $SC1n[COCO]$, is then set and an interrupt is generated if the respective conversion complete interrupt has been enabled, that is, $SC1[AIEN]=1$.

44.5.4 Conversion control

Conversion mode is selected by configuring [CFG1\[MODE\]](#).

Conversions can be initiated by a software or hardware trigger.

In addition, the ADC module can be configured for:

- Low-power operation
- Long sample time
- Continuous conversion
- Hardware average
- Automatic compare of the conversion result to a software-determined compare value

44.5.4.1 Initiating conversions

A conversion is initiated:

- Following a write to SC1A, if software-triggered operation is selected, that is, when $SC2[ADTRG] = 0$.
- Following a hardware trigger, or ADHWT event, if hardware-triggered operation is selected, that is, $SC2[ADTRG] = 1$, and a hardware trigger select event, $ADHWTSn$, has occurred. The channel and status fields that are selected depend on the active trigger select signal:

Functional description

- ADHWTS_A active selects SC1A.
- ADHWTS_{*n*} active selects SC1_{*n*}.
- if neither is active, the off condition is selected

Note

Selecting more than one ADHWTS_{*n*} prior to a conversion completion will cause unpredictable results. To avoid this, select only one ADHWTS_{*n*} prior to a conversion completion.

- Following the transfer of the result to the data registers when continuous conversion is enabled, that is, when SC3[ADCO] = 1.

If continuous conversions are enabled, a new conversion is automatically initiated after the completion of the current conversion. In software-triggered operation, that is, when SC2[ADTRG] = 0, continuous conversions begin after SC1A is written and continue until aborted. In hardware-triggered operation, that is, when SC2[ADTRG] = 1 and one ADHWTS_{*n*} event has occurred, continuous conversions begin after a hardware trigger event and continue until aborted.

If hardware averaging is enabled, a new conversion is automatically initiated after the completion of the current conversion until the correct number of conversions are completed. In software-triggered operation, conversions begin after SC1A is written. In hardware-triggered operation, conversions begin after a hardware trigger. If continuous conversions are also enabled, a new set of conversions to be averaged are initiated following the last of the selected number of conversions.

44.5.4.2 Completing conversions

A conversion is completed when the result of the conversion is transferred into the data result registers, *R_n*, as indicated in the following table.

Table 44-4. Indication of conversion completion

Compare functions	Hardware averaging	Conversion status	Is SC1 _{<i>n</i>} [COCO] set to 1, and is the conversion result transferred into the data result registers?
Disabled	Disabled	Not completed	No
Disabled	Disabled	Completed	Yes
Disabled	Enabled	Not completed	No
Disabled	Enabled	Completed	Yes, if the last of the selected number of conversions is completed
Enabled	Disabled	Not completed	No
Enabled	Disabled	Completed	Yes, if the compare condition is true

Table continues on the next page...

Table 44-4. Indication of conversion completion (continued)

Compare functions	Hardware averaging	Conversion status	Is SC1n[COCO] set to 1, and is the conversion result transferred into the data result registers?
Enabled	Enabled	Not completed	No
Enabled	Enabled	Completed	Yes, if [(the last of the selected number of conversions is completed) AND (the compare condition is true)]

An interrupt is generated if the respective SC1n[AIEN] is high at the time that the respective SC1n[COCO] is set.

44.5.4.3 Aborting conversions

Any conversion in progress is aborted when:

- Writing to SC1A while it is actively controlling a conversion aborts the current conversion. In Software Trigger mode, when SC2[ADTRG] = 0, a write to SC1A initiates a new conversion if SC1A[ADCH] is equal to a value other than all 1s. Writing to any of the SC1B-SC1n registers while that specific SC1B-SC1n register is actively controlling a conversion aborts the current conversion. The SC1B-SC1n registers are not used for software trigger operation and therefore writes to the SC1B-SC1n registers do not initiate a new conversion.
- A write to any ADC register besides the SC1A-SC1n registers occurs. This indicates that a change in mode of operation has occurred and the current conversion is therefore invalid.
- The MCU is reset.

When a conversion is aborted, the contents of the data registers, Rn, are not altered. The data registers continue to be the values transferred after the completion of the last successful conversion. If the conversion was aborted by a reset, RA and Rn return to their reset states.

44.5.4.4 Power control

The ADC module remains in its Idle state until a conversion is initiated. The Idle state implies that ADC conversion routine is held in reset.

44.5.4.5 Sample time and total conversion time

The total conversion time depends upon:

Functional description

- The sample time as determined by CFG2[SMPLTS]
- The MCU bus frequency
- The conversion mode, as determined by CFG1[MODE]
- The frequency of the conversion clock, that is, f_{ADCK} .

After the module becomes active, sampling of the input begins.

1. CFG2[SMPLTS] selects between sample times based on the conversion mode that is selected.
2. When sampling is completed, the converter is isolated from the input channel and a successive approximation algorithm is applied to determine the digital value of the analog signal.
3. The result of the conversion is transferred to R_n upon completion of the conversion algorithm.

The maximum total conversion time is determined by the clock source chosen and the divide ratio selected. The clock source is selectable by CFG1[ADICLK], and the divide ratio is specified by CFG1[ADIV]. To calculate total conversion time the following formula is applied:

ADC TOTAL CONVERSION TIME = Sample Phase Time (set by SMPLTS + 1) + Hold Phase (1 ADC Cycle) + Compare Phase Time (8-bit Mode = 20 ADC Cycles, 10-bit Mode = 24 ADC Cycles, 12-bit Mode = 28 ADC Cycles) + Single or First continuous time adder (5 ADC cycles + 5 bus clock cycles)

44.5.4.6 Hardware average function

The hardware average function can be enabled by setting SC3[AVGE] = 1 to perform a hardware average of multiple conversions. The number of conversions is determined by the AVGS[1:0] bits, which can select 4, 8, 16, or 32 conversions to be averaged. While the hardware average function is in progress, SC2[ADACT] will be set.

After the selected input is sampled and converted, the result is placed in an accumulator from which an average is calculated after the selected number of conversions have been completed. When hardware averaging is selected, the completion of a single conversion will not set SC1n[COCO].

If the compare function is either disabled or evaluates true, after the selected number of conversions are completed, the average conversion result is transferred into the data result registers, R_n , and SC1n[COCO] is set. An ADC interrupt is generated upon the setting of SC1n[COCO] if the respective ADC interrupt is enabled, that is, SC1n[AIEN] = 1.

Note

The hardware average function can perform conversions on a channel while the MCU is in Wait or Normal Stop mode. The ADC interrupt wakes the MCU when the hardware average is completed if SC1n[AIEN] is set.

44.5.5 Automatic compare function

The compare function can be configured to check whether the result is less than or greater-than-or-equal-to a single compare value, or, if the result falls within or outside a range determined by two compare values.

The compare mode is determined by SC2[ACFGT], SC2[ACREN], and the values in the Compare Value registers (CV1 and CV2). After the input is sampled and converted, the compare values in CV1 and CV2 are used as described in the following table. There are six Compare modes as shown in the following table.

Table 44-5. Compare modes

SC2[ACFGT]	SC2[ACREN]	CV1 relative to CV2	Function	Compare mode description
0	0	—	Less than threshold	Compare true if the result is less than the CV1 registers.
1	0	—	Greater than or equal to threshold	Compare true if the result is greater than OR equal to CV1 registers.
0	1	Less than or equal	Outside range, not inclusive	Compare true if the result is less than CV1 OR the result is greater than CV2.
0	1	Greater than	Inside range, not inclusive	Compare true if the result is less than CV1 AND the result is greater than CV2.
1	1	Less than or equal	Inside range, inclusive	Compare true if the result is greater than or equal to CV1 AND the result is less than or equal to CV2.
1	1	Greater than	Outside range, inclusive	Compare true if the result is greater than or equal to CV1 OR the result is less than or equal to CV2.

With SC2[ACREN] = 1, and if the value of CV1 is less than or equal to the value of CV2, then setting SC2[ACFGT] will select a trigger-if-inside-compare-range inclusive-of-endpoints function. Clearing SC2[ACFGT] will select a trigger-if-outside-compare-range, not-inclusive-of-endpoints function.

If CV1 is greater than CV2, setting SC2[ACFGT] will select a trigger-if-outside-compare-range, inclusive-of-endpoints function. Clearing SC2[ACFGT] will select a trigger-if-inside-compare-range, not-inclusive-of-endpoints function.

If the condition selected evaluates true, $SC1n[COCO]$ is set.

Upon completion of a conversion while the compare function is enabled, if the compare condition is not true, $SC1n[COCO]$ is not set and the conversion result data will not be transferred to the result register, Rn . If the hardware averaging function is enabled, the compare function compares the averaged result to the compare values. The same compare function definitions apply. An ADC interrupt is generated when $SC1n[COCO]$ is set and the respective ADC interrupt is enabled, that is, $SC1n[AIEN] = 1$.

Note

The compare function can monitor the voltage on a channel while the MCU is in Wait or Normal Stop mode. The ADC interrupt wakes the MCU when the compare condition is met.

44.5.6 Calibration function

The ADC is equipped with a calibration mechanism to provide high accuracy as specified in the data sheet.

NOTE

It is mandatory to calibrate the ADC after power up or reset. Not doing this can result in ADC conversion results with lower than specified accuracy.

In order to calibrate the ADC correctly, the following has to be done:

- On startup, wait until the reference voltage (VREFH) has stabilized.
- ADC has to be recalibrated after each system reset.
- Calibrate only one ADC instance at a time. So, when calibrating instance ADC0, the instances ADC1, ADC2, and so on, are required to be idle.
- You must set ADCK (ADC clock) to a value less than or equal to half of the maximum specified frequency.
- Before starting calibration, the calibration registers (CLPS, CLP3, CLP2, CLP1, CLP0, CLPX, and CLP9) must be cleared by writing 0000_0000h into each of them.
- Start ADC calibration by writing $SC3[CAL] = 1$, $SC3[AVGE] = 1$, and $SC3[AVGS] = 11b$.
- Wait for calibration to finish. This will be indicated by conversion complete flag ($SC1n[COCO] = 1$).
- Now you can run ADC conversions with high accuracy in your application. Please make sure to reconfigure the ADCK clock speed and reconfigure AVGE and AVGS to your desired settings. (Maximum clock speed and no use of hardware averaging is possible.)

The total calibration conversion time is: $12 \times (\text{\# of AVERAGE} \times [\text{Sample time (sample + 1) + 1 cycle for hold + 34 cycles for compare phase}]) + 1\text{st conversion synchronization} (\sim 5 \text{ ADC cycles} + 5 \text{ module clocks})$.

For high accuracy of the ADC (as specified in data sheet) on your application board (PCB), the following requirements should be met:

- Bypass caps between VREFH and VREFL. Suggested cap sizes: 1 nF, 100 nF, 10 μ F.
- Place caps on PCB as close as possible to the device pins VREFH and VREFL.
- Bypass caps between VDDA and VSSA. Suggested cap sizes: 1 nF, 100 nF, 10 μ F.
- Place caps on PCB as close as possible to the device pins VDDA and VSSA.
- Routing of VDDA, VSSA, VREFH, and VREFL on PCB:
 - Low impedance between the bypass caps and the MCU pins.
 - Keep routing distant from noisy signal routes like switching I/Os.

44.5.7 User-defined offset function

OFS is a two's-complement, left-justified register that contains the calibration-generated offset error correction value.

The value in OFS is subtracted from the conversion and the result is transferred into the result registers, R_n . If the result is greater than the maximum or less than the minimum result value, it is forced to the appropriate limit for the current mode of operation.

The formatting of OFS is different from the data result register, R_n , to preserve the resolution of the calibration value regardless of the conversion mode selected. Lower order bits are ignored in lower resolution modes. For example, in 8-bit single-ended mode, OFS[14:7] are subtracted from D[7:0]; OFS[15] indicates the sign (negative numbers are effectively added to the result) and OFS[6:0] are ignored.

OFS is automatically set according to calibration requirements after the self-calibration sequence is done, that is, SC3[CAL] is cleared. You can write to OFS to override the calibration result if desired. If you write an OFS value that is different from the calibration value, the ADC error specifications may not be met. You should store the value generated by the calibration function in memory before overwriting with a user-specified value.

Note

There is an effective limit to the values of offset that you can set. If the magnitude of the offset is too high, the results of the conversions will cap off at the limits.

You can use the offset calibration function to remove application offsets or DC bias values. `USR_OFS` may be written with a number in two's-complement format and this offset will be subtracted from the result or hardware averaged value. To add an offset, store the negative offset in two's-complement format and the effect will be an addition. An offset correction that results in an out-of-range value will be forced to the minimum or maximum value. The minimum value for single-ended conversions is 0000h.

44.5.8 MCU Normal Stop mode operation

Stop mode is a low-power consumption Standby mode during which most or all clock sources on the MCU are disabled.

44.5.8.1 Normal Stop mode with Alternate clock sources enabled

If Alternate clock source selected for the conversion clock is enabled, the ADC continues operation during Normal Stop mode. See the chip-specific ADC information for configuration information for this device.

If a conversion is in progress when the MCU enters Normal Stop mode, it continues until completion. Conversions can be initiated while the MCU is in Normal Stop mode by means of the hardware trigger or if continuous conversions are enabled.

If the compare and hardware averaging functions are disabled, a conversion complete event sets `SC1n[COCO]` and generates an ADC interrupt to wake the MCU from Normal Stop mode if the respective ADC interrupt is enabled, that is, when `SC1n[AIEN]=1`. The result register, `Rn`, will contain the data from the first completed conversion that occurred during Normal Stop mode. If the hardware averaging function is enabled, `SC1n[COCO]` will set, and generate an interrupt if enabled, when the selected number of conversions are completed. If the compare function is enabled, `SC1n[COCO]` will set, and generate an interrupt if enabled, only if the compare conditions are met. If a single conversion is selected and the compare is not true, the ADC will return to its idle state and cannot wake the MCU from Normal Stop mode unless a new conversion is initiated by another hardware trigger.

Chapter 45

Comparator (CMP)

45.1 Chip-specific CMP information

45.1.1 Instantiation information

This chip has one analog comparator (CMP0). DAC output is not supported for applications external to DAC on these devices.

- CMP0 has its own independent 8-bit DAC.
- CMP0 supports up to 8 analog inputs from external pins.
- CMP0 is able to convert an internal reference from the bandgap (1 V reference voltage).
- CMP0 supports the round-robin sampling scheme. In summary, this allow the CMP to operate independently in STOP1 and VLPS mode, whilst being triggered periodically to sample up to 8 inputs. Only if an input changes state is a full wakeup generated.

In section [Trigger mode](#), RTC_CLK/Round robin clock refers to LPTMR prescaler clock and STOP refers to STOP1.

See [Module operation in available power modes](#) for details on available power modes.

45.1.2 CMP input connections

The following table shows device specific input channel connections to CMP.

Table 45-1. CMP channel connections

Chip	Package	No of input channels
S32K116	32 QFN	6
	48 LQFP	

Table continues on the next page...

Table 45-1. CMP channel connections (continued)

Chip	Package	No of input channels
S32K118	48 LQFP	8
	64 LQFP	
S32K142	48 LQFP	6
	64 LQFP	8
	100 LQFP	
S32K144	48 LQFP	6
	64 LQFP	8
	100 LQFP	
	100 MAPBGA	
S32K142W	48 LQFP	6
	64 LQFP	8
S32K144W	48 LQFP	6
	64 LQFP	8
S32K146	64 LQFP	8
	100 LQFP	
	144 LQFP	
	100 MAPBGA	
S32K148	100 LQFP	8
	144 LQFP	
	100 MAPBGA	
	176 LQFP	

NOTE

See IO Signal Description Input Multiplexing sheet(s) attached to the Reference Manual for channel details on each device and their specific packages.

The following table shows the input/output connections to the CMP.

Table 45-2. CMP input/output connections

CMP Inputs	Description	Direction
CMP0_IN0	Input Channel 0	Input
CMP0_IN1	Input Channel 1	Input
CMP0_IN2	Input Channel 2	Input
CMP0_IN3	Input Channel 3	Input
CMP0_IN4	Input Channel 4	Input
CMP0_IN5	Input Channel 5	Input
CMP0_IN6	Input Channel 6	Input
CMP0_IN7	Input Channel 7	Input

Table continues on the next page...

Table 45-2. CMP input/output connections (continued)

CMP Inputs	Description	Direction
CMP0_RRT	Round robin active signal	Output
CMP0_OUT	Comparator output to PAD and TRGMUX	Output

45.1.3 CMP external references

The CMP could get external reference through the tightly integrated 8-bit DAC sub-block. The 8-bit DAC sub-block supports selection of two references. For this device, the references are connected as follows:

- V_{in1} : VDDA
- V_{in2} : PMC bandgap buffer out (1 V reference voltage) ¹

45.1.4 External window/sample input

PDB, LPIT, and LPTIMER could be used to generate pulse output which can be used as sampling windows of CMP block via TRGMUX.

45.1.5 CMP trigger mode

The CMP and 8-bit DAC sub-block supports trigger mode operation when the chip is in STOP1 or VLPS mode. When trigger mode is enabled, the trigger source will provide a low power clock and the triggers to the CMP. The trigger event will initiate a compare sequence that must first enable the CMP and DAC prior to performing a CMP operation and capturing the output. In this device, control for this two staged sequencing is provided from the LPTMR. The LPTMR triggering output is always enabled when the LPTMR is enabled. LPTMR trigger output is used as the trigger event and LPTM prescaler clock acts as the low power clock to the CMP in trigger mode. The first signal is supplied to enable the CMP and DAC and is asserted at the same time as the TCF flag is set. The delay to the second signal that triggers the CMP to capture the result of the compare operation is dependent on the LPTMR configuration. In Time Counter mode with prescaler enabled, the delay is 1/2 Prescaler output period. In Time Counter mode with prescaler bypassed, the delay is 1/2 Prescaler source clock period.

1. 1 V reference voltage will not be available in VLP modes

The delay between the first signal from LPTMR and the second signal from LPTMR must be greater than the Analog comparator initialization delay as defined in the device datasheet.

NOTE

When used in Round Robin mode, CMP0 outputs the enable signal of comparator on CMP0_RRT pin, on each cycle of comparator circuit. See IO Signal Description Input Multiplexing sheet(s) attached to the Reference Manual for the pins on which CMP0_RRT function is available.

45.1.6 Programming recommendation

Following sequence to be followed for CMP round robin operation:

1. Configure the comparator for round robin mode. (Fields in same register can be configured at one time)
 - a. Configure the comparison cycles by C2[NSAM].

NOTE

It is a mandatory request that the round robin cycling period must be set longer than the time that all the active channels complete the specified comparison cycles set by C2[NSAM].

- b. Configure CMP initialization delay by C2[INITMOD].

NOTE

In programming the C2[INITMOD] registers, the $INITMOD \times$ round robin clock period must be longer than the initialization delay. See device datasheet for details.

- c. Configure the C2[FXMP] to select the fixed port of CMP
 1. If using one input channel to compare with other channels, configure the C2[FXMXCH] to select the fixed channel
 2. If using DAC output to compare with input channels, configure the C1[INPSEL] or C1[INNSEL](according to C2[FXMP])to select the DAC output
 - d. Clear channel flags C2[CHnF]
 - e. Write C2[ACOn] to define the pre-set state of channel n.
 - f. Configure channels for comparison by C1[CHNn]
 - g. Enable round robin mode by C2[RRE] and round robin interrupt by C2[RRIE] (disable C0[IER] and C0[IEF])

- h. Enable comparator by C0[EN]
2. Program LPTMR prescaler clock (round robin clock) and LPTMR as a trigger source to provide round robin triggers.
3. Enter low power mode by executing WFI.

45.1.7 S32K11X to S32K14X difference

See [Differences between S32K14x/S32K14xW, and S32K11x](#), for differences arising out of CPU and interrupt latency impacting timed events when comparing S32K14X and S32K11X variants.

45.2 Introduction

The comparator (CMP) module provides a circuit for comparing two analog input voltages. The comparator circuit is designed to operate across the full range of the supply voltage, known as rail-to-rail operation.

The Analog MUX (ANMUX) provides a circuit for selecting an analog input signal from eight channels. One signal is provided by the 8-bit digital-to-analog converter (DAC). The mux circuit is designed to operate across the full range of the supply voltage.

The DAC is a 256-tap resistor ladder network that provides a selectable voltage reference for applications requiring a voltage reference. The 256-tap resistor ladder network divides the supply reference V_{in} into 256 voltage levels. A 8-bit digital signal input selects the output voltage level, which varies from V_{in} to $V_{in}/256$. V_{in} can be selected from two voltage sources, V_{in1} and V_{in2} . The DAC from a comparator is available as an on-chip internal signal only and is not available externally to a pin.

45.3 Features

The following subsections list the features of the CMP, the DAC, and the ANMUX.

45.3.1 CMP features

The CMP has the following features:

- Operational over the entire supply range

Features

- Inputs may range from rail to rail
- Programmable hysteresis control
- Selectable interrupt on rising-edge, falling-edge, or both rising or falling edges of the comparator output
- Selectable inversion on comparator output
- Capability to produce a wide range of outputs such as:
 - Sampled
 - Windowed, which is ideal for certain PWM zero-crossing-detection applications
 - Digitally filtered:
 - Filter can be bypassed
 - Can be clocked via external SAMPLE signal or scaled bus clock
- External hysteresis can be used at the same time that the output filter is used for internal functions
- Two software selectable performance levels:
 - Shorter propagation delay at the expense of higher power
 - Low power, with longer propagation delay
- DMA transfer support
 - A comparison event can be selected to trigger a DMA transfer
- Functional in all power modes available on this MCU
- The window and filter functions are not available in STOP modes
- The comparator can be triggered by other peripherals to work for only a small fraction of the time

45.3.2 8-bit DAC key features

The DAC has the following features:

- 8-bit resolution
- Selectable supply reference source

- Power Down mode to conserve power when not in use
- Option to route the output to internal comparator input

45.3.3 ANMUX key features

The ANMUX has the following features:

- Two 8-to-1 channel MUXes
- Operational over the entire supply range

45.4 CMP, DAC, and ANMUX diagram

The following figure shows the block diagram for the High-Speed Comparator, DAC, and ANMUX modules.

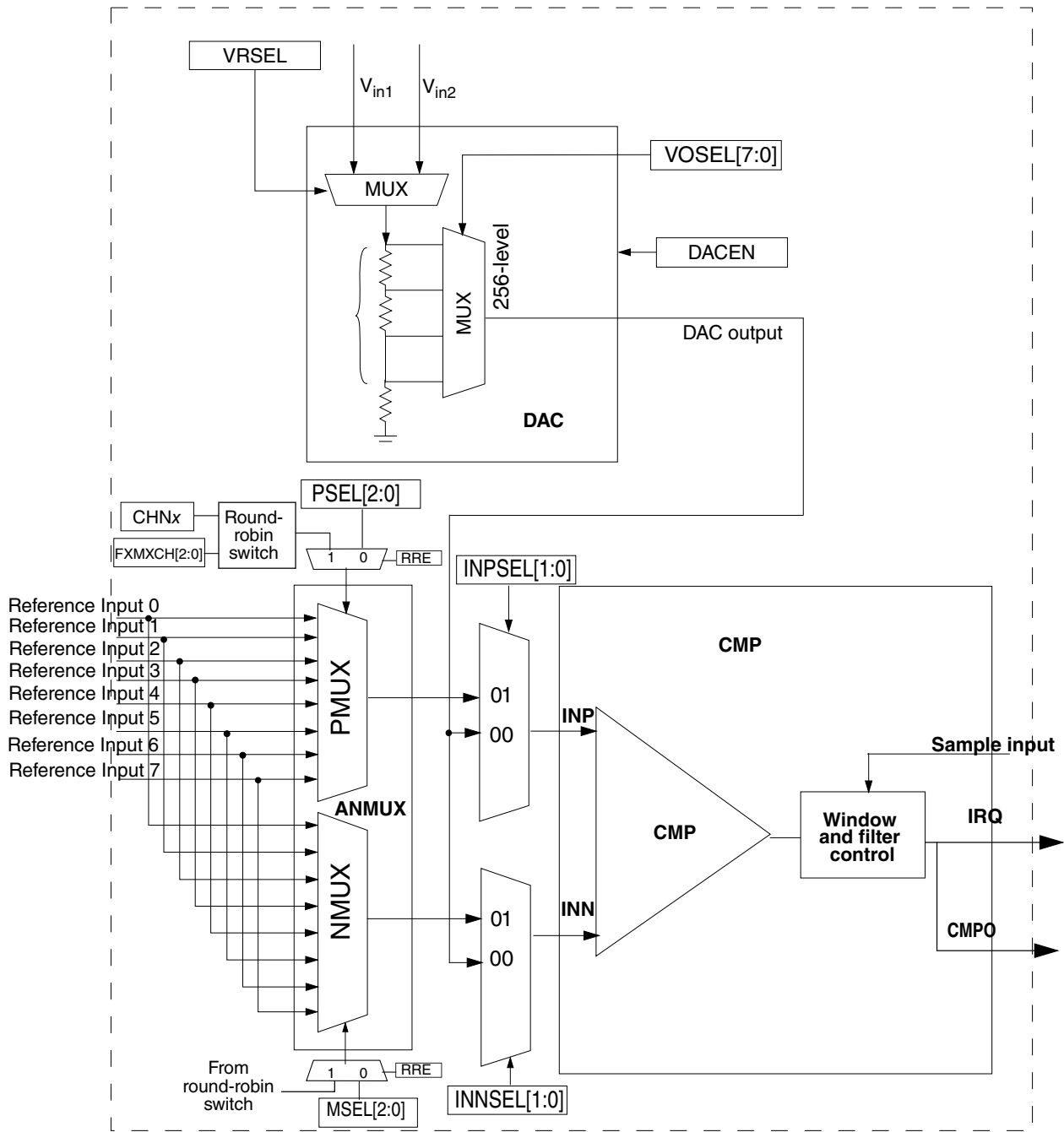

Figure 45-1. CMP high level diagram

45.5 CMP block diagram

The following figure shows the block diagram for the CMP module.

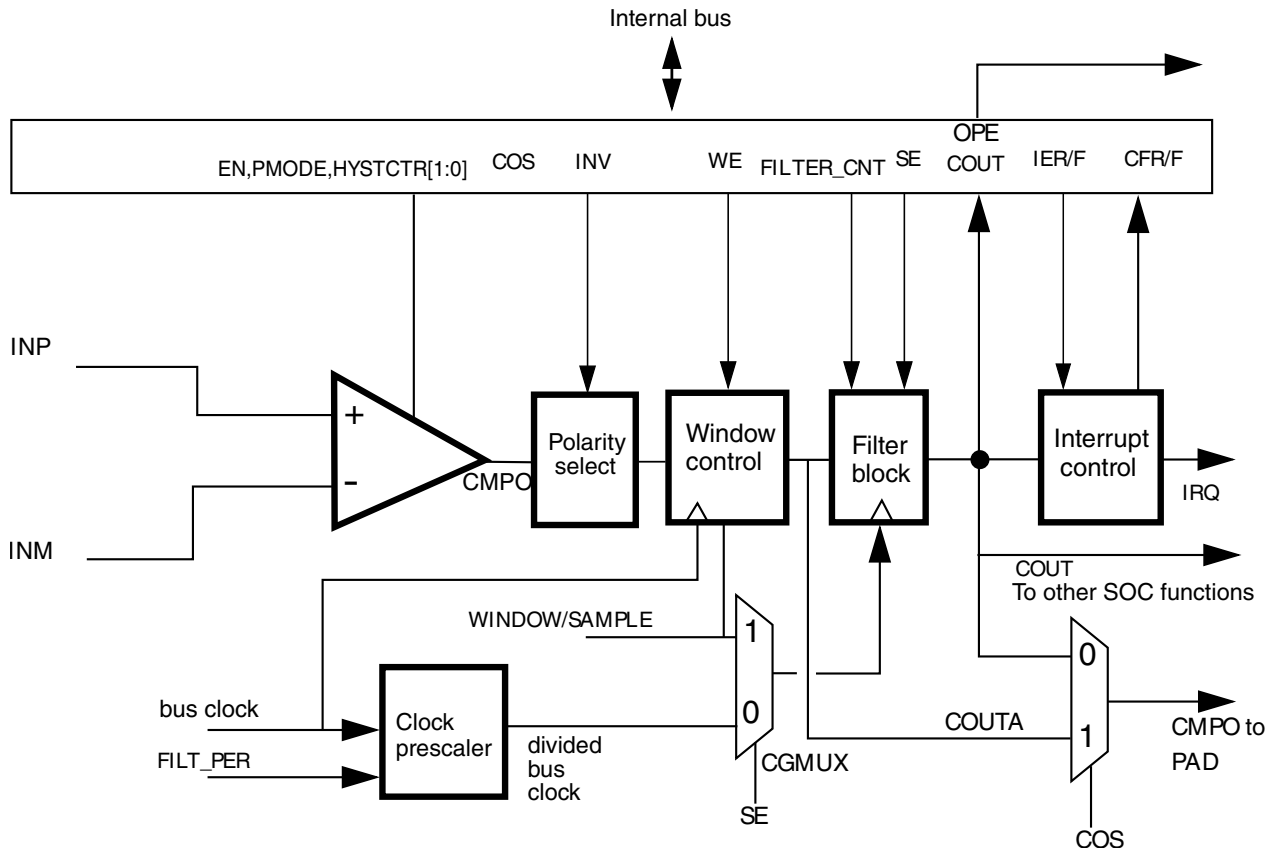

Figure 45-2. Comparator module block diagram

In the CMP block diagram:

- The Window Control block is bypassed when $C0[WE] = 0$.
- If $C0[WE] = 1$, the comparator output is sampled on every bus clock when $WINDOW=1$ to generate $COUTA$. Sampling does NOT occur when $WINDOW = 0$.
- The Filter block is bypassed when not in use.

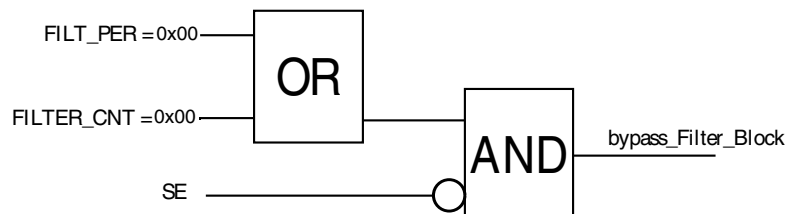

Figure 45-3. Filter block bypass logic

- The Filter block acts as a simple sampler if the filter is bypassed and $C0[FILTER_CNT]$ is set to $0x01$.
- The Filter block filters based on multiple samples when the filter is bypassed and $C0[FILTER_CNT]$ is set greater than $0x01$.

- If C0[SE] = 1, the external SAMPLE input is used as the sampling clock.
- IF C0[SE] = 0, the divided bus clock is used as the sampling clock.
- If enabled, the Filter block will incur up to one bus clock additional latency penalty on COUT due to the fact that COUT, which crosses clock domain boundaries, must be resynchronized to the bus clock.
- C0[WE] and C0[SE] are mutually exclusive.
- If enabled, the filter clock and the sample period must be at least 4 times slower than the system clock to the comparator.

45.6 CMP pin descriptions

This section provides the comparator pin descriptions. The external inputs IN[7:0] are muxed by CMP_C1[PSEL] and CMP_C1[MSEL] beforehand and multiplexed output will then go to the second stage of multiplex with the input of 8-bit DAC and other two internal reserved test signals, determined by CMP_C1[INPSEL] and CMP_C1[INNSEL]. The output of the second multiplex will finally go to the positive and negative ports of the comparator respectively.

Table 45-3. CMP signal descriptions

Signal	Description	I/O
IN[7:0]	Analog voltage inputs	I

NOTE

If comparing one input channel with the DAC output, and if there is injection or over-voltage in the input channels, the DAC output may be corrupted. For such case, the software workaround is to configure the DAC side SEL[2:0] same as the non-DAC side, i.e. configuration of MSEL and PSEL register bits must be the same.

45.6.1 External pins

The CMP has two analog inputs: INP and INM. Each of these pins can accept an input voltage that varies across the full operating range of the MCU. If the module is not enabled, each pin can be used as a digital input or output. Consult the specific MCU documentation to determine what functions are shared with these analog inputs.

The user can select either filtered or unfiltered comparator outputs for use on an external I/O pad.

45.7 CMP functional modes

There are three main sub-blocks to the CMP module:

- The comparator itself
- The window function
- The filter function

The filter, C0[FILTER_CNT], can be clocked from an internal or external clock source. The filter is programmable with respect to the number of samples that must agree before a change in the output is registered. In the simplest case, only one sample must agree. In this case, the filter acts as a simple sampler.

The external sample input is enabled using C0[SE]. When set, the output of the comparator is sampled only on rising edges of the sample input.

The "windowing mode" is enabled by setting C0[WE]. When set, the comparator output is sampled only when WINDOW=1. This feature can be used to ignore the comparator output during time periods in which the input voltages are not valid. This is especially useful when implementing zero-crossing-detection for certain PWM applications.

The comparator filter and sampling features can be combined as shown in the following table. Individual modes are discussed below.

Table 45-4. Comparator sample/filter controls

Mode #	C0[EN]	C0[WE]	C0[SE]	C0[FILTER_CNT]	C0[FPR]	Operation
1	0	X	X	X	X	Disabled See the Disabled mode (# 1) .
2A	1	0	0	0x00	X	Continuous Mode See the Continuous mode (#s 2A & 2B) .
2B	1	0	0	X	0x00	
3A	1	0	1	0x01	X	Sampled, Non-Filtered mode See the Sampled, Non-Filtered mode (#s 3A & 3B) .
3B	1	0	0	0x01	> 0x00	
4A	1	0	1	> 0x01	X	Sampled, Filtered mode
4B	1	0	0	> 0x01	> 0x04	

Table continues on the next page...

Table 45-4. Comparator sample/filter controls (continued)

Mode #	C0[EN]	C0[WE]	C0[SE]	C0[FILTER_CN T]	C0[FPR]	Operation
						See the Sampled, Filtered mode (#s 4A & 4B) .
5A	1	1	0	0x00	X	Windowed mode Comparator output is sampled on every rising bus clock edge when SAMPLE=1 to generate COUTA. See the Windowed mode (#s 5A & 5B) .
5B	1	1	0	X	0x00	
6	1	1	0	0x01	0x01–0xFF	Windowed/Resampled mode Comparator output is sampled on every rising bus clock edge when SAMPLE=1 to generate COUTA, which is then resampled on an interval determined by C0[FPR] to generate COUT. See the Windowed/Resampled mode (# 6) .
7	1	1	0	> 0x01	0x01–0xFF	Windowed/Filtered mode Comparator output is sampled on every rising bus clock edge when SAMPLE=1 to generate COUTA, which is then resampled and filtered to generate COUT. See the Windowed/Filtered mode (#7) .
All other combinations of C0[EN], C0[WE], C0[SE], C0[FILTER_CNT], and C0[FPR] are illegal.						

For cases where a comparator is used to drive a fault input, for example, for a motor-control module such as FTM, it must be configured to operate in Continuous mode so that an external fault can immediately pass through the comparator to the target fault circuitry.

Note

Filtering and sampling settings must be changed only after setting C0[SE]=0, C0[FPR]=0 and C0[FILTER_CNT]=0x00. This resets the filter to a known state.

45.7.1 Disabled mode (# 1)

In Disabled mode, the analog comparator is non-functional and consumes no power. CMPO is 0 in this mode.

45.7.2 Continuous mode (#s 2A & 2B)

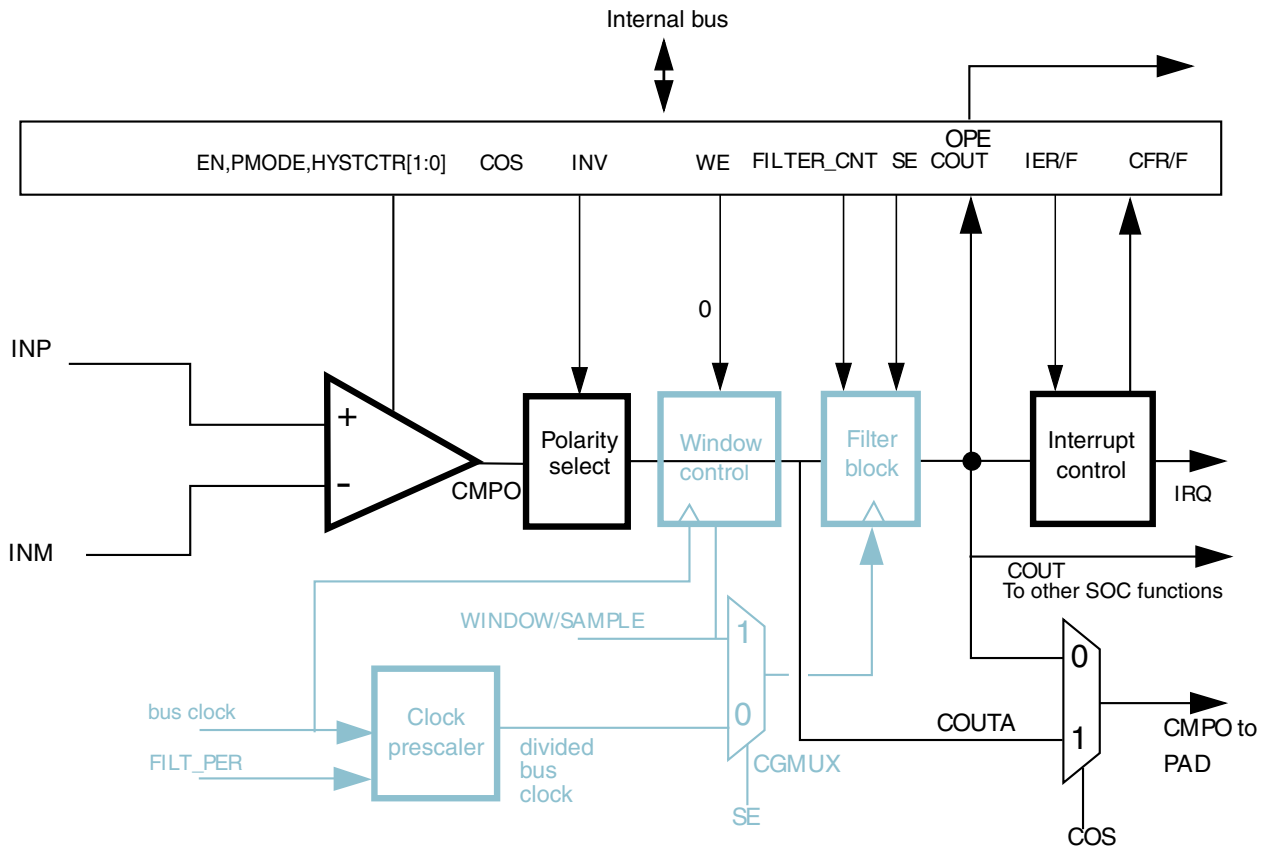

Figure 45-4. Comparator operation in Continuous mode

NOTE

See the chip configuration section for the source of sample/window input.

The analog comparator block is powered and active. CMPO may be optionally inverted, but is not subject to external sampling or filtering. Both window control and filter blocks are completely bypassed (as the grey-colored parts in the figure). C0[COUT] is updated continuously. The path from comparator input pins to output pin is operating in combinational unlocked mode. COUT and COUTA are identical.

For control configurations that result in disabling the filter block, see [Figure 45-3](#).

45.7.3 Sampled, Non-Filtered mode (#s 3A & 3B)

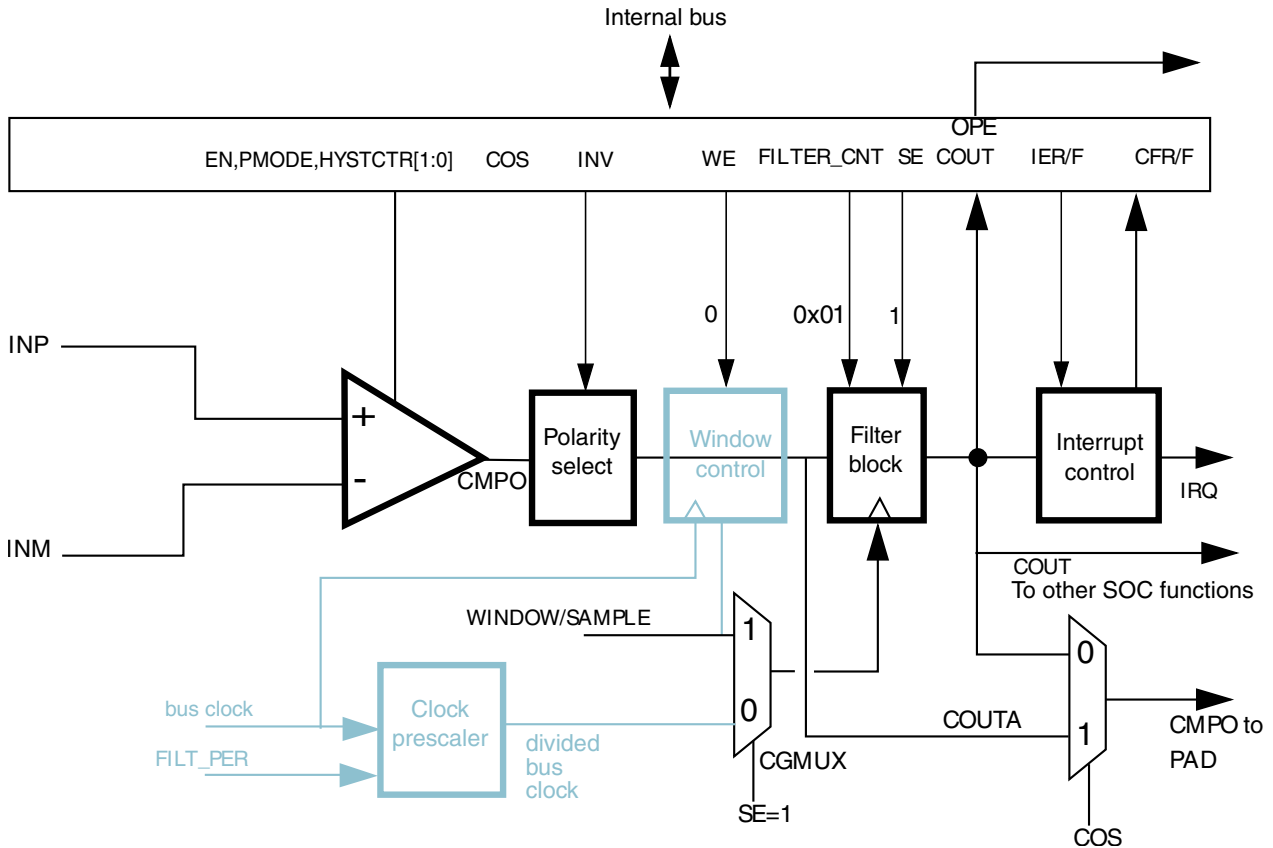

Figure 45-5. Sampled, Non-Filtered (# 3A): sampling point externally driven

In Sampled, Non-Filtered mode, the analog comparator block is powered and active. The path from analog inputs to COUTA is combinational unlocked. Windowing control is completely bypassed. COUTA is sampled whenever a rising edge is detected on the filter block clock input.

The only difference in operation between Sampled, Non-Filtered (# 3A) and Sampled, Non-Filtered (# 3B) is in how the clock to the filter block is derived. In #3A, the clock to filter block is externally derived while in #3B, the clock to filter block is internally derived.

The comparator filter has no other function than sample/hold of the comparator output in this mode (# 3B).

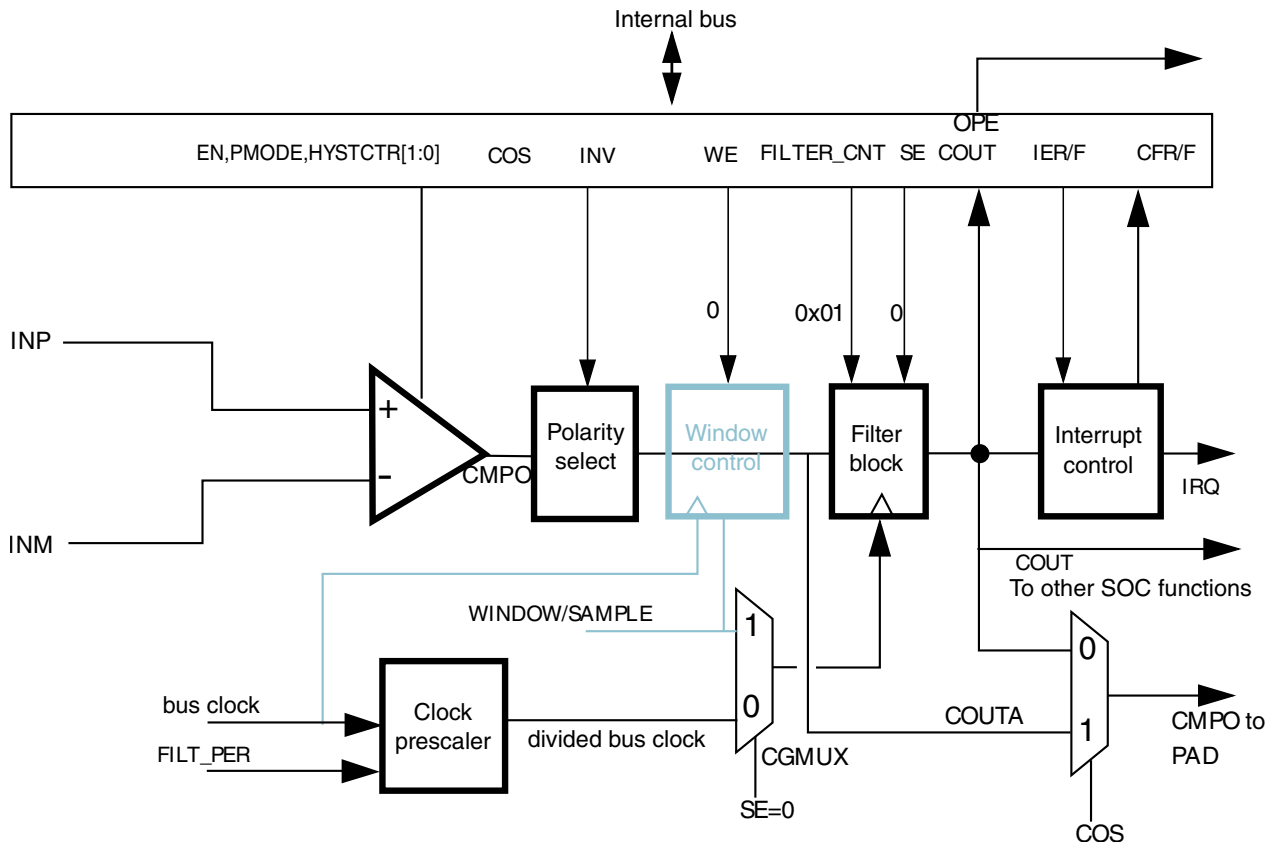

Figure 45-6. Sampled, Non-Filtered (# 3B): sampling interval internally derived

The following figure illustrates comparator operation in this mode, assuming the polarity select is set to non-inverting state.

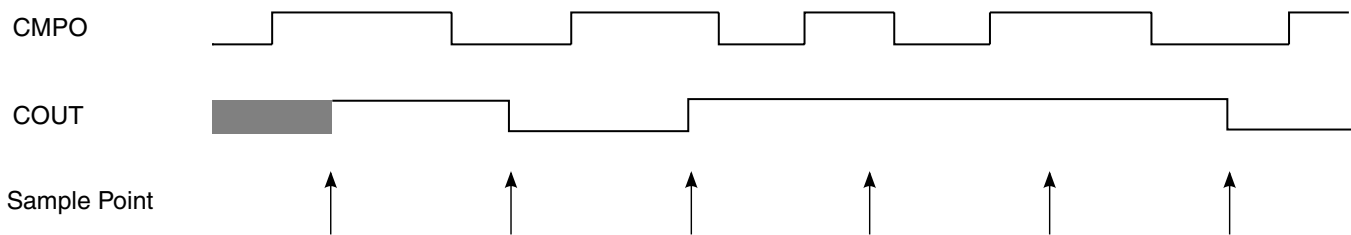

Figure 45-7. Sampled, Non-Filtered Mode Timing Diagram

45.7.4 Sampled, Filtered mode (#s 4A & 4B)

In Sampled, Filtered mode, the analog comparator block is powered and active. The path from analog inputs to COUTA is combinational unlocked. Windowing control is completely bypassed. COUTA is sampled whenever a rising edge is detected on the filter block clock input.

The only difference in operation between Sampled, Non-Filtered (# 3A) and Sampled, Filtered (# 4A) is that, now, $C0[FILTER_CNT] > 1$, which activates filter operation.

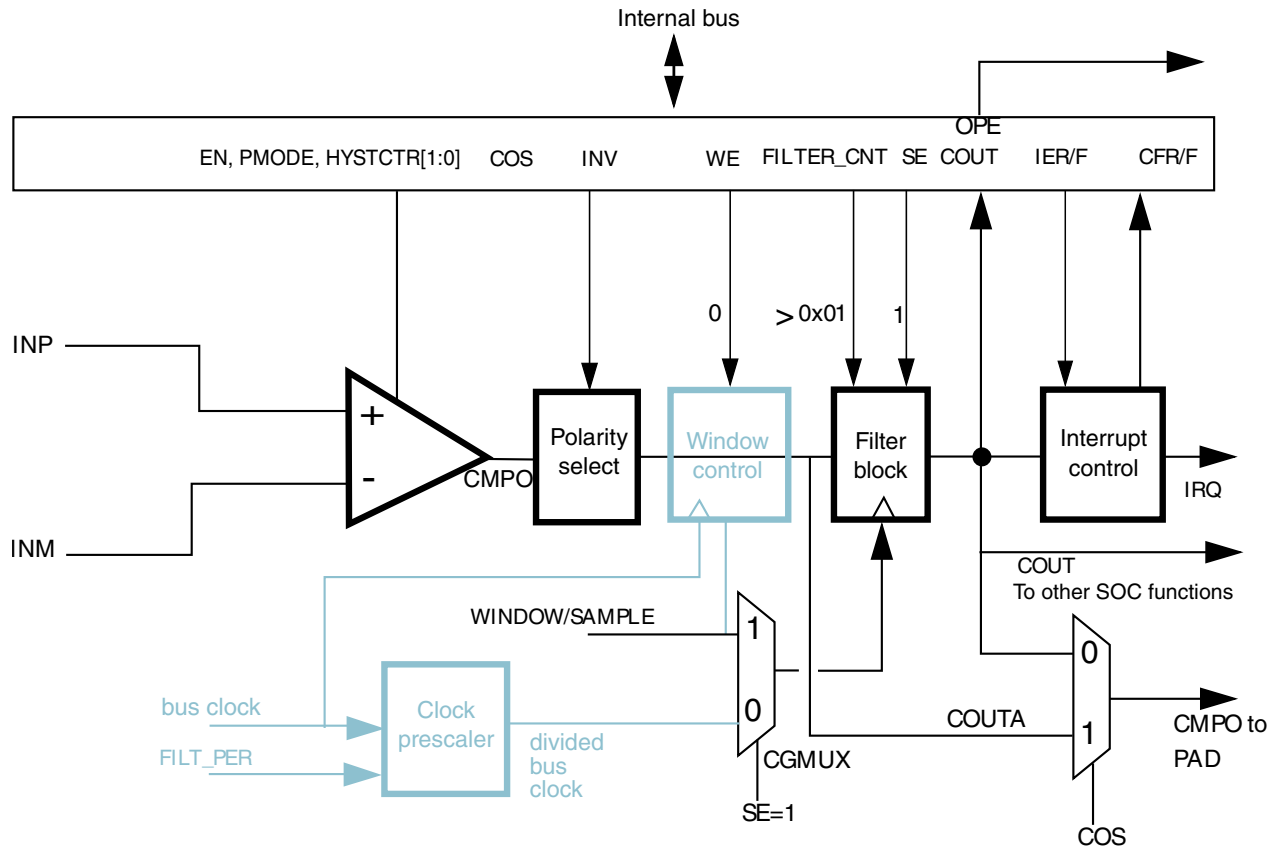

Figure 45-8. Sampled, Filtered (# 4A): sampling point externally driven

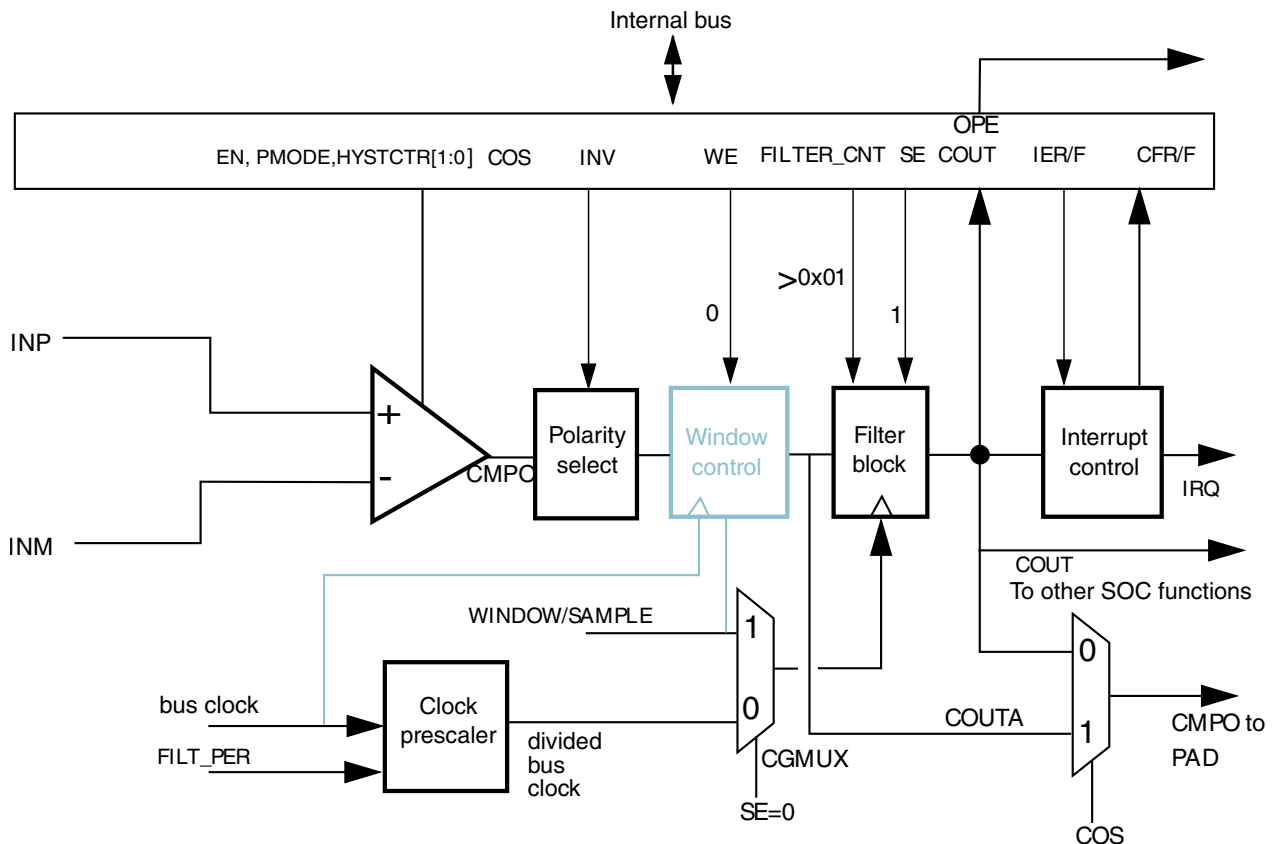

Figure 45-9. Sampled, Filtered (# 4B): sampling point internally derived

The only difference in operation between Sampled, Non-Filtered (# 3B) and Sampled, Filtered (# 4B) is that now, $C0[FILTER_CNT] > 1$, which activates filter operation.

45.7.5 Windowed mode (#s 5A & 5B)

The following figure illustrates comparator operation in the Windowed mode, ignoring latency of the analog comparator, polarity select, and window control block. It also assumes that the polarity select is set to non-inverting state.

NOTE

The analog comparator output is passed to COUTA only when the WINDOW signal is high.

In actual operation, COUTA may lag the analog inputs by up to one bus clock cycle plus the combinational path delay through the comparator and polarity select logic.

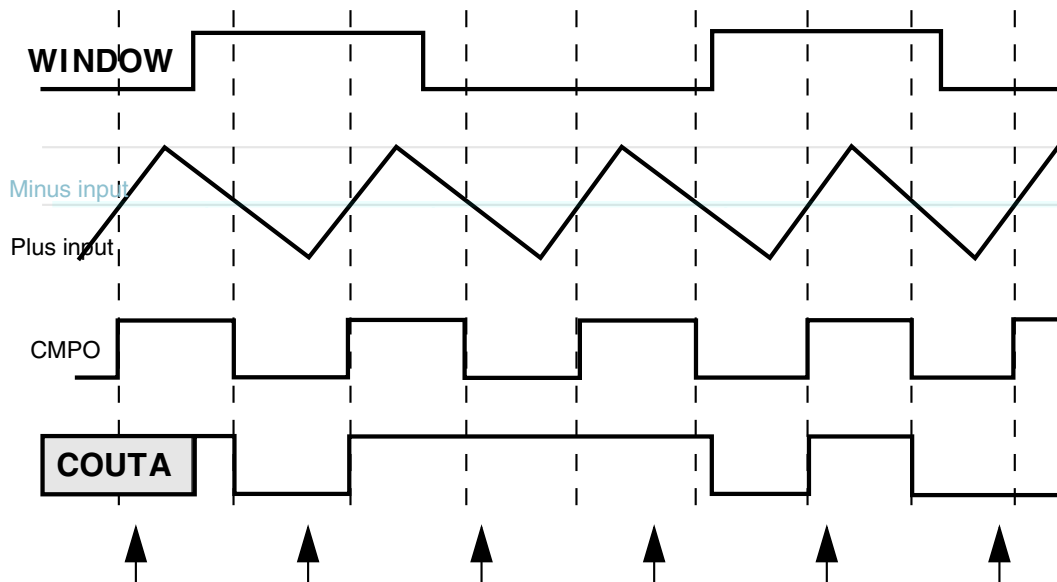

Figure 45-10. Windowed mode timing diagram

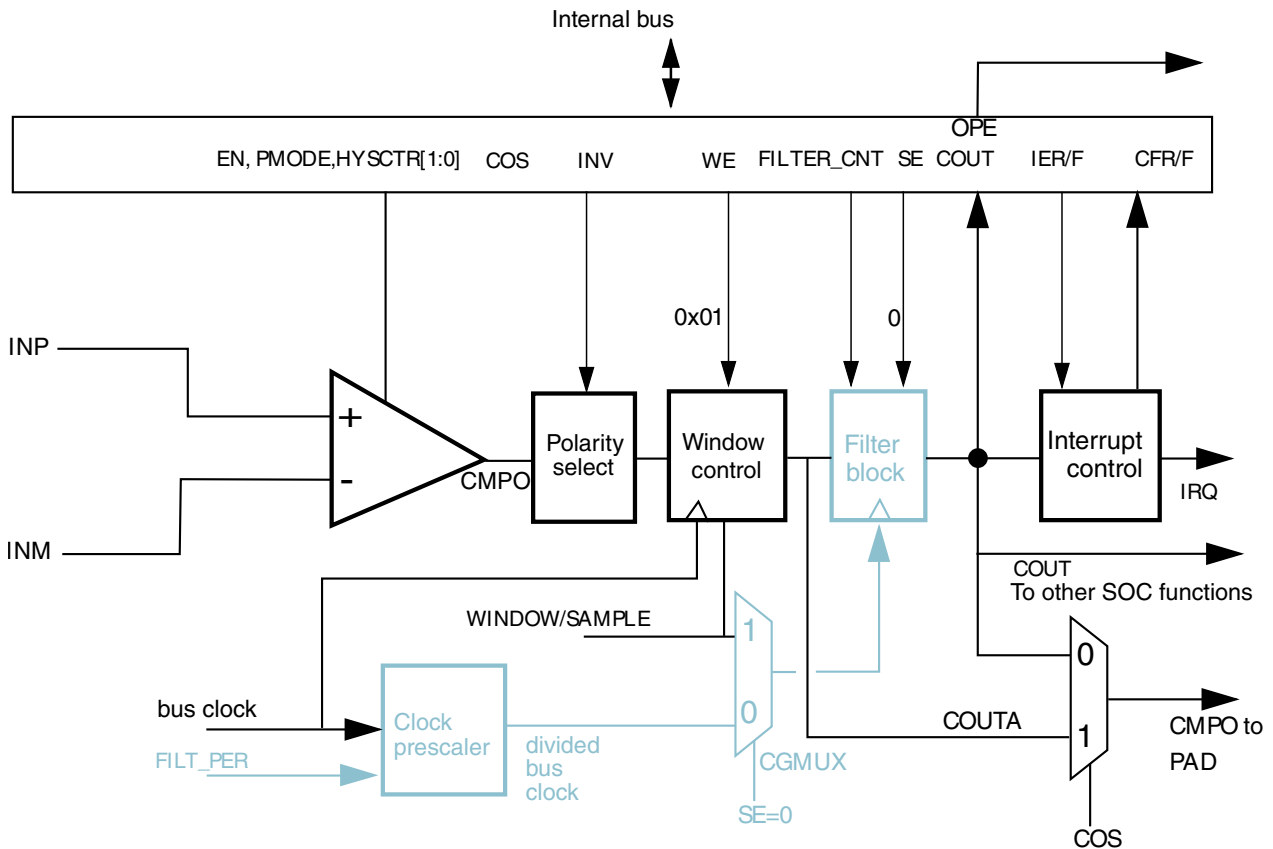

Figure 45-11. Windowed mode

For control configurations which result in disabling the filter block, see [Figure 45-3](#).

When any windowed mode is active, **COUTA** is clocked by the bus clock whenever **WINDOW = 1**. The last latched value is held when **WINDOW = 0**.

NOTE

The sample input must be high for ≥ 2.5 CMP bus clock cycles to ensure no sampling event is missed.

45.7.6 Windowed/Resampled mode (# 6)

The following figure uses the same input stimulus shown in [Figure 45-10](#), and adds resampling of COUTA to generate COUT. Samples are taken at the time points indicated by the arrows in the figure. Again, prop delays and latency are ignored for the sake of clarity.

This example was generated solely to demonstrate operation of the comparator in windowed/resampled mode, and does not reflect any specific application. Depending upon the sampling rate and window placement, COUT may not see zero-crossing events detected by the analog comparator. Sampling period and/or window placement must be carefully considered for a given application.

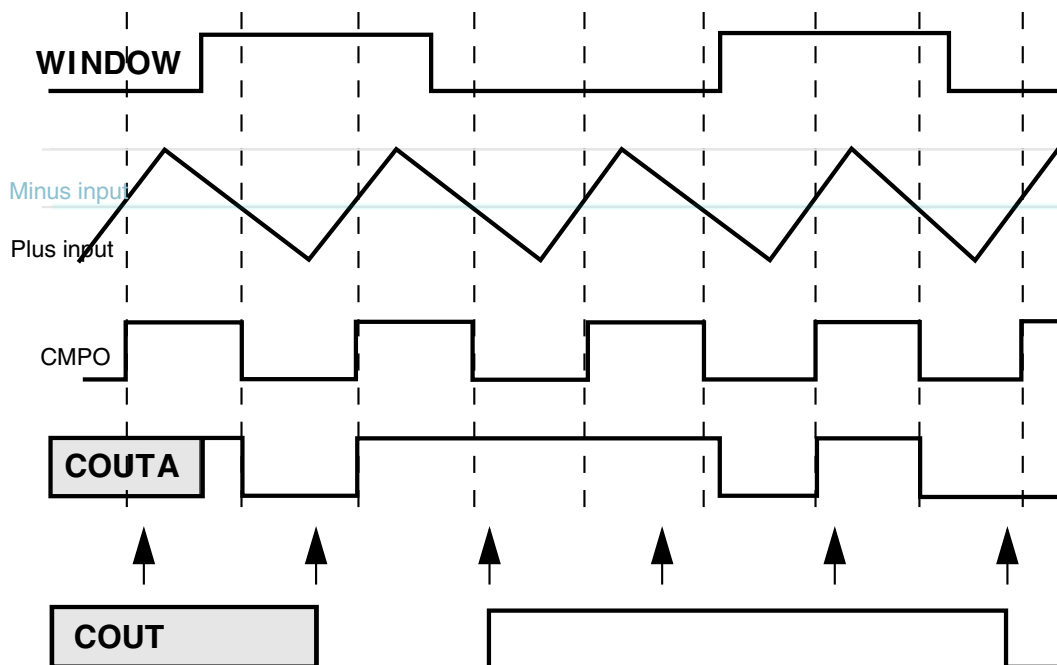

Figure 45-12. Windowed/resampled mode operation

This mode of operation results in an unfiltered string of comparator samples where the interval between the samples is determined by $FPR[FILT_PER]$ and the bus clock rate. Configuration for this mode is virtually identical to that for the Windowed/Filtered Mode shown in the next section. The only difference is that the value of $C0[FILTER_CNT]$ must be 1.

NOTE

The sample input must be high for ≥ 2.5 CMP bus clock cycles to ensure no sampling event is missed.

45.7.7 Windowed/Filtered mode (#7)

This is the most complex mode of operation for the comparator block, as it uses both windowing and filtering features. It also has the highest latency of any of the modes. This can be approximated: up to 1 bus clock synchronization in the window function + $[(C0[FILTER_CNT] \times C0[FPR]) + 1] \times$ bus clock for the filter function.

When any windowed mode is active, COUTA is clocked by the bus clock whenever WINDOW = 1. The last latched value is held when WINDOW = 0.

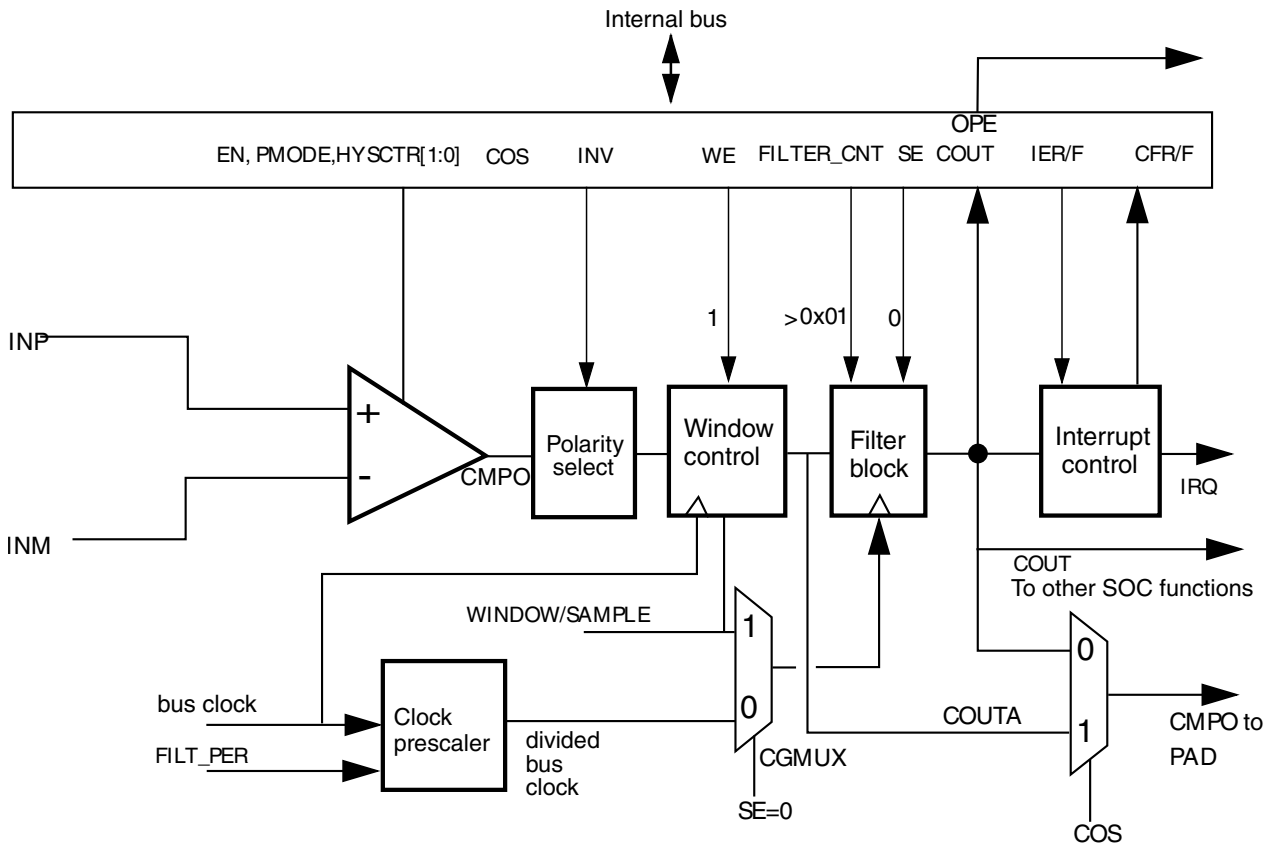

Figure 45-13. Windowed/Filtered mode

The following figure shows the operation timing for this mode, considering uncertainty is introduced by the internal synchronization for the filter block.

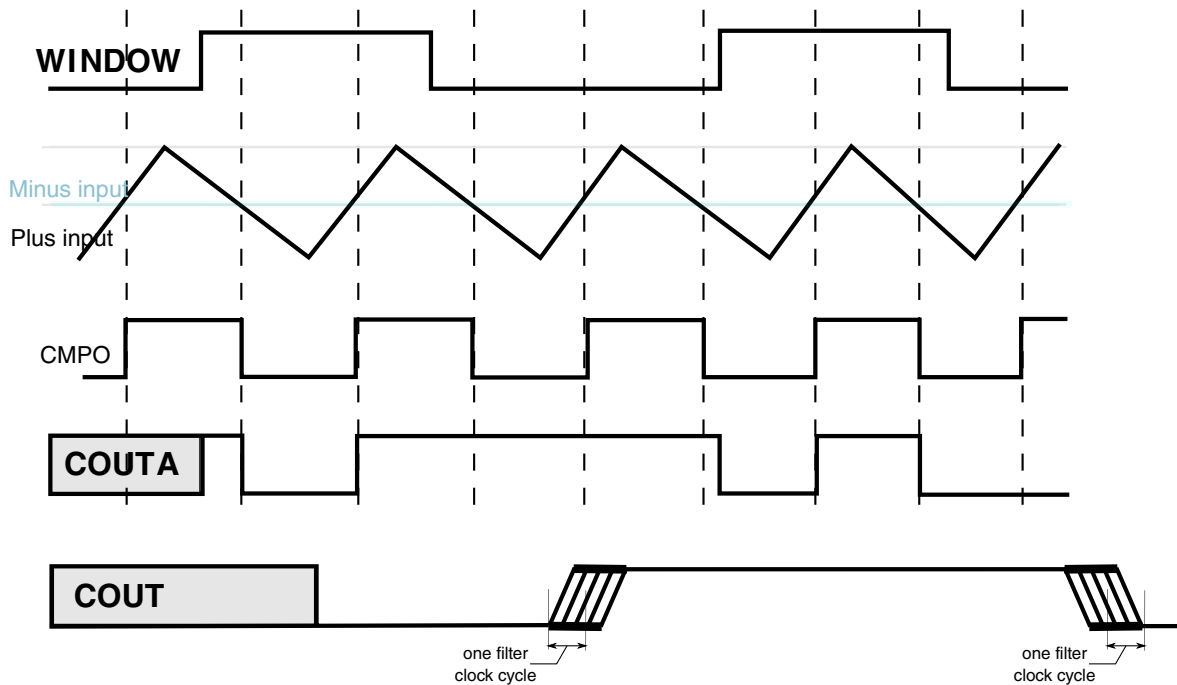

Figure 45-14. Windowed/Filtered mode operation

45.8 Memory map/register definitions

CMP memory map

Address offset (hex)	Register name	Width (in bits)	Access	Reset value	Section/page
0	CMP Control Register 0 (CMP_C0)	32	R/W	0000_0000h	45.8.1/1291
4	CMP Control Register 1 (CMP_C1)	32	R/W	0000_0000h	45.8.2/1295
8	CMP Control Register 2 (CMP_C2)	32	R/W	0000_0000h	45.8.3/1298

45.8.1 CMP Control Register 0 (CMP_C0)

Access:

- Supervisor read/write
- User read/write

Memory map/register definitions

Address: 0h base + 0h offset = 0h

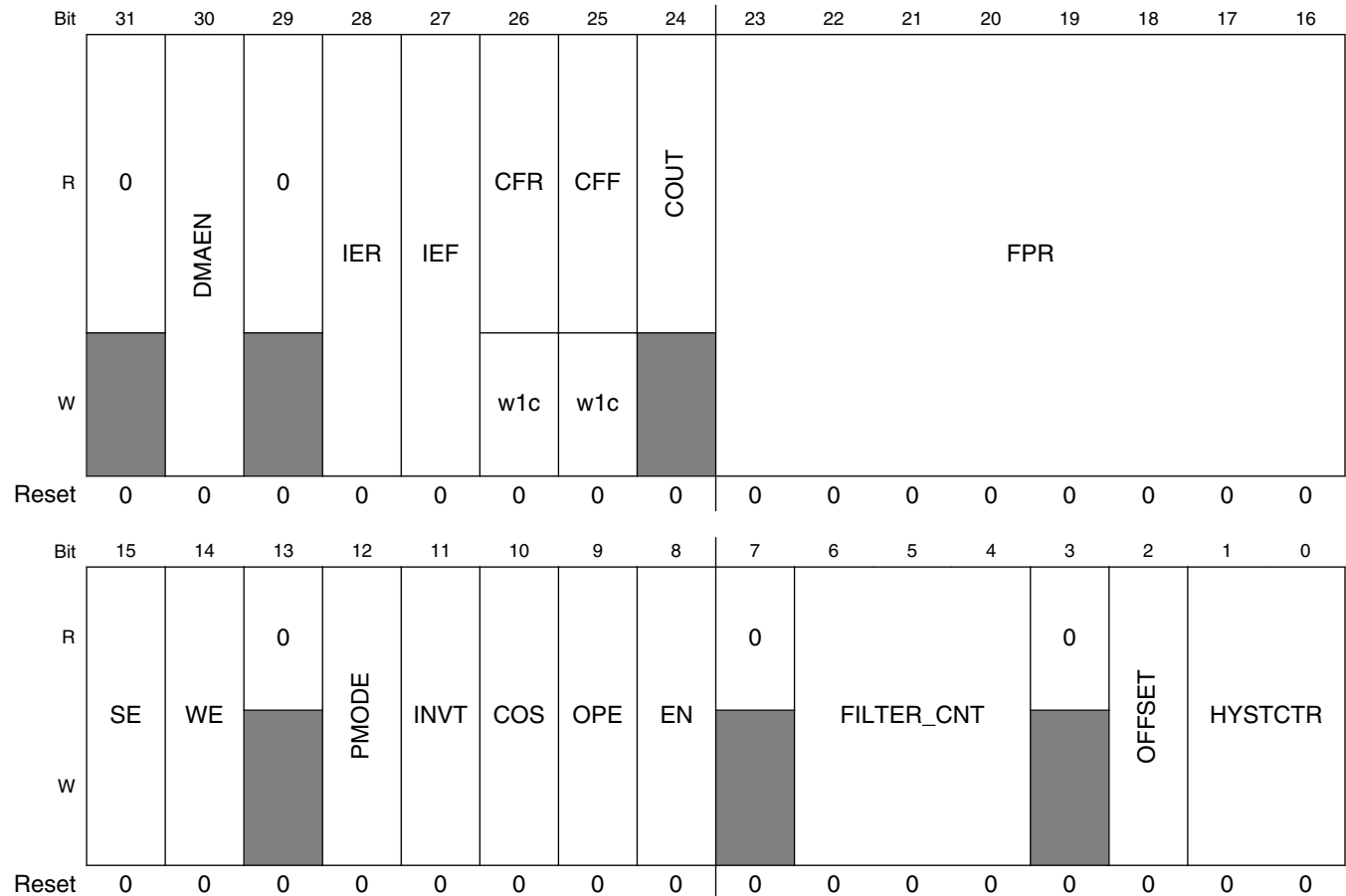

CMP_C0 field descriptions

Field	Description
31 Reserved	This field is reserved. This read-only field is reserved and always has the value 0.
30 DMAEN	DMA Enable Enables the DMA transfer triggered from the CMP module. When this field is set, a DMA request is asserted when CFR or CFF is set. 0 DMA is disabled. 1 DMA is enabled.
29 Reserved	This field is reserved. This read-only field is reserved and always has the value 0.
28 IER	Comparator Interrupt Enable Rising Enables the CFR interrupt from the CMP. When this field is set, an interrupt will be asserted when CFR is set. 0 Interrupt is disabled. 1 Interrupt is enabled.
27 IEF	Comparator Interrupt Enable Falling

Table continues on the next page...

CMP_C0 field descriptions (continued)

Field	Description
	<p>Enables the CFF interrupt from the CMP. When this field is set, an interrupt will be asserted when CFF is set.</p> <p>0 Interrupt is disabled. 1 Interrupt is enabled.</p>
26 CFR	<p>Analog Comparator Flag Rising</p> <p>Detects a rising-edge on COUT, when set, during normal operation. CFR is cleared by writing 1 to it. During Stop modes, CFR is level sensitive</p> <p>0 A rising edge has not been detected on COUT. 1 A rising edge on COUT has occurred.</p>
25 CFF	<p>Analog Comparator Flag Falling</p> <p>Detects a falling-edge on COUT, when set, during normal operation. CFF is cleared by writing 1 to it. During Stop modes, CFF is level sensitive .</p> <p>0 A falling edge has not been detected on COUT. 1 A falling edge on COUT has occurred.</p>
24 COUT	<p>Analog Comparator Output</p> <p>Returns the current value of the Analog Comparator output, when read. The field is reset to 0 and will read as C0[INVT] when the Analog Comparator module is disabled, that is, when C0[EN] = 0. Writes to this field are ignored.</p>
23–16 FPR	<p>Filter Sample Period</p> <p>Specifies the sampling period, in bus clock cycles, of the comparator output filter, when C0[SE] = 0. Setting FPR to 0x0 disables the filter. Filter programming and latency details are provided in the CMP functional description. This field has no effect when C0[SE] = 1. In that case, the external SAMPLE signal is used to determine the sampling period.</p>
15 SE	<p>Sample Enable</p> <p>At any given time, either SE or WE can be set. If a write to this register attempts to set both, then SE is set and WE is cleared. However, avoid writing ones to both bit locations because this "11" case is reserved.</p> <p>0 Sampling mode is not selected. 1 Sampling mode is selected.</p>
14 WE	<p>Windowing Enable</p> <p>At any given time, either SE or WE can be set. If a write to this register attempts to set both, then SE is set and WE is cleared. However, avoid writing ones to both bit locations because this "11" case is reserved.</p> <p>0 Windowing mode is not selected. 1 Windowing mode is selected.</p>
13 Reserved	<p>This field is reserved. This read-only field is reserved and always has the value 0.</p>
12 PMODE	<p>Power Mode Select</p> <p>0 Low Speed (LS) comparison mode is selected. 1 High Speed (HS) comparison mode is selected, in VLPx mode, or Stop mode switched to Low Speed (LS) mode.</p>

Table continues on the next page...

CMP_C0 field descriptions (continued)

Field	Description
11 INVT	<p>Comparator invert</p> <p>This bit allows selecting the polarity of the analog comparator function. It is also driven to the COUT output (on both the device pin and as C0[COUT]) when C0[OPE]=0.</p> <p>0 Does not invert the comparator output. 1 Inverts the comparator output.</p>
10 COS	<p>Comparator Output Select</p> <p>0 Set CMPO to equal COUT (filtered comparator output). 1 Set CMPO to equal COUTA (unfiltered comparator output).</p>
9 OPE	<p>Comparator Output Pin Enable</p> <p>The OPE bit enables the path from the comparator output to a selected pin.</p> <p>0 When OPE is 0, the comparator output (after window/filter settings dependent on software configuration) is not available to a packaged pin. 1 When OPE is 1, and if the software has configured the comparator to own a packaged pin, the comparator is available in a packaged pin.</p>
8 EN	<p>Comparator Module Enable</p> <p>The EN bit enables the Analog Comparator Module. When the module is not enabled, the analog part remains in the off state, and consumes no power.</p> <p>0 Analog Comparator is disabled. 1 Analog Comparator is enabled.</p>
7 Reserved	<p>This field is reserved. This read-only field is reserved and always has the value 0.</p>
6–4 FILTER_CNT	<p>Filter Sample Count</p> <p>This field specifies the number of consecutive samples that must agree prior to the comparator output filter accepting a new output state. For information regarding filter programming and latency, please see the Functional Description.</p> <p>000 Filter is disabled. If SE = 1, then COUT is a logic zero (this is not a legal state, and is not recommended). If SE = 0, COUT = COUTA. 001 1 consecutive sample must agree (comparator output is simply sampled). 010 2 consecutive samples must agree. 011 3 consecutive samples must agree. 100 4 consecutive samples must agree. 101 5 consecutive samples must agree. 110 6 consecutive samples must agree. 111 7 consecutive samples must agree.</p>
3 Reserved	<p>This field is reserved. This read-only field is reserved and always has the value 0.</p>
2 OFFSET	<p>Comparator hard block offset control. See chip data sheet to get the actual offset value with each level</p>

Table continues on the next page...

CMP_C0 field descriptions (continued)

Field	Description
	<p>NOTE:</p> <ul style="list-style-type: none"> If OFFSET = 1, then there will be no hysteresis in the case of INP crossing INN in the positive direction (or INN crossing INP in the negative direction). A Half Hysteresis value still exists for INP crossing INN in the falling direction. If OFFSET = 0, then the hysteresis selected by HYSTCTR is valid for both directions. <p>0 The comparator hard block output has level 0 offset internally. 1 The comparator hard block output has level 1 offset internally.</p>
HYSTCTR	<p>Comparator hard block hysteresis control. See chip data sheet to get the actual hysteresis value with each level</p> <p>00 The hard block output has level 0 hysteresis internally. 01 The hard block output has level 1 hysteresis internally. 10 The hard block output has level 2 hysteresis internally. 11 The hard block output has level 3 hysteresis internally.</p>

45.8.2 CMP Control Register 1 (CMP_C1)

Access:

- Supervisor read/write
- User read/write

Address: 0h base + 4h offset = 4h

Bit	31	30	29	28	27	26	25	24	23	22	21	20	19	18	17	16
R	0	0				0			CHN7	CHN6	CHN5	CHN4	CHN3	CHN2	CHN1	CHN0
W				INPSEL			INNSEL									
Reset	0	0	0	0	0	0	0	0	0	0	0	0	0	0	0	0
Bit	15	14	13	12	11	10	9	8	7	6	5	4	3	2	1	0
R																
W	DACEN	VRSEL		PSEL		MSEL								VOSEL		
Reset	0	0	0	0	0	0	0	0	0	0	0	0	0	0	0	0

CMP_C1 field descriptions

Field	Description
31–30 Reserved	This field is reserved. This read-only field is reserved and always has the value 0.
29 Reserved	This field is reserved. This read-only field is reserved and always has the value 0.

Table continues on the next page...

CMP_C1 field descriptions (continued)

Field	Description
28–27 INPSEL	<p>Selection of the input to the positive port of the comparator</p> <p>Determines which input is selected for the plus input of the comparator.</p> <p>NOTE: These selections is used to select the final positive input to the comparator.</p> <p>Note: For the round robin mode of operation, the MSEL and PSEL bitfields in CMPx_C1 register must have different values.</p> <p>00 IN0, from the 8-bit DAC output 01 IN1, from the analog 8-1 mux 10 Reserved 11 Reserved</p>
26 Reserved	<p>This field is reserved.</p> <p>This read-only field is reserved and always has the value 0.</p>
25–24 INNSEL	<p>Selection of the input to the negative port of the comparator</p> <p>Determines which input is selected for the minus input of the comparator.</p> <p>NOTE: These selections is used to select the final negative input to the comparator.</p> <p>Note: For the round robin mode of operation, the MSEL and PSEL bitfields in CMPx_C1 register must have different values.</p> <p>00 IN0, from the 8-bit DAC output 01 IN1, from the analog 8-1 mux 10 Reserved 11 Reserved</p>
23 CHN7	<p>Channel 7 input enable</p> <p>Channel 7 of the input enable for the round-robin checker. If CHN7 is set, then the corresponding channel to the non-fixed mux port is enabled to check its voltage value in the round-robin mode. If the same channel is selected as the reference voltage, this bit has no effect.</p>
22 CHN6	<p>Channel 6 input enable</p> <p>Channel 6 of the input enable for the round-robin checker. If CHN6 is set, then the corresponding channel to the non-fixed mux port is enabled to check its voltage value in the round-robin mode. If the same channel is selected as the reference voltage, this bit has no effect.</p>
21 CHN5	<p>Channel 5 input enable</p> <p>Channel 5 of the input enable for the round-robin checker. If CHN5 is set, then the corresponding channel to the non-fixed mux port is enabled to check its voltage value in the round-robin mode. If the same channel is selected as the reference voltage, this bit has no effect.</p>
20 CHN4	<p>Channel 4 input enable</p> <p>Channel 4 of the input enable for the round-robin checker. If CHN4 is set, then the corresponding channel to the non-fixed mux port is enabled to check its voltage value in the round-robin mode. If the same channel is selected as the reference voltage, this bit has no effect.</p>
19 CHN3	<p>Channel 3 input enable</p> <p>Channel 3 of the input enable for the round-robin checker. If CHN3 is set, then the corresponding channel to the non-fixed mux port is enabled to check its voltage value in the round-robin mode. If the same channel is selected as the reference voltage, this bit has no effect.</p>

Table continues on the next page...

CMP_C1 field descriptions (continued)

Field	Description
18 CHN2	Channel 2 input enable Channel 2 of the input enable for the round-robin checker. If CHN2 is set, then the corresponding channel to the non-fixed mux port is enabled to check its voltage value in the round-robin mode. If the same channel is selected as the reference voltage, this bit has no effect.
17 CHN1	Channel 1 input enable Channel 1 of the input enable for the round-robin checker. If CHN1 is set, then the corresponding channel to the non-fixed mux port is enabled to check its voltage value in the round-robin mode. If the same channel is selected as the reference voltage, this bit has no effect.
16 CHN0	Channel 0 input enable Channel 0 of the input enable for the round-robin checker. If CHN0 is set, then the corresponding channel to the non-fixed mux port is enabled to check its voltage value in the round-robin mode. If the same channel is selected as the reference voltage, this bit has no effect.
15 DACEN	DAC Enable This bit is used to enable the DAC. When the DAC is disabled, it is powered down to conserve power. 0 DAC is disabled. 1 DAC is enabled.
14 VRSEL	Supply Voltage Reference Source Select 0 Vin1 is selected as resistor ladder network supply reference Vin. 1 Vin2 is selected as resistor ladder network supply reference Vin.
13–11 PSEL	Plus Input MUX Control Determines which input is selected for the plus mux. NOTE: These bits are used to select the external 8 inputs for the plus mux, the actual input to the positive port of the comparator is selected between this mux out and other inputs finally, see the definition in INPSEL. Note: For the round robin mode of operation, the MSEL and PSEL bitfields in CMPx_C1 register must have different values. 000 IN0 001 IN1 010 IN2 011 IN3 100 IN4 101 IN5 110 IN6 111 IN7
10–8 MSEL	Minus Input MUX Control Determines which input is selected for the minus mux. NOTE: These bits are used to select the external 8 inputs for the minus mux, the actual input to the negative port of the comparator is selected between this mux out and other inputs finally, see the definition in INNSEL. Note: For the round robin mode of operation, the MSEL and PSEL bitfields in CMPx_C1 register must have different values.

Table continues on the next page...

CMP_C1 field descriptions (continued)

Field	Description
000	IN0
001	IN1
010	IN2
011	IN3
100	IN4
101	IN5
110	IN6
111	IN7
VOSEL	DAC Output Voltage Select This bit selects an output voltage from one of 256 distinct levels. $DACO = (V_{in}/256) \times (VOSEL[7:0] + 1)$, so the DACO range is from $V_{in}/256$ to V_{in} .

45.8.3 CMP Control Register 2 (CMP_C2)

Access:

- Supervisor read/write
- User read/write

Address: 0h base + 8h offset = 8h

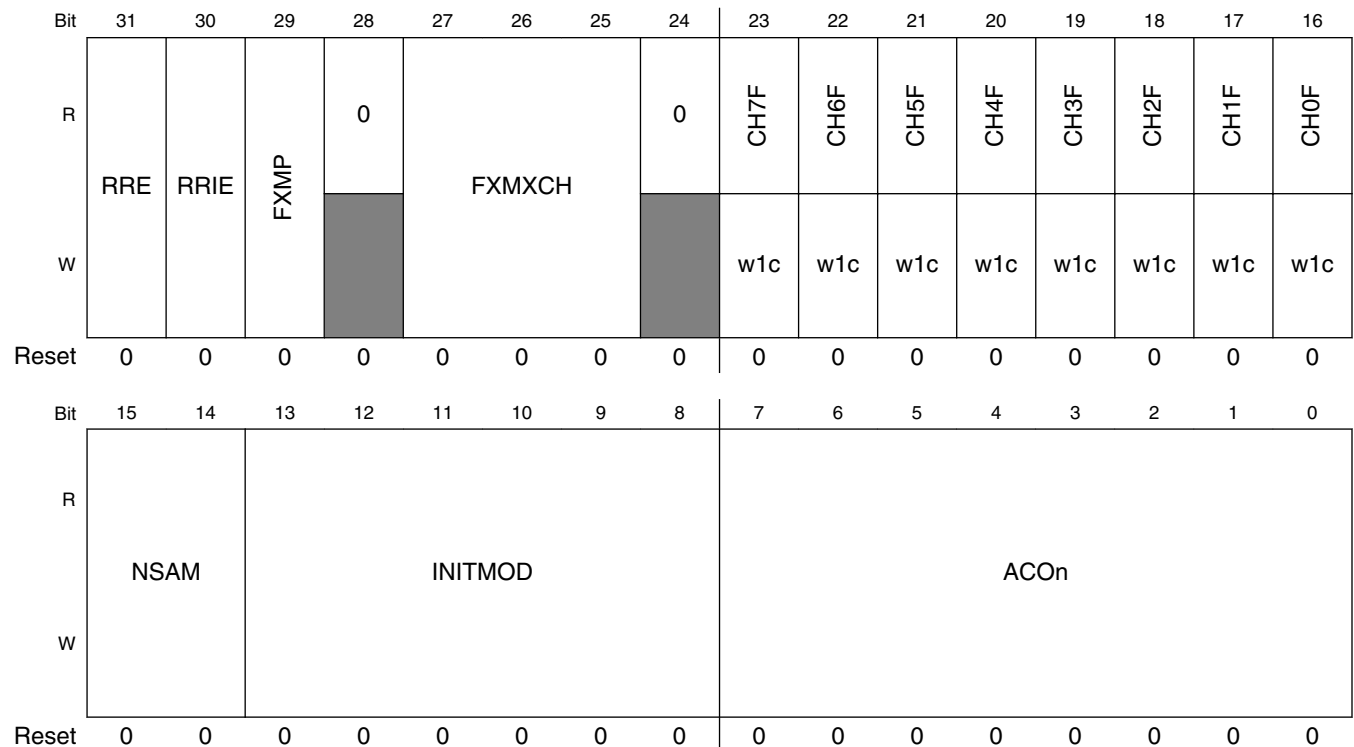

CMP_C2 field descriptions

Field	Description
31 RRE	Round-Robin Enable This bit enables the round-robin operation. 0 Round-robin operation is disabled. 1 Round-robin operation is enabled.
30 RRIE	Round-Robin interrupt enable This bit enables the interrupt/wake-up when the comparison result changes for a given channel. 0 The round-robin interrupt is disabled. 1 The round-robin interrupt is enabled when a comparison result changes from the last sample.
29 FXMP	Fixed MUX Port This bit is used to fix the analog mux port for the round-robin mode. 0 The Plus port is fixed. Only the inputs to the Minus port are swept in each round. 1 The Minus port is fixed. Only the inputs to the Plus port are swept in each round.
28 Reserved	This field is reserved. This read-only field is reserved and always has the value 0.
27–25 FXMXCH	Fixed channel selection This field indicates which channel in the mux port is fixed in a given round-robin mode. 000 Channel 0 is selected as the fixed reference input for the fixed mux port. 001 Channel 1 is selected as the fixed reference input for the fixed mux port. 010 Channel 2 is selected as the fixed reference input for the fixed mux port. 011 Channel 3 is selected as the fixed reference input for the fixed mux port. 100 Channel 4 is selected as the fixed reference input for the fixed mux port. 101 Channel 5 is selected as the fixed reference input for the fixed mux port. 110 Channel 6 is selected as the fixed reference input for the fixed mux port. 111 Channel 7 is selected as the fixed reference input for the fixed mux port.
24 Reserved	This field is reserved. This read-only field is reserved and always has the value 0.
23 CH7F	Channel 7 input changed flag. This bit is set if the channel 7 input changed from the last comparison with the fixed mux port.
22 CH6F	Channel 6 input changed flag. This bit is set if the channel 6 input changed from the last comparison with the fixed mux port.
21 CH5F	Channel 5 input changed flag. This bit is set if the channel 5 input changed from the last comparison with the fixed mux port.
20 CH4F	Channel 4 input changed flag. This bit is set if the channel 4 input changed from the last comparison with the fixed mux port.
19 CH3F	Channel 3 input changed flag. This bit is set if the channel 3 input changed from the last comparison with the fixed mux port.
18 CH2F	Channel 2 input changed flag. This bit is set if the channel 2 input changed from the last comparison with the fixed mux port.
17 CH1F	Channel 1 input changed flag. This bit is set if the channel 1 input changed from the last comparison with the fixed mux port.

Table continues on the next page...

CMP_C2 field descriptions (continued)

Field	Description
16 CH0F	Channel 0 input changed flag. This bit is set if the channel 0 input changed from the last comparison with the fixed mux port.
15–14 NSAM	Number of sample clocks For a given channel, this field specifies how many round-robin clock cycles later the sample takes place. 00 The comparison result is sampled as soon as the active channel is scanned in one round-robin clock. 01 The sampling takes place 1 round-robin clock cycle after the next cycle of the round-robin clock. 10 The sampling takes place 2 round-robin clock cycles after the next cycle of the round-robin clock. 11 The sampling takes place 3 round-robin clock cycles after the next cycle of the round-robin clock.
13–8 INITMOD	Comparator and DAC initialization delay modulus. These values specify the round robin clock cycles used to determine the comparator and DAC initialization delays specified by the datasheet. For example the initialization delay is 80us and the round robin clock is 100kHz, then INITMOD should be set to 80us/10us = 8. 000000 The modulus is set to 64 (same with 111111). other values Initialization delay is set to INITMOD × round robin clock period
ACOn	The result of the input comparison for channel <i>n</i> . This field stores the latest comparison result of the input channel <i>n</i> with the fixed mux port. Reading this bit returns the latest comparison result. Writing this field defines the pre-set state of channel <i>n</i> .

45.9 CMP functional description

The CMP module can be used to compare two analog input voltages applied to INP and INM. CMPO is high when the non-inverting input is greater than the inverting input, and is low when the non-inverting input is less than the inverting input. This signal can be selectively inverted by setting C0[INVT] = 1.

C0[IER] and C0[IEF] are used to select the condition that causes the CMP module to assert an interrupt to the processor. C0[CFF] is set on a falling edge, and C0[CFR] is set on a rising edge of the comparator output. The optionally filtered CMPO can be read directly through C0[COUT].

45.9.1 Initialization

A typical startup sequence is as follows.

The time required to stabilize COUT is the power-on delay of the comparators plus the largest propagation delay from a selected analog source through the analog comparator, windowing function, and filter. See the datasheet for power-on delays of the comparators. The windowing function has a maximum of one bus clock period delay. The filter delay is specified in the [Low-pass filter](#) section.

During operation, the propagation delay of the selected data paths must always be considered. It may take many bus clock cycles for COUT and C0[CFR]/C0[CFF] to reflect an input change or a configuration change to one of the components involved in the data path.

When programmed for filtering modes, COUT initially equals 0 until sufficient clock cycles have elapsed to fill all stages of the filter. This occurs even if COUTA is at a logic 1.

45.9.2 Low-pass filter

The low-pass filter operates on the unfiltered and unsynchronized and optionally inverted comparator output COUTA and generates the filtered and synchronized output COUT. Both COUTA and COUT can be configured as module outputs and are used for different purposes within the system.

Synchronization and edge detection are always used to determine status register bit values. They also apply to COUT for all sampling and windowed modes. Filtering can be performed using an internal timebase defined by FPR[FILT_PER], or using an external SAMPLE input to determine sample time.

The need for digital filtering and the amount of filtering is dependent on user requirements. Filtering can become more useful in the absence of an external hysteresis circuit. Without external hysteresis, high-frequency oscillations can be generated at COUTA when the selected INM and INP input voltages differ by less than the offset voltage of the differential comparator.

45.9.2.1 Enabling filter modes

Filter modes can be enabled by:

- Setting C0[FILTER_CNT] > 0x01 and
- Setting C0[FPR] to a nonzero value or setting C0[SE]=1

If using the divided bus clock to drive the filter, it samples COUTA every C0[FPR] bus clock cycles.

The filter output is at logic 0 when first initialized, and subsequently changes when all the consecutive C0[FILTER_CNT] samples agree that the output value has changed. In other words, C0[COU] is 0 for some initial period, even when COUTA is at logic 1.

Setting all of C0[SE], C0[FPR] and C0[FILTER_CNT] to 0 disables the filter and eliminates switching current associated with the filtering process.

Note

Always switch to this setting prior to making any changes in filter parameters. This resets the filter to a known state.

Switching C0[FILTER_CNT] on the fly without this intermediate step can result in unexpected behavior.

If C0[SE]=1, the filter samples COUTA on each positive transition of the sample input. The output state of the filter changes when all the consecutive C0[FILTER_CNT] samples agree that the output value has changed.

45.9.2.2 Latency issues

The value of C0[FPR] or SAMPLE period must be set such that the sampling period is just longer than the period of the expected noise. This way a noise spike will corrupt only one sample. The value of C0[FILTER_CNT] must be chosen to reduce the probability of noisy samples causing an incorrect transition to be recognized. The probability of an incorrect transition is defined as the probability of an incorrect sample raised to the power of C0[FILTER_CNT].

The values of C0[FPR] or SAMPLE period and C0[FILTER_CNT] must also be traded off against the desire for minimal latency in recognizing actual comparator output transitions. The probability of detecting an actual output change within the nominal latency is the probability of a correct sample raised to the power of C0[FILTER_CNT].

The following table summarizes maximum latency values for the various modes of operation *in the absence of noise*. Filtering latency is restarted each time an actual output transition is masked by noise.

Table 45-5. Comparator sample/filter maximum latencies

Mode #	C0[EN]	C0[WE]	C0[SE]	C0[FILTER_CNT]	Co[FPR]	Operation	Maximum latency ¹
1	0	X	X	X	X	Disabled	N/A
2A	1	0	0	0x00	X	Continuous Mode	T _{PD}
2B	1	0	0	X	0x00		
3A	1	0	1	0x01	X	Sampled, Non-Filtered mode	T _{PD} + T _{SAMPLE} + T _{per}

Table continues on the next page...

Table 45-5. Comparator sample/filter maximum latencies (continued)

Mode #	C0[EN]	C0[WE]	C0[SE]	C0[FILTER_CNT]	Co[FPR]	Operation	Maximum latency ¹
3B	1	0	0	0x01	> 0x00		$T_{PD} + (C0[FPR] * T_{per}) + T_{per}$
4A	1	0	1	> 0x01	X	Sampled, Filtered mode	$T_{PD} + (C0[FILTER_CNT] * T_{SAMPLE}) + T_{per}$
4B	1	0	0	> 0x01	> 0x00		$T_{PD} + (C0[FILTER_CNT] * C0[FPR] * T_{per}) + T_{per}$
5A	1	1	0	0x00	X	Windowed mode	$T_{PD} + T_{per}$
5B	1	1	0	X	0x00		$T_{PD} + T_{per}$
6	1	1	0	0x01	0x01 - 0xFF	Windowed / Resampled mode	$T_{PD} + (C0[FPR] * T_{per}) + 2T_{per}$
7	1	1	0	> 0x01	0x01 - 0xFF	Windowed / Filtered mode	$T_{PD} + (C0[FILTER_CNT] * C0[FPR] * T_{per}) + 2T_{per}$

1. T_{PD} represents the intrinsic delay of the analog component plus the polarity select logic. T_{SAMPLE} is the clock period of the external sample clock. T_{per} is the period of the bus clock.

45.10 Interrupts

The CMP module is capable of generating an interrupt on either the rising- or falling-edge of the comparator output, or both. Assuming the CMP DMA enable bit is not set, the following table gives the conditions in which the interrupt request is asserted and deasserted.

Table 45-6. CMP interrupt generations

When	Then
C0[IER] and C0[CFR] are set	The interrupt request is asserted
C0[IEF] and C0[CFF] are set	The interrupt request is asserted
C0[IER] and C0[CFR] are cleared for a rising-edge interrupt	The interrupt request is deasserted
C0[IEF] and C0[CFF] are cleared for a falling-edge interrupt	The interrupt request is deasserted

45.11 DMA support

Normally, the CMP generates a CPU interrupt if there is a change on the COUT. When DMA support is enabled by setting C0[DMAEN] and the interrupt is enabled by setting C0[IER], C0[IEF], or both, the corresponding change on COUT forces a DMA transfer request rather than a CPU interrupt instead. When the DMA has completed the transfer, it

sends a transfer completing indicator signal that deasserts the DMA transfer request and clears the flag to allow a subsequent change on comparator output to occur and force another DMA request.

45.12 DAC functional description

This section provides DAC functional description.

45.12.1 Digital-to-analog converter block diagram

The following figure shows the block diagram of the DAC module. It contains a 256-tap resistor ladder network and a 256-to-1 multiplexer, which selects an output voltage from one of 256 distinct levels that outputs from DACO. It is controlled through the Control register 1 (CMP_C1). Its supply reference source can be selected from two sources V_{in1} and V_{in2} . The module can be powered down or disabled when not in use. When in the Disabled mode, DACO is connected to the analog ground.

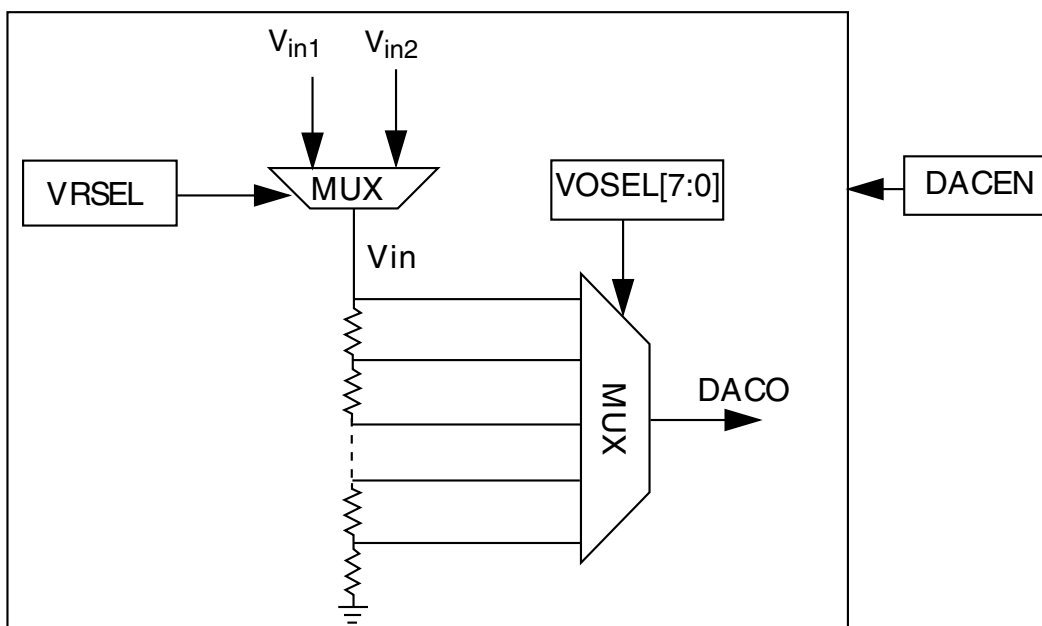

Figure 45-15. 8-bit DAC block diagram

45.12.2 DAC resets

This module has a single reset input, corresponding to the chip-wide peripheral reset.

45.12.3 DAC clocks

This module has a single clock input, the bus clock.

45.12.4 DAC interrupts

This module has no interrupts.

45.13 Trigger mode

The CMP and the 8-bit DAC are designed to support the trigger mode operation, which is enabled when the MCU enters STOP modes with C2[RRE] and C0[EN] are set.

With this mode enabled, the trigger events that include the operation clock and a trigger start signal will initiate a compare sequence that must first enable the CMP and DAC prior to performing a CMP operation and capturing the output. A fixed channel for either the plus-side mux or the minus-side mux is selected by software via C2[FXMP] and C2[FXMXCH]. It is a mandatory request that the round-robin cycling period must be set longer than the time that all the active channels complete the specified comparison cycles set by C2[NSAM].

The active channels selected by C1[CHN n] are then routed to the non-fixed channel mux and compared with the reference input in a round-robin manner. In order to meet the comparator stabilization time, after the configurable number of operation clocks defined by C2[NSAM], the comparison result is sampled for the selected channel. A software pre-programmed state for each channel is configured by writing to C2[ACON] field. After all the active channels are sampled, if the comparison result changes from its pre-programmed state, the corresponding flag in C2[CH n F] is set. If C2[RRIE] is set, an asynchronous reset is asserted to bring the MCU out of STOP mode.

NOTE

These flags do not support generating a DMA transfer event.

This mode is active when the MCU is in STOP mode, so none of the window/filter functions are available. A basic assumption of this mode is that the selected inputs are changing at a much slower rate than the operation clock. It is suggested to configure the comparator in low power comparison mode as well. In programming the C2[INITMOD] registers, the INITMOD \times round-robin clock period must be longer than the initialization delay, which can be referred from the chip datasheet.

Trigger mode

The following diagram shows the basic flow of this mode. In the diagram, C1[CHN1], C1[CHN3], and C1[CHN7] are set, so channels #1, #3, and #7 are selected for round-robin. C2[NSAM] is set to 2'b01, so one clock later the comparison result of the selected channel is sampled. When channel #7 is compared, the result is sampled, and round-robin ends. If any of the comparison results from channel #1, #3, or #7 changed from their programmed value (written to C2[ACO1], C2[ACO3], and C2[ACO7]), an interrupt is generated to wake up the MCU from the STOP mode. Software can then poll the C2[CHnF] to see which channel input(s) changed value during the STOP mode.

NOTE

In round-robin mode, it should be ensured that the RTC_CLK period is greater than the comparison time corresponding to the value of C0[PMODE]. It is also required to **not** select the internal reserved channels for round-robin by INPSEL and INNSEL.

NOTE

In round-robin mode, it is suggested to always configure the DAC output as the fixed port reference.

NOTE

In round-robin mode, current injection or over-voltage is not supported on the input channels.

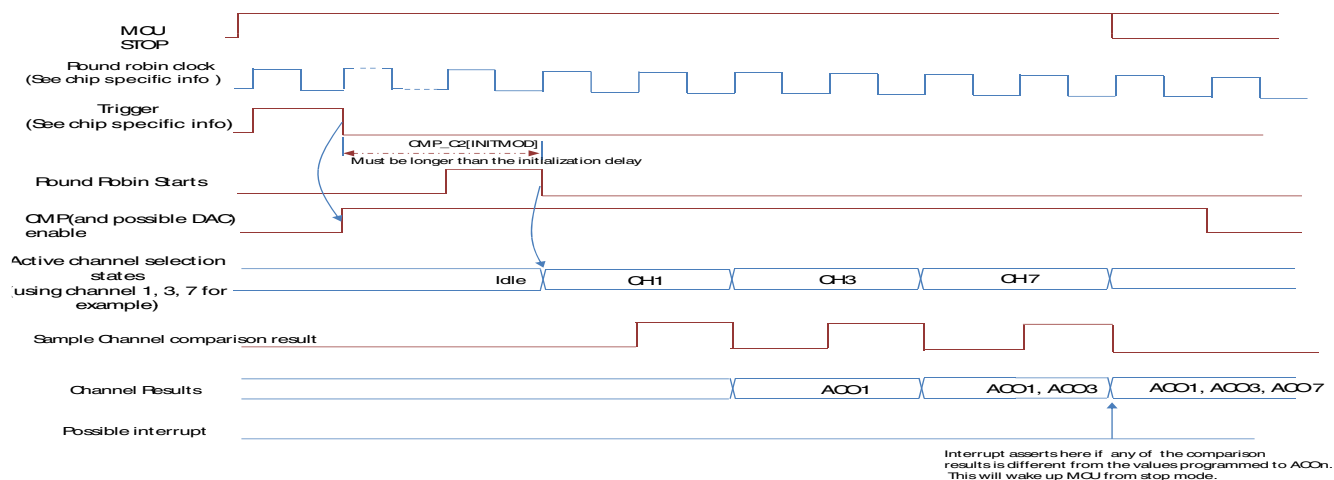

Figure 45-16. Trigger mode

The following table shows the channel decoding in both functional mode and trigger mode. Other cases not listed in the table are illegal.

Table 45-7. CMP channel decoding in functional mode and trigger mode

Mode	RRE	PSEL[2:0]	MSEL[2:0]	INPSEL[1:0]	INNSEL[1:0]	FXMP	FXMXCH[2:0]	CHNx	INP	INN	CMP Behavior
Functional Mode	0	x ¹	0~7	0	1	x	x	x	DAC	Channel decoded from MSEL[2:0]	Channel 0~7 can be compared with DAC
		0~7	x	1	0	x	x	x	Channel decoded from PSEL[2:0]	DAC	Channel 0~7 can be compared with DAC
		0~7	0~7	1	1	x	x	x	Channel decoded from PSEL[2:0]	Channel decoded from MSEL[2:0]	Channel 0~7 can be compared with channel 0~7 ²
Trigger Mode	1	x	x	0	1	0	x	0~7	DAC	Channel sweep (CHNx)	Channel 0~7 can be swept with DAC
		x	x	1	0	1	x	0~7	Channel sweep (CHNx)	DAC	Channel 0~7 can be swept with DAC
		x	x	1	1	0	0~7	0~7	Channel fixed by FXMXCH[2:0]	Channel sweep (CHNx)	Channel 0~7 can be swept with a fixed channel (0~7) ³
		x	x	1	1	1	0~7	0~7	Channel sweep (CHNx)	Channel fixed by FXMXCH[2:0]	Channel 0~7 can be swept with a fixed channel (0~7) ³

1. "x" means "do not care".
2. PSEL should not be set the same as MSEL.
3. Channel in the sweep side should not be the same as the fixed side.

Chapter 46

Programmable delay block (PDB)

46.1 Chip-specific PDB information

46.1.1 Instantiation Information

46.1.1.1 PDB output trigger connections

S32K14x contains two PDB modules. S32K11x contains one PDB module.

Table 46-1. PDB output trigger connections

Chip	Number of slots on PDB	Number of triggers per slot	Number of Pulse Out	Number of pre-triggers slot
S32K116	2	1	1	8
S32K118	2	1	1	8
S32K142	2	1	1	8
S32K144	2	1	1	8
S32K142W	2	1	1	8
S32K144W	2	1	1	8
S32K146	3	1	1	8
S32K148	4	1	1	8

PDB has slots, also referred as PDB channels, for connectivity with chip. Each slot consists of pulse out, triggers, and pre-triggers as mentioned in above table. See [Figure 46-7](#) and [Figure 43-2](#)

46.1.1.2 PDB Input Trigger Connections

On this device, the PDB trigger source selection is implemented through the TRGMUX module. For each PDB unit, there is only one trigger input from TRGMUX, but it

supports different trigger sources. The internal trigger mux inside PDB is not used any more.

Table 46-2. PDB input trigger connections

PDB Trigger	PDB Input
0000	PDBn_trigger_in0

46.1.2 PDB trigger interconnections with ADC and TRGMUX

Besides the specific PDB-ADC triggering scheme (refer to ADC trigger source section), the PDB channel triggers can also work as trigger source of TRGMUX module, which can be used to trigger other modules besides ADC.

Following are PDB module interconnectivities:

Table 46-3. PDB trigger interconnections with ADC and TRGMUX

PDBx Trigger outputs	Interconnectivity
Channel 0 triggers	Trigger connects to both ADC and TRGMUX
Channel 1 trigger	Trigger connects to ADC
Channel 2 trigger	Trigger connects to ADC
Channel 3 trigger	Trigger connects to ADC
Pulse-out	Pulse-out connects to TRGMUX

46.1.3 Back-to-back acknowledgement connections

Back-to-back operation enables the ADC conversions complete to trigger the next PDB channel pre-trigger and trigger output.

In this MCU, the following PDB back-to-back operation acknowledgment connections are implemented based on SIM_CHIPCTL[PDB_BB_SEL] settings. The PDB back to back operation is supported on all channels of each PDB. The PDB back to back forming a ring is supported for channel 0 of each PDB and channel 0 and channel 1 cumulatively.

See [Figure 46-5](#) and [Figure 46-6](#) for detailed back-to-back operation.

The PDB back to back operation provides a flexible inter-channel and intra channel chaining as shown in the following table.

Table 46-4. PDB_BB_SEL inter-channel and intra channel chaining

PDB_BB_SEL_2/SIM CHIPCTL[23]	PDB_BB_SEL_1/SIM CHIPCTL[22]	PDB_BB_SEL/SIM CHIPCTL[13]	Description
0	0	0	Independent intra channel chaining of CH0 of PDB0 and CH0 of PDB1. PDB0 channel0 back-to-back operation with ADC0 COCO[7:0], and PDB1 Channel0 back-to-back operation with ADC1 COCO[7:0]
0	0	1	Chaining of CH0-CH0 of PDB0 and PDB1 Channel0 of PDB0 and PDB1 back-to-back operation with COCO[7:0] of ADC0 and ADC1.
0	1	X	Inter channel chaining of PDB0 CH0 and CH1. Channel0 and Channel1 of PDB0 back-to-back operation with COCO[7:0] and COCO[15:8] of ADC0. PDB1 channel 0 back to back operation with ADC1 COCO[7:0]
1	0	X	Inter channel chaining of PDB1 CH0 and CH1. Channel0 and Channel1 of PDB1 back-to-back operation with COCO[7:0] and COCO[15:8] of ADC1. PDB0 channel 0 back to back operation with ADC0 COCO[7:0]
1	1	X	Inter channel chaining of PDB0 CH0 and CH1 and PDB1 CH0 and CH1 both. Channel0 and Channel1 of PDB0 back-to-back operation with COCO[7:0] and COCO[15:8] of ADC0, and Channel0 and Channel1 of PDB1 back-to-back operation with COCO[7:0] and COCO[15:8] of ADC1.

Table 46-5. Available configurations

Device	Available configurations
S32K11x	No chaining supported.

Table continues on the next page...

Table 46-5. Available configurations (continued)

Device	Available configurations
	PDB_BB_SEL, PDB_BB_SEL_1, and PDB_BB_SEL_2 reserved.
S32K14x	Interchaining of CH0-CH0 of PDB0 and PDB1 supported. PDB_BB_SEL is configurable. PDB_BB_SEL_1 and PDB_BB_SEL_2 are reserved.
S32K14xW	Interchaining of CH0-CH0 of PDB0 and PDB1 supported. Interchaining of CH0 and CH1 amongst PDB0 and independently amongst PDB1 supported. Simultaneous interchaining of both CH0-CH1 of PDB0 and PDB1 supported. PDB_BB_SEL, PDB_BB_SEL_1, and PDB_BB_SEL_2 are configurable.

The back-to-back chain diagrams for PDB0 CH0, PDB1 CH1, and PDB0-PDB1 forming a ring are shown below:

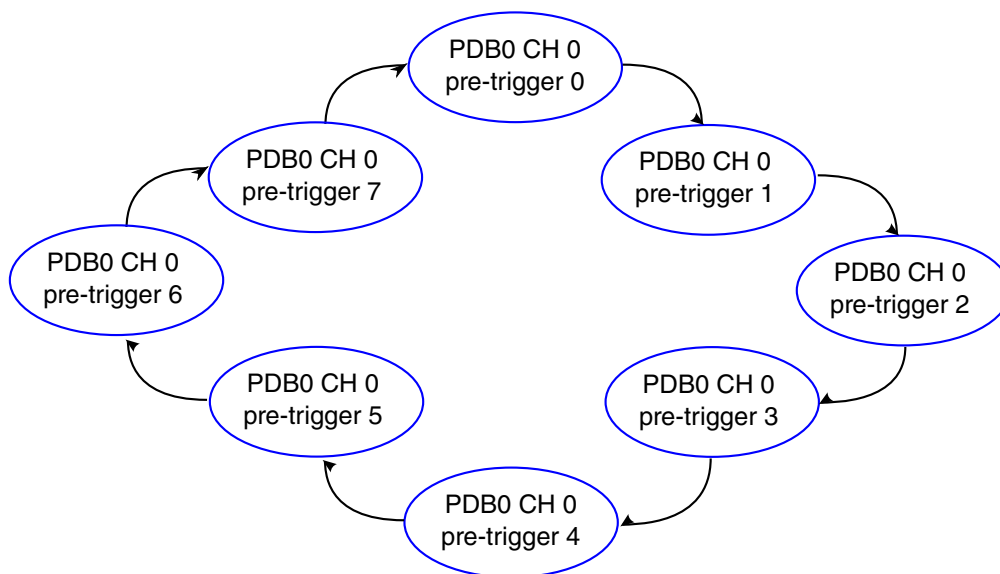

Figure 46-1. Example: PDB0 CH0 back-to-back chain

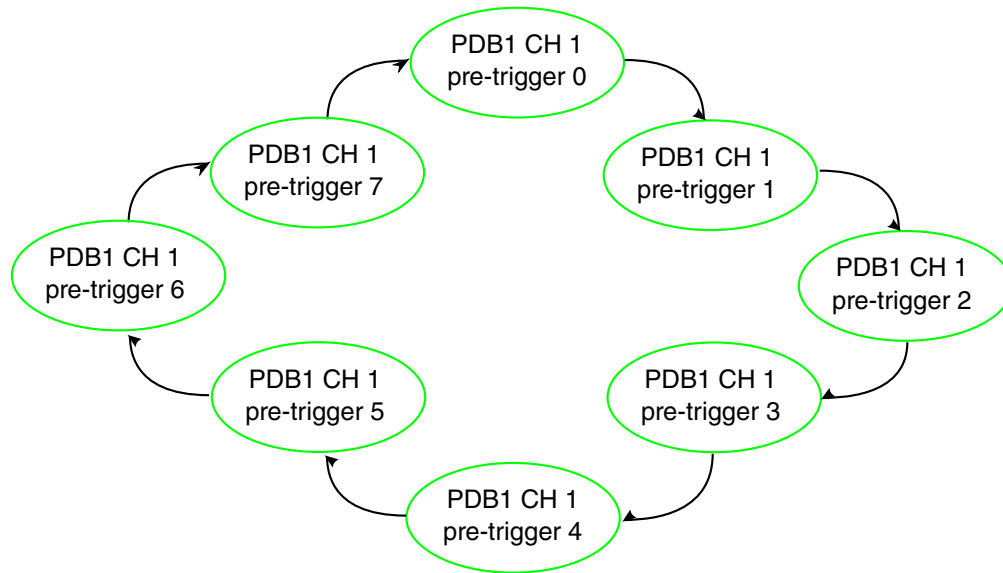

Figure 46-2. Example: PDB1 CH1 back-to-back chain

When `SIM_CHIPCTL[PDB_BB_SEL]=001`:

The PDB back-to-back operation acknowledgement connections are implemented with all of the PDB units as a ring. The chain diagram is as follows:

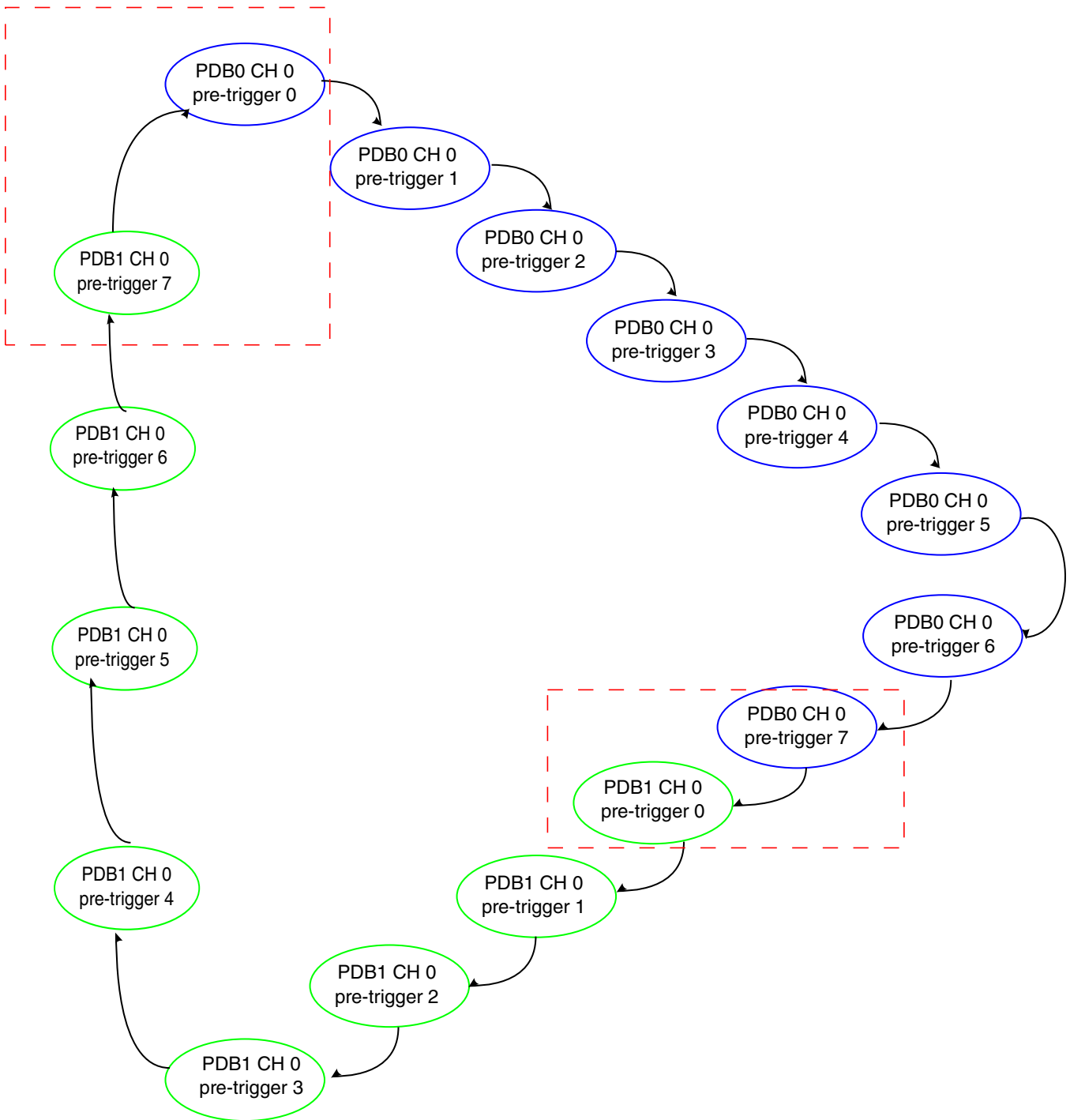

Figure 46-3. PDB back-to-back chain forming PDB0-PDB1 ring

When `SIM_CHIPCTL[PDB_BB_SEL]=01X`: The PDB back-to-back operation acknowledgement connections are implemented with CH0 and CH1 of PDB0 as a chain. The chain diagram is as follows:

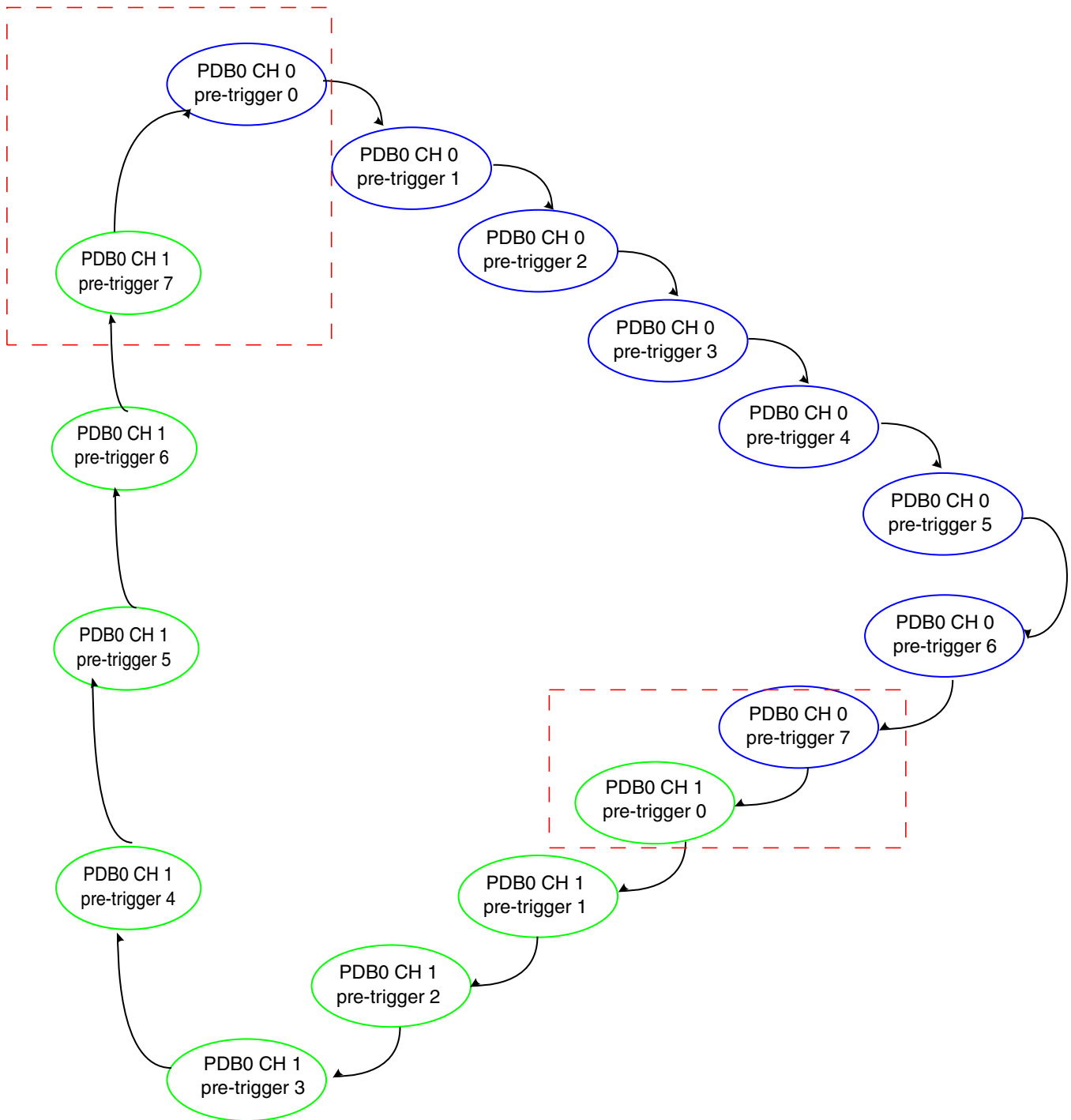

Figure 46-4. PDB back-to-back chain forming PDB0-PDB1 ring

The application code can set the `PDBx_CHnC1[BB]` bits to configure the PDB pre-triggers as a single chain or several chains.

The pre-trigger for the beginning of the chain should be provided from PDB (for e.g., by setting `CHnDLY1` and `CHnC1[EN]` bit) with clearing `PDBx_CHnC1[BB]` bit.

Chip-specific PDB information

For example, the below table shows the configurations with SIM_CHIPCTL[PDB_BB_SEL] being configured as 0 and 1. The device supports more flexibility with combination of SIM_CHIPCTL[PDB_BB_SEL_1] and SIM_CHIPCTL[PDB_BB_SEL_2] which are not depicted in below table for sake of simplicity. See following figure for complete configuration.

Table 46-6. PDB-ADC back to back connection (Part 1 of 2)

PDB Instance	PDB Channel	Pre-Trigger #	Ack Connection from	
			SIM_CHIPCTL[PDB_BB_SEL]=0	SIM_CHIPCTL[PDB_BB_SEL]=1
PDB0	CH0	0	ADC0 SC1H_COCO	ADC1 SC1H_COCO
		1	ADC0 SC1A_COCO	ADC0 SC1A_COCO
		2	ADC0 SC1B_COCO	ADC0 SC1B_COCO
		3	ADC0 SC1C_COCO	ADC0 SC1C_COCO
		4	ADC0 SC1D_COCO	ADC0 SC1D_COCO
		5	ADC0 SC1E_COCO	ADC0 SC1E_COCO
		6	ADC0 SC1F_COCO	ADC0 SC1F_COCO
		7	ADC0 SC1G_COCO	ADC0 SC1G_COCO
PDB0	CH1	0	ADC0 SC1P_COCO	1
		1	ADC0 SC1I_COCO	
		2	ADC0 SC1J_COCO	
		3	ADC0 SC1K_COCO	
		4	ADC0 SC1L_COCO	
		5	ADC0 SC1M_COCO	
		6	ADC0 SC1N_COCO	
		7	ADC0 SC1O_COCO	
PDB0	CH2	0	ADC0 SC1X_COCO	
		1	ADC0 SC1Q_COCO	
		2	ADC0 SC1R_COCO	
		3	ADC0 SC1S_COCO	
		4	ADC0 SC1T_COCO	
		5	ADC0 SC1U_COCO	
		6	ADC0 SC1V_COCO	
		7	ADC0 SC1W_COCO	
PDB0	CH3	0	ADC0 SC1FF_COCO	
		1	ADC0 SC1Y_COCO	
		2	ADC0 SC1Z_COCO	
		3	ADC0 SC1AA_COCO	
		4	ADC0 SC1BB_COCO	
		5	ADC0 SC1CC_COCO	
		6	ADC0 SC1DD_COCO	
		7	ADC0 SC1EE_COCO	

1. PDB back to back operation forming a ring is supported only on Channel 0

Table 46-7. PDB-ADC back to back connection (Part 2 of 2)

PDB Instance	PDB Channel	Pre-Trigger #	Ack Connection from	
			SIM_CHIPCTL[PDB_BB_SEL]=0	SIM_CHIPCTL[PDB_BB_SEL]=1
PDB1	CH0	0	ADC1 SC1H_COCO	ADC0 SC1H_COCO
		1	ADC1 SC1A_COCO	ADC1 SC1A_COCO
		2	ADC1 SC1B_COCO	ADC1 SC1B_COCO
		3	ADC1 SC1C_COCO	ADC1 SC1C_COCO
		4	ADC1 SC1D_COCO	ADC1 SC1D_COCO
		5	ADC1 SC1E_COCO	ADC1 SC1E_COCO
		6	ADC1 SC1F_COCO	ADC1 SC1F_COCO
		7	ADC1 SC1G_COCO	ADC1 SC1G_COCO
PDB1	CH1	0	ADC1 SC1P_COCO	1
		1	ADC1 SC1I_COCO	
		2	ADC1 SC1J_COCO	
		3	ADC1 SC1K_COCO	
		4	ADC1 SC1L_COCO	
		5	ADC1 SC1M_COCO	
		6	ADC1 SC1N_COCO	
		7	ADC1 SC1O_COCO	
PDB1	CH2	0	ADC1 SC1X_COCO	1
		1	ADC1 SC1Q_COCO	
		2	ADC1 SC1R_COCO	
		3	ADC1 SC1S_COCO	
		4	ADC1 SC1T_COCO	
		5	ADC1 SC1U_COCO	
		6	ADC1 SC1V_COCO	
		7	ADC1 SC1W_COCO	
PDB1	CH3	0	ADC1 SC1FF_COCO	1
		1	ADC1 SC1Y_COCO	
		2	ADC1 SC1Z_COCO	
		3	ADC1 SC1AA_COCO	
		4	ADC1 SC1BB_COCO	
		5	ADC1 SC1CC_COCO	
		6	ADC1 SC1DD_COCO	
		7	ADC1 SC1EE_COCO	

1. PDB back to back operation forming a ring is supported only on Channel 0

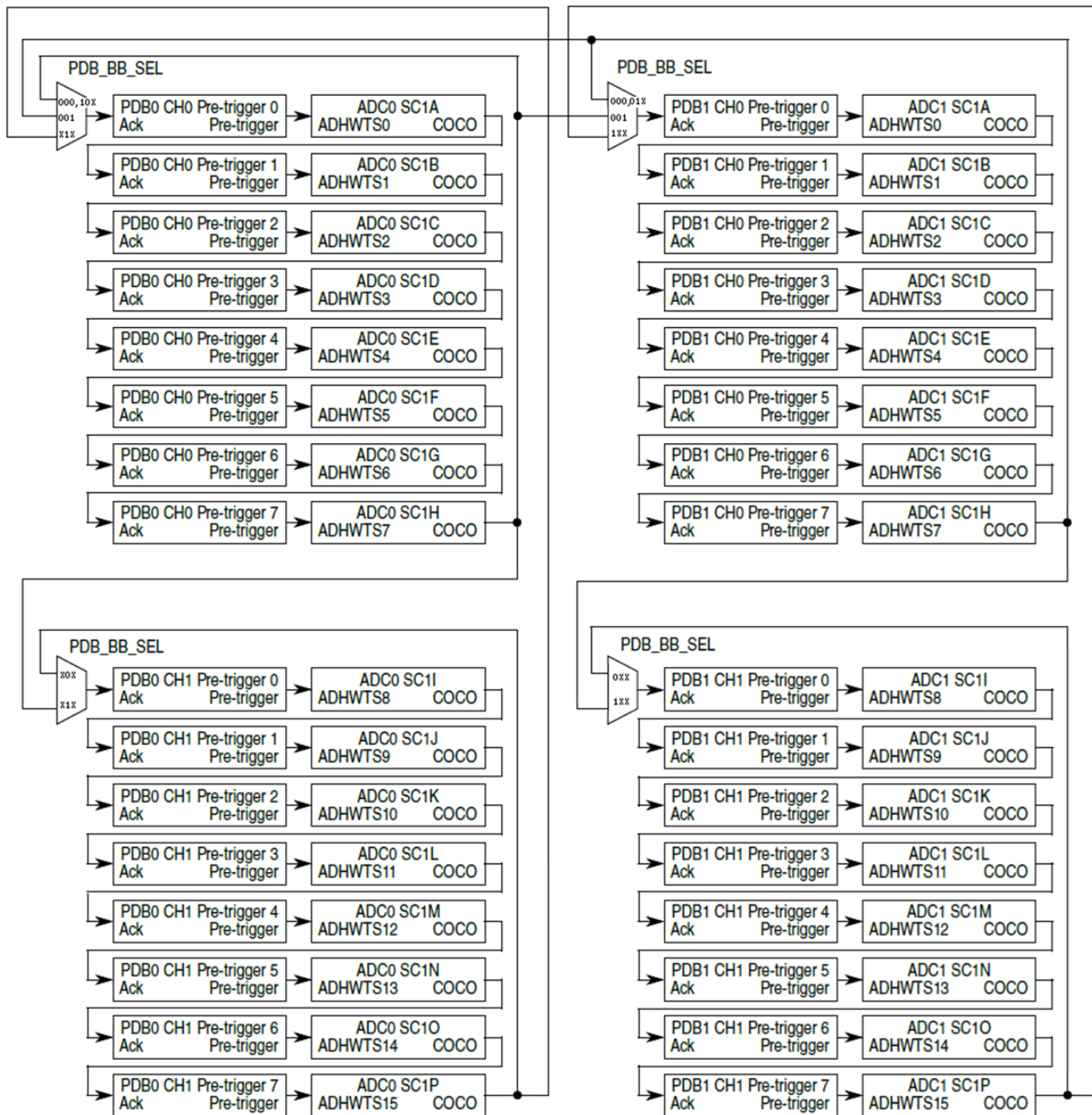

Figure 46-5. PDB-ADC back to back connection (Part 1 of 2)

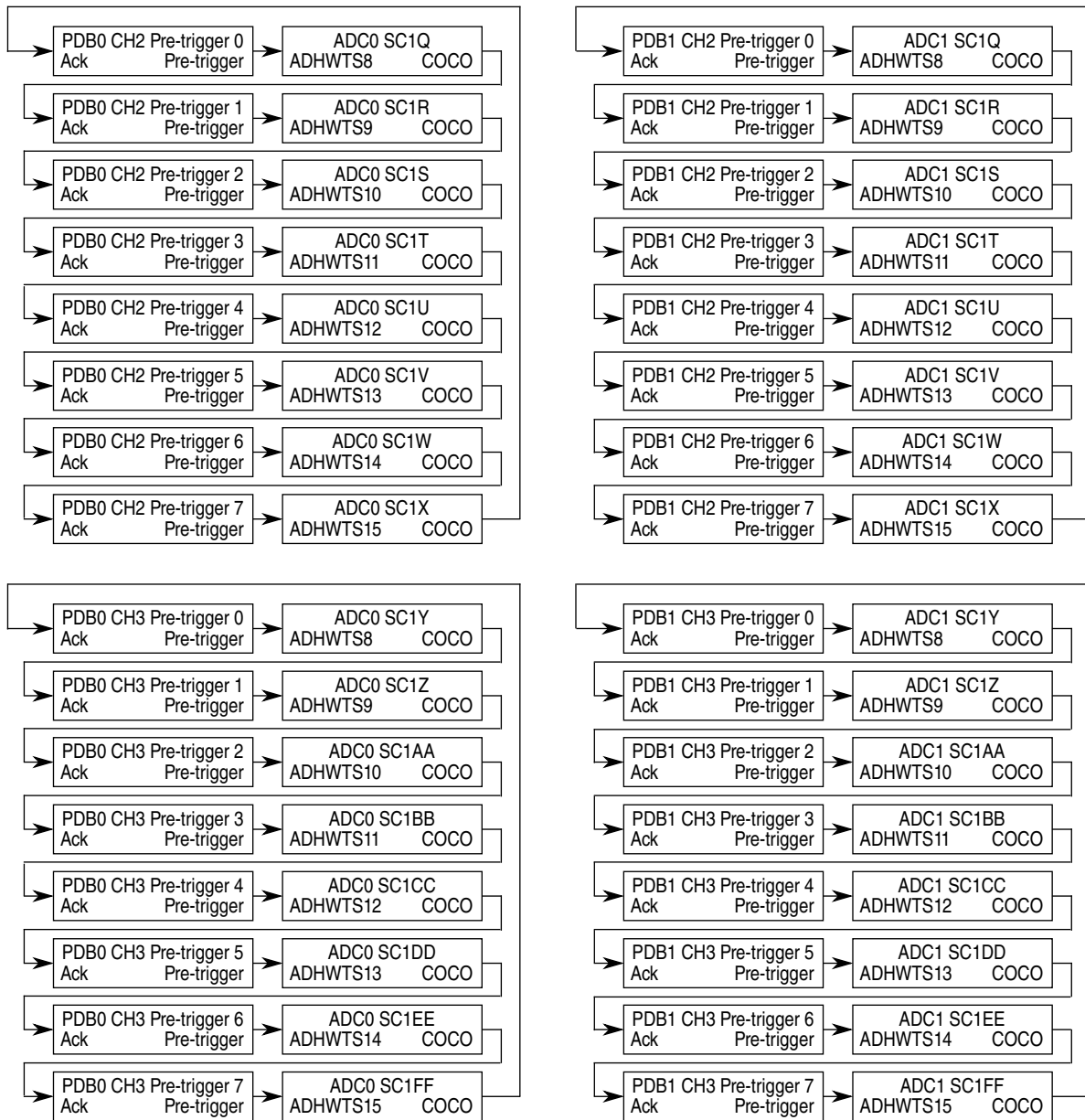

Figure 46-6. PDB-ADC back to back connection (Part 2 of 2)

46.1.4 Pulse-Out Enable Register Implementation

The following table shows the comparison of pulse-out enable register at the module and chip level. In this device, each PDB unit will have one Pulse-Out channel. The Pulse-Out is connecting to TRGMUX, which is then flexible to work as sample window for any CMP module.

Table 46-8. PDB pulse-out enable register

Register	Module implementation	Chip implementation
POnEN	7:0 - POEN 31:8 - Reserved	0 - POEN[0] for CMP 31:1 - Reserved

46.1.5 S32K11X to S32K14X difference

See [Differences between S32K14x/S32K14xW, and S32K11x](#), for differences arising out of CPU and interrupt latency impacting timed events when comparing S32K14X and S32K11X variants.

46.2 Introduction

The Programmable Delay Block (PDB) provides controllable delays from either an internal or an external trigger, or a programmable interval tick, to the hardware trigger inputs of ADCs. The PDB can optionally provide pulse outputs (Pulse-Out's) that are used as the sample window in the CMP block.

46.2.1 Features

- Up to 2 trigger input sources and one software trigger source
- Up to 8 configurable PDB channels for ADC hardware trigger
 - One PDB channel is associated with one ADC
 - One trigger output for ADC hardware trigger and up to 8 pre-trigger outputs for ADC trigger select per PDB channel
 - Trigger outputs can be enabled or disabled independently

- One 16-bit delay register per pre-trigger output
- Optional bypass of the delay registers of the pre-trigger outputs
- Operation in One-Shot or Continuous modes
- Optional back-to-back mode operation, which enables the ADC conversions complete to trigger the next PDB channel
- One programmable delay interrupt
- One sequence error interrupt
- One channel flag and one sequence error flag per pre-trigger
- DMA support
- Up to 8 pulse outputs (pulse-out's)
 - Pulse-out's can be enabled or disabled independently
 - Programmable pulse width

NOTE

The number of PDB input and output triggers are chip-specific. See the chip-specific PDB information for details.

46.2.2 Implementation

In this section, the following letters refer to the number of output triggers:

- N —Total available number of PDB channels.
- n —PDB channel number, valid from 0 to $N-1$.
- M —Total available pre-trigger per PDB channel.
- m —Pre-trigger number, valid from 0 to $M-1$.
- Y —Total number of Pulse-Out's.
- y —Pulse-Out number, valid value is from 0 to $Y-1$.

NOTE

The number of module output triggers to core is chip-specific. For module to core output triggers implementation, see the chip configuration information.

46.2.3 Back-to-back acknowledgment connections

PDB back-to-back operation acknowledgment connections are chip-specific. For implementation, see the chip configuration information.

46.2.4 Block diagram

This diagram illustrates the major components of the PDB.

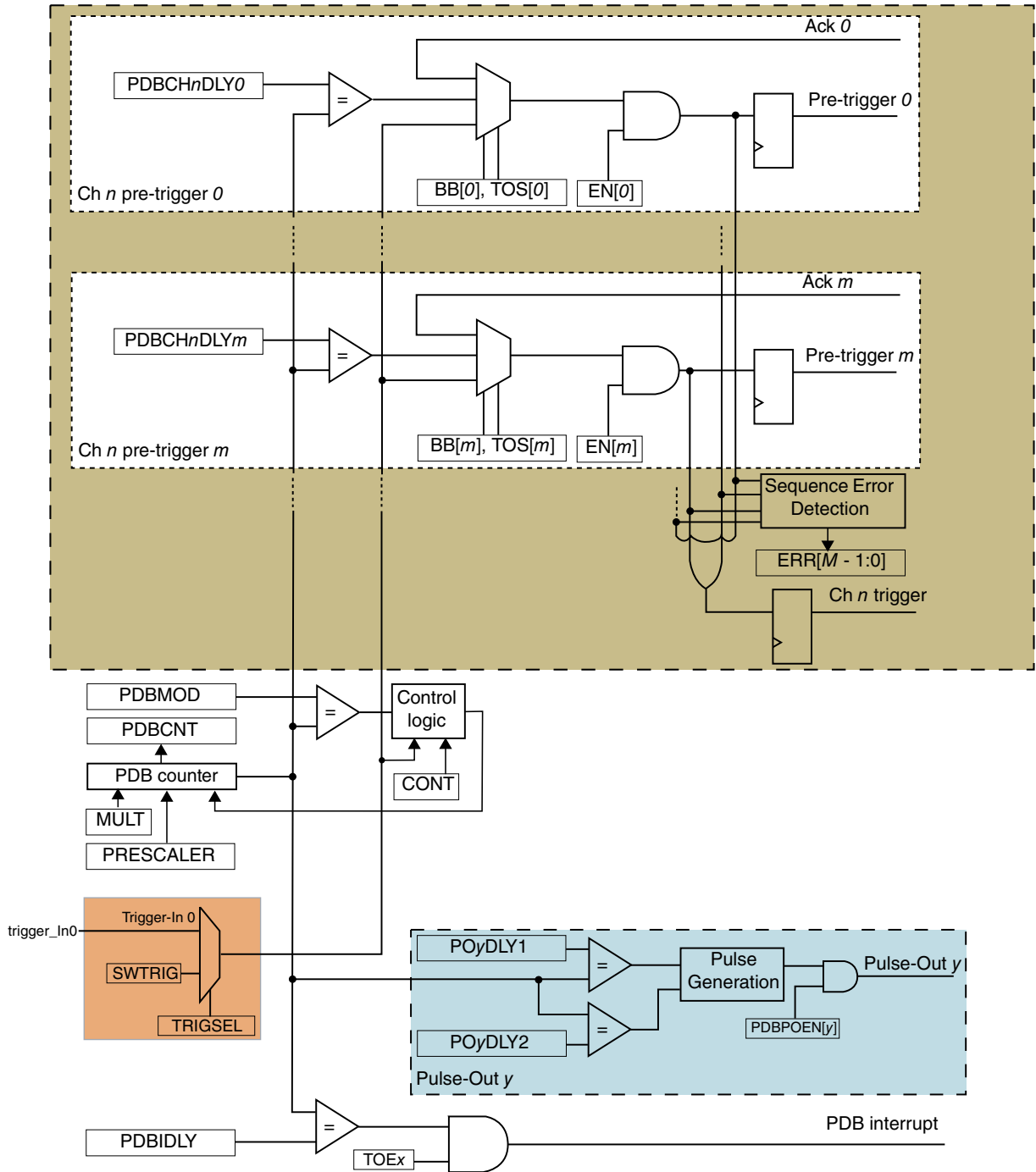

Figure 46-7. PDB block diagram

In this diagram, only one PDB channel n , and one Pulse-Out y are shown. The PDB-enabled control logic and the sequence error interrupt logic are not shown.

46.2.5 Modes of operation

PDB ADC trigger operates in the following modes:

- Disabled—Counter is off, all pre-trigger and trigger outputs are low if PDB is not in back-to-back operation of Bypass mode.
- Debug—Counter is paused when processor is in Debug mode.
- Enabled One-Shot—Counter is enabled and restarted at count zero upon receiving a positive edge on the selected trigger input source or software trigger is selected and SC[SWTRIG] is written with 1. In each PDB channel, an enabled pre-trigger asserts once per trigger input event. The trigger output asserts whenever any of the pre-triggers is asserted.
- Enabled Continuous—Counter is enabled and restarted at count zero. The counter is rolled over to zero again when the count reaches the value specified in the modulus register, and the counting is restarted. This enables a continuous stream of pre-triggers/trigger outputs as a result of a single trigger input event.
- Enabled Bypassed—The pre-trigger and trigger outputs assert immediately after a positive edge on the selected trigger input source or software trigger is selected and SC[SWTRIG] is written with 1, that is the delay registers are bypassed. It is possible to bypass any one or more of the delay registers; therefore, this mode can be used in conjunction with One-Shot or Continuous mode.

46.3 Memory map and register definition

PDB memory map

Address offset (hex)	Register name	Width (in bits)	Access	Reset value	Section/page
0	Status and Control register (PDB_SC)	32	R/W	0000_0000h	46.3.1/1326
4	Modulus register (PDB_MOD)	32	R/W	0000_FFFFh	46.3.2/1329
8	Counter register (PDB_CNT)	32	R	0000_0000h	46.3.3/1330
C	Interrupt Delay register (PDB_IDLY)	32	R/W	0000_FFFFh	46.3.4/1330
10	Channel n Control register 1 (PDB_CH0C1)	32	R/W	0000_0000h	46.3.5/1331
14	Channel n Status register (PDB_CH0S)	32	R/W	0000_0000h	46.3.6/1332
18	Channel n Delay 0 register (PDB_CH0DLY0)	32	R/W	0000_0000h	46.3.7/1332
1C	Channel n Delay 1 register (PDB_CH0DLY1)	32	R/W	0000_0000h	46.3.8/1333
20	Channel n Delay 2 register (PDB_CH0DLY2)	32	R/W	0000_0000h	46.3.9/1334
24	Channel n Delay 3 register (PDB_CH0DLY3)	32	R/W	0000_0000h	46.3.10/1334
28	Channel n Delay 4 register (PDB_CH0DLY4)	32	R/W	0000_0000h	46.3.11/1335

Table continues on the next page...

PDB memory map (continued)

Address offset (hex)	Register name	Width (in bits)	Access	Reset value	Section/page
2C	Channel n Delay 5 register (PDB_CH0DLY5)	32	R/W	0000_0000h	46.3.12/1336
30	Channel n Delay 6 register (PDB_CH0DLY6)	32	R/W	0000_0000h	46.3.13/1336
34	Channel n Delay 7 register (PDB_CH0DLY7)	32	R/W	0000_0000h	46.3.14/1337
38	Channel n Control register 1 (PDB_CH1C1)	32	R/W	0000_0000h	46.3.5/1331
3C	Channel n Status register (PDB_CH1S)	32	R/W	0000_0000h	46.3.6/1332
40	Channel n Delay 0 register (PDB_CH1DLY0)	32	R/W	0000_0000h	46.3.7/1332
44	Channel n Delay 1 register (PDB_CH1DLY1)	32	R/W	0000_0000h	46.3.8/1333
48	Channel n Delay 2 register (PDB_CH1DLY2)	32	R/W	0000_0000h	46.3.9/1334
4C	Channel n Delay 3 register (PDB_CH1DLY3)	32	R/W	0000_0000h	46.3.10/1334
50	Channel n Delay 4 register (PDB_CH1DLY4)	32	R/W	0000_0000h	46.3.11/1335
54	Channel n Delay 5 register (PDB_CH1DLY5)	32	R/W	0000_0000h	46.3.12/1336
58	Channel n Delay 6 register (PDB_CH1DLY6)	32	R/W	0000_0000h	46.3.13/1336
5C	Channel n Delay 7 register (PDB_CH1DLY7)	32	R/W	0000_0000h	46.3.14/1337
60	Channel n Control register 1 (PDB_CH2C1)	32	R/W	0000_0000h	46.3.5/1331
64	Channel n Status register (PDB_CH2S)	32	R/W	0000_0000h	46.3.6/1332
68	Channel n Delay 0 register (PDB_CH2DLY0)	32	R/W	0000_0000h	46.3.7/1332
6C	Channel n Delay 1 register (PDB_CH2DLY1)	32	R/W	0000_0000h	46.3.8/1333
70	Channel n Delay 2 register (PDB_CH2DLY2)	32	R/W	0000_0000h	46.3.9/1334
74	Channel n Delay 3 register (PDB_CH2DLY3)	32	R/W	0000_0000h	46.3.10/1334
78	Channel n Delay 4 register (PDB_CH2DLY4)	32	R/W	0000_0000h	46.3.11/1335
7C	Channel n Delay 5 register (PDB_CH2DLY5)	32	R/W	0000_0000h	46.3.12/1336
80	Channel n Delay 6 register (PDB_CH2DLY6)	32	R/W	0000_0000h	46.3.13/1336
84	Channel n Delay 7 register (PDB_CH2DLY7)	32	R/W	0000_0000h	46.3.14/1337
88	Channel n Control register 1 (PDB_CH3C1)	32	R/W	0000_0000h	46.3.5/1331
8C	Channel n Status register (PDB_CH3S)	32	R/W	0000_0000h	46.3.6/1332
90	Channel n Delay 0 register (PDB_CH3DLY0)	32	R/W	0000_0000h	46.3.7/1332
94	Channel n Delay 1 register (PDB_CH3DLY1)	32	R/W	0000_0000h	46.3.8/1333
98	Channel n Delay 2 register (PDB_CH3DLY2)	32	R/W	0000_0000h	46.3.9/1334
9C	Channel n Delay 3 register (PDB_CH3DLY3)	32	R/W	0000_0000h	46.3.10/1334

Table continues on the next page...

PDB memory map (continued)

Address offset (hex)	Register name	Width (in bits)	Access	Reset value	Section/page
A0	Channel n Delay 4 register (PDB_CH3DLY4)	32	R/W	0000_0000h	46.3.11/ 1335
A4	Channel n Delay 5 register (PDB_CH3DLY5)	32	R/W	0000_0000h	46.3.12/ 1336
A8	Channel n Delay 6 register (PDB_CH3DLY6)	32	R/W	0000_0000h	46.3.13/ 1336
AC	Channel n Delay 7 register (PDB_CH3DLY7)	32	R/W	0000_0000h	46.3.14/ 1337
190	Pulse-Out n Enable register (PDB_POEN)	32	R/W	0000_0000h	46.3.15/ 1337
194	Pulse-Out n Delay register (PDB_PO0DLY)	32	R/W	0000_0000h	46.3.16/ 1338

46.3.1 Status and Control register (PDB_SC)

Address: 0h base + 0h offset = 0h

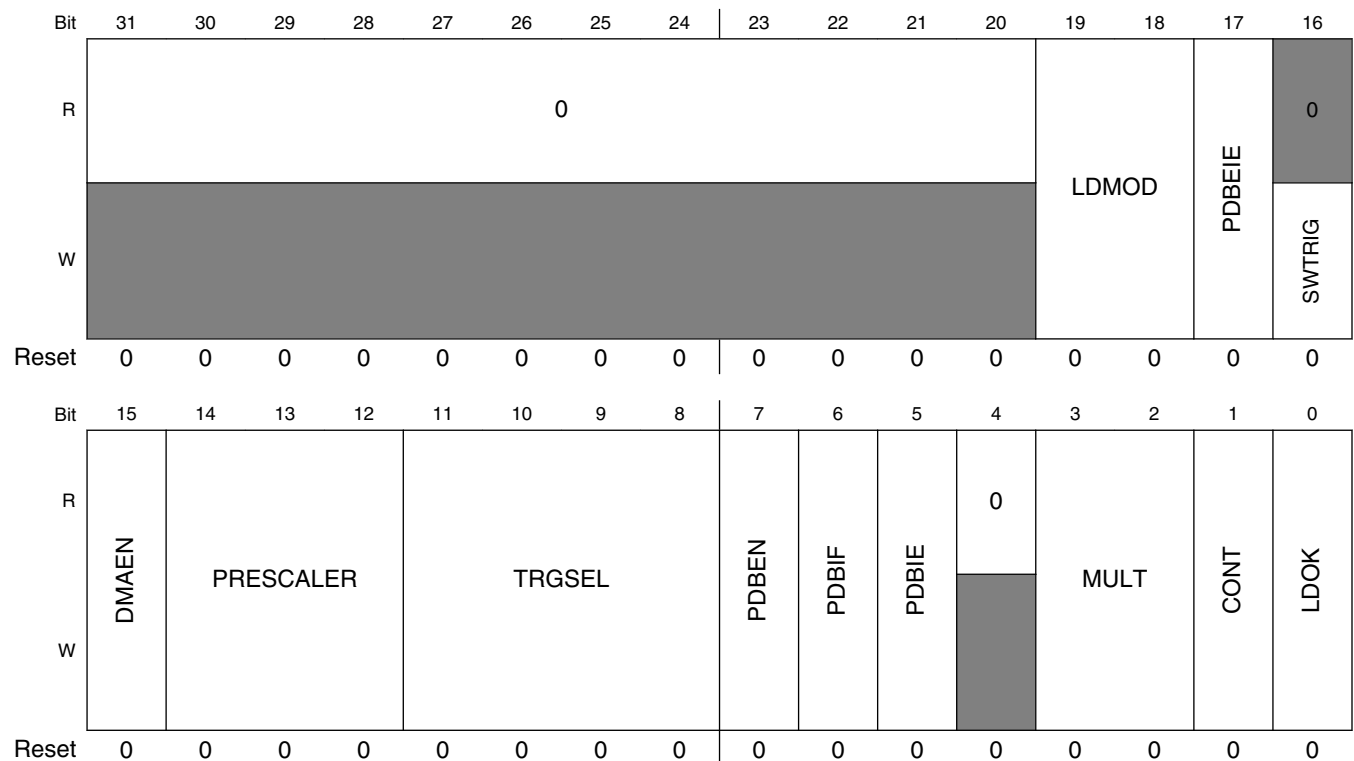

PDB_SC field descriptions

Field	Description
31–20 Reserved	This field is reserved. This read-only field is reserved and always has the value 0.

Table continues on the next page...

PDB_SC field descriptions (continued)

Field	Description
19–18 LDMOD	<p>Load Mode Select</p> <p>Selects the mode to load the MOD, IDLY, CHnDLYm, INTx, and POyDLY registers, after 1 is written to LDOK.</p> <p>00 The internal registers are loaded with the values from their buffers, immediately after 1 is written to LDOK.</p> <p>01 The internal registers are loaded with the values from their buffers when the PDB counter (CNT) = MOD + 1 CNT delay elapsed, after 1 is written to LDOK.</p> <p>10 The internal registers are loaded with the values from their buffers when a trigger input event is detected, after 1 is written to LDOK.</p> <p>11 The internal registers are loaded with the values from their buffers when either the PDB counter (CNT) = MOD + 1 CNT delay elapsed, or a trigger input event is detected, after 1 is written to LDOK.</p>
17 PDBEIE	<p>PDB Sequence Error Interrupt Enable</p> <p>Enables the PDB sequence error interrupt. When PDBEIE is set, any of the PDB channel sequence error flags generates a PDB sequence error interrupt.</p> <p>0 PDB sequence error interrupt disabled.</p> <p>1 PDB sequence error interrupt enabled.</p>
16 SWTRIG	<p>Software Trigger</p> <p>When PDB is enabled and the software trigger is selected as the trigger input source, writing 1 to SWTRIG resets and restarts the counter. Writing 0 to SWTRIG has no effect. Reading SWTRIG yields 0.</p>
15 DMAEN	<p>DMA Enable</p> <p>When DMA is enabled, the PDBIF flag generates a DMA request instead of an interrupt.</p> <p>0 DMA disabled.</p> <p>1 DMA enabled.</p>
14–12 PRESCALER	<p>Prescaler Divider Select</p> <p>Counting uses the peripheral clock divided by the product of a factor (selected by MULT field) and an integer factor (set by PRESCALAR field), or in other words, (peripheral clock)/(MULT x PRESCALAR).</p> <p>000 Counting uses the peripheral clock divided by MULT (the multiplication factor).</p> <p>001 Counting uses the peripheral clock divided by 2 x MULT (the multiplication factor).</p> <p>010 Counting uses the peripheral clock divided by 4 x MULT (the multiplication factor).</p> <p>011 Counting uses the peripheral clock divided by 8 x MULT (the multiplication factor).</p> <p>100 Counting uses the peripheral clock divided by 16 x MULT (the multiplication factor).</p> <p>101 Counting uses the peripheral clock divided by 32 x MULT (the multiplication factor).</p> <p>110 Counting uses the peripheral clock divided by 64 x MULT (the multiplication factor).</p> <p>111 Counting uses the peripheral clock divided by 128 x MULT (the multiplication factor).</p>
11–8 TRGSEL	<p>Trigger Input Source Select</p> <p>Selects the trigger input source for the PDB. The trigger input source can be internal or external (EXTRG pin), or the software trigger. Refer to chip configuration details for the actual PDB input trigger connections.</p> <p>0000 Trigger-In 0 is selected.</p> <p>0001 Trigger-In 1 is selected.</p> <p>0010 Trigger-In 2 is selected.</p>

Table continues on the next page...

PDB_SC field descriptions (continued)

Field	Description
	0011 Trigger-In 3 is selected. 0100 Trigger-In 4 is selected. 0101 Trigger-In 5 is selected. 0110 Trigger-In 6 is selected. 0111 Trigger-In 7 is selected. 1000 Trigger-In 8 is selected. 1001 Trigger-In 9 is selected. 1010 Trigger-In 10 is selected. 1011 Trigger-In 11 is selected. 1100 Trigger-In 12 is selected. 1101 Trigger-In 13 is selected. 1110 Trigger-In 14 is selected. 1111 Software trigger is selected.
7 PDBEN	PDB Enable 0 PDB disabled. Counter is off. 1 PDB enabled.
6 PDBIF	PDB Interrupt Flag PDBIF is set when the counter value is equal to the IDLY register + 1. <ul style="list-style-type: none"> • Write zero to clear PDBIF. • Writing 1 to PDBIF has no effect.
5 PDBIE	PDB Interrupt Enable Enables the PDB interrupt. When PDBIE is set and DMAEN is cleared, PDBIF generates a PDB interrupt. 0 PDB interrupt disabled. 1 PDB interrupt enabled.
4 Reserved	This field is reserved. This read-only field is reserved and always has the value 0.
3–2 MULT	Multiplication Factor Select for Prescaler Selects the multiplication factor of the prescaler divider for the counter clock. 00 Multiplication factor is 1. 01 Multiplication factor is 10. 10 Multiplication factor is 20. 11 Multiplication factor is 40.
1 CONT	Continuous Mode Enable Enables the PDB operation in Continuous mode. 0 PDB operation in One-Shot mode 1 PDB operation in Continuous mode
0 LDOK	Load OK Writing 1 to LDOK bit updates the MOD, IDLY, CHnDLYm, and POyDLY registers with the values previously written to their internal buffers (and stored there). The new values of MOD, IDLY, CHnDLYm, and POyDLY registers will take effect according to the setting of the LDMOD field (Load Mode Select).

Table continues on the next page...

PDB_SC field descriptions (continued)

Field	Description
	<p>Before 1 is written to the LDOK field, the values in the internal buffers of these registers are not effective, and new values cannot be written to the internal buffers until the existing values in the internal buffers are loaded into their corresponding registers.</p> <ul style="list-style-type: none"> • LDOK can be written only when PDBEN is set, or LDOK can be written at the same time when PDBEN is written to 1. • LDOK is automatically cleared when the values in the internal buffers are loaded into the registers or when PDBEN bit (PDB Enable) is cleared. • Writing 0 to LDOK has no effect.

46.3.2 Modulus register (PDB_MOD)

Note: This register is internally buffered, and any values written to the register are written to its internal buffer instead; in other words, the internal device bus does not write directly to this register. The value in this register's internal buffer is loaded into this register only after "1" is written to the SC[LDOK] bit.

Address: 0h base + 4h offset = 4h

Bit	31	30	29	28	27	26	25	24	23	22	21	20	19	18	17	16	15	14	13	12	11	10	9	8	7	6	5	4	3	2	1	0
R	0																MOD															
W	0																1															
Reset	0	0	0	0	0	0	0	0	0	0	0	0	0	0	0	0	1	1	1	1	1	1	1	1	1	1	1	1	1	1	1	1

PDB_MOD field descriptions

Field	Description
31–16 Reserved	<p>This field is reserved. This read-only field is reserved and always has the value 0.</p>
MOD	<p>PDB Modulus</p> <p>Specifies the period of the counter. When the counter reaches this value, it will be reset back to zero. If the PDB is in Continuous mode, the count begins anew. Reading this field returns the value of the internal register that is effective for the current cycle of PDB.</p>

46.3.3 Counter register (PDB_CNT)

NOTE

Writing to this read-only register will not generate a transfer error or hard fault.

Address: 0h base + 8h offset = 8h

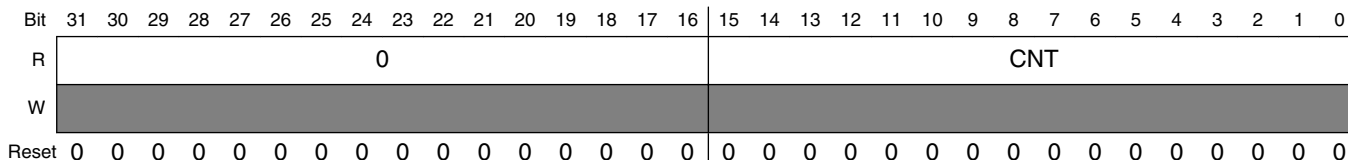

PDB_CNT field descriptions

Field	Description
31–16 Reserved	This field is reserved. This read-only field is reserved and always has the value 0.
CNT	PDB Counter Contains the current value of the counter.

46.3.4 Interrupt Delay register (PDB_IDLY)

Note: This register is internally buffered, and any values written to the register are written to its internal buffer instead; in other words, the internal device bus does not write directly to this register. The value in this register's internal buffer is loaded into this register only after "1" is written to the SC[LDOK] bit.

Address: 0h base + Ch offset = Ch

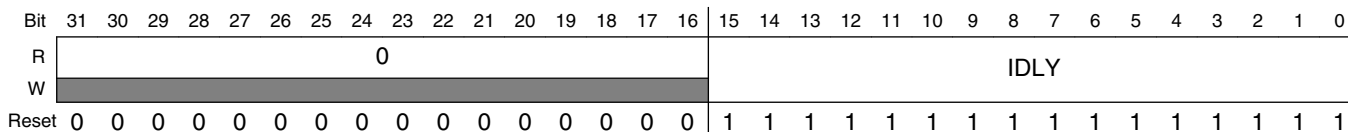

PDB_IDLY field descriptions

Field	Description
31–16 Reserved	This field is reserved. This read-only field is reserved and always has the value 0.
IDLY	PDB Interrupt Delay

Table continues on the next page...

PDB_IDLY field descriptions (continued)

Field	Description
	Specifies the delay value to schedule the PDB interrupt. It can be used to schedule an independent interrupt at some point in the PDB cycle. If enabled, a PDB interrupt is generated, when the counter is equal to the IDLY. Reading this field returns the value of internal register that is effective for the current cycle of the PDB.

46.3.5 Channel n Control register 1 (PDB_CHnC1)

Each PDB channel has one control register, CHnC1. The bits in this register control the functionality of each PDB channel operation.

Address: 0h base + 10h offset + (40d × i), where i=0d to 3d

Bit	31	30	29	28	27	26	25	24	23	22	21	20	19	18	17	16	15	14	13	12	11	10	9	8	7	6	5	4	3	2	1	0
R	0								BB								TOS								EN							
W	0								0								0								0							
Reset	0	0	0	0	0	0	0	0	0	0	0	0	0	0	0	0	0	0	0	0	0	0	0	0	0	0	0	0	0	0	0	0

PDB_CHnC1 field descriptions

Field	Description
31–24 Reserved	This field is reserved. This read-only field is reserved and always has the value 0.
23–16 BB	PDB Channel Pre-Trigger Back-to-Back Operation Enable These bits enable the PDB ADC pre-trigger operation as back-to-back mode. Only lower M pre-trigger bits are implemented in this MCU. Back-to-back operation enables the ADC conversions complete to trigger the next PDB channel pre-trigger and trigger output, so that the ADC conversions can be triggered on next set of configuration and results registers. Application code must only enable the back-to-back operation of the PDB pre-triggers at the leading of the back-to-back connection chain. 0 PDB channel's corresponding pre-trigger back-to-back operation disabled. 1 PDB channel's corresponding pre-trigger back-to-back operation enabled.
15–8 TOS	PDB Channel Pre-Trigger Output Select These bits select the PDB ADC pre-trigger outputs. Only lower M pre-trigger bits are implemented in this MCU. 0 PDB channel's corresponding pre-trigger is in bypassed mode. The pre-trigger asserts one peripheral clock cycle after a rising edge is detected on selected trigger input source or software trigger is selected and SWTRIG is written with 1. 1 PDB channel's corresponding pre-trigger asserts when the counter reaches the channel delay register plus one peripheral clock cycle after a rising edge is detected on selected trigger input source or software trigger is selected and SWTRIG is written with 1.
EN	PDB Channel Pre-Trigger Enable These bits enable the PDB ADC pre-trigger outputs. Only lower M pre-trigger bits are implemented in this MCU. 0 PDB channel's corresponding pre-trigger disabled. 1 PDB channel's corresponding pre-trigger enabled.

46.3.6 Channel n Status register (PDB_CHnS)

Address: 0h base + 14h offset + (40d × i), where i=0d to 3d

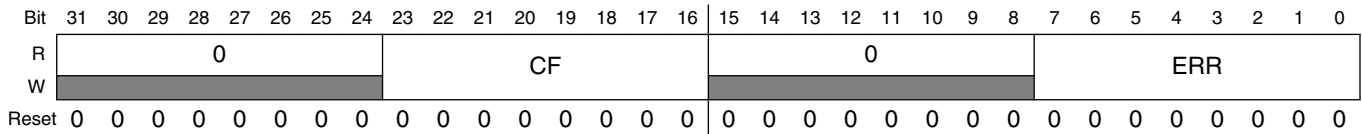

PDB_CHnS field descriptions

Field	Description
31–24 Reserved	This field is reserved. This read-only field is reserved and always has the value 0.
23–16 CF	PDB Channel Flags The CF[m] field is set when the PDB counter (PDB_CNT) matches the value CHnDLYm + 1. Write 0 to clear CF.
15–8 Reserved	This field is reserved. This read-only field is reserved and always has the value 0.
ERR	PDB Channel Sequence Error Flags Only the lower M bits are implemented in this MCU. 0 Sequence error not detected on PDB channel's corresponding pre-trigger. 1 Sequence error detected on PDB channel's corresponding pre-trigger. ADCn block can be triggered for a conversion by one pre-trigger from PDB channel n. When one conversion, which is triggered by one of the pre-triggers from PDB channel n, is in progress, new trigger from PDB channel's corresponding pre-trigger m cannot be accepted by ADCn, and ERR[m] is set. Writing 0's to clear the sequence error flags.

46.3.7 Channel n Delay 0 register (PDB_CHnDLY0)

Note: This register is internally buffered, and any values written to the register are written to its internal buffer instead; in other words, the internal device bus does not write directly to this register. The value in this register's internal buffer is loaded into this register only after "1" is written to the SC[LDOK] bit.

Address: 0h base + 18h offset + (40d × i), where i=0d to 3d

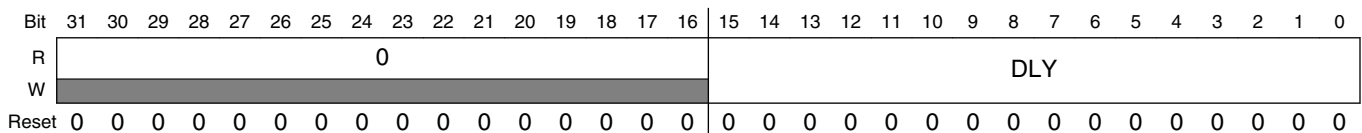

PDB_CHnDLY0 field descriptions

Field	Description
31–16 Reserved	This field is reserved. This read-only field is reserved and always has the value 0.
DLY	PDB Channel Delay These bits specify the delay value for the channel's corresponding pre-trigger. The pre-trigger asserts when the counter is equal to DLY. Reading these bits returns the value of internal register that is effective for the current PDB cycle.

46.3.8 Channel n Delay 1 register (PDB_CHnDLY1)

Note: This register is internally buffered, and any values written to the register are written to its internal buffer instead; in other words, the internal device bus does not write directly to this register. The value in this register's internal buffer is loaded into this register only after "1" is written to the SC[LDOK] bit.

Address: 0h base + 1Ch offset + (40d × i), where i=0d to 3d

Bit	31	30	29	28	27	26	25	24	23	22	21	20	19	18	17	16	15	14	13	12	11	10	9	8	7	6	5	4	3	2	1	0
R	0																DLY															
W	0																0															
Reset	0	0	0	0	0	0	0	0	0	0	0	0	0	0	0	0	0	0	0	0	0	0	0	0	0	0	0	0	0	0	0	0

PDB_CHnDLY1 field descriptions

Field	Description
31–16 Reserved	This field is reserved. This read-only field is reserved and always has the value 0.
DLY	PDB Channel Delay These bits specify the delay value for the channel's corresponding pre-trigger. The pre-trigger asserts when the counter is equal to DLY. Reading these bits returns the value of internal register that is effective for the current PDB cycle.

46.3.9 Channel n Delay 2 register (PDB_CHnDLY2)

Note: This register is internally buffered, and any values written to the register are written to its internal buffer instead; in other words, the internal device bus does not write directly to this register. The value in this register's internal buffer is loaded into this register only after "1" is written to the SC[LDOK] bit.

Address: 0h base + 20h offset + (40d × i), where i=0d to 3d

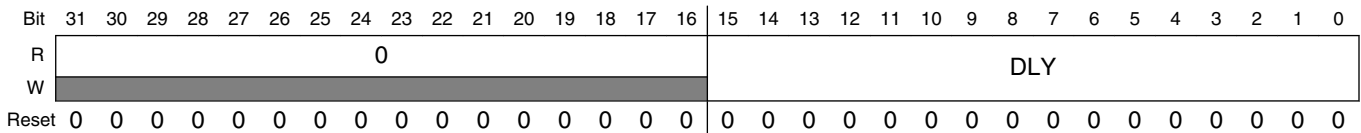

PDB_CHnDLY2 field descriptions

Field	Description
31–16 Reserved	This field is reserved. This read-only field is reserved and always has the value 0.
DLY	PDB Channel Delay These bits specify the delay value for the channel's corresponding pre-trigger. The pre-trigger asserts when the counter is equal to DLY. Reading these bits returns the value of internal register that is effective for the current PDB cycle.

46.3.10 Channel n Delay 3 register (PDB_CHnDLY3)

Note: This register is internally buffered, and any values written to the register are written to its internal buffer instead; in other words, the internal device bus does not write directly to this register. The value in this register's internal buffer is loaded into this register only after "1" is written to the SC[LDOK] bit.

Address: 0h base + 24h offset + (40d × i), where i=0d to 3d

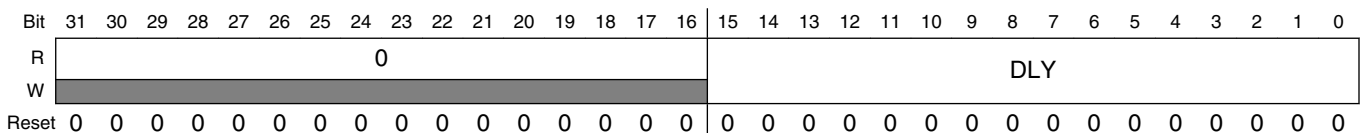

PDB_CHnDLY3 field descriptions

Field	Description
31–16 Reserved	This field is reserved. This read-only field is reserved and always has the value 0.
DLY	PDB Channel Delay These bits specify the delay value for the channel's corresponding pre-trigger. The pre-trigger asserts when the counter is equal to DLY. Reading these bits returns the value of internal register that is effective for the current PDB cycle.

46.3.11 Channel n Delay 4 register (PDB_CHnDLY4)

Note: This register is internally buffered, and any values written to the register are written to its internal buffer instead; in other words, the internal device bus does not write directly to this register. The value in this register's internal buffer is loaded into this register only after "1" is written to the SC[LDOK] bit.

Address: 0h base + 28h offset + (40d × i), where i=0d to 3d

Bit	31	30	29	28	27	26	25	24	23	22	21	20	19	18	17	16	15	14	13	12	11	10	9	8	7	6	5	4	3	2	1	0
R	0																DLY															
W	0																0															
Reset	0	0	0	0	0	0	0	0	0	0	0	0	0	0	0	0	0	0	0	0	0	0	0	0	0	0	0	0	0	0	0	0

PDB_CHnDLY4 field descriptions

Field	Description
31–16 Reserved	This field is reserved. This read-only field is reserved and always has the value 0.
DLY	PDB Channel Delay These bits specify the delay value for the channel's corresponding pre-trigger. The pre-trigger asserts when the counter is equal to DLY. Reading these bits returns the value of internal register that is effective for the current PDB cycle.

46.3.12 Channel n Delay 5 register (PDB_CHnDLY5)

Note: This register is internally buffered, and any values written to the register are written to its internal buffer instead; in other words, the internal device bus does not write directly to this register. The value in this register's internal buffer is loaded into this register only after "1" is written to the SC[LDOK] bit.

Address: 0h base + 2Ch offset + (40d × i), where i=0d to 3d

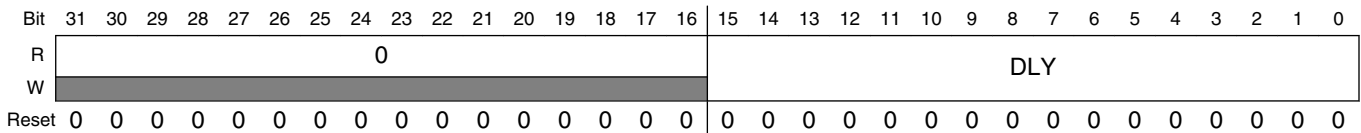

PDB_CHnDLY5 field descriptions

Field	Description
31–16 Reserved	This field is reserved. This read-only field is reserved and always has the value 0.
DLY	PDB Channel Delay These bits specify the delay value for the channel's corresponding pre-trigger. The pre-trigger asserts when the counter is equal to DLY. Reading these bits returns the value of internal register that is effective for the current PDB cycle.

46.3.13 Channel n Delay 6 register (PDB_CHnDLY6)

Note: This register is internally buffered, and any values written to the register are written to its internal buffer instead; in other words, the internal device bus does not write directly to this register. The value in this register's internal buffer is loaded into this register only after "1" is written to the SC[LDOK] bit.

Address: 0h base + 30h offset + (40d × i), where i=0d to 3d

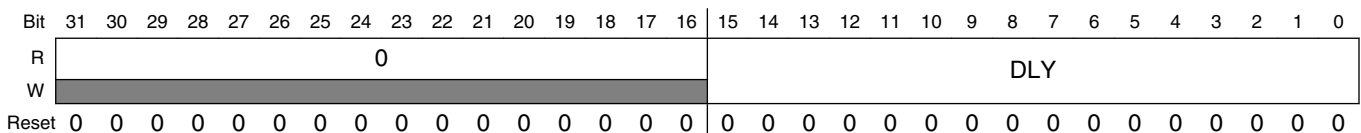

PDB_CHnDLY6 field descriptions

Field	Description
31–16 Reserved	This field is reserved. This read-only field is reserved and always has the value 0.
DLY	PDB Channel Delay These bits specify the delay value for the channel's corresponding pre-trigger. The pre-trigger asserts when the counter is equal to DLY. Reading these bits returns the value of internal register that is effective for the current PDB cycle.

46.3.14 Channel n Delay 7 register (PDB_CHnDLY7)

Note: This register is internally buffered, and any values written to the register are written to its internal buffer instead; in other words, the internal device bus does not write directly to this register. The value in this register's internal buffer is loaded into this register only after "1" is written to the SC[LDOK] bit.

Address: 0h base + 34h offset + (40d × i), where i=0d to 3d

Bit	31	30	29	28	27	26	25	24	23	22	21	20	19	18	17	16	15	14	13	12	11	10	9	8	7	6	5	4	3	2	1	0
R	0																DLY															
W	0																0															
Reset	0	0	0	0	0	0	0	0	0	0	0	0	0	0	0	0	0	0	0	0	0	0	0	0	0	0	0	0	0	0	0	0

PDB_CHnDLY7 field descriptions

Field	Description
31–16 Reserved	This field is reserved. This read-only field is reserved and always has the value 0.
DLY	PDB Channel Delay These bits specify the delay value for the channel's corresponding pre-trigger. The pre-trigger asserts when the counter is equal to DLY. Reading these bits returns the value of internal register that is effective for the current PDB cycle.

46.3.15 Pulse-Out n Enable register (PDB_POEN)

Address: 0h base + 190h offset = 190h

Bit	31	30	29	28	27	26	25	24	23	22	21	20	19	18	17	16	15	14	13	12	11	10	9	8	7	6	5	4	3	2	1	0
R	0																POEN															
W	0																0															
Reset	0	0	0	0	0	0	0	0	0	0	0	0	0	0	0	0	0	0	0	0	0	0	0	0	0	0	0	0	0	0	0	0

PDB_POEN field descriptions

Field	Description
31–8 Reserved	This field is reserved. This read-only field is reserved and always has the value 0.
POEN	PDB Pulse-Out Enable Enables the pulse output. Only lower 8 bits are implemented in this MCU. 0 PDB Pulse-Out disabled 1 PDB Pulse-Out enabled

46.3.16 Pulse-Out n Delay register (PDB_POnDLY)

Note: This register is internally buffered, and any values written to the register are written to its internal buffer instead; in other words, the internal device bus does not write directly to this register. The value in this register's internal buffer is loaded into this register only after "1" is written to the SC[LDOK] bit.

Address: 0h base + 194h offset + (4d × i), where i=0d to 0d

Bit	31	30	29	28	27	26	25	24	23	22	21	20	19	18	17	16	15	14	13	12	11	10	9	8	7	6	5	4	3	2	1	0
R																																
W	DLY1																DLY2															
Reset	0	0	0	0	0	0	0	0	0	0	0	0	0	0	0	0	0	0	0	0	0	0	0	0	0	0	0	0	0	0	0	0

PDB_POnDLY field descriptions

Field	Description
31–16 DLY1	PDB Pulse-Out Delay 1 These bits specify the delay 1 value for the PDB Pulse-Out. Pulse-Out goes high when the PDB counter is equal to the DLY1. Reading these bits returns the value of internal register that is effective for the current PDB cycle.
DLY2	PDB Pulse-Out Delay 2 These bits specify the delay 2 value for the PDB Pulse-Out. Pulse-Out goes low when the PDB counter is equal to the DLY2. Reading these bits returns the value of internal register that is effective for the current PDB cycle.

46.4 Functional description

46.4.1 PDB pre-trigger and trigger outputs

The PDB contains a counter whose output is compared to several different digital values. If the PDB is enabled, then a trigger input event will reset the counter and make it start to count. A trigger input event is defined as a rising edge being detected on a selected trigger input source, or if a software trigger is selected and the Software Trigger bit (SC[SWTRIG]) is written with 1. For each channel, a delay m determines the time between assertion of the trigger input event to the time at which changes in the pre-trigger m output signal are started. The time is defined as:

- Trigger input event to pre-trigger $m = (\text{prescaler} \times \text{multiplication factor} \times \text{delay } m) + 2$ peripheral clock cycles
- Add 1 additional peripheral clock cycle to determine the time when the channel trigger output changes.

Each channel is associated with 1 ADC block. PDB channel n pre-trigger outputs 0 to M ; each pre-trigger output is connected to ADC hardware trigger select and hardware trigger inputs. The pre-triggers are used to precondition the ADC block before the actual trigger occurs. When the ADC receives the rising edge of the trigger, the ADC will start the conversion according to the precondition determined by the pre-triggers. The ADC contains M sets of configuration and result registers, allowing it to alternate conversions between M different analog sources (like a ping-pong game). The pre-trigger outputs are used to specify which signal will be sampled next. When a pre-trigger m is asserted, the ADC conversion is triggered with set m of the configuration and result registers.

The waveforms shown in the following diagram show the pre-trigger and trigger outputs of PDB channel n . The delays can be independently set using the channel delay registers (CH n DLY m), and the pre-triggers can be enabled or disabled using the PDB Channel Pre-Trigger Enables (CH n C1[EN[m]]).

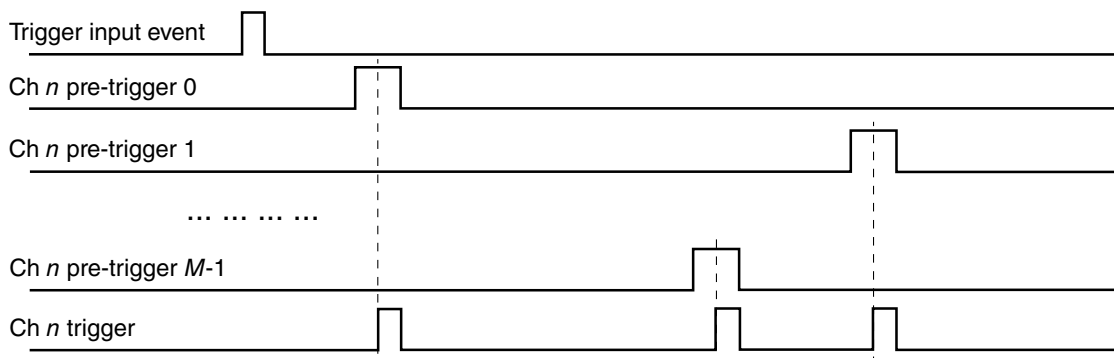

Figure 46-8. Pre-trigger and trigger outputs

The delay in the channel delay register ($CHnDLYm$) can be optionally bypassed, if the PDB Channel Pre-Trigger Output Select ($CHnC1[TOS[m]]$) is cleared. In this case, when the trigger input event occurs, the pre-trigger m is asserted after 2 peripheral clock cycles.

The PDB can be configured for back-to-back operation. Back-to-back operation enables the ADC conversion completions to trigger the next PDB channel pre-trigger and trigger outputs, so that the ADC conversions can be triggered on the next set of configuration and results registers. When back-to-back operation is enabled by setting the PDB Channel Pre-Trigger Back-to-Back Operation Enable ($CHnC1[BB[m]]$), then the delay m is ignored and the pre-trigger m is asserted 2 peripheral cycles after the acknowledgment m is received. The acknowledgment connections in this MCU are described in [Back-to-back acknowledgment connections](#).

When a pre-trigger from a PDB channel n is asserted, the associated lock of the pre-trigger becomes active. The associated lock is released by the rising edge of the corresponding $ADCnSC1[COCO]$; the $ADCnSC1[COCO]$ should be cleared after the conversion result is read, so that the next rising edge of $ADCnSC1[COCO]$ can be generated to clear the lock later. The lock becomes inactive when:

- the rising edge of corresponding $ADCnSC1[COCO]$ occurs,
- or the corresponding PDB pre-trigger is disabled,
- or the PDB is disabled

The channel n trigger output is suppressed when any of the locks of the pre-triggers in channel n is active.

- If a new pre-trigger m asserts when there is active lock in the PDB channel n , then a PDB Channel Sequence Error Flag ($CHnS[ERR[m]]$, associated with the pre-trigger m) is set. If the PDB Sequence Error Interrupt Enable ($SC[PDBEIE]$) is set, then the sequence error interrupt is generated. A sequence error typically happens because the delay m is set too short and the pre-trigger m asserts before the previously triggered ADC conversion finishes.
- If the pre-trigger delay is 0 cycles, then both channels will flag a PDB channel sequence error and ADC will not perform a conversion.

The PDB reports PDB channel sequence errors only for pre-triggers in same PDB channel. For situations when PDB triggering is done through different PDB channels, software must ensure sufficient delays in between the pre-triggers.

When the PDB counter reaches the value ($CNT + 1$), the PDB Interrupt Flag ($SC[PDBIF]$) is set. A PDB interrupt can be generated if the PDB Sequence Error Interrupt Enable ($SC[PDBEIE]$) is set and the DMA Enable ($SC[DMAEN]$) is cleared. If the DMA Enable ($SC[DMAEN]$) is set, then the PDB requests a DMA transfer when the PDB Interrupt Flag ($SC[PDBIF]$) is set.

The modulus value in the Modulus register (MOD) is used to reset the counter back to zero at the end of the count. If the Continuous Mode Enable (SC[CONT]) is set, then the counter will then resume a new count; otherwise, the counter operation will stop until the next trigger input event occurs.

46.4.2 PDB trigger input source selection

The PDB has up to 3 trigger input sources: software trigger, internal trigger, external trigger (via a pin). They are connected to on-chip or off-chip event sources. The PDB can be triggered by software through SC[SWTRIG].

For the trigger input sources implemented in this MCU, see chip configuration information.

46.4.3 Pulse-Out's

PDB can generate pulse outputs of configurable width.

- When the PDB counter reaches the value set in POyDLY[DLY1], then the Pulse-Out goes high.
- When the PDB counter reaches POyDLY[DLY2], then it goes low.

POyDLY[DLY2] can be set either greater or less than POyDLY[DLY1].

ADC pre-trigger/trigger outputs and Pulse-Out generation have the same time base, because they both share the PDB counter. The pulse-out connections implemented in this MCU are described in the device's chip configuration details.

Pulse-Out generation with $DLY2 > DLY1$

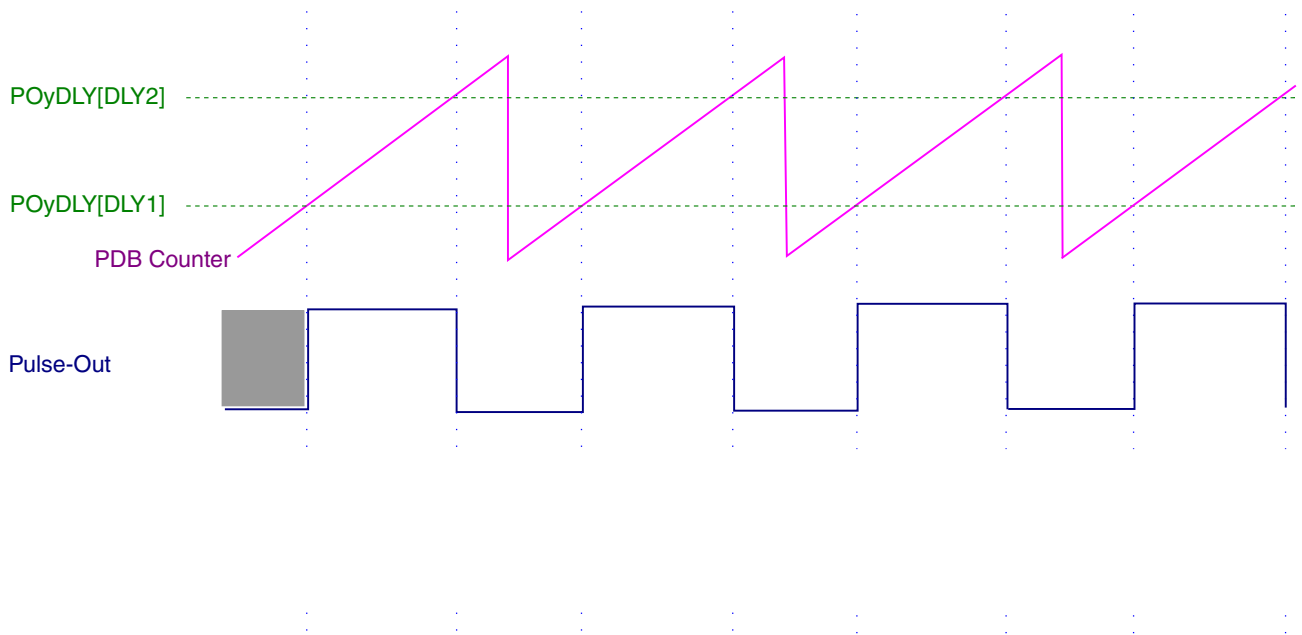

Pulse-Out generation with $DLY1 > DLY2$

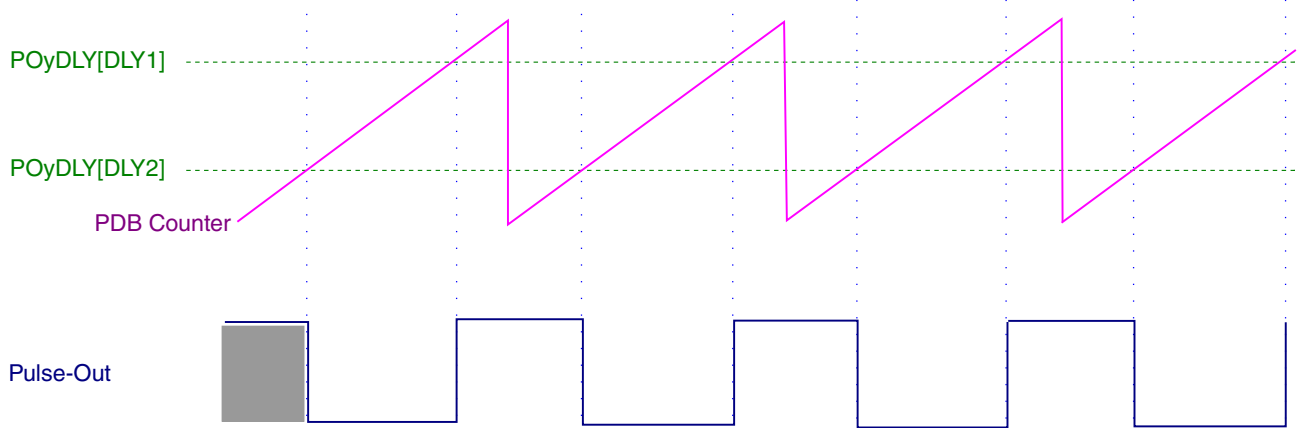

Figure 46-9. How Pulse Out is generated

46.4.4 Updating the delay registers

The following registers control the timing of the PDB operation; and in some of the applications, they may need to become effective at the same time.

- PDB Modulus register (MOD)
- PDB Interrupt Delay register (IDLY)

- PDB Channel n Delay m register ($CHnDLYm$)
- PDB Pulse-Out y Delay register ($POyDLY$)

The internal registers of them are buffered and any values written to them are written first to their buffers. The circumstances that cause their internal registers to be updated with the values from the buffers are summarized in the next table.

Table 46-9. When delay registers are updated

SC[LDMOD]	Update to the delay registers
00	The internal registers are loaded with the values from their buffers immediately after 1 is written to SC[LDOK].
01	The PDB counter reaches PDB_MOD[MOD] + 1 value, after 1 is written to SC[LDOK].
10	A trigger input event is detected after 1 is written to SC[LDOK].
11	Either the PDB counter reaches PDB_MOD[MOD] + 1 value or a trigger input event is detected, after 1 is written to SC[LDOK].

After 1 is written to SC[LDOK], the buffers cannot be written until the values in buffers are loaded into their internal registers. SC[LDOK] is self-cleared when the internal registers are loaded, so the application code can read it to determine the updates to the internal registers.

The following diagrams show the cases of the internal registers being updated with SC[LDMOD] is 00 and x1.

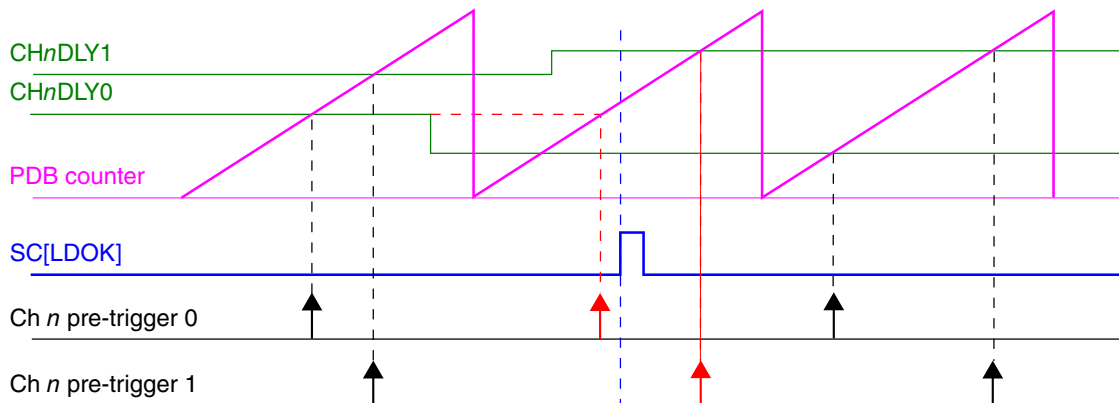

Figure 46-10. Registers update with SC[LDMOD] = 00

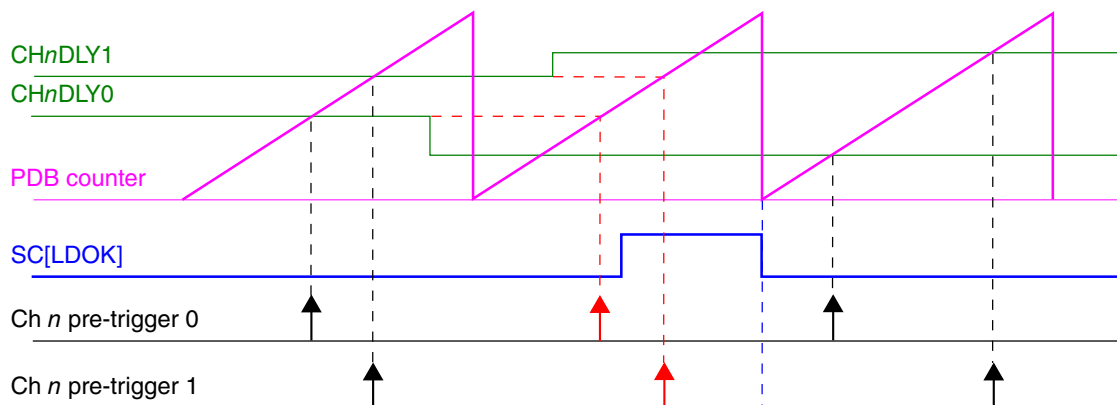

Figure 46-11. Registers update with SC[LDMOD] = x1

46.4.5 Interrupts

PDB can generate two interrupts: PDB interrupt and PDB sequence error interrupt. The following table summarizes the interrupts.

Table 46-10. PDB interrupt summary

Interrupt	Flags	Enable bit
PDB Interrupt	SC[PDBIF]	SC[PDBIE] = 1 and SC[DMAEN] = 0
PDB Sequence Error Interrupt	CHnS[ERRm]	SC[PDBEIE] = 1

46.4.6 DMA

If SC[DMAEN] is set, PDB can generate a DMA transfer request when SC[PDBIF] is set. When DMA is enabled, the PDB interrupt is not issued.

46.5 Application information

46.5.1 Impact of using the prescaler and multiplication factor on timing resolution

Use of prescaler and multiplication factor greater than 1 limits the count/delay accuracy in terms of peripheral clock cycles (to the modulus of the prescaler X multiplication factor). If the multiplication factor is set to 1 and the prescaler is set to 2 then the only values of total peripheral clocks that can be detected are even values; if prescaler is set to 4 then the only values of total peripheral clocks that can be decoded as detected are mod(4) and so forth. If the applications need a really long delay value and use a prescaler set to 128, then the resolution would be limited to 128 peripheral clock cycles.

Therefore, use the lowest possible prescaler and multiplication factor for a given application.

Chapter 47

FlexTimer Module (FTM)

47.1 Chip-specific FTM information

47.1.1 Instantiation Information

The following table lists the FTM instances each chip in the product series and summarizes features that vary across the products and instances.

Table 47-1. FTM instances and features

Chips	Instances	Channels	Fault inputs	FTM modulation	Quadrature Decoder	Hall sensor support	Dithering
S32K116	FTM0	8	1	Yes	No	No	No
	FTM1	8	3	No	Yes	No	Yes
S32K118	FTM0	8	4	Yes	No	No	No
	FTM1	8	4	No	Yes	No	Yes
S32K142	FTM0	8	4	Yes	No	No	No
	FTM1	8	4	No	Yes	Yes	Yes
	FTM2	8	4	No	Yes	Yes	Yes
	FTM3	8	4	Yes	No	No	No
S32K144	FTM0	8	4	Yes	No	No	No
	FTM1	8	4	No	Yes	Yes	No
	FTM2	8	4	No	Yes	Yes	No
	FTM3	8	4	Yes	No	No	No
S32K144W	FTM0	8	4	Yes	No	No	No
	FTM1	8	4	No	Yes	Yes	Yes
	FTM2	8	4	No	Yes	Yes	Yes
	FTM3	8	4	Yes	No	No	No
S32K146	FTM0	8	4	Yes	No	No	No
	FTM1	8	4	No	Yes	Yes	Yes
	FTM2	8	4	No	Yes	Yes	Yes
	FTM3	8	4	Yes	No	No	No

Table continues on the next page...

Table 47-1. FTM instances and features (continued)

Chips	Instances	Channels	Fault inputs	FTM modulation	Quadrature Decoder	Hall sensor support	Dithering
	FTM4	8	2	No	No	No	No
	FTM5	8	2	No	No	No	No
S32K148	FTM0	8	4	Yes	No	No	No
	FTM1	8	4	No	Yes	Yes	Yes
	FTM2	8	4	No	Yes	Yes	Yes
	FTM3	8	4	Yes	No	No	No
	FTM4	8	2	No	No	No	No
	FTM5	8	2	No	No	No	No
	FTM6	8	2	No	No	No	No
	FTM7	8	2	No	No	No	No

NOTE

Not all the registers shown in memory map of FTM are implemented in each variant/instance of S32K14x. See the above table for available features and hence the register implementation.

For all products in the series, all FTM instances have these features:

- Global time base
- Filters on input channel
- Filter on fault channel
- Half cycle reload
- Separate deadtime on channel pairs

FTM global load enable is implemented through SIM_FTMOPT1[FTMGLDOK]. Refer to [Global Load](#) and SIM_FTMOPT1[FTMGLDOK].

Wait mode is not supported on this device. See [Module operation in available power modes](#) for details on available power modes.

47.1.2 FTM Interrupts

The FlexTimer has multiple sources of interrupt. Refer to the DMA_Interrupt_mapping.xlsm attached with this Reference Manual. When an FTM interrupt occurs, read the FTM status registers (FMS, SC, and STATUS) to determine the exact interrupt source.

47.1.3 FTM Fault Detection Inputs

The following fault detection input options for the FTM modules are selected via the SIM_FTMOPT0 register. The external pin option is selected by default.

- FTM0 FAULT0 = FTM0_FLT0 pin or TRGMUX output
- FTM0 FAULT1 = FTM0_FLT1 pin or TRGMUX output
- FTM0 FAULT2 = FTM0_FLT2 pin or TRGMUX output
- FTM0 FAULT3 = FTM0_FLT3 pin

- FTM1 FAULT0 = FTM1_FLT0 pin or TRGMUX output
- FTM1 FAULT1 = FTM1_FLT1 pin or TRGMUX output
- FTM1 FAULT2 = FTM1_FLT2 pin or TRGMUX output
- FTM1 FAULT3 = FTM1_FLT3 pin

- FTM2 FAULT0 = FTM2_FLT0 pin or TRGMUX output
- FTM2 FAULT1 = FTM2_FLT1 pin or TRGMUX output
- FTM2 FAULT2 = FTM2_FLT2 pin or TRGMUX output
- FTM2 FAULT3 = FTM2_FLT3 pin

- FTM3 FAULT0 = FTM3_FLT0 pin or TRGMUX output
- FTM3 FAULT1 = FTM3_FLT1 pin or TRGMUX output
- FTM3 FAULT2 = FTM3_FLT2 pin or TRGMUX output
- FTM3 FAULT3 = FTM3_FLT3 pin
- FTM4 FAULT0 = FTM4_FLT0 pin

- FTM4 FAULT1 = FTM4_FLT1 pin

- FTM5 FAULT0 = FTM5_FLT0 pin

- FTM5 FAULT1 = FTM5_FLT1 pin

- FTM6 FAULT0 = FTM6_FLT0 pin

- FTM6 FAULT1 = FTM6_FLT1 pin

- FTM7 FAULT0 = FTM7_FLT0 pin

- FTM7 FAULT1 = FTM7_FLT1 pin

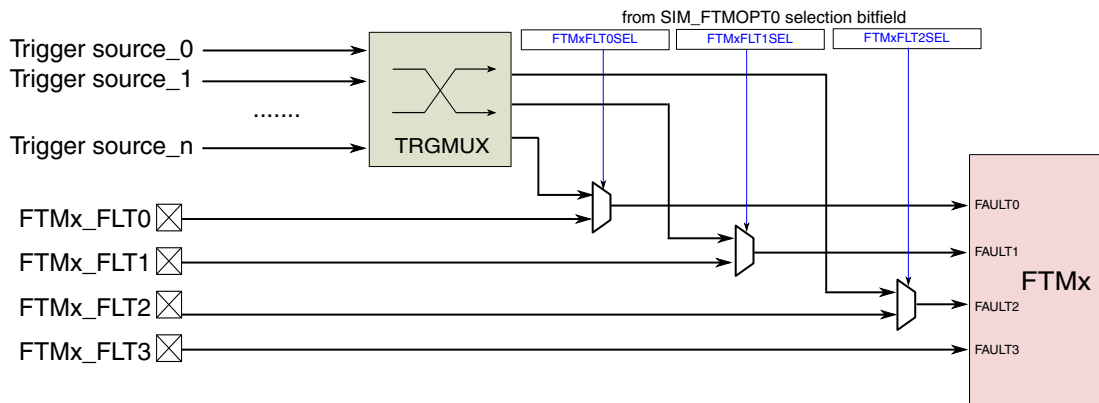

Figure 47-1. Fault detection inputs

47.1.4 FTM Hardware Triggers and Synchronization

The FlexTimer support external hardware trigger input which can be used for timer dynamic synchronization between multiple FlexTimers or counter reset. The FlexTimer hardware trigger are implemented as following.

FTM0:

- FTM0 hardware trigger 0 = TRGMUX trigger output
- FTM0 hardware trigger 1 = SIM_FTMOPT1[FTM0SYNCSBIT]
- FTM0 hardware trigger 2 = FTM0_FLT0 pin

FTM1:

- FTM1 hardware trigger 0 = TRGMUX trigger output
- FTM1 hardware trigger 1 = SIM_FTMOPT1[FTM1SYNCSBIT]
- FTM1 hardware trigger 2 = FTM1_FLT0 pin

FTM2:

- FTM2 hardware trigger 0 = TRGMUX trigger output
- FTM2 hardware trigger 1 = SIM_FTMOPT1[FTM2SYNCSBIT]
- FTM2 hardware trigger 2 = FTM2_FLT0 pin

FTM3:

- FTM3 hardware trigger 0 = TRGMUX trigger output
- FTM3 hardware trigger 1 = SIM_FTMOPT1[FTM3SYNCSBIT]
- FTM3 hardware trigger 2 = FTM3_FLT0 pin

FTM4

- FTM4 hardware trigger 0 = TRGMUX trigger output
- FTM4 hardware trigger 1 = SIM_FTMOPT1[FTM4SYNCSBIT]
- FTM4 hardware trigger 2 = FTM4_FLT0 pin

FTM5

- FTM5 hardware trigger 0 = TRGMUX trigger output
- FTM5 hardware trigger 1 = SIM_FTMOPT1[FTM5SYNCSBIT]
- FTM5 hardware trigger 2 = FTM5_FLT0 pin

FTM6

- FTM6 hardware trigger 0 = TRGMUX trigger output
- FTM6 hardware trigger 1 = SIM_FTMOPT1[FTM6SYNCSBIT]
- FTM6 hardware trigger 2 = FTM6_FLT0 pin

FTM7

- FTM7 hardware trigger 0 = TRGMUX trigger output
- FTM7 hardware trigger 1 = SIM_FTMOPT1[FTM7SYNCSBIT]
- FTM7 hardware trigger 2 = FTM7_FLT0 pin

The hardware trigger source can be from many other modules via TRGMUX, like LPIT, Low Power Timer, CMP, etc. It also supports FlexTimer's self trigger outputs, ex: counter initialization trigger (init_trig) and channel match trigger (ext_trig), through the flexible TRGMUX module.

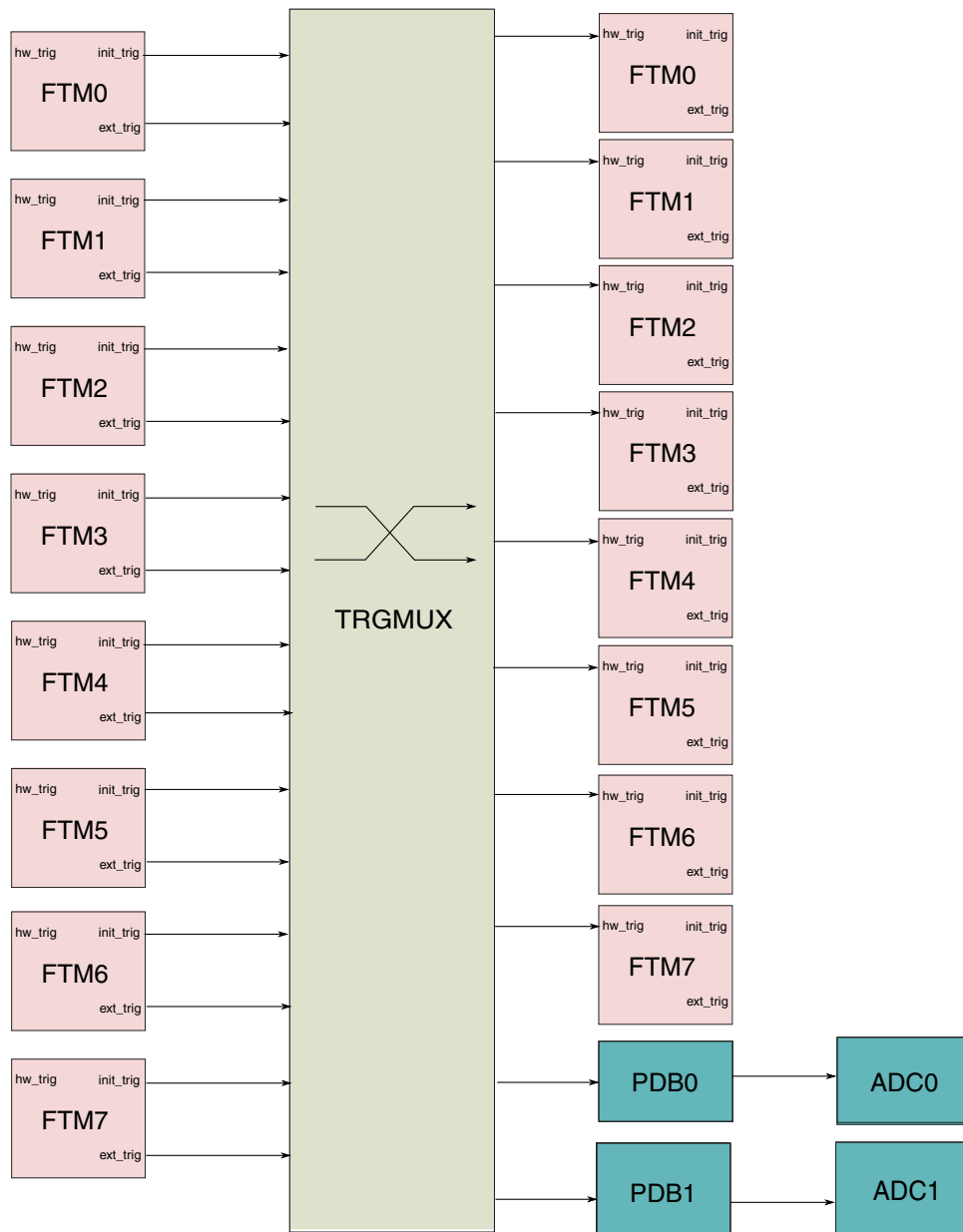

Figure 47-2. Hardware triggers

The FlexTimer trigger outputs are also usually used as trigger source by other modules, for example, the above diagram shows a case of triggering PDB and ADC. See [Instantiation Information](#) and TRGMUX connectivity [Module interconnectivity](#) for details.

47.1.5 FTM Input Capture Options

The following channel 0 input capture source options are selected via SIM_FTMOPT1. The external pin option is selected by default.

- FTM1 channel 0 input capture = FTM1_CH0 pin or CMP0 output
- FTM2 channel 0 input capture = FTM2_CH0 pin or CMP0 output
- FTM2 channel 1 input capture = FTM2_CH1 pin or exclusive OR of FTM2_CH0, FTM2_CH1, and FTM1_CH1. See [FTM Hall sensor support](#).

47.1.6 FTM Hall sensor support

For 3 phase motor control sensor-ed applications the use of Hall sensors, generally 3 sensors placed 120 degrees apart around the rotor, are deployed to detect position and speed. Each of the 3 sensors provides a pulse that applied to an input capture pin, can then be analyzed and both speed and position can be deduced. To simplify the calculations required by the CPU on each hall sensor's input, if all 3 inputs are "exclusively OR'd" into one timer channel and the free running counter is refreshed on every edge then this can simplify the speed calculation.

Via the SIM module and SIM_FTMOPT1 register the FTM2CH1SEL bit provides the choice of normal FTM2_CH1 input or the XOR of FTM2_CH0, FTM2_CH1 and FTM1_CH1 pins that will be applied to FTM2_CH1.

NOTE

If the user utilizes FTM1_CH1 to be an input to FTM2_CH1, FTM1_CH0 can still be utilized for other functions.

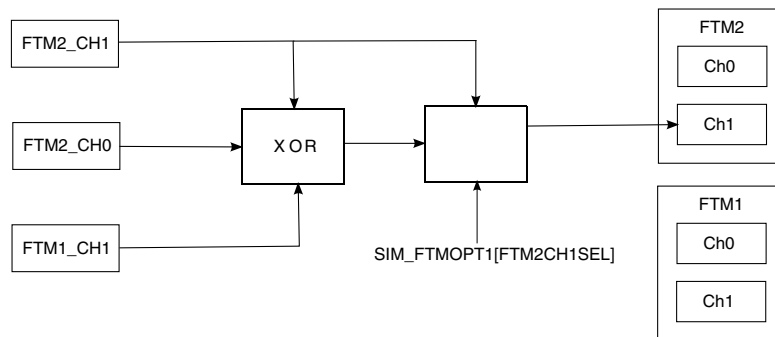

Figure 47-3. FTM Hall Sensor Configuration

47.1.7 FTM Modulation Implementation

FTM0 and FTM3 support a modulation function where the output channels when configured as PWM or Output Compare mode modulate another timer output when the channel signal is asserted. Any of the 8 channels of FTM0 and any of the 8 channels of FTM3 can be configured to support this modulation function.

The SIM_FTMOPT1 register has control bits (FTMxCHySEL) that allow the user to select normal PWM/Output Compare mode on the corresponding FTM timer channel or modulate with FTM1_CH1. The diagram below shows the implementation for FTM0. FTM3 has similar implementation controlled by SIM_FTMOPT1[FTM3CHySEL] on each of its 8 channels with modulation possible via FTM2_CH1. See [SIM](#) chapter for further information.

When FTM1_CH1 is used to modulate an FTM0 channel, then the user must configure FTM1_CH1 to provide a signal that has a higher frequency than the modulated FTM0 channel output. Also it limits the use of the FTM1_CH0 function, as the FTM1_CH1 will be programmed to provide a 50% duty PWM signal and limit the start and modulus values for the free running counter. FTM2 has a similar restriction when FTM2_CH1 is used for modulating an FTM3 channel.

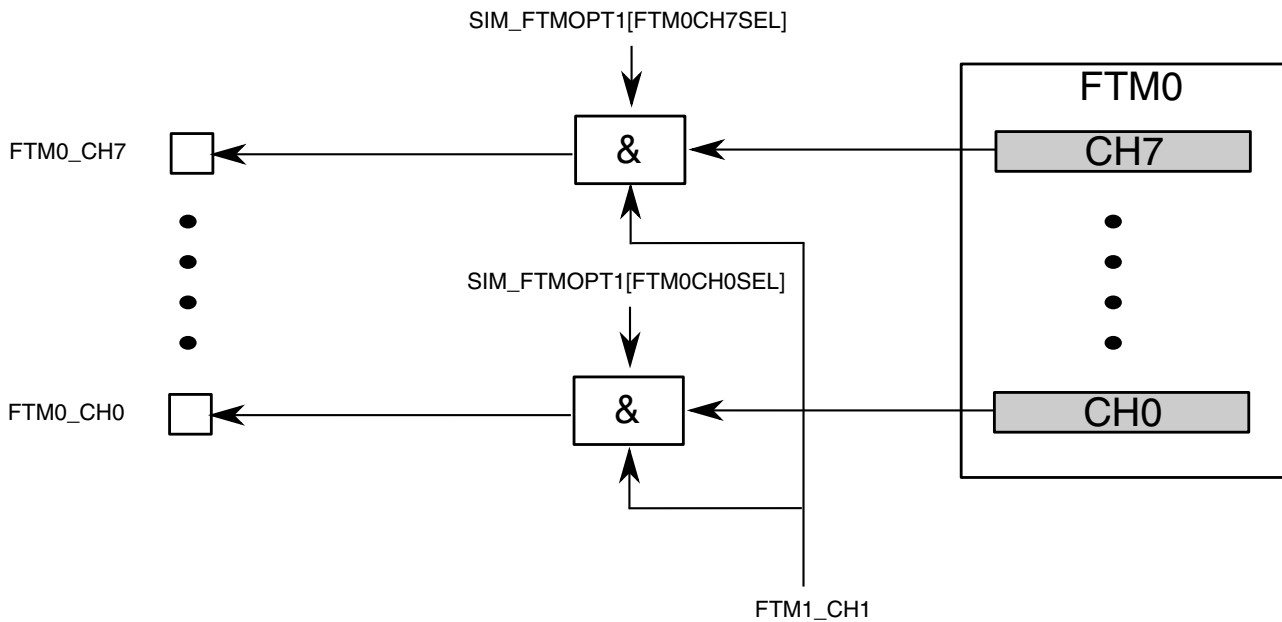

Figure 47-4. FTM Output Modulation

47.1.8 FTM Global Time Base

This chip provides the optional FTM global time base feature, see [Global time base \(GTB\)](#).

FTM supports global timer base through the GTB feature. Any of the FTM module could be used as the GTB_EN source. The global timer base only allows the FTM counters to start their operation synchronously, it does not automatically provide continuous synchronization of FTM counters, meaning that the FTM counters may lose synchronization during misc FTM operation.

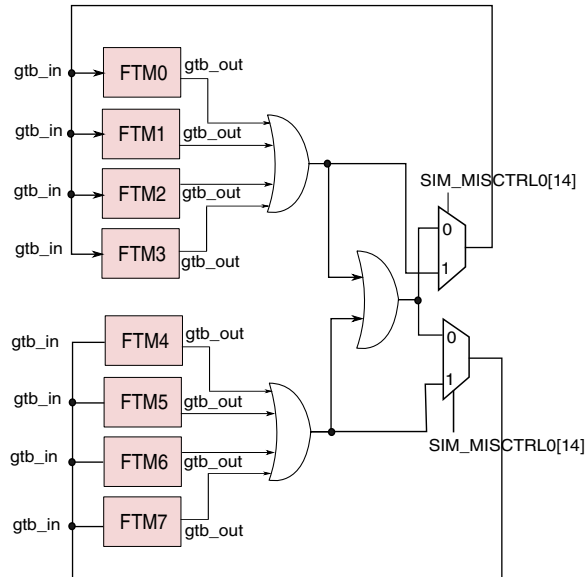

Figure 47-5. FTM global time base system interconnection

47.1.9 FTM BDM and debug halt mode

In the FTM chapter, references to the chip being in "BDM" are the same as the chip being in "debug halt mode".

47.1.9.1 FTM output channel state retention

This device supports optional state retention of FTM channel in case of no clock condition (CLKS=2'b00). See SIM_MISCTRL0[FTMx_OBE_CTRL] for enabling this feature.

47.1.10 FTM fixed frequency clock

This device requires that the input fixed frequency clock (mapped to RTC_CLK (shown in [Table 27-9](#)), should be restricted to 1/4th of the FTM System clock.

47.1.11 S32K11X to S32K14X difference

See [Differences between S32K14x/S32K14xW, and S32K11x](#), for differences arising out of CPU and interrupt latency impacting timed events when comparing S32K14X and S32K11X variants.

47.1.11.1 Filter differences in S32K14x, S32K14xW, and S32K11x devices

The following table shows the filter differences between S32K14x, S32K14xW, and S32K11x devices.

S32K14x			S32K11x and S32K14xW		
Operation in Input capture/dual edge capture/fault control/quadrature decoder modes with FLTSP[3:0] ≠ 0					
<p>In S32K14x, there are two asymmetric stages (having undivided clock (FTM input clock) and divided prescaled clock (FTM filter clock)) in synchronization of the input.</p> 			<p>In S32K11x, there are three stages (one symmetric synchronization stage on undivided clock (FTM input clock) and one flop on divided prescaled clock (FTM filter clock)) in synchronization of the input.</p> 		
See Input Capture Mode for details.			See Input Capture Mode for details.		
Operation in Input capture/dual edge capture/fault control/quadrature decoder modes with FLTSP[3:0] = 0					
<p>In both S32K14x and S32K11x, there are two stages (FTM input clock and FTM filter clock. In this case (prescaler not used), FTM input clock and FTM filter clock are of same frequency) in synchronization of the input.</p> 			<p>In both S32K14x and S32K11x, there are two stages (FTM input clock and FTM filter clock. In this case, FTM input clock and FTM filter clock are of same frequency) in synchronization of the input.</p> 		
See Input Capture Mode for details.			See Input Capture Mode for details.		
FTM Channel Input Filter Delay					
FTM channel input filter	FLTSP[3:0] bits	Number of rising edges between the selected edge on channel input and setting CHF bit	FTM channel input filter	FLTSP[3:0] bits	Number of rising edges between the selected edge on channel input and setting CHF bit
• channel does not have the input filter, or	FLTSP[3:0] = 0	• 3 rising edges of FTM input clock	• channel does not have the input filter, or	FLTSP[3:0] = 0	• 3 rising edges of FTM input clock
• channel input filter is disabled (CHnFVAL[3:0] = 0)	FLTSP[3:0] ≠ 0	• 2 rising edges of FTM input clock, plus • 1 rising edge of FTM filter clock	• channel input filter is disabled (CHnFVAL[3:0] = 0)	FLTSP[3:0] ≠ 0	• 3 rising edges of FTM input clock, plus • 1 rising edge of FTM filter clock
• channel has the input filter, and • channel input filter is enabled (CHnFVAL[3:0] ≠ 0)	FLTSP[3:0] = 0	• (4 + 4 × CHnFVAL[3:0]) rising edges of FTM input clock	• channel has the input filter, and • channel input filter is enabled (CHnFVAL[3:0] ≠ 0)	FLTSP[3:0] = 0	• (4 + 4 × CHnFVAL[3:0]) rising edges of FTM input clock
	FLTSP[3:0] ≠ 0	• 3 rising edges of FTM input clock, plus • (1 + 4 × CHnFVAL[3:0]) rising edges of FTM filter clock		FLTSP[3:0] ≠ 0	• 4 rising edges of FTM input clock, plus • (1 + 4 × CHnFVAL[3:0]) rising edges of FTM filter clock
See Table 47-7 for details.			See Table 47-7 for details.		
FTM Fault Input Filter Delay					

Table continues on the next page...

S32K14x			S32K11x and S32K14xW		
FTM fault input filter	FLTPS[3:0] bits	Number of rising edges between the selected edge on fault input and forcing the channels outputs to their safe values	FTM fault input filter	FLTPS[3:0] bits	Number of rising edges between the selected edge on fault input and forcing the channels outputs to their safe values
<ul style="list-style-type: none"> fault input does not have the input filter, or fault input filter is disabled (FFLTRnEN = 0 or FFVAL[3:0] = 0) 	FLTPS[3:0] = 0	<ul style="list-style-type: none"> 3 rising edges of FTM input clock 	<ul style="list-style-type: none"> fault input does not have the input filter, or fault input filter is disabled (FFLTRnEN = 0 or FFVAL[3:0] = 0) 	FLTPS[3:0] = 0	<ul style="list-style-type: none"> 3 rising edges of FTM input clock
	FLTPS[3:0] ≠ 0	<ul style="list-style-type: none"> 2 rising edges of FTM input clock, plus 1 rising edge of FTM filter clock 		FLTPS[3:0] ≠ 0	<ul style="list-style-type: none"> 3 rising edges of FTM input clock, plus 1 rising edge of FTM filter clock
<ul style="list-style-type: none"> fault input has the input filter, and fault input filter is enabled (FFLTRnEN = 1 and FFVAL[3:0] ≠ 0) 	FLTPS[3:0] = 0	<ul style="list-style-type: none"> (4 + FFVAL[3:0]) rising edges of FTM input clock 	<ul style="list-style-type: none"> fault input has the input filter, and fault input filter is enabled (FFLTRnEN = 1 and FFVAL[3:0] ≠ 0) 	FLTPS[3:0] = 0	<ul style="list-style-type: none"> (4 + FFVAL[3:0]) rising edges of FTM input clock
	FLTPS[3:0] ≠ 0	<ul style="list-style-type: none"> 3 rising edges of FTM input clock, plus (1 + FFVAL[3:0]) rising edges of FTM filter clock 		FLTPS[3:0] ≠ 0	<ul style="list-style-type: none"> 4 rising edges of FTM input clock, plus (1 + FFVAL[3:0]) rising edges of FTM filter clock
See Table 47-7 for details.			See Table 47-7 for details.		

NOTE

The corresponding sections refer to S32K11x implementation.
For S32K14x, see the differences listed in the table above.

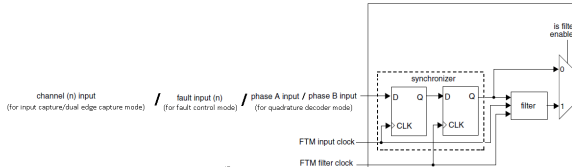
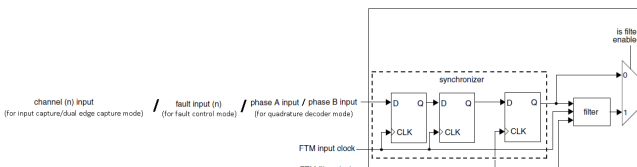
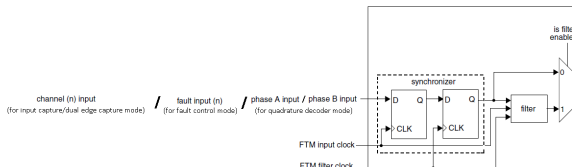
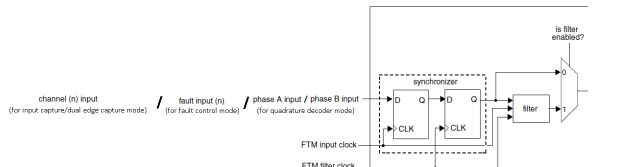
47.2 Introduction

The FlexTimer module (FTM) is a two-to-eight channel timer that supports input capture, output compare, and the generation of PWM signals to control electric motor and power management applications. The FTM time reference is a 16-bit counter that can be used as an unsigned or signed counter.

47.2.1 Features

The FTM features include:

- FTM source clock is selectable
 - Source clock can be the FTM input clock, the fixed frequency clock, or an external clock
 - Fixed frequency clock is an additional clock input to allow the selection of an on chip clock source other than the FTM input clock
 - Selecting external clock connects FTM clock to a chip level input pin therefore allowing to synchronize the FTM counter with an off chip clock source
- Prescaler divide-by 1, 2, 4, 8, 16, 32, 64, or 128
- 16-bit counter

- It can be a free-running counter or a counter with initial and final value
- The counting can be up or up-down
- Each channel can be configured for input capture, output compare, or edge-aligned PWM mode
- In Input Capture mode:
 - The capture can occur on rising edges, falling edges or both edges
 - An input filter can be selected for some channels. One unique prescaler is available for all filters
- In Output Compare mode the output signal can be set, cleared, or toggled on match
- All channels can be configured for center-aligned PWM mode
- Each pair of channels can be combined to generate a PWM signal with independent control of both edges of PWM signal
- The FTM channels can operate as pairs with equal outputs, pairs with complementary outputs, or independent channels with independent outputs
- The deadtime insertion is available for each complementary pair
- Generation of match triggers
- Software control of PWM outputs
- Up to 4 fault inputs for global fault control
- The polarity of each channel is configurable
- The generation of an interrupt per channel
- The generation of an interrupt when the counter overflows
- The generation of an interrupt when the fault condition is detected
- The generation of an interrupt when a register reload point occurs
- Synchronized loading of write buffered FTM registers
- Half cycle and Full cycle register reload capacity
- Write protection for critical registers
- Backwards compatible with TPM
- Testing of input capture mode

- Direct access to input pin states
- Dual edge capture for pulse and period width measurement
- Quadrature decoder with input filters, relative position counting, and interrupt on position count or capture of position count on external event
- The FTM channels can be selected to generate a trigger pulse on channel output instead of a PWM
- Dithering capability to simulate fine edge control for both PWM period or PWM duty cycle

47.2.2 Modes of operation

When the chip is in an active Debug mode, the FTM temporarily suspends all counting until the chip returns to normal user operating mode. During Stop mode, all FTM input clocks are stopped, so the FTM is effectively disabled until clocks resume. During Wait mode, the FTM continues to operate normally. If the FTM does not need to produce a real time reference or provide the interrupt sources needed to wake the chip from Wait mode, the power can then be saved by disabling FTM functions before entering Wait mode.

47.2.3 Block Diagram

The FTM uses one input/output (I/O) pin per channel, CH_n (FTM channel (n)) where n is the channel number (0–7).

NOTE

The number of channels supported can vary for each instance of the FTM module on a chip. See the chip-specific FTM information to see how many channels are supported for each module instance. For example, if a module instance supports only six channels, references to channel numbers 6 and 7 do not apply for that instance.

The following figure shows the FTM structure. The central component of the FTM is the 16-bit counter with programmable initial and final values and its counting can be up or up-down.

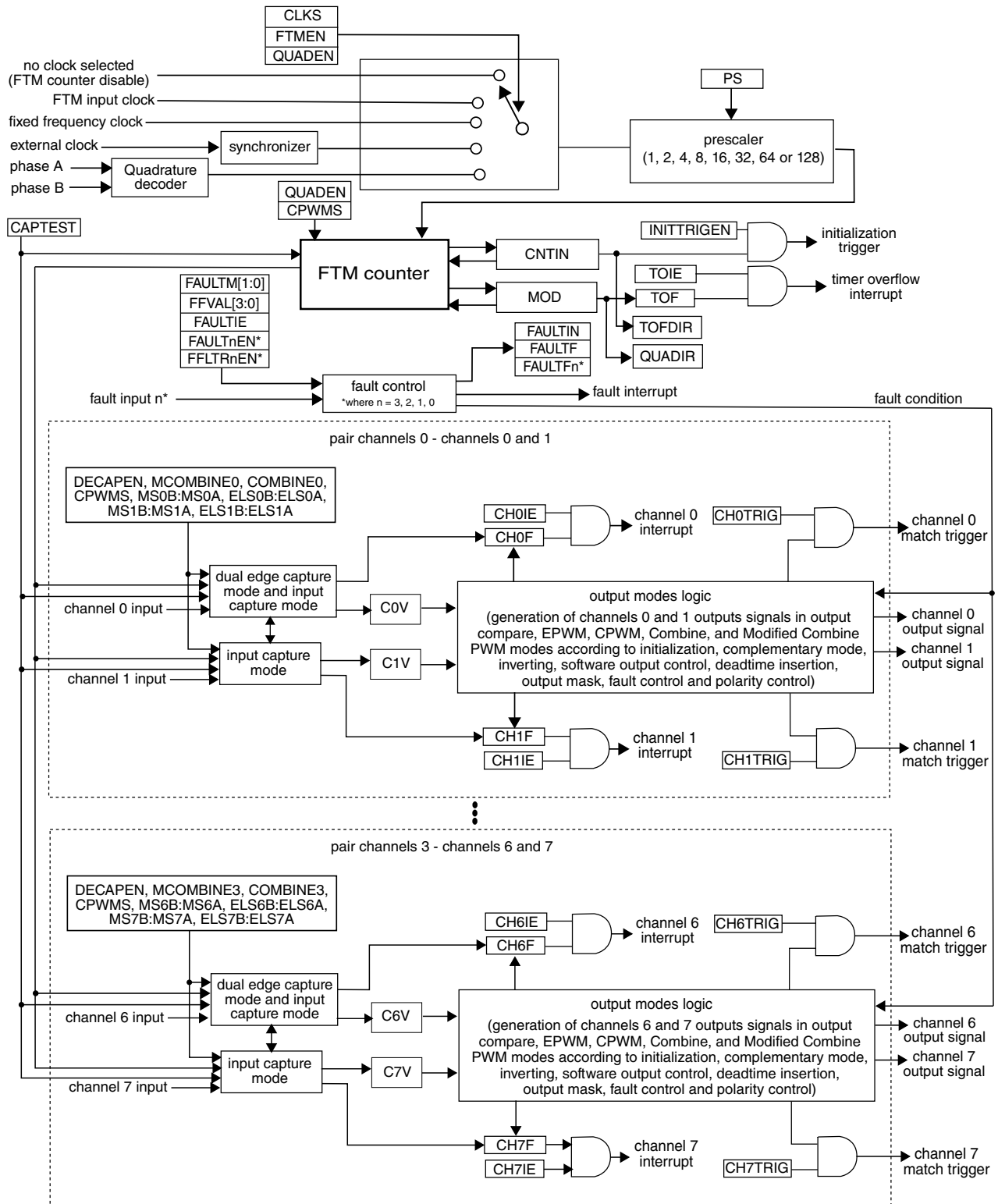

Figure 47-6. FTM Block Diagram

47.3 FTM signal descriptions

Table 47-2 shows the user-accessible signals for the FTM.

Table 47-2. FTM signal descriptions

Signal	Description	I/O	Function
EXTCLK	External clock. FTM external clock can be selected to drive the FTM counter.	I	The external clock input signal is used as the FTM counter clock if selected by CLKS[1:0] bits in the SC register. This clock signal must not exceed 1/4 of FTM input clock frequency. The FTM counter prescaler selection and settings are also used when an external clock is selected.
CHn	FTM channel (n), where n can be 7-0	I/O	Each FTM channel can be configured to operate either as input or output. The direction associated with each channel, input or output, is selected according to the mode assigned for that channel.
FAULTj	Fault input (j), where j can be 3-0	I	The fault input signals are used to control the CHn channel output state. If a fault is detected, the FAULTj signal is asserted and the channel output is put in a safe state. The behavior of the fault logic is defined by the FAULTM[1:0] control bits in the MODE register and FAULTEN bit in the COMBINE register. Note that each FAULTj input may affect all channels selectively since FAULTM[1:0] and FAULTEN control bits are defined for each pair of channels. Because there are several FAULTj inputs, maximum of 4 for the FTM module, each one of these inputs is activated by the FAULTJEN bit in the FLTCTRL register.
PHA	Quadrature decoder phase A input. Input pin associated with quadrature decoder phase A.	I	The quadrature decoder phase A input is used as the Quadrature Decoder mode is selected. The phase A input signal is one of the signals that control the FTM counter increment or decrement in the Quadrature Decoder Mode .
PHB	Quadrature decoder phase B input. Input pin associated with quadrature decoder phase B.	I	The quadrature decoder phase B input is used as the Quadrature Decoder mode is selected. The phase B input signal is one of the signals that control the FTM counter increment or decrement in the Quadrature Decoder Mode .

47.4 Memory map and register definition

47.4.1 Memory map

This section presents a high-level summary of the FTM registers and how they are mapped.

The registers and bits of an unavailable function in the FTM remain in the memory map and in the reset value, but they have no active function.

NOTE

The number of channels supported can vary for each instance of the FTM module on a chip. See the chip-specific FTM information to see how many channels are supported for each module instance.

47.4.2 Register descriptions

Accesses to reserved addresses result in transfer errors. Registers for absent channels are considered reserved. Double buffered register writes must be done using 32-bit operations.

47.4.3 FTM register descriptions**47.4.3.1 FTM memory map**

FTM0 base address: 4003_8000h

FTM1 base address: 4003_9000h

FTM2 base address: 4003_A000h

FTM3 base address: 4002_6000h

FTM4 base address: 4006_E000h

FTM5 base address: 4006_F000h

FTM6 base address: 4007_0000h

FTM7 base address: 4007_1000h

Offset	Register	Width (In bits)	Access	Reset value
0h	Status And Control (SC)	32	RW	0000_0000h
4h	Counter (CNT)	32	RW	0000_0000h
8h	Modulo (MOD)	32	RW	0000_0000h
Ch	Channel (n) Status And Control (C0SC)	32	RW	0000_0000h
10h	Channel (n) Value (C0V)	32	RW	0000_0000h
14h	Channel (n) Status And Control (C1SC)	32	RW	0000_0000h

Table continues on the next page...

Offset	Register	Width (In bits)	Access	Reset value
18h	Channel (n) Value (C1V)	32	RW	0000_0000h
1Ch	Channel (n) Status And Control (C2SC)	32	RW	0000_0000h
20h	Channel (n) Value (C2V)	32	RW	0000_0000h
24h	Channel (n) Status And Control (C3SC)	32	RW	0000_0000h
28h	Channel (n) Value (C3V)	32	RW	0000_0000h
2Ch	Channel (n) Status And Control (C4SC)	32	RW	0000_0000h
30h	Channel (n) Value (C4V)	32	RW	0000_0000h
34h	Channel (n) Status And Control (C5SC)	32	RW	0000_0000h
38h	Channel (n) Value (C5V)	32	RW	0000_0000h
3Ch	Channel (n) Status And Control (C6SC)	32	RW	0000_0000h
40h	Channel (n) Value (C6V)	32	RW	0000_0000h
44h	Channel (n) Status And Control (C7SC)	32	RW	0000_0000h
48h	Channel (n) Value (C7V)	32	RW	0000_0000h
4Ch	Counter Initial Value (CNTIN)	32	RW	0000_0000h
50h	Capture And Compare Status (STATUS)	32	RW	0000_0000h
54h	Features Mode Selection (MODE)	32	RW	0000_0004h
58h	Synchronization (SYNC)	32	RW	0000_0000h
5Ch	Initial State For Channels Output (OUTINIT)	32	RW	0000_0000h
60h	Output Mask (OUTMASK)	32	RW	0000_0000h
64h	Function For Linked Channels (COMBINE)	32	RW	0000_0000h
68h	Deadtime Configuration (DEADTIME)	32	RW	0000_0000h
6Ch	FTM External Trigger (EXTTRIG)	32	RW	0000_0000h
70h	Channels Polarity (POL)	32	RW	0000_0000h
74h	Fault Mode Status (FMS)	32	RW	0000_0000h
78h	Input Capture Filter Control (FILTER)	32	RW	0000_0000h
7Ch	Fault Control (FLTCTRL)	32	RW	0000_0000h
80h	Quadrature Decoder Control And Status (QDCTRL)	32	RW	0000_0000h
84h	Configuration (CONF)	32	RW	0000_0000h
88h	FTM Fault Input Polarity (FLTPOL)	32	RW	0000_0000h
8Ch	Synchronization Configuration (SYNCONF)	32	RW	0000_0000h
90h	FTM Inverting Control (INVCTRL)	32	RW	0000_0000h
94h	FTM Software Output Control (SWOCTRL)	32	RW	0000_0000h
98h	FTM PWM Load (PWMLOAD)	32	RW	0000_0000h
9Ch	Half Cycle Register (HCR)	32	RW	0000_0000h
A0h	Pair 0 Deadtime Configuration (PAIR0DEADTIME)	32	RW	0000_0000h
A8h	Pair 1 Deadtime Configuration (PAIR1DEADTIME)	32	RW	0000_0000h
B0h	Pair 2 Deadtime Configuration (PAIR2DEADTIME)	32	RW	0000_0000h
B8h	Pair 3 Deadtime Configuration (PAIR3DEADTIME)	32	RW	0000_0000h
200h	Mirror of Modulo Value (MOD_MIRROR)	32	RW	0000_0000h
204h - 220h	Mirror of Channel (n) Match Value (C0V_MIRROR - C7V_MIRROR)	32	RW	0000_0000h

47.4.3.2 Status And Control (SC)

47.4.3.2.1 Offset

Register	Offset
SC	0h

47.4.3.2.2 Function

SC contains the overflow status flag and control bits used to configure the interrupt enable, FTM configuration, clock source, filter prescaler, and prescaler factor.

This register also contains the output enable control bits and the reload opportunity flag control.

These controls relate to all channels within this module.

47.4.3.2.3 Diagram

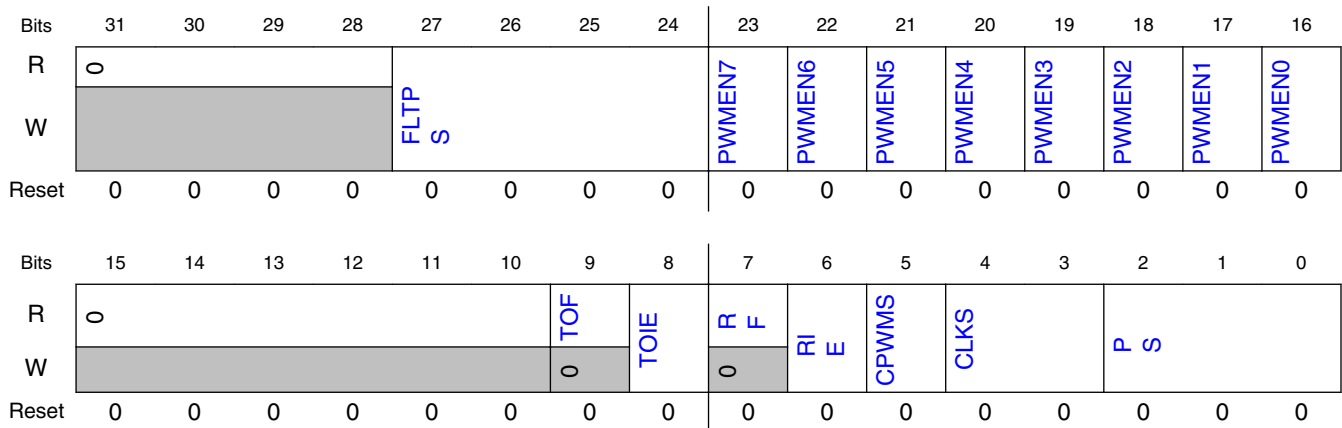

47.4.3.2.4 Fields

Field	Function
31-28	Reserved
—	
27-24	Filter Prescaler

Table continues on the next page...

Field	Function
FLTPS	<p>The bits FLTPS selects the clock prescaler used in the FTM filters:</p> <ul style="list-style-type: none"> channel input filters fault inputs filters quadrature decoder phase A and B inputs filters <p>Writing to the bits FLTPS has immediate effect.</p> <p>0000b - Divide by 1 0001b - Divide by 2 0010b - Divide by 3 0011b - Divide by 4 0100b - Divide by 5 0101b - Divide by 6 0110b - Divide by 7 0111b - Divide by 8 1000b - Divide by 9 1001b - Divide by 10 1010b - Divide by 11 1011b - Divide by 12 1100b - Divide by 13 1101b - Divide by 14 1110b - Divide by 15 1111b - Divide by 16</p>
23-16 PWMEFn	<p>Channel n PWM enable bit</p> <p>This bit enables the PWM channel output. This bit should be set to 0 (output disabled) when an input mode is used.</p> <p>0b - Channel output port is disabled. 1b - Channel output port is enabled.</p>
15-10 —	Reserved
9 TOF	<p>Timer Overflow Flag</p> <p>Set by hardware when the FTM counter passes the value in the MOD register. The TOF bit is cleared by reading the SC register while TOF is set and then writing a 0 to TOF bit. Writing a 1 to TOF has no effect.</p> <p>If another FTM overflow occurs between the read and write operations, the write operation has no effect; therefore, TOF remains set indicating an overflow has occurred. In this case, a TOF interrupt request is not lost due to the clearing sequence for a previous TOF.</p> <p>0b - FTM counter has not overflowed. 1b - FTM counter has overflowed.</p>
8 TOIE	<p>Timer Overflow Interrupt Enable</p> <p>Enables FTM overflow interrupts.</p> <p>0b - Disable TOF interrupts. Use software polling. 1b - Enable TOF interrupts. An interrupt is generated when TOF equals one.</p>
7 RF	<p>Reload Flag</p> <p>The RF bit is set at each selected reload point. See Reload Points.</p> <p>The RF bit is cleared by reading the SC register while RF is set and then writing a 0 to RF bit. Writing 1 to RF has no effect. If another selected reload point happens between the read and write operations, the write operation has no effect; therefore, RF remains set.</p> <p>0b - A selected reload point did not happen. 1b - A selected reload point happened.</p>
6	Reload Point Interrupt Enable

Table continues on the next page...

Memory map and register definition

Field	Function
RIE	Enables the reload point interrupt. 0b - Reload point interrupt is disabled. 1b - Reload point interrupt is enabled.
5 CPWMS	Center-Aligned PWM Select Selects CPWM mode. This mode configures the FTM to operate in Up-Down Counting mode. This field is write protected. It can be written only when MODE[WPDIS] = 1. 0b - FTM counter operates in Up Counting mode. 1b - FTM counter operates in Up-Down Counting mode.
4-3 CLKS	Clock Source Selection Selects one of the three FTM counter clock sources. This field is write protected. It can be written only when MODE[WPDIS] = 1. 00b - No clock selected. This in effect disables the FTM counter. 01b - FTM input clock 10b - Fixed frequency clock 11b - External clock
2-0 PS	Prescale Factor Selection Selects one of 8 division factors for the clock source selected by CLKS. The new prescaler factor affects the clock source on the next FTM input clock cycle after the new value is updated into the register bits. This field is write protected. It can be written only when MODE[WPDIS] = 1. 000b - Divide by 1 001b - Divide by 2 010b - Divide by 4 011b - Divide by 8 100b - Divide by 16 101b - Divide by 32 110b - Divide by 64 111b - Divide by 128

47.4.3.3 Counter (CNT)

47.4.3.3.1 Offset

Register	Offset
CNT	4h

47.4.3.3.2 Function

The CNT register contains the FTM counter value.

Reset clears the CNT register. Writing any value to COUNT updates the counter with its initial value, CNTIN.

47.4.3.3.3 Diagram

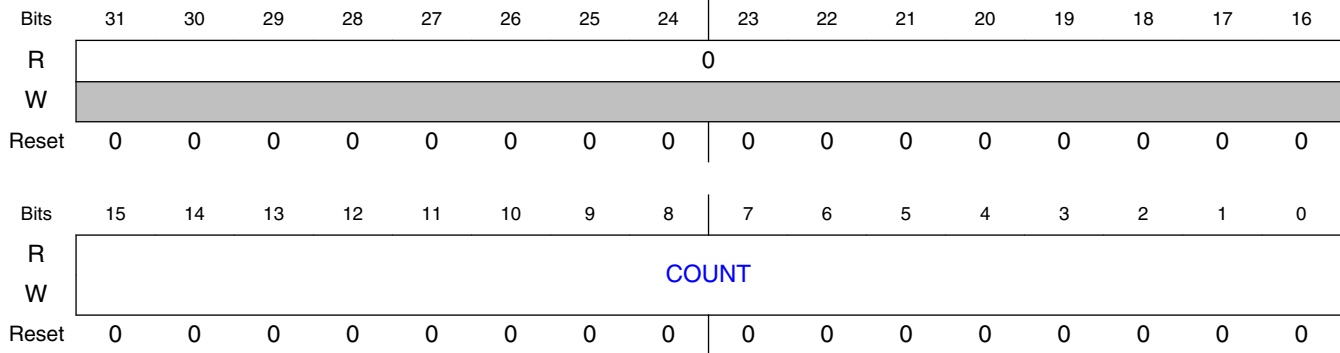

47.4.3.3.4 Fields

Field	Function
31-16 —	Reserved
15-0 COUNT	Counter Value

47.4.3.4 Modulo (MOD)

47.4.3.4.1 Offset

Register	Offset
MOD	8h

47.4.3.4.2 Function

The Modulo register contains the modulo value for the FTM counter. After the FTM counter reaches the modulo value, the overflow flag (TOF) becomes set at the next clock cycle, and the next value of FTM counter depends on the selected counting method; see [Counter](#).

Writes to the MOD register are done on its write buffer. The MOD register is updated with its write buffer value according to [Registers updated from write buffers](#). If FTMMEN = 0, a write to SC register resets manually this write coherency mechanism.

Memory map and register definition

Initialize the FTM counter, by writing to CNT, before writing to the MOD register to avoid confusion about when the first counter overflow will occur.

47.4.3.4.3 Diagram

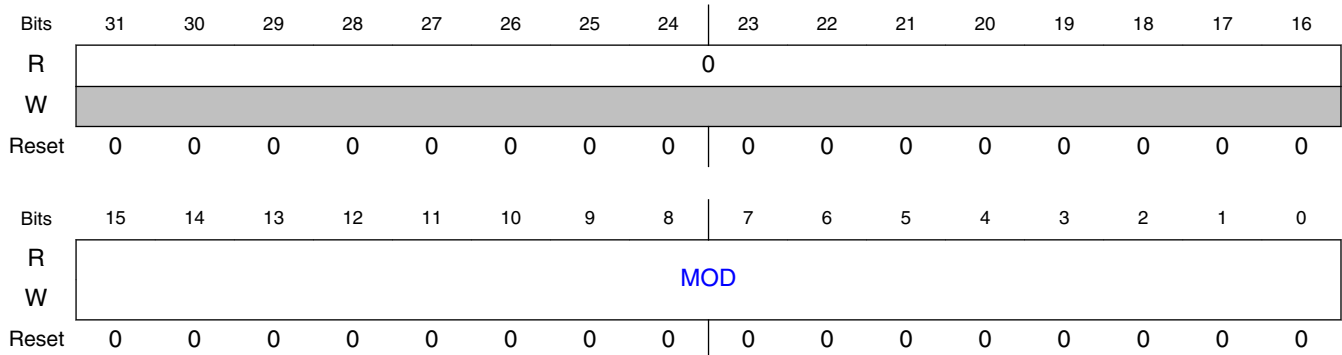

47.4.3.4.4 Fields

Field	Function
31-16 —	Reserved
15-0 MOD	MOD Modulo Value

47.4.3.5 Channel (n) Status And Control (C0SC - C7SC)

47.4.3.5.1 Offset

For a = 0 to 7:

Register	Offset
CaSC	Ch + (a × 8h)

47.4.3.5.2 Function

CnSC contains channel (n) status bits and control bits that select the channel (n) mode and its functionality.

47.4.3.5.3 Diagram

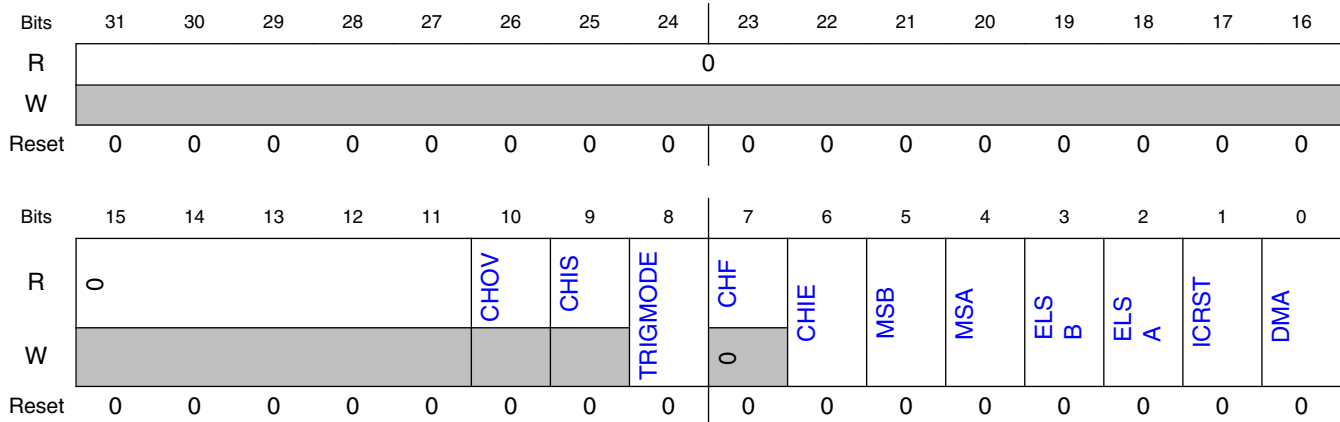

47.4.3.5.4 Fields

Field	Function
31-11 —	Reserved
10 CHOV	<p>Channel (n) Output Value</p> <p>The CHOV bit has the final value of the channel (n) output.</p> <p>NOTE: The CHOV bit should be ignored when the channel (n) is not in an output mode.</p> <p>0b - The channel (n) output is zero. 1b - The channel (n) output is one.</p>
9 CHIS	<p>Channel (n) Input State</p> <p>The CHIS bit has the value of the channel (n) input after the double-sampling or the filtering (if the channel (n) filter is enabled) both them are inside the FTM.</p> <p>NOTE: The CHIS bit should be ignored when the channel (n) is not in an input mode.</p> <p>NOTE: When the pair channels is on dual edge mode, the channel (n+1) CHIS bit is the channel (n+1) input value and not the channel (n) input value (this signal is the input signal used by the dual edge mode).</p> <p>0b - The channel (n) input is zero. 1b - The channel (n) input is one.</p>
8 TRIGMODE	<p>Trigger mode control</p> <p>This bit controls the trigger generation on FTM channel outputs. This mode is allowed only if when FTM channel is configured to EPWM or CPWM modes. If a match in the channel occurs, a trigger pulse with one FTM clock cycle width will be generated in the channel output. See Channel trigger output.</p> <p>This field is write protected. It can be written only when $MODE[WPDIS] = 1$.</p> <p>0b - Channel outputs will generate the normal PWM outputs without generating a pulse. 1b - If a match in the channel occurs, a trigger generation on channel output will happen. The trigger pulse width has one FTM clock cycle.</p>
7 CHF	<p>Channel (n) Flag</p> <p>Set by hardware when an event occurs on the channel (n). CHF is cleared by reading the CnSC register while CHF is set and then writing a 0 to the CHF bit. Writing a 1 to CHF has no effect.</p>

Table continues on the next page...

Memory map and register definition

Field	Function
	<p>If another event occurs between the read and write operations, the write operation has no effect; therefore, CHF remains set indicating an event has occurred. In this case a CHF interrupt request is not lost due to the clearing sequence for a previous CHF.</p> <p>0b - No channel (n) event has occurred. 1b - A channel (n) event has occurred.</p>
6 CHIE	<p>Channel (n) Interrupt Enable</p> <p>Enables channel (n) interrupt.</p> <p>0b - Disable channel (n) interrupt. Use software polling. 1b - Enable channel (n) interrupt.</p>
5 MSB	<p>Channel (n) Mode Select</p> <p>Used on the selection of the channel (n) mode. See Channel Modes.</p> <p>This field is write protected. It can be written only when MODE[WPDIS] = 1.</p>
4 MSA	<p>Channel (n) Mode Select</p> <p>Used on the selection of the channel (n) mode. See Channel Modes.</p> <p>This field is write protected. It can be written only when MODE[WPDIS] = 1.</p>
3 ELSB	<p>Channel (n) Edge or Level Select</p> <p>Used on the selection of the channel (n) mode. See Channel Modes.</p> <p>This field is write protected. It can be written only when MODE[WPDIS] = 1.</p>
2 ELSA	<p>Channel (n) Edge or Level Select</p> <p>Used on the selection of the channel (n) mode. See Channel Modes.</p> <p>This field is write protected. It can be written only when MODE[WPDIS] = 1.</p>
1 ICRST	<p>FTM counter reset by the selected input capture event.</p> <p>FTM counter reset is driven by the selected event of the channel (n) in the Input Capture mode.</p> <p>This field is write protected. It can be written only when MODE[WPDIS] = 1.</p> <p>0b - FTM counter is not reset when the selected channel (n) input event is detected. 1b - FTM counter is reset when the selected channel (n) input event is detected.</p>
0 DMA	<p>DMA Enable</p> <p>Enables DMA transfers for the channel.</p> <p>0b - Disable DMA transfers. 1b - Enable DMA transfers.</p>

47.4.3.6 Channel (n) Value (C0V - C7V)

47.4.3.6.1 Offset

For a = 0 to 7:

Register	Offset
CaV	10h + (a × 8h)

47.4.3.6.2 Function

These registers contain the captured FTM counter value for the input modes or the match value for the output modes.

In Input Capture , Capture Test, and Dual Edge Capture modes, any write to a CnV register is ignored.

In output modes, writes to the CnV register are done on its write buffer. The CnV register is updated with its write buffer value according to [Registers updated from write buffers](#). If FTMEN = 0, a write to CnSC register resets manually this write coherency mechanism.

47.4.3.6.3 Diagram

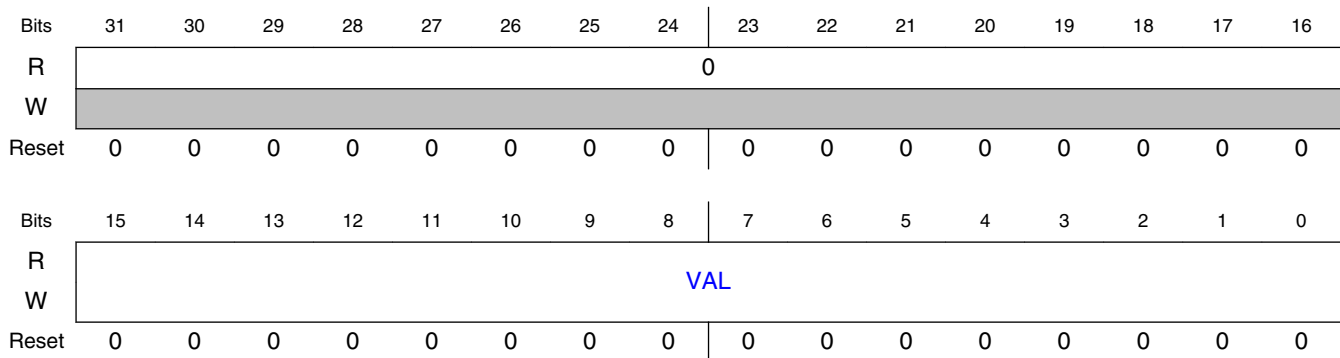

47.4.3.6.4 Fields

Field	Function
31-16 —	Reserved
15-0 VAL	Channel Value Captured FTM counter value of the input modes or the match value for the output modes

47.4.3.7 Counter Initial Value (CNTIN)

47.4.3.7.1 Offset

Register	Offset
CNTIN	4Ch

47.4.3.7.2 Function

The Counter Initial Value register contains the initial value for the FTM counter.

Writing to the CNTIN register latches the value into a buffer. The CNTIN register is updated with the value of its write buffer according to [Registers updated from write buffers](#).

When the FTM clock is initially selected, by writing a non-zero value to the CLKS bits, the FTM counter starts with the value 0x0000. To avoid this behavior, before the first write to select the FTM clock, write the new value to the CNTIN register and then initialize the FTM counter by writing any value to the CNT register.

47.4.3.7.3 Diagram

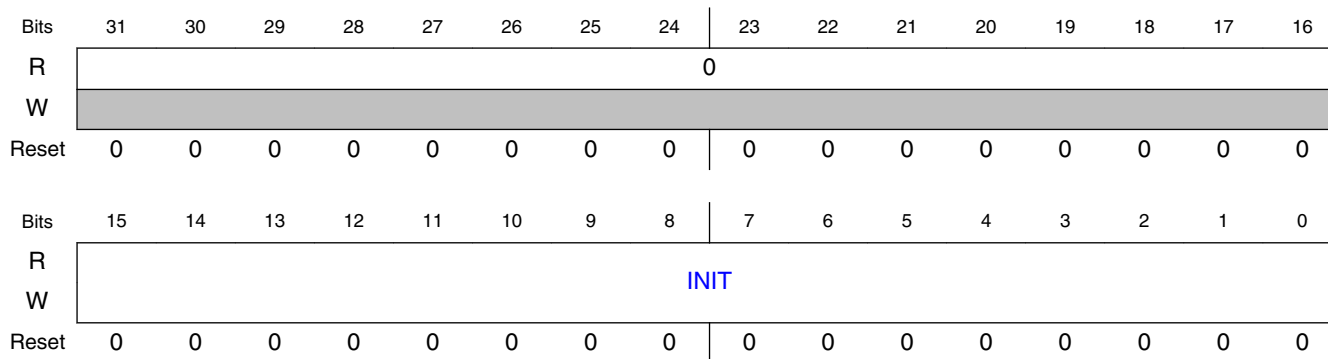

47.4.3.7.4 Fields

Field	Function
31-16 —	Reserved
15-0 INIT	INIT Initial Value Of The FTM Counter

47.4.3.8 Capture And Compare Status (STATUS)

47.4.3.8.1 Offset

Register	Offset
STATUS	50h

47.4.3.8.2 Function

The STATUS register contains a copy of the status flag CHF bit in CnSC for each FTM channel for software convenience.

Each CHF bit in STATUS is a mirror of CHF bit in CnSC. All CHF bits can be checked using only one read of STATUS. All CHF bits can be cleared by reading STATUS followed by writing 0x00 to STATUS.

Hardware sets the individual channel flags when an event occurs on the channel. CHF is cleared by reading STATUS while CHF is set and then writing a 0 to the CHF bit. Writing a 1 to CHF has no effect.

If another event occurs between the read and write operations, the write operation has no effect; therefore, CHF remains set indicating an event has occurred. In this case, a CHF interrupt request is not lost due to the clearing sequence for a previous CHF.

47.4.3.8.3 Diagram

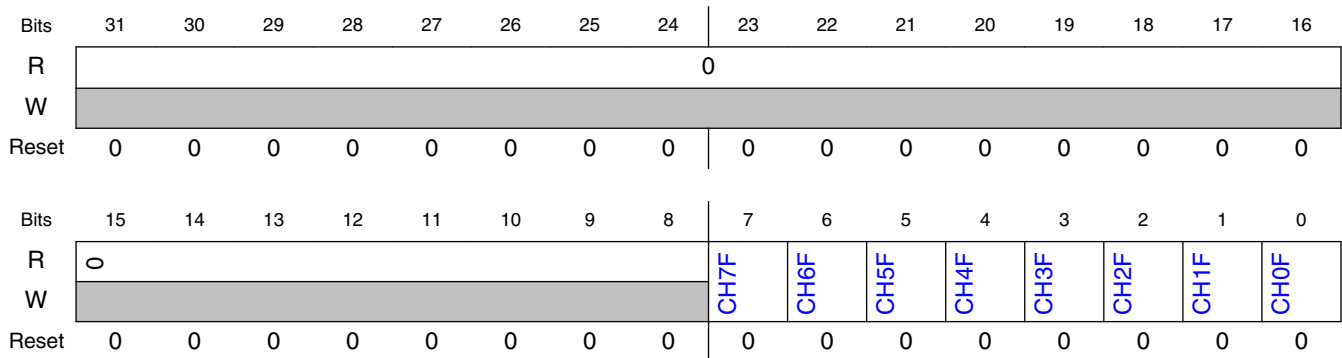

47.4.3.8.4 Fields

Field	Function
31-8	Reserved
—	
7-0	Channel n Flag

Memory map and register definition

Field	Function
CHnF	See the register description. 0b - No channel event has occurred. 1b - A channel event has occurred.

47.4.3.9 Features Mode Selection (MODE)

47.4.3.9.1 Offset

Register	Offset
MODE	54h

47.4.3.9.2 Function

This register contains the global enable bit for FTM-specific features and the control bits used to configure:

- Fault control mode and interrupt
- Capture Test mode
- PWM synchronization
- Write protection
- Channel output initialization

These controls relate to all channels within this module.

47.4.3.9.3 Diagram

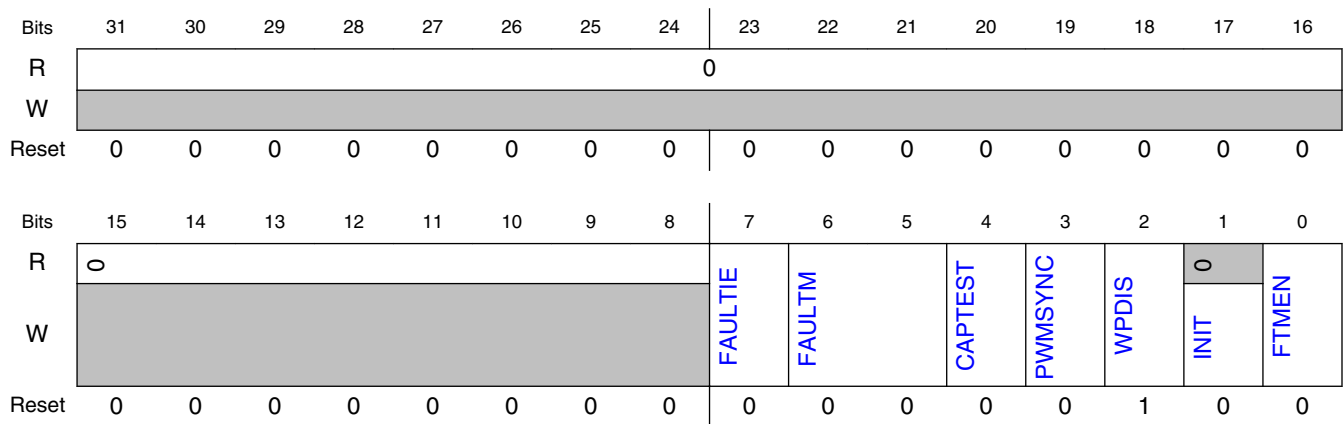

47.4.3.9.4 Fields

Field	Function
31-8 —	Reserved
7 FAULTIE	<p>Fault Interrupt Enable</p> <p>Enables the generation of an interrupt when a fault is detected by FTM and the FTM fault control is enabled.</p> <p>0b - Fault control interrupt is disabled. 1b - Fault control interrupt is enabled.</p>
6-5 FAULTM	<p>Fault Control Mode</p> <p>Defines the FTM fault control mode.</p> <p>This field is write protected. It can be written only when MODE[WPDIS] = 1.</p> <p>00b - Fault control is disabled for all channels. 01b - Fault control is enabled for even channels only (channels 0, 2, 4, and 6), and the selected mode is the manual fault clearing. 10b - Fault control is enabled for all channels, and the selected mode is the manual fault clearing. 11b - Fault control is enabled for all channels, and the selected mode is the automatic fault clearing.</p>
4 CAPTEST	<p>Capture Test Mode Enable</p> <p>Enables the capture test mode.</p> <p>This field is write protected. It can be written only when MODE[WPDIS] = 1.</p> <p>0b - Capture test mode is disabled. 1b - Capture test mode is enabled.</p>
3 PWMSYNC	<p>PWM Synchronization Mode</p> <p>Selects which triggers can be used by MOD, CnV, OUTMASK, and FTM counter synchronization. See PWM synchronization. The PWMSYNC bit configures the synchronization when SYNCMODE is 0.</p> <p>0b - No restrictions. Software and hardware triggers can be used by MOD, CnV, OUTMASK, and FTM counter synchronization. 1b - Software trigger can only be used by MOD and CnV synchronization, and hardware triggers can only be used by OUTMASK and FTM counter synchronization.</p>
2 WPDIS	<p>Write Protection Disable</p> <p>When write protection is enabled (WPDIS = 0), write protected bits cannot be written. When write protection is disabled (WPDIS = 1), write protected bits can be written. The WPDIS bit is the negation of the WPEN bit. WPDIS is cleared when 1 is written to WPEN. WPDIS is set when WPEN bit is read as a 1 and then 1 is written to WPDIS. Writing 0 to WPDIS has no effect.</p> <p>0b - Write protection is enabled. 1b - Write protection is disabled.</p>
1 INIT	<p>Initialize The Channels Output</p> <p>When a 1 is written to INIT bit the channels output is initialized according to the state of their corresponding bit in the OUTINIT register. Writing a 0 to INIT bit has no effect.</p> <p>The INIT bit is always read as 0.</p>
0 FTMEN	<p>FTM Enable</p> <p>This field is write protected. It can be written only when MODE[WPDIS] = 1.</p> <p>0b - TPM compatibility. Free running counter and synchronization compatible with TPM. 1b - Free running counter and synchronization are different from TPM behavior.</p>

47.4.3.10 Synchronization (SYNC)

47.4.3.10.1 Offset

Register	Offset
SYNC	58h

47.4.3.10.2 Function

This register configures the PWM synchronization.

A synchronization event can perform the synchronized update of MOD, CnV, and OUTMASK registers with the value of their write buffer and the FTM counter initialization.

NOTE

The software trigger, SWSYNC bit, and hardware triggers TRIG0, TRIG1, and TRIG2 bits have a potential conflict if used together when SYNCMODE = 0. Use only hardware or software triggers but not both at the same time, otherwise unpredictable behavior is likely to happen.

The selection of the loading point, CNTMAX and CNTMIN bits, is intended to provide the update of MOD, CNTIN, and CnV registers across all enabled channels simultaneously. The use of the loading point selection together with SYNCMODE = 0 and hardware trigger selection, TRIG0, TRIG1, or TRIG2 bits, is likely to result in unpredictable behavior.

The synchronization event selection also depends on the PWMSYNC (MODE register) and SYNCMODE (SYNCONF register) bits. See [PWM synchronization](#).

47.4.3.10.3 Diagram

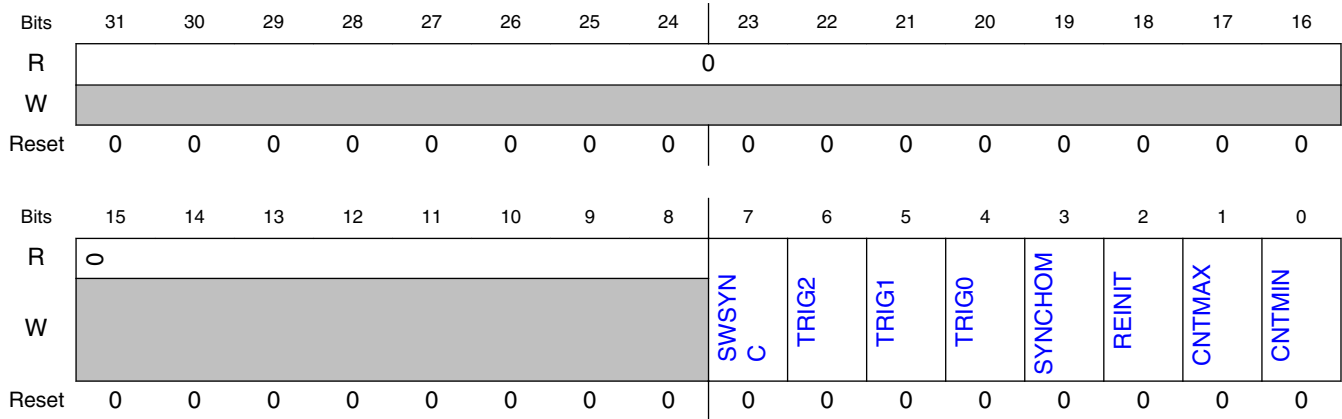

47.4.3.10.4 Fields

Field	Function
31-8 —	Reserved
7 SWSYNC	PWM Synchronization Software Trigger Selects the software trigger as the PWM synchronization trigger. The software trigger happens when a 1 is written to SWSYNC bit. 0b - Software trigger is not selected. 1b - Software trigger is selected.
6 TRIG2	PWM Synchronization Hardware Trigger 2 Enables hardware trigger 2 to the PWM synchronization. Hardware trigger 2 happens when a rising edge is detected at the trigger 2 input signal. 0b - Trigger is disabled. 1b - Trigger is enabled.
5 TRIG1	PWM Synchronization Hardware Trigger 1 Enables hardware trigger 1 to the PWM synchronization. Hardware trigger 1 happens when a rising edge is detected at the trigger 1 input signal. 0b - Trigger is disabled. 1b - Trigger is enabled.
4 TRIG0	PWM Synchronization Hardware Trigger 0 Enables hardware trigger 0 to the PWM synchronization. Hardware trigger 0 occurs when a rising edge is detected at the trigger 0 input signal. 0b - Trigger is disabled. 1b - Trigger is enabled.
3 SYNCHOM	Output Mask Synchronization Selects when the OUTMASK register is updated with the value of its buffer. 0b - OUTMASK register is updated with the value of its buffer in all rising edges of the FTM input clock. 1b - OUTMASK register is updated with the value of its buffer only by the PWM synchronization.
2	FTM Counter Reinitialization by Synchronization

Table continues on the next page...

Memory map and register definition

Field	Function
REINIT	Determines if the FTM counter is reinitialized when the selected trigger for the synchronization is detected (FTM counter synchronization). The REINIT bit configures the synchronization when SYNCMODE is zero. 0b - FTM counter continues to count normally. 1b - FTM counter is updated with its initial value when the selected trigger is detected.
1 CNTMAX	Maximum Loading Point Enable Selects the maximum loading point to PWM synchronization (Synchronization Points). If CNTMAX is 1, the selected loading point is when the FTM counter reaches its maximum value (MOD register). 0b - The maximum loading point is disabled. 1b - The maximum loading point is enabled.
0 CNTMIN	Minimum Loading Point Enable Selects the minimum loading point to PWM synchronization (Synchronization Points). If CNTMIN is 1, the selected loading point is when the FTM counter reaches its minimum value (CNTIN register). 0b - The minimum loading point is disabled. 1b - The minimum loading point is enabled.

47.4.3.11 Initial State For Channels Output (OUTINIT)

47.4.3.11.1 Offset

Register	Offset
OUTINIT	5Ch

47.4.3.11.2 Diagram

Bits	31	30	29	28	27	26	25	24	23	22	21	20	19	18	17	16
R	0															
W																
Reset	0	0	0	0	0	0	0	0	0	0	0	0	0	0	0	0
Bits	15	14	13	12	11	10	9	8	7	6	5	4	3	2	1	0
R	0								CH7OI	CH6OI	CH5OI	CH4OI	CH3OI	CH2OI	CH1OI	CH0OI
W									CH7OI	CH6OI	CH5OI	CH4OI	CH3OI	CH2OI	CH1OI	CH0OI
Reset	0	0	0	0	0	0	0	0	0	0	0	0	0	0	0	0

47.4.3.11.3 Fields

Field	Function
31-8	Reserved

Table continues on the next page...

Field	Function
—	
7-0 CHnOI	Channel n Output Initialization Value Selects the value that is forced into the channel output when the initialization occurs. 0b - The initialization value is 0. 1b - The initialization value is 1.

47.4.3.12 Output Mask (OUTMASK)

47.4.3.12.1 Offset

Register	Offset
OUTMASK	60h

47.4.3.12.2 Function

This register provides a mask for each FTM channel. The mask of a channel determines if its output responds, that is, it is masked or not, when a match occurs. This feature is used for BLDC control where the PWM signal is presented to an electric motor at specific times to provide electronic commutation.

Any write to the OUTMASK register, stores the value in its write buffer. The register is updated with the value of its write buffer according to [PWM synchronization](#).

Output Mask bits must not be set for trigger mode.

47.4.3.12.3 Diagram

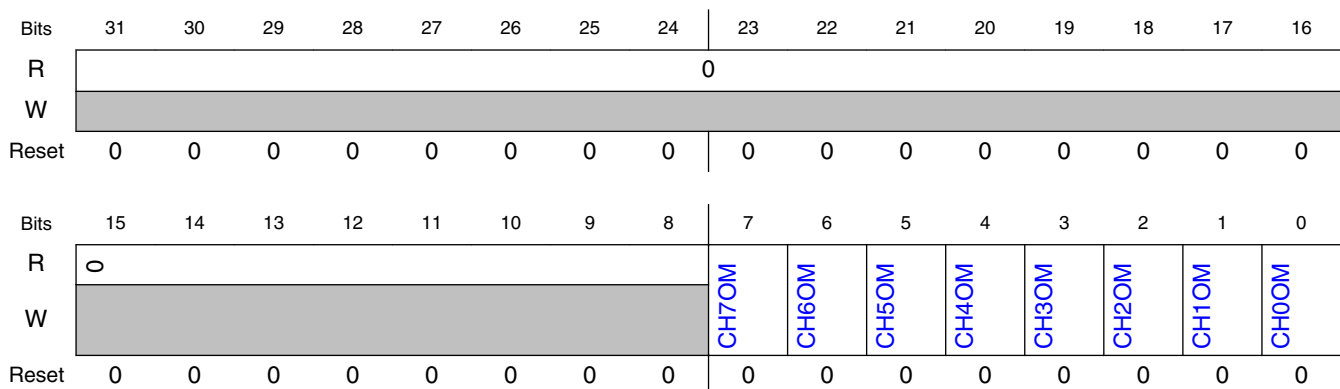

47.4.3.12.4 Fields

Field	Function
31-8 —	Reserved
7-0 CHnOM	Channel n Output Mask Defines if the channel output is masked or unmasked. 0b - Channel output is not masked. It continues to operate normally. 1b - Channel output is masked. It is forced to its inactive state.

47.4.3.13 Function For Linked Channels (COMBINE)

47.4.3.13.1 Offset

Register	Offset
COMBINE	64h

47.4.3.13.2 Function

This register contains the configuration bits for each pair of channels.

47.4.3.13.3 Diagram

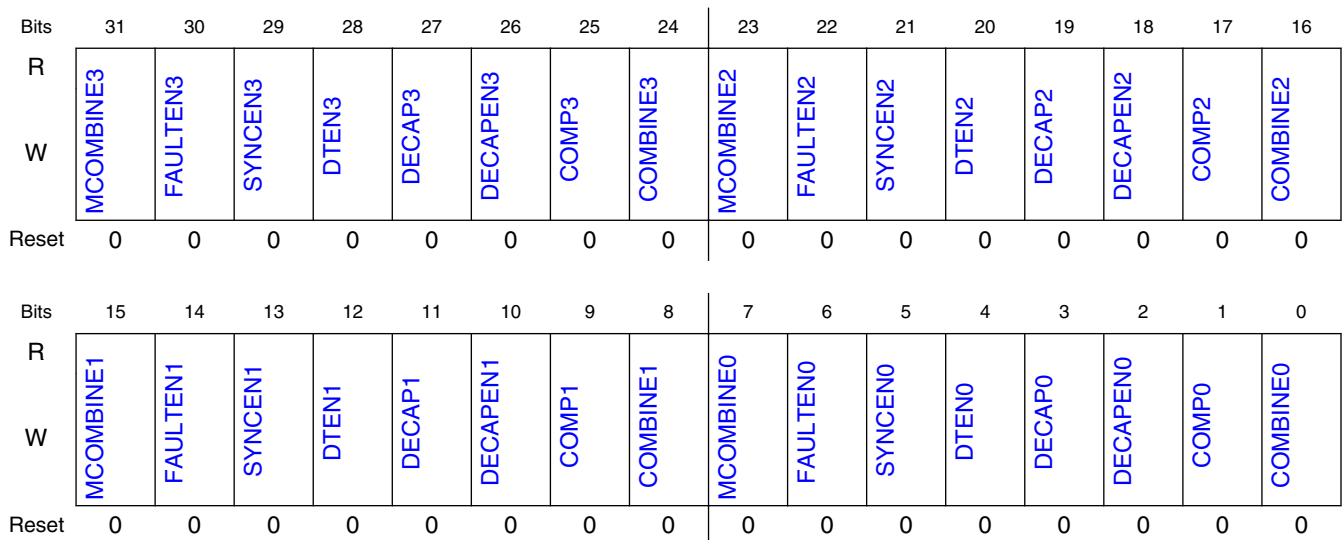

47.4.3.13.4 Fields

Field	Function
31 MCOMBINE3	Modified Combine Mode For n = 6 Used on the selection of the modified combine mode for channels (n) and (n+1). See Channel Modes . This field is write protected. It can be written only when MODE[WPDIS] = 1.
30 FAULTEN3	Fault Control Enable For n = 6 Enables the fault control in channels (n) and (n+1). This field is write protected. It can be written only when MODE[WPDIS] = 1. 0b - The fault control in this pair of channels is disabled. 1b - The fault control in this pair of channels is enabled.
29 SYNCE3	Synchronization Enable For n = 6 Enables PWM synchronization of registers C(n)V and C(n+1)V. 0b - The PWM synchronization in this pair of channels is disabled. 1b - The PWM synchronization in this pair of channels is enabled.
28 DTEN3	Deadtime Enable For n = 6 Enables the deadtime insertion in the channels (n) and (n+1). This field is write protected. It can be written only when MODE[WPDIS] = 1. 0b - The deadtime insertion in this pair of channels is disabled. 1b - The deadtime insertion in this pair of channels is enabled.
27 DECAP3	Dual Edge Capture Mode Captures For n = 6 Enables the capture of the FTM counter value according to the channel (n) input event and the configuration of the dual edge capture bits. This field applies only when DECAPEN = 1. DECAP bit is cleared automatically by hardware if dual edge capture – one-shot mode is selected and when the capture of channel (n+1) event is made. 0b - The dual edge captures are inactive. 1b - The dual edge captures are active.
26 DECAPEN3	Dual Edge Capture Mode Enable For n = 6 Enables the Dual Edge Capture mode in the channels (n) and (n+1). See Channel Modes . This field is write protected. It can be written only when MODE[WPDIS] = 1.
25 COMP3	Complement Of Channel (n) for n = 6 In Complementary mode the channel (n+1) output is the inverse of the channel (n) output. This field is write protected. It can be written only when MODE[WPDIS] = 1. 0b - If the channels (n) and (n+1) are in Combine Mode or Modified Combine PWM Mode, the channel (n+1) output is the same as the channel (n) output. If the channel (n+1) is in Output Compare Mode, EPWM or CPWM, the channel (n+1) output is independent from channel (n) output. 1b - The channel (n+1) output is the complement of the channel (n) output.
24 COMBINE3	Combine Channels For n = 6 Used on the selection of the combine mode for channels (n) and (n+1). See Channel Modes . This field is write protected. It can be written only when MODE[WPDIS] = 1.
23	Modified Combine Mode For n = 4

Table continues on the next page...

Memory map and register definition

Field	Function
MCOMBINE2	Used on the selection of the modified combine mode for channels (n) and (n+1). See Channel Modes . This field is write protected. It can be written only when MODE[WPDIS] = 1.
22 FAULTEN2	Fault Control Enable For n = 4 Enables the fault control in channels (n) and (n+1). This field is write protected. It can be written only when MODE[WPDIS] = 1. 0b - The fault control in this pair of channels is disabled. 1b - The fault control in this pair of channels is enabled.
21 SYNCEN2	Synchronization Enable For n = 4 Enables PWM synchronization of registers C(n)V and C(n+1)V. 0b - The PWM synchronization in this pair of channels is disabled. 1b - The PWM synchronization in this pair of channels is enabled.
20 DTEN2	Deadtime Enable For n = 4 Enables the deadtime insertion in the channels (n) and (n+1). This field is write protected. It can be written only when MODE[WPDIS] = 1. 0b - The deadtime insertion in this pair of channels is disabled. 1b - The deadtime insertion in this pair of channels is enabled.
19 DECAP2	Dual Edge Capture Mode Captures For n = 4 Enables the capture of the FTM counter value according to the channel (n) input event and the configuration of the dual edge capture bits. This field applies only when DECAPEN = 1. DECAP bit is cleared automatically by hardware if dual edge capture – one-shot mode is selected and when the capture of channel (n+1) event is made. 0b - The dual edge captures are inactive. 1b - The dual edge captures are active.
18 DECAPEN2	Dual Edge Capture Mode Enable For n = 4 Enables the Dual Edge Capture mode in the channels (n) and (n+1). See Channel Modes . This field is write protected. It can be written only when MODE[WPDIS] = 1.
17 COMP2	Complement Of Channel (n) For n = 4 In Complementary mode the channel (n+1) output is the inverse of the channel (n) output. This field is write protected. It can be written only when MODE[WPDIS] = 1. 0b - If the channels (n) and (n+1) are in Combine Mode or Modified Combine PWM Mode, the channel (n+1) output is the same as the channel (n) output. If the channel (n+1) is in Output Compare Mode, EPWM or CPWM, the channel (n+1) output is independent from channel (n) output. 1b - The channel (n+1) output is the complement of the channel (n) output.
16 COMBINE2	Combine Channels For n = 4 Used on the selection of the combine mode for channels (n) and (n+1). See Channel Modes . This field is write protected. It can be written only when MODE[WPDIS] = 1.
15 MCOMBINE1	Modified Combine Mode For n = 2 Used on the selection of the modified combine mode for channels (n) and (n+1). See Channel Modes . This field is write protected. It can be written only when MODE[WPDIS] = 1.
14	Fault Control Enable For n = 2

Table continues on the next page...

Field	Function
FAULTEN1	Enables the fault control in channels (n) and (n+1). This field is write protected. It can be written only when MODE[WPDIS] = 1. 0b - The fault control in this pair of channels is disabled. 1b - The fault control in this pair of channels is enabled.
13 SYNCEN1	Synchronization Enable For n = 2 Enables PWM synchronization of registers C(n)V and C(n+1)V. 0b - The PWM synchronization in this pair of channels is disabled. 1b - The PWM synchronization in this pair of channels is enabled.
12 DTEN1	Deadtime Enable For n = 2 Enables the deadtime insertion in the channels (n) and (n+1). This field is write protected. It can be written only when MODE[WPDIS] = 1. 0b - The deadtime insertion in this pair of channels is disabled. 1b - The deadtime insertion in this pair of channels is enabled.
11 DECAP1	Dual Edge Capture Mode Captures For n = 2 Enables the capture of the FTM counter value according to the channel (n) input event and the configuration of the dual edge capture bits. This field applies only when DECAPEN = 1. DECAP bit is cleared automatically by hardware if Dual Edge Capture – One-Shot mode is selected and when the capture of channel (n+1) event is made. 0b - The dual edge captures are inactive. 1b - The dual edge captures are active.
10 DECAPEN1	Dual Edge Capture Mode Enable For n = 2 Enables the Dual Edge Capture mode in the channels (n) and (n+1). See Channel Modes . This field is write protected. It can be written only when MODE[WPDIS] = 1.
9 COMP1	Complement Of Channel (n) For n = 2 In Complementary mode the channel (n+1) output is the inverse of the channel (n) output. This field is write protected. It can be written only when MODE[WPDIS] = 1. 0b - If the channels (n) and (n+1) are in Combine Mode or Modified Combine PWM Mode, the channel (n+1) output is the same as the channel (n) output. If the channel (n+1) is in Output Compare Mode, EPWM or CPWM, the channel (n+1) output is independent from channel (n) output. 1b - The channel (n+1) output is the complement of the channel (n) output.
8 COMBINE1	Combine Channels For n = 2 Used on the selection of the combine mode for channels (n) and (n+1). See Channel Modes . This field is write protected. It can be written only when MODE[WPDIS] = 1.
7 MCOMBINE0	Modified Combine Mode For n = 0 Used on the selection of the modified combine mode for channels (n) and (n+1). See Channel Modes . This field is write protected. It can be written only when MODE[WPDIS] = 1.
6 FAULTEN0	Fault Control Enable For n = 0 Enables the fault control in channels (n) and (n+1). This field is write protected. It can be written only when MODE[WPDIS] = 1. 0b - The fault control in this pair of channels is disabled. 1b - The fault control in this pair of channels is enabled.

Table continues on the next page...

Memory map and register definition

Field	Function
5 SYNCEN0	<p>Synchronization Enable For n = 0</p> <p>Enables PWM synchronization of registers C(n)V and C(n+1)V.</p> <p>0b - The PWM synchronization in this pair of channels is disabled. 1b - The PWM synchronization in this pair of channels is enabled.</p>
4 DTEN0	<p>Deadtime Enable For n = 0</p> <p>Enables the deadtime insertion in the channels (n) and (n+1).</p> <p>This field is write protected. It can be written only when MODE[WPDIS] = 1.</p> <p>0b - The deadtime insertion in this pair of channels is disabled. 1b - The deadtime insertion in this pair of channels is enabled.</p>
3 DECAPO	<p>Dual Edge Capture Mode Captures For n = 0</p> <p>Enables the capture of the FTM counter value according to the channel (n) input event and the configuration of the dual edge capture bits.</p> <p>This field applies only when DECAPEN = 1.</p> <p>DECAP bit is cleared automatically by hardware if dual edge capture – one-shot mode is selected and when the capture of channel (n+1) event is made.</p> <p>0b - The dual edge captures are inactive. 1b - The dual edge captures are active.</p>
2 DECAPEN0	<p>Dual Edge Capture Mode Enable For n = 0</p> <p>Enables the Dual Edge Capture mode in the channels (n) and (n+1). See Channel Modes.</p> <p>This field is write protected. It can be written only when MODE[WPDIS] = 1.</p>
1 COMPO	<p>Complement Of Channel (n) For n = 0</p> <p>In Complementary mode the channel (n+1) output is the inverse of the channel (n) output.</p> <p>This field is write protected. It can be written only when MODE[WPDIS] = 1.</p> <p>0b - If the channels (n) and (n+1) are in Combine Mode or Modified Combine PWM Mode, the channel (n+1) output is the same as the channel (n) output. If the channel (n+1) is in Output Compare Mode, EPWM or CPWM, the channel (n+1) output is independent from channel (n) output. 1b - The channel (n+1) output is the complement of the channel (n) output.</p>
0 COMBINE0	<p>Combine Channels For n = 0</p> <p>Used on the selection of the combine mode for channels (n) and (n+1). See Channel Modes.</p> <p>This field is write protected. It can be written only when MODE[WPDIS] = 1.</p>

47.4.3.14 Deadtime Configuration (DEADTIME)

47.4.3.14.1 Offset

Register	Offset
DEADTIME	68h

47.4.3.14.2 Function

This register selects the deadtime prescaler and value.

47.4.3.14.3 Diagram

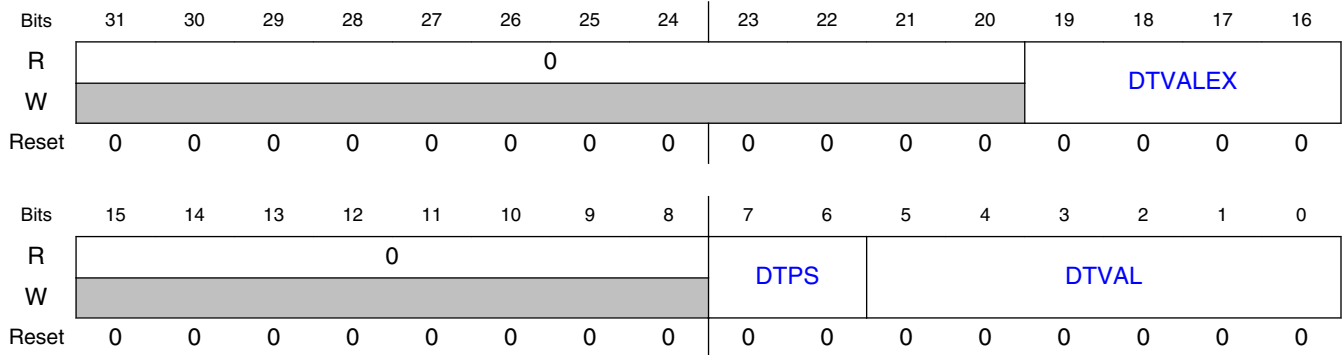

47.4.3.14.4 Fields

Field	Function
31-20 —	Reserved
19-16 DTVALEX	<p>Extended Deadtime Value</p> <p>This field is a bit extension of the DTVAL field. It defines the 4 most significant bits of the deadtime value. The maximum deadtime value is extended to 1023 using the concatenation {DTVALEX, DTVAL}.</p> <p>Deadtime insert value = (DTPS × {DTVALEX, DTVAL}).</p> <p>This field is write protected. It can be written only when MODE[WPDIS] = 1.</p> <p>NOTE: If full compatibility is needed with previous software versions, write 0 to DTVALEX bits.</p>
15-8 —	Reserved
7-6 DTPS	<p>Deadtime Prescaler Value</p> <p>Selects the division factor of the FTM input clock. This prescaled clock is used by the deadtime counter.</p> <p>This field is write protected. It can be written only when MODE[WPDIS] = 1.</p> <p>0xb - Divide the FTM input clock by 1. 10b - Divide the FTM input clock by 4. 11b - Divide the FTM input clock by 16.</p>
5-0 DTVAL	<p>Deadtime Value</p> <p>Selects the deadtime value.</p> <p>This field is write protected. It can be written only when MODE[WPDIS] = 1.</p>

47.4.3.15 FTM External Trigger (EXTTRIG)

47.4.3.15.1 Offset

Register	Offset
EXTTRIG	6Ch

47.4.3.15.2 Function

This register:

- Indicates when the external trigger was generated
- Enables the generation of a trigger when the FTM counter is equal to its initial value
- Selects which channels are used in the generation of the external trigger

47.4.3.15.3 Diagram

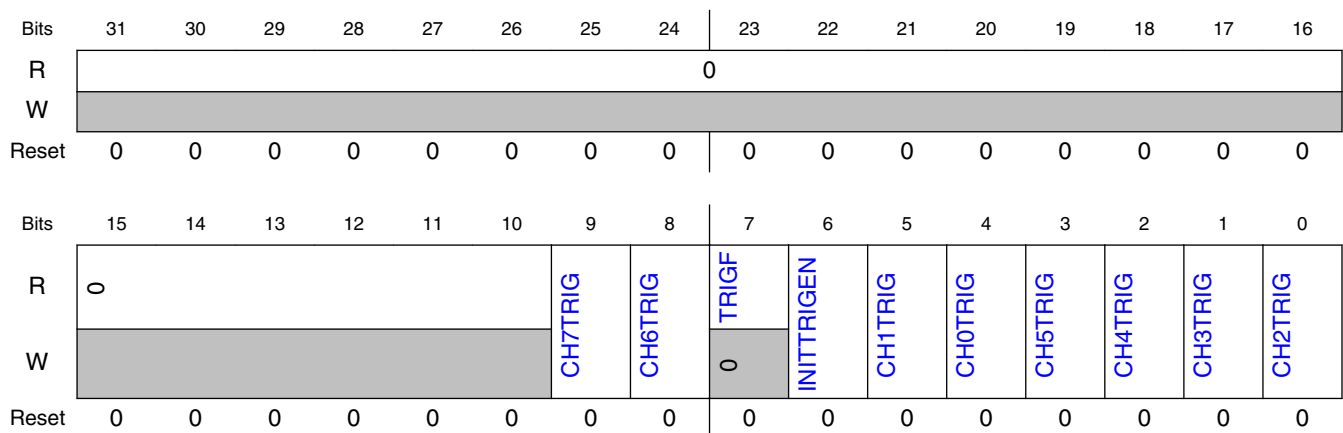

47.4.3.15.4 Fields

Field	Function
31-10 —	Reserved
9 CH7TRIG	Channel 7 External Trigger Enable Enables the generation of the external trigger when FTM counter = C7V. 0b - The generation of this external trigger is disabled. 1b - The generation of this external trigger is enabled.
8 CH6TRIG	Channel 6 External Trigger Enable Enables the generation of the external trigger when FTM counter = C6V.

Table continues on the next page...

Field	Function
	0b - The generation of this external trigger is disabled. 1b - The generation of this external trigger is enabled.
7 TRIGF	Channel Trigger Flag Set by hardware when a channel trigger is generated. Clear TRIGF by reading EXTTRIG while TRIGF is set and then writing a 0 to TRIGF. Writing a 1 to TRIGF has no effect. If another channel trigger is generated before the clearing sequence is completed, the sequence is reset so TRIGF remains set after the clear sequence is completed for the earlier TRIGF. 0b - No channel trigger was generated. 1b - A channel trigger was generated.
6 INITTRIGEN	Initialization Trigger Enable Enables the generation of the trigger when the FTM counter is equal to the CNTIN register. 0b - The generation of initialization trigger is disabled. 1b - The generation of initialization trigger is enabled.
5 CH1TRIG	Channel 1 External Trigger Enable Enables the generation of the external trigger when FTM counter = C1V. 0b - The generation of this external trigger is disabled. 1b - The generation of this external trigger is enabled.
4 CH0TRIG	Channel 0 External Trigger Enable Enables the generation of the external trigger when FTM counter = C0V. 0b - The generation of this external trigger is disabled. 1b - The generation of this external trigger is enabled.
3 CH5TRIG	Channel 5 External Trigger Enable Enables the generation of the external trigger when FTM counter = C5V. 0b - The generation of this external trigger is disabled. 1b - The generation of this external trigger is enabled.
2 CH4TRIG	Channel 4 External Trigger Enable Enables the generation of the external trigger when FTM counter = C4V. 0b - The generation of this external trigger is disabled. 1b - The generation of this external trigger is enabled.
1 CH3TRIG	Channel 3 External Trigger Enable Enables the generation of the external trigger when FTM counter = C3V. 0b - The generation of this external trigger is disabled. 1b - The generation of this external trigger is enabled.
0 CH2TRIG	Channel 2 External Trigger Enable Enables the generation of the external trigger when FTM counter = C2V. 0b - The generation of this external trigger is disabled. 1b - The generation of this external trigger is enabled.

47.4.3.16 Channels Polarity (POL)

47.4.3.16.1 Offset

Register	Offset
POL	70h

47.4.3.16.2 Function

This register defines the output polarity of the FTM channels.

NOTE

The channel safe value is the value of its POL bit. The channel safe value is driven on the channel output when the fault control is enabled and a fault condition is detected.

47.4.3.16.3 Diagram

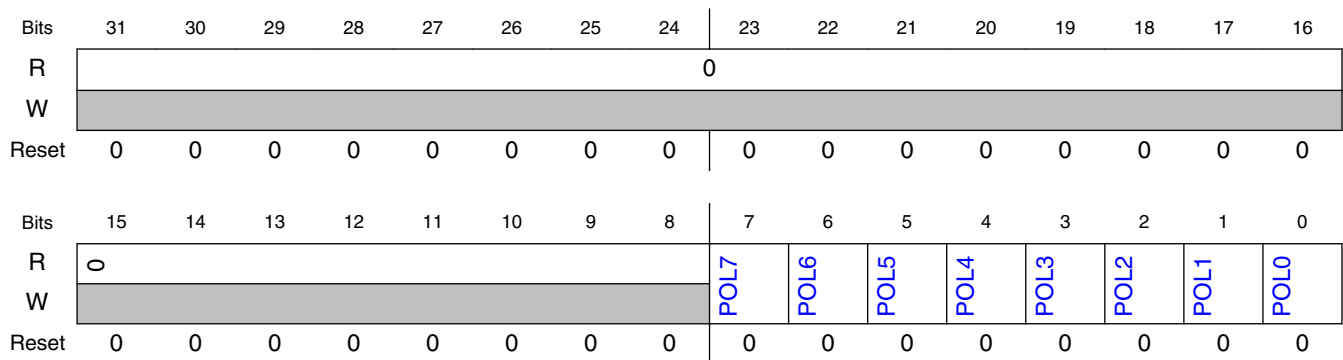

47.4.3.16.4 Fields

Field	Function
31-8 —	Reserved
7-0 POLn	<p>Channel n Polarity</p> <p>Defines the polarity of the channel output.</p> <p>This field is write protected. It can be written only when MODE[WPDIS] = 1.</p> <p>0b - The channel polarity is active high. 1b - The channel polarity is active low.</p>

47.4.3.17 Fault Mode Status (FMS)

47.4.3.17.1 Offset

Register	Offset
FMS	74h

47.4.3.17.2 Function

This register contains:

- the write protection enable bit
- the fault detection flags
- the logic OR of the enabled fault inputs

47.4.3.17.3 Diagram

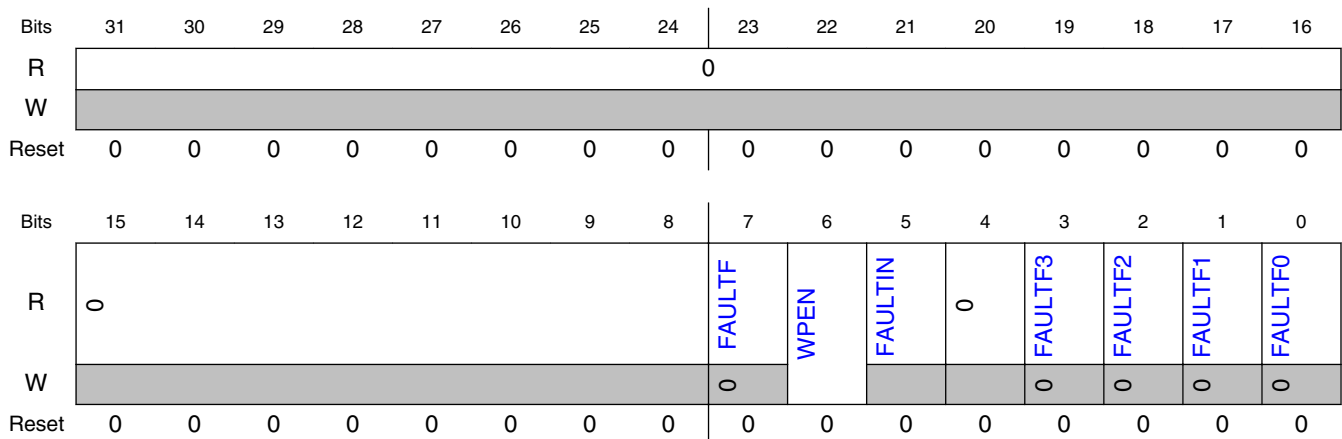

47.4.3.17.4 Fields

Field	Function
31-8	Reserved
—	
7	Fault Detection Flag
FAULTF	Represents the logic OR of the FAULTF bit of each enabled fault input. Clear FAULTF by reading the FMS register while FAULTF is set and then writing a 0 to FAULTF while there is no existing fault condition at the enabled fault inputs. Writing a 1 to FAULTF has no effect.

Table continues on the next page...

Memory map and register definition

Field	Function																		
	<p>If another fault condition is detected in an enabled fault input before the clearing sequence is completed, the sequence is reset so FAULTF remains set after the clearing sequence is completed for the earlier fault condition. FAULTF is also cleared when FAULTF bit of each enabled fault input is cleared.</p> <p>0b - No fault condition was detected. 1b - A fault condition was detected.</p>																		
6 WPEN	<p>Write Protection Enable</p> <p>The WPEN bit is the negation of the WPDIS bit. WPEN is set when 1 is written to it. WPEN is cleared when WPEN bit is read as a 1 and then 1 is written to WPDIS. Writing 0 to WPEN has no effect.</p> <p>0b - Write protection is disabled. Write protected bits can be written. 1b - Write protection is enabled. Write protected bits cannot be written.</p>																		
5 FAULTIN	<p>Fault Inputs</p> <p>Represents the logic OR of the enabled fault inputs after their filter (if their filter is enabled) when fault control is enabled.</p> <p>0b - The logic OR of the enabled fault inputs is 0. 1b - The logic OR of the enabled fault inputs is 1.</p>																		
4 —	Reserved																		
3 FAULTF3	<p>Fault Detection Flag 3</p> <p>Set by hardware when fault control is enabled, the corresponding fault input is enabled and a fault condition is detected at the fault input.</p> <p>Clear FAULTF3 by reading the FMS register while FAULTF3 is set and then writing a 0 to FAULTF3 while there is no existing fault condition at the corresponding fault input. Writing a 1 to FAULTF3 has no effect. FAULTF3 bit is also cleared when FAULTF bit is cleared.</p> <p>If another fault condition is detected at the corresponding fault input before the clearing sequence is completed, the sequence is reset so FAULTF3 remains set after the clearing sequence is completed for the earlier fault condition.</p> <p>NOTE: This field is not supported in every instance. The following table includes only supported registers.</p> <table border="1" data-bbox="431 1203 1455 1576"> <thead> <tr> <th>Field supported in</th> <th>Field not supported in</th> </tr> </thead> <tbody> <tr> <td>FTM0_FMS</td> <td>—</td> </tr> <tr> <td>FTM1_FMS</td> <td>—</td> </tr> <tr> <td>FTM2_FMS</td> <td>—</td> </tr> <tr> <td>FTM3_FMS</td> <td>—</td> </tr> <tr> <td>—</td> <td>FTM4_FMS</td> </tr> <tr> <td>—</td> <td>FTM5_FMS</td> </tr> <tr> <td>—</td> <td>FTM6_FMS</td> </tr> <tr> <td>—</td> <td>FTM7_FMS</td> </tr> </tbody> </table> <p>0b - No fault condition was detected at the fault input. 1b - A fault condition was detected at the fault input.</p>	Field supported in	Field not supported in	FTM0_FMS	—	FTM1_FMS	—	FTM2_FMS	—	FTM3_FMS	—	—	FTM4_FMS	—	FTM5_FMS	—	FTM6_FMS	—	FTM7_FMS
Field supported in	Field not supported in																		
FTM0_FMS	—																		
FTM1_FMS	—																		
FTM2_FMS	—																		
FTM3_FMS	—																		
—	FTM4_FMS																		
—	FTM5_FMS																		
—	FTM6_FMS																		
—	FTM7_FMS																		
2 FAULTF2	<p>Fault Detection Flag 2</p> <p>Set by hardware when fault control is enabled, the corresponding fault input is enabled and a fault condition is detected at the fault input.</p>																		

Table continues on the next page...

Field	Function																		
	<p>Clear FAULTF2 by reading the FMS register while FAULTF2 is set and then writing a 0 to FAULTF2 while there is no existing fault condition at the corresponding fault input. Writing a 1 to FAULTF2 has no effect. FAULTF2 bit is also cleared when FAULTF bit is cleared.</p> <p>If another fault condition is detected at the corresponding fault input before the clearing sequence is completed, the sequence is reset so FAULTF2 remains set after the clearing sequence is completed for the earlier fault condition.</p> <p>NOTE: This field is not supported in every instance. The following table includes only supported registers.</p> <table border="1" data-bbox="431 482 1455 855"> <thead> <tr> <th>Field supported in</th> <th>Field not supported in</th> </tr> </thead> <tbody> <tr> <td>FTM0_FMS</td> <td>—</td> </tr> <tr> <td>FTM1_FMS</td> <td>—</td> </tr> <tr> <td>FTM2_FMS</td> <td>—</td> </tr> <tr> <td>FTM3_FMS</td> <td>—</td> </tr> <tr> <td>—</td> <td>FTM4_FMS</td> </tr> <tr> <td>—</td> <td>FTM5_FMS</td> </tr> <tr> <td>—</td> <td>FTM6_FMS</td> </tr> <tr> <td>—</td> <td>FTM7_FMS</td> </tr> </tbody> </table> <p>0b - No fault condition was detected at the fault input. 1b - A fault condition was detected at the fault input.</p>	Field supported in	Field not supported in	FTM0_FMS	—	FTM1_FMS	—	FTM2_FMS	—	FTM3_FMS	—	—	FTM4_FMS	—	FTM5_FMS	—	FTM6_FMS	—	FTM7_FMS
Field supported in	Field not supported in																		
FTM0_FMS	—																		
FTM1_FMS	—																		
FTM2_FMS	—																		
FTM3_FMS	—																		
—	FTM4_FMS																		
—	FTM5_FMS																		
—	FTM6_FMS																		
—	FTM7_FMS																		
<p>1</p> <p>FAULTF1</p>	<p>Fault Detection Flag 1</p> <p>Set by hardware when fault control is enabled, the corresponding fault input is enabled and a fault condition is detected at the fault input.</p> <p>Clear FAULTF1 by reading the FMS register while FAULTF1 is set and then writing a 0 to FAULTF1 while there is no existing fault condition at the corresponding fault input. Writing a 1 to FAULTF1 has no effect. FAULTF1 bit is also cleared when FAULTF bit is cleared.</p> <p>If another fault condition is detected at the corresponding fault input before the clearing sequence is completed, the sequence is reset so FAULTF1 remains set after the clearing sequence is completed for the earlier fault condition.</p> <p>0b - No fault condition was detected at the fault input. 1b - A fault condition was detected at the fault input.</p>																		
<p>0</p> <p>FAULTF0</p>	<p>Fault Detection Flag 0</p> <p>Set by hardware when fault control is enabled, the corresponding fault input is enabled and a fault condition is detected at the fault input.</p> <p>Clear FAULTF0 by reading the FMS register while FAULTF0 is set and then writing a 0 to FAULTF0 while there is no existing fault condition at the corresponding fault input. Writing a 1 to FAULTF0 has no effect. FAULTF0 bit is also cleared when FAULTF bit is cleared.</p> <p>If another fault condition is detected at the corresponding fault input before the clearing sequence is completed, the sequence is reset so FAULTF0 remains set after the clearing sequence is completed for the earlier fault condition.</p> <p>0b - No fault condition was detected at the fault input. 1b - A fault condition was detected at the fault input.</p>																		

47.4.3.18 Input Capture Filter Control (FILTER)

47.4.3.18.1 Offset

Register	Offset
FILTER	78h

47.4.3.18.2 Function

This register selects the filter value for the inputs of channels.

Channels 4, 5, 6 and 7 do not have an input filter.

NOTE

Writing to the FILTER register has immediate effect and must be done only when the channels 0, 1, 2, and 3 are not in input modes. Failure to do this could result in a missing valid signal.

47.4.3.18.3 Diagram

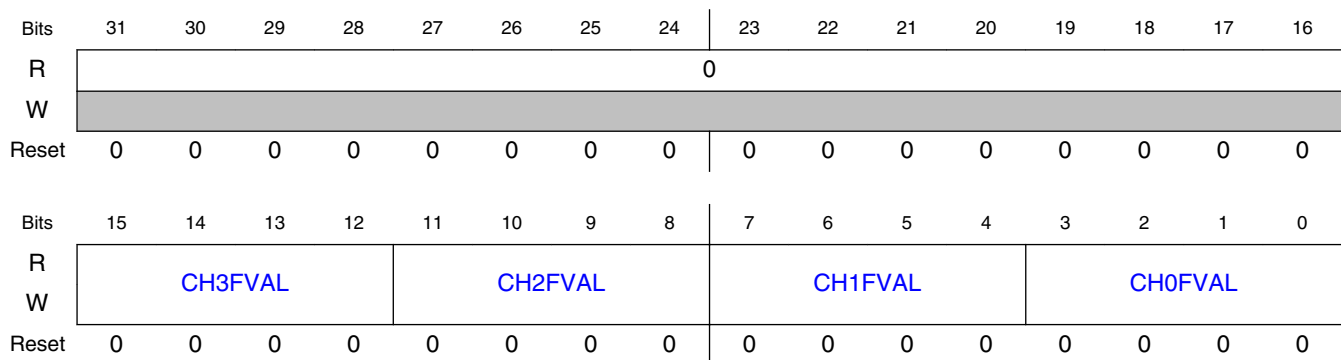

47.4.3.18.4 Fields

Field	Function
31-16 —	Reserved
15-12 CH3FVAL	Channel 3 Input Filter Selects the filter value for the channel input. The filter is disabled when the value is zero.
11-8	Channel 2 Input Filter

Table continues on the next page...

Field	Function
CH2FVAL	Selects the filter value for the channel input. The filter is disabled when the value is zero.
7-4 CH1FVAL	Channel 1 Input Filter Selects the filter value for the channel input. The filter is disabled when the value is zero.
3-0 CH0FVAL	Channel 0 Input Filter Selects the filter value for the channel input. The filter is disabled when the value is zero.

47.4.3.19 Fault Control (FLTCTRL)

47.4.3.19.1 Offset

Register	Offset
FLTCTRL	7Ch

47.4.3.19.2 Function

This register contains:

- the state of channels output when a fault event happens
- the enable for each fault input
- the filter enable for each fault input
- the filter value for enabled fault inputs and with filter

47.4.3.19.3 Diagram

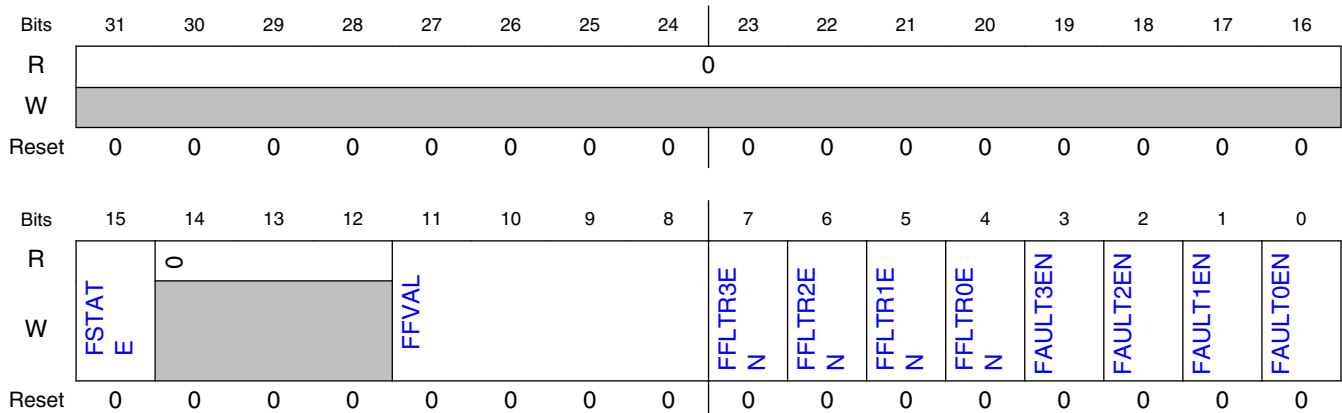

47.4.3.19.4 Fields

Field	Function																		
31-16 —	Reserved																		
15 FSTATE	<p>Fault output state</p> <p>This configuration allows to put the FTM outputs tri-stated when a fault event is ongoing.</p> <p>This field is write protected. It can be written only when MODE[WPDIS] = 1.</p> <p>0b - FTM outputs will be placed into safe values when fault events in ongoing (defined by POL bits). 1b - FTM outputs will be tri-stated when fault event is ongoing</p>																		
14-12 —	Reserved																		
11-8 FFVAL	<p>Fault Input Filter</p> <p>Selects the filter value for the fault inputs.</p> <p>The fault filter is disabled when the value is zero.</p> <p>NOTE: Writing to this field has immediate effect and must be done only when the fault control or all fault inputs are disabled. Failure to do this could result in a missing fault detection.</p>																		
7 FFLTR3EN	<p>Fault Input 3 Filter Enable</p> <p>Enables the filter for the fault input.</p> <p>This field is write protected. It can be written only when MODE[WPDIS] = 1.</p> <p>NOTE: This field is not supported in every instance. The following table includes only supported registers.</p> <table border="1" style="margin-left: auto; margin-right: auto;"> <thead> <tr> <th>Field supported in</th> <th>Field not supported in</th> </tr> </thead> <tbody> <tr> <td>FTM0_FLTCTRL</td> <td>—</td> </tr> <tr> <td>FTM1_FLTCTRL</td> <td>—</td> </tr> <tr> <td>FTM2_FLTCTRL</td> <td>—</td> </tr> <tr> <td>FTM3_FLTCTRL</td> <td>—</td> </tr> <tr> <td>—</td> <td>FTM4_FLTCTRL</td> </tr> <tr> <td>—</td> <td>FTM5_FLTCTRL</td> </tr> <tr> <td>—</td> <td>FTM6_FLTCTRL</td> </tr> <tr> <td>—</td> <td>FTM7_FLTCTRL</td> </tr> </tbody> </table> <p>0b - Fault input filter is disabled. 1b - Fault input filter is enabled.</p>	Field supported in	Field not supported in	FTM0_FLTCTRL	—	FTM1_FLTCTRL	—	FTM2_FLTCTRL	—	FTM3_FLTCTRL	—	—	FTM4_FLTCTRL	—	FTM5_FLTCTRL	—	FTM6_FLTCTRL	—	FTM7_FLTCTRL
Field supported in	Field not supported in																		
FTM0_FLTCTRL	—																		
FTM1_FLTCTRL	—																		
FTM2_FLTCTRL	—																		
FTM3_FLTCTRL	—																		
—	FTM4_FLTCTRL																		
—	FTM5_FLTCTRL																		
—	FTM6_FLTCTRL																		
—	FTM7_FLTCTRL																		
6 FFLTR2EN	<p>Fault Input 2 Filter Enable</p> <p>Enables the filter for the fault input.</p> <p>This field is write protected. It can be written only when MODE[WPDIS] = 1.</p> <p>NOTE: This field is not supported in every instance. The following table includes only supported registers.</p>																		

Table continues on the next page...

Field	Function																			
	<table border="1"> <thead> <tr> <th>Field supported in</th> <th>Field not supported in</th> </tr> </thead> <tbody> <tr> <td>FTM0_FLTCTRL</td> <td>—</td> </tr> <tr> <td>FTM1_FLTCTRL</td> <td>—</td> </tr> <tr> <td>FTM2_FLTCTRL</td> <td>—</td> </tr> <tr> <td>FTM3_FLTCTRL</td> <td>—</td> </tr> <tr> <td>—</td> <td>FTM4_FLTCTRL</td> </tr> <tr> <td>—</td> <td>FTM5_FLTCTRL</td> </tr> <tr> <td>—</td> <td>FTM6_FLTCTRL</td> </tr> <tr> <td>—</td> <td>FTM7_FLTCTRL</td> </tr> </tbody> </table> <p>0b - Fault input filter is disabled. 1b - Fault input filter is enabled.</p>	Field supported in	Field not supported in	FTM0_FLTCTRL	—	FTM1_FLTCTRL	—	FTM2_FLTCTRL	—	FTM3_FLTCTRL	—	—	FTM4_FLTCTRL	—	FTM5_FLTCTRL	—	FTM6_FLTCTRL	—	FTM7_FLTCTRL	
Field supported in	Field not supported in																			
FTM0_FLTCTRL	—																			
FTM1_FLTCTRL	—																			
FTM2_FLTCTRL	—																			
FTM3_FLTCTRL	—																			
—	FTM4_FLTCTRL																			
—	FTM5_FLTCTRL																			
—	FTM6_FLTCTRL																			
—	FTM7_FLTCTRL																			
5 FFLTR1EN	<p>Fault Input 1 Filter Enable</p> <p>Enables the filter for the fault input.</p> <p>This field is write protected. It can be written only when MODE[WPDIS] = 1.</p> <p>0b - Fault input filter is disabled. 1b - Fault input filter is enabled.</p>																			
4 FFLTR0EN	<p>Fault Input 0 Filter Enable</p> <p>Enables the filter for the fault input.</p> <p>This field is write protected. It can be written only when MODE[WPDIS] = 1.</p> <p>0b - Fault input filter is disabled. 1b - Fault input filter is enabled.</p>																			
3 FAULT3EN	<p>Fault Input 3 Enable</p> <p>Enables the fault input.</p> <p>This field is write protected. It can be written only when MODE[WPDIS] = 1.</p> <p>NOTE: This field is not supported in every instance. The following table includes only supported registers.</p> <table border="1"> <thead> <tr> <th>Field supported in</th> <th>Field not supported in</th> </tr> </thead> <tbody> <tr> <td>FTM0_FLTCTRL</td> <td>—</td> </tr> <tr> <td>FTM1_FLTCTRL</td> <td>—</td> </tr> <tr> <td>FTM2_FLTCTRL</td> <td>—</td> </tr> <tr> <td>FTM3_FLTCTRL</td> <td>—</td> </tr> <tr> <td>—</td> <td>FTM4_FLTCTRL</td> </tr> <tr> <td>—</td> <td>FTM5_FLTCTRL</td> </tr> <tr> <td>—</td> <td>FTM6_FLTCTRL</td> </tr> <tr> <td>—</td> <td>FTM7_FLTCTRL</td> </tr> </tbody> </table> <p>0b - Fault input is disabled. 1b - Fault input is enabled.</p>		Field supported in	Field not supported in	FTM0_FLTCTRL	—	FTM1_FLTCTRL	—	FTM2_FLTCTRL	—	FTM3_FLTCTRL	—	—	FTM4_FLTCTRL	—	FTM5_FLTCTRL	—	FTM6_FLTCTRL	—	FTM7_FLTCTRL
Field supported in	Field not supported in																			
FTM0_FLTCTRL	—																			
FTM1_FLTCTRL	—																			
FTM2_FLTCTRL	—																			
FTM3_FLTCTRL	—																			
—	FTM4_FLTCTRL																			
—	FTM5_FLTCTRL																			
—	FTM6_FLTCTRL																			
—	FTM7_FLTCTRL																			
2 FAULT2EN	<p>Fault Input 2 Enable</p> <p>Enables the fault input.</p>																			

Table continues on the next page...

Memory map and register definition

Field	Function																		
	<p>This field is write protected. It can be written only when MODE[WPDIS] = 1.</p> <p>NOTE: This field is not supported in every instance. The following table includes only supported registers.</p> <table border="1"> <thead> <tr> <th>Field supported in</th> <th>Field not supported in</th> </tr> </thead> <tbody> <tr> <td>FTM0_FLTCTRL</td> <td>—</td> </tr> <tr> <td>FTM1_FLTCTRL</td> <td>—</td> </tr> <tr> <td>FTM2_FLTCTRL</td> <td>—</td> </tr> <tr> <td>FTM3_FLTCTRL</td> <td>—</td> </tr> <tr> <td>—</td> <td>FTM4_FLTCTRL</td> </tr> <tr> <td>—</td> <td>FTM5_FLTCTRL</td> </tr> <tr> <td>—</td> <td>FTM6_FLTCTRL</td> </tr> <tr> <td>—</td> <td>FTM7_FLTCTRL</td> </tr> </tbody> </table> <p>0b - Fault input is disabled. 1b - Fault input is enabled.</p>	Field supported in	Field not supported in	FTM0_FLTCTRL	—	FTM1_FLTCTRL	—	FTM2_FLTCTRL	—	FTM3_FLTCTRL	—	—	FTM4_FLTCTRL	—	FTM5_FLTCTRL	—	FTM6_FLTCTRL	—	FTM7_FLTCTRL
Field supported in	Field not supported in																		
FTM0_FLTCTRL	—																		
FTM1_FLTCTRL	—																		
FTM2_FLTCTRL	—																		
FTM3_FLTCTRL	—																		
—	FTM4_FLTCTRL																		
—	FTM5_FLTCTRL																		
—	FTM6_FLTCTRL																		
—	FTM7_FLTCTRL																		
1 FAULT1EN	<p>Fault Input 1 Enable</p> <p>Enables the fault input.</p> <p>This field is write protected. It can be written only when MODE[WPDIS] = 1.</p> <p>0b - Fault input is disabled. 1b - Fault input is enabled.</p>																		
0 FAULT0EN	<p>Fault Input 0 Enable</p> <p>Enables the fault input.</p> <p>This field is write protected. It can be written only when MODE[WPDIS] = 1.</p> <p>0b - Fault input is disabled. 1b - Fault input is enabled.</p>																		

47.4.3.20 Quadrature Decoder Control And Status (QDCTRL)

47.4.3.20.1 Offset

Register	Offset
QDCTRL	80h

47.4.3.20.2 Function

This register has the control and status bits for the Quadrature Decoder mode.

NOTE

Each module instance supports a different number of registers.

Register supported	Register not supported
—	FTM0_ QDCT RL
FTM1_ QDCT RL	—
FTM2_ QDCT RL	—
—	FTM3_ QDCT RL
FTM4_ QDCT RL	—
—	FTM5_ QDCT RL
—	FTM6_ QDCT RL
—	FTM7_ QDCT RL

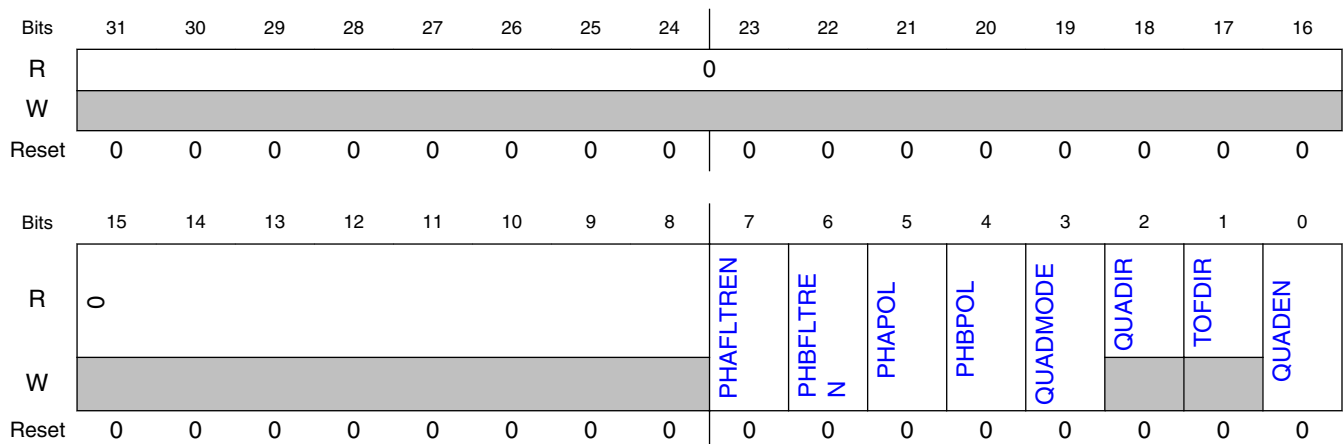
47.4.3.20.3 Diagram

47.4.3.20.4 Fields

Field	Function								
31-8 —	Reserved								
7 PHAFLTREN	<p>Phase A Input Filter Enable</p> <p>Enables the filter for the quadrature decoder phase A input. The filter value for the phase A input is defined by the CH0FVAL field of FILTER. The phase A filter is also disabled when CH0FVAL is zero.</p> <p>NOTE: This field is not supported in every instance. The following table includes only supported registers.</p> <table border="1"> <thead> <tr> <th>Field supported in</th> <th>Field not supported in</th> </tr> </thead> <tbody> <tr> <td>FTM1_QDCTRL</td> <td>—</td> </tr> <tr> <td>FTM2_QDCTRL</td> <td>—</td> </tr> <tr> <td>—</td> <td>FTM4_QDCTRL</td> </tr> </tbody> </table> <p>0b - Phase A input filter is disabled. 1b - Phase A input filter is enabled.</p>	Field supported in	Field not supported in	FTM1_QDCTRL	—	FTM2_QDCTRL	—	—	FTM4_QDCTRL
Field supported in	Field not supported in								
FTM1_QDCTRL	—								
FTM2_QDCTRL	—								
—	FTM4_QDCTRL								
6 PHBFLTREN	<p>Phase B Input Filter Enable</p> <p>Enables the filter for the quadrature decoder phase B input. The filter value for the phase B input is defined by the CH1FVAL field of FILTER. The phase B filter is also disabled when CH1FVAL is zero.</p> <p>NOTE: This field is not supported in every instance. The following table includes only supported registers.</p> <table border="1"> <thead> <tr> <th>Field supported in</th> <th>Field not supported in</th> </tr> </thead> <tbody> <tr> <td>FTM1_QDCTRL</td> <td>—</td> </tr> <tr> <td>FTM2_QDCTRL</td> <td>—</td> </tr> <tr> <td>—</td> <td>FTM4_QDCTRL</td> </tr> </tbody> </table> <p>0b - Phase B input filter is disabled. 1b - Phase B input filter is enabled.</p>	Field supported in	Field not supported in	FTM1_QDCTRL	—	FTM2_QDCTRL	—	—	FTM4_QDCTRL
Field supported in	Field not supported in								
FTM1_QDCTRL	—								
FTM2_QDCTRL	—								
—	FTM4_QDCTRL								
5 PHAPOL	<p>Phase A Input Polarity</p> <p>Selects the polarity for the quadrature decoder phase A input.</p> <p>0b - Normal polarity. Phase A input signal is not inverted before identifying the rising and falling edges of this signal.</p> <p>1b - Inverted polarity. Phase A input signal is inverted before identifying the rising and falling edges of this signal.</p>								
4 PHBPOL	<p>Phase B Input Polarity</p> <p>Selects the polarity for the quadrature decoder phase B input.</p> <p>0b - Normal polarity. Phase B input signal is not inverted before identifying the rising and falling edges of this signal.</p> <p>1b - Inverted polarity. Phase B input signal is inverted before identifying the rising and falling edges of this signal.</p>								
3 QUADMODE	<p>Quadrature Decoder Mode</p> <p>Selects the encoding mode used in the Quadrature Decoder mode.</p> <p>0b - Phase A and phase B encoding mode.</p>								

Table continues on the next page...

Field	Function
	1b - Count and direction encoding mode.
2 QUADIR	FTM Counter Direction In Quadrature Decoder Mode Indicates the counting direction. 0b - Counting direction is decreasing (FTM counter decrement). 1b - Counting direction is increasing (FTM counter increment).
1 TOFDIR	Timer Overflow Direction In Quadrature Decoder Mode Indicates if the TOF bit was set on the top or the bottom of counting. 0b - TOF bit was set on the bottom of counting. There was an FTM counter decrement and FTM counter changes from its minimum value (CNTIN register) to its maximum value (MOD register). 1b - TOF bit was set on the top of counting. There was an FTM counter increment and FTM counter changes from its maximum value (MOD register) to its minimum value (CNTIN register).
0 QUADEN	Quadrature Decoder Mode Enable Enables the Quadrature Decoder mode. In this mode, the phase A and B input signals control the FTM counter direction. The Quadrature Decoder mode has precedence over the other modes. This field is write protected. It can be written only when MODE[WPDIS] = 1. 0b - Quadrature Decoder mode is disabled. 1b - Quadrature Decoder mode is enabled.

47.4.3.21 Configuration (CONF)

47.4.3.21.1 Offset

Register	Offset
CONF	84h

47.4.3.21.2 Function

This register selects the frequency of the reload opportunities, the FTM behavior in Debug mode, the use of an external global time base, and the global time base signal generation.

This register also controls if initialization trigger should be generated when a reload point is reached.

47.4.3.21.3 Diagram

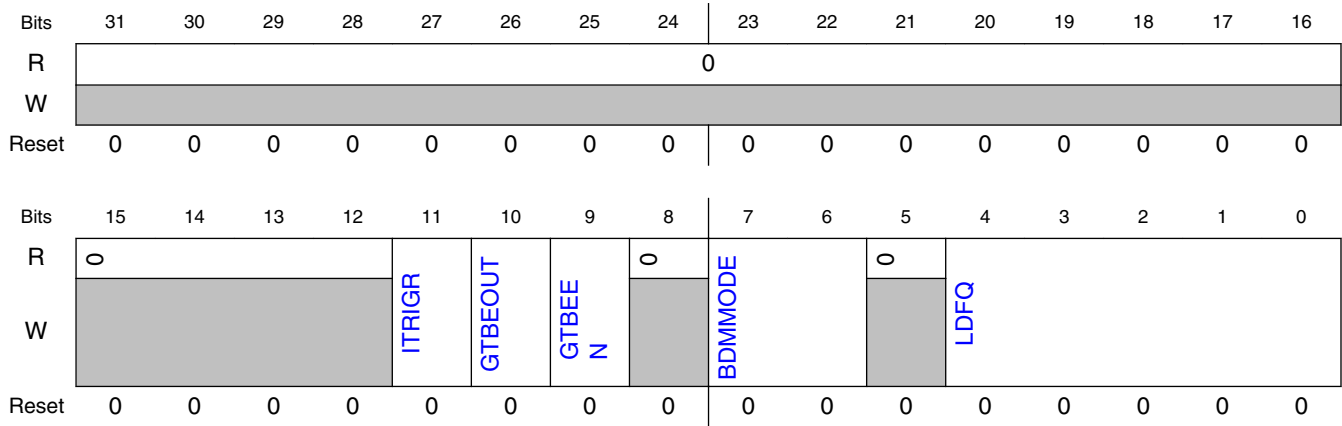

47.4.3.21.4 Fields

Field	Function
31-12 —	Reserved
11 ITRIGR	Initialization trigger on Reload Point This bit controls whether an initialization trigger is generated when a reload point configured by PWMLOAD register is reached considering the FTM_CONF[LDFQ] settings. 0b - Initialization trigger is generated on counter wrap events. 1b - Initialization trigger is generated when a reload point is reached.
10 GTBEOUT	Global Time Base Output Enables the global time base signal generation to other FTMs. 0b - A global time base signal generation is disabled. 1b - A global time base signal generation is enabled.
9 GTBEEN	Global Time Base Enable Configures the FTM to use an external global time base signal that is generated by another FTM. 0b - Use of an external global time base is disabled. 1b - Use of an external global time base is enabled.
8 —	Reserved
7-6 BDMODE	Debug Mode Selects the FTM behavior in Debug mode. See Debug mode .
5 —	Reserved
4-0 LDFQ	Frequency of the Reload Opportunities The LDFQ[4:0] bits define the number of enabled reload opportunities should happen until an enabled reload opportunity becomes a reload point. See Reload Points LDFQ = 0: All reload opportunities are reload points. LDFQ = 1: There is a reload point each 2 reload opportunities.

Field	Function
	LDFQ = 2: There is a reload point each 3 reload oportunities. LDFQ = 3: There is a reload point each 4 reload oportunities. This pattern continues up to a maximum of 32.

47.4.3.22 FTM Fault Input Polarity (FLTPOL)

47.4.3.22.1 Offset

Register	Offset
FLTPOL	88h

47.4.3.22.2 Function

This register defines the fault inputs polarity.

47.4.3.22.3 Diagram

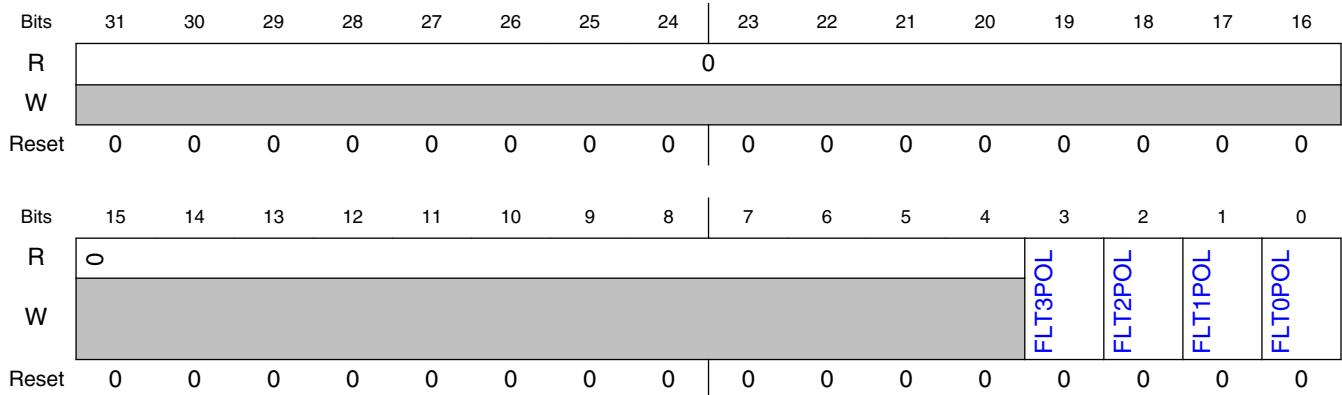

47.4.3.22.4 Fields

Field	Function
31-4	Reserved
—	
3 FLT3POL	Fault Input 3 Polarity Defines the polarity of the fault input. This field is write protected. It can be written only when MODE[WPDIS] = 1.

Table continues on the next page...

Memory map and register definition

Field	Function																		
	<p>NOTE: This field is not supported in every instance. The following table includes only supported registers.</p> <table border="1"> <thead> <tr> <th>Field supported in</th> <th>Field not supported in</th> </tr> </thead> <tbody> <tr> <td>FTM0_FLTPOL</td> <td>—</td> </tr> <tr> <td>FTM1_FLTPOL</td> <td>—</td> </tr> <tr> <td>FTM2_FLTPOL</td> <td>—</td> </tr> <tr> <td>FTM3_FLTPOL</td> <td>—</td> </tr> <tr> <td>—</td> <td>FTM4_FLTPOL</td> </tr> <tr> <td>—</td> <td>FTM5_FLTPOL</td> </tr> <tr> <td>—</td> <td>FTM6_FLTPOL</td> </tr> <tr> <td>—</td> <td>FTM7_FLTPOL</td> </tr> </tbody> </table> <p>0b - The fault input polarity is active high. A 1 at the fault input indicates a fault. 1b - The fault input polarity is active low. A 0 at the fault input indicates a fault.</p>	Field supported in	Field not supported in	FTM0_FLTPOL	—	FTM1_FLTPOL	—	FTM2_FLTPOL	—	FTM3_FLTPOL	—	—	FTM4_FLTPOL	—	FTM5_FLTPOL	—	FTM6_FLTPOL	—	FTM7_FLTPOL
Field supported in	Field not supported in																		
FTM0_FLTPOL	—																		
FTM1_FLTPOL	—																		
FTM2_FLTPOL	—																		
FTM3_FLTPOL	—																		
—	FTM4_FLTPOL																		
—	FTM5_FLTPOL																		
—	FTM6_FLTPOL																		
—	FTM7_FLTPOL																		
2 FLT2POL	<p>Fault Input 2 Polarity Defines the polarity of the fault input.</p> <p>This field is write protected. It can be written only when MODE[WPDIS] = 1.</p> <p>NOTE: This field is not supported in every instance. The following table includes only supported registers.</p> <table border="1"> <thead> <tr> <th>Field supported in</th> <th>Field not supported in</th> </tr> </thead> <tbody> <tr> <td>FTM0_FLTPOL</td> <td>—</td> </tr> <tr> <td>FTM1_FLTPOL</td> <td>—</td> </tr> <tr> <td>FTM2_FLTPOL</td> <td>—</td> </tr> <tr> <td>FTM3_FLTPOL</td> <td>—</td> </tr> <tr> <td>—</td> <td>FTM4_FLTPOL</td> </tr> <tr> <td>—</td> <td>FTM5_FLTPOL</td> </tr> <tr> <td>—</td> <td>FTM6_FLTPOL</td> </tr> <tr> <td>—</td> <td>FTM7_FLTPOL</td> </tr> </tbody> </table> <p>0b - The fault input polarity is active high. A 1 at the fault input indicates a fault. 1b - The fault input polarity is active low. A 0 at the fault input indicates a fault.</p>	Field supported in	Field not supported in	FTM0_FLTPOL	—	FTM1_FLTPOL	—	FTM2_FLTPOL	—	FTM3_FLTPOL	—	—	FTM4_FLTPOL	—	FTM5_FLTPOL	—	FTM6_FLTPOL	—	FTM7_FLTPOL
Field supported in	Field not supported in																		
FTM0_FLTPOL	—																		
FTM1_FLTPOL	—																		
FTM2_FLTPOL	—																		
FTM3_FLTPOL	—																		
—	FTM4_FLTPOL																		
—	FTM5_FLTPOL																		
—	FTM6_FLTPOL																		
—	FTM7_FLTPOL																		
1 FLT1POL	<p>Fault Input 1 Polarity Defines the polarity of the fault input.</p> <p>This field is write protected. It can be written only when MODE[WPDIS] = 1.</p> <p>0b - The fault input polarity is active high. A 1 at the fault input indicates a fault. 1b - The fault input polarity is active low. A 0 at the fault input indicates a fault.</p>																		
0 FLT0POL	<p>Fault Input 0 Polarity Defines the polarity of the fault input.</p> <p>This field is write protected. It can be written only when MODE[WPDIS] = 1.</p> <p>0b - The fault input polarity is active high. A 1 at the fault input indicates a fault. 1b - The fault input polarity is active low. A 0 at the fault input indicates a fault.</p>																		

47.4.3.23 Synchronization Configuration (SYNCONF)

47.4.3.23.1 Offset

Register	Offset
SYNCONF	8Ch

47.4.3.23.2 Function

This register selects the PWM synchronization configuration, SWOCTRL, INVCTRL and CNTIN registers synchronization, if FTM clears the TRIG_j bit, where $j = 0, 1, 2$, when the hardware trigger j is detected.

47.4.3.23.3 Diagram

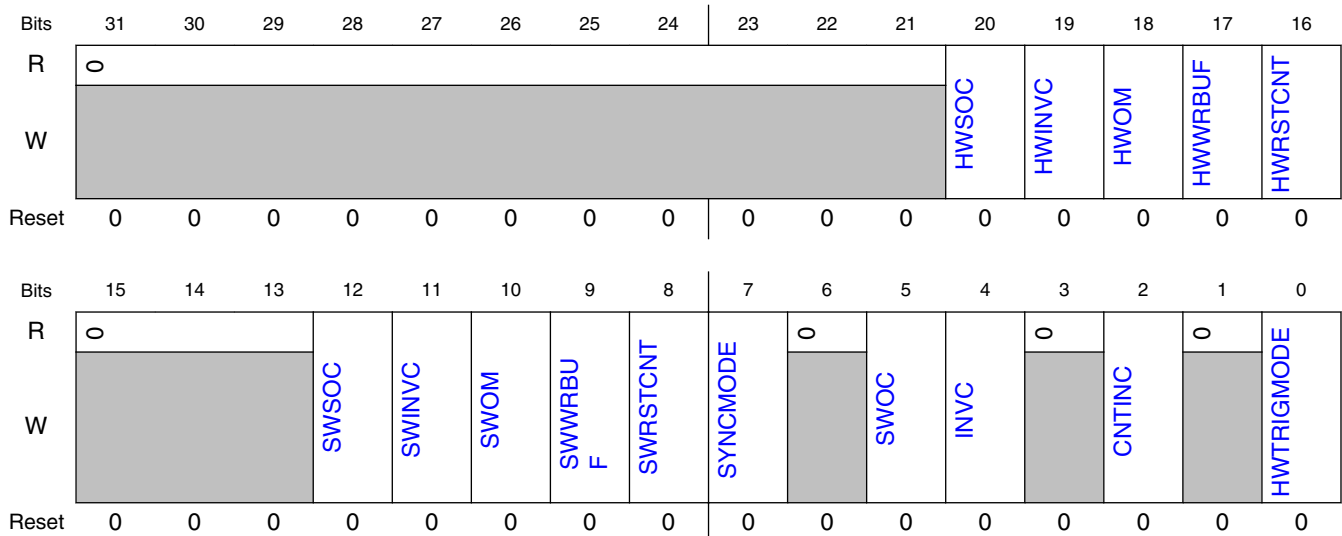

47.4.3.23.4 Fields

Field	Function
31-21	Reserved
—	
20 HWSOC	Software output control synchronization is activated by a hardware trigger 0b - A hardware trigger does not activate the SWOCTRL register synchronization. 1b - A hardware trigger activates the SWOCTRL register synchronization.
19	Inverting control synchronization is activated by a hardware trigger

Table continues on the next page...

Memory map and register definition

Field	Function
HWINVC	0b - A hardware trigger does not activate the INVCTRL register synchronization. 1b - A hardware trigger activates the INVCTRL register synchronization.
18 HWOM	Output mask synchronization is activated by a hardware trigger 0b - A hardware trigger does not activate the OUTMASK register synchronization. 1b - A hardware trigger activates the OUTMASK register synchronization.
17 HWRBUB	MOD, HCR, CNTIN, and CV registers synchronization is activated by a hardware trigger 0b - A hardware trigger does not activate MOD, HCR, CNTIN, and CV registers synchronization. 1b - A hardware trigger activates MOD, HCR, CNTIN, and CV registers synchronization.
16 HWRSTCNT	FTM counter synchronization is activated by a hardware trigger 0b - A hardware trigger does not activate the FTM counter synchronization. 1b - A hardware trigger activates the FTM counter synchronization.
15-13 —	Reserved
12 SWSOC	Software output control synchronization is activated by the software trigger 0b - The software trigger does not activate the SWOCTRL register synchronization. 1b - The software trigger activates the SWOCTRL register synchronization.
11 SWINVC	Inverting control synchronization is activated by the software trigger 0b - The software trigger does not activate the INVCTRL register synchronization. 1b - The software trigger activates the INVCTRL register synchronization.
10 SWOM	Output mask synchronization is activated by the software trigger 0b - The software trigger does not activate the OUTMASK register synchronization. 1b - The software trigger activates the OUTMASK register synchronization.
9 SWRUBUF	MOD, HCR, CNTIN, and CV registers synchronization is activated by the software trigger 0b - The software trigger does not activate MOD, HCR, CNTIN, and CV registers synchronization. 1b - The software trigger activates MOD, HCR, CNTIN, and CV registers synchronization.
8 SWRSTCNT	FTM counter synchronization is activated by the software trigger 0b - The software trigger does not activate the FTM counter synchronization. 1b - The software trigger activates the FTM counter synchronization.
7 SYNCMODE	Synchronization Mode Selects the PWM Synchronization mode. 0b - Legacy PWM synchronization is selected. 1b - Enhanced PWM synchronization is selected.
6 —	Reserved
5 SWOC	SWOCTRL Register Synchronization 0b - SWOCTRL register is updated with its buffer value at all rising edges of FTM input clock. 1b - SWOCTRL register is updated with its buffer value by the PWM synchronization.
4 INVC	INVCTRL Register Synchronization 0b - INVCTRL register is updated with its buffer value at all rising edges of FTM input clock. 1b - INVCTRL register is updated with its buffer value by the PWM synchronization.
3 —	Reserved
2 CNTINC	CNTIN Register Synchronization 0b - CNTIN register is updated with its buffer value at all rising edges of FTM input clock. 1b - CNTIN register is updated with its buffer value by the PWM synchronization.
1 —	Reserved
0	Hardware Trigger Mode

Field	Function
HWTRIGMODE	0b - FTM clears the TRIGj bit when the hardware trigger j is detected, where j = 0, 1,2. 1b - FTM does not clear the TRIGj bit when the hardware trigger j is detected, where j = 0, 1,2.

47.4.3.24 FTM Inverting Control (INVCTRL)

47.4.3.24.1 Offset

Register	Offset
INVCTRL	90h

47.4.3.24.2 Function

This register controls when the channel (n) output becomes the channel (n+1) output, and channel (n+1) output becomes the channel (n) output. Each INVmEN bit enables the inverting operation for the corresponding pair channels m.

This register has a write buffer. The INVmEN bit is updated by the INVCTRL register synchronization.

47.4.3.24.3 Diagram

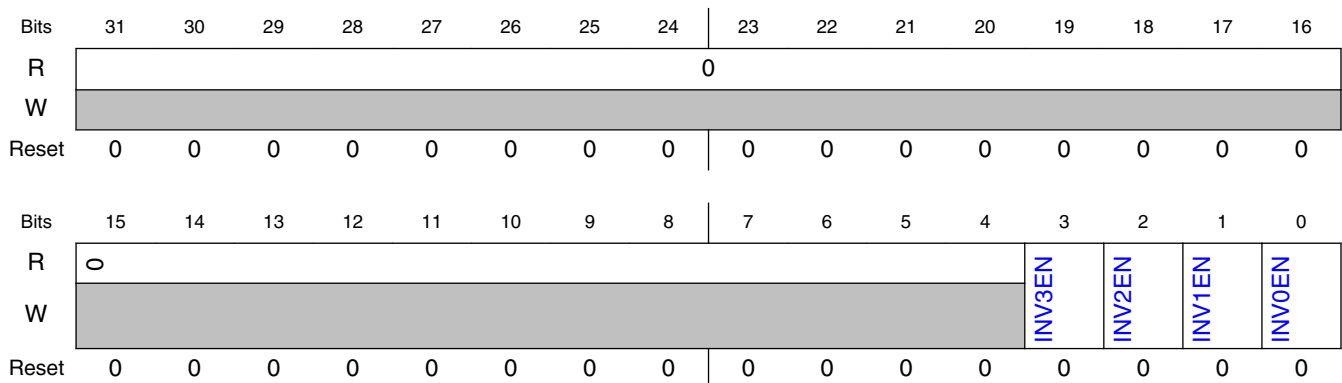

47.4.3.24.4 Fields

Field	Function
31-4	Reserved

Table continues on the next page...

Memory map and register definition

Field	Function
—	
3 INV3EN	Pair Channels 3 Inverting Enable 0b - Inverting is disabled. 1b - Inverting is enabled.
2 INV2EN	Pair Channels 2 Inverting Enable 0b - Inverting is disabled. 1b - Inverting is enabled.
1 INV1EN	Pair Channels 1 Inverting Enable 0b - Inverting is disabled. 1b - Inverting is enabled.
0 INV0EN	Pair Channels 0 Inverting Enable 0b - Inverting is disabled. 1b - Inverting is enabled.

47.4.3.25 FTM Software Output Control (SWOCTRL)

47.4.3.25.1 Offset

Register	Offset
SWOCTRL	94h

47.4.3.25.2 Function

This register enables software control of channel (n) output and defines the value forced to the channel (n) output:

- The CH(n)OC bits enable the control of the corresponding channel (n) output by software.
- The CH(n)OCV bits select the value that is forced at the corresponding channel (n) output.

This register has a write buffer. The fields are updated by the SWOCTRL register synchronization.

47.4.3.25.3 Diagram

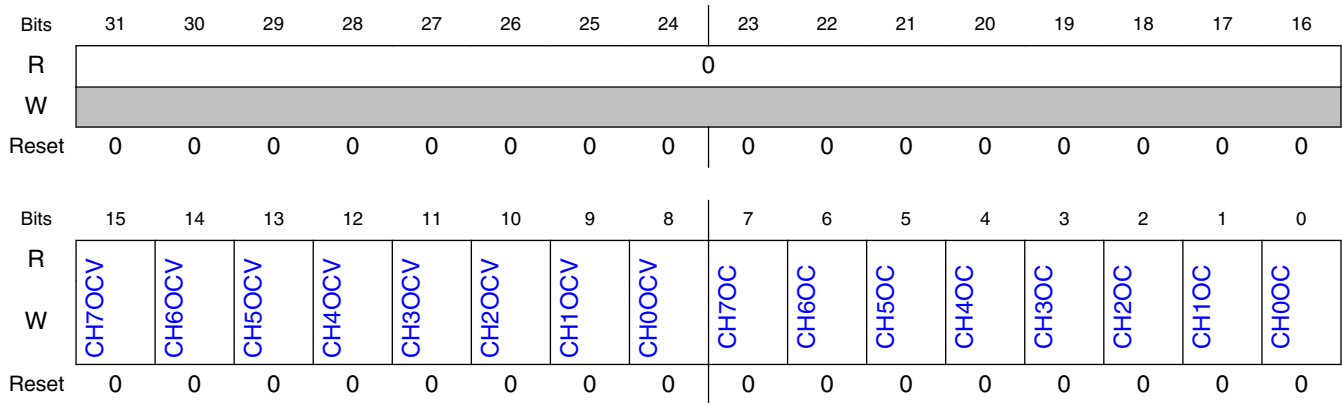

47.4.3.25.4 Fields

Field	Function
31-16 —	Reserved
15-8 CHnOCV	Channel n Software Output Control Value 0b - The software output control forces 0 to the channel output. 1b - The software output control forces 1 to the channel output.
7-0 CHnOC	Channel n Software Output Control Enable 0b - The channel output is not affected by software output control. 1b - The channel output is affected by software output control.

47.4.3.26 FTM PWM Load (PWMLOAD)

47.4.3.26.1 Offset

Register	Offset
PWMLOAD	98h

47.4.3.26.2 Function

Enables the reload of the MOD, HCR, CNTIN, C(n)V, and C(n+1)V registers with the values of their write buffers when the FTM counter changes from the MOD register value to its next value or when a channel (j) match occurs. A match occurs for channel (j) when FTM counter = C(j)V. A reload can also occur when FTM counter = HCR register at a half cycle match. This register also controls the local and global load mechanisms.

47.4.3.26.3 Diagram

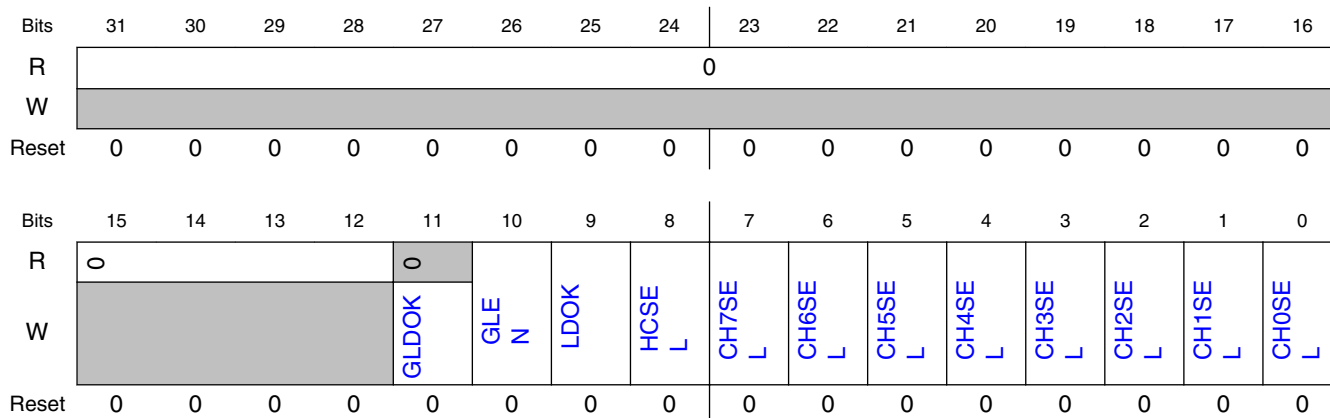

47.4.3.26.4 Fields

Field	Function
31-12 —	Reserved
11 GLDOK	<p>Global Load OK</p> <p>This bit controls the global load mechanism. It generates a pulse at FTM module global load output with one FTM clock cycle width, which is used to set LDOK bits of FTM and other modules (including other FTMs). This bit is self-cleared and read value is always zero.</p> <p>The global load mechanism depends on SoC specific information. Refer to FTM SoC specific information to more details.</p> <p>0b - No action. 1b - LDOK bit is set.</p>
10 GLEN	<p>Global Load Enable</p> <p>This bit enables the global load mechanism implemented by GLDOK. If GLEN bit is set, then an external event on the FTM global load input sets the LDOK bit. The clear of the LDOK bit is done by CPU writes '0' to the bit.</p> <p>0b - Global Load Ok disabled. 1b - Global Load OK enabled. A pulse event on the module global load input sets the LDOK bit.</p>
9 LDOK	<p>Load Enable</p> <p>Enables the loading of the MOD, CNTIN, HCR and CV registers with the values of their buffers.</p> <p>The LDOK bit can also be set by the Global Load mechanism if GLEN bit is enabled.</p> <p>0b - Loading updated values is disabled. 1b - Loading updated values is enabled.</p>
8 HCSEL	<p>Half Cycle Select</p> <p>This bit enables the half cycle match as a reload opportunity. A half cycle is defined by when the FTM counter matches the HCR register.</p> <p>0b - Half cycle reload is disabled and it is not considered as a reload opportunity. 1b - Half cycle reload is enabled and it is considered as a reload opportunity.</p>

Table continues on the next page...

Field	Function
7-0 CHnSEL	Channel n Select 0b - Channel match is not included as a reload opportunity. 1b - Channel match is included as a reload opportunity.

47.4.3.27 Half Cycle Register (HCR)

47.4.3.27.1 Offset

Register	Offset
HCR	9Ch

47.4.3.27.2 Function

The Half Cycle Register contains the match value for FTM half cycle reload feature. After FTM counter reaches this value, a reload opportunity is generated if FTM_PWMLOAD[HCSEL] is enabled.

Writing to the HCR register latches the value into a buffer. The HCR register is updated with the value of its write buffer according to [Registers updated from write buffers](#).

47.4.3.27.3 Diagram

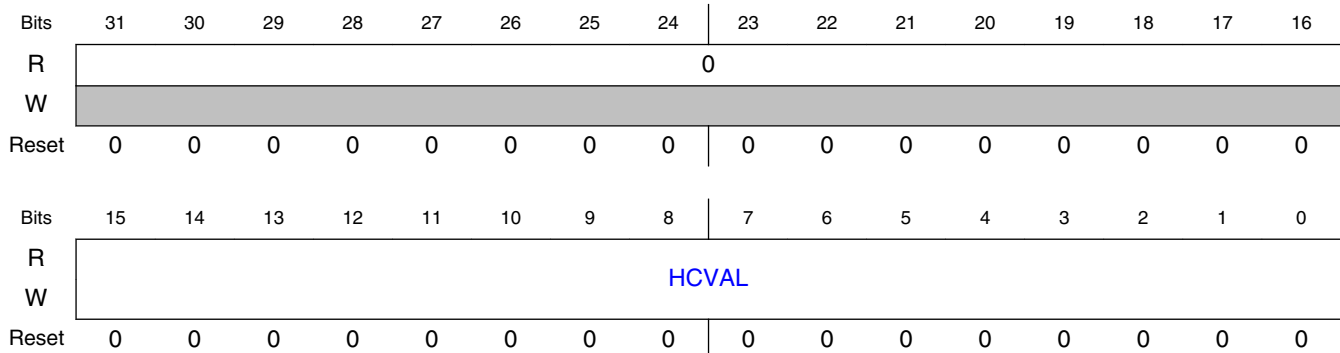

47.4.3.27.4 Fields

Field	Function
31-16	Reserved

Table continues on the next page...

Memory map and register definition

Field	Function
—	
15-0 HCVAl	Half Cycle Value

47.4.3.28 Pair 0 Deadtime Configuration (PAIR0DEADTIME)

47.4.3.28.1 Offset

Register	Offset
PAIR0DEADTIME	A0h

47.4.3.28.2 Function

This register selects the deadtime prescaler and value for the pair 0.

47.4.3.28.3 Diagram

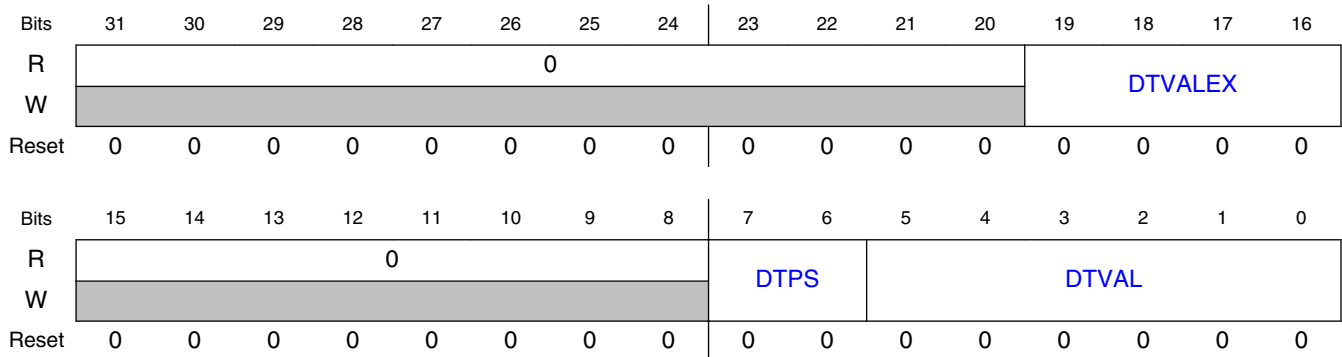

47.4.3.28.4 Fields

Field	Function
31-20 —	Reserved
19-16 DTVAlEX	Extended Deadtime Value This field is a bit extension of the DTVAL field. It defines the 4 most significant bits of the deadtime value. The maximum deadtime value is extended to 1023 using the concatenation {DTVAlEX, DTVAL}. Deadtime insert value = (DTPS × {DTVAlEX, DTVAL}).

Table continues on the next page...

Field	Function
	This field is write protected. It can be written only when MODE[WPDIS] = 1.
15-8 —	Reserved
7-6 DTPS	Deadtime Prescaler Value Selects the division factor of the FTM input clock. This prescaled clock is used by the deadtime counter. This field is write protected. It can be written only when MODE[WPDIS] = 1. 0xb - Divide the FTM input clock by 1. 10b - Divide the FTM input clock by 4. 11b - Divide the FTM input clock by 16.
5-0 DTVAL	Deadtime Value Selects the deadtime value. This field is write protected. It can be written only when MODE[WPDIS] = 1.

47.4.3.29 Pair 1 Deadtime Configuration (PAIR1DEADTIME)

47.4.3.29.1 Offset

Register	Offset
PAIR1DEADTIME	A8h

47.4.3.29.2 Function

This register selects the deadtime prescaler and value for the pair 1.

47.4.3.29.3 Diagram

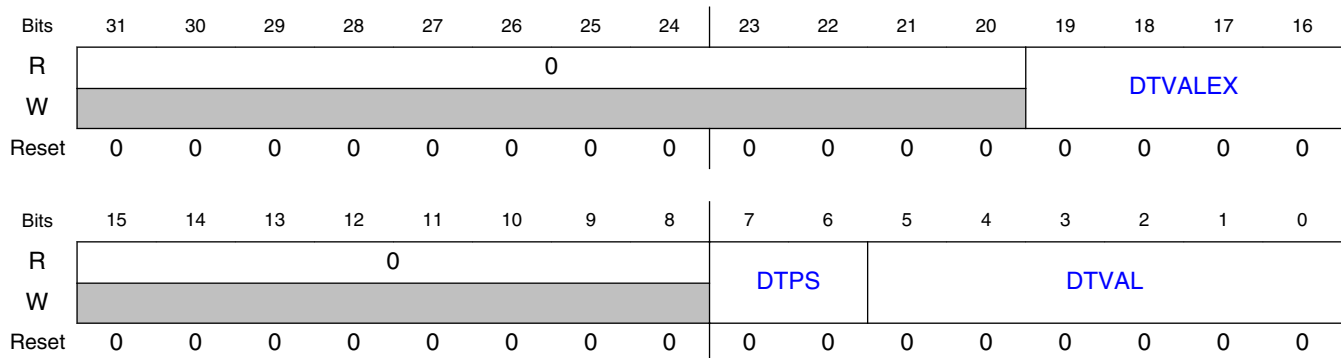

47.4.3.29.4 Fields

Field	Function
31-20 —	Reserved
19-16 DTVALEX	<p>Extended Deadtime Value</p> <p>This field is a bit extension of the DTVAL field. It defines the 4 most significant bits of the deadtime value. The maximum deadtime value is extended to 1023 using the concatenation {DTVALEX, DTVAL}.</p> <p>Deadtime insert value = (DTPS × {DTVALEX, DTVAL}).</p> <p>This field is write protected. It can be written only when MODE[WPDIS] = 1.</p>
15-8 —	Reserved
7-6 DTPS	<p>Deadtime Prescaler Value</p> <p>Selects the division factor of the FTM input clock. This prescaled clock is used by the deadtime counter.</p> <p>This field is write protected. It can be written only when MODE[WPDIS] = 1.</p> <p>0xb - Divide the FTM input clock by 1. 10b - Divide the FTM input clock by 4. 11b - Divide the FTM input clock by 16.</p>
5-0 DTVAL	<p>Deadtime Value</p> <p>Selects the deadtime value.</p> <p>This field is write protected. It can be written only when MODE[WPDIS] = 1.</p>

47.4.3.30 Pair 2 Deadtime Configuration (PAIR2DEADTIME)

47.4.3.30.1 Offset

Register	Offset
PAIR2DEADTIME	B0h

47.4.3.30.2 Function

This register selects the deadtime prescaler and value for the pair 2.

47.4.3.30.3 Diagram

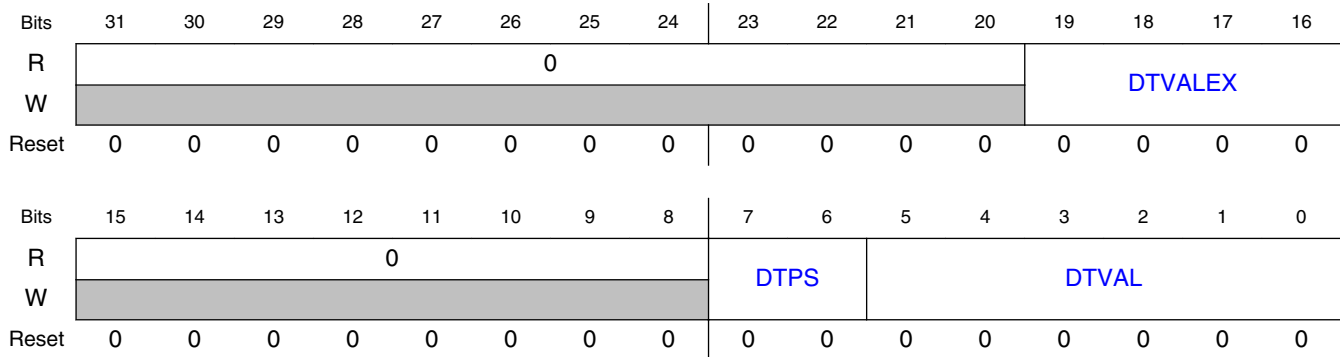

47.4.3.30.4 Fields

Field	Function
31-20 —	Reserved
19-16 DTVALEX	<p>Extended Deadtime Value</p> <p>This field is a bit extension of the DTVAL field. It defines the 4 most significant bits of the deadtime value. The maximum deadtime value is extended to 1023 using the concatenation {DTVALEX, DTVAL}.</p> <p>Deadtime insert value = (DTPS × {DTVALEX, DTVAL}).</p> <p>This field is write protected. It can be written only when MODE[WPDIS] = 1.</p>
15-8 —	Reserved
7-6 DTPS	<p>Deadtime Prescaler Value</p> <p>Selects the division factor of the FTM input clock. This prescaled clock is used by the deadtime counter.</p> <p>This field is write protected. It can be written only when MODE[WPDIS] = 1.</p> <p>0xb - Divide the FTM input clock by 1. 10b - Divide the FTM input clock by 4. 11b - Divide the FTM input clock by 16.</p>
5-0 DTVAL	<p>Deadtime Value</p> <p>Selects the deadtime value.</p> <p>This field is write protected. It can be written only when MODE[WPDIS] = 1.</p>

47.4.3.31 Pair 3 Deadtime Configuration (PAIR3DEADTIME)

47.4.3.31.1 Offset

Register	Offset
PAIR3DEADTIME	B8h

47.4.3.31.2 Function

This register selects the deadtime prescaler and value for the pair 3.

47.4.3.31.3 Diagram

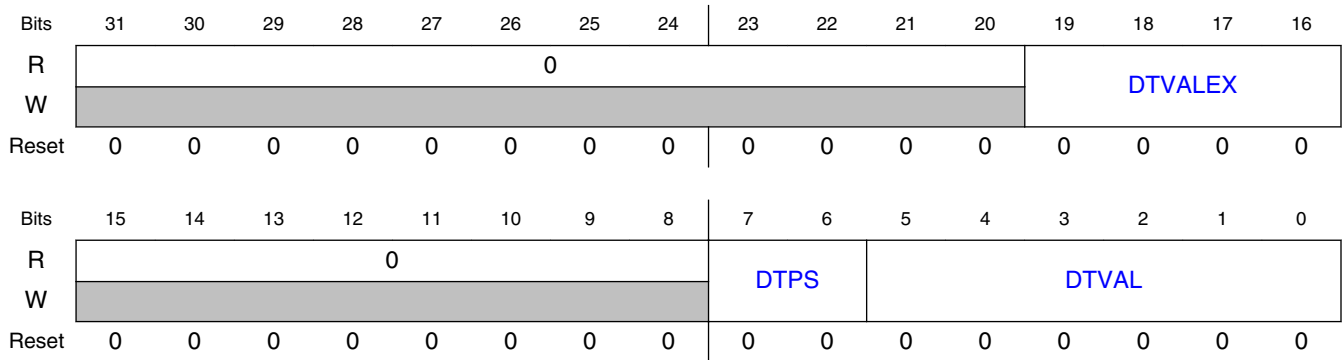

47.4.3.31.4 Fields

Field	Function
31-20 —	Reserved
19-16 DTVALEX	Extended Deadtime Value This field is a bit extension of the DTVAL field. It defines the 4 most significant bits of the deadtime value. The maximum deadtime value is extended to 1023 using the concatenation {DTVALEX, DTVAL}. Deadtime insert value = (DTPS × {DTVALEX, DTVAL}). This field is write protected. It can be written only when MODE[WPDIS] = 1.
15-8 —	Reserved
7-6 DTPS	Deadtime Prescaler Value Selects the division factor of the FTM input clock. This prescaled clock is used by the deadtime counter. This field is write protected. It can be written only when MODE[WPDIS] = 1. 0xb - Divide the FTM input clock by 1. 10b - Divide the FTM input clock by 4. 11b - Divide the FTM input clock by 16.
5-0	Deadtime Value

Field	Function
DTVAL	Selects the deadtime value. This field is write protected. It can be written only when MODE[WPDIS] = 1.

47.4.3.32 Mirror of Modulo Value (MOD_MIRROR)

47.4.3.32.1 Offset

Register	Offset
MOD_MIRROR	200h

47.4.3.32.2 Function

This register contains the integer and fractional modulo value for the FTM counter.

NOTE

Each module instance supports a different number of registers.

Register supported	Register not supported
—	FTM0_ MOD_ MIRR OR
FTM1_ MOD_ MIRR OR	—
FTM2_ MOD_ MIRR OR	—
—	FTM3_ MOD_ MIRR OR
—	FTM4_ MOD_ MIRR OR

Table continues on the next page...

Memory map and register definition

Register supported	Register not supported
—	FTM5_ MOD_ MIRR OR
—	FTM6_ MOD_ MIRR OR
—	FTM7_ MOD_ MIRR OR

47.4.3.32.3 Diagram

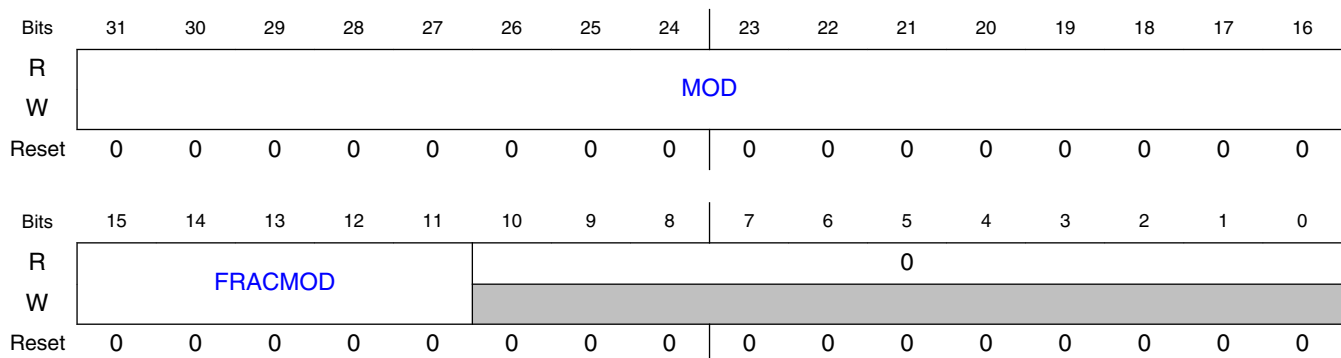

47.4.3.32.4 Fields

Field	Function
31-16 MOD	Mirror of the Modulo Integer Value See the field MOD of the register MOD.
15-11 FRACMOD	Modulo Fractional Value The modulo fractional value is used in the PWM period dithering. This value is added to an internal accumulator at the end of each PWM period. Writes to the field FRACMOD are done on its write buffer. The FRACMOD is updated with its write buffer value according to Registers updated from write buffers . If FTMEN = 0, a write to SC register resets manually this write coherency mechanism.
10-0 —	Reserved

47.4.3.33 Mirror of Channel (n) Match Value (C0V_MIRROR - C7V_MIRROR)

47.4.3.33.1 Offset

For a = 0 to 7:

Register	Offset
CaV_MIRROR	204h + (a × 4h)

47.4.3.33.2 Function

This register contains the integer and fractional value of the channel (n) match.

NOTE

Each module instance supports a different number of registers.

Register supported	Register not supported
—	FTM0_C 0V_ MIRR OR- C7V_ MIRR OR
FTM1_C 0V_ MIRR OR- C7V_ MIRR OR	—
FTM2_C 0V_ MIRR OR- C7V_ MIRR OR	—
—	FTM3_C 0V_ MIRR OR- C7V_ MIRR OR

Table continues on the next page...

Memory map and register definition

Register supported	Register not supported
—	FTM4_C 0V_ MIRR OR- C7V_ MIRR OR
—	FTM5_C 0V_ MIRR OR- C7V_ MIRR OR
—	FTM6_C 0V_ MIRR OR- C7V_ MIRR OR
—	FTM7_C 0V_ MIRR OR- C7V_ MIRR OR

47.4.3.33.3 Diagram

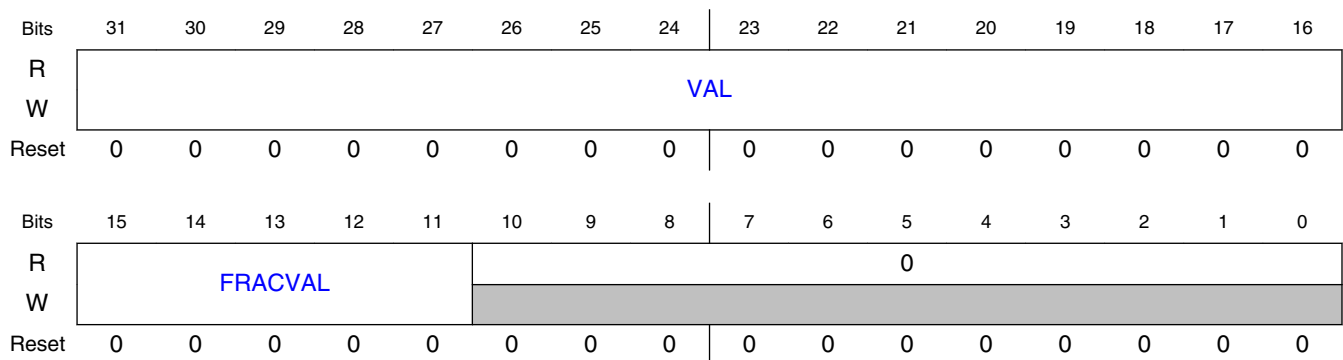

47.4.3.33.4 Fields

Field	Function
31-16	Mirror of the Channel (n) Match Integer Value

Table continues on the next page...

Field	Function
VAL	See the field VAL of the register CnV.
15-11 FRACVAL	Channel (n) Match Fractional Value The channel (n) match fractional value is used in the PWM edge dithering. This value is added to the channel (n) internal accumulator at the end of each PWM period. Writes to the field FRACVAL are done on its write buffer. The FRACVAL is updated with its write buffer value according to Registers updated from write buffers . If FTMEN = 0, a write to CnSC register resets manually this write coherency mechanism.
10-0 —	Reserved

47.5 Functional Description

47.5.1 Clock source

The FTM has only one clock domain: the FTM input clock.

47.5.1.1 Counter clock source

The CLKS[1:0] bits select one of three possible clock sources for the FTM counter or disable the FTM counter. After any chip reset, CLKS[1:0] = 0:0 so no clock source is selected.

The CLKS[1:0] bits may be read or written at any time. Disabling the FTM counter by writing 0:0 to the CLKS[1:0] bits does not affect the FTM counter value or other registers.

The fixed frequency clock is an alternative clock source for the FTM counter that allows the selection of a clock other than the FTM input clock or an external clock. This clock input is defined by chip integration. Refer to the chip specific documentation for further information. Due to FTM hardware implementation limitations, the frequency of the fixed frequency clock must not exceed 1/2 of the FTM input clock frequency.

The external clock passes through a synchronizer clocked by the FTM input clock to assure that counter transitions are properly aligned to FTM input clock transitions. Therefore, to meet Nyquist criteria considering also jitter, the frequency of the external clock source must not exceed 1/4 of the FTM input clock frequency.

47.5.2 Prescaler

The selected counter clock source passes through a prescaler that is a 7-bit counter. The value of the prescaler is selected by the PS[2:0] bits. The following figure shows an example of the prescaler counter and FTM counter.

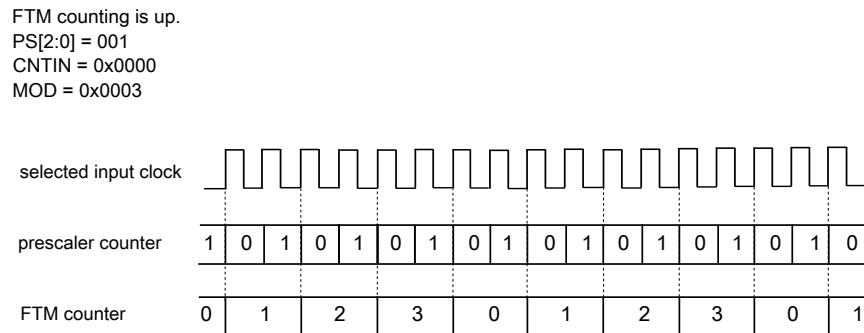

Figure 47-7. Example of the prescaler counter

47.5.3 Counter

The FTM has a 16-bit counter that is used by the channels either for input or output modes. The FTM counter clock is the selected clock divided by the prescaler.

The FTM counter has these modes of operation:

- [Up counting](#)
- [Up-down counting](#)
- [Quadrature Decoder Mode](#)

47.5.3.1 Up counting

Up counting is selected when:

- QUADEN = 0, and
- CPWMS = 0

CNTIN defines the starting value of the count and MOD defines the final value of the count, see the following figure. The value of CNTIN is loaded into the FTM counter, and the counter increments until the value of MOD is reached, at which point the counter is reloaded with the value of CNTIN.

The FTM period when using up counting is $(MOD - CNTIN + 0x0001) \times$ period of the FTM counter clock.

The TOF bit is set when the FTM counter changes from MOD to CNTIN.

A counter event happens at the same time of TOF bit set when the FTM counter changes from MOD to CNTIN. See [Counter events](#) for more details.

FTM counting is up.
 CNTIN = 0xFFFFC (in two's complement is equal to -4)
 MOD = 0x0004

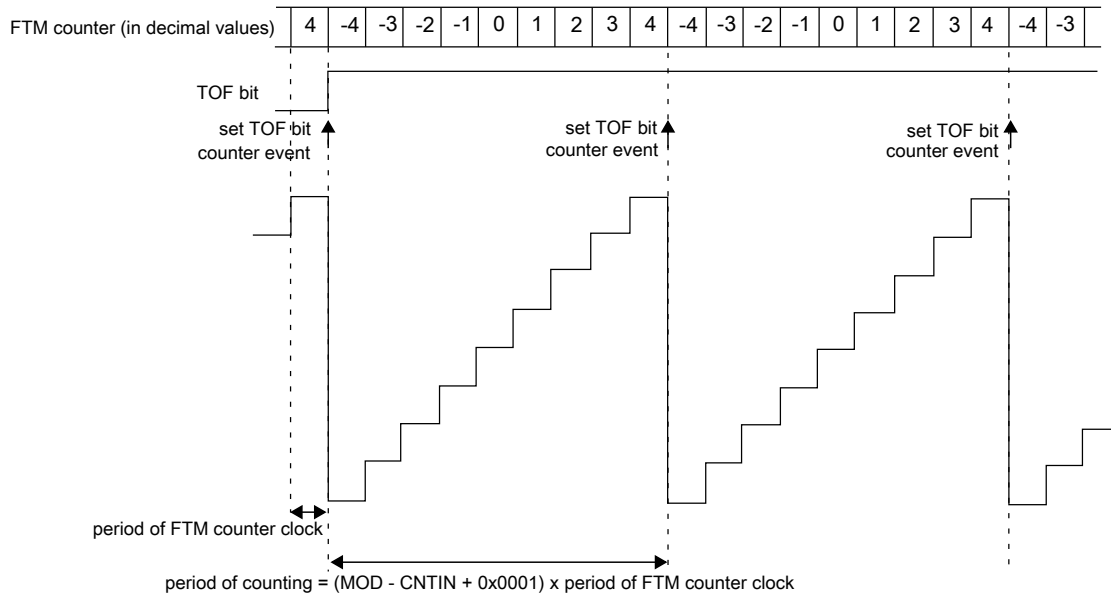

Figure 47-8. Example of FTM up and signed counting

Table 47-3. FTM counting based on CNTIN value

When	Then
CNTIN = 0x0000	The FTM counting is equivalent to TPM up counting, that is, up and unsigned counting. See the following figure.
CNTIN[15] = 1	The initial value of the FTM counter is a negative number in two's complement, so the FTM counting is up and signed.
CNTIN[15] = 0 and CNTIN ≠ 0x0000	The initial value of the FTM counter is a positive number, so the FTM counting is up and unsigned.

Functional Description

FTM counting is up

CNTIN = 0x0000

MOD = 0x0004

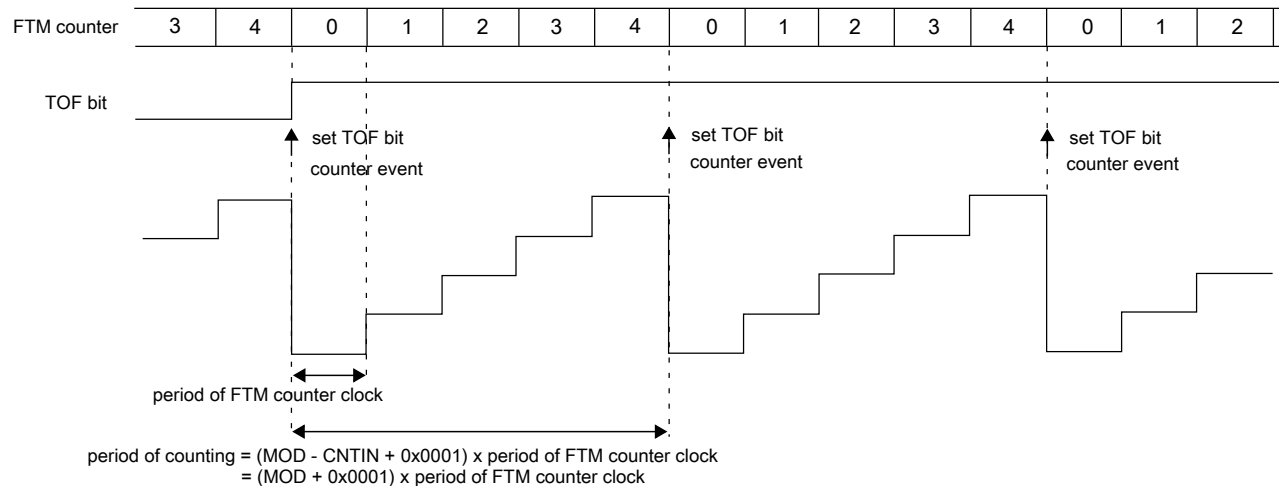

Figure 47-9. Example of FTM up counting with CNTIN = 0x0000

Note

- FTM operation is only valid when the value of the CNTIN register is less than the value of the MOD register, either in the unsigned counting or signed counting. It is the responsibility of the software to ensure that the values in the CNTIN and MOD registers meet this requirement. Any values of CNTIN and MOD that do not satisfy this criteria can result in unpredictable behavior.
- MOD = CNTIN is a redundant condition. In this case, the FTM counter is always equal to MOD and the TOF bit is set in each rising edge of the FTM counter clock.
- When MOD = 0x0000, CNTIN = 0x0000, for example after reset, and FTMMEN = 1, the FTM counter remains stopped at 0x0000 until a non-zero value is written into the MOD or CNTIN registers.
- Setting CNTIN to be greater than the value of MOD is not recommended as this unusual setting may make the FTM operation difficult to comprehend. However, there is no restriction on this configuration, and an example is shown in the following figure.

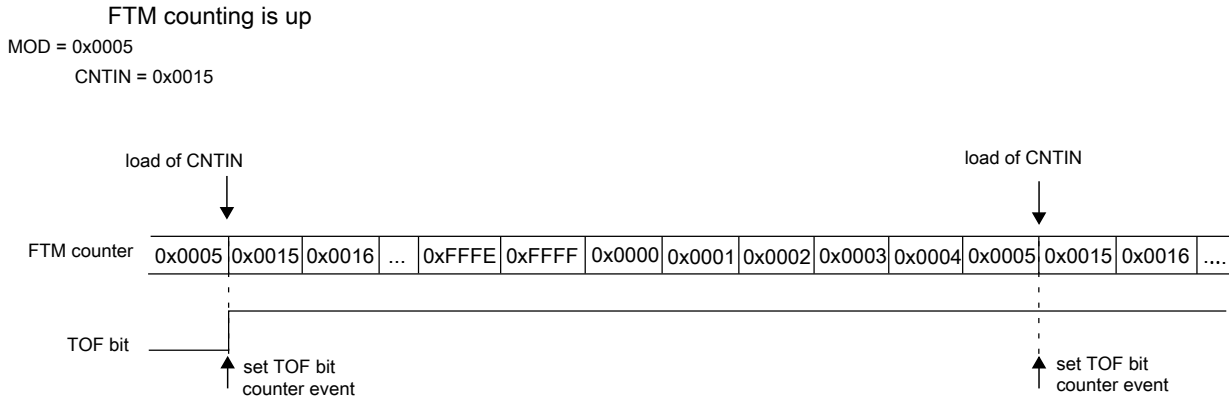

Figure 47-10. Example of up counting when the value of CNTIN is greater than the value of MOD

47.5.3.2 Up-down counting

Up-down counting is selected when:

- QUADEN = 0, and
- CPWMS = 1

CNTIN defines the starting value of the count and MOD defines the final value of the count. The value of CNTIN is loaded into the FTM counter, and the counter increments until the value of MOD is reached, at which point the counter is decremented until it returns to the value of CNTIN and the up-down counting restarts.

The FTM period when using up-down counting is $2 \times (\text{MOD} - \text{CNTIN}) \times \text{period of the FTM counter clock}$.

The TOF bit is set when the FTM counter changes from MOD to (MOD – 1).

If (CNTIN = 0x0000), the FTM counting is equivalent to TPM up-down counting, that is, up-down and unsigned counting. See the following figure.

Functional Description

FTM counting is up-down
 CNTIN = 0x0000
 MOD = 0x0004

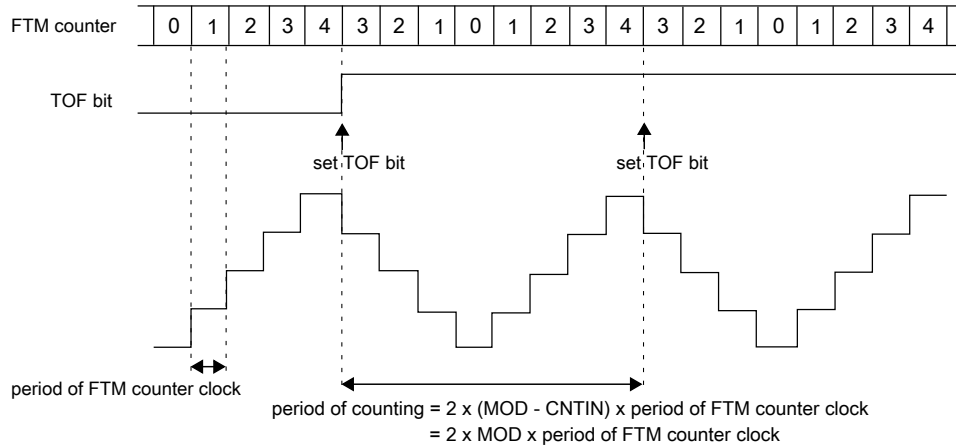

Figure 47-11. Example of up-down counting when CNTIN = 0x0000

Note

When CNTIN is different from zero in the up-down counting, a valid CPWM signal is generated:

- if $C_nV > \text{CNTIN}$, or
- if $C_nV = 0$ or if $C_nV[15] = 1$. In this case, 0% CPWM is generated.

The figure below shows the possible counter events when in up-down counting mode. See [Counter events](#) for more details.

FTM counting is up-down
 CNTIN = 0x0000
 MOD = 0x0004

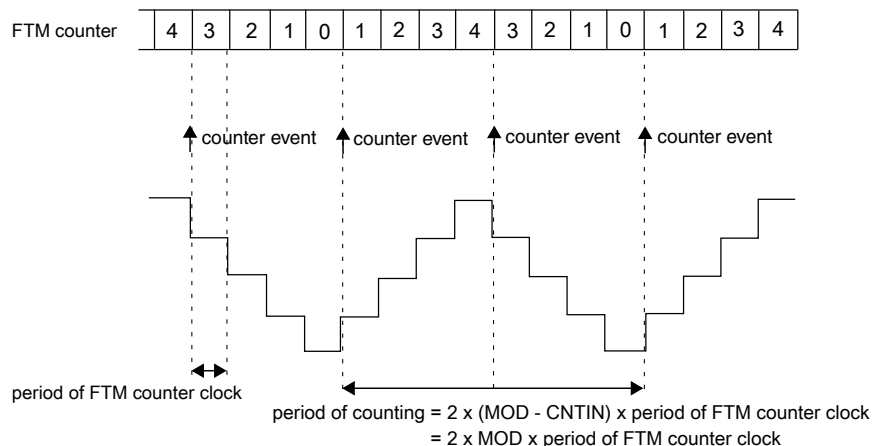

Figure 47-12. Example of counter events in up-down counting mode when CNTIN = 0x0000

47.5.3.3 Free running counter

If (FTMEN = 0) and (MOD = 0x0000 or MOD = 0xFFFF), the FTM counter is a free running counter. In this case, the FTM counter runs free from 0x0000 through 0xFFFF and the TOF bit is set when the FTM counter changes from 0xFFFF to 0x0000. See the following figure.

A counter event occurs at the same time of TOF bit set when the FTM counter changes from 0xFFFF to 0x0000. See [Counter events](#) for more details.

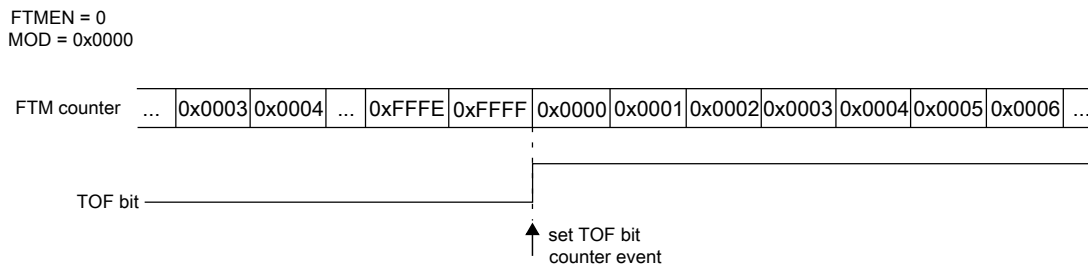

Figure 47-13. Example when the FTM counter is free running

The FTM counter is also a free running counter when:

- FTMEN = 1
- QUADEN = 0
- CPWMS = 0
- CNTIN = 0x0000, and
- MOD = 0xFFFF

47.5.3.4 Counter reset

Any one of the following cases resets the FTM counter to the value in the CNTIN register and the channels output to its initial value, except for channels in Output Compare mode.

- Any write to CNT.
- [FTM counter synchronization](#).
- A channel in Input Capture mode with ICRST = 1 ([FTM Counter Reset in Input Capture Mode](#)).

Note that resetting the counter also generates a counter event. See [Counter events](#) for more details.

47.5.3.5 Counter events

Counter events can be used as reload opportunities to FTM register synchronization mechanism. See [Reload Points](#) for more details. There are some possible counter events depending on the counter mode. Please see the table below for more details.

Table 47-4. FTM counter events

When	Then
FTM counter is in up counting mode or freerunning	<ul style="list-style-type: none"> A counter event happens at the same time of TOF bit set when the FTM counter changes from MOD to CNTIN (counter wrap). Figure at Up counting shows the counter event generation. When in freerunning, there is a counter event when FTM counter changes from 0xFFFF to 0x0000. Figure at Free running counter shows the counter event generation.
FTM counter is in up-down counting mode	<ul style="list-style-type: none"> In up-down counting mode, there are two possible counter events when FTM counter turns from down to up counting and when counter turns from up to down counting. User can select which point will be used to generate the counter event. Figure at Up-down counting shows the possible counter events.
FTM counter is reseted (see Counter reset) or a value different from zero is written at CLKS field	<ul style="list-style-type: none"> In up-counting mode, all counter reset events or a write in the CLKS with a value different from zero generates a counter event. In up-down counting mode, counter reset events only generates a counter event if the minimum load point when FTM counter turns from down to up counting is configured. A write in the CLKS with a value different from zero always generates a counter event in up-down counting mode.

47.5.4 Channel Modes

The following table shows the channel modes selection.

Table 47-5. Channel Modes Selection

DECAPEN	MCOMBINE	COMBINE	CPWMS	MSB:MSA	ELSB:ELSA	Mode	Configuration
X	X	X	X	XX	00	Pin not used for FTM—revert the channel pin to general purpose I/O or other peripheral control	
0	0	0	0	00	01	Input Capture	Capture on Rising Edge Only

Table continues on the next page...

Table 47-5. Channel Modes Selection (continued)

DECAPEN	MCOMBINE	COMBINE	CPWMS	MSB:MSA	ELSB:ELSA	Mode	Configuration			
					10		Capture on Falling Edge Only			
					11		Capture on Rising or Falling Edge			
				01	01	Output Compare	Toggle Output on match			
					10		Clear Output on match			
					11		Set Output on match			
				1X	10	Edge-Aligned PWM	High-true pulses (clear Output on match)			
					X1		Low-true pulses (set Output on match)			
				1	XX	10	Center-Aligned PWM	High-true pulses (clear Output on match-up)		
								X1	Low-true pulses (set Output on match-up)	
				1	0	XX	10	Combine PWM	High-true pulses (set on channel (n) match, and clear on channel (n+1) match)	
									X1	Low-true pulses (clear on channel (n) match, and set on channel (n+1) match)
				1	0	X	XX	XX	Reserved for future use	
				1	1	0	XX	10	Modified Combine PWM	High-true pulses (set on channel (n) match, and

Table continues on the next page...

Table 47-5. Channel Modes Selection (continued)

DECAPEN	MCOMBINE	COMBINE	CPWMS	MSB:MSA	ELSB:ELSA	Mode	Configuration
							clear on channel (n+1) match)
					X1		Low-true pulses (clear on channel (n) match, and set on channel (n+1) match)
1	0	0	0	X0	See Table 47-6 .	Dual Edge Capture	One-Shot Capture mode
				X1			Continuous Capture mode

Table 47-6. Dual Edge Capture Mode — Edge Polarity Selection

ELSB	ELSA	Channel Port Enable	Detected Edges
0	0	Disabled	No edge
0	1	Enabled	Rising edge
1	0	Enabled	Falling edge
1	1	Enabled	Rising and falling edges

47.5.5 Input Capture Mode

The Input Capture mode is selected when:

- DECAPEN = 0
- MCOMBINE = 0
- COMBINE = 0
- CPWMS = 0
- MSB:MSA = 0:0, and
- ELSB:ELSA ≠ 0:0

When a selected edge occurs on the channel input, the current value of the FTM counter is captured into the CnV register, at the same time the CHF bit is set and the channel interrupt is generated if enabled by CHIE = 1. See the following figure.

When a channel is configured for input capture, the FTMxCHn pin is an edge-sensitive input. ELSB:ELSA bits determine which edge, falling or rising, triggers input-capture event.

Writes to the CnV register are ignored in input capture mode.

While in Debug mode, the input capture function works as configured. When a selected edge event occurs, the FTM counter value, which is frozen because of Debug, is captured into the CnV register and the CHF bit is set.

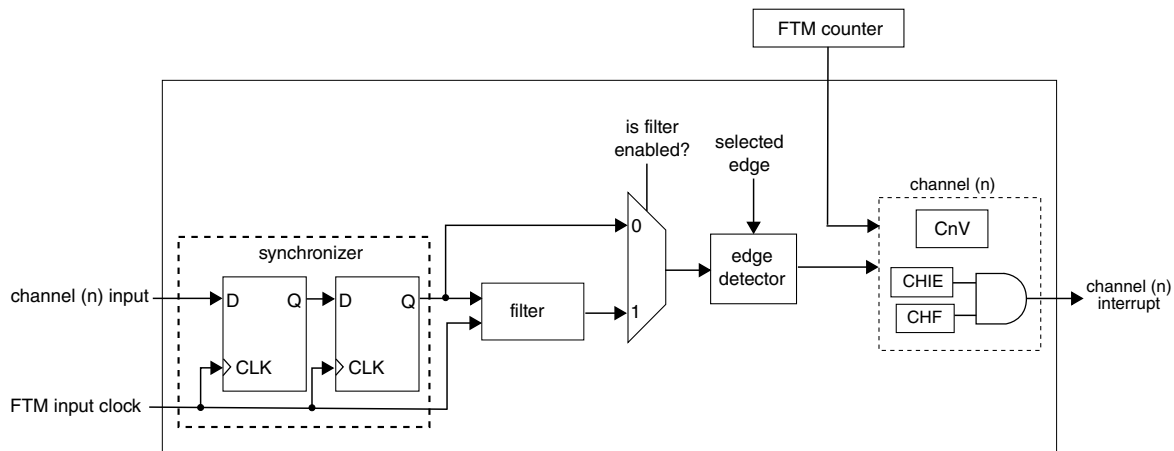

Note: The filter is only available for the channels 0, 1, 2, and 3 inputs.

Figure 47-14. Diagram for Input Capture Mode when FLTPS[3:0] = 0

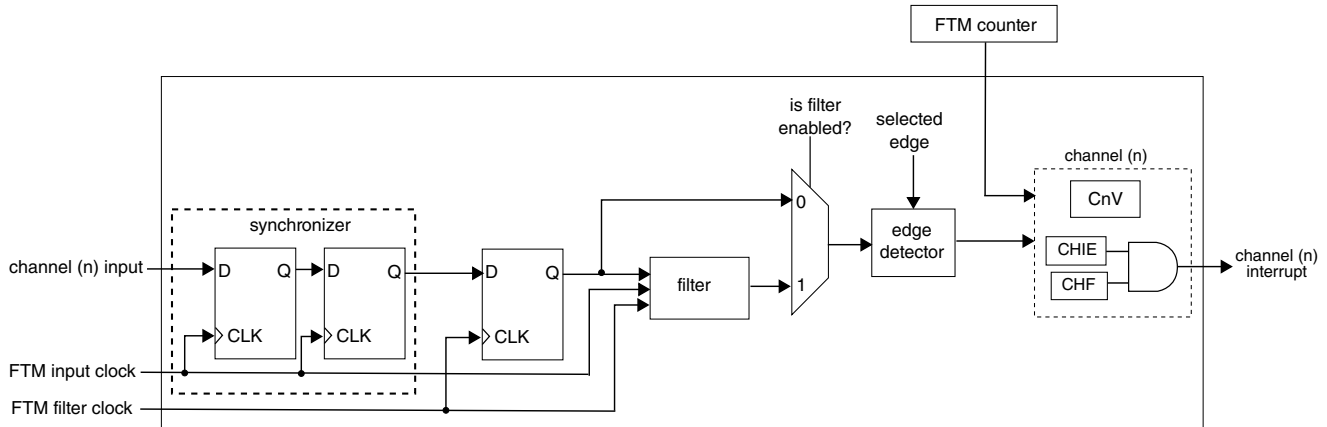

Note: The filter is only available for the channels 0, 1, 2, and 3 inputs.

Figure 47-15. Diagram for Input Capture Mode when FLTPS[3:0] ≠ 0

47.5.5.1 Filter for Input Capture Mode

The filter is only available on channels 0, 1, 2, and 3.

If FLTPS[3:0] = 0, the channel input after being synchronized by FTM input clock (Figure 47-14) is the filter input.

Functional Description

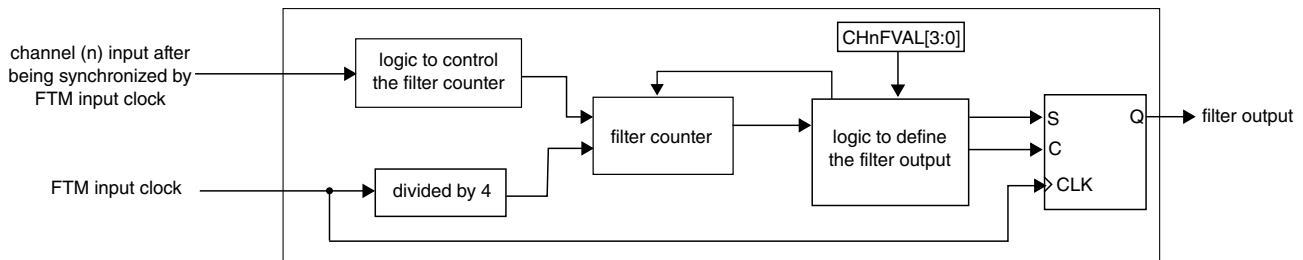

Figure 47-16. Channel Input Filter when $FLTPS[3:0] = 0$

If $FLTPS[3:0] \neq 0$, the channel input after being synchronized by FTM input clock and being sampled by FTM filter clock (Figure 47-15) is the filter input.

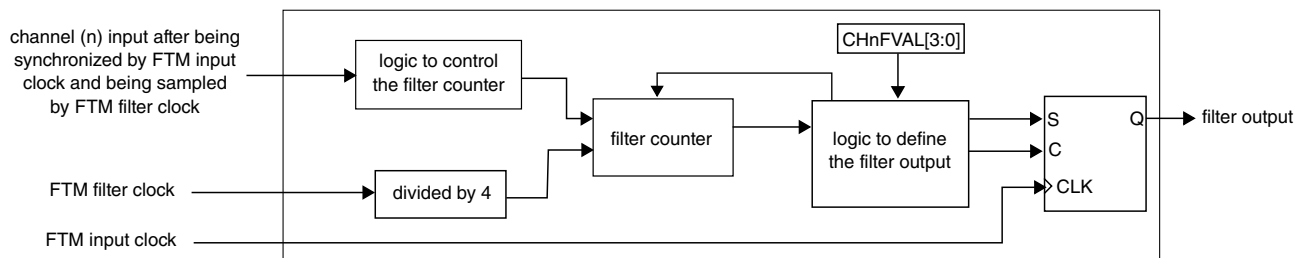

Figure 47-17. Channel Input Filter when $FLTPS[3:0] \neq 0$

NOTE

The maximum frequency for the channel input to be detected correctly is FTM filter clock divided by 4, which is required to meet Nyquist criteria for signal sampling.

When there is a state change in the channel input, the counter is reset and starts counting up. As long as the new state is stable on the channel input, the counter continues to increment. When the counter is equal to $CHnFVAL[3:0]$, the new channel input signal value is validated. It is then transmitted as a pulse to the edge detector.

If the opposite edge appears on the channel input signal before it can be validated, the counter is reset. At the next input transition, the counter starts counting again. If a pulse is sampled as a value less than $(CHnFVAL[3:0] \times 4)$ consecutive rising edges of FTM filter clock, it is regarded as a glitch and is not passed on to the edge detector.

The table below shows the delay that is added by the FTM channel input filter according to its configuration.

Table 47-7. FTM Channel Input Filter Delay

FTM channel input filter	FLTPS[3:0] bits	Number of rising edges between the selected edge on channel input and setting CHF bit
<ul style="list-style-type: none"> channel does not have the input filter, or channel input filter is disabled (CHnFVAL[3:0] = 0) 	FLTPS[3:0] = 0	<ul style="list-style-type: none"> 3 rising edges of FTM input clock
	FLTPS[3:0] ≠ 0	<ul style="list-style-type: none"> 3 rising edges of FTM input clock, plus 1 rising edge of FTM filter clock
<ul style="list-style-type: none"> channel has the input filter, and channel input filter is enabled (CHnFVAL[3:0] ≠ 0) 	FLTPS[3:0] = 0	<ul style="list-style-type: none"> (4 + 4 × CHnFVAL[3:0]) rising edges of FTM input clock
	FLTPS[3:0] ≠ 0	<ul style="list-style-type: none"> 4 rising edges of FTM input clock, plus (1 + 4 × CHnFVAL[3:0]) rising edges of FTM filter clock

The following figures illustrate two examples of channel input filter.

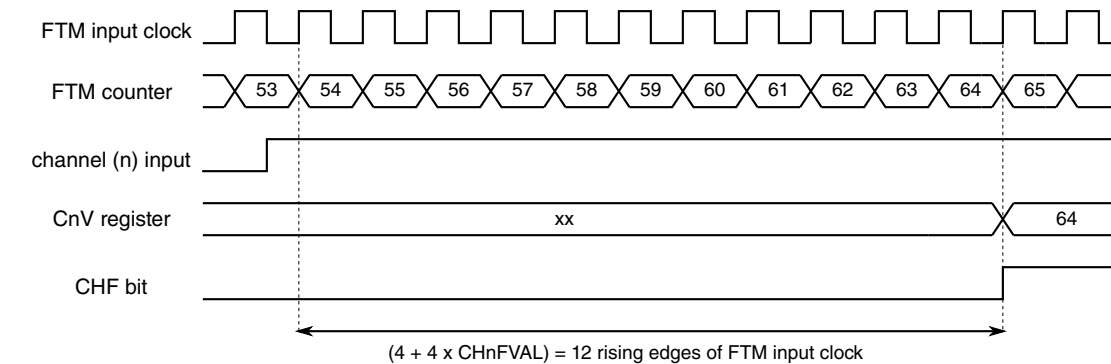

Note:
 PS[2:0] = 3'b000
 channel (n) in input capture mode with capture only on rising edges
 CHnFVAL[3:0] = 4'h2 (channel (n) input filter is enabled)

Figure 47-18. Example of Channel Input Filter when FLTPS[3:0] = 0

Functional Description

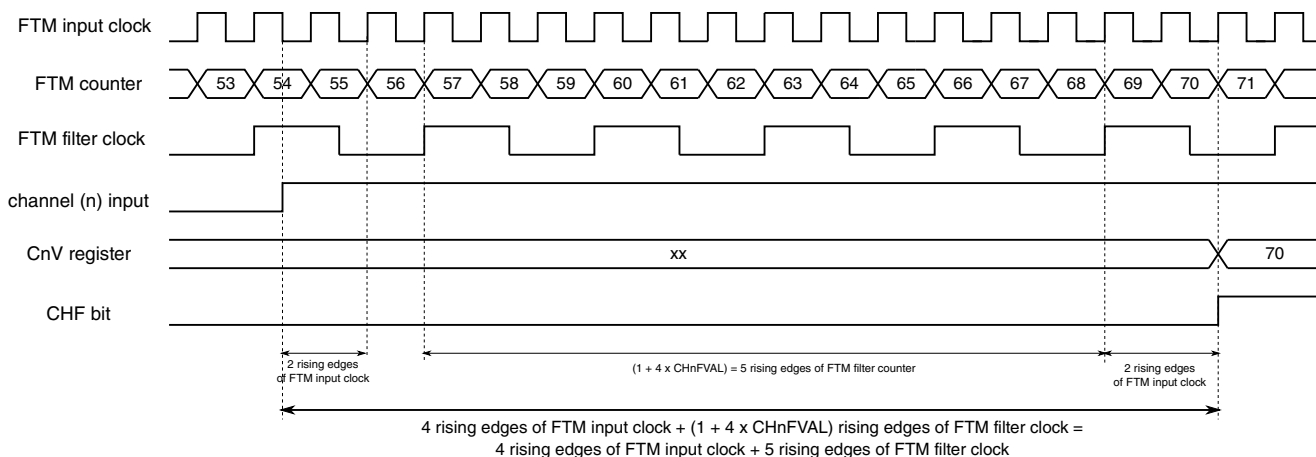

Note:
 PS[2:0] = 3'b000
 channel (n) in input capture mode with capture only on rising edges
 CHnFVAL[3:0] = 4'h1 (channel (n) input filter is enabled)
 FLTPS[3:0] = 4'h2 (divide by 3)

Figure 47-19. Example of Channel Input Filter when FLTPS[3:0] \neq 0

47.5.5.2 FTM Counter Reset in Input Capture Mode

If the channel (n) is in input capture mode and $\text{CnSC}[\text{ICRST} = 1]$, then when the selected input capture event occurs in the channel (n) input signal, the current value of the FTM counter is captured into the CnV register, the CHF bit is set, the channel (n) interrupt is generated (if $\text{CHIE} = 1$) and the FTM counter is reset to the CNTIN register value.

This allows the FTM to measure a period/pulse being applied to the channel (n) input (number of the FTM input clocks) without having to implement a subtraction calculation in software subsequent to the event occurring.

The figure below shows the FTM counter reset when the selected input capture event is detected in a channel in input capture mode with $\text{ICRST} = 1$.

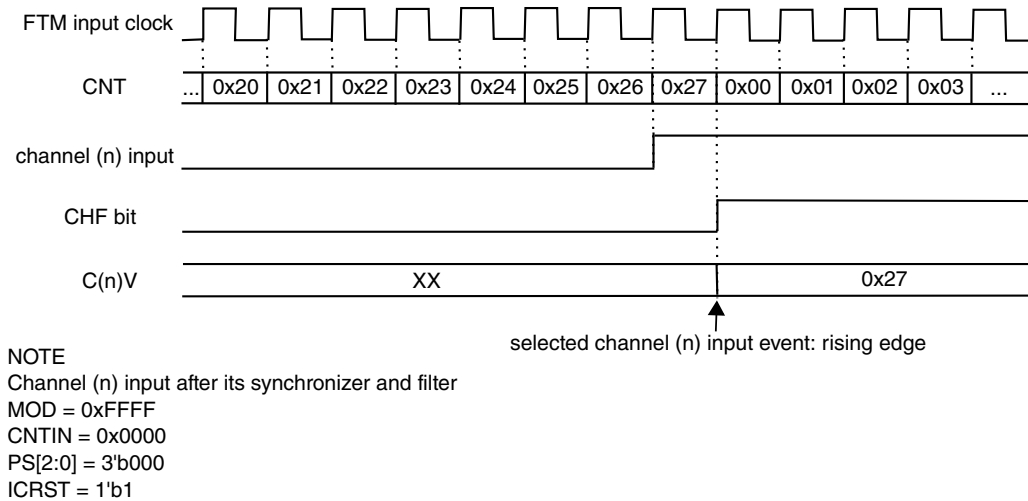

Figure 47-20. Example of the Input Capture mode with ICRST = 1

NOTE

- It is expected that the ICRST bit be set only when the channel is in input capture mode.
- If the FTM counter is reset because the channel is in input capture mode with ICRST = 1, then the prescaler counter ([Prescaler](#)) is also reset.

47.5.6 Output Compare mode

The Output Compare mode is selected when:

- DECAPEN = 0
- MCOMBINE = 0
- COMBINE = 0
- CPWMS = 0, and
- MSB:MSA = 0:1

In Output Compare mode, the FTM can generate timed pulses with programmable position, polarity, duration, and frequency. When the counter matches the value in the CnV register of an output compare channel, the channel (n) output can be set, cleared, or toggled.

When a channel is initially configured to Toggle mode, the previous value of the channel output is held until the first output compare event occurs.

The CHF bit is set and the channel (n) interrupt is generated if CHIE = 1 at the channel (n) match (FTM counter = CnV).

Functional Description

MOD = 0x0005
CnV = 0x0003

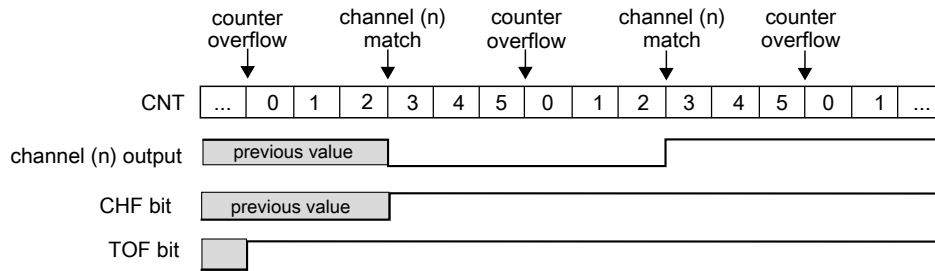

Figure 47-21. Example of the Output Compare mode when the match toggles the channel output

MOD = 0x0005
CnV = 0x0003

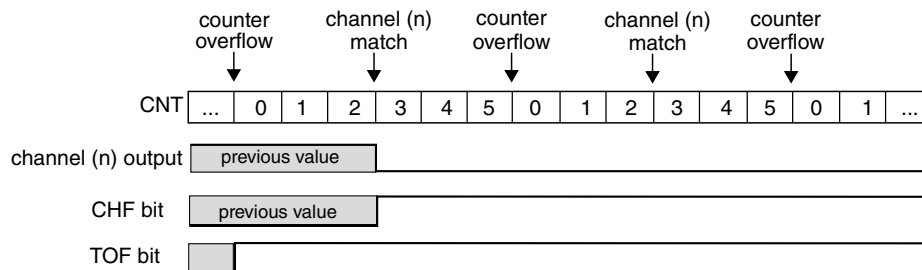

Figure 47-22. Example of the Output Compare mode when the match clears the channel output

MOD = 0x0005
CnV = 0x0003

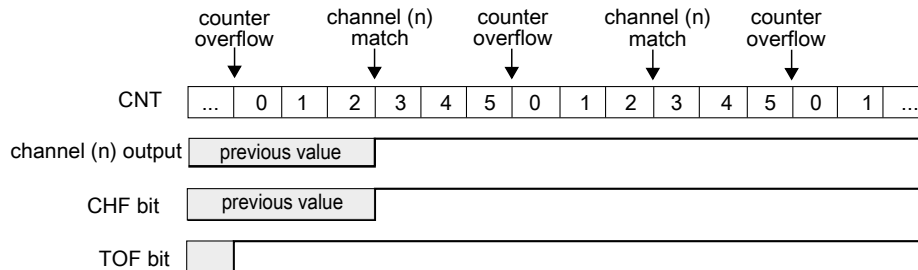

Figure 47-23. Example of the Output Compare mode when the match sets the channel output

If (ELSB:ELSA = 0:0) when the counter reaches the value in the CnV register, the CHF bit is set and the channel (n) interrupt is generated if CHIE = 1, however the channel (n) output is not modified and controlled by FTM.

47.5.7 Edge-Aligned PWM (EPWM) mode

The Edge-Aligned mode is selected when:

- QUADEN = 0

- $DECAPEN = 0$
- $MCOMBINE = 0$
- $COMBINE = 0$
- $CPWMS = 0$, and
- $MSB = 1$

The EPWM period is determined by $(MOD - CNTIN + 0x0001)$ and the pulse width (duty cycle) is determined by $(CnV - CNTIN)$.

The CHF bit is set and the channel (n) interrupt is generated if $CHIE = 1$ at the channel (n) match (FTM counter = CnV), that is, at the end of the pulse width.

This type of PWM signal is called edge-aligned because the leading edges of all PWM signals are aligned with the beginning of the period, which is the same for all channels within an FTM.

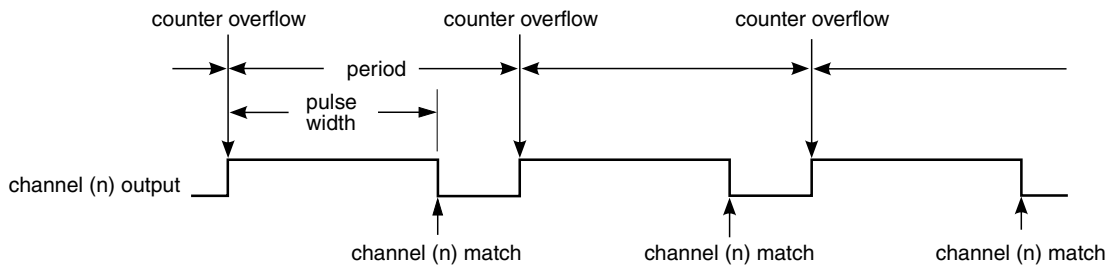

Figure 47-24. EPWM period and pulse width with ELSB:ELSA = 1:0

If ($ELSB:ELSA = 0:0$) when the counter reaches the value in the CnV register, the CHF bit is set and the channel (n) interrupt is generated if $CHIE = 1$, however the channel (n) output is not controlled by FTM.

If ($ELSB:ELSA = 1:0$), then the channel (n) output is forced high at the counter overflow when the $CNTIN$ register value is loaded into the FTM counter, and it is forced low at the channel (n) match (FTM counter = CnV). See the following figure.

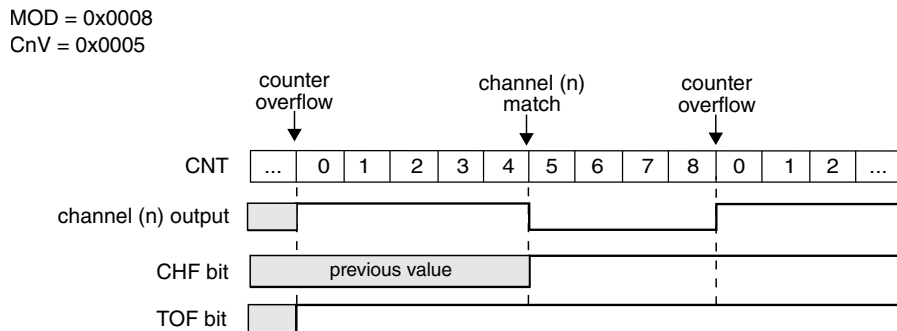

Figure 47-25. EPWM signal with ELSB:ELSA = 1:0

Functional Description

If (ELSB:ELSA = X:1), then the channel (n) output is forced low at the counter overflow when the CNTIN register value is loaded into the FTM counter, and it is forced high at the channel (n) match (FTM counter = CnV). See the following figure.

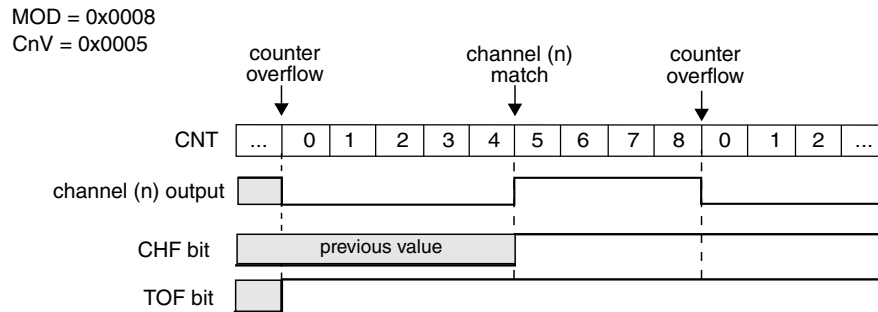

Figure 47-26. EPWM signal with ELSB:ELSA = X:1

If (CnV = 0x0000), then the channel (n) output is a 0% duty cycle EPWM signal and CHF bit is not set even when there is the channel (n) match.

If (CnV > MOD), then the channel (n) output is a 100% duty cycle EPWM signal and CHF bit is not set. Therefore, MOD must be less than 0xFFFF in order to get a 100% duty cycle EPWM signal.

Note

When CNTIN is different from zero the following EPWM signals can be generated:

- 0% EPWM signal if CnV = CNTIN,
- EPWM signal between 0% and 100% if CNTIN < CnV <= MOD,
- 100% EPWM signal when CNTIN > CnV or CnV > MOD.

47.5.8 Center-Aligned PWM (CPWM) mode

The Center-Aligned mode is selected when:

- QUADEN = 0
- DECAPEN = 0
- MCOMBINE = 0
- COMBINE = 0, and
- CPWMS = 1

The CPWM pulse width (duty cycle) is determined by $2 \times (CnV - CNTIN)$ and the period is determined by $2 \times (MOD - CNTIN)$. See the following figure. MOD must be kept in the range of 0x0001 to 0x7FFF because values outside this range can produce ambiguous results.

In the CPWM mode, the FTM counter counts up until it reaches MOD and then counts down until it reaches CNTIN.

The CHF bit is set and channel (n) interrupt is generated (if CHIE = 1) at the channel (n) match (FTM counter = CnV) when the FTM counting is down (at the begin of the pulse width) and when the FTM counting is up (at the end of the pulse width).

This type of PWM signal is called center-aligned because the pulse width centers for all channels are aligned with the value of CNTIN.

The other channel modes are not compatible with the up-down counter (CPWMS = 1). Therefore, all FTM channels must be used in CPWM mode when (CPWMS = 1).

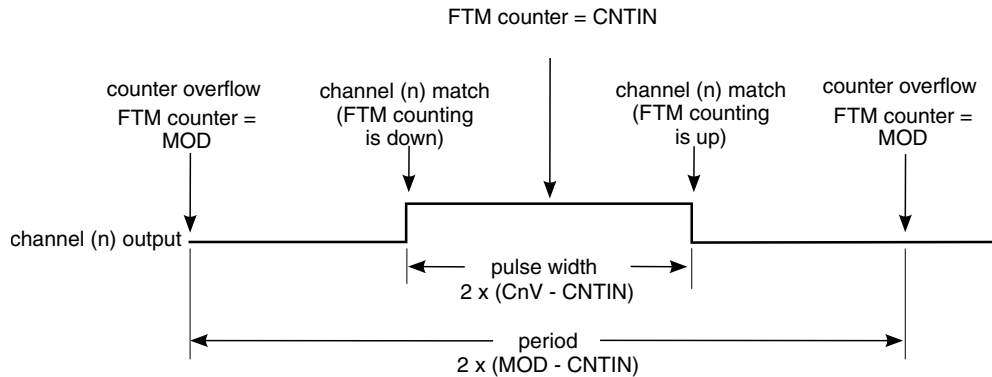

Figure 47-27. CPWM period and pulse width with ELSB:ELSA = 1:0

If (ELSB:ELSA = 0:0) when the FTM counter reaches the value in the CnV register, the CHF bit is set and the channel (n) interrupt is generated (if CHIE = 1), however the channel (n) output is not controlled by FTM.

If (ELSB:ELSA = 1:0), then the channel (n) output is forced high at the channel (n) match (FTM counter = CnV) when counting down, and it is forced low at the channel (n) match when counting up. See the following figure.

Functional Description

MOD = 0x0008
CnV = 0x0005

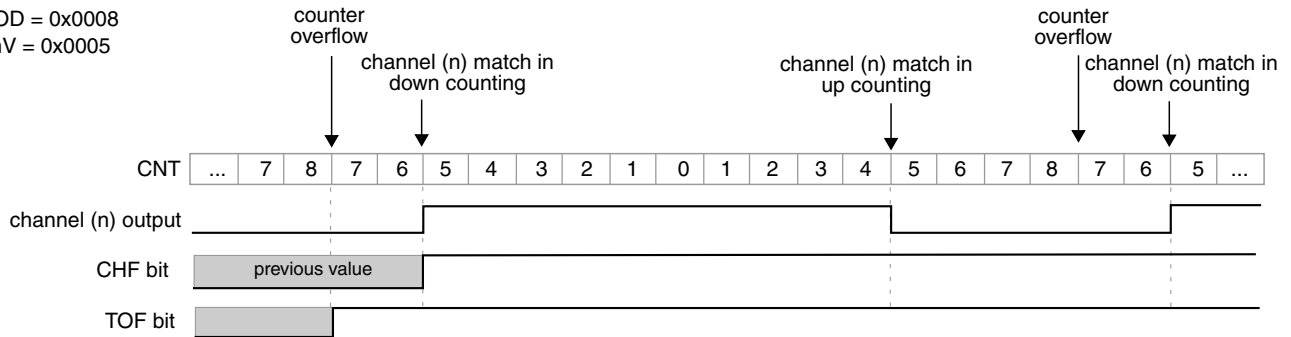

Figure 47-28. CPWM signal with ELSB:ELSA = 1:0

If (ELSB:ELSA = X:1), then the channel (n) output is forced low at the channel (n) match (FTM counter = CnV) when counting down, and it is forced high at the channel (n) match when counting up. See the following figure.

MOD = 0x0008
CnV = 0x0005

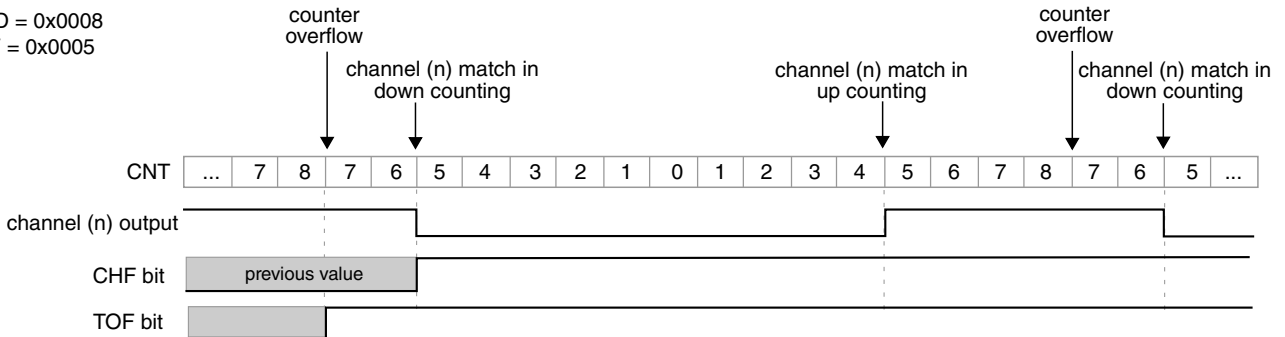

Figure 47-29. CPWM signal with ELSB:ELSA = X:1

If (CnV = 0x0000) or CnV is a negative value, that is (CnV[15] = 1), then the channel (n) output is a 0% duty cycle CPWM signal and CHF bit is not set even when there is the channel (n) match.

If CnV is a positive value, that is (CnV[15] = 0), (CnV ≥ MOD), and (MOD ≠ 0x0000), then the channel (n) output is a 100% duty cycle CPWM signal and CHF bit is not set even when there is the channel (n) match. This implies that the usable range of periods set by MOD is 0x0001 through 0x7FFE, 0x7FFF if you do not need to generate a 100% duty cycle CPWM signal. This is not a significant limitation because the resulting period is much longer than required for normal applications.

The CPWM mode must not be used when the FTM counter is a free running counter.

47.5.9 Combine mode

The Combine mode is selected when:

- QUADEN = 0

- $DECAPEN = 0$
- $MCOMBINE = 0$
- $COMBINE = 1$, and
- $CPWMS = 0$

In Combine mode, an even channel (n) and adjacent odd channel (n+1) are combined to generate a PWM signal in the channel (n) output.

In the Combine mode, the PWM period is determined by $(MOD - CNTIN + 0x0001)$ and the PWM pulse width (duty cycle) is determined by $(IC(n+1)V - C(n)V)$.

The channel (n) CHF bit is set and its interrupt is generated, if channel (n) CHIE = 1, at the channel (n) match (FTM counter = $C(n)V$). The channel (n+1) CHF bit is set and its interrupt is generated, if channel (n+1) CHIE = 1, at the channel (n+1) match (FTM counter = $C(n+1)V$).

If channel (n) $ELSB:ELSA = 1:0$, then the channel (n) output is forced low at the beginning of the period (FTM counter = $CNTIN$) and at the channel (n+1) match (FTM counter = $C(n+1)V$). It is forced high at the channel (n) match (FTM counter = $C(n)V$). See the following figure.

If channel (n) $ELSB:ELSA = X:1$, then the channel (n) output is forced high at the beginning of the period (FTM counter = $CNTIN$) and at the channel (n+1) match (FTM counter = $C(n+1)V$). It is forced low at the channel (n) match (FTM counter = $C(n)V$). See the following figure.

In Combine mode, the channel (n+1) $ELSB:ELSA$ bits are not used in the generation of the channels (n) and (n+1) output. However, if channel (n) $ELSB:ELSA = 0:0$, then the channel (n) output is not controlled by FTM, and if channel (n+1) $ELSB:ELSA = 0:0$, then the channel (n+1) output is not controlled by FTM.

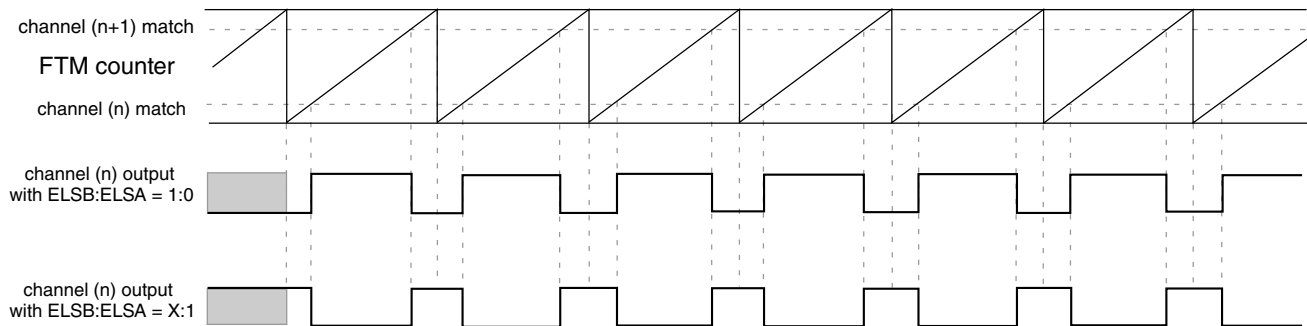

Figure 47-30. Combine mode

The following figures illustrate the PWM signals generation using Combine mode.

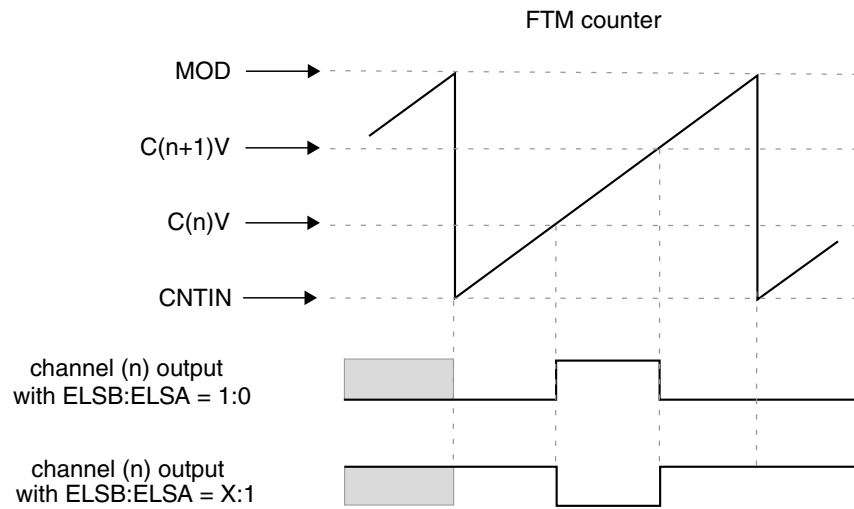

Figure 47-31. Channel (n) output if $(CNTIN < C(n)V < MOD)$ and $(CNTIN < C(n+1)V < MOD)$ and $(C(n)V < C(n+1)V)$

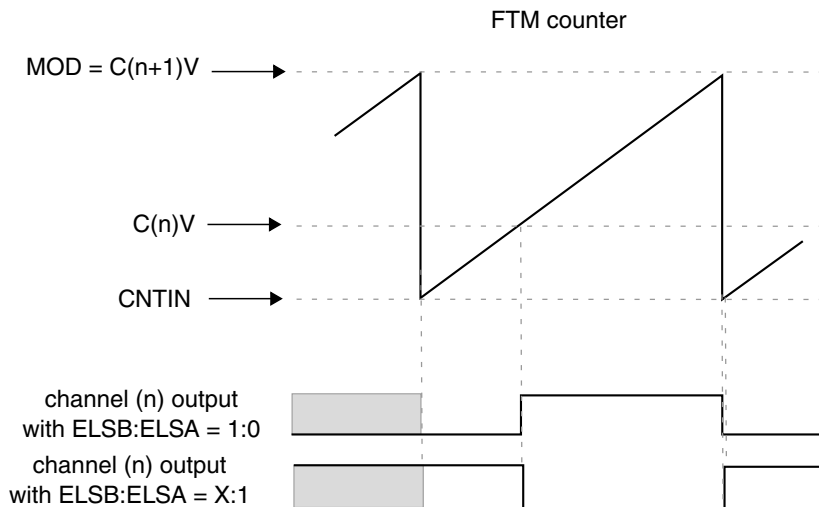

Figure 47-32. Channel (n) output if $(CNTIN < C(n)V < MOD)$ and $(C(n+1)V = MOD)$

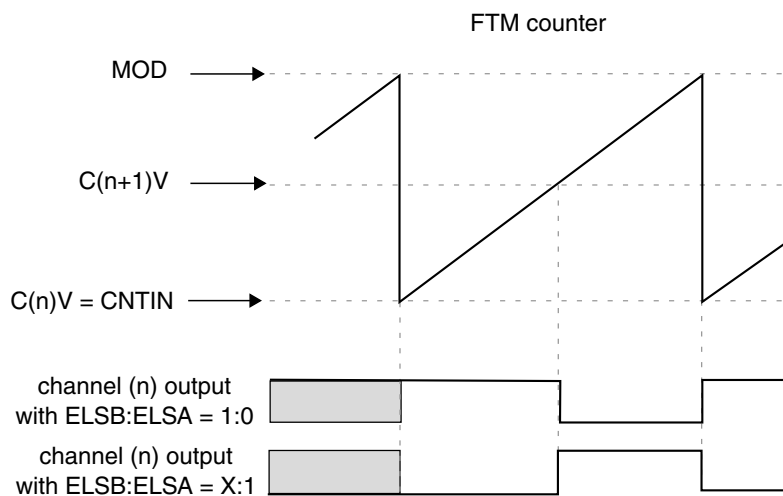

Figure 47-33. Channel (n) output if $(C(n)V = CNTIN)$ and $(CNTIN < C(n+1)V < MOD)$

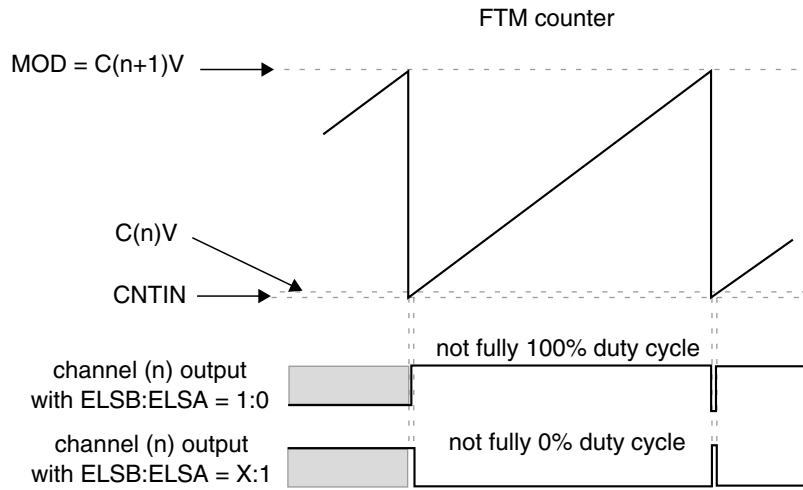

Figure 47-34. Channel (n) output if $(CNTIN < C(n)V < MOD)$ and $(C(n)V$ is Almost Equal to $CNTIN$) and $(C(n+1)V = MOD)$

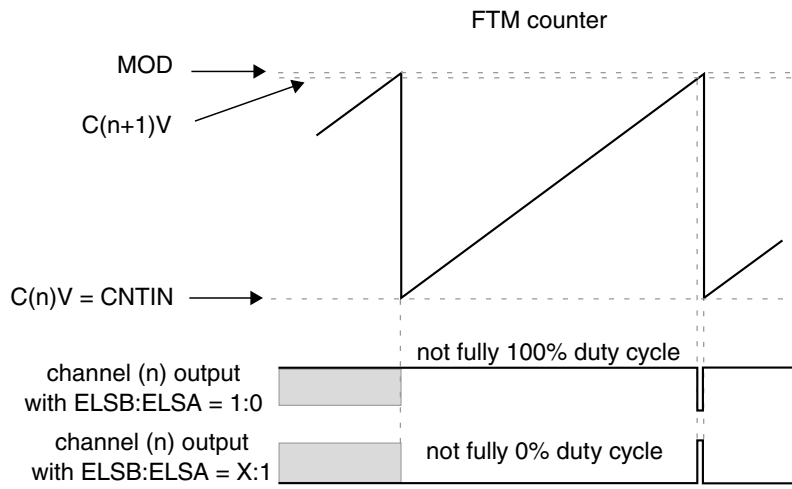

Figure 47-35. Channel (n) output if $(C(n)V = CNTIN)$ and $(CNTIN < C(n+1)V < MOD)$ and $(C(n+1)V$ is Almost Equal to MOD)

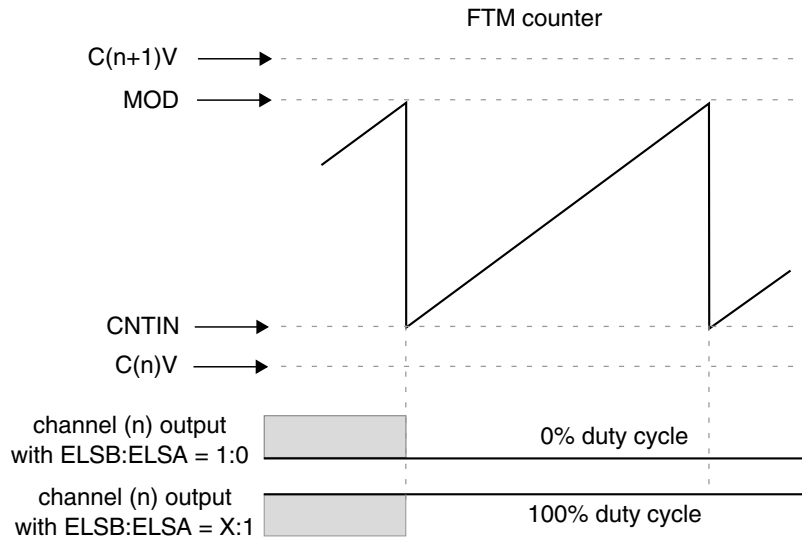

Figure 47-36. Channel (n) output if $C(n)V$ and $C(n+1)V$ are not between $CNTIN$ and MOD

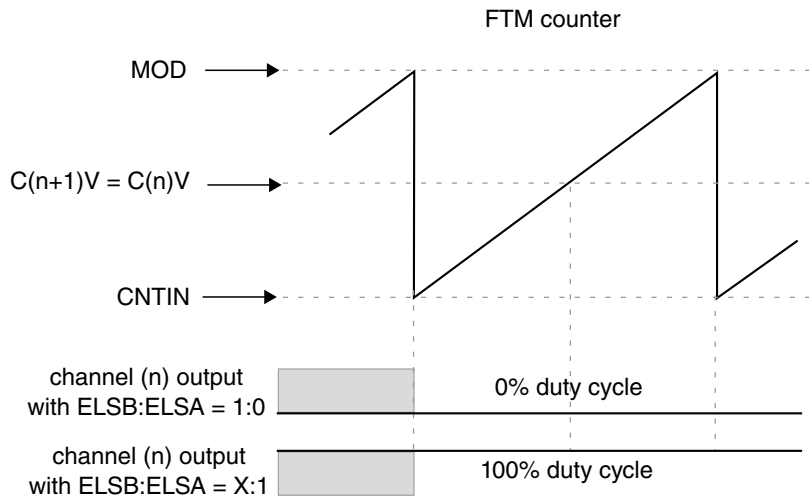

Figure 47-37. Channel (n) output if $(CNTIN < C(n)V < MOD)$ and $(CNTIN < C(n+1)V < MOD)$ and $(C(n)V = C(n+1)V)$

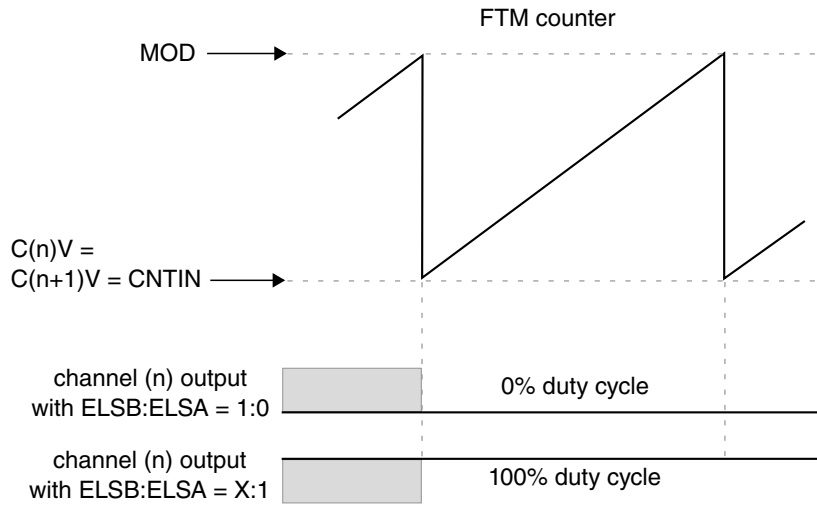

Figure 47-38. Channel (n) output if $(C(n)V = C(n+1)V = CNTIN)$

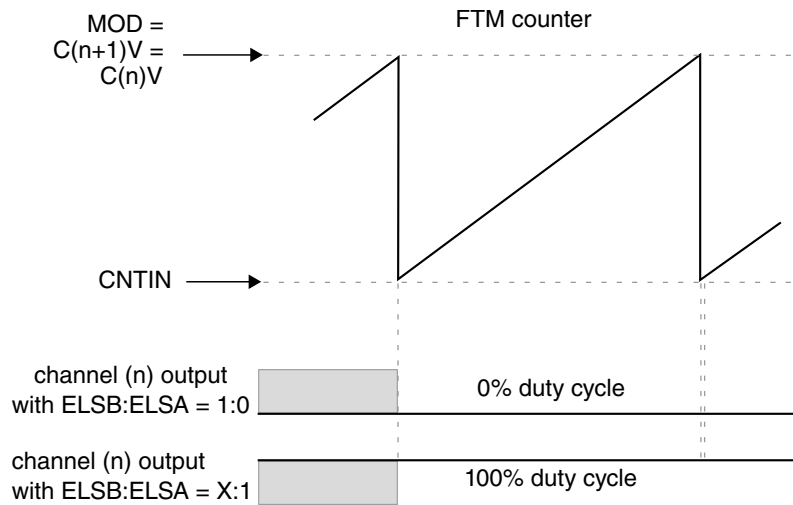

Figure 47-39. Channel (n) output if $(C(n)V = C(n+1)V = MOD)$

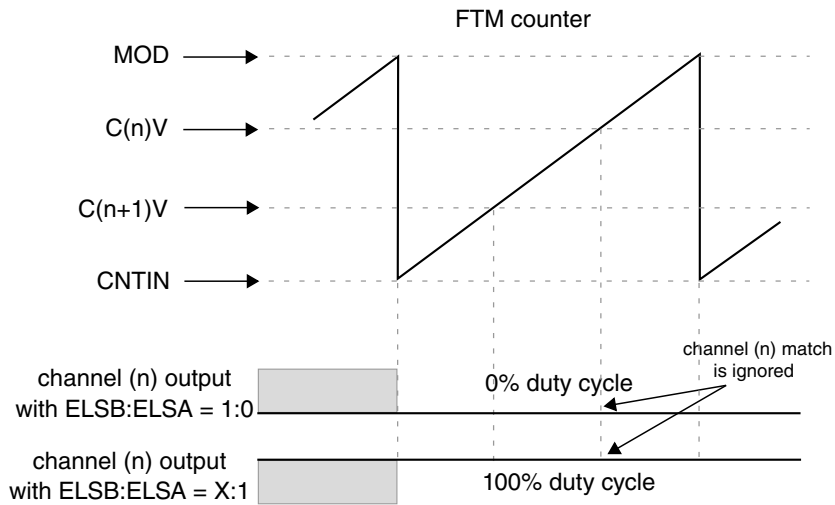

Figure 47-40. Channel (n) output if $(CNTIN < C(n)V < MOD)$ and $(CNTIN < C(n+1)V < MOD)$ and $(C(n)V > C(n+1)V)$

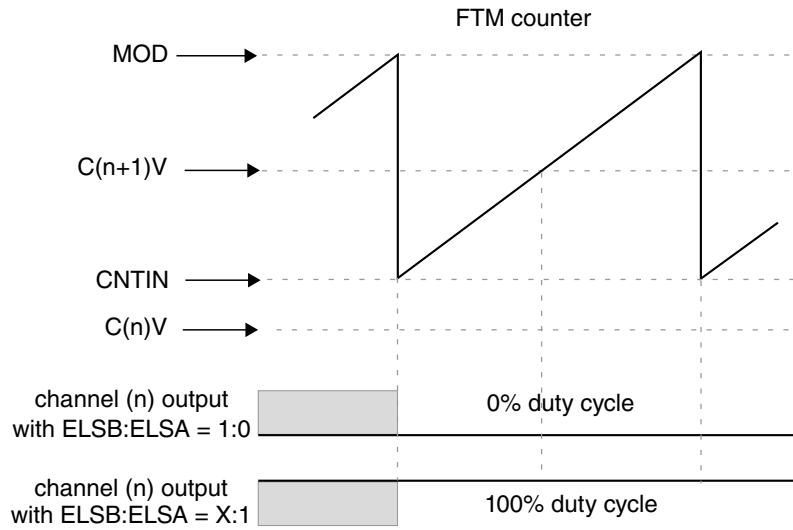

Figure 47-41. Channel (n) output if $(C(n)V < CNTIN)$ and $(CNTIN < C(n+1)V < MOD)$

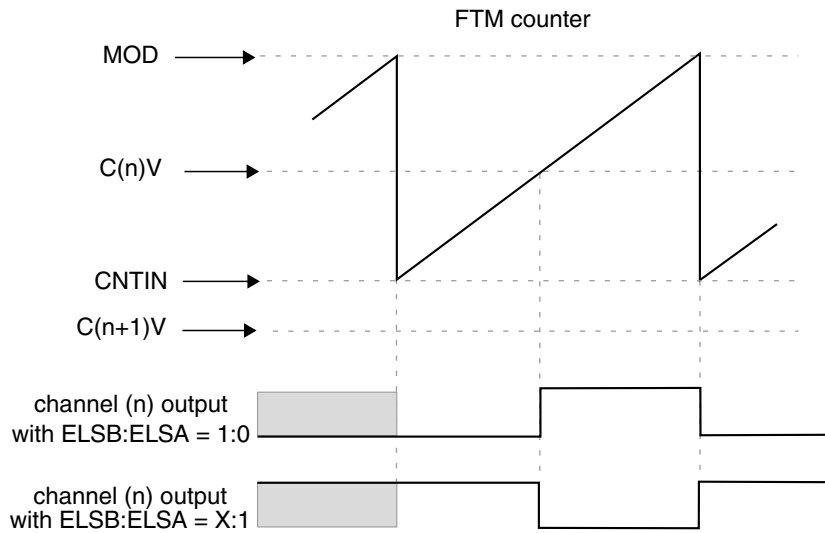

Figure 47-42. Channel (n) output if $(C(n+1)V < CNTIN)$ and $(CNTIN < C(n)V < MOD)$

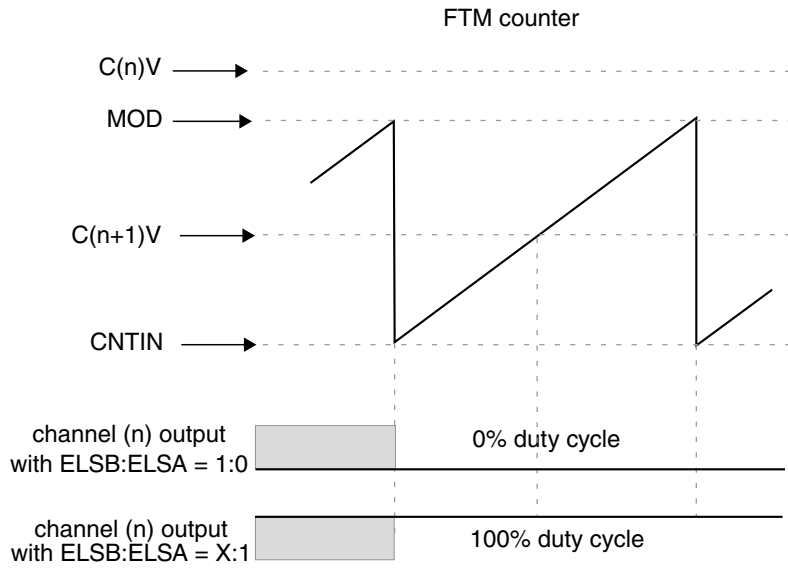

Figure 47-43. Channel (n) output if $(C(n)V > MOD)$ and $(CNTIN < C(n+1)V < MOD)$

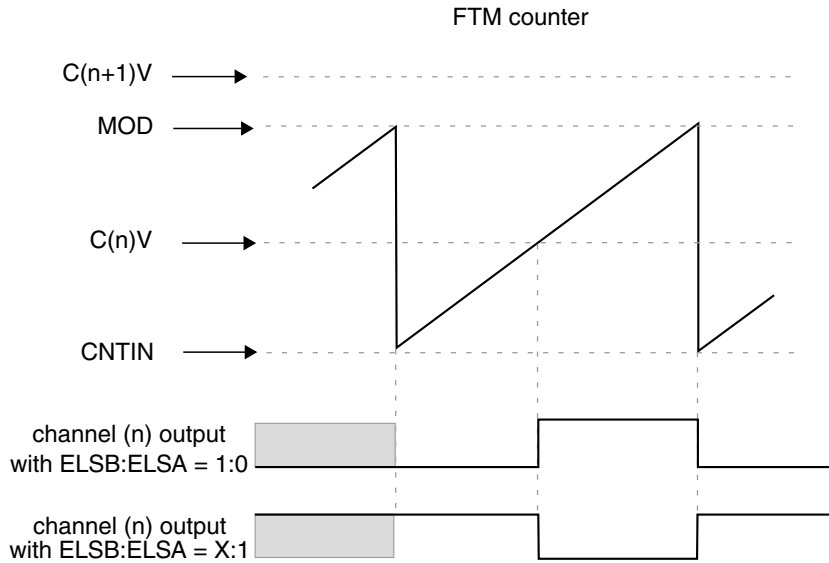

Figure 47-44. Channel (n) output if $(C(n+1)V > MOD)$ and $(CNTIN < C(n)V < MOD)$

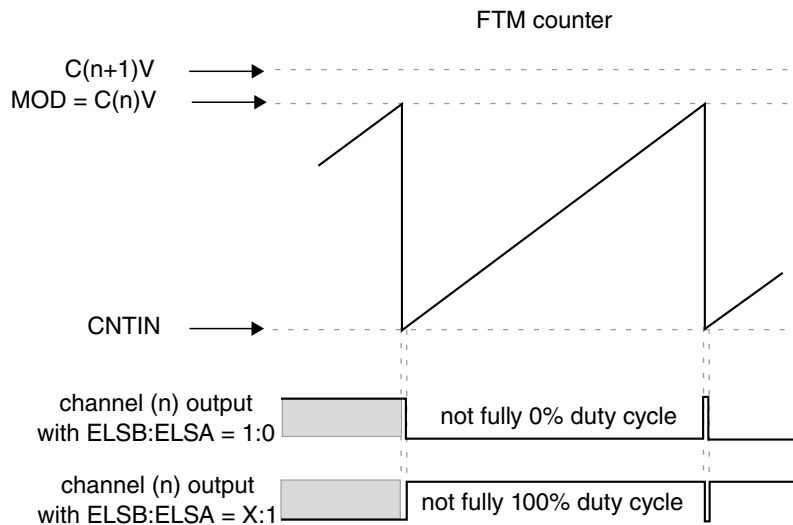

Figure 47-45. Channel (n) output if $(C(n+1)V > MOD)$ and $(CNTIN < C(n)V = MOD)$

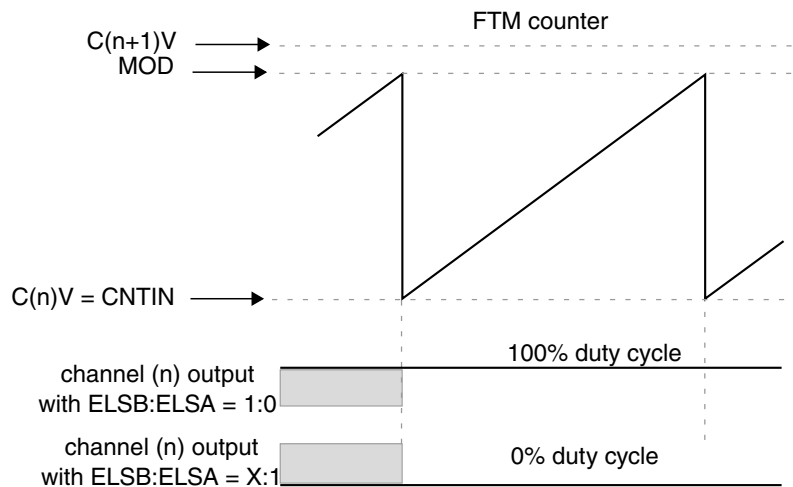

Figure 47-46. Channel (n) output if $(C(n)V = CNTIN)$ and $(C(n+1)V > MOD)$

47.5.9.1 Asymmetrical PWM

In [Combine mode](#) and [Modified Combine PWM Mode](#), the PWM first edge (channel (n) match: FTM counter = $C(n)V$) is independent of the PWM second edge (channel (n+1) match: FTM counter = $C(n+1)V$).

47.5.10 Modified Combine PWM Mode

The Modified Combine PWM mode is selected when:

- $QUADEN = 0$
- $DECAPEN = 0$

- MCOMBINE = 1
- COMBINE = 1, and
- CPWMS = 0

The Modified Combine PWM mode is intended to support the generation of PWM signals where the period is not modified while the signal is being generated, but the duty cycle will be varied. In this mode, an even channel (n) and adjacent odd channel (n+1) are combined to generate a PWM signal in the channel (n) output. Thus, the channel (n) match edge is fixed and the channel (n+1) match edge can be varied.

When a pair of channels is in Modified Combine PWM mode, it is recommend that the other pairs also be in Modified Combine PWM mode.

In the Modified Combine PWM mode, assuming that $CNTIN \geq 0$, $MOD > 0$, and $CNTIN < MOD$:

- The PWM period is determined by $(MOD - CNTIN + 0x0001)$;
- The channel (n) PWM duty cycle is calculated according to the following table.

Table 47-8. Modified Combine PWM Mode - Duty Cycles

Channel (n) PWM Duty Cycle	Condition
0% duty cycle	For $CNTIN \leq (C(n)V$ and $C(n+1)V \leq MOD$: $C(n)V = C(n+1)V$
duty cycle between 0% and 100%	For $CNTIN \leq (C(n)V$ and $C(n+1)V \leq MOD$: <ul style="list-style-type: none"> • if $(C(n)V < C(n+1)V)$, then the duty cycle is $(C(n+1)V - C(n)V)$ • if $(C(n)V > C(n+1)V)$, then the duty cycle is $[(MOD - C(n)V) + (C(n+1)V - CNTIN) + 1]$
100% duty cycle	$CNTIN \leq C(n)V \leq MOD$ and $C(n+1)V > MOD$

The channel (n) CHF bit is set and its interrupt is generated, if channel (n) CHIE = 1, at the channel (n) match (FTM counter = $C(n)V$). The channel (n+1) CHF bit is set and its interrupt is generated, if channel (n+1) CHIE = 1, at the channel (n+1) match (FTM counter = $C(n+1)V$).

If channel (n) ELSB:ELSA = 1:0, then the channel (n) output is forced high at the channel (n) match (FTM counter = $C(n)V$) and it is forced low at the channel (n+1) match (FTM counter = $C(n+1)V$).

If channel (n) ELSB:ELSA = X:1, then the channel (n) output is forced low at the channel (n) match (FTM counter = $C(n)V$) and it is forced high at the channel (n+1) match (FTM counter = $C(n+1)V$).

Functional Description

In Modified Combine PWM mode, the channel (n+1) ELSB:ELSA bits are not used in the generation of the channels (n) and (n+1) output. However, if channel (n) ELSB:ELSA = 0:0, then the channel (n) output is not controlled by FTM, and if channel (n+1) ELSB:ELSA = 0:0, then the channel (n+1) output is not controlled by FTM.

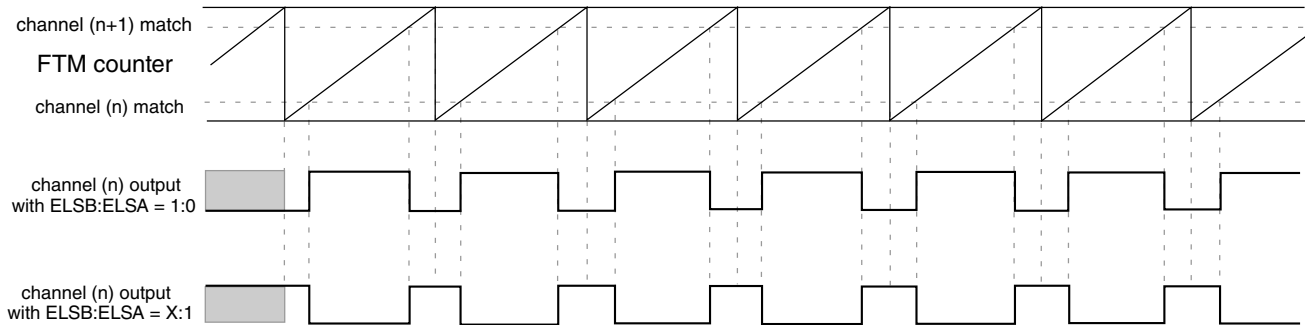

Figure 47-47. Modified Combine PWM Mode

The Modified Combine PWM mode allows the offset addition of the duty cycle, thus, in some cases, the $C(n+1)V$ match can happen on the next FTM counter period. For $CNTIN \geq 0$, $MOD > 0$, and $CNTIN < MOD$, this situation happens when $C(n)V > C(n+1)V$.

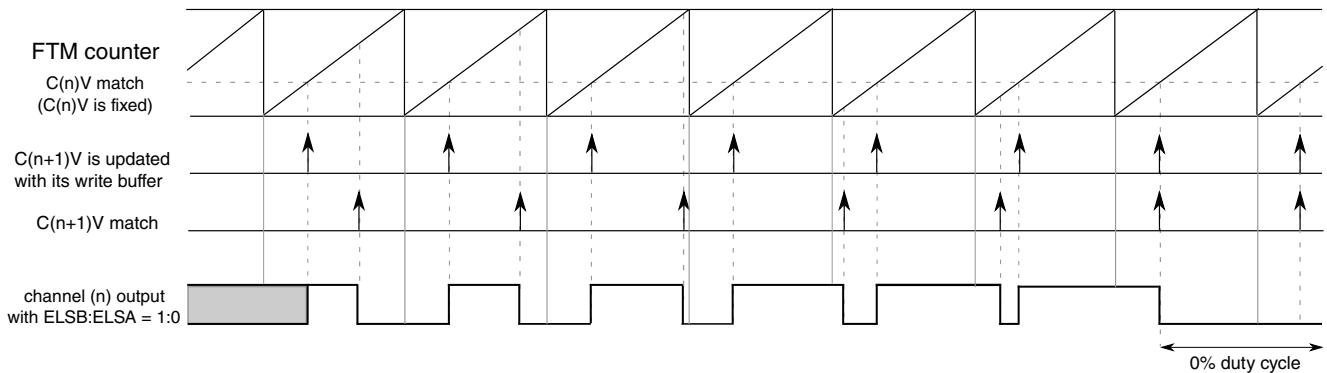

Figure 47-48. Modified Combine PWM Mode Examples

If more than one pair of channels are configured in Modified Combine PWM Mode, it is possible to fix an offset for the channel (n) match edge of each pair with respect to other pairs. This behavior is useful in the generation of lighting PWM control signals where it is desirable that edges are not coincident with each other pair to help eliminate noise generation. The $C(n)V$ register value is the shift of the PWM pulse with respect to the beginning of FTM counter period (FTM counter = $CNTIN$).

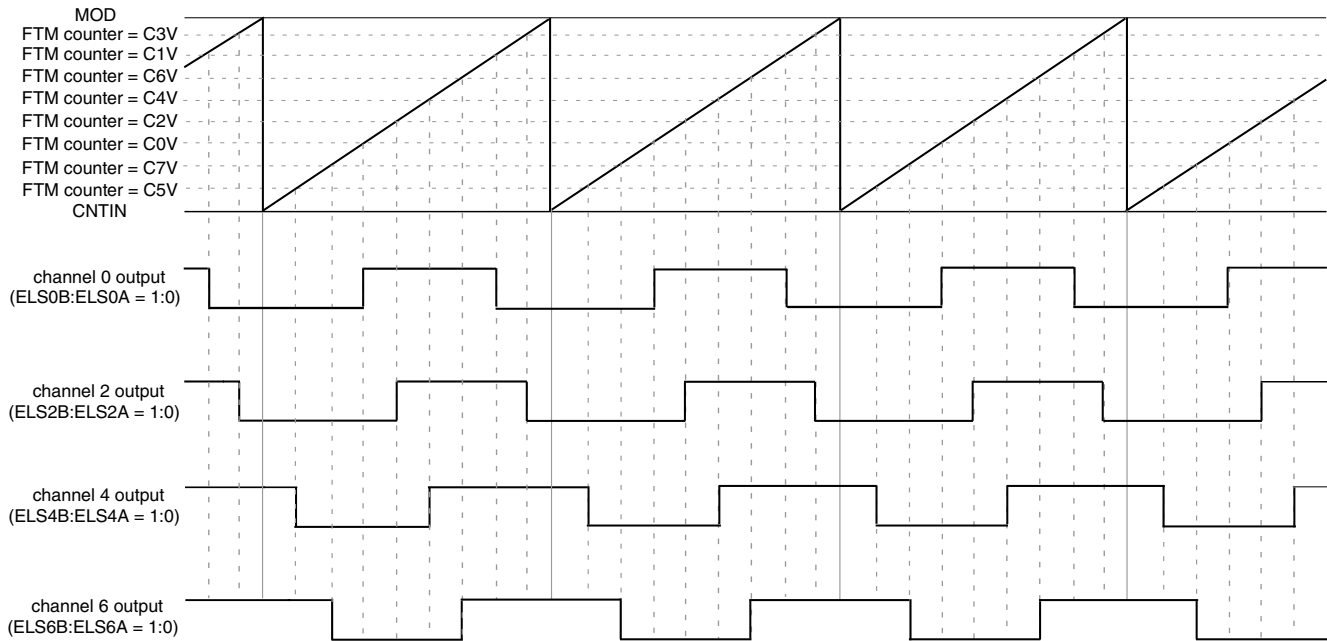

Figure 47-49. Example of Four Pairs of Channels in Modified Combine PWM Mode

47.5.10.1 Synchronization

In the Modified Combine Mode, the following registers should be updated when the FTM counter clock is disabled ($CLKS[1:0] = 0:0$).

- CNTIN (CNTIN register update)
- MOD (MOD and HCR registers update)
- C(n)V and C(n+1)V (CnV register update)

In the Modified Combine Mode, if ($FTMEN = 1$), ($CLKS[1:0] \neq 0:0$), and there was a write to the register C(n+1)V, then the register C(n+1)V is updated with its write buffer value on the next channel (n) match (FTM counter = C(n)V). This feature allows to vary the PWM duty cycle value in this mode.

NOTE

In the Modified Combine Mode, the bit SYNCEN(n) should be zero bit for the channels (n) and (n+1). So, the following features are not available for this mode.

- C(n)V and C(n+1)V register synchronization
- Reload Points
- Global Load

47.5.11 Complementary Mode

The Complementary mode is selected when:

- QUADEN = 0
- DECAPEN = 0
- COMP = 1

In Complementary mode, the channel (n+1) output is the inverse of the channel (n) output.

NOTE

The Complementary Mode is not available on [Output Compare mode](#).

The channel (n+1) output is the same as the channel (n) output when:

- QUADEN = 0
- DECAPEN = 0
- COMP = 0
- channels (n) and (n+1) are on Combine Mode or Modified Combine PWM Mode

The channel (n+1) output is independent from channel (n) output when:

- QUADEN = 0
- DECAPEN = 0
- COMP = 0
- channel (n) is on Output Compare Mode, EPWM or CPWM

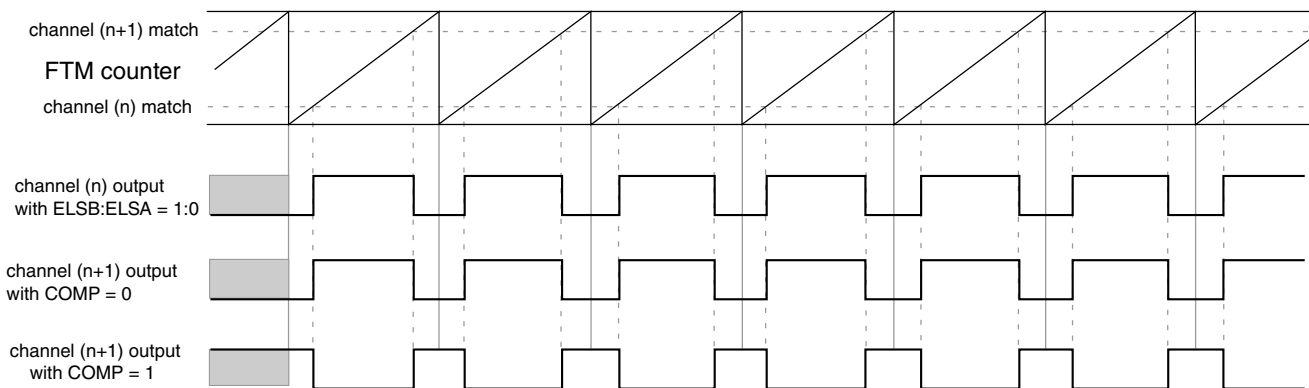

Figure 47-50. Channel (n+1) output in Complementary mode with (ELSB:ELSA = 1:0)

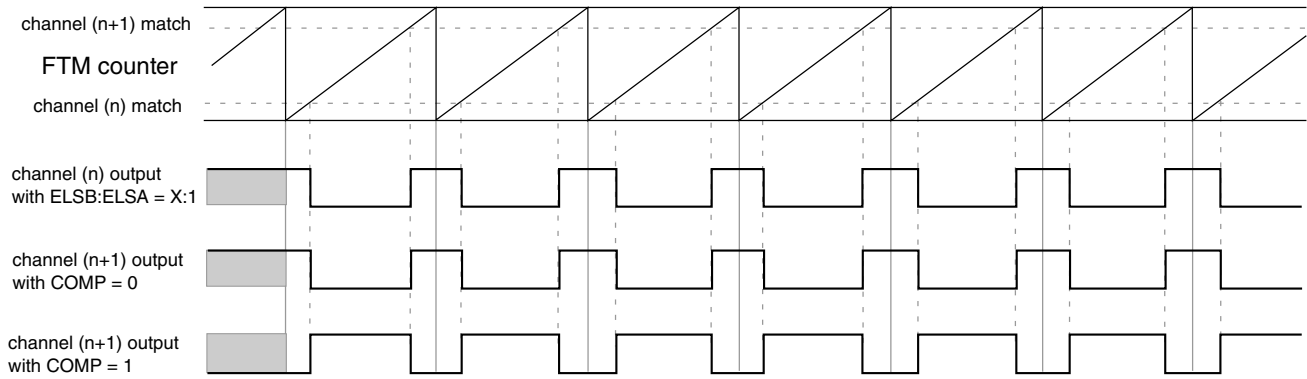

Figure 47-51. Channel (n+1) output in Complementary mode with (ELSB:ELSA = X:1)

47.5.12 Registers updated from write buffers

47.5.12.1 CNTIN register update

The following table describes when CNTIN register is updated:

Table 47-9. CNTIN register update

When	Then CNTIN register is updated
CLKS[1:0] = 0:0	When CNTIN register is written, independent of FTMEN bit.
<ul style="list-style-type: none"> • FTMEN = 0, or • CNTINC = 0 	At the next FTM input clock after CNTIN was written.
<ul style="list-style-type: none"> • FTMEN = 1, • SYNCMODE = 1, and • CNTINC = 1 	By the CNTIN register synchronization .
<ul style="list-style-type: none"> • CNTINC = 1, and • LDOK = 1 	By the Reload Points .

47.5.12.2 MOD and HCR registers update

The following table describes when MOD or HCR registers are updated:

Table 47-10. MOD and HCR updates

When	Then MOD or HCR is updated
CLKS[1:0] = 0:0	When MOD (or HCR) is written, independent of FTMEN bit.
<ul style="list-style-type: none"> • CLKS[1:0] ≠ 0:0, and • FTMEN = 0 	According to the CPWMS bit, that is:

Table continues on the next page...

Table 47-10. MOD and HCR updates (continued)

When	Then MOD or HCR is updated
	<ul style="list-style-type: none"> If the selected mode is not CPWM then MOD (or HCR) is updated after MOD (or HCR) register was written and the FTM counter changes from MOD to CNTIN. If the FTM counter is at free-running counter mode then this update occurs when the FTM counter changes from 0xFFFF to 0x0000. If the selected mode is CPWM then MOD (or HCR) register is updated after MOD (or HCR) register was written and the FTM counter changes from MOD to (MOD – 0x0001).
<ul style="list-style-type: none"> CLKS[1:0] ≠ 0:0, and FTMEN = 1 	By the MOD register synchronization . HCR follows the same procedure of MOD register in this case.
<ul style="list-style-type: none"> LDOK = 1 	By the Reload Points .

47.5.12.3 CnV register update

The following table describes when CnV register is updated:

Table 47-11. CnV register update

When	Then CnV register is updated
CLKS[1:0] = 0:0	When CnV register is written, independent of FTMEN bit.
<ul style="list-style-type: none"> CLKS[1:0] ≠ 0:0, and FTMEN = 0 	<p>According to the selected mode, that is:</p> <ul style="list-style-type: none"> If the selected mode is Output Compare, then CnV register is updated on the next FTM counter change, end of the prescaler counting, after CnV register was written. If the selected mode is EPWM, then CnV register is updated after CnV register was written and the FTM counter changes from MOD to CNTIN. If the FTM counter is at free-running counter mode then this update occurs when the FTM counter changes from 0xFFFF to 0x0000. If the selected mode is CPWM, then CnV register is updated after CnV register was written and the FTM counter changes from MOD to (MOD – 0x0001).
<ul style="list-style-type: none"> CLKS[1:0] ≠ 0:0, and FTMEN = 1 	<p>According to the selected mode, that is:</p> <ul style="list-style-type: none"> If the selected mode is output compare then CnV register is updated according to the SYNCEN bit. If (SYNCEN = 0) then CnV register is updated after CnV register was written at the next change of the FTM counter, the end of the prescaler counting. If (SYNCEN = 1) then CnV register is updated by the C(n)V and C(n+1)V register synchronization. If the selected mode is not output compare and (SYNCEN = 1) then CnV register is updated by the C(n)V and C(n+1)V register synchronization.
<ul style="list-style-type: none"> SYNCEN = 1, and LDOK = 1 	By the Reload Points .

47.5.13 PWM synchronization

The PWM synchronization provides an opportunity to update the MOD, HCR, CNTIN, CnV, OUTMASK, INVCTRL and SWOCTRL registers with their buffered value and force the FTM counter to the CNTIN register value.

Note

The legacy PWM synchronization (SYNCMODE = 0) is a subset of the enhanced PWM synchronization (SYNCMODE = 1). Thus, only the enhanced PWM synchronization must be used.

47.5.13.1 Hardware trigger

Three hardware trigger signal inputs of the FTM module are enabled when TRIGN = 1, where n = 0, 1 or 2 corresponding to each one of the input signals, respectively. The hardware trigger input n is synchronized by the FTM input clock. The PWM synchronization with hardware trigger is initiated when a rising edge is detected at the enabled hardware trigger inputs.

If (HWTRIGMODE = 0) then the TRIGN bit is cleared when 0 is written to it or when the trigger n event is detected.

In this case, if two or more hardware triggers are enabled (for example, TRIG0 and TRIG1 = 1) and only trigger 1 event occurs, then only TRIG1 bit is cleared. If a trigger n event occurs together with a write setting TRIGN bit, then the synchronization is initiated, but TRIGN bit remains set due to the write operation.

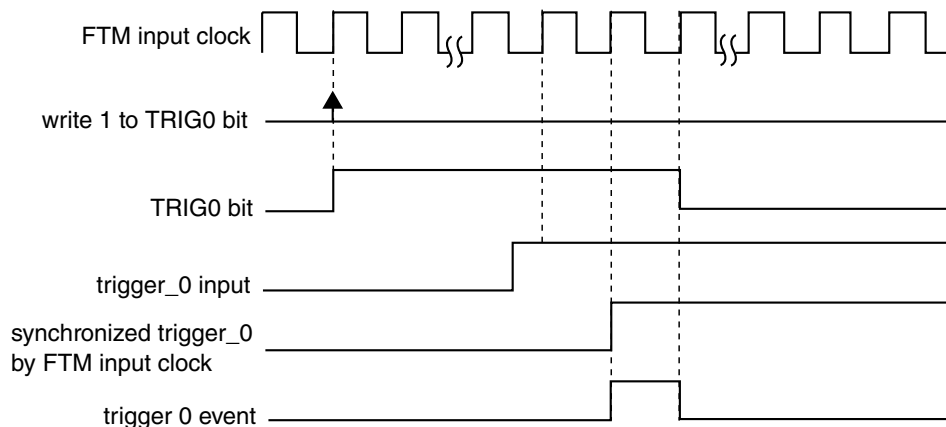

Note
All hardware trigger inputs have the same behavior.

Figure 47-52. Hardware trigger event with HWTRIGMODE = 0

If HWTRIGMODE = 1, then the TRIGn bit is only cleared when 0 is written to it.

NOTE

The HWTRIGMODE bit must be 1 only with enhanced PWM synchronization (SYNCMODE = 1).

47.5.13.2 Software trigger

A software trigger event occurs when 1 is written to the SYNC[SWSYNC] bit. The SWSYNC bit is cleared when 0 is written to it or when the PWM synchronization, initiated by the software event, is completed.

If another software trigger event occurs (by writing another 1 to the SWSYNC bit) at the same time the PWM synchronization initiated by the previous software trigger event is ending, a new PWM synchronization is started and the SWSYNC bit remains equal to 1.

If SYNCMODE = 0 then the SWSYNC bit is also cleared by FTM according to PWMSYNC and REINIT bits. In this case if (PWMSYNC = 1) or (PWMSYNC = 0 and REINIT = 0) then SWSYNC bit is cleared at the next selected loading point after that the software trigger event occurred; see [Synchronization Points](#) and the following figure. If (PWMSYNC = 0) and (REINIT = 1) then SWSYNC bit is cleared when the software trigger event occurs.

If SYNCMODE = 1 then the SWSYNC bit is also cleared by FTM according to the SWRSTCNT bit. If SWRSTCNT = 0 then SWSYNC bit is cleared at the next selected loading point after that the software trigger event occurred; see the following figure. If SWRSTCNT = 1 then SWSYNC bit is cleared when the software trigger event occurs.

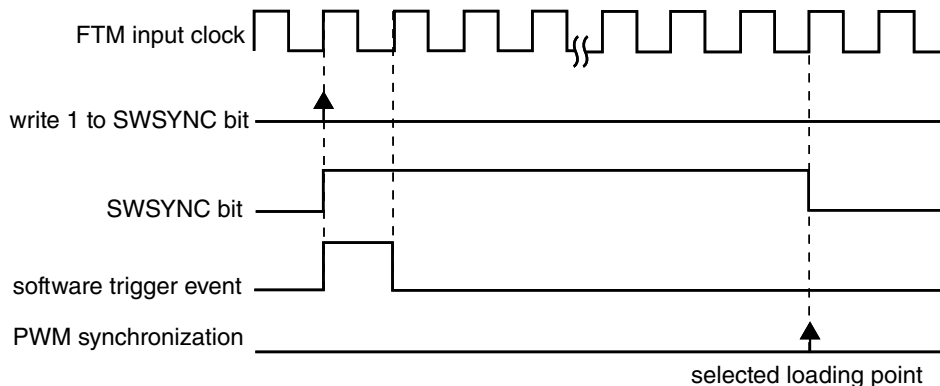

Figure 47-53. Software trigger event

47.5.13.3 Synchronization Points

The synchronization points are points where the registers can be updated with their write buffer by PWM synchronization. These synchronization points are safe points because guarantee smooth transitions in the generated PWM signals.

In **Up counting**, the synchronization points are when the FTM counter changes from MOD to CNTIN. In this case, the synchronization points are enabled if (CNTMIN = 1) or (CNTMAX = 1).

In **Up-down counting**, the synchronization points are:

- if (CNTMAX = 1), when the FTM counter changes from (MOD) to (MOD - 1);
- if (CNTMIN = 1), when the FTM counter changes from (CNTIN) to (CNTIN + 1).

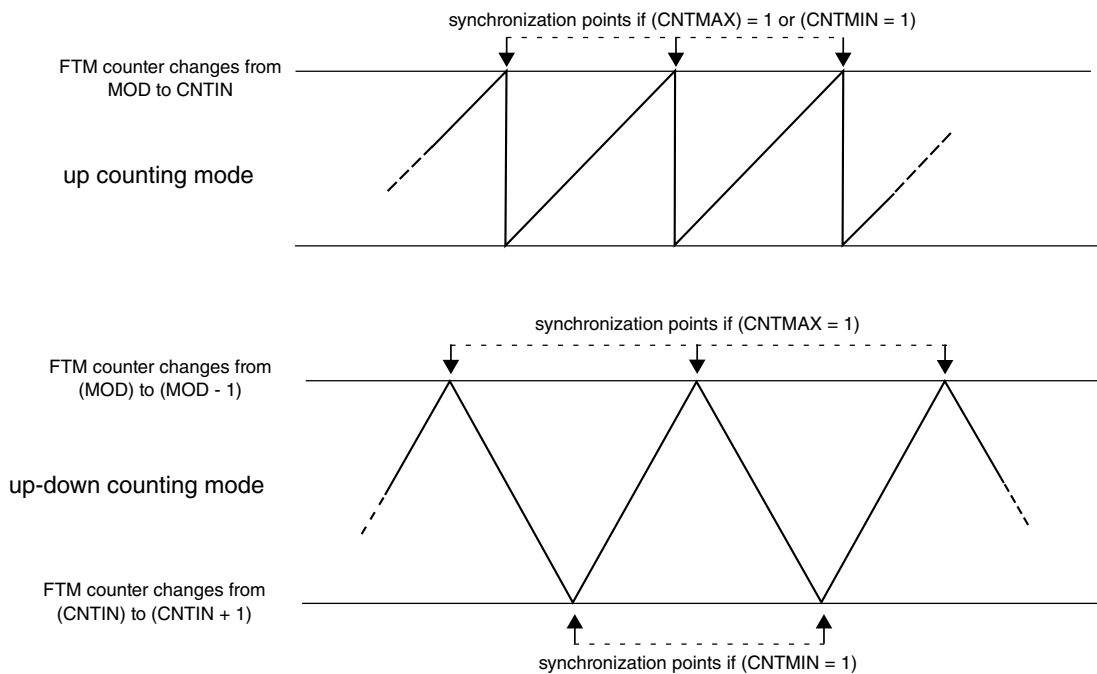

Figure 47-54. Synchronization Points

47.5.13.4 MOD register synchronization

The MOD register synchronization updates the MOD register with its buffer value. This synchronization is enabled if (FTMEN = 1).

The MOD register synchronization can be done by either the enhanced PWM synchronization (SYNCMODE = 1) or the legacy PWM synchronization (SYNCMODE = 0). However, it is expected that the MOD register be synchronized only by the enhanced PWM synchronization.

Functional Description

In the case of enhanced PWM synchronization, the MOD register synchronization depends on SWWRBUF, SWRSTCNT, HWWRBUF, and HWRSTCNT bits according to this flowchart:

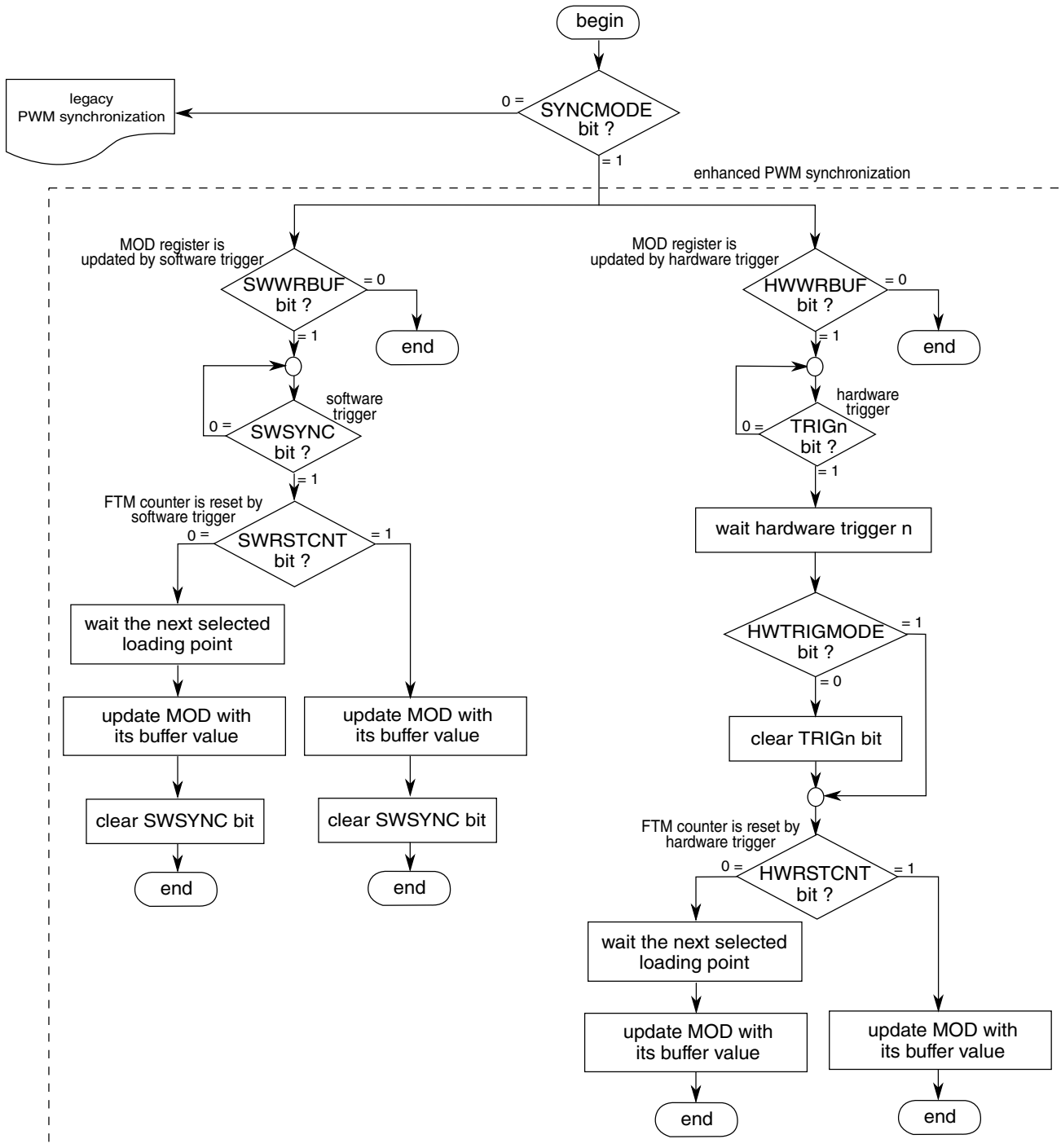

Figure 47-55. MOD register synchronization flowchart

In the case of legacy PWM synchronization, the MOD register synchronization depends on PWMSYNC and REINIT bits according to the following description.

If ($\text{SYNCMODE} = 0$), ($\text{PWMSYNC} = 0$), and ($\text{REINIT} = 0$), then this synchronization is made on the next selected loading point after an enabled trigger event takes place. If the trigger event was a software trigger, then the SWSYNC bit is cleared on the next selected loading point. If the trigger event was a hardware trigger, then the trigger enable bit (TRIGn) is cleared according to [Hardware trigger](#). Examples with software and hardware triggers follow.

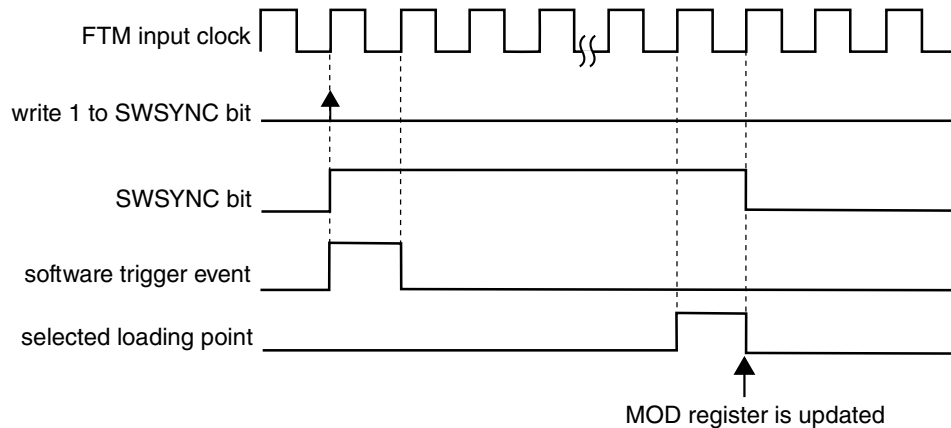

Figure 47-56. MOD synchronization with ($\text{SYNCMODE} = 0$), ($\text{PWMSYNC} = 0$), ($\text{REINIT} = 0$), and software trigger was used

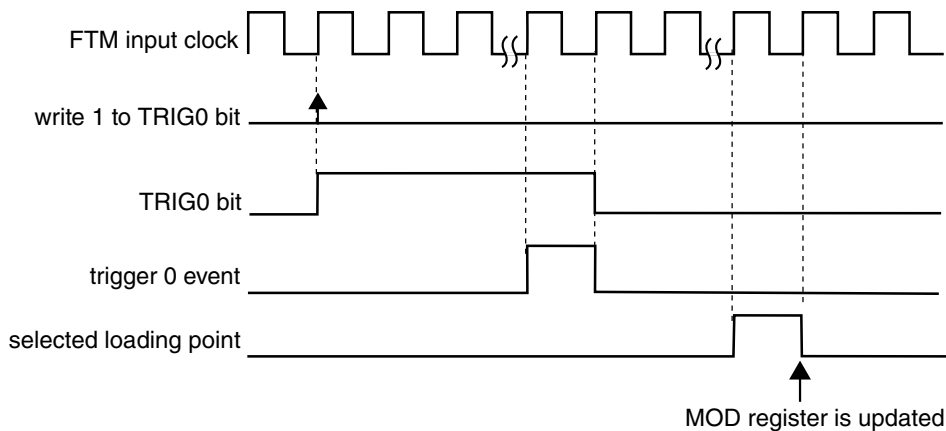

Figure 47-57. MOD synchronization with ($\text{SYNCMODE} = 0$), ($\text{HWTRIGMODE} = 0$), ($\text{PWMSYNC} = 0$), ($\text{REINIT} = 0$), and a hardware trigger was used

If ($\text{SYNCMODE} = 0$), ($\text{PWMSYNC} = 0$), and ($\text{REINIT} = 1$), then this synchronization is made on the next enabled trigger event. If the trigger event was a software trigger, then the SWSYNC bit is cleared according to the following example. If the trigger event was a hardware trigger, then the TRIGn bit is cleared according to [Hardware trigger](#). Examples with software and hardware triggers follow.

Functional Description

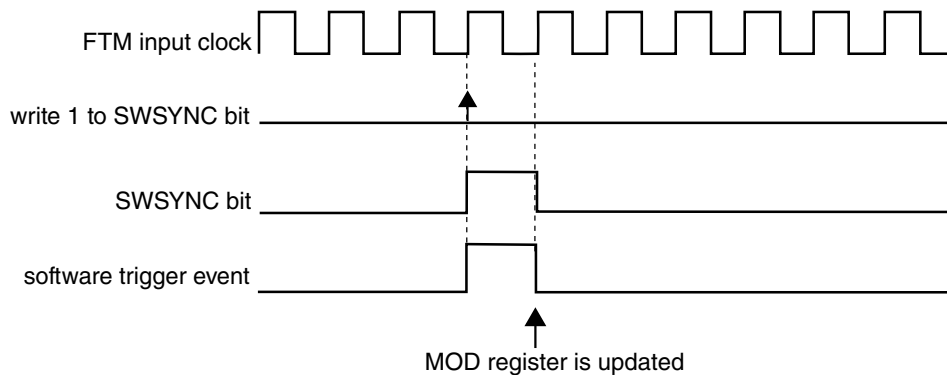

Figure 47-58. MOD synchronization with (SYNCMODE = 0), (PWMSYNC = 0), (REINIT = 1), and software trigger was used

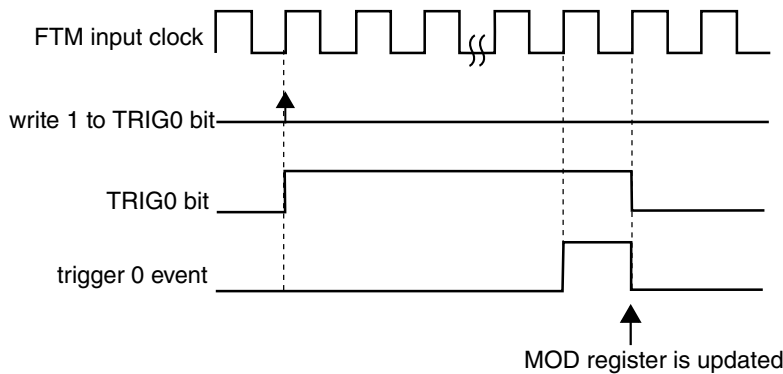

Figure 47-59. MOD synchronization with (SYNCMODE = 0), (HWTRIGMODE = 0), (PWMSYNC = 0), (REINIT = 1), and a hardware trigger was used

If (SYNCMODE = 0) and (PWMSYNC = 1), then this synchronization is made on the next selected loading point after the software trigger event takes place. The SWSYNC bit is cleared on the next selected loading point:

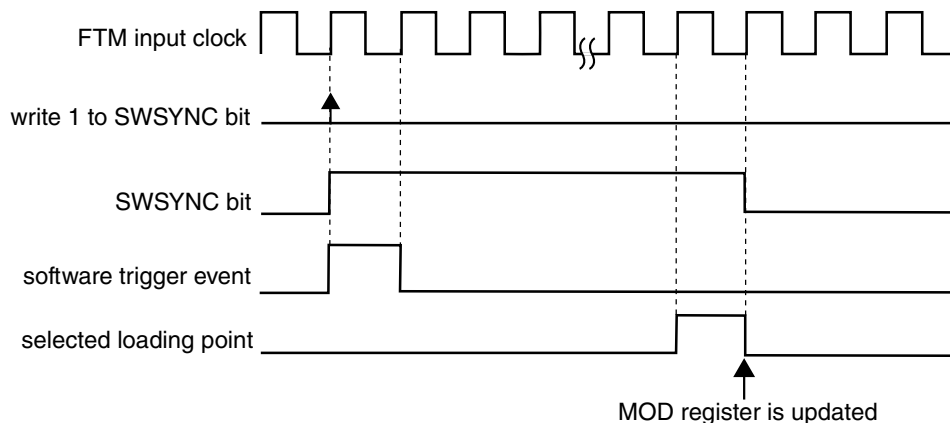

Figure 47-60. MOD synchronization with (SYNCMODE = 0) and (PWMSYNC = 1)

47.5.13.5 CNTIN register synchronization

The CNTIN register synchronization updates the CNTIN register with its buffer value.

This synchronization is enabled if (FTMEN = 1), (SYNCMODE = 1), and (CNTINC = 1). The CNTIN register synchronization can be done only by the enhanced PWM synchronization (SYNCMODE = 1). The synchronization mechanism is the same as the MOD register synchronization done by the enhanced PWM synchronization; see [MOD register synchronization](#).

47.5.13.6 C(n)V and C(n+1)V register synchronization

The C(n)V and C(n+1)V registers synchronization updates the C(n)V and C(n+1)V registers with their buffer values.

This synchronization is enabled if (FTMEN = 1) and (SYNCEN = 1). The synchronization mechanism is the same as the [MOD register synchronization](#). However, it is expected that the C(n)V and C(n+1)V registers be synchronized only by the enhanced PWM synchronization (SYNCMODE = 1).

47.5.13.7 OUTMASK register synchronization

The OUTMASK register synchronization updates the OUTMASK register with its buffer value.

The OUTMASK register can be updated at each rising edge of FTM input clock (SYNCHOM = 0), by the enhanced PWM synchronization (SYNCHOM = 1 and SYNCMODE = 1) or by the legacy PWM synchronization (SYNCHOM = 1 and SYNCMODE = 0). However, it is expected that the OUTMASK register be synchronized only by the enhanced PWM synchronization.

In the case of enhanced PWM synchronization, the OUTMASK register synchronization depends on SWOM and HWOM bits. See the following flowchart:

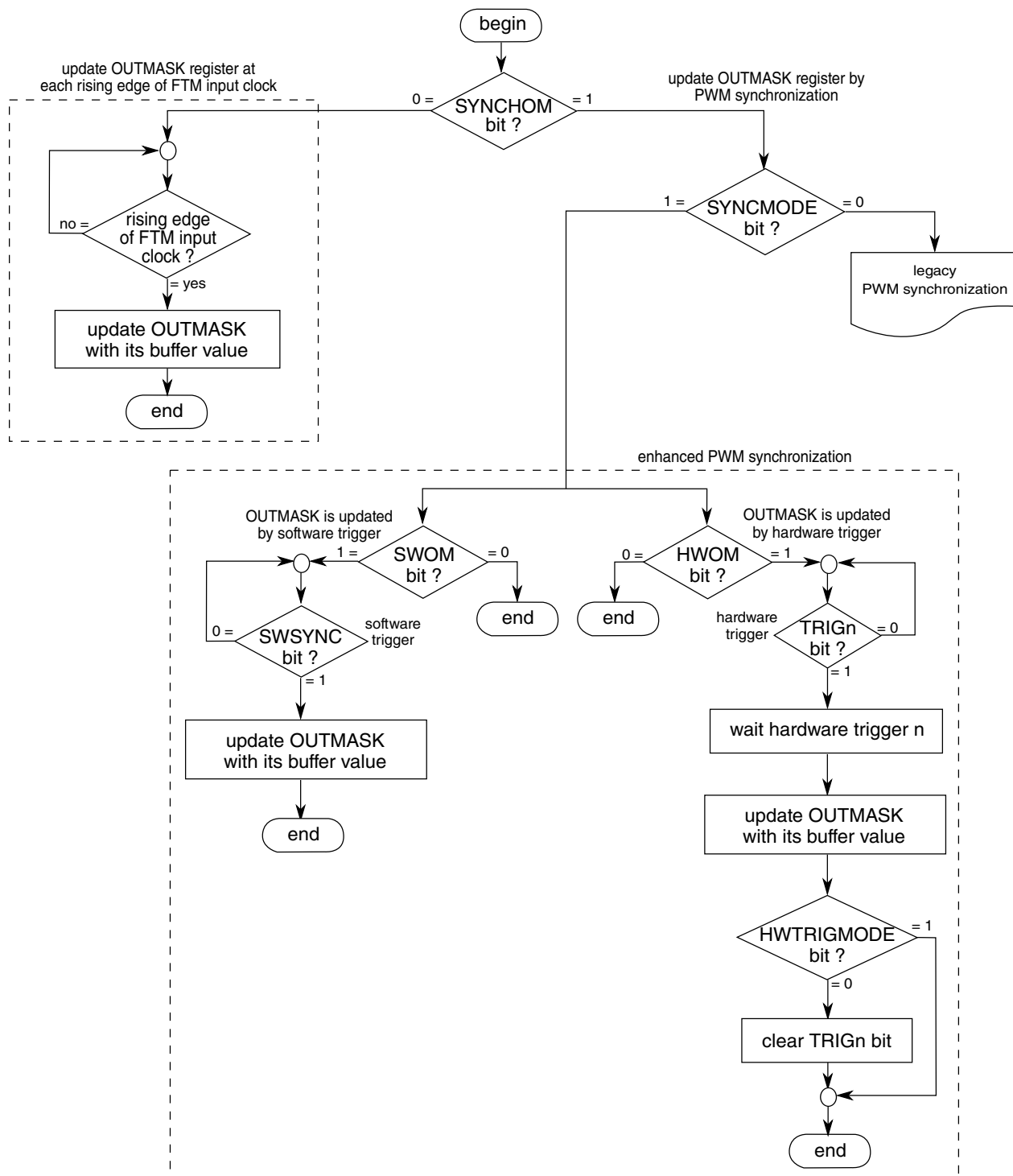

Figure 47-61. OUTMASK register synchronization flowchart

In the case of legacy PWM synchronization, the OUTMASK register synchronization depends on PWMSYNC bit according to the following description.

If ($\text{SYNCMODE} = 0$), ($\text{SYNCHOM} = 1$), and ($\text{PWMSYNC} = 0$), then this synchronization is done on the next enabled trigger event. If the trigger event was a software trigger, then the SWSYNC bit is cleared on the next selected loading point. If the trigger event was a hardware trigger, then the TRIGN bit is cleared according to [Hardware trigger](#). Examples with software and hardware triggers follow.

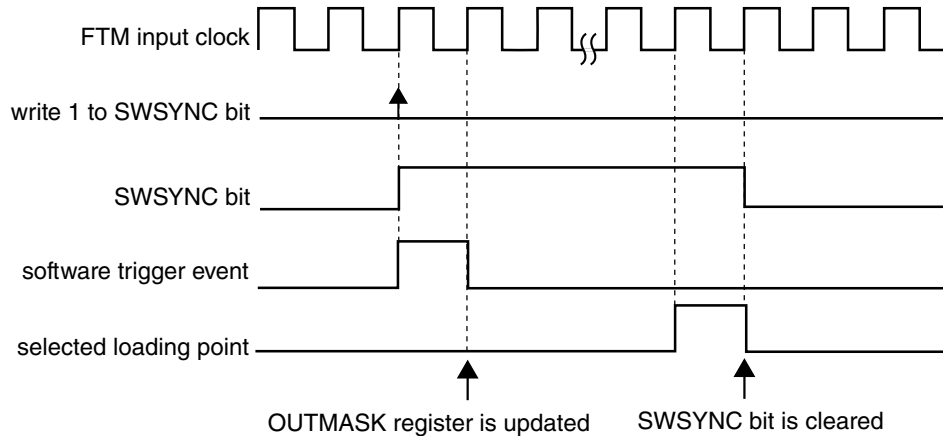

Figure 47-62. OUTMASK synchronization with ($\text{SYNCMODE} = 0$), ($\text{SYNCHOM} = 1$), ($\text{PWMSYNC} = 0$) and software trigger was used

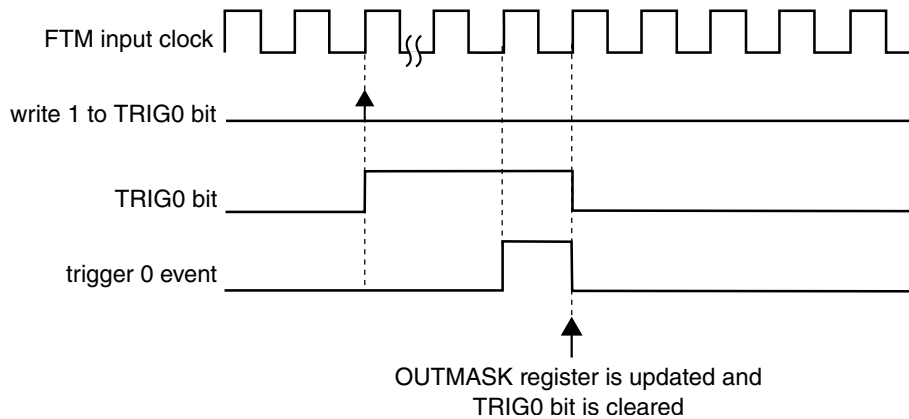

Figure 47-63. OUTMASK synchronization with ($\text{SYNCMODE} = 0$), ($\text{HWTRIGMODE} = 0$), ($\text{SYNCHOM} = 1$), ($\text{PWMSYNC} = 0$), and a hardware trigger was used

If ($\text{SYNCMODE} = 0$), ($\text{SYNCHOM} = 1$), and ($\text{PWMSYNC} = 1$), then this synchronization is made on the next enabled hardware trigger. The TRIGN bit is cleared according to [Hardware trigger](#). An example with a hardware trigger follows.

Functional Description

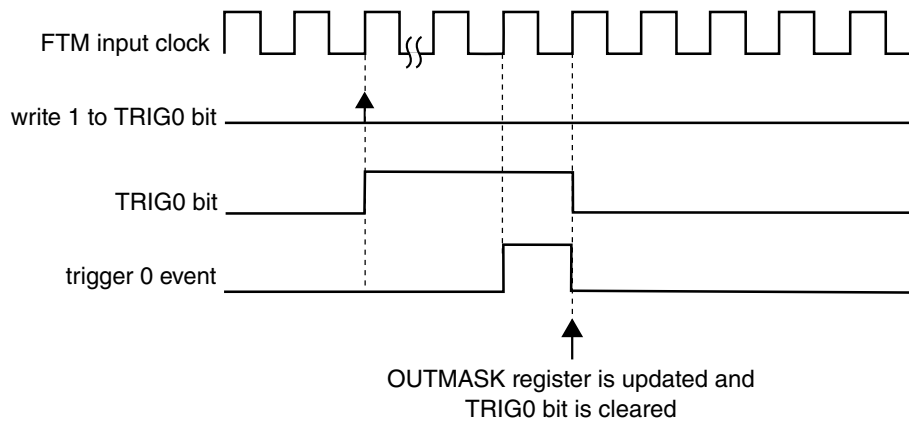

Figure 47-64. OUTMASK synchronization with (SYNCMODE = 0), (HWTRIGMODE = 0), (SYNCHOM = 1), (PWMSYNC = 1), and a hardware trigger was used

47.5.13.8 INVCTRL register synchronization

The INVCTRL register synchronization updates the INVCTRL register with its buffer value.

The INVCTRL register can be updated at each rising edge of FTM input clock (INVC = 0) or by the enhanced PWM synchronization (INVC = 1 and SYNCMODE = 1) according to the following flowchart.

In the case of enhanced PWM synchronization, the INVCTRL register synchronization depends on SWINVC and HWINVC bits.

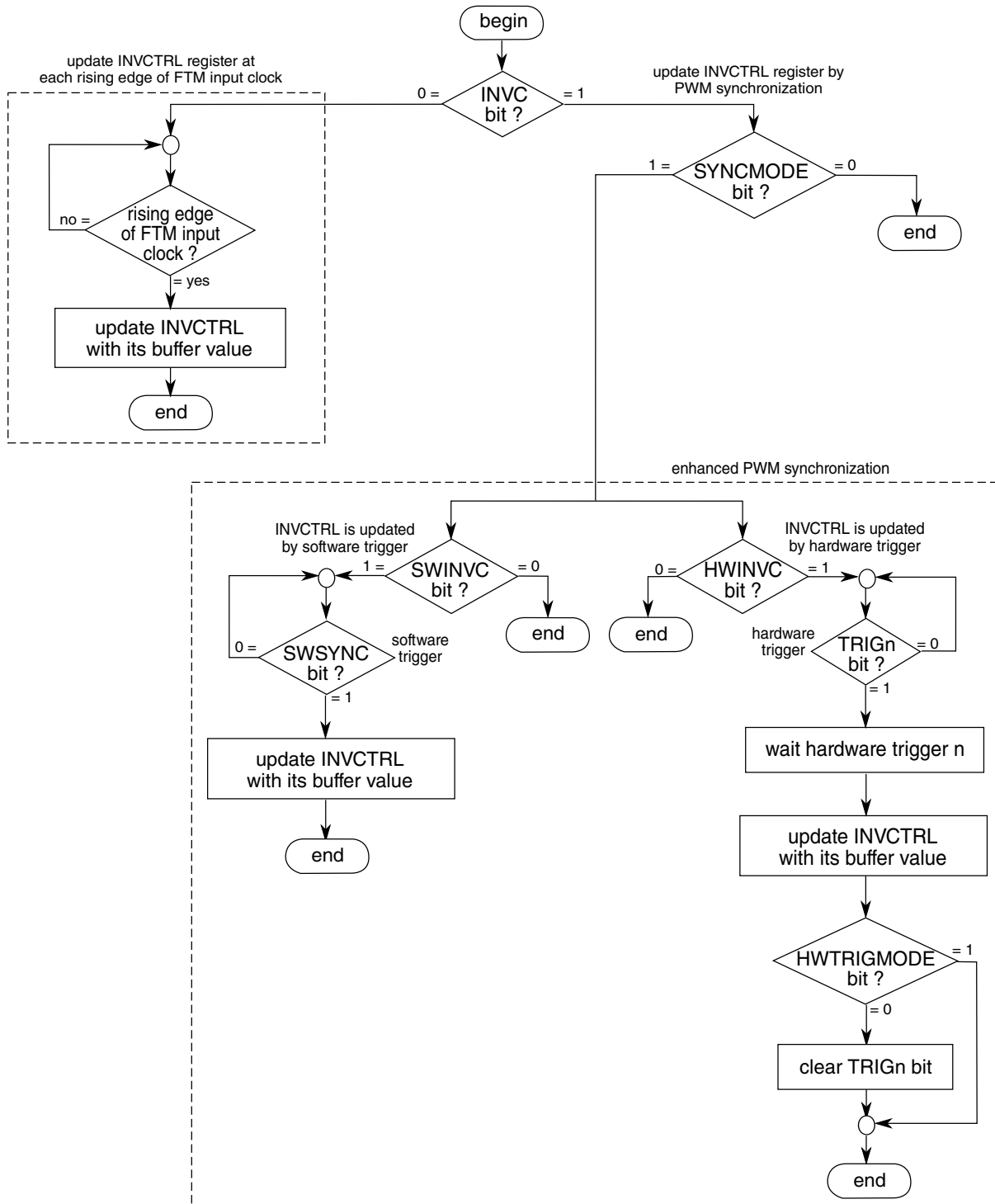

Figure 47-65. INVCTRL register synchronization flowchart

47.5.13.9 SWOCTRL register synchronization

The SWOCTRL register synchronization updates the SWOCTRL register with its buffer value.

Functional Description

The SWOCTRL register can be updated at each rising edge of FTM input clock (SWOC = 0) or by the enhanced PWM synchronization (SWOC = 1 and SYNCMODE = 1) according to the following flowchart.

In the case of enhanced PWM synchronization, the SWOCTRL register synchronization depends on SWSOC and HWSOC bits.

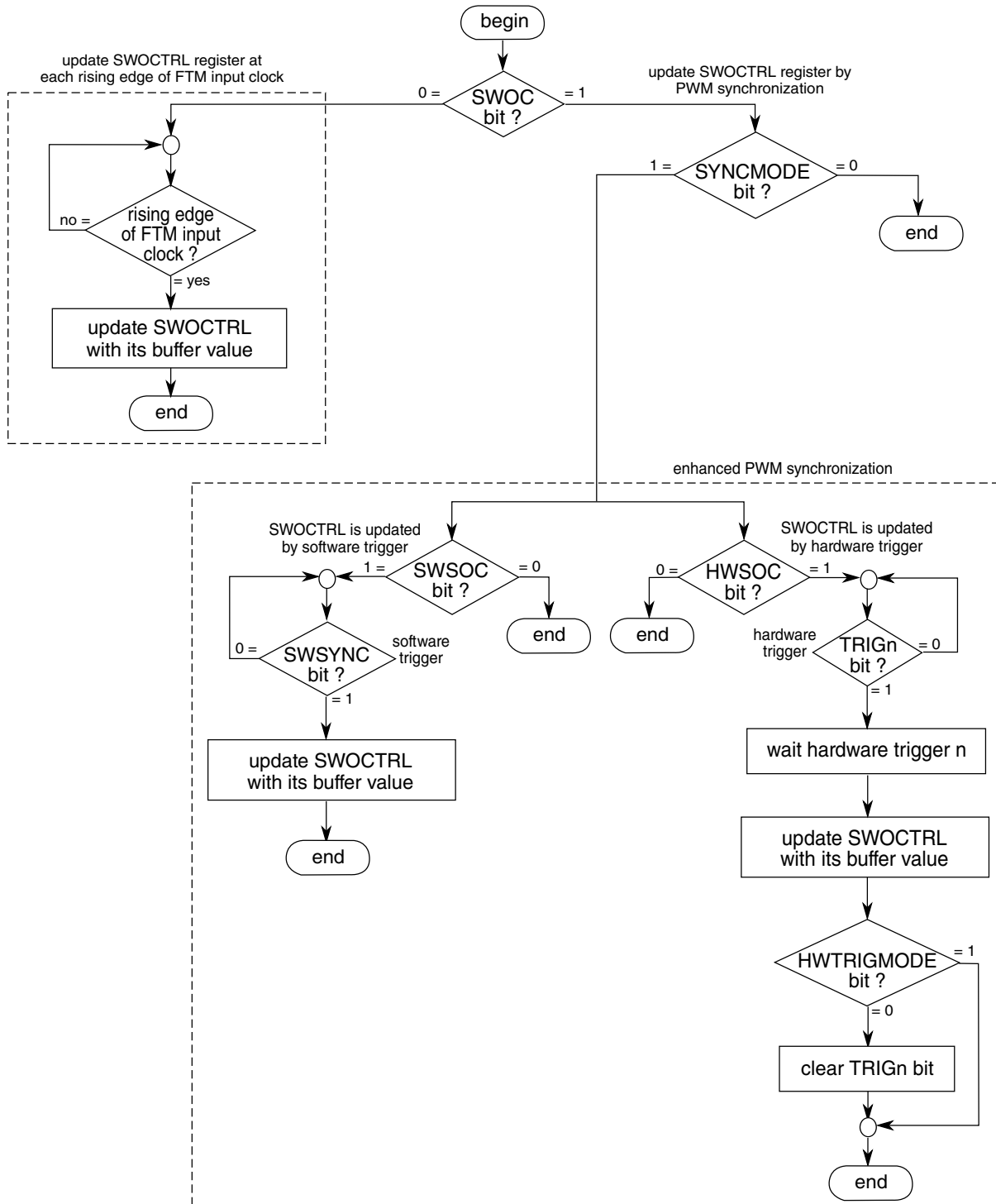

Figure 47-66. SWOCTRL register synchronization flowchart

47.5.13.10 FTM counter synchronization

The FTM counter synchronization is a mechanism that allows the FTM to restart the PWM generation at a certain point in the PWM period. The channels outputs are forced to their initial value, except for channels in Output Compare mode, and the FTM counter is forced to its initial counting value defined by CNTIN register.

The following figure shows the FTM counter synchronization. Note that after the synchronization event occurs, the channel (n) is set to its initial value and the channel (n+1) is not set to its initial value due to a specific timing of this figure in which the deadtime insertion prevents this channel output from transitioning to 1. If no deadtime insertion is selected, then the channel (n+1) transitions to logical value 1 immediately after the synchronization event occurs.

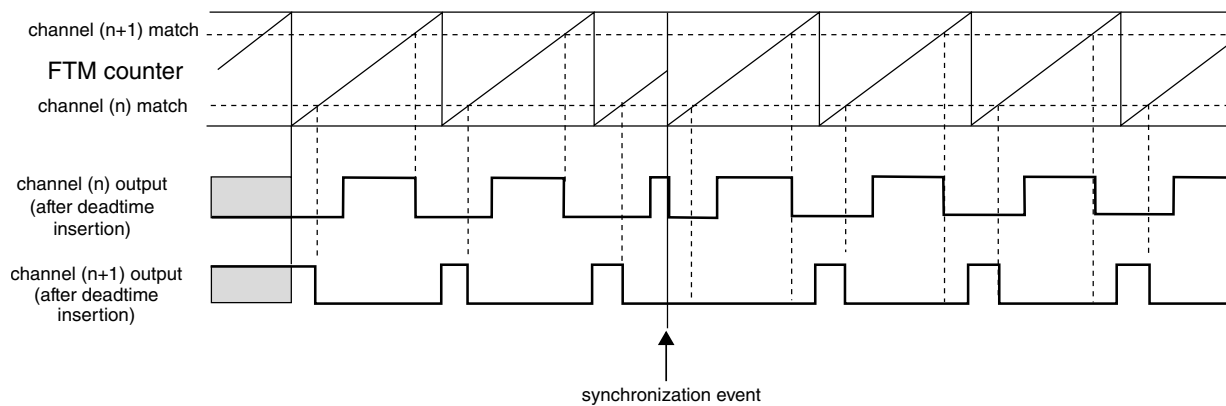

Figure 47-67. FTM counter synchronization

The FTM counter synchronization can be done by either the enhanced PWM synchronization (SYNCMODE = 1) or the legacy PWM synchronization (SYNCMODE = 0). However, the FTM counter must be synchronized only by the enhanced PWM synchronization.

In the case of enhanced PWM synchronization, the FTM counter synchronization depends on SWRSTCNT and HWRSTCNT bits according to the following flowchart.

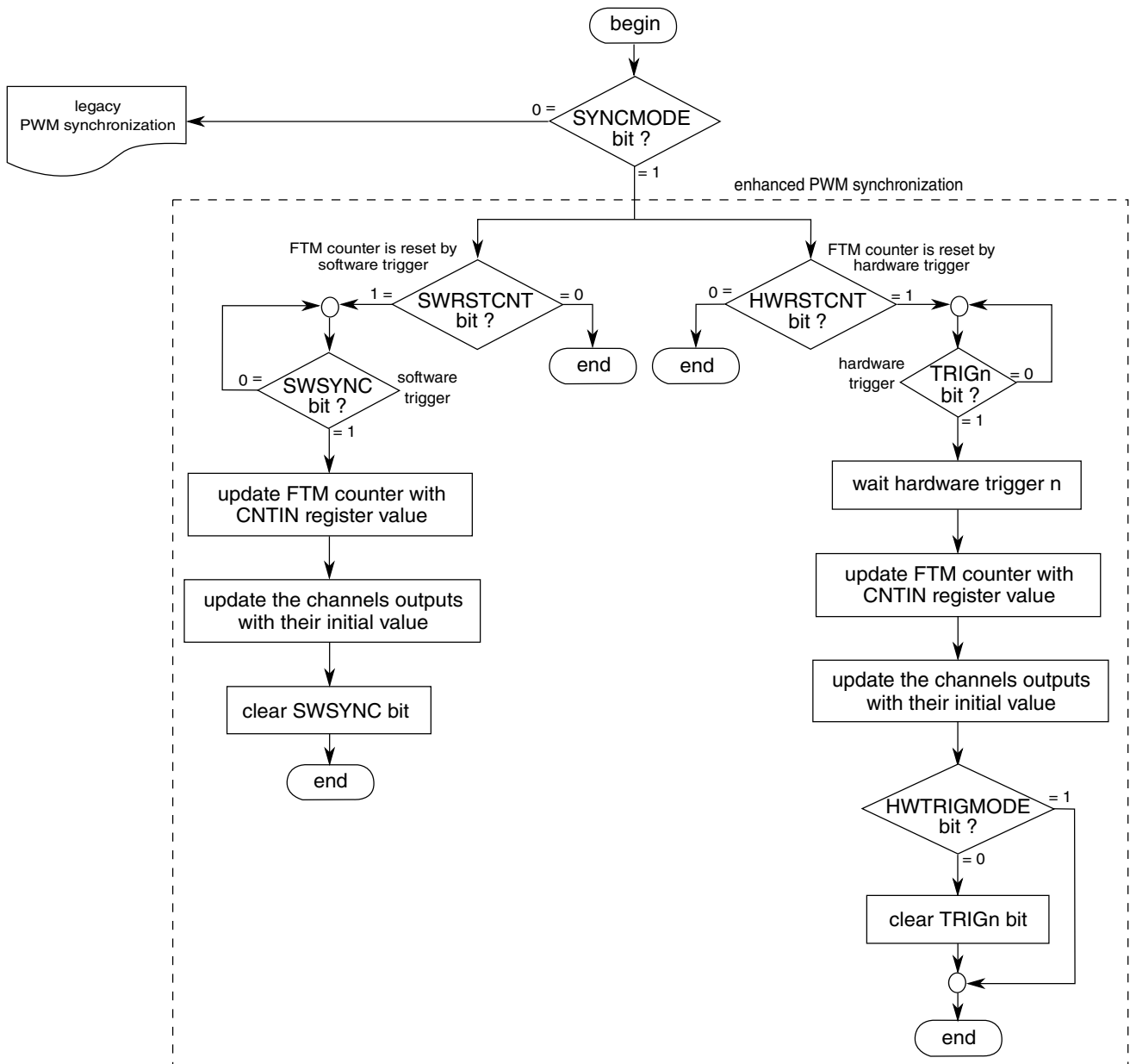

Figure 47-68. FTM counter synchronization flowchart

In the case of legacy PWM synchronization, the FTM counter synchronization depends on REINIT and PWMSYNC bits according to the following description.

If (SYNCMODE = 0), (REINIT = 1), and (PWMSYNC = 0) then this synchronization is made on the next enabled trigger event. If the trigger event was a software trigger then the SWSYNC bit is cleared according to the following example. If the trigger event was a hardware trigger then the TRIGN bit is cleared according to [Hardware trigger](#). Examples with software and hardware triggers follow.

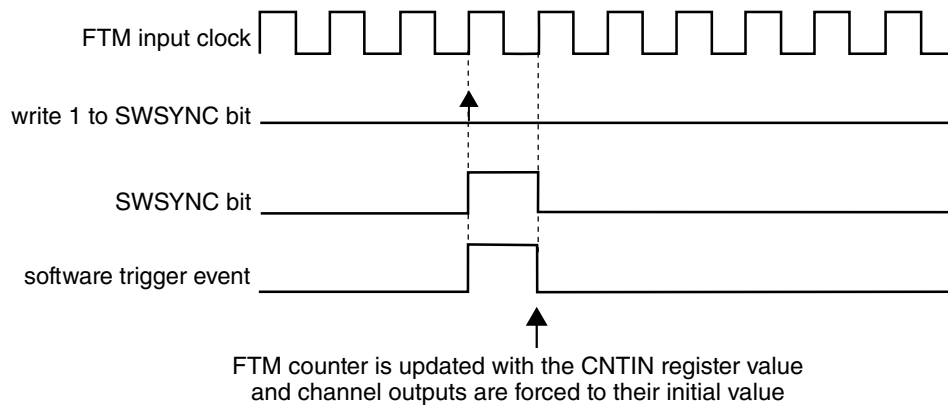

Figure 47-69. FTM counter synchronization with (SYNCMODE = 0), (REINIT = 1), (PWMSYNC = 0), and software trigger was used

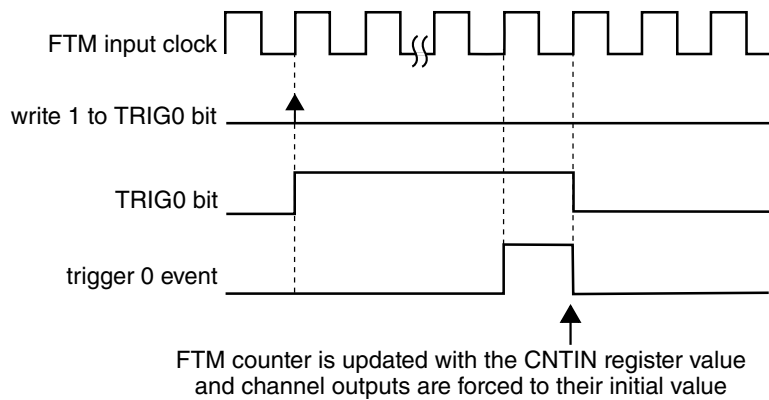

Figure 47-70. FTM counter synchronization with (SYNCMODE = 0), (HWTRIGMODE = 0), (REINIT = 1), (PWMSYNC = 0), and a hardware trigger was used

If (SYNCMODE = 0), (REINIT = 1), and (PWMSYNC = 1) then this synchronization is made on the next enabled hardware trigger. The TRIGn bit is cleared according to [Hardware trigger](#).

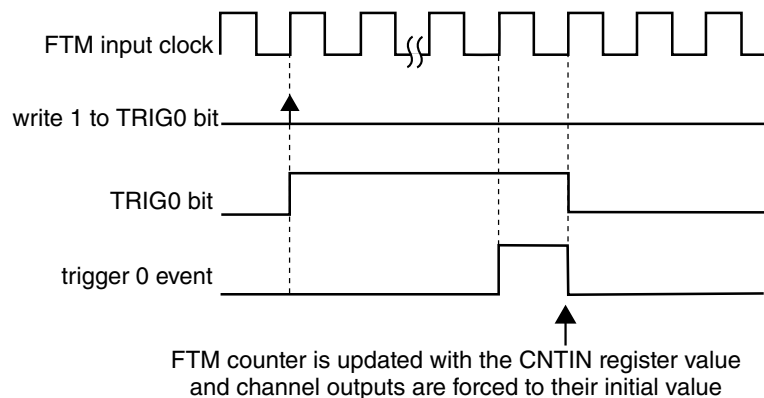

Figure 47-71. FTM counter synchronization with (SYNCMODE = 0), (HWTRIGMODE = 0), (REINIT = 1), (PWMSYNC = 1), and a hardware trigger was used

47.5.14 Inverting

The invert functionality swaps the signals between channel (n) and channel (n+1) outputs. The inverting operation is selected when:

- QUADEN = 0
- DECAPEN = 0
- COMP = 1, and
- INV_m = 1 (where m represents a channel pair)

The INV_m bit in INVCTRL register is updated with its buffer value according to [INVCTRL register synchronization](#).

In combine mode with channel (n) ELSB:ELSA = 1:0, the channel (n) output is forced low at the beginning of the period (FTM counter = CNTIN), forced high at the channel (n) match and forced low at the channel (n+1) match. If the inverting is selected, the channel (n) output behavior is changed to force high at the beginning of the PWM period, force low at the channel (n) match and force high at the channel (n+1) match. See the following figure.

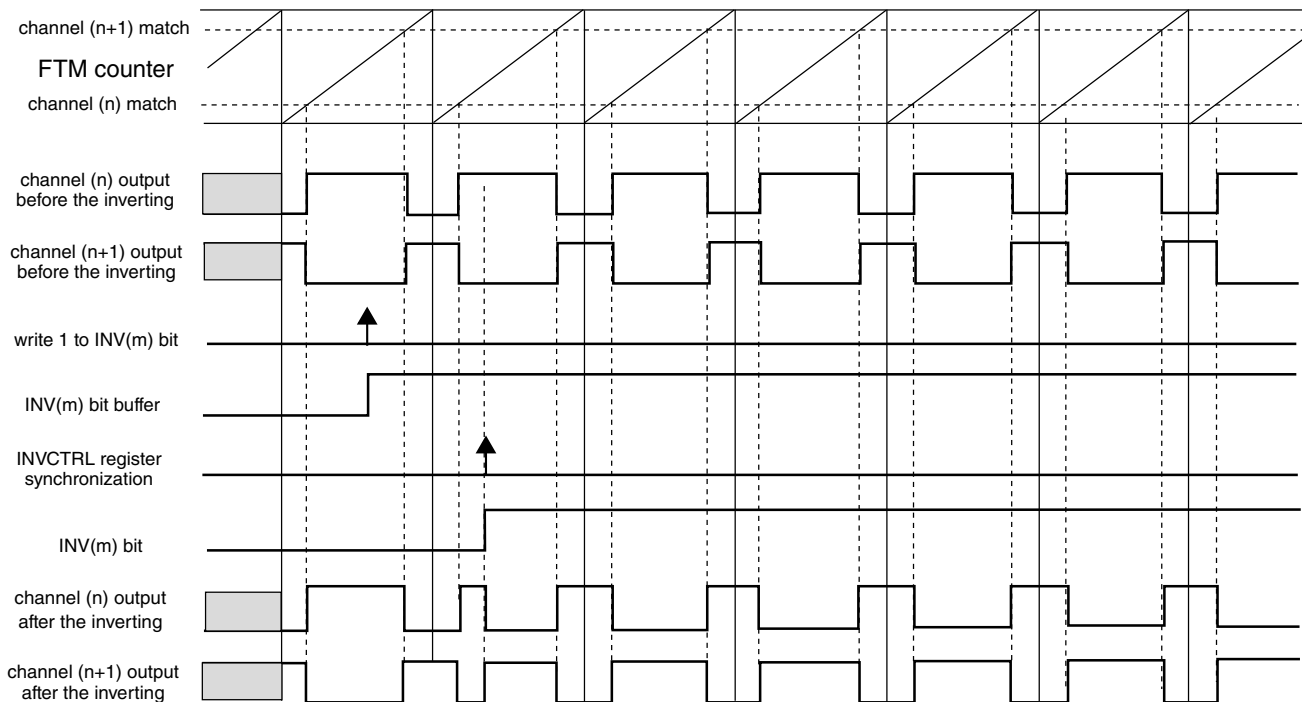

NOTE
INV(m) bit selects the inverting to the pair channels (n) and (n+1).

Figure 47-72. Channels (n) and (n+1) outputs after the inverting in combine mode with channel (n) ELSB:ELSA = 1:0

Note that the channel (n) ELSB:ELSA bits should be considered because they define the active state of the channels outputs. In combine mode with channel (n) ELSB:ELSA = X:1, the channel (n) output is forced high at the beginning of the period, forced low at the channel (n) match and forced high at the channel (n+1) match. When inverting is selected, the channels (n) and (n+1) present waveforms as shown in the following figure.

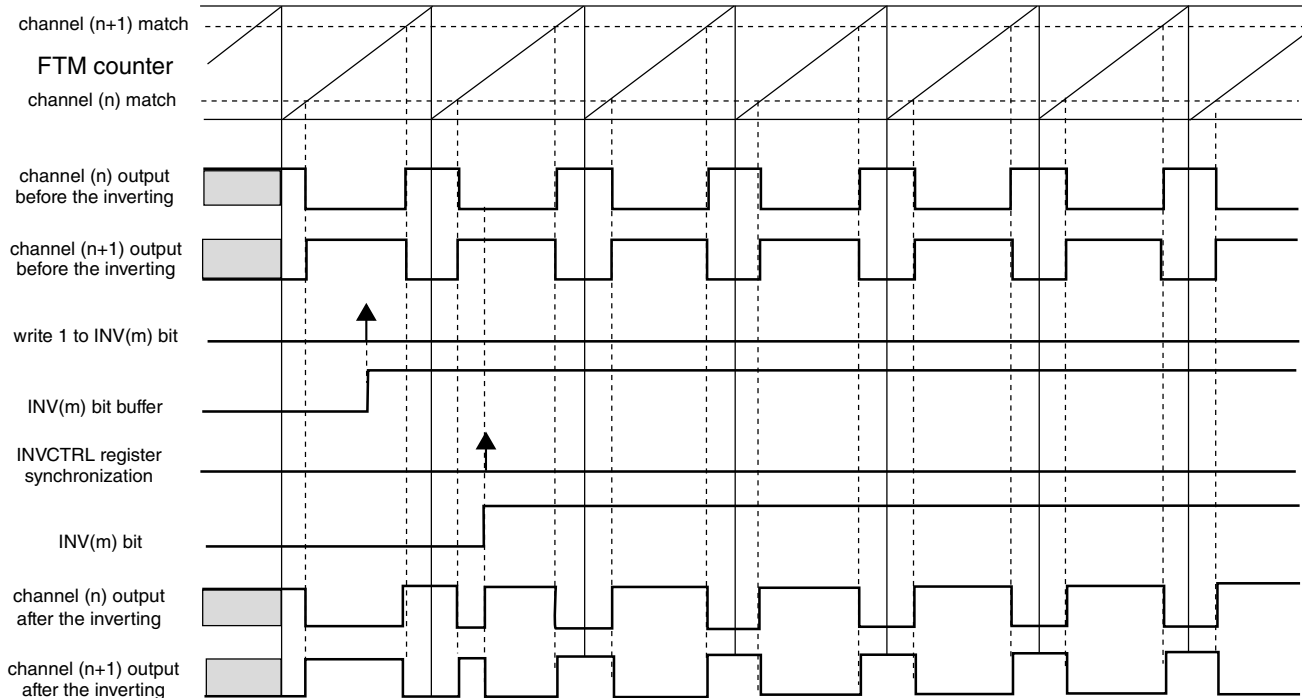

NOTE
INV(m) bit selects the inverting to the pair channels (n) and (n+1).

Figure 47-73. Channels (n) and (n+1) outputs after the inverting in combine mode with channel (n) ELSB:ELSA = X:1

NOTE

The Inverting is not available in [Output Compare mode](#) and [Modified Combine PWM Mode](#).

47.5.15 Software Output Control Mode

The software output control forces the channel output according to software defined values at a specific time in the PWM generation.

The software output control is selected when:

- QUADEN = 0
- DECAPEN = 0, and
- CH(n)OC = 1

Functional Description

The CH(n)OC bit enables the software output control for a specific channel output and the CH(n)OCV selects the value that is forced to this channel output.

Both CH(n)OC and CH(n)OCV bits in SWOCTRL register are buffered and updated with their buffer value according to [SWOCTRL register synchronization](#).

The following figure shows the channels (n) and (n+1) outputs signals when the software output control is used. In this case the channels (n) and (n+1) are set to Combine and Complementary mode.

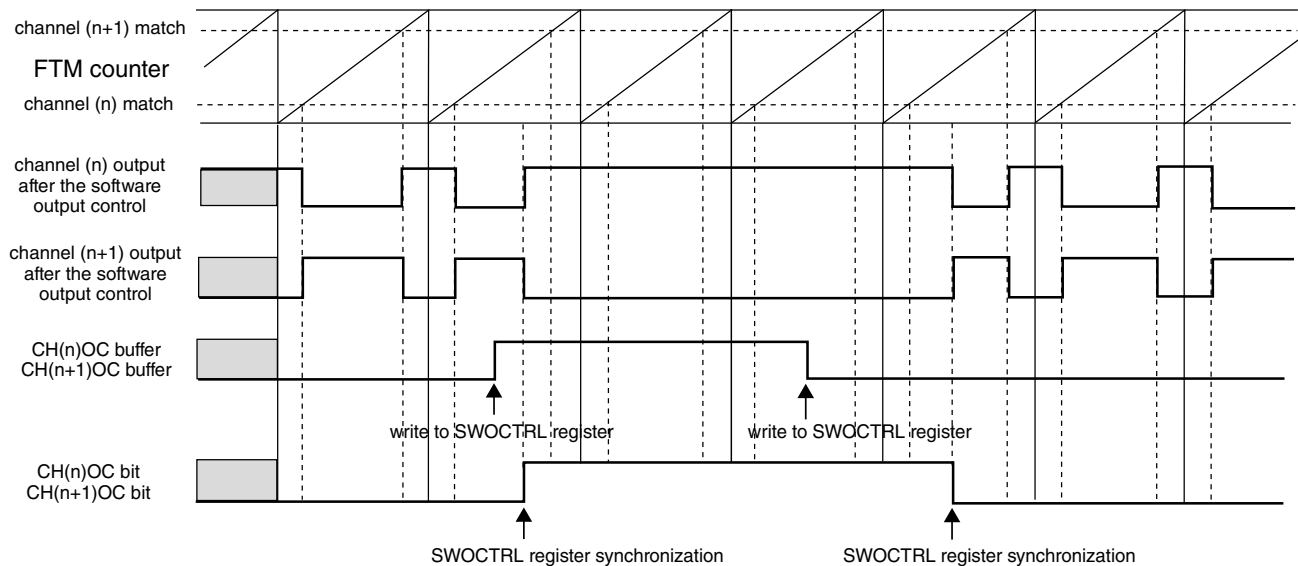

NOTE
Channel (n) ELSB:ELSA = X:1, CH(n)OCV = 1 and CH(n+1)OCV = 0.

Figure 47-74. Example of software output control in Combine and Complementary mode

Software output control forces the following values on channels (n) and (n+1) when the COMP bit is zero.

Table 47-12. Software output control behavior when (COMP = 0)

CH(n)OC	CH(n+1)OC	CH(n)OCV	CH(n+1)OCV	Channel (n) Output	Channel (n+1) Output
0	0	X	X	is not modified by SWOC	is not modified by SWOC
1	1	0	0	is forced to zero	is forced to zero
1	1	0	1	is forced to zero	is forced to one
1	1	1	0	is forced to one	is forced to zero
1	1	1	1	is forced to one	is forced to one

Software output control forces the following values on channels (n) and (n+1) when the COMP bit is one.

Table 47-13. Software output control behavior when (COMP = 1)

CH(n)OC	CH(n+1)OC	CH(n)OCV	CH(n+1)OCV	Channel (n) Output	Channel (n+1) Output
0	0	X	X	is not modified by SWOC	is not modified by SWOC
1	1	0	0	is forced to zero	is forced to zero
1	1	0	1	is forced to zero	is forced to one
1	1	1	0	is forced to one	is forced to zero
1	1	1	1	is forced to one	is forced to zero

Note

- The CH(n)OC and CH(n+1)OC bits should be equal.
- The COMP bit must not be modified when software output control is enabled, that is, CH(n)OC = 1 and/or CH(n+1)OC = 1.
- Software output control has the same behavior with disabled or enabled FTM counter (see the CLKS field description in the Status and Control register).

47.5.16 Deadtime insertion

The deadtime insertion is enabled when DTEN is set and the concatenation {DTVALEX[3:0], DTVAL[5:0]} is non-zero.

DEADTIME register defines the deadtime delay that can be used for all FTM channels. The clock for the DEADTIME delay is the FTM input clock divided by DTPS bits, and the {DTVALEX[3:0], DTVAL[5:0]} bits define the deadtime modulo, that is, the number of the deadtime prescaler clocks.

The deadtime delay insertion ensures that no two complementary signals (channels (n) and (n+1)) drive the active state at the same time.

If POL(n) = 0, POL(n+1) = 0, and the deadtime is enabled, then when the channel (n) match (FTM counter = C(n)V) occurs, the channel (n) output remains at the low value until the end of the deadtime delay when the channel (n) output is set. Similarly, when the channel (n+1) match (FTM counter = C(n+1)V) occurs, the channel (n+1) output remains at the low value until the end of the deadtime delay when the channel (n+1) output is set. See the following figures.

If POL(n) = 1, POL(n+1) = 1, and the deadtime is enabled, then when the channel (n) match (FTM counter = C(n)V) occurs, the channel (n) output remains at the high value until the end of the deadtime delay when the channel (n) output is cleared. Similarly,

Functional Description

when the channel (n+1) match (FTM counter = C(n+1)V) occurs, the channel (n+1) output remains at the high value until the end of the deadtime delay when the channel (n+1) output is cleared.

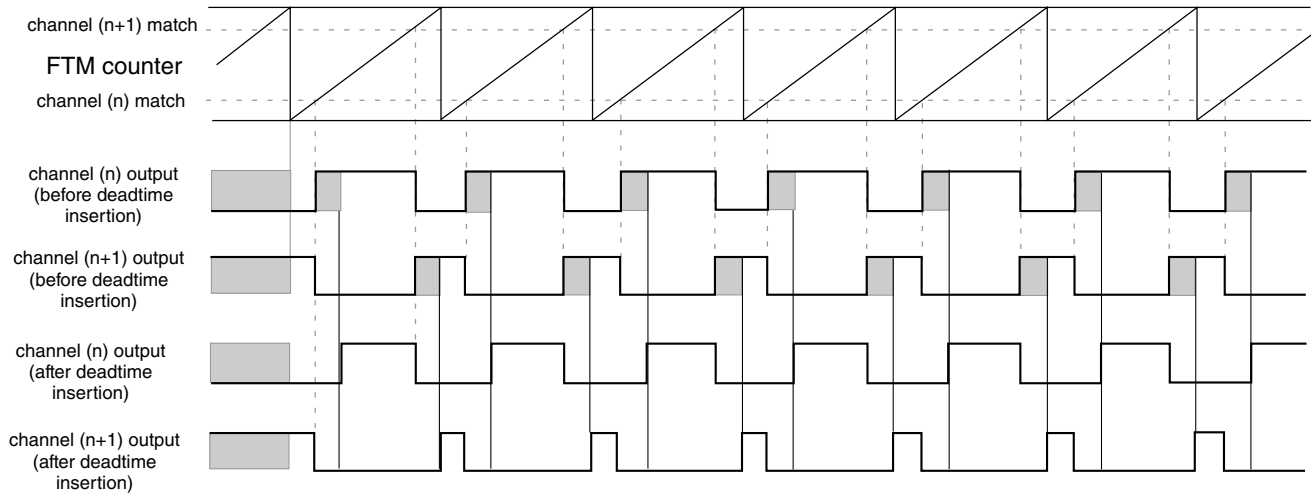

Figure 47-75. Deadtime insertion with ELSB:ELSA = 1:0, POL(n) = 0, and POL(n+1) = 0

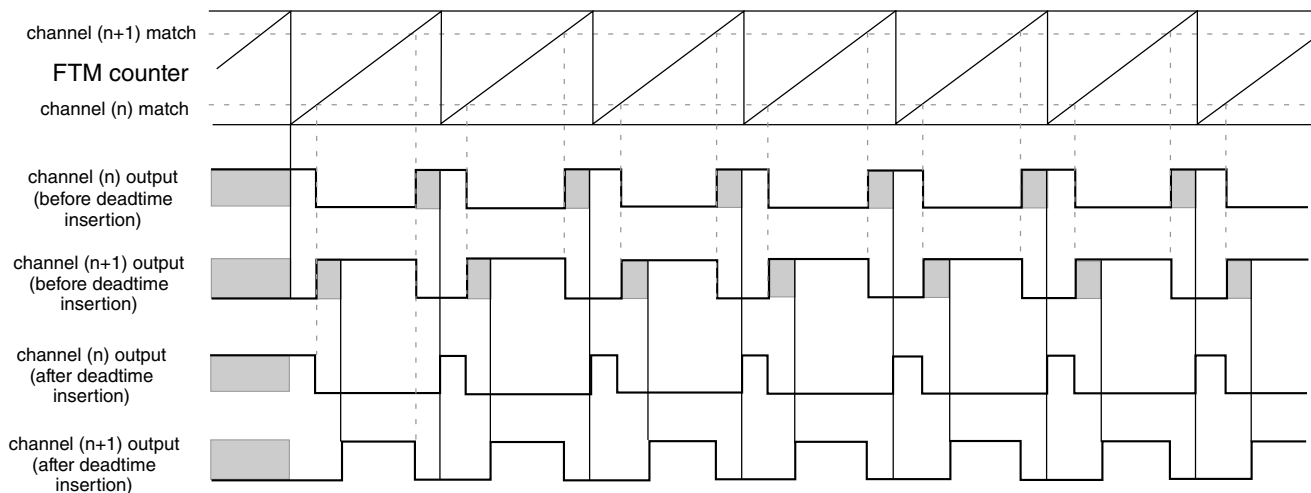

Figure 47-76. Deadtime insertion with ELSB:ELSA = X:1, POL(n) = 0, and POL(n+1) = 0

NOTE

- The deadtime feature must be used only in Complementary mode.
- The deadtime feature is not available in Output Compare mode.

47.5.16.1 Separated Deadtime by Pair of Channels

The separated deadtime value by pair of channels allows that each pair of channels has its own deadtime value (i.e., bits DTVALEX[3:0], DTSP[1:0], and DTVAL[5:0]).

The registers PAIR0DEADTIME, PAIR1DEADTIME, PAIR2DEADTIME, and PAIR3DEADTIME are available according to the FTM configuration.

The figure below describes how the deadtime value is defined by each pair according to the FTM configuration.

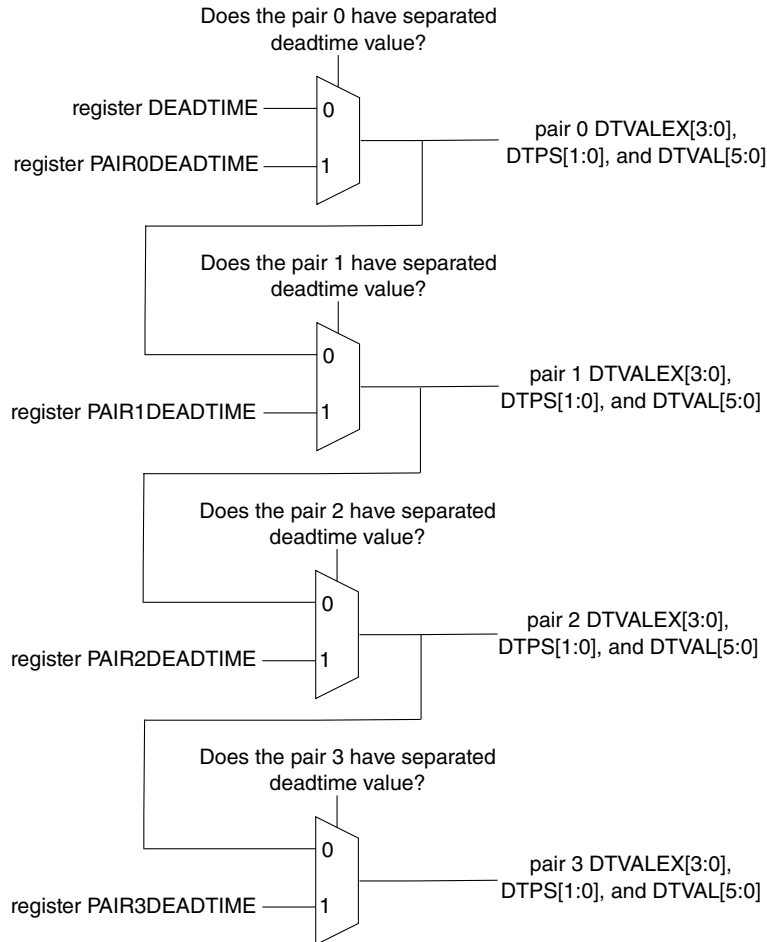

Figure 47-77. Separated Deadtime by Pair of Channels

The writes to the register DEADTIME also update the available registers PAIR(j)DEADTIME (where j is the pair of channels). Because of this, the write to the register DEADTIME should be done before the writes to the registers PAIR(j)DEADTIME.

If the pair 0 of channels has separated deadtime value, then the reads of the register DEADTIME return the read value of the register PAIR0DEADTIME. Otherwise, the read value is the value of the register DEADTIME.

47.5.16.2 Deadtime insertion corner cases

If (PS[2:0] is cleared), (DTPS[1:0] = 0:0 or DTPS[1:0] = 0:1):

- and the deadtime delay is greater than or equal to the channel (n) duty cycle ($(C(n+1)V - C(n)V) \times \text{FTM input clock}$), then the channel (n) output is always the inactive value (POL(n) bit value).
- and the deadtime delay is greater than or equal to the channel (n+1) duty cycle ($(\text{MOD} - \text{CNTIN} + 1 - (C(n+1)V - C(n)V)) \times \text{FTM input clock}$), then the channel (n+1) output is always the inactive value (POL(n+1) bit value).

Although, in most cases the deadtime delay is not comparable to channels (n) and (n+1) duty cycle, the following figures show examples where the deadtime delay is comparable to the duty cycle.

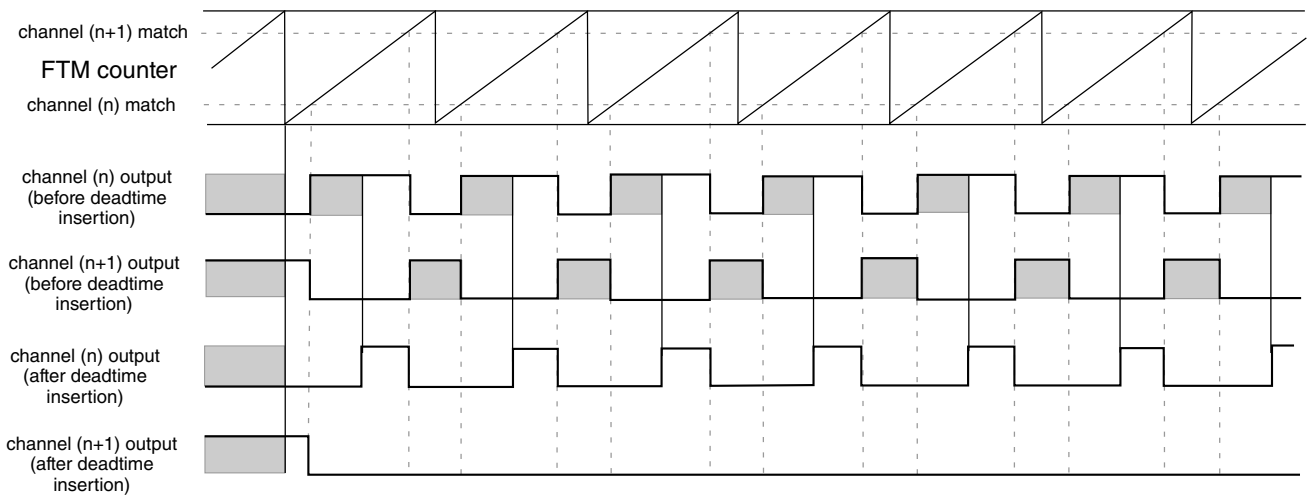

Figure 47-78. Example of the deadtime insertion (channel (n) ELSB:ELSA = 1:0, POL(n) = 0, and POL(n+1) = 0) when the deadtime delay is comparable to channel (n+1) duty cycle

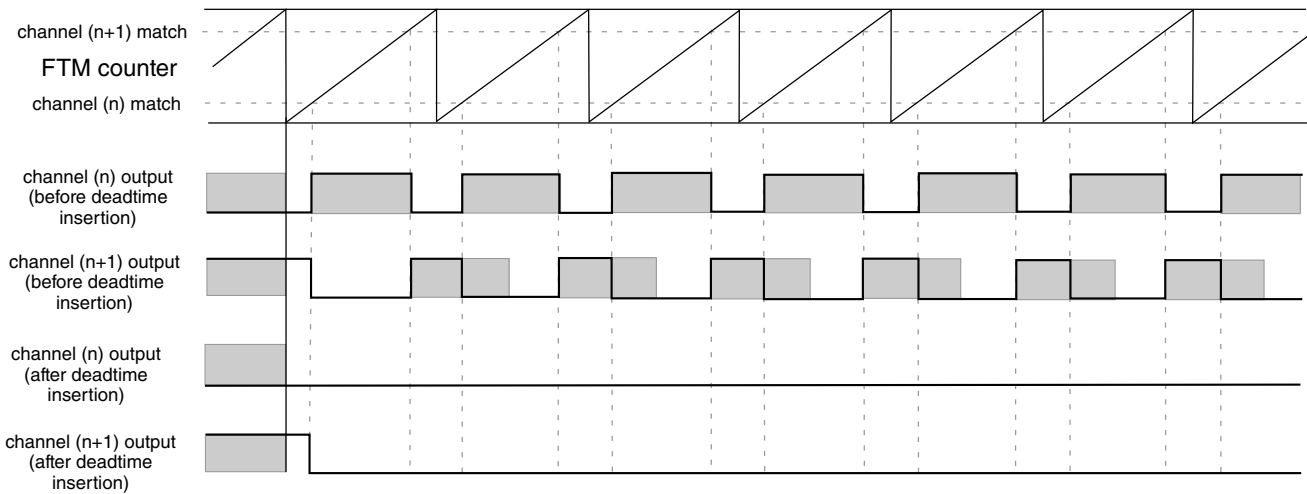

Figure 47-79. Example of the deadtime insertion (channel (n) ELSB:ELSA = 1:0, POL(n) = 0, and POL(n+1) = 0) when the deadtime delay is comparable to channels (n) and (n+1) duty cycle

47.5.17 Output mask

The output mask can be used to force channels output to their inactive state through software. For example: to control a BLDC motor.

Any write to the OUTMASK register updates its write buffer. The OUTMASK register is updated with its buffer value by PWM synchronization; see [OUTMASK register synchronization](#).

If CH(n)OM = 1, then the channel (n) output is forced to its inactive state (POLn bit value). If CH(n)OM = 0, then the channel (n) output is unaffected by the output mask. See the following figure.

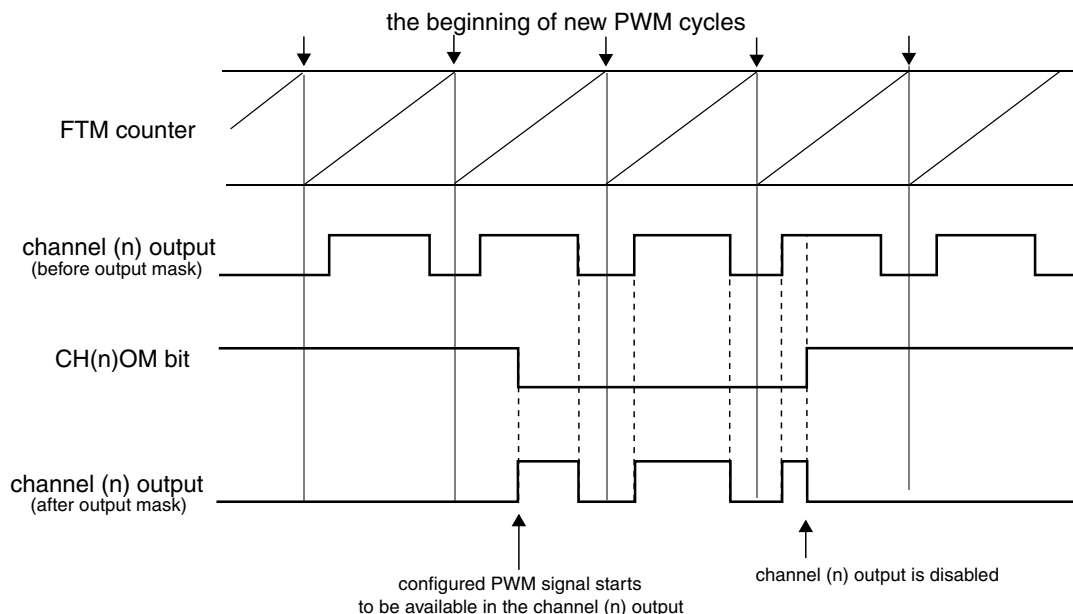

Figure 47-80. Output mask with POLn = 0

The following table shows the output mask result before the polarity control.

Table 47-14. Output mask result for channel (n) before the polarity control

CH(n)OM	Output Mask Input	Output Mask Result
0	inactive state	inactive state
	active state	active state
1	inactive state	inactive state
	active state	inactive state

47.5.18 Fault Control

The fault control is enabled if FAULTM[1:0] ≠ 0:0.

FTM can have up to four fault inputs. FAULTnEN bit (where n = 0, 1, 2, 3) enables the fault input n and FFLTRnEN bit enables the fault input n filter. FFVAL[3:0] bits select the value of the enabled filter in each enabled fault input.

If FLTTPS[3:0] = 0, the fault input after being synchronized by FTM input clock is the filter input.

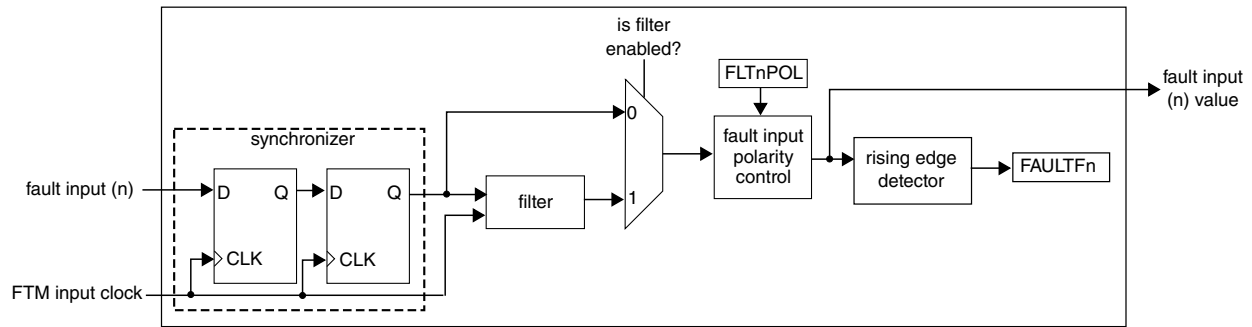

Figure 47-81. Diagram for Fault Control when FLTPS[3:0] = 0

If FLTPS[3:0] \neq 0, the fault input after being synchronized by FTM input clock and being sampled by FTM filter clock is the filter input.

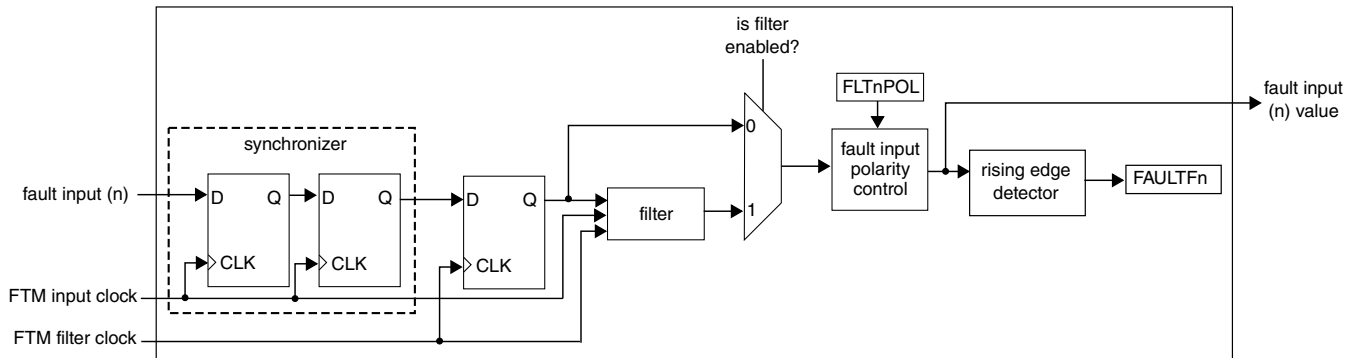

Figure 47-82. Diagram for Fault Control when FLTPS[3:0] \neq 0

When there is a state change in the fault input (n), the counter is reset and starts counting up. As long as the new state is stable on the fault input (n), the counter continues to increment. When the counter is equal to FFVAL[3:0] bits, the new fault input (n) value is validated. It is then transmitted as a pulse to the edge detector.

If the opposite edge appears on the fault input (n) before it can be validated, the counter is reset. At the next input transition, the counter starts counting again. If a pulse is sampled as a value less than FFVAL[3:0] consecutive rising edges of FTM filter clock, it is regarded as a glitch and is not passed on to the edge detector.

Functional Description

The table below shows the delay that is added by the FTM fault input filter according to its configuration.

Table 47-15. FTM Fault Input Filter Delay

FTM fault input filter	FLTPS[3:0] bits	Number of rising edges between the selected edge on fault input and forcing the channels outputs to their safe values
<ul style="list-style-type: none"> fault input does not have the input filter, or fault input filter is disabled (FFLTRnEN = 0 or FFVAL[3:0] = 0) 	FLTPS[3:0] = 0	<ul style="list-style-type: none"> 3 rising edges of FTM input clock
	FLTPS[3:0] ≠ 0	<ul style="list-style-type: none"> 3 rising edges of FTM input clock, plus 1 rising edge of FTM filter clock
<ul style="list-style-type: none"> fault input has the input filter, and fault input filter is enabled (FFLTRnEN = 1 and FFVAL[3:0] ≠ 0) 	FLTPS[3:0] = 0	<ul style="list-style-type: none"> (4 + FFVAL[3:0]) rising edges of FTM input clock
	FLTPS[3:0] ≠ 0	<ul style="list-style-type: none"> 4 rising edges of FTM input clock, plus (1 + FFVAL[3:0]) rising edges of FTM filter clock

If the fault control and fault input (n) are enabled, and the selected edge at the fault input (n) is detected, then a fault condition has occurred and the FAULTFn bit is set. The FAULTF bit is the logic OR of FAULTFn[3:0] bits. See the following figure.

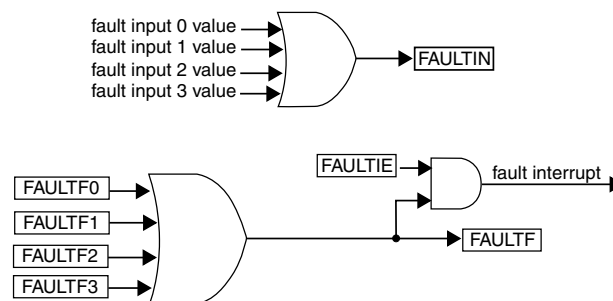

Figure 47-83. FAULTF and FAULTIN bits and fault interrupt

If the fault control is enabled (FAULTM[1:0] ≠ 0:0), a fault condition has occurred, and (FAULTENj = 1, where j is the pair j of the channels), then the channels (n) and (n+1) outputs are forced to their safe values:

- channel (n) output takes the POL(n) bit value
- channel (n+1) output takes the POL(n+1) bit value

The fault interrupt is generated when (FAULTF = 1) and (FAULTIE = 1). This interrupt request remains set until:

- Software clears the FAULTF bit by reading FAULTF bit as 1 and writing 0 to it
- Software clears the FAULTIE bit
- A reset occurs

47.5.18.1 Automatic fault clearing

If the automatic fault clearing is selected ($\text{FAULTM}[1:0] = 1:1$), then the channels output disabled by fault control is again enabled when the fault input signal (FAULTIN) returns to zero and a new PWM cycle begins. See the following figure.

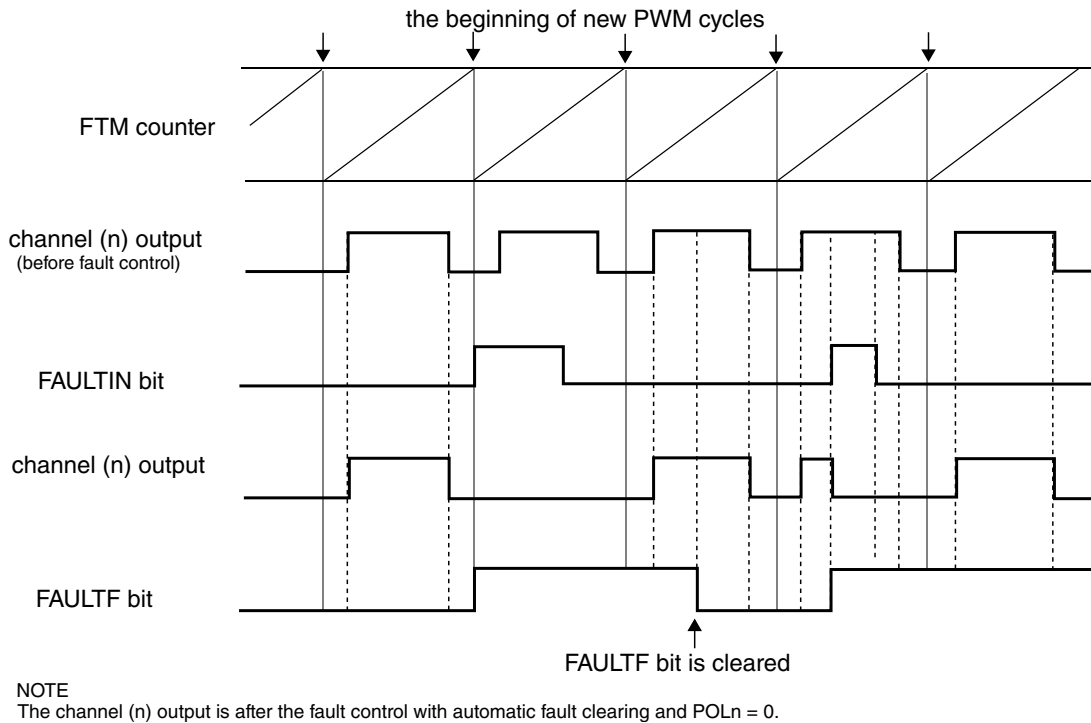
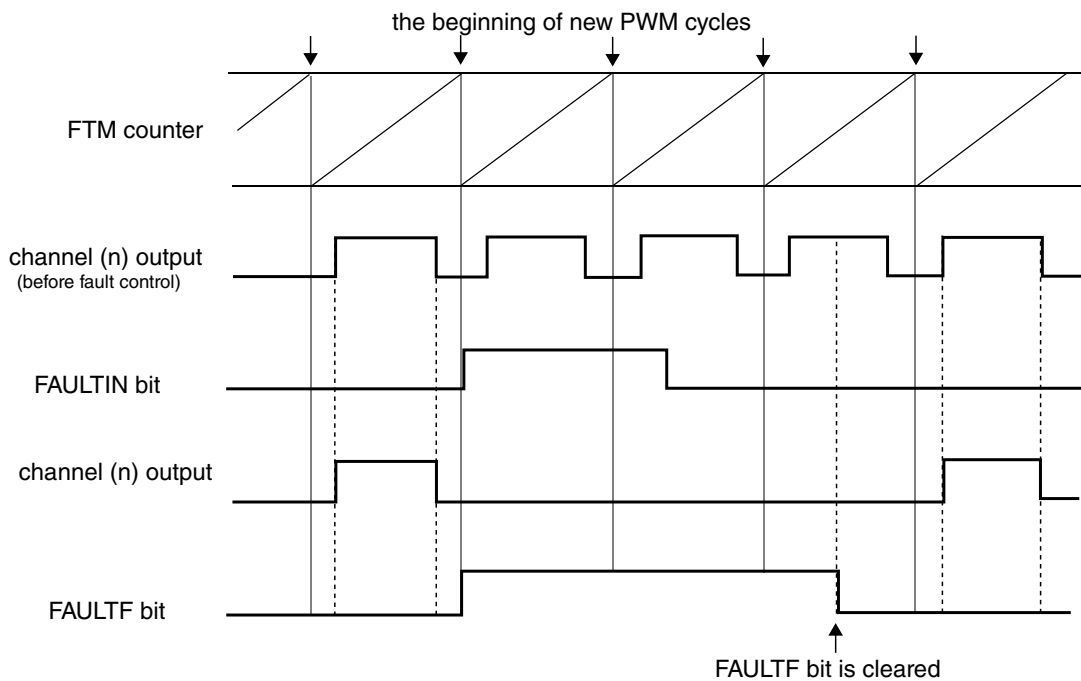

Figure 47-84. Fault control with automatic fault clearing

47.5.18.2 Manual fault clearing

If the manual fault clearing is selected ($\text{FAULTM}[1:0] = 0:1$ or $1:0$), then the channels output disabled by fault control is again enabled when the FAULTF bit is cleared and a new PWM cycle begins. See the following figure.



NOTE
The channel (n) output is after the fault control with manual fault clearing and POLn = 0.

Figure 47-85. Fault control with manual fault clearing

47.5.18.3 Fault inputs polarity control

The FLTjPOL bit selects the fault input j polarity, where j = 0, 1, 2, 3:

- If FLTjPOL = 0, the fault j input polarity is high, so the logical one at the fault input j indicates a fault.
- If FLTjPOL = 1, the fault j input polarity is low, so the logical zero at the fault input j indicates a fault.

47.5.19 Polarity Control

The POLn bit selects the channel (n) output polarity:

- If POLn = 0, the channel (n) output polarity is high, so the logical one is the active state and the logical zero is the inactive state.
- If POLn = 1, the channel (n) output polarity is low, so the logical zero is the active state and the logical one is the inactive state.

47.5.20 Initialization

The initialization forces the CH(n)OI bit value to the channel (n) output when 1 is written to the INIT bit.

The initialization depends on COMP and DTEN bits. The following table shows the values that channels (n) and (n+1) are forced by initialization when the COMP and DTEN bits are zero.

Table 47-16. Initialization behavior when (COMP = 0 and DTEN = 0)

CH(n)OI	CH(n+1)OI	Channel (n) Output	Channel (n+1) Output
0	0	is forced to zero	is forced to zero
0	1	is forced to zero	is forced to one
1	0	is forced to one	is forced to zero
1	1	is forced to one	is forced to one

The following table shows the values that channels (n) and (n+1) are forced by initialization when (COMP = 1) or (DTEN = 1).

Table 47-17. Initialization behavior when (COMP = 1 or DTEN = 1)

CH(n)OI	CH(n+1)OI	Channel (n) Output	Channel (n+1) Output
0	X	is forced to zero	is forced to one
1	X	is forced to one	is forced to zero

Note

The initialization feature must be used only with disabled FTM counter. See the description of the CLKS field in the Status and Control register.

47.5.21 Features Priority

The following figure shows the priority of the features used at the generation of channels (n) and (n+1) outputs signals.

Pair channels (m) - channels (n) and (n+1)

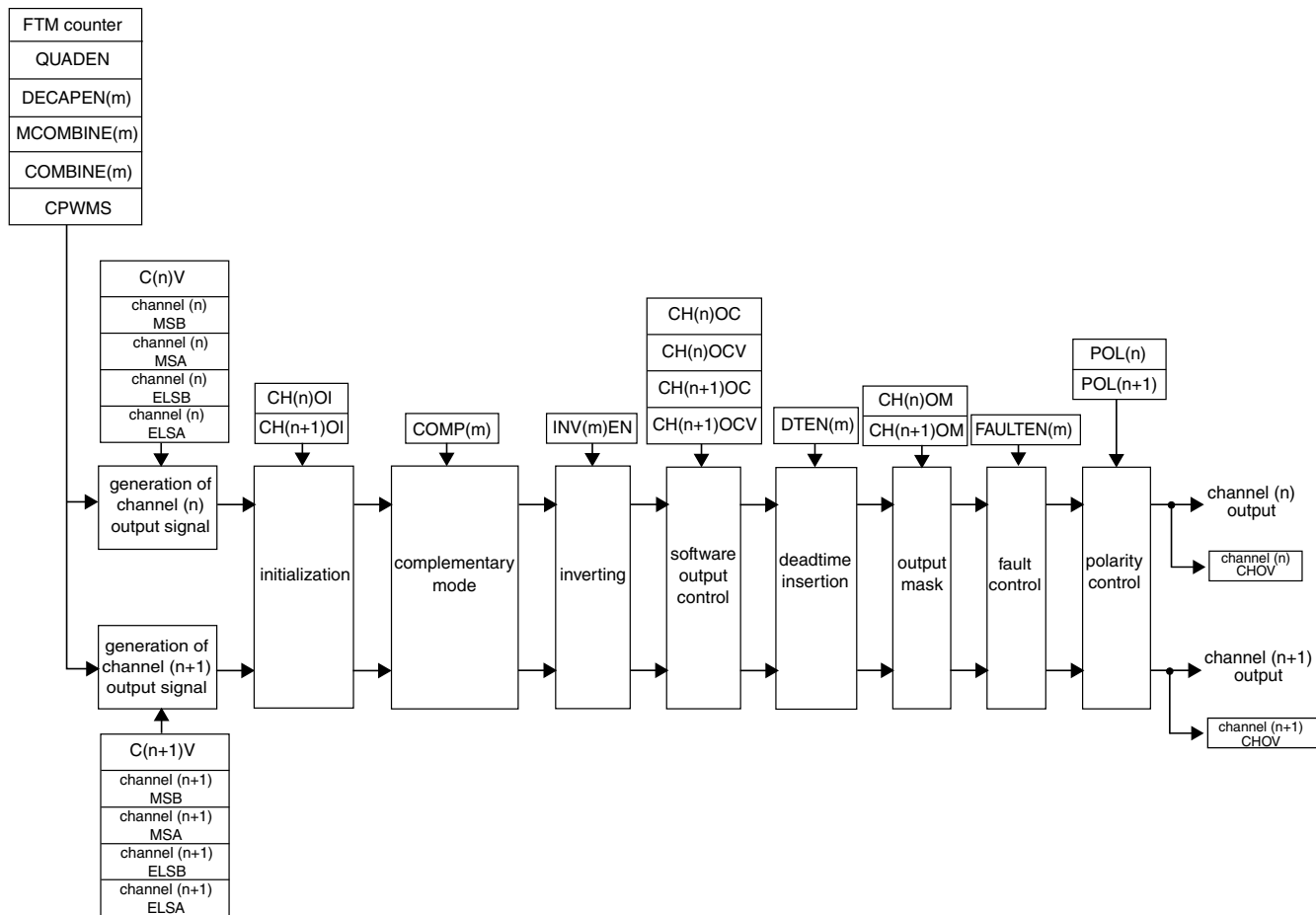

Note:
The channels (n) and (n+1) are in Output Compare, EPWM, CPWM, Combine or Modified Combine PWM modes.

Figure 47-86. Priority of the features used at the generation of channels (n) and (n+1) output

NOTE

The **Initialization** must not be used with **Inverting** and **Software Output Control Mode**.

47.5.22 External Trigger

If the CH(n)TRIG bit (register EXTTRIG) is set, where n = 0, 1, 2, 3, 4, 5, 6 or 7, then the FTM generates a trigger when the channel (n) match occurs (FTM counter = C(n)V) at the FTM external trigger output.

The width of a channel (n) trigger is one FTM input clock and the FTM is able to generate multiple triggers in one PWM period. See the figure below.

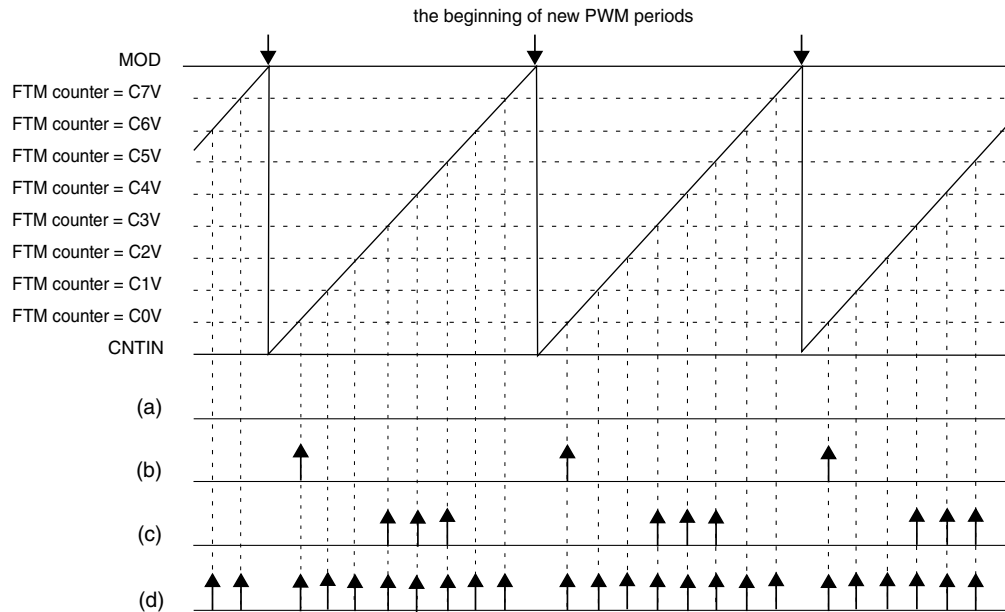
**Note**

- (a) CH0TRIG = 0, CH1TRIG = 0, CH2TRIG = 0, CH3TRIG = 0, CH4TRIG = 0, CH5TRIG = 0, CH6TRIG = 0, CH7TRIG = 0
 (b) CH0TRIG = 1, CH1TRIG = 0, CH2TRIG = 0, CH3TRIG = 0, CH4TRIG = 0, CH5TRIG = 0, CH6TRIG = 0, CH7TRIG = 0
 (c) CH0TRIG = 0, CH1TRIG = 0, CH2TRIG = 0, CH3TRIG = 1, CH4TRIG = 1, CH5TRIG = 1, CH6TRIG = 0, CH7TRIG = 0
 (d) CH0TRIG = 1, CH1TRIG = 1, CH2TRIG = 1, CH3TRIG = 1, CH4TRIG = 1, CH5TRIG = 1, CH6TRIG = 1, CH7TRIG = 1

Figure 47-87. External Trigger

47.5.23 Initialization Trigger

Initialization trigger allows FTM to generate a trigger in some specific points of FTM counter cycle. This feature is controlled by the bits INITTRIGEN and ITRIGR. The INITTRIGEN bit enables the initialization trigger generation and the ITRIGR bit selects when the initialization trigger is generated.

If INITTRIGEN = 1 and ITRIGR = 1, then the initialization trigger is generated when FTM counter reaches a reload point according to the frequency of the reload opportunities ([Reload Points](#)).

NOTE

For this configuration of initialization trigger and in CPWM mode, the bits CNTMAX and CNTMIN select where the initialization trigger is generated.

If INITTRIGEN = 1 and ITRIGR = 0, then the initialization trigger is generated when FTM counter is updated with the CNTIN register value. See the cases below.

1. When FTM counter is updated with CNTIN register value automatically.

Functional Description

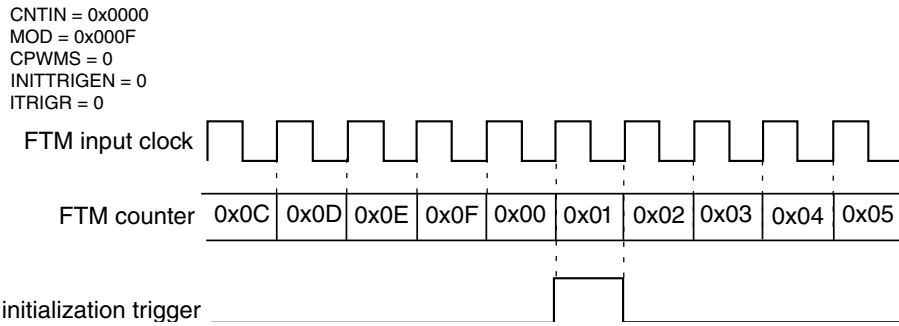

Figure 47-88. Example of the generation of the initialization trigger in the case 1.
 2. When there is a write to CNT register.

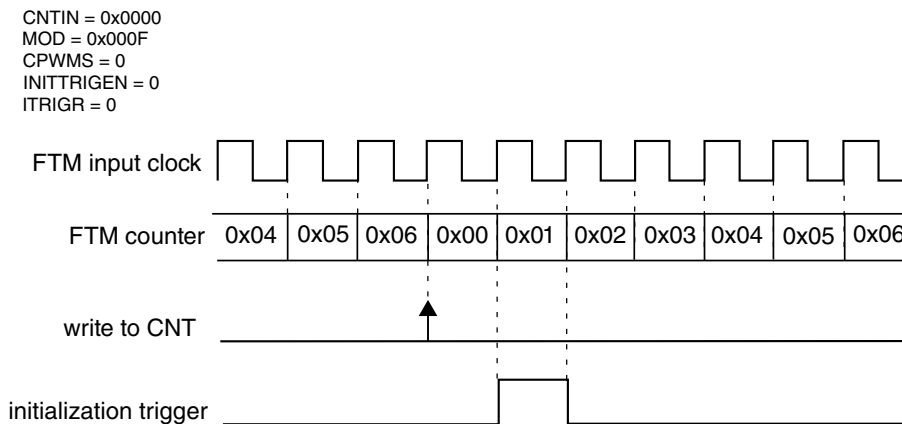

Figure 47-89. Example of the generation of the initialization trigger in the case 2.

NOTE

This behavior is not available in CPWM mode.

3. When there is the **FTM counter synchronization**.

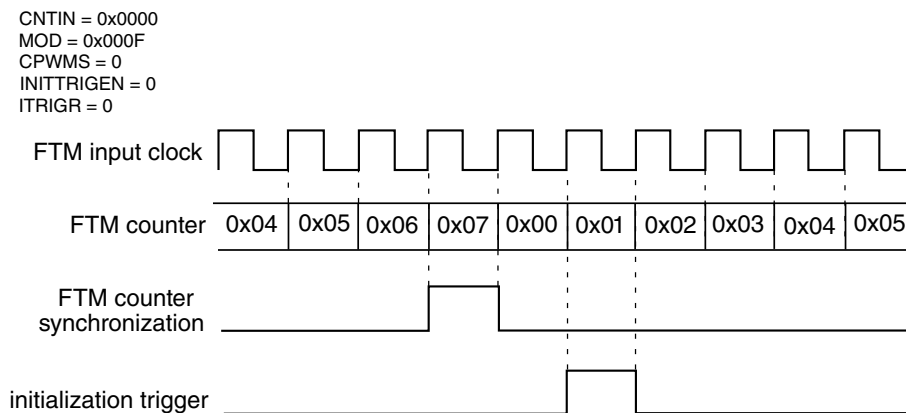

Figure 47-90. Example of the generation of the initialization trigger in the case 3.

NOTE

This behavior is not available in CPWM mode.

4. If (CNT = CNTIN), (CLKS[1:0] = 0:0), and a value different from zero is written to CLKS[1:0] bits.

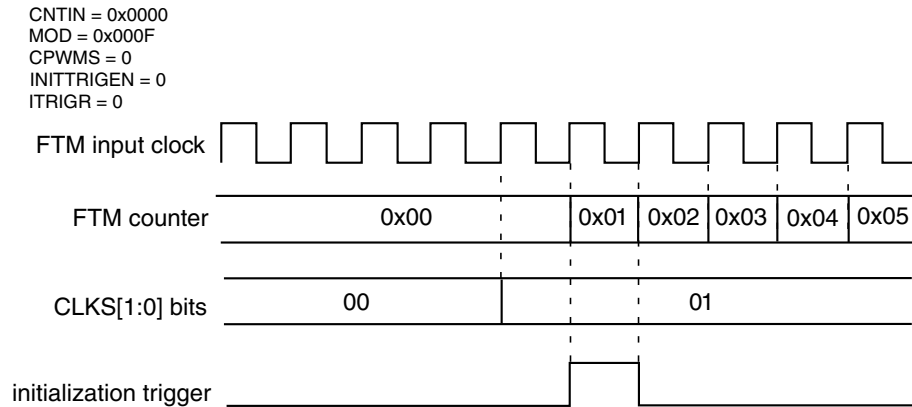

Figure 47-91. Example of the generation of the initialization trigger in the case 4.

NOTE

This behavior is not available in CPWM mode.

5. If the channel (n) is in Input Capture mode, (ICRST = 1) and the selected input capture event occurs in the channel (n) input.

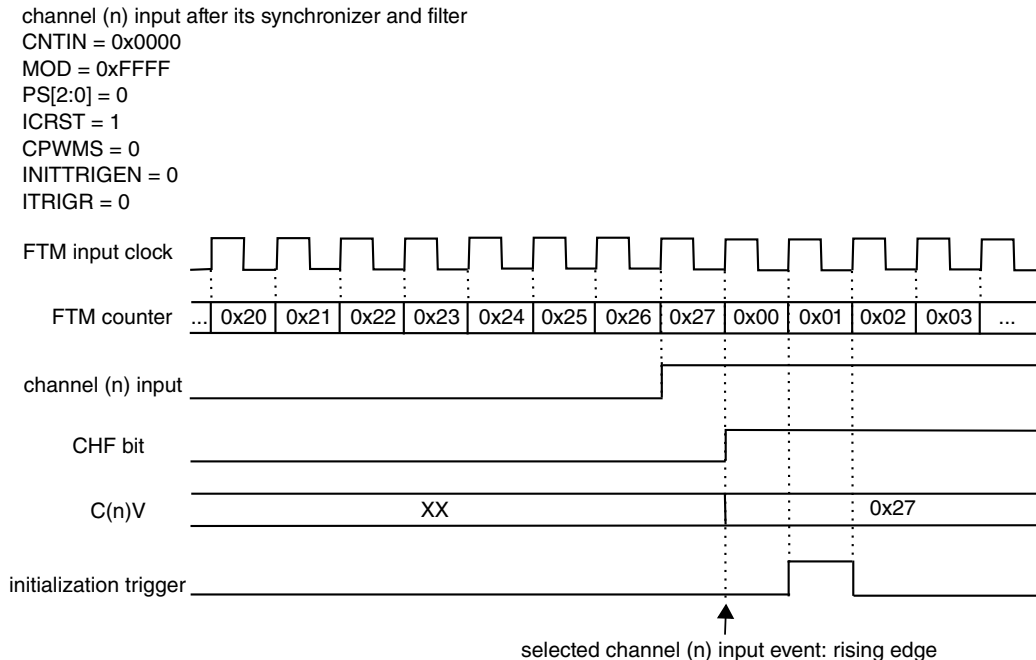

Figure 47-92. Example of the generation of the initialization trigger in the case 5.

47.5.24 Capture Test Mode

The Capture Test mode allows to test the CnV registers, the FTM counter and the interconnection logic between the FTM counter and CnV registers.

In this test mode, all channels must be configured for **Input Capture Mode** and FTM counter must be configured to the **Up counting**.

When the Capture Test mode is enabled (CAPTEST = 1), the FTM counter is frozen and any write to CNT register updates directly the FTM counter; see the following figure. After it was written, all CnV registers are updated with the written value to CNT register and CHF bits are set. Therefore, the FTM counter is updated with its next value according to its configuration. Its next value depends on CNTIN, MOD, and the written value to FTM counter.

The next reads of CnV registers return the written value to the FTM counter and the next reads of CNT register return FTM counter next value.

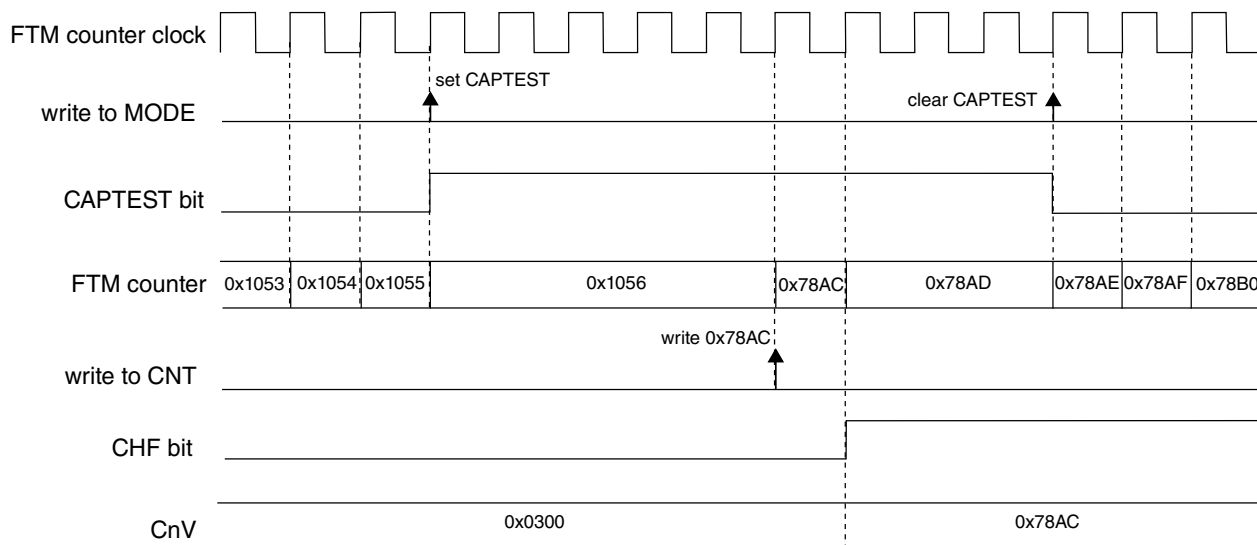

- Note:
- FTM counter is in free running
 - FTMEN = 1
 - FTM channel (n) is in Input Capture Mode

Figure 47-93. Capture Test Mode

47.5.25 DMA

The channel generates a DMA transfer request according to DMA and CHIE bits. See the following table.

Table 47-18. Channel DMA transfer request

DMA	CHIE	Channel DMA Transfer Request	Channel Interrupt
0	0	The channel DMA transfer request is not generated.	The channel interrupt is not generated.
0	1	The channel DMA transfer request is not generated.	The channel interrupt is generated if (CHF = 1).
1	0	The channel DMA transfer request is not generated.	The channel interrupt is not generated.
1	1	The channel DMA transfer request is generated if (CHF = 1).	The channel interrupt is not generated.

If DMA = 1, the CHF bit is cleared either by channel DMA transfer done or reading CnSC while CHF is set and then writing a zero to CHF bit according to CHIE bit. See the following table.

Table 47-19. Clear CHF bit when DMA = 1

CHIE	How CHF Bit Can Be Cleared
0	CHF bit is cleared either when the channel DMA transfer is done or by reading CnSC while CHF is set and then writing a 0 to CHF bit.
1	CHF bit is cleared when the channel DMA transfer is done.

47.5.26 Dual Edge Capture Mode

The dual edge capture mode is enabled if DECAPEN = 1. This mode allows to measure a pulse width or period of the channel (n) input where n = 0, 2, 4 or 6. The channel (n) filter can be enabled for n = 0 or 2.

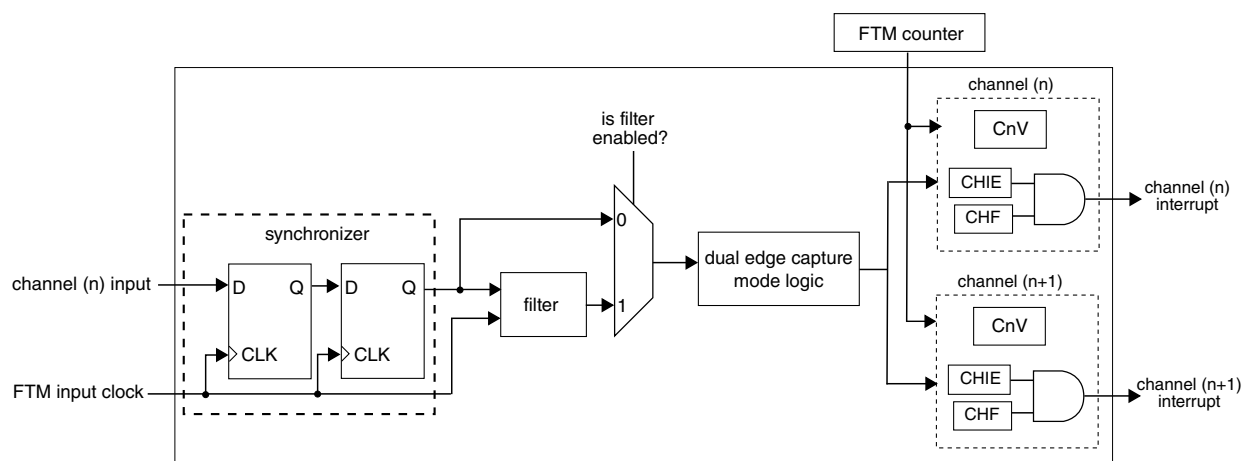
**Figure 47-94. Diagram for Dual Edge Capture Mode when FLTPS[3:0] = 0**

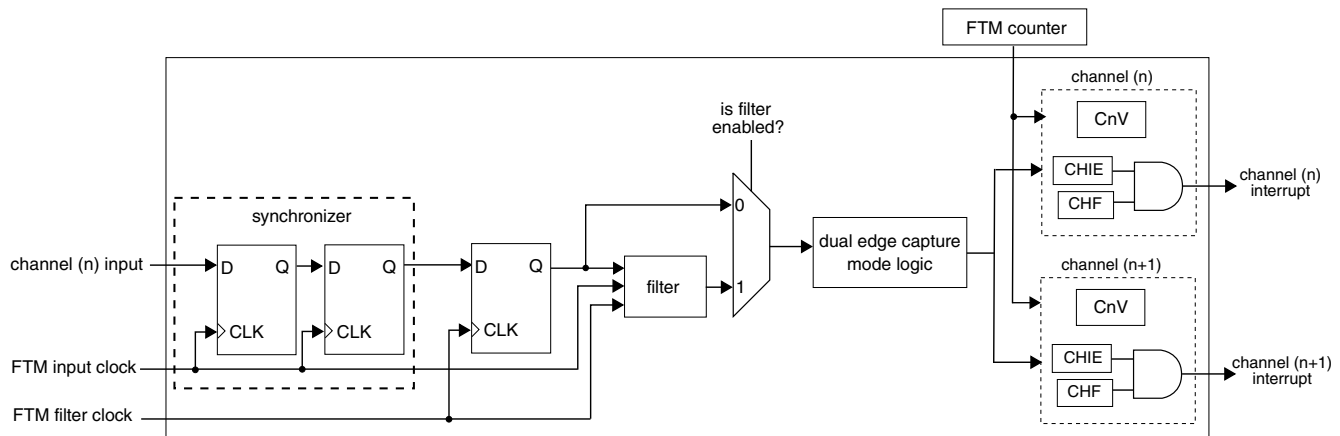

Figure 47-95. Diagram for Dual Edge Capture Mode when FLTPS[3:0] ≠ 0

The channel (n) MSA bit defines if the dual edge capture mode is one-shot or continuous.

The channel (n) ELSB:ELSA bits select the edge that is captured by channel (n), and channel (n+1) ELSB:ELSA bits select the edge that is captured by channel (n+1). If both channel (n) ELSB:ELSA and channel (n+1) ELSB:ELSA bits select the same edge, then it is the period measurement. If these bits select different edges, then it is a pulse width measurement.

In the dual edge capture mode, only channel (n) input is used and channel (n+1) input is ignored.

If the selected edge by channel (n) bits is detected at channel (n) input, then channel (n) CHF bit is set and the channel (n) interrupt is generated (if channel (n) CHIE = 1). If the selected edge by channel (n+1) bits is detected at channel (n) input and (channel (n) CHF = 1), then channel (n+1) CHF bit is set and the channel (n+1) interrupt is generated (if channel (n+1) CHIE = 1).

The C(n)V register stores the FTM counter value when the selected edge by channel (n) is detected at channel (n) input. The C(n+1)V register stores the FTM counter value when the selected edge by channel (n+1) is detected at channel (n) input.

In this mode, a coherency mechanism (for channels (n) and (n+1)) ensures coherent data when the C(n)V and C(n+1)V registers are read. The only requirement is that C(n)V must be read before C(n+1)V.

Note

- The dual edge capture mode must be used with channel (n) ELSB:ELSA = 0:1 or 1:0, channel (n+1) ELSB:ELSA = 0:1 or 1:0 and the FTM counter in [Free running counter](#).

47.5.26.1 One-Shot Capture mode

The One-Shot Capture mode is selected when (DECAPEN = 1), and (channel (n) MSA = 0). In this capture mode, only one pair of edges at the channel (n) input is captured. The channel (n) ELSB:ELSA bits select the first edge to be captured, and channel (n+1) ELSB:ELSA bits select the second edge to be captured.

The edge captures are enabled while DECAP bit is set. For each new measurement in One-Shot Capture mode, first the channel (n) CHF and channel (n+1) CHF bits must be cleared, and then the DECAP bit must be set.

In this mode, the DECAP bit is automatically cleared by FTM when the edge selected by channel (n+1) is captured. Therefore, while DECAP bit is set, the one-shot capture is in process. When this bit is cleared, both edges were captured and the captured values are ready for reading in the C(n)V and C(n+1)V registers.

Similarly, when the channel (n+1) CHF bit is set, both edges were captured and the captured values are ready for reading in the C(n)V and C(n+1)V registers.

47.5.26.2 Continuous Capture mode

The Continuous Capture mode is selected when (DECAPEN = 1), and (channel (n) MSA = 1). In this capture mode, the edges at the channel (n) input are captured continuously. The channel (n) ELSB:ELSA bits select the initial edge to be captured, and channel (n+1) ELSB:ELSA bits select the final edge to be captured.

The edge captures are enabled while DECAP bit is set. For the initial use, first the channel (n) CHF and channel (n+1) CHF bits must be cleared, and then DECAP bit must be set to start the continuous measurements.

When the channel (n+1) CHF bit is set, both edges were captured and the captured values are ready for reading in the C(n)V and C(n+1)V registers. The latest captured values are always available in these registers even after the DECAP bit is cleared.

In this mode, it is possible to clear only the channel (n+1) CHF bit. Therefore, when the channel (n+1) CHF bit is set again, the latest captured values are available in C(n)V and C(n+1)V registers.

For a new sequence of the measurements in the Dual Edge Capture – Continuous mode, clear the channel (n) CHF and channel (n+1) CHF bits to start new measurements.

47.5.26.3 Pulse width measurement

If the channel (n) is configured to capture rising edges (channel (n) ELSB:ELSA = 0:1) and the channel (n+1) to capture falling edges (channel (n+1) ELSB:ELSA = 1:0), then the positive polarity pulse width is measured. If the channel (n) is configured to capture falling edges (channel (n) ELSB:ELSA = 1:0) and the channel (n+1) to capture rising edges (channel (n+1) ELSB:ELSA = 0:1), then the negative polarity pulse width is measured.

The pulse width measurement can be made in [One-Shot Capture mode](#) or [Continuous Capture mode](#).

The following figure shows an example of the Dual Edge Capture – One-Shot mode used to measure the positive polarity pulse width. The DECAPEN bit selects the Dual Edge Capture mode, so it remains set. The DECAP bit is set to enable the measurement of next positive polarity pulse width. The channel (n) CHF bit is set when the first edge of this pulse is detected, that is, the edge selected by channel (n) ELSB:ELSA bits. The channel (n+1) CHF bit is set and DECAP bit is cleared when the second edge of this pulse is detected, that is, the edge selected by channel (n+1) ELSB:ELSA bits. Both DECAP and channel (n+1) CHF bits indicate when two edges of the pulse were captured and the C(n)V and C(n+1)V registers are ready for reading.

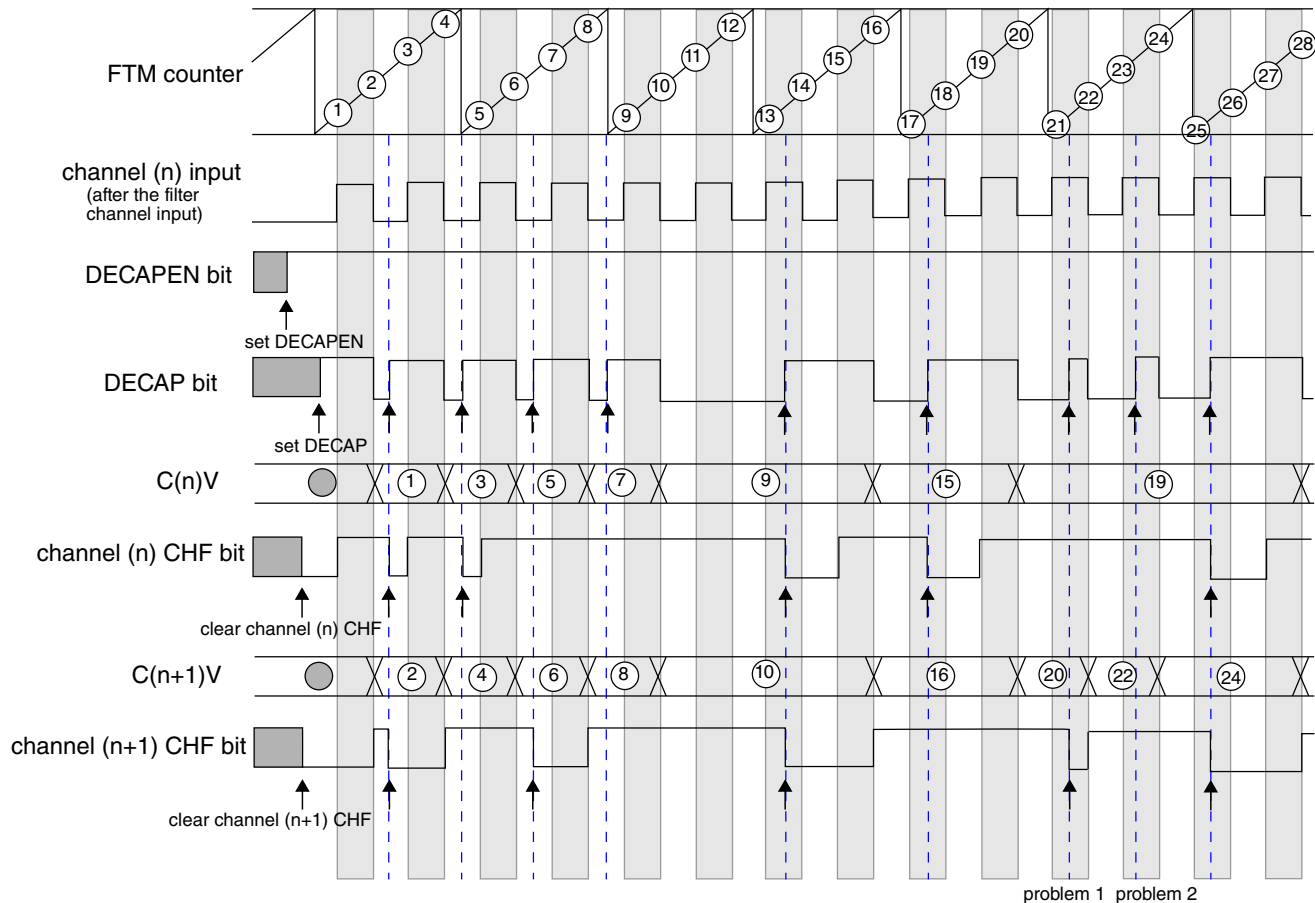

Note

- The commands set DECAPEN, set DECAP, clear channel (n) CHF, and clear channel (n+1) CHF are made by the user.
- Problem 1: channel (n) input = 1, set DECAP, not clear channel (n) CHF, and clear channel (n+1) CHF.
- Problem 2: channel (n) input = 1, set DECAP, not clear channel (n) CHF, and not clear channel (n+1) CHF.

Figure 47-96. Dual Edge Capture – One-Shot mode for positive polarity pulse width measurement

The following figure shows an example of the Dual Edge Capture – Continuous mode used to measure the positive polarity pulse width. The DECAPEN bit selects the Dual Edge Capture mode, so it remains set. While the DECAP bit is set the configured measurements are made. The channel (n) CHF bit is set when the first edge of the positive polarity pulse is detected, that is, the edge selected by channel (n) ELSB:ELSA bits. The channel (n+1) CHF bit is set when the second edge of this pulse is detected, that is, the edge selected by channel (n+1) ELSB:ELSA bits. The channel (n+1) CHF bit indicates when two edges of the pulse were captured and the C(n)V and C(n+1)V registers are ready for reading.

Functional Description

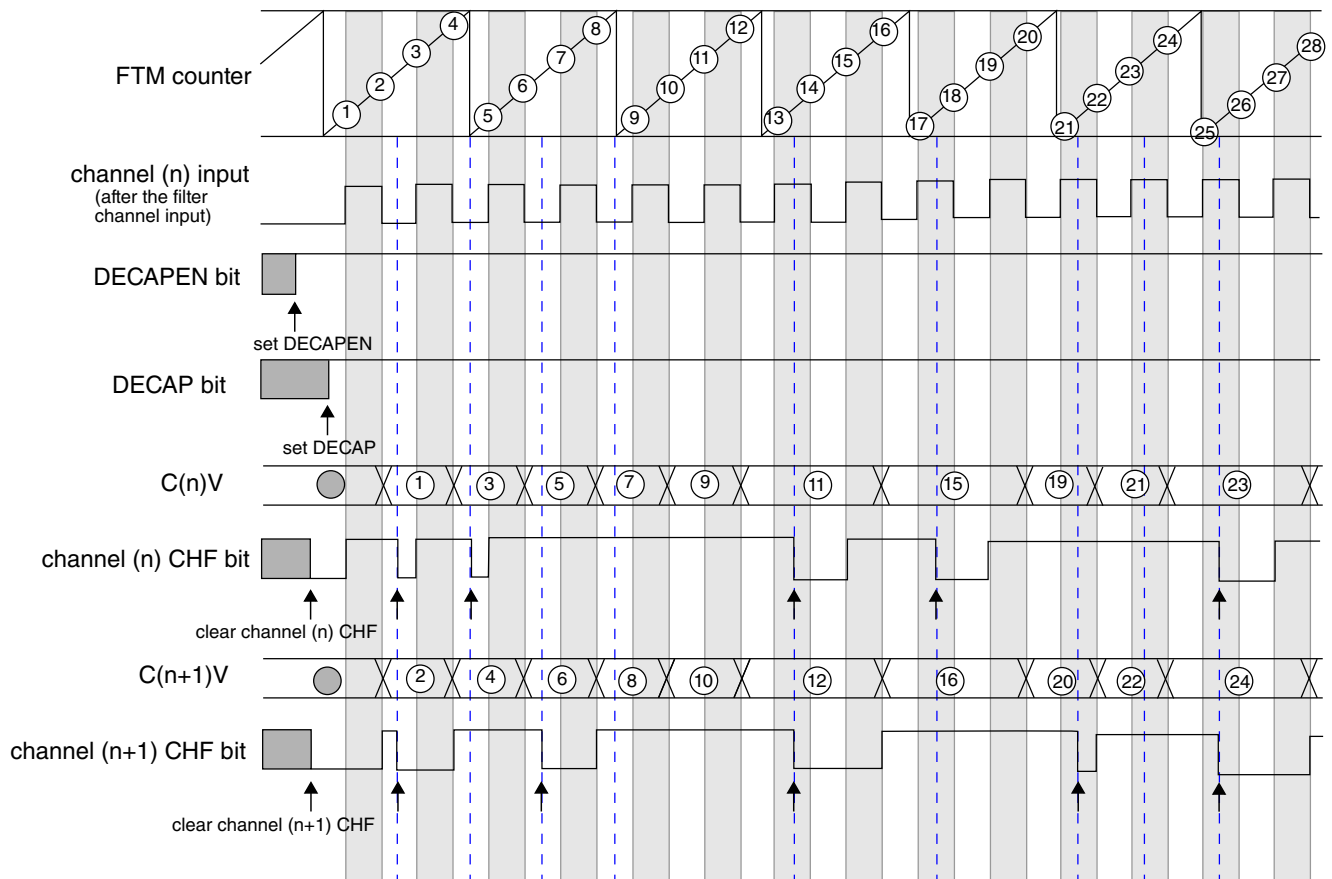

Note

- The commands set DECAPEN, set DECAP, clear channel (n) CHF, and clear channel (n+1) CHF are made by the user.

Figure 47-97. Dual Edge Capture – Continuous mode for positive polarity pulse width measurement

47.5.26.4 Period measurement

If the channels (n) and (n+1) are configured to capture consecutive edges of the same polarity, then the period of the channel (n) input signal is measured. If both channels (n) and (n+1) are configured to capture rising edges (channel (n) ELSB:ELSA = 0:1 and channel (n+1) ELSB:ELSA = 0:1), then the period between two consecutive rising edges is measured. If both channels (n) and (n+1) are configured to capture falling edges (channel (n) ELSB:ELSA = 1:0 and channel (n+1) ELSB:ELSA = 1:0), then the period between two consecutive falling edges is measured.

The period measurement can be made in [One-Shot Capture mode](#) or [Continuous Capture mode](#).

The following figure shows an example of the Dual Edge Capture – One-Shot mode used to measure the period between two consecutive rising edges. The DECAPEN bit selects the Dual Edge Capture mode, so it remains set. The DECAP bit is set to enable the measurement of next period. The channel (n) CHF bit is set when the first rising edge is detected, that is, the edge selected by channel (n) ELSB:ELSA bits. The channel (n+1) CHF bit is set and DECAP bit is cleared when the second rising edge is detected, that is, the edge selected by channel (n+1) ELSB:ELSA bits. Both DECAP and channel (n+1) CHF bits indicate when two selected edges were captured and the C(n)V and C(n+1)V registers are ready for reading.

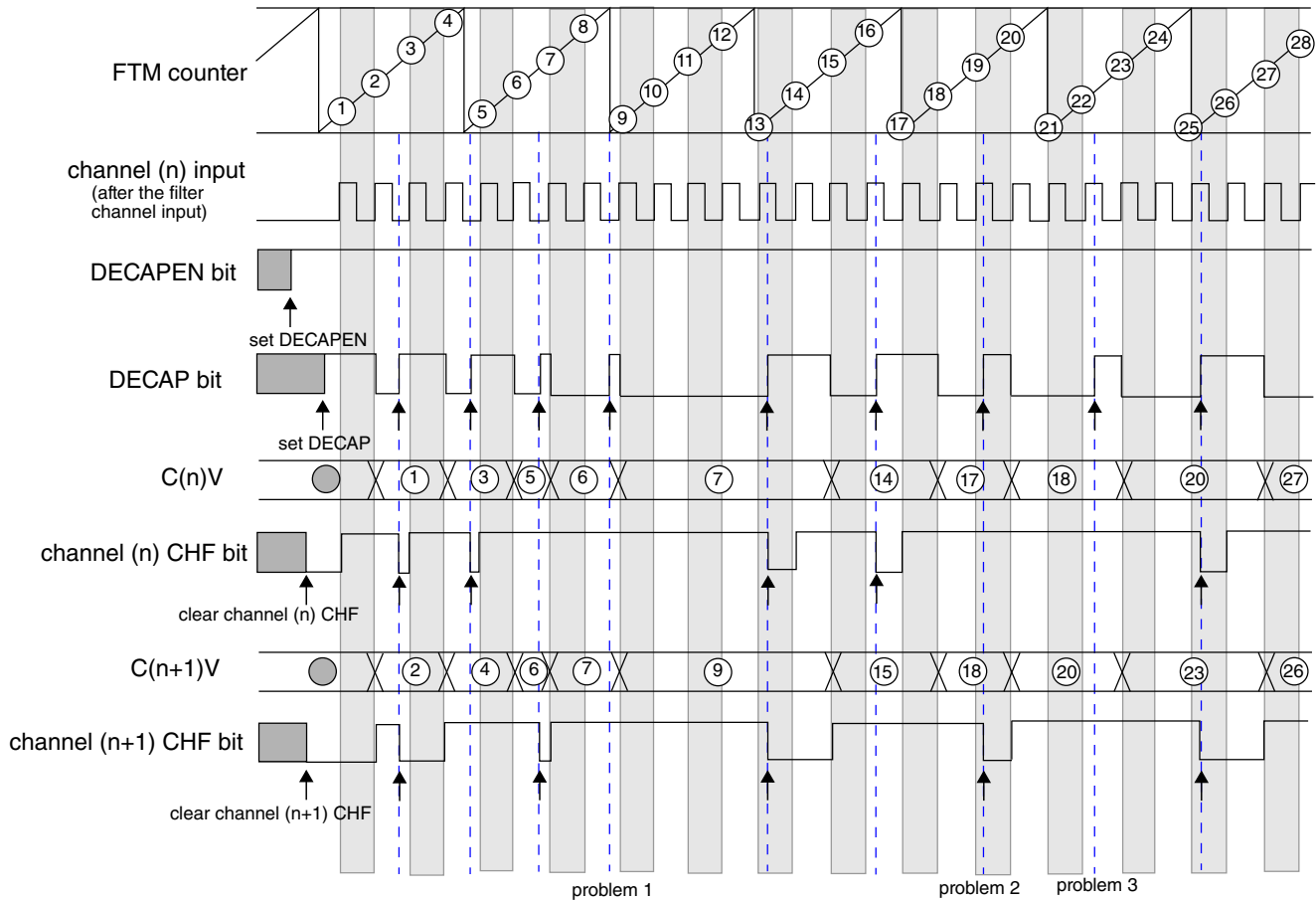

Note

- The commands set DECAPEN, set DECAP, clear channel (n) CHF, and clear channel (n+1) CHF are made by the user.
- Problem 1: channel (n) input = 0, set DECAP, not clear channel (n) CHF, and not clear channel (n+1) CHF.
- Problem 2: channel (n) input = 1, set DECAP, not clear channel (n) CHF, and clear channel (n+1) CHF.
- Problem 3: channel (n) input = 1, set DECAP, not clear channel (n) CHF, and not clear channel (n+1) CHF.

Figure 47-98. Dual Edge Capture – One-Shot mode to measure of the period between two consecutive rising edges

The following figure shows an example of the Dual Edge Capture – Continuous mode used to measure the period between two consecutive rising edges. The DECAPEN bit selects the Dual Edge Capture mode, so it remains set. While the DECAP bit is set the configured measurements are made. The channel (n) CHF bit is set when the first rising

Functional Description

edge is detected, that is, the edge selected by channel (n) ELSB:ELSA bits. The channel (n+1) CHF bit is set when the second rising edge is detected, that is, the edge selected by channel (n+1) ELSB:ELSA bits. The channel (n+1) CHF bit indicates when two edges of the period were captured and the C(n)V and C(n+1)V registers are ready for reading.

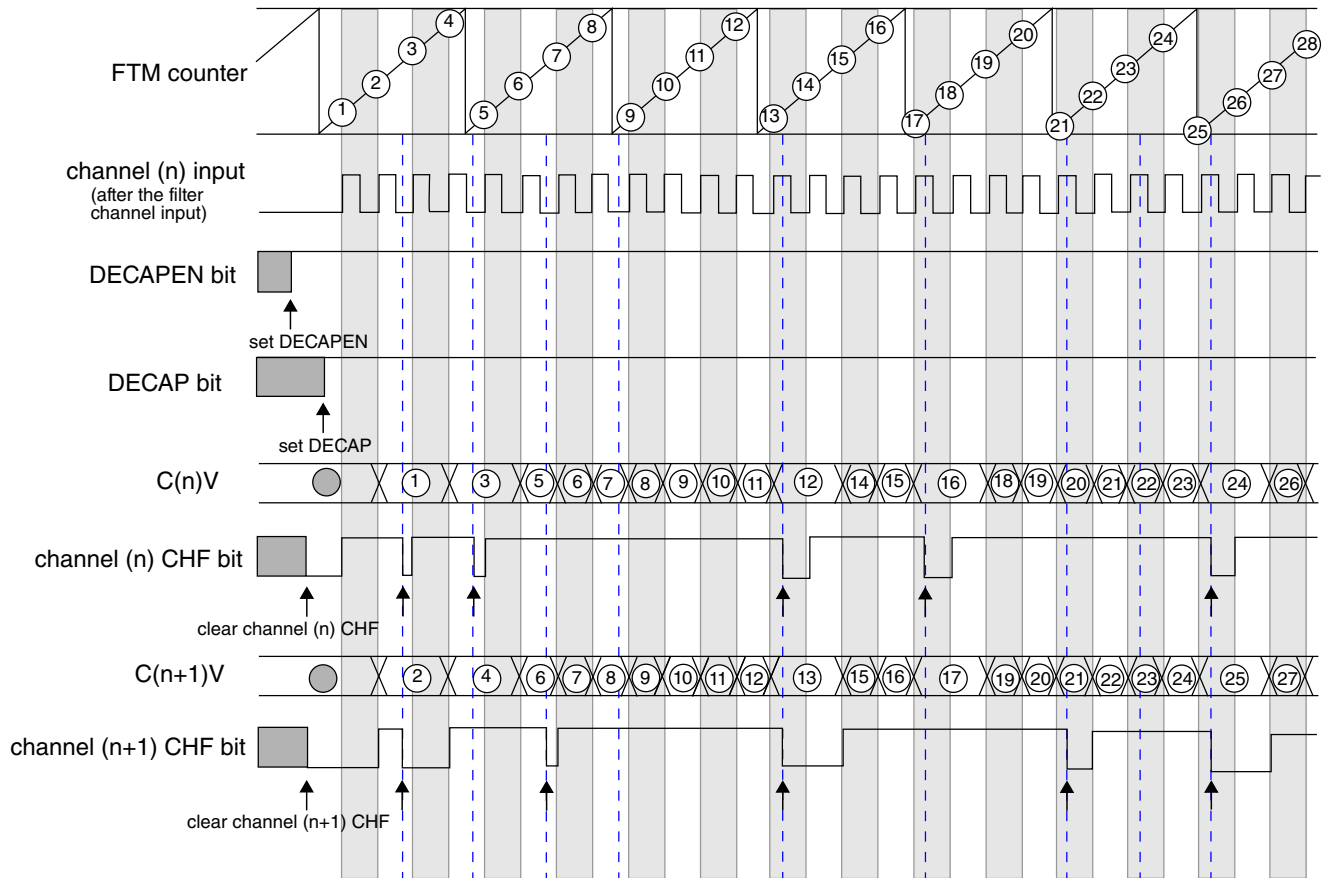

Note

- The commands set DECAPEN, set DECAP, clear channel (n) CHF, and clear channel (n+1) CHF are made by the user.

Figure 47-99. Dual Edge Capture – Continuous mode to measure of the period between two consecutive rising edges

47.5.26.5 Read coherency mechanism

The Dual Edge Capture mode implements a read coherency mechanism between the FTM counter value captured in C(n)V and C(n+1)V registers. The read coherency mechanism is illustrated in the following figure. In this example, the channels (n) and (n+1) are in Dual Edge Capture – Continuous mode for positive polarity pulse width measurement. Thus, the channel (n) is configured to capture the FTM counter value when there is a rising edge at channel (n) input signal, and channel (n+1) to capture the FTM counter value when there is a falling edge at channel (n) input signal.

When a rising edge occurs in the channel (n) input signal, the FTM counter value is captured into channel (n) capture buffer. The channel (n) capture buffer value is transferred to C(n)V register when a falling edge occurs in the channel (n) input signal. C(n)V register has the FTM counter value when the previous rising edge occurred, and the channel (n) capture buffer has the FTM counter value when the last rising edge occurred.

When a falling edge occurs in the channel (n) input signal, the FTM counter value is captured into channel (n+1) capture buffer. The channel (n+1) capture buffer value is transferred to C(n+1)V register when the C(n)V register is read.

In the following figure, the read of C(n)V returns the FTM counter value when the event 1 occurred and the read of C(n+1)V returns the FTM counter value when the event 2 occurred.

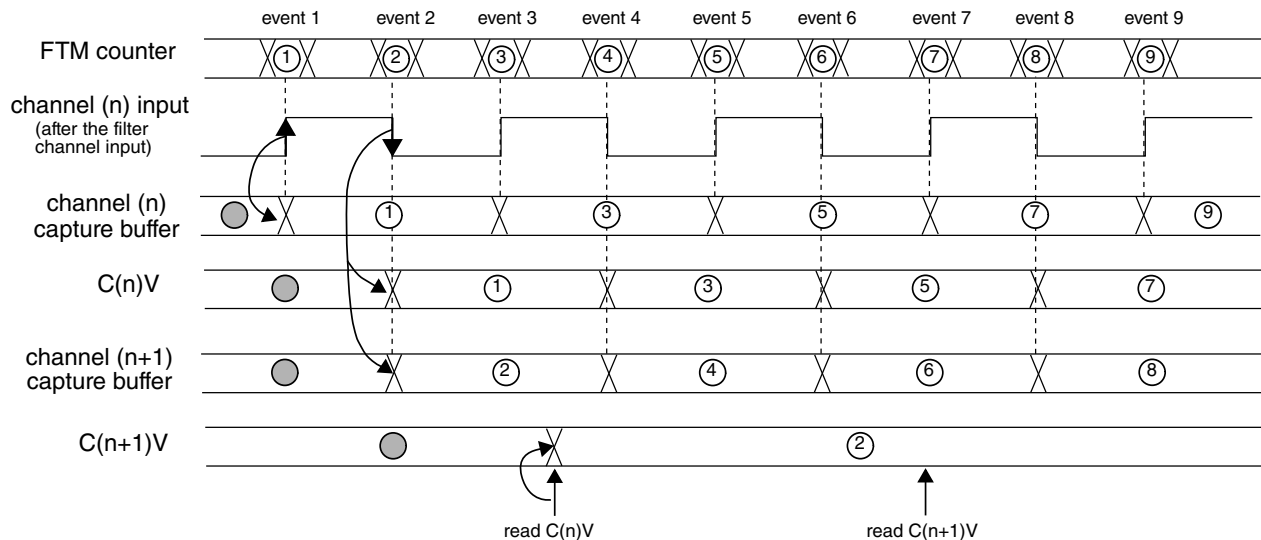

Figure 47-100. Dual Edge Capture mode read coherency mechanism

C(n)V register must be read prior to C(n+1)V register in dual edge capture one-shot and continuous modes for the read coherency mechanism works properly.

47.5.27 Quadrature Decoder Mode

The quadrature decoder mode is enabled if QUADEN = 1. The quadrature decoder mode uses the input signals phase A and B to control the FTM counter increment and decrement.

Functional Description

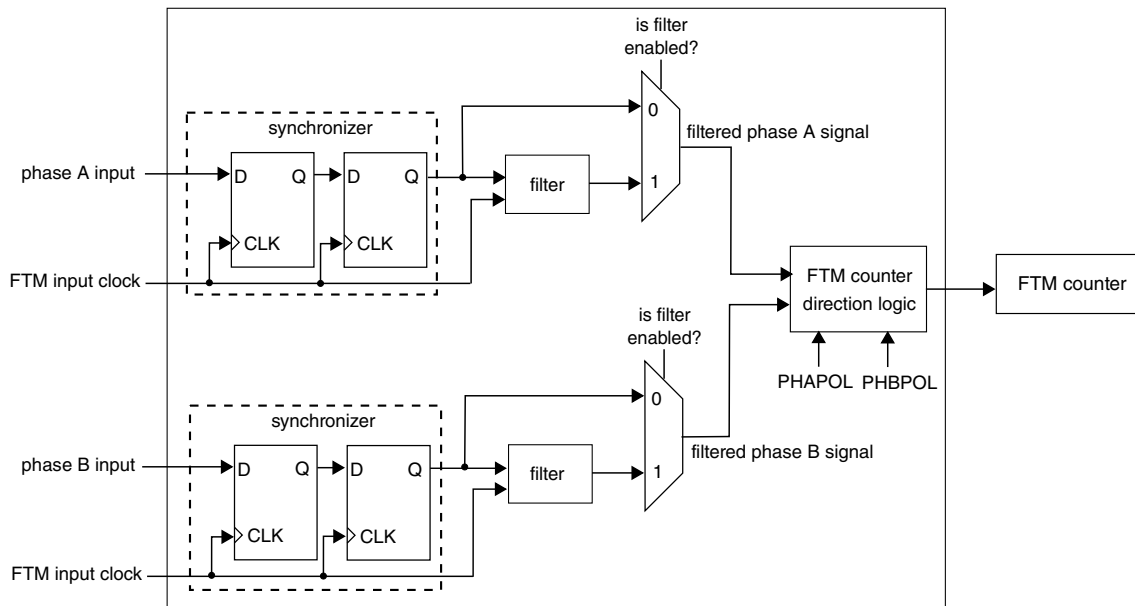

Figure 47-101. Diagram for Quadrature Decoder when FLTIPS[3:0] = 0

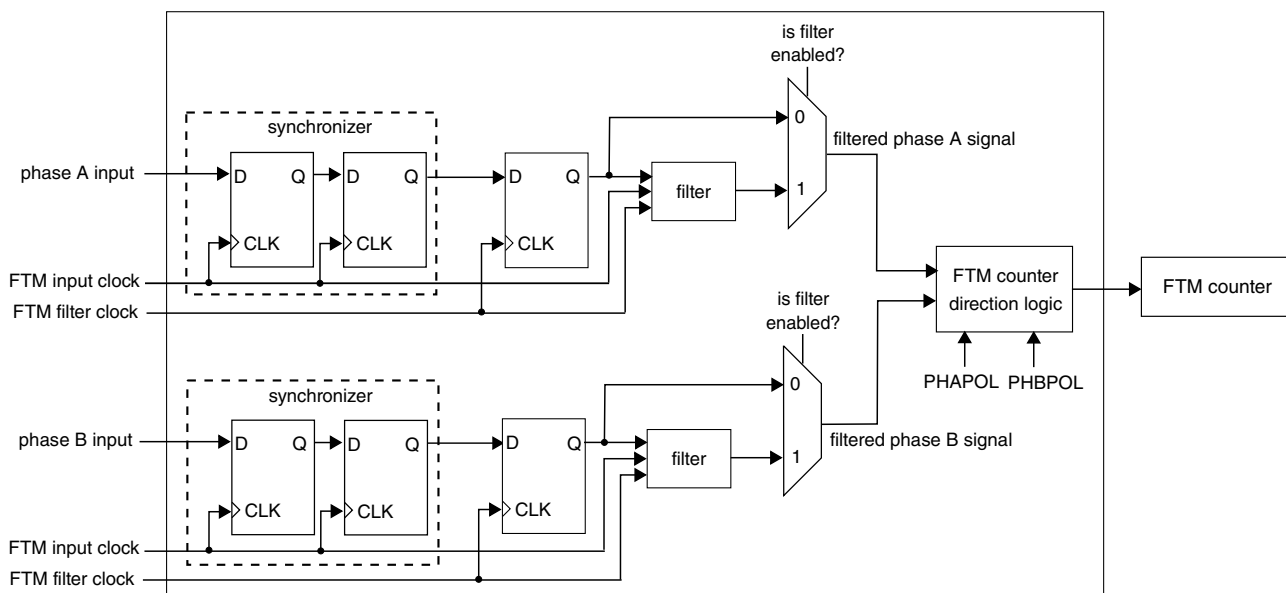

Figure 47-102. Diagram for Quadrature Decoder when FLTIPS[3:0] ≠ 0

Each one of input signals phase A and B has a filter that is equivalent to the channel input filter ([Filter for Input Capture Mode](#)). The phase A input filter is enabled by PHAFLTREN bit and its value is defined by CH0FVAL[3:0] bits. The phase B input filter is enabled by PHBFLTREN bit and its value is defined by CH1FVAL[3:0] bits.

Except for CH0FVAL[3:0] and CH1FVAL[3:0] bits, no channel logic is used in quadrature decoder mode.

Note

The FTM counter is clocked by the phase A and B input signals when quadrature decoder mode is enabled. Therefore it is expected that the quadrature decoder mode be used only with the FTM channels in input capture or output compare modes.

Note

An edge at phase A must not occur together an edge at phase B and vice-versa.

The PHAPOL bit selects the polarity of the phase A input, and the PHBPOL bit selects the polarity of the phase B input.

The QUADMODE selects the encoding mode used in the quadrature decoder mode. If $QUADMODE = 1$, then the count and direction encoding mode is enabled; see the following figure. In this mode, the phase B input value indicates the counting direction, and the phase A input defines the counting rate. The FTM counter is updated when there is a rising edge at phase A input signal.

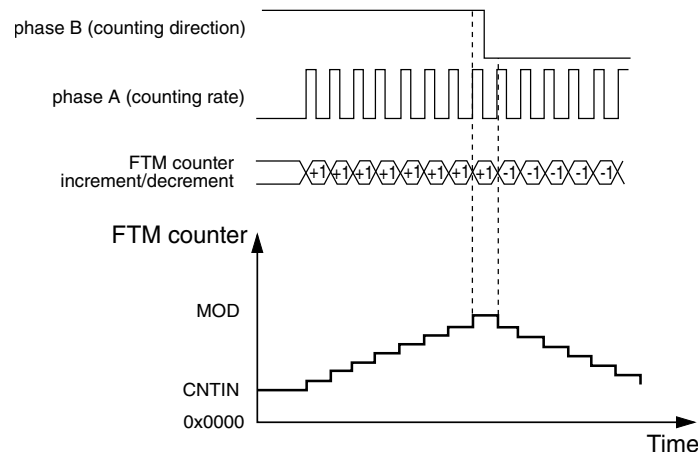

Figure 47-103. Quadrature Decoder – Count and Direction Encoding mode

If $QUADMODE = 0$, then the phase A and phase B Encoding mode is enabled; see the following figure. In this mode, the relationship between phase A and B signals indicates the counting direction, and phase A and B signals define the counting rate. The FTM counter is updated when there is an edge either at the phase A or phase B signals.

If $PHAPOL = 0$ and $PHBPOL = 0$, then the FTM counter increment happens when:

- there is a rising edge at phase A signal and phase B signal is at logic zero;
- there is a rising edge at phase B signal and phase A signal is at logic one;

Functional Description

- there is a falling edge at phase B signal and phase A signal is at logic zero;
- there is a falling edge at phase A signal and phase B signal is at logic one;

and the FTM counter decrement happens when:

- there is a falling edge at phase A signal and phase B signal is at logic zero;
- there is a falling edge at phase B signal and phase A signal is at logic one;
- there is a rising edge at phase B signal and phase A signal is at logic zero;
- there is a rising edge at phase A signal and phase B signal is at logic one.

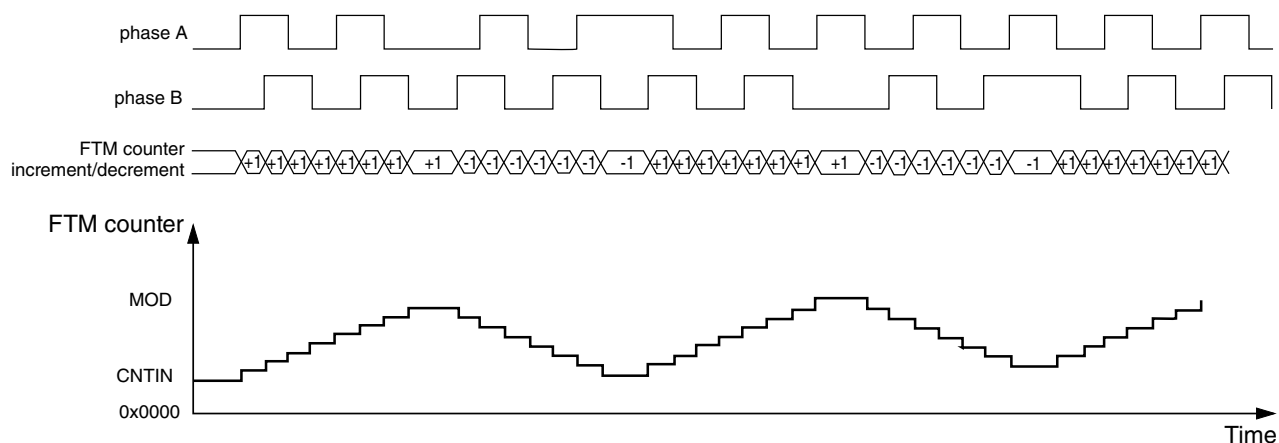

Figure 47-104. Quadrature Decoder – Phase A and Phase B Encoding Mode

The following figure shows the FTM counter overflow in up counting. In this case, when the FTM counter changes from MOD to CNTIN, TOF and TOFDIR bits are set. TOF bit indicates the FTM counter overflow occurred. TOFDIR indicates the counting was up when the FTM counter overflow occurred.

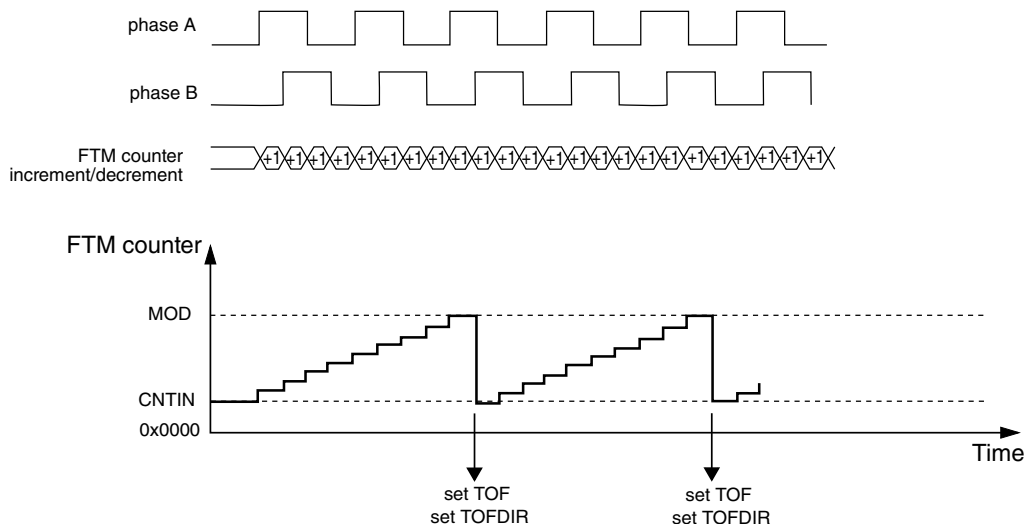

Figure 47-105. FTM Counter Overflow in Up Counting for Quadrature Decoder Mode

The following figure shows the FTM counter overflow in down counting. In this case, when the FTM counter changes from CNTIN to MOD, TOF bit is set and TOFDIR bit is cleared. TOF bit indicates the FTM counter overflow occurred. TOFDIR indicates the counting was down when the FTM counter overflow occurred.

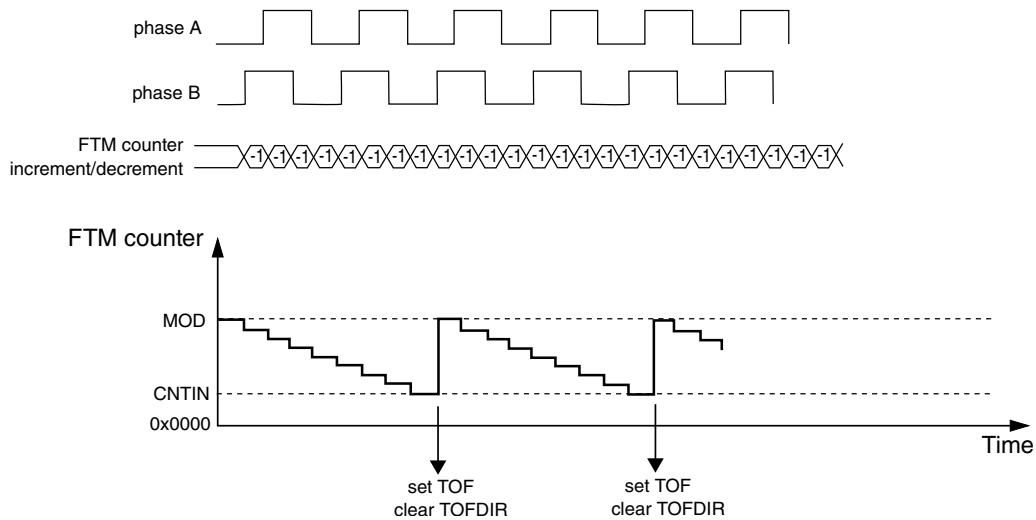

Figure 47-106. FTM Counter Overflow in Down Counting for Quadrature Decoder Mode

47.5.27.1 Quadrature Decoder boundary conditions

The following figures show the FTM counter responding to motor jittering typical in motor position control applications.

Functional Description

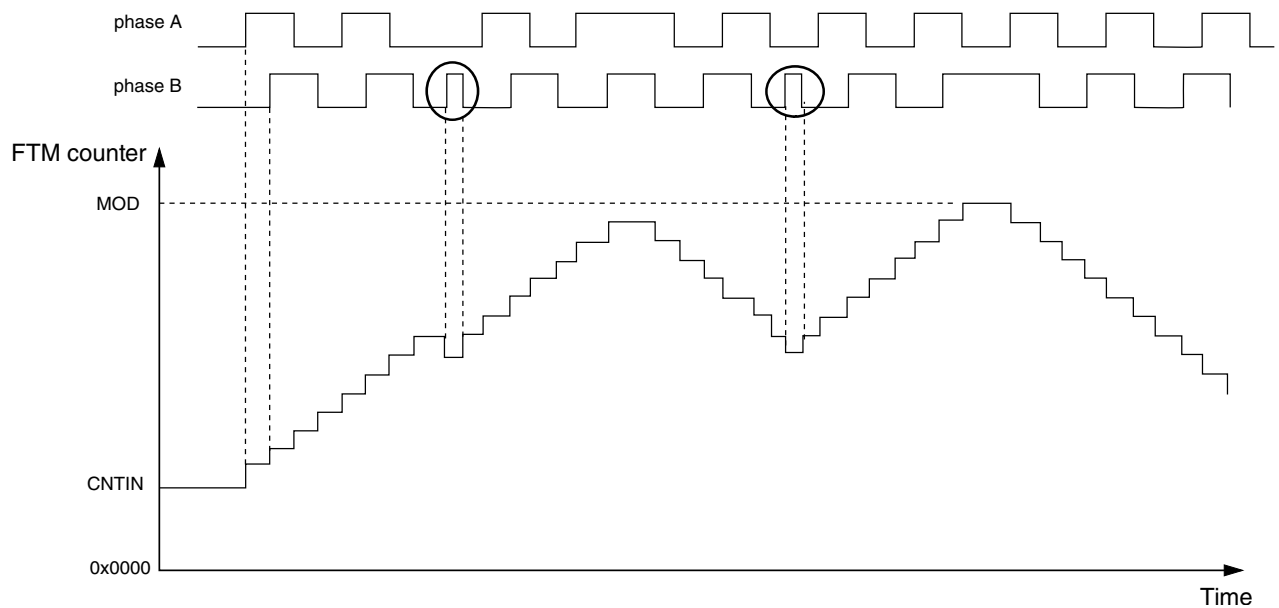

Figure 47-107. Motor position jittering in a mid count value

The following figure shows motor jittering produced by the phase B and A pulses respectively:

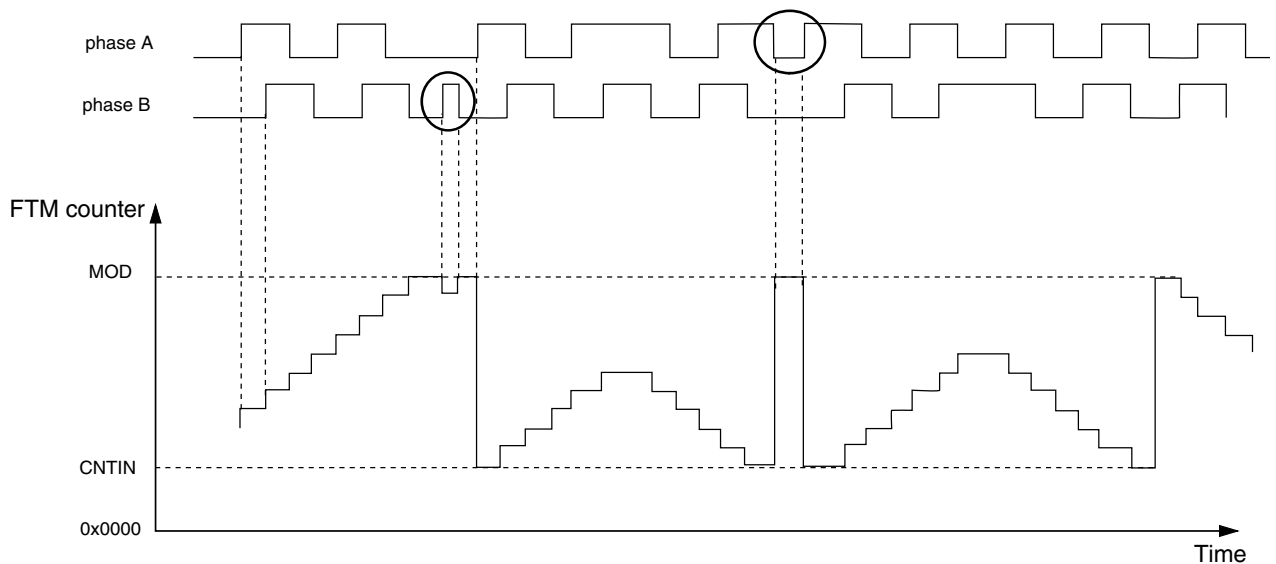

Figure 47-108. Motor position jittering near maximum and minimum count value

The first highlighted transition causes a jitter on the FTM counter value near the maximum count value (MOD). The second indicated transition occurs on phase A and causes the FTM counter transition between the maximum and minimum count values which are defined by MOD and CNTIN registers.

The appropriate settings of the phase A and phase B input filters are important to avoid glitches that may cause oscillation on the FTM counter value. The preceding figures show examples of oscillations that can be caused by poor input filter setup. Thus, it is important to guarantee a minimum pulse width to avoid these oscillations.

47.5.28 Debug mode

When the chip is in Debug mode, the BDMODE[1:0] bits select the behavior of the FTM counter, the channel (n) CHF bit, the channels output, and the writes to the MOD, CNTIN, and C(n)V registers according to the following table.

Table 47-20. FTM behavior when the chip is in Debug mode

BDMODE	FTM Counter	channel (n) CHF bit	FTM Channels Output	Writes to MOD, CNTIN, and C(n)V Registers
00	Stopped	can be set	Functional mode	Writes to these registers bypass the registers buffers
01	Stopped	is not set	The channels outputs are forced to their safe value according to POLn bit	Writes to these registers bypass the registers buffers
10	Stopped	is not set	The channels outputs are frozen when the chip enters in Debug mode	Writes to these registers bypass the registers buffers
11	Functional mode	can be set	Functional mode	Functional mode

Note that if BDMODE[1:0] = 2'b00 then the channels outputs remain at the value when the chip enters in Debug mode, because the FTM counter is stopped. However, the following situations modify the channels outputs in this Debug mode.

- Write any value to CNT register; see [Counter reset](#). In this case, the FTM counter is updated with the CNTIN register value and the channels outputs are updated to the initial value – except for those channels set to Output Compare mode.
- FTM counter is reset by PWM Synchronization mode; see [FTM counter synchronization](#). In this case, the FTM counter is updated with the CNTIN register value and the channels outputs are updated to the initial value – except for channels in Output Compare mode.
- In the channels outputs initialization, the channel (n) output is forced to the CH(n)OI bit value when the value 1 is written to INIT bit. See [Initialization](#).

Note

The BDMODE[1:0] = 2'b00 must not be used with the **Fault Control**. Even if the fault control is enabled and a fault condition exists, the channels outputs are updated as above.

Note

If CLKS[1:0] = 2'b00 in Debug, a non-zero value is written to CLKS in Debug, and CnV = CNTIN when the Debug is disabled, then the CHF bit is set (since if the channel is a 0% EPWM signal) when the Debug is disabled.

47.5.29 Reload Points

This feature allows to update the registers CNTIN, HCR, MOD and C(n)V with the value of their write buffer at the selected reload point.

NOTE

- This feature is independent of the PWM synchronization.
- At these reload points neither the channels outputs nor the FTM counter are changed. Software must select these reload points at the safe points in time.

47.5.29.1 Reload Opportunities

The reload opportunities are:

1. At the half cycle

This reload opportunity is enabled if (HCSEL = 1) and it happens at the half cycle (FTM counter = HCR register). The software should calculate the half cycle value according to the FTM counter configuration, then writes this value to the register HCR.

2. At the channel (n) match

This reload opportunity is enabled if (CH(n)SEL = 1) and it happens at the channel (n) match (FTM counter = C(n)V).

3. When the FTM counter is an up counter

This reload opportunity is when the FTM counter changes from (MOD) to (CNTIN - 1) and it is always enabled.

The following figure shows an example of the reload opportunities at the half cycle, at the channels match, and when the FTM counter is an up counter.

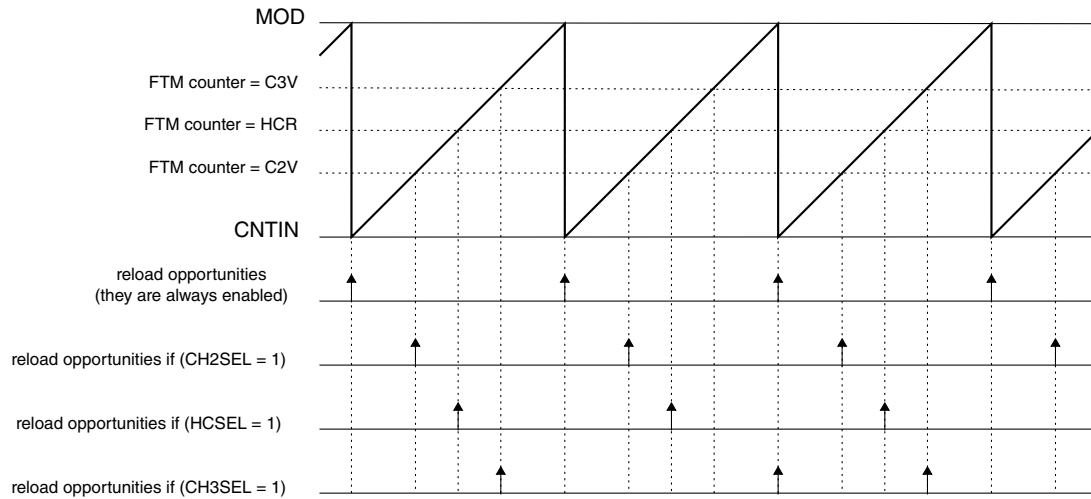

Figure 47-109. Reload opportunities when the FTM counter is an up counter

4. When the FTM counter is an up-down counter

In this case, the reload opportunities are enabled by the bits CNTMAX and CNTMIN according to [Table 47-21](#).

Table 47-21. Reload opportunities enabled by the bits CNTMAX and CNTMIN when the FTM counter is up-down counter

CNTMAX	CNTMIN	Reload Opportunities
0	0	when the FTM counter changes from (MOD) to (MOD - 1)
0	1	when the FTM counter changes from (CNTMIN) to (CNTMIN + 1)
1	0	when the FTM counter changes from (MOD) to (MOD - 1)
1	1	<ul style="list-style-type: none"> when the FTM counter changes from (MOD) to (MOD - 1), and when the FTM counter changes from (CNTMIN) to (CNTMIN + 1)

The following figure shows an example of the reload opportunities at the half cycle, at the channels match, and when the FTM counter is an up-down counter.

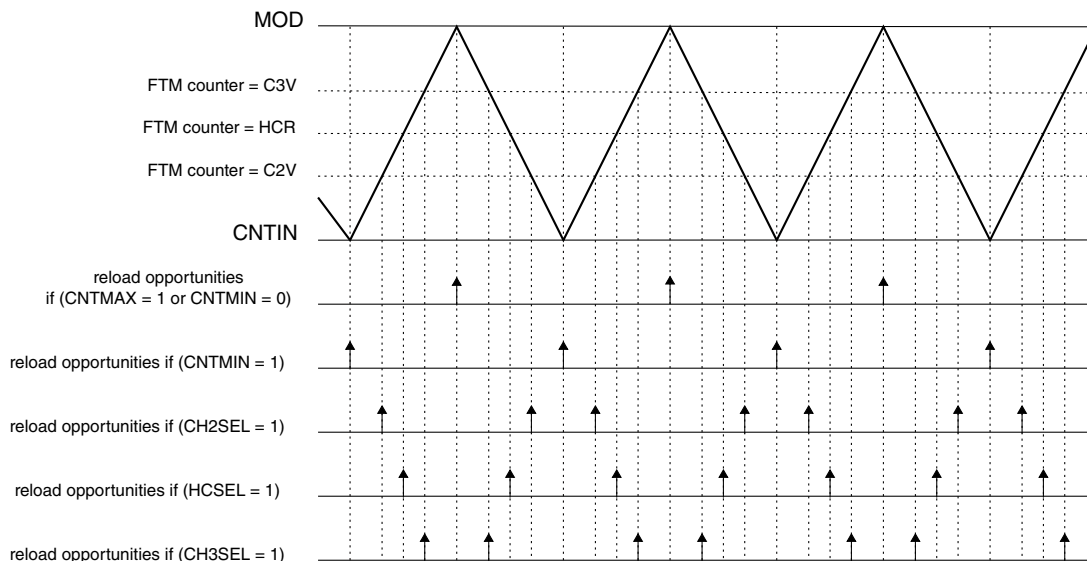

Figure 47-110. Reload opportunities when the FTM counter is an up-down counter

47.5.29.2 Frequency of Reload Opportunities

The LDFQ[4:0] bits define the number of enabled reload opportunities should happen until an enabled reload opportunity becomes a reload point. The following figure shows an example when the LDFQ[4:0] = 4.

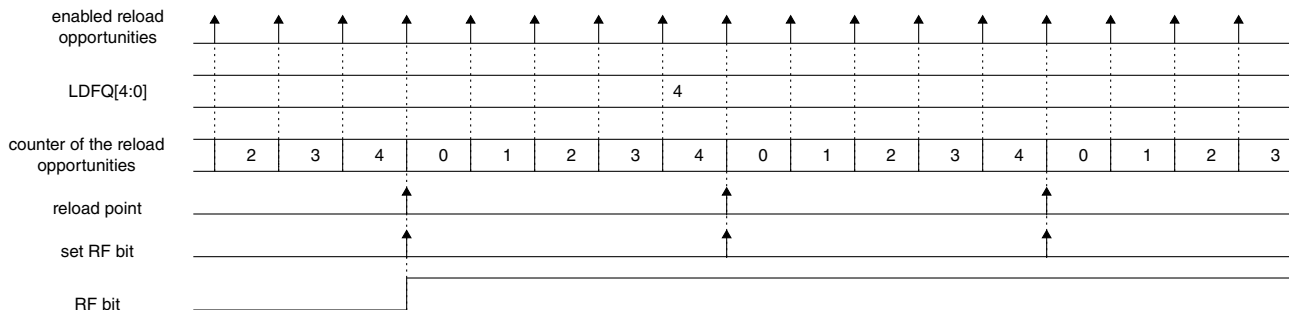

Figure 47-111. Frequency of Reload Opportunities with LDFQ[4:0] = 4

If LDFQ[4:0] = 0, then all reload opportunities are reload points.

The counter of the reload opportunities is reset when there is a write to the register CNT.

The RF bit is set at each reload point (see the figure above) independent of LDOK bit value. The reload point interrupt is generated when (RF = 1) and (RIE = 1).

47.5.29.3 Update of the Registers

After writing new value to the registers with write buffer, selecting which of them will be updated (according to [Table 47-22](#)), selecting the reload opportunities, selecting the frequency of the reload opportunities, thus the LDOK bit should be set to enable the update of these registers at the next reload point.

Table 47-22. Additional conditions to update the registers

Register	Additional Condition
CNTIN	CNTINC = 1
HCR	-
MOD	-
C(n)V and C(n+1)V	SYNCEN _m = 1, where m is the pair of the channels (n) and (n +1)

47.5.30 Global Load

The global load mechanism allows several modules to have their double buffered registers synchronously reloaded after a synchronization event if a write to one operation is performed in the global load OK (GLDOK) bit in the PWMLOAD register. Global load may be enabled or disabled configuring the global load enable (GLEN) bit in the PWMLOAD register. Writing one in the GLDOK bit with GLEN enabled has the same effect of writing one in the LDOK bit. Refer to SoC specific information about global load connections.

Global load mechanism allows MOD, HCR, CNTIN, and C(n)V registers to be updated with the content of the register buffer at configurable reload point. The figure below shows an example of connection between FTM global load inputs and outputs considering that GLDOK bit is implemented outside from FTM module.

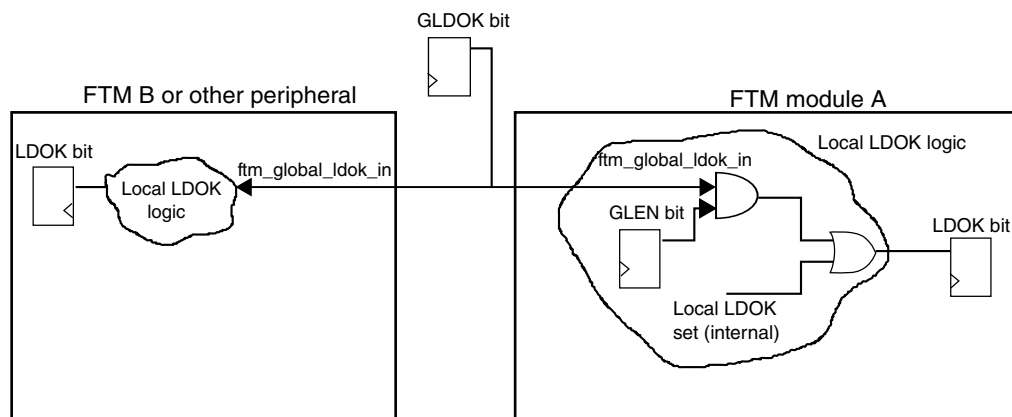

Figure 47-112. Global load logic

47.5.31 Global time base (GTB)

The global time base (GTB) is a FTM function that allows the synchronization of multiple FTM modules on a chip. The following figure shows an example of the GTB feature used to synchronize two FTM modules. In this case, the FTM A and B channels can behave as if just one FTM module was used, that is, a global time base.

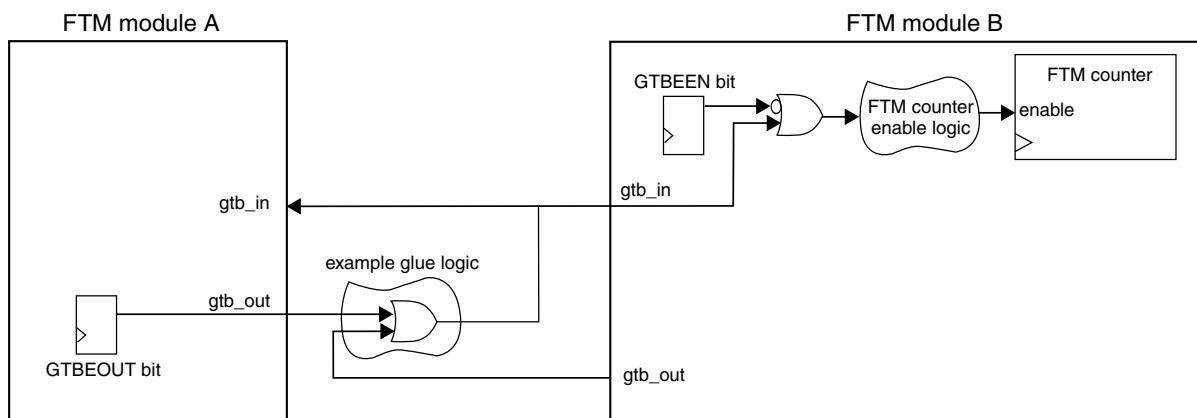

Figure 47-113. Global time base (GTB) block diagram

The GTB functionality is implemented by the GTBEEN and GTBEOUT bits in the CONF register, the input signal *gtb_in*, and the output signal *gtb_out*. The GTBEEN bit enables *gtb_in* to control the FTM counter enable signal:

- If GTBEEN = 0, each one of FTM modules works independently according to their configured mode.
- If GTBEEN = 1, the FTM counter update is enabled only when *gtb_in* is 1.

In the configuration described in the preceding figure, FTM modules A and B have their FTM counters enabled if at least one of the *gtb_out* signals from one of the FTM modules is 1. There are several possible configurations for the interconnection of the *gtb_in* and *gtb_out* signals, represented by the example glue logic shown in the figure. Note that these configurations are chip-dependent and implemented outside of the FTM modules. See the chip-specific FTM information for the chip's specific implementation.

NOTE

- In order to use the GTB signals to synchronize the FTM counter of different FTM modules, the configuration of each FTM module should guarantee that its FTM counter starts counting as soon as the *gtb_in* signal is 1.
- The GTB feature does not provide continuous synchronization of FTM counters, meaning that the FTM counters may lose synchronization during FTM operation.

The GTB feature only allows the FTM counters to *start* their operation synchronously.

47.5.31.1 Enabling the global time base (GTB)

To enable the GTB feature, follow these steps for each participating FTM module:

1. Stop the FTM counter: Write 00b to SC[CLKS].
2. Program the FTM to the intended configuration. The FTM counter mode needs to be consistent across all participating modules.
3. Write 1 to CONF[GTBEEN] and write 0 to CONF[GTBEOOUT] at the same time.
4. Select the intended FTM counter clock source in SC[CLKS]. The clock source needs to be consistent across all participating modules.
5. Reset the FTM counter: Write any value to the CNT register.

To initiate the GTB feature in the configuration described in the preceding figure, write 1 to CONF[GTBEOOUT] in the FTM module used as the time base.

47.5.32 Channel trigger output

The channel trigger output provides a trigger signal which has one FTM input clock period width in the channel (n) output.

If the TRIGMODE bit of the CnSC register is set (TRIGMODE = 1), a trigger pulse with one FTM input clock width is generated in the channel (n) output when a match occurs. It is only allowed to use trigger mode when channel (n) is in EPWM or CPWM modes.

The figures below show some cases of channel (n) trigger generation in the channel (n) output.

MOD = 0x0005
CnV = 0x0003
PS[2:0] = 001
TRIGMODE = 1

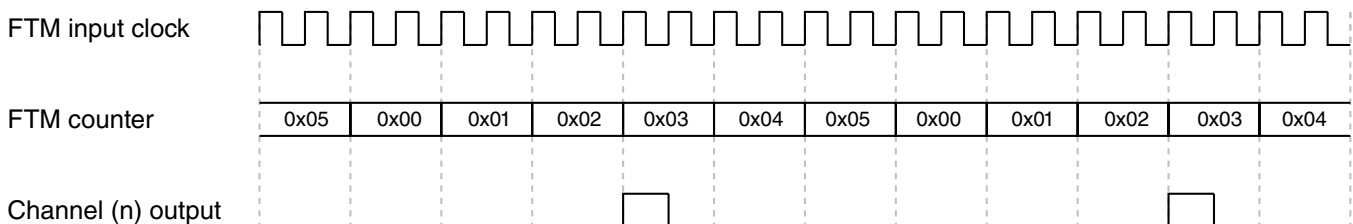

Figure 47-114. Example of channel (n) trigger at the channel (n) output in EPWM mode

Functional Description

MOD = 0x0005
 CnV = 0x0003
 PS[2:0] = 000
 TRIGMODE = 1
 CPWM mode

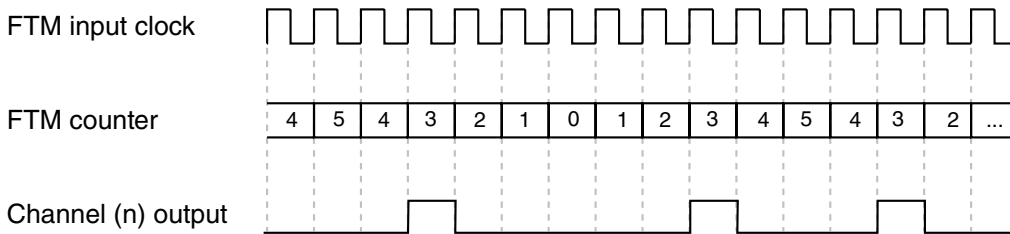

Figure 47-115. Example of channel (n) trigger at the channel (n) output in CPWM mode

47.5.33 External Control of Channels Output

The channel (n) PWMEN bit can be used in an FTM external logic to control the final value of the channel (n) output. This same logic can also control the channel (n) output when FSTATE = 1 and the channel (n) output is disabled by the Fault Control. The following figure shows an example of this external logic.

The term "channel (n) output" means the channel (n) output value after the Polarity Control. See [Features Priority](#) and [Polarity Control](#) for more details.

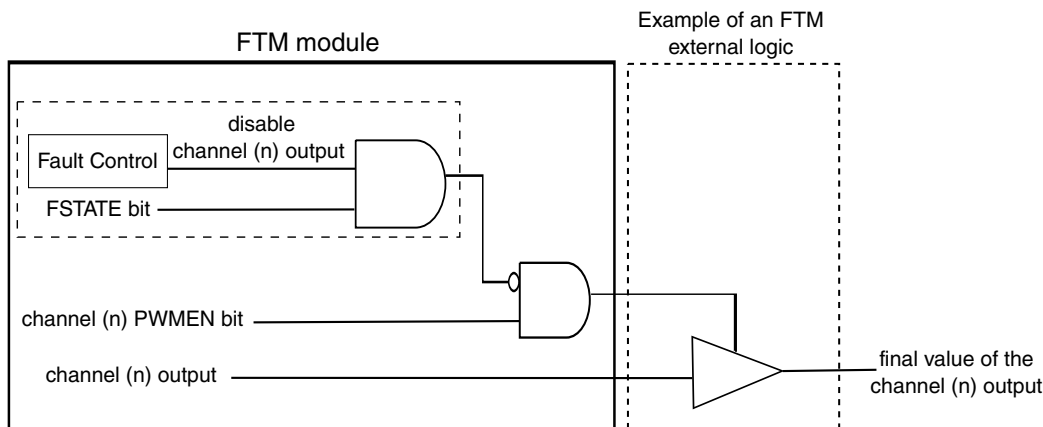

Figure 47-116. Example of the External Control of the Channel (n) Output

47.5.34 Dithering

FTM implements a fractional delay to achieve fine resolution on the generated PWM signals using dithering. The dithering can be used by applications where more resolution than one unit of the FTM counter is needed.

Two kinds of dithering are available: PWM period dithering and edge dithering.

47.5.34.1 PWM Period Dithering

The PWM period dithering is enabled when a non-zero value is written to FRACMOD.

The internal accumulator used in the PWM period dithering is reset when:

- the field MOD of the register MOD_MIRROR is updated with the value of its write buffer,
- the FRACMOD is updated with the value of its write buffer, or
- the FTM counter is stopped.

NOTE

For the PWM period dithering, the register MOD_MIRROR should be used instead of the register MOD.

To avoid inconsistencies, the field FRACMOD is cleared when the field MOD of the register MOD is updated with the value of its write buffer.

The PWM period dithering is not available:

- when the FTM counter is a free running counter
- when the FTM is in quadrature decoder mode

47.5.34.1.1 Up Counting

When the FTM counter is an up counter and the PWM period dithering is enabled, at the end of each PWM period, the FRACMOD value is added to an internal 5-bit accumulator. When this accumulator overflows (that is, the result of the adding is greater or equal than 0x20), then one unit of FTM counter is added to the end of the current PWM period, and the accumulator remains with the rest of the subtraction: (the result of this adding - 0x20).

Due to one unit of FTM counter that can be added to the PWM period, the largest valid value for MOD is 0xFFFFE for PWM period dithering with unsigned counting and 0x7FFE for PWM period dithering with signed counting.

The following figures show some examples of PWM period dithering when the FTM counter is an up counter.

NOTE

For the generation of 100% PWM signal in the channel (n) (with channel (n) ELSB:ELSA = 2'b10) using EPWM mode and PWM Period Dithering, it is recommended to use $(C(n) > MOD + 1)$.

For the generation of PWM signals in the channel (n) (with channel (n) ELSB:ELSA = 2'b10) using Combine mode and PWM Period Dithering, it is recommended to use:

- For 0% PWM signal: $(C(n)V > MOD + 1)$ and $(C(n+1)V > MOD + 1)$;
- For 100% PWM signal: $(C(n)V = CNTIN)$ and $(C(n+1)V > MOD + 1)$.

For the generation of PWM signals in the channel (n) (with channel (n) ELSB:ELSA = 2'b10) using Modified Combine PWM mode and PWM Period Dithering, it is recommended to use:

- For 0% PWM signal: $(C(n)V > MOD + 1)$ and $(CNTIN \leq C(n+1)V \leq MOD)$;
- For 100% PWM signal: $(CNTIN \leq C(n)V \leq MOD)$ and $(C(n+1)V > MOD + 1)$.

47.5.34.1.2 Up-Down Counting

When the FTM counter is an up-down counter and the PWM period dithering is enabled, at the end of each PWM period, the FRACMOD value is added to an internal 5-bit accumulator. When this accumulator overflows (that is, the result of the adding is greater or equal than 0x20), then one unit of FTM counter is added to the end of the current PWM period and other unit is added to the begin of the next PWM period (see the figure below). After the accumulator overflows, the accumulator remains with the rest of the subtraction: (the result of this adding - 0x20).

Due to one unit of FTM counter that can be added to the PWM period, the largest valid value for MOD is 0x7FFE for PWM period dithering in up-down counting (CPWM mode).

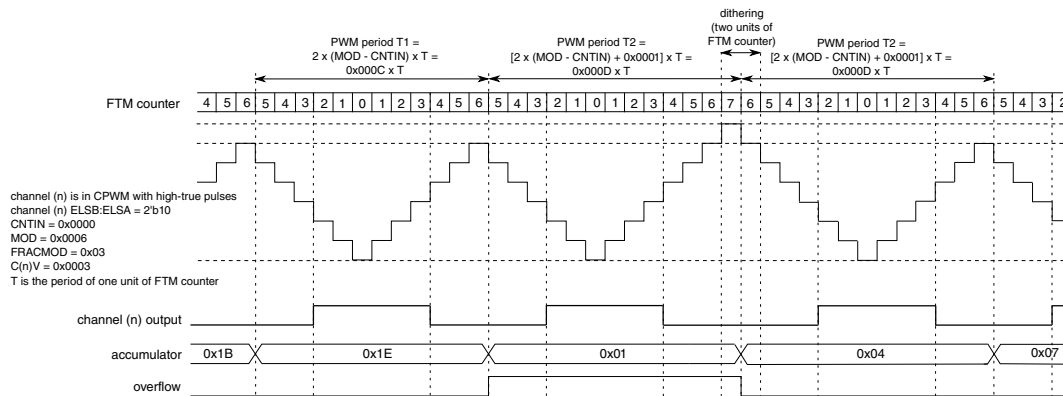

Figure 47-119. PWM Period Dithering with Up-Down Counting

NOTE

For the generation of 100% PWM signal in the channel (n) (with channel (n) ELSB:ELSA = 2'b10) using CPWM mode and PWM Period Dithering, it is recommended to use (C(n)V[15] = 0) and (C(n)V > MOD + 1) and (MOD ≠ 0x0000).

47.5.34.2 PWM Edge Dithering

The channel (n) internal accumulator used in the PWM edge dithering is reset when:

- the field VAL of the register C(n)V_MIRROR is updated with the value of its write buffer,
- the FRACVAL is updated with the value of its write buffer, or
- the FTM counter is stopped.

NOTE

For the PWM edge dithering, the register C(n)V_MIRROR should be used instead of the register C(n)V.

To avoid inconsistencies, the field FRACVAL is cleared when the field VAL of the register C(n)V is updated with the value of its write buffer.

The PWM edge dithering is not available:

- to the channel in input modes, and
- to the channel in output compare mode.

47.5.34.2.1 EPWM Mode

The PWM edge dithering for channel (n) in EPWM mode is enabled when a non-zero value is written to the channel (n) `FRACVAL`.

If the channel (n) is in EPWM mode and the PWM edge dithering is enabled, at the end of each EPWM period, the channel (n) `FRACVAL` value is added to the channel (n) internal 5-bit accumulator. When this accumulator overflows (that is, the result of the adding is greater or equal than `0x20`), the accumulator remains with the rest of the subtraction: (the result of this adding - `0x20`).

In this configuration, the initial edge of EPWM duty cycle happens when (FTM counter = `CNTIN`), its position is not modified by the PWM edge dithering. If there was not the overflow of the channel (n) accumulator in the current EPWM period, then the final edge of EPWM duty cycle happens on the channel (n) match (FTM counter = `C(n)V`), that is, its position is not modified by the edge dithering. However, if there was the overflow of the channel (n) accumulator in the current EPWM period, then the final edge of EPWM duty cycle happens when (FTM counter = `C(n)V + 0x0001`).

The following figures show some examples of PWM edge dithering when the channel (n) is in EPWM mode.

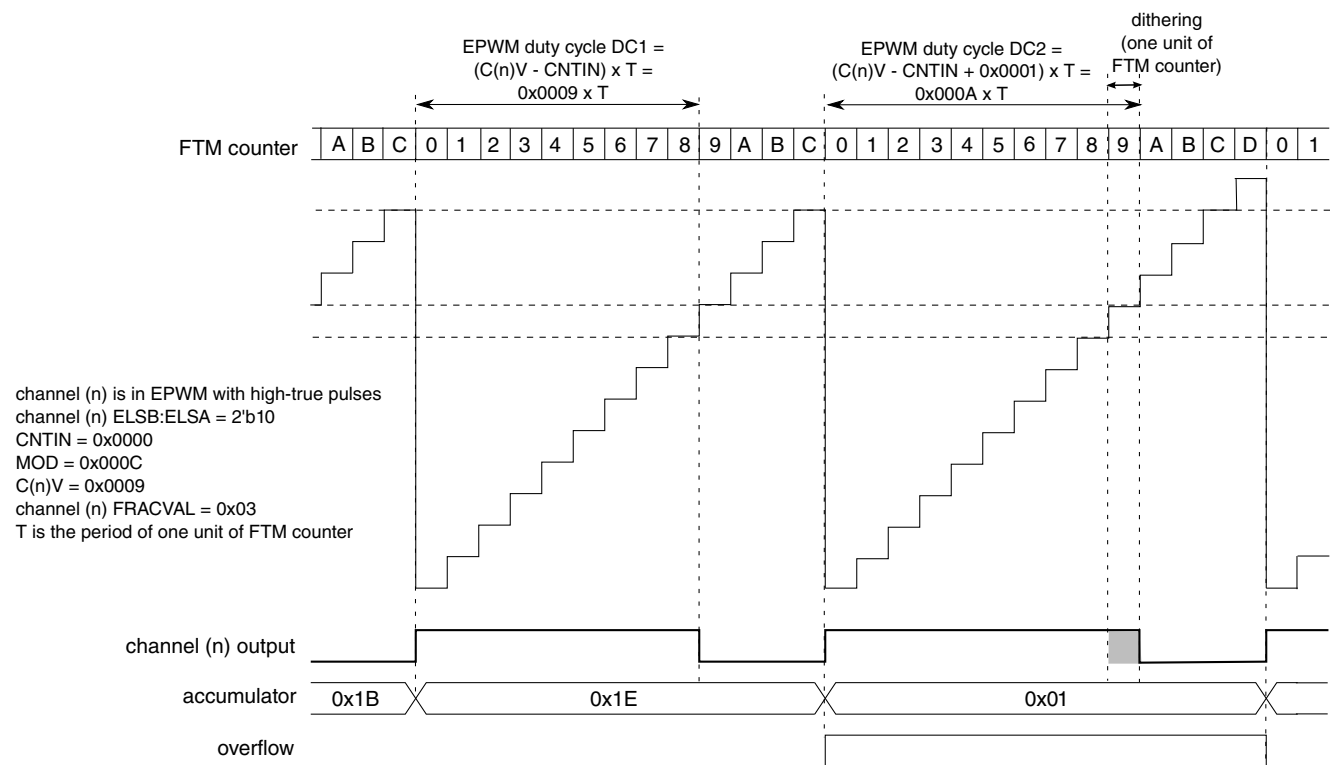

Figure 47-120. Channel (n) is in EPWM Mode with PWM Edge Dithering

Assuming:

Functional Description

- the channel (n) is in EPWM mode,
- T is one unit of FTM counter,
- the EPWM duty cycle without edge dithering is $[(C(n)V - CNTIN) \times T]$,
- the number of PWM periods which duty cycle that has edge dithering is FRACVAL,
- the EWM duty cycle with edge dithering is $[(C(n)V - CNTIN + 1) \times T]$,

thus, the average duty cycle (in decimal) is $[(C(n)V - CNTIN) + (FRACVAL/32)] \times T$, where the integer value is $(C(n)V - CNTIN)$ and the fractional value is $(FRACVAL/32)$. See the example below.

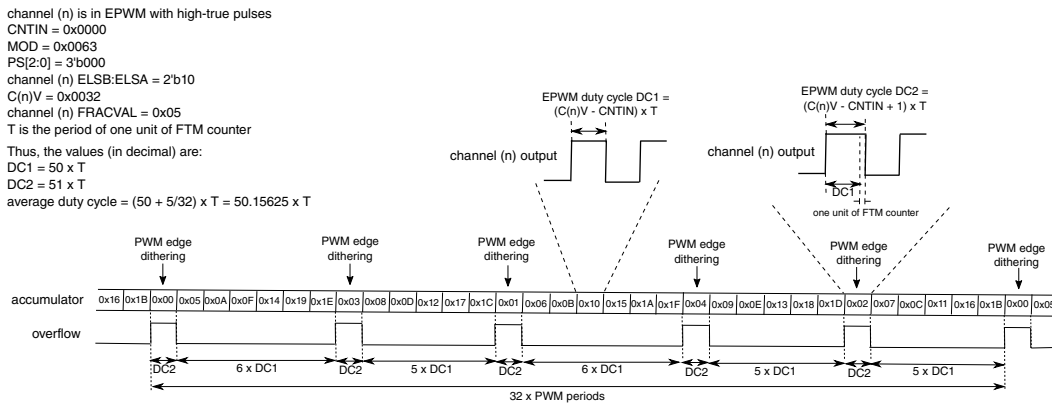

Figure 47-121. Example of Average Duty Cycle when the Channel (n) is in EPWM Mode with PWM Edge Dithering

47.5.34.2.2 CPWM Mode

The PWM edge dithering for channel (n) in CPWM mode is enabled when a non-zero value is written to the channel (n) FRACVAL.

If the channel (n) is in CPWM mode and the PWM edge dithering is enabled, at the end of each CPWM period, the channel (n) FRACVAL value is added to the channel (n) internal 5-bit accumulator. When this accumulator overflows (that is, the result of the adding is greater or equal than 0x20), the accumulator remains with the rest of the subtraction: (the result of this adding - 0x20).

In this configuration, if there was not the overflow of the channel (n) accumulator in the current CPWM period, then the duty cycle is not modified by the PWM edge dithering, that is, the initial edge of CPWM duty cycle happens on channel (n) match (FTM counter = C(n)V) when the FTM counter is decrementing, and the final edge of CPWM duty cycle on channel (n) match when the FTM counter is incrementing.

However, if there was the overflow of the channel (n) accumulator in the current CPWM period, then the initial edge of CPWM duty cycle happens when (FTM counter = $C(n)V + 0x0001$) and the FTM counter is decrementing, and the final edge of CPWM duty cycle when (FTM counter = $C(n)V + 0x0001$) and the FTM counter is incrementing.

The following figure shows an example of PWM edge dithering when the channel (n) is in CPWM mode.

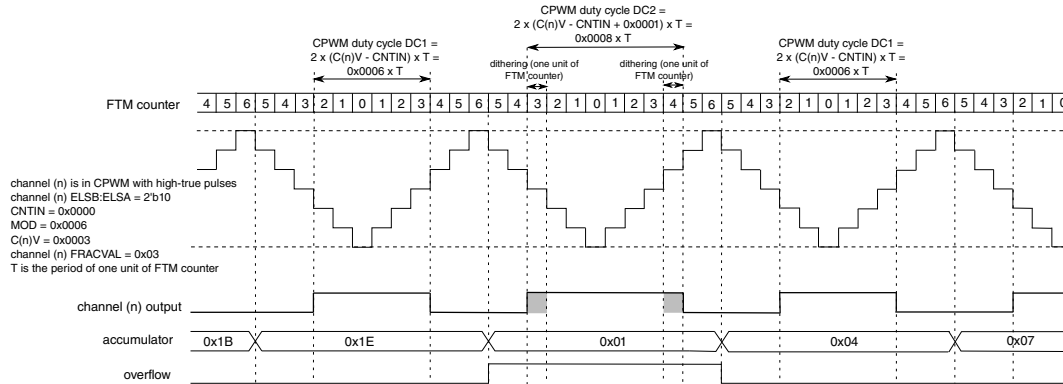

Figure 47-122. Channel (n) is in CPWM Mode with PWM Edge Dithering

47.5.34.2.3 Combine Mode

In the Combine mode, the PWM edge dithering can be done:

- in the channel (n) match (FTM counter = $C(n)V$) edge or
- in the channel (n+1) match (FTM counter = $C(n+1)V$) edge.

The channel (n) match edge dithering is enabled when a non-zero value is written to the channel (n) FRACVAL.

For the channel (n) match edge dithering, the channel (n) has an internal 5-bit accumulator. At the end of each PWM period, the channel (n) FRACVAL value is added to the channel (n) accumulator. When this accumulator overflows (that is, the result of the adding is greater or equal than $0x20$), the accumulator remains with the rest of the subtraction: (the result of this adding - $0x20$).

If there was not the overflow of the channel (n) accumulator in the current PWM period, the channel (n) match edge is not modified, that is, it happens on channel (n) match. However, if there was the overflow of the channel (n) accumulator, the channel (n) match edge happens when (FTM counter = $C(n)V + 0x0001$).

The following figure shows an example of the channel (n) match edge dithering when the channels (n) and (n+1) are in Combine mode.

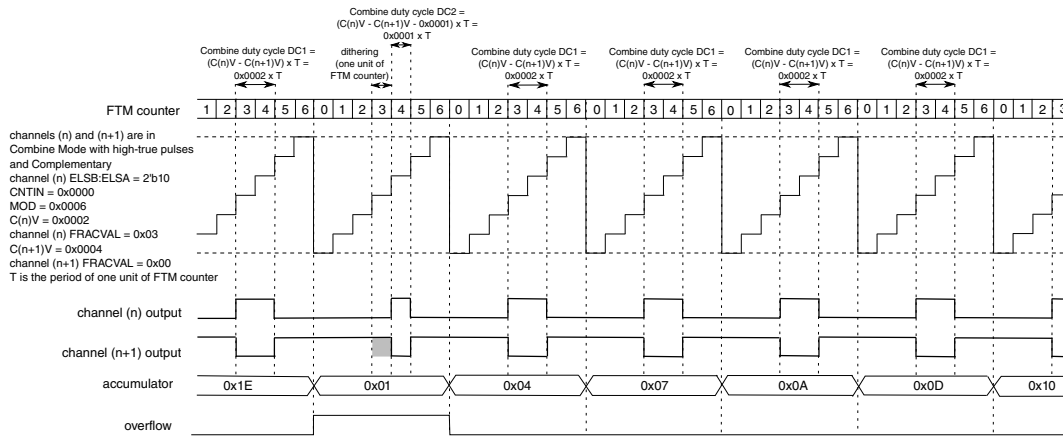

Figure 47-123. Channel (n) Match Edge Dithering in Combine Mode

The channel (n+1) match edge dithering is enabled when a non-zero value is written to the channel (n+1) FRACVAL.

For the channel (n+1) match edge dithering, the channel (n+1) has an internal 5-bit accumulator. At the end of each PWM period, the channel (n+1) FRACVAL value is added to the channel (n+1) accumulator. When this accumulator overflows (that is, the result of the adding is greater or equal than 0x20), the accumulator remains with the rest of the subtraction: (the result of this adding - 0x20).

If there was not the overflow of the channel (n+1) accumulator in the current PWM period, the channel (n+1) match edge is not modified, that is, it happens on channel (n+1) match. However, if there was the overflow of the channel (n+1) accumulator, the channel (n+1) match edge happens when (FTM counter = C(n+1)V + 0x0001).

The following figure shows an example of the channel (n+1) match edge dithering when the channels (n) and (n+1) are in Combine mode.

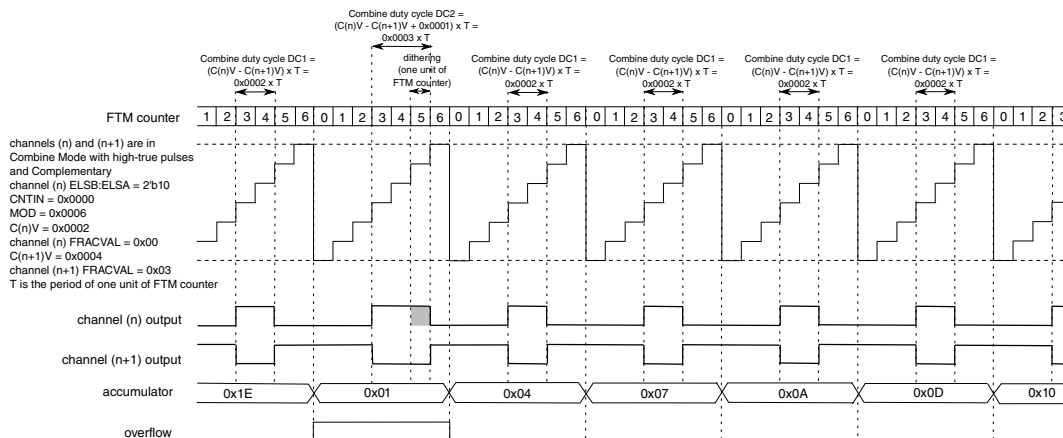

Figure 47-124. Channel (n+1) Match Edge Dithering in Combine Mode

NOTE

It is recommended to use only one PWM Edge Dithering (channel (n) PWM Edge Dithering or channel (n+1) PWM Edge Dithering) at a time.

For the generation of 0% PWM in the channel (n) (with channel (n) ELSB:ELSA = 2'b10) using Combine mode and PWM Edge Dithering, it is recommended to use:

- (C(n)V < CNTIN or C(n)V > MOD) and (channel (n) FRACVAL is zero) and
- (channel (n+1) FRACVAL is zero).

For the generation of 100% PWM in the channel (n) (with channel (n) ELSB:ELSA = 2'b10) using Combine mode and PWM Edge Dithering, it is recommended to use:

- (C(n)V = CNTIN) and (channel (n) FRACVAL is zero) and
- (C(n+1)V < CNTIN or C(n+1)V > MOD) and (channel (n+1) FRACVAL is zero).

47.5.34.2.4 Modified Combine PWM Mode

In the Modified Combine PWM mode, the PWM edge dithering can be done:

- in the channel (n) match (FTM counter = C(n)V) edge or
- in the channel (n+1) match (FTM counter = C(n+1)V) edge.

The channel (n) match edge dithering is enabled when a non-zero value is written to the channel (n) FRACVAL.

For the channel (n) match edge dithering, the channel (n) has an internal 5-bit accumulator. At the end of each PWM period, the channel (n) FRACVAL value is added to the channel (n) accumulator. When this accumulator overflows (that is, the result of the adding is greater or equal than 0x20), the accumulator remains with the rest of the subtraction: (the result of this adding - 0x20).

If there was not the overflow of the channel (n) accumulator in the current PWM period, the channel (n) match edge is not modified, that is, it happens on channel (n) match. However, if there was the overflow of the channel (n) accumulator, the channel (n) match edge happens when (FTM counter = C(n)V + 0x0001).

The following figure shows an example of the channel (n) match edge dithering when the channels (n) and (n+1) are in Modified Combine PWM mode.

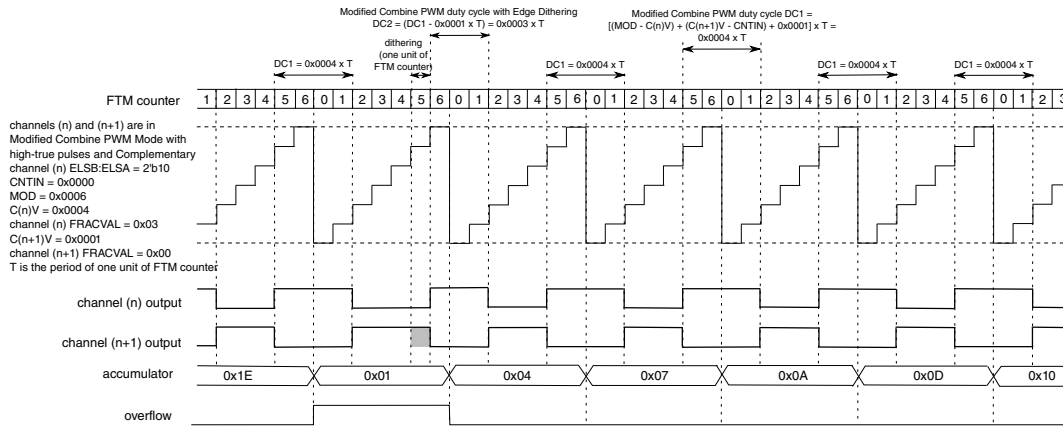

Figure 47-125. Channel (n) Match Edge Dithering in Modified Combine PWM Mode

The channel (n+1) match edge dithering is enabled when a non-zero value is written to the channel (n+1) FRACVAL.

For the channel (n+1) match edge dithering, the channel (n+1) has an internal 5-bit accumulator. At the end of each PWM period, the channel (n+1) FRACVAL value is added to the channel (n+1) accumulator. When this accumulator overflows (that is, the result of the adding is greater or equal than 0x20), the accumulator remains with the rest of the subtraction: (the result of this adding - 0x20).

If there was not the overflow of the channel (n+1) accumulator in the current PWM period, the channel (n+1) match edge is not modified, that is, it happens on channel (n+1) match. However, if there was the overflow of the channel (n+1) accumulator, the channel (n+1) match edge happens when (FTM counter = $C(n+1)V + 0x0001$).

The following figure shows an example of the channel (n+1) match edge dithering when the channels (n) and (n+1) are in Modified Combine PWM mode.

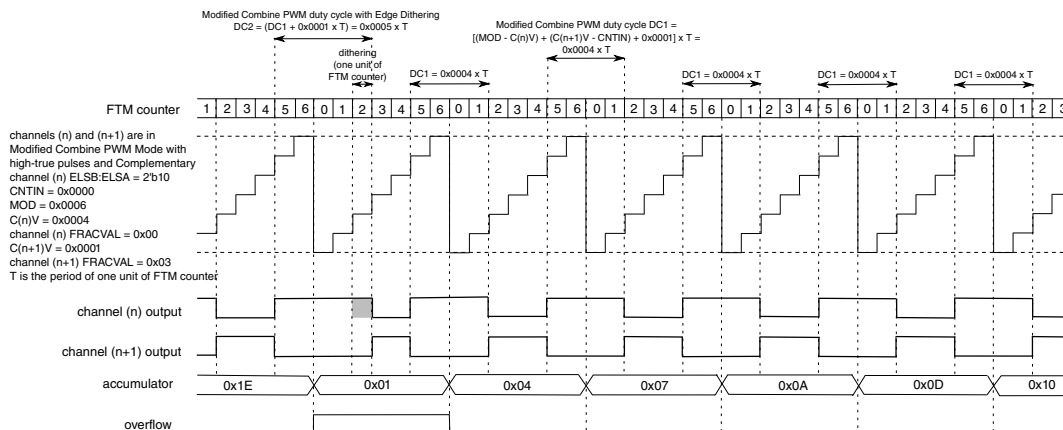

Figure 47-126. Channel (n+1) Match Edge Dithering in Modified Combine PWM Mode

NOTE

It is recommended to use only one PWM Edge Dithering (channel (n) PWM Edge Dithering or channel (n+1) PWM Edge Dithering) at a time.

For the generation of 0% PWM in the channel (n) (with channel (n) ELSB:ELSA = 2'b10) using Modified Combine PWM mode and PWM Edge Dithering, it is recommended to use:

- (C(n)V < CNTIN or C(n)V > MOD) and (channel (n) FRACVAL is zero) and
- (CNTIN ≤ C(n+1)V ≤ MOD) and (channel (n+1) FRACVAL is zero).

For the generation of 100% PWM in the channel (n) (with channel (n) ELSB:ELSA = 2'b10) using Modified Combine PWM mode and PWM Edge Dithering, it is recommended to use:

- (CNTIN ≤ C(n)V ≤ MOD) and (channel (n) FRACVAL is zero) and
- (C(n+1)V < CNTIN or C(n+1)V > MOD) and (channel (n+1) FRACVAL is zero).

47.6 Reset Overview

The FTM is reset whenever any chip reset occurs.

When the FTM exits from reset:

- the FTM counter and the prescaler counter are zero and are stopped (CLKS[1:0] = 2'b00);
- the timer overflow interrupt is zero ([Timer Overflow Interrupt](#));
- the channels interrupts are zero ([Channel \(n\) Interrupt](#));
- the fault interrupt is zero ([Fault Interrupt](#));
- the channels are in input capture mode ([Input Capture Mode](#));
- the channels outputs are zero;
- the channels ELSB:ELSA = 0:0 ([Channel Modes](#)) and PWMEN = 0 ([External Control of Channels Output](#)).

The following figure shows the FTM behavior after the reset. At the reset (item 1), the FTM counter is disabled (CLKS[1:0] = 2'b00), its value is updated to zero and the pins are not controlled by FTM ([Channel Modes](#)).

Reset Overview

After the reset, the FTM should be configured (item 2). It is necessary to define the FTM counter mode, the FTM counting limits (MOD and CNTIN registers value), the channels mode and CnV registers value according to the channels mode.

Thus, it is recommended to write any value to CNT register (item 3). This write updates the FTM counter with the CNTIN register value and the channels output with its initial value (except for channels in output compare mode) ([Counter reset](#)).

The next step is to select the FTM counter clock by the CLKS[1:0] bits (item 4). It is important to highlight that the pins are only controlled by FTM when CLKS[1:0] bits are different from zero.

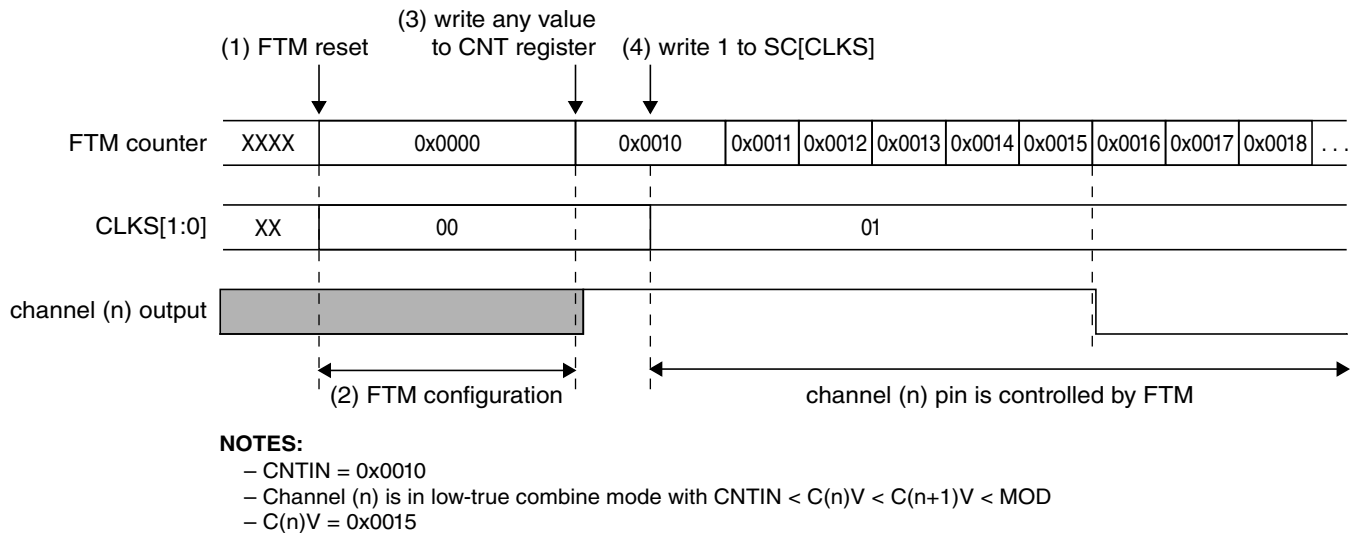

Figure 47-127. FTM behavior after reset when the channel (n) is in Combine mode

The following figure shows an example when the channel (n) is in Output Compare mode and the channel (n) output is toggled when there is a match. In the Output Compare mode, the channel output is not updated to its initial value when there is a write to CNT register (item 3). In this case, use the software output control ([Software Output Control Mode](#)) or the initialization ([Initialization](#)) to update the channel output to the selected value (item 4).

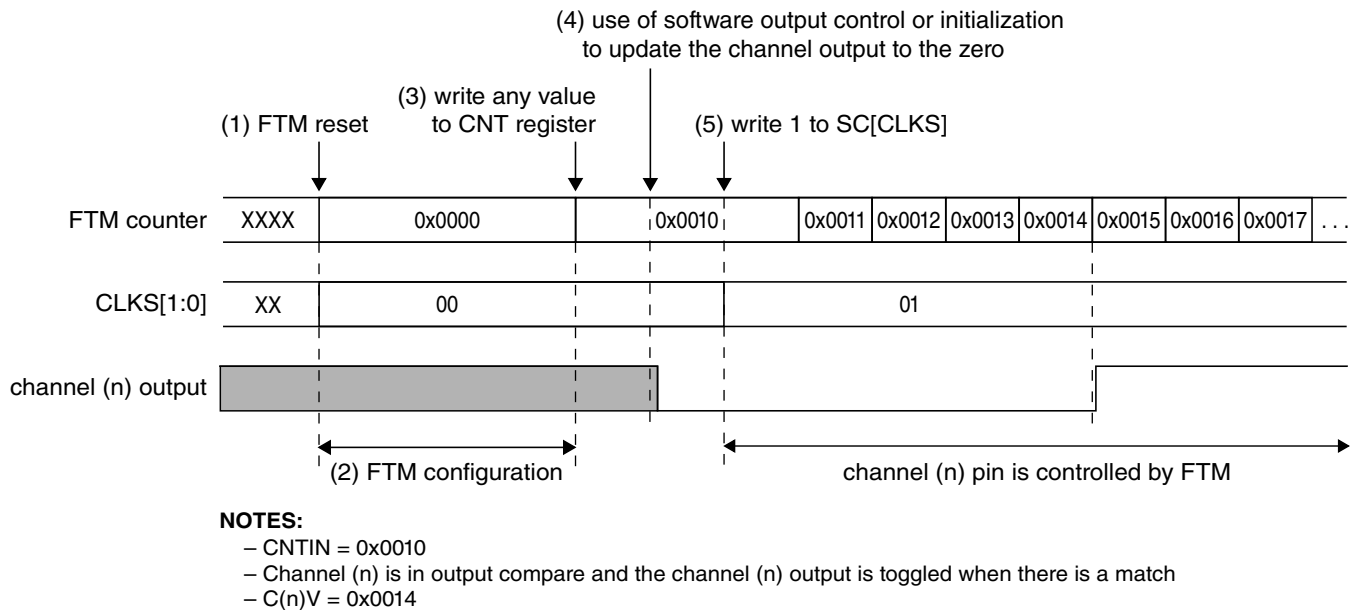

Figure 47-128. FTM behavior after reset when the channel (n) is in Output Compare mode

47.7 FTM Interrupts

47.7.1 Timer Overflow Interrupt

The timer overflow interrupt is generated when (TOIE = 1) and (TOF = 1).

47.7.2 Reload Point Interrupt

The Reload Point interrupt is generated when (RIE = 1) and (RF = 1).

47.7.3 Channel (n) Interrupt

The channel (n) interrupt is generated when (CHIE = 1) and (CHF = 1).

47.7.4 Fault Interrupt

The fault interrupt is generated when (FAULTIE = 1) and (FAULTF = 1).

47.8 Initialization Procedure

The following initialization procedure is recommended to configure the FlexTimer. This procedure can also be used to do a new configuration.

1. Define the POL bits.
2. Mask the channels outputs using $\text{SYNCHOM} = 0$. Two clocks after the write to OUTMASK , the channels outputs are in the safe value.
3. (Re)Configuration FTM counter and channels to generation of periodic signals:
 - a. Disable the clock. Disable the Quadrature Decoder mode.
 - b. Examples of (re)configuration:
 - Write to MOD
 - Write to CNTIN
 - Configure the channels that will be used
 - Write to CnV for the channels in output modes
 - (Re)Configure deadtime and fault control
 - Do not use the SWOC without SW synchronization (see item 6)
 - Do not use the Inverting without SW synchronization (see item 6)
 - Do not use the Initialization
 - Do not change the polarity control
 - Do not configure the HW synchronization
4. Write any value to CNT . The FTM Counter is reset and the channels outputs are updated according to new configuration.
5. Enable the clock. Write to $\text{CLKS}[1:0]$ bits a value different from zero. Enable the Quadrature Decoder mode (if it is desired).
6. Configure the SW synchronization for SWOC (if it is necessary), Inverting (if it is necessary) and Output Mask (always)
 - a. Select synchronization for Output Mask
 - Write to SYNC ($\text{SWSYNC} = 0$, $\text{TRIG2} = 0$, $\text{TRIG1} = 0$, $\text{TRIG0} = 0$, $\text{SYNCHOM} = 1$, $\text{REINIT} = 0$, $\text{CNTMAX} = 0$, $\text{CNTMIN} = 0$)
 - b. Write to SYNCONF
 - HW Synchronization can not be enabled ($\text{HWSOC} = 0$, $\text{HWINVC} = 0$, $\text{HWOM} = 0$, $\text{HWWRBUF} = 0$, $\text{HWRSTCNT} = 0$, $\text{HWTRIGMODE} = 0$)
 - SW Synchronization for SWOC (if it is necessary): $\text{SWSOC} = [0/1]$ and $\text{SWOC} = [0/1]$
 - SW Synchronization for Inverting (if it is necessary): $\text{SWINVC} = [0/1]$ and $\text{INVC} = [0/1]$
 - SW Synchronization for SWOM (always): $\text{SWOM} = 1$

- No enable the SW Synchronization for write buffers (because the writes to registers with write buffer are done using $CLKS[1:0] = 2'b00$): $SWWRBUF = 0$ and $CNTINC = 0$
 - SW Synchronization for counter reset (always): $SWRSTCNT = 1$
 - Enhanced synchronization (always): $SYNCMODE = 1$
- c. If the SWOC is used ($SWSOC = 1$ and $SWOC = 1$), then write to $SWOCTRL$ register.
 - d. If the Inverting is used ($SWINVC = 1$ and $INVC = 1$), then write to $INVCTRL$ register.
 - e. Write to $OUTMASK$ to enable the masked channels.
7. Generate the Software Trigger
 - Write to $SYNC$ ($SWSYNC = 1$, $TRIG2 = 0$, $TRIG1 = 0$, $TRIG0 = 0$, $SYNCHOM = 1$, $REINIT = 0$, $CNTMAX = 0$, $CNTMIN = 0$)
 8. Configure $PWMEN$ bits ([External Control of Channels Output](#)).

Chapter 48

Low Power Interrupt Timer (LPIT)

48.1 Chip-specific LPIT information

48.1.1 Instantiation Information

S32K1xx contains one LPIT module with four channels. Low leakage mode and Wait mode is not supported in this device. See [Module operation in available power modes](#) for details on available power modes.

Accessing LPIT when its functional clock is disabled may give transfer error.

48.1.2 LPIT/DMA Periodic Trigger Assignments

The LPIT generates periodic trigger events to the DMAMUX as shown in the table below.

Table 48-1. LPIT channel assignments for periodic DMA triggering

DMA Channel Number	LPIT Channel
0	0
1	1
2	2
3	3

48.1.3 LPIT input triggers

LPIT is designed to capture small pulses at its input trigger irrespective of its clock frequency as mentioned in S32K14x_Trigger_Muxing.xlsx attached to the Reference manual. But for reliable back to back operation these triggers should be spaced apart by at least 10 LPIT bus clock cycles.

48.1.4 LPIT/ADC Trigger

The LPIT could be used as an alternate ADC hardware trigger source, the implementation is through TRGMUX. Each LPIT channel supports one pre-trigger and one trigger. The LPIT channels are implemented based on independent counters. When used as ADC trigger source, the channel outputs generate the ADC hardware triggers and pre-triggers. The following diagram shows an example of using LPIT triggering ADC0.

The LPIT triggers can also have multiple sources. Refer to [ADC Trigger Sources](#).

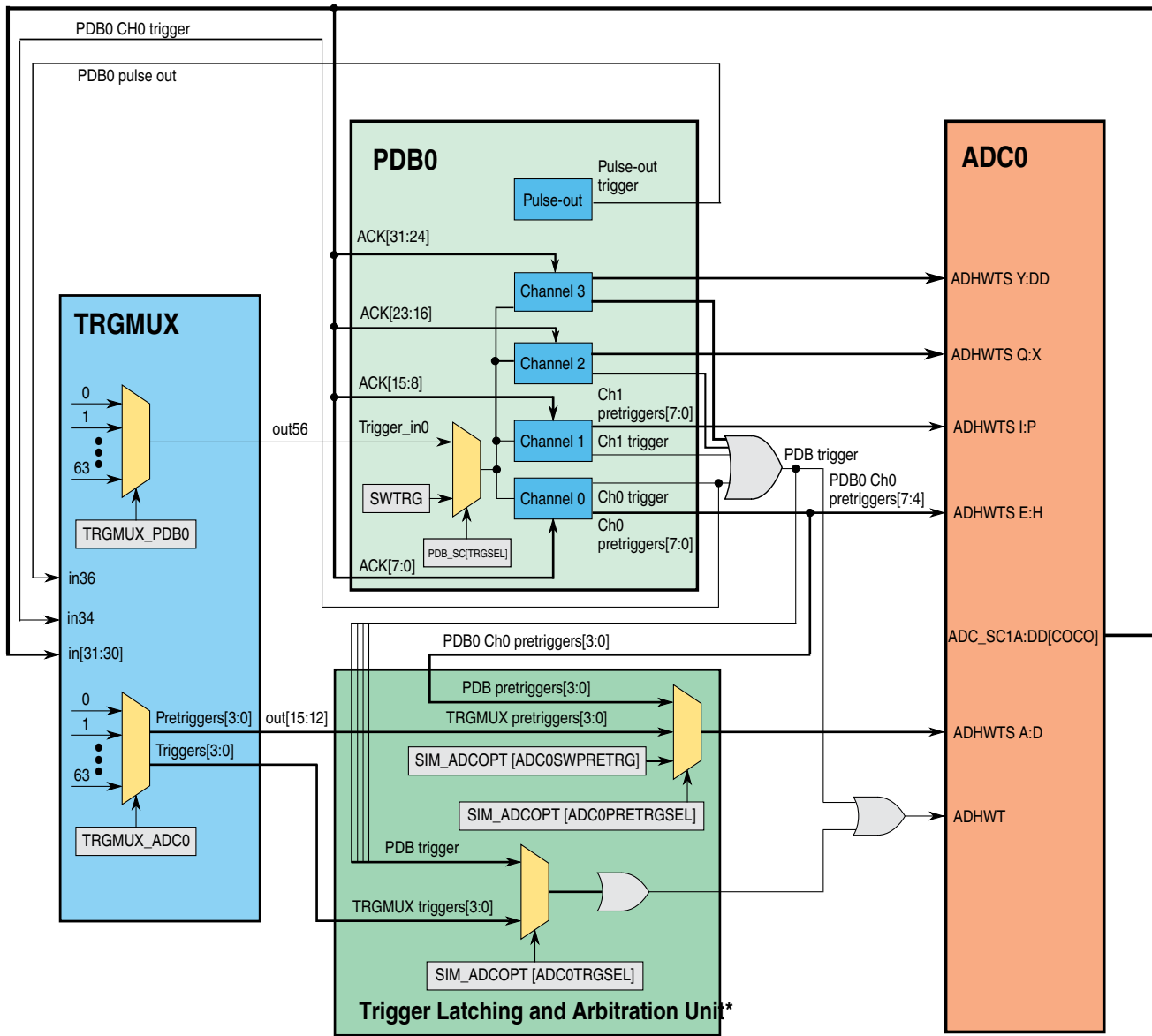

* The block depicts simplified schematic and doesn't show detailed latching. See section 'Trigger Latching and Arbitration' of ADC chapter for details

Figure 48-1. ADC triggering scheme

48.1.5 Current timer value

Following table describes the Current Timer Value register reads across devices.

Table 48-2. Current Timer Value register reads

S32K1xx devices	S32K14xW devices
While the timer is running, CVALn register reads may not return the real value. If the timer value needs to be read, read it during an LPIT interrupt service routine.	CVALn register reads return the real value even if timer is running

48.1.6 S32K11X to S32K14X difference

See [Differences between S32K14x/S32K14xW, and S32K11x](#), for differences arising out of CPU and interrupt latency impacting timed events when comparing S32K14X and S32K11X variants.

48.2 Introduction

48.2.1 Overview

LPIT is a low power periodic interrupt timer with multiple timer channels. After a timer reaches a programmed count, the respective timer channel will generate pre-trigger and trigger output signals, and these pre-trigger and trigger outputs can be used to trigger other modules on the device.

- Timers can be configured to be controlled using:
 - external triggers (triggers from outside the LPIT module)
 - or internal triggers (triggers from other timer channels inside the LPIT module).
- The timer channels can be chained together, to form a larger width timer.
- Depending on the timer modes, the timer channels may reload and count again, or stop after reaching the programmed count.

The next figure shows the interface of an LPIT module to the other modules on the SoC.

- The CPU interface provides the clock, reset, register read/write bus interface and handles interrupts from an LPIT.
- The trigger output signals from an LPIT may trigger other modules on the SoC, like the DMA, ADC, and other modules.
- Similarly, other timer modules may provide trigger inputs to an LPIT module, to control when an LPIT timer channel starts.

For the exact module interactions, see the SoC Configuration chapter in your device's hardware Reference Manual (RM).

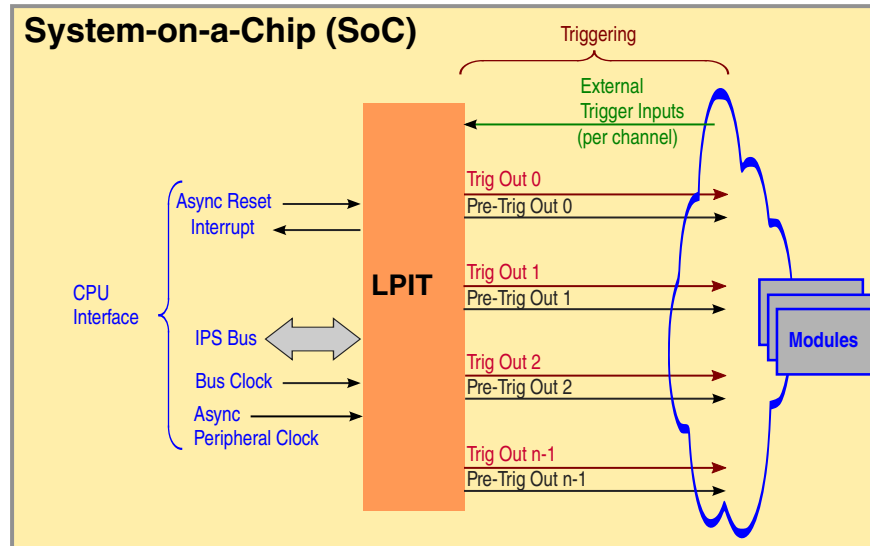

Figure 48-2. LPIT Interface in SoC

Each timer channel in LPIT can be configured to work in either compare modes or capture modes.

- **In compare mode:** the timers decrement when enabled and generate an output pre-trigger and trigger output. The trigger output is 1 clock cycle delayed of the pre-trigger pulse. Each timer channel start, reload and restart can be controlled via control bits. The timer can be configured to always decrement from a programmed start value, or decrement on selected trigger inputs or previous channel timeout (when channels are chained). By chaining timer channels, applications can achieve larger timeout durations.
- **In capture mode:** the timer can be used to perform measurements as the timer value is captured (in the timer value register) when a selected trigger input is asserted. The timer can support once-off or multiple measurements (like frequency measurements).

The timer channels operate on an asynchronous clock, which is independent from the register read/write access clock. Clock synchronization between the clock domains ensures normal operations.

48.2.2 Block Diagram

The next figure shows a detailed block diagram for an LPIT module. The programming model comprises of a global register set (common to all timer channels), and registers for each timer channel (that control their respective timer channels). Access to these registers gets synchronized to the asynchronous peripheral clock, then affects the timer channel registers.

Modes of operation

- Each timer channel contains a 32-bit counter that loads the starting value and down counts on every peripheral clock's positive edge.
- After reaching a zero value (a channel timer timeout), a trigger output is generated.
- The counter enable is controlled using a timer enable register control bit, external or internal triggers or via previous channel timeout (when using timer chaining).
- After a channel timer timeout, an interrupt bit is also set, to tell the CPU about the timer timeout.

For more details, see the functional description section.

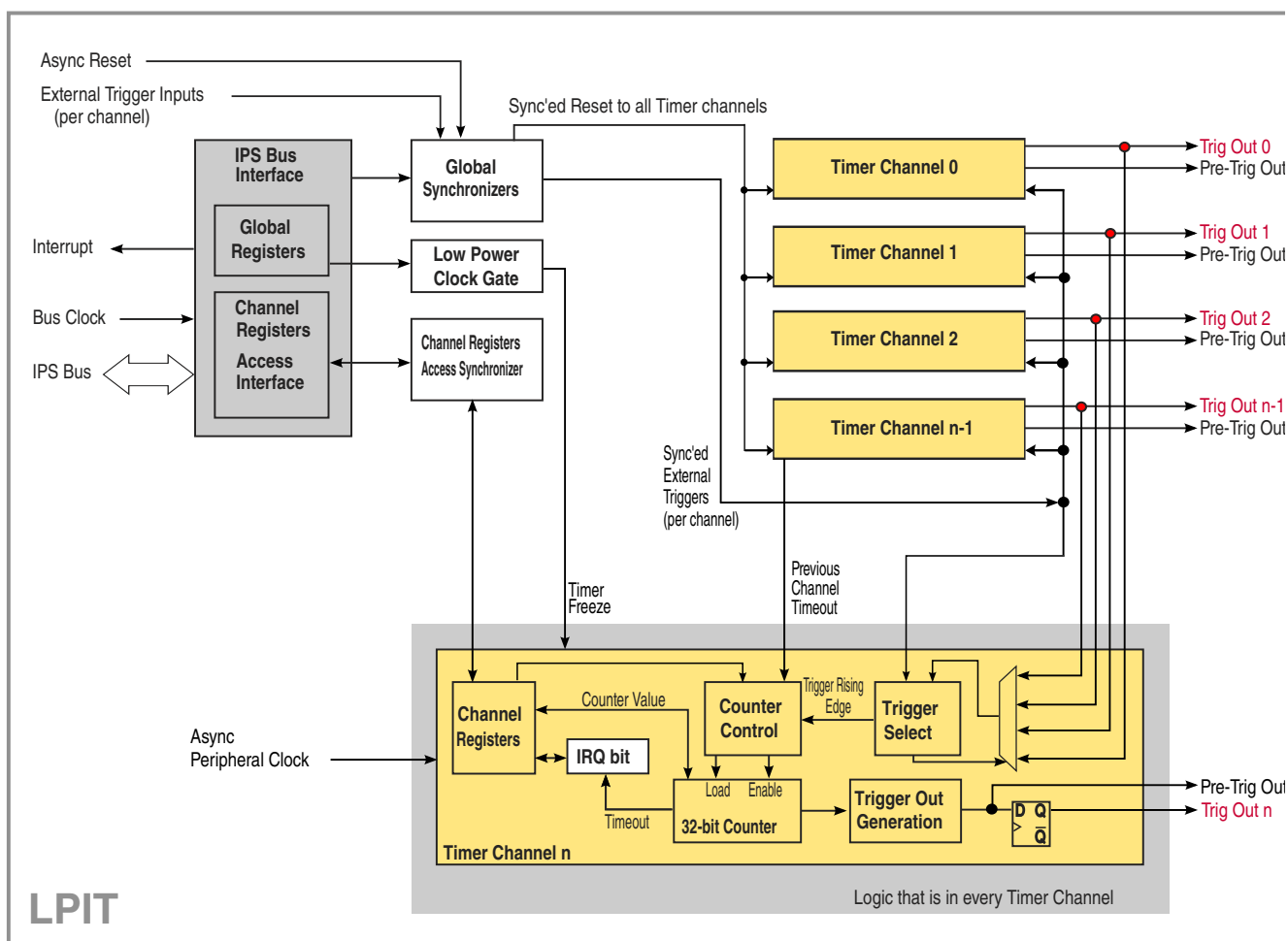

Figure 48-3. Detailed Block Diagram

48.3 Modes of operation

The LPIT module supports the following chip modes.

Table 48-3. Chip modes supported by the LPIT module

Chip mode	LPIT Operation
Run	Normal operation
Stop	Can continue operating, if the Doze Enable bit (MCR[DOZE_EN]) is set and the LPIT is using an external or internal clock source that remains operating during stop mode.
Debug	Can continue operating provided the Debug Enable bit (MCR[DBG_EN]) is set.

48.4 Memory Map and Registers

48.4.1 LPIT register descriptions

The memory map comprises of 32-bit aligned registers, which can be accessed via 8-bit, 16-bit, or 32-bit accesses.

- Write access to reserved locations will generate a transfer error.
- Read access to reserved locations will also generate a transfer error, and the read data bus will show all 0s.

NOTE

- The Memory Map and complete module is in Big Endian format.
- The LPIT module will not check if programmed values in the registers are correct; software must ensure that correct programmed values are being written.

48.4.1.1 LPIT memory map

LPIT base address: 4003_7000h

Offset	Register	Width (In bits)	Access	Reset value
0h	Version ID Register (VERID)	32	RO	0100_0000h
4h	Parameter Register (PARAM)	32	RO	0000_0404h
8h	Module Control Register (MCR)	32	RW	0000_0000h
Ch	Module Status Register (MSR)	32	W1C	0000_0000h
10h	Module Interrupt Enable Register (MIER)	32	RW	0000_0000h
14h	Set Timer Enable Register (SETTEN)	32	RW	0000_0000h

Table continues on the next page...

Memory Map and Registers

Offset	Register	Width (In bits)	Access	Reset value
18h	Clear Timer Enable Register (CLRTEN)	32	WORZ	0000_0000h
20h	Timer Value Register (TVAL0)	32	RW	0000_0000h
24h	Current Timer Value (CVAL0)	32	RO	FFFF_FFFFh
28h	Timer Control Register (TCTRL0)	32	RW	0000_0000h
30h	Timer Value Register (TVAL1)	32	RW	0000_0000h
34h	Current Timer Value (CVAL1)	32	RO	FFFF_FFFFh
38h	Timer Control Register (TCTRL1)	32	RW	0000_0000h
40h	Timer Value Register (TVAL2)	32	RW	0000_0000h
44h	Current Timer Value (CVAL2)	32	RO	FFFF_FFFFh
48h	Timer Control Register (TCTRL2)	32	RW	0000_0000h
50h	Timer Value Register (TVAL3)	32	RW	0000_0000h
54h	Current Timer Value (CVAL3)	32	RO	FFFF_FFFFh
58h	Timer Control Register (TCTRL3)	32	RW	0000_0000h

48.4.1.2 Version ID Register (VERID)

48.4.1.2.1 Offset

Register	Offset
VERID	0h

48.4.1.2.2 Diagram

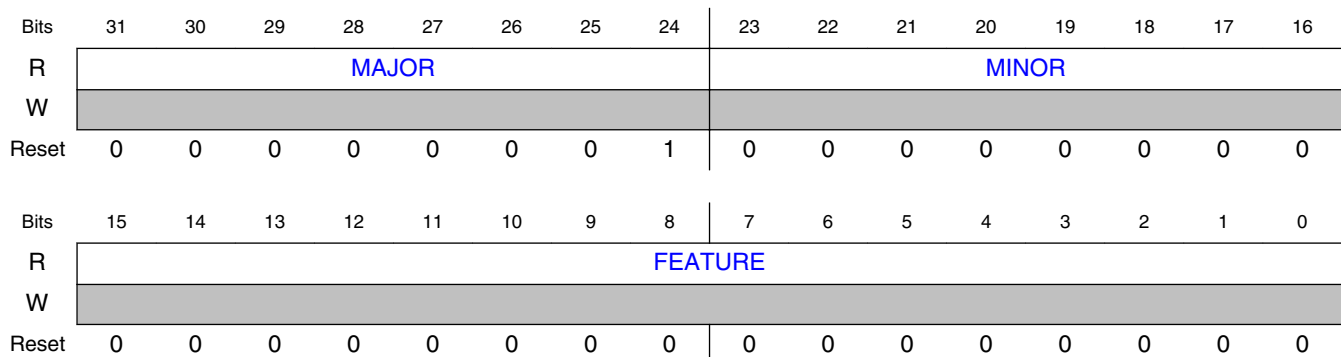

48.4.1.2.3 Fields

Field	Function
31-24 MAJOR	Major Version Number Returns the major version number for the module design specification. Read-only field.
23-16 MINOR	Minor Version Number Returns the minor version number for the module design specification. Read-only field.
15-0 FEATURE	Feature Number Returns the feature set number. Read-only field.

48.4.1.3 Parameter Register (PARAM)

48.4.1.3.1 Offset

Register	Offset
PARAM	4h

48.4.1.3.2 Function

Provides details on the parameter settings that were used while incorporating this module into the device.

48.4.1.3.3 Diagram

Bits	31	30	29	28	27	26	25	24	23	22	21	20	19	18	17	16
R	0															
W																
Reset	0	0	0	0	0	0	0	0	0	0	0	0	0	0	0	0
Bits	15	14	13	12	11	10	9	8	7	6	5	4	3	2	1	0
R	EXT_TRIG								CHANNEL							
W																
Reset	0	0	0	0	0	1	0	0	0	0	0	0	0	1	0	0

48.4.1.3.4 Fields

Field	Function
31-16 —	This read-only field is reserved and always has the value 0
15-8 EXT_TRIG	Number of External Trigger Inputs Number of external triggers implemented in this device
7-0 CHANNEL	Number of Timer Channels Number of timer channels implemented in this device

48.4.1.4 Module Control Register (MCR)

48.4.1.4.1 Offset

Register	Offset
MCR	8h

48.4.1.4.2 Diagram

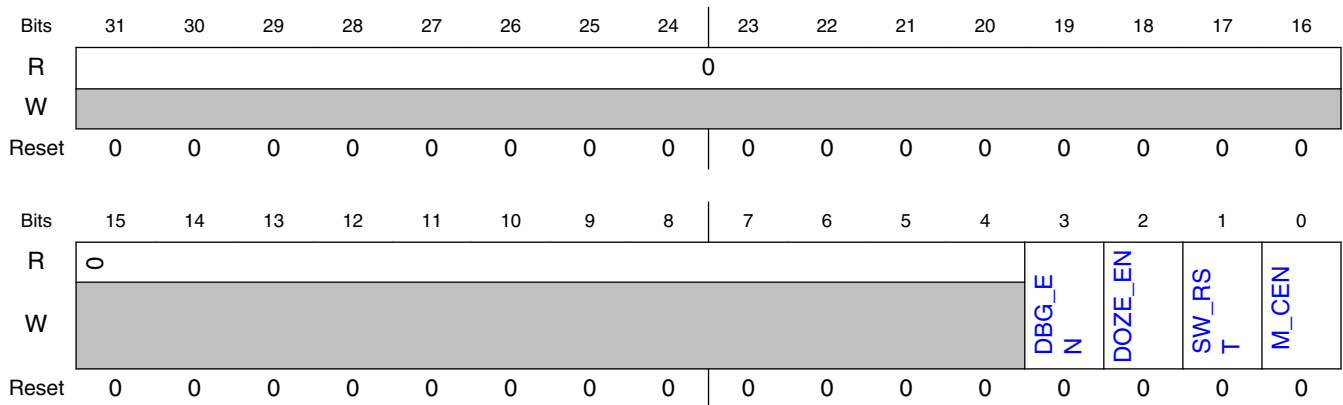

48.4.1.4.3 Fields

Field	Function
31-4 —	This read-only field is reserved and always has the value 0
3	Debug Enable Bit

Table continues on the next page...

Field	Function
DBG_EN	Stops the timer channels when the device enters Debug mode 0b - Stop timer channels in Debug mode 1b - Allow timer channels to continue to run in Debug mode
2 DOZE_EN	DOZE Mode Enable Bit Stops the timer channels when the device enters DOZE mode 0b - Stop timer channels in DOZE mode 1b - Allow timer channels to continue to run in DOZE mode
1 SW_RST	Software Reset Bit Resets all channels and registers, except the Module Control Register. The Software Reset bit remains set until cleared by software. NOTE: Before clearing the Software Reset bit, software must wait for 4 peripheral clocks (for clock synchronization and reset propagation). 0b - Timer channels and registers are not reset 1b - Reset timer channels and registers
0 M_CEN	Module Clock Enable Enables the peripheral clock to the module timers. <ul style="list-style-type: none"> The Module Clock Enable bit must be asserted when accessing these registers: <ul style="list-style-type: none"> Module Status Register (MSR) Set Timer Enable Register (SETTEN) Clear Timer Enable Register (CLRTEEN) Timer Value Registers (TVAL_n) Current Timer Value Registers (CVAL_n) Timer Control Registers (TCTRL_n) Both the bus clock and peripheral clock must be enabled to allow for clock synchronization and updating the above registers. Accessing the above mentioned registers while the Module Clock Enable bit (M_CEN) = '0', will assert a transfer error for that bus cycle. Writing to Current Timer Value (CVAL_n) registers and Reserved registers will always generate a transfer error. NOTE: There may be additional clock gating bits in your device that gate the peripheral clock to the LPIT module. Ensure that those additional clock gating bits are configured appropriately, to enable the peripheral clock to the LPIT module. 0b - Disable peripheral clock to timers 1b - Enable peripheral clock to timers

48.4.1.5 Module Status Register (MSR)

48.4.1.5.1 Offset

Register	Offset
MSR	Ch

48.4.1.5.2 Function

NOTE

Unless the Module Clock Enable bit (MCR[M_CEN]) is set (=1, peripheral clock to timers is enabled), reading or writing the Module Status register will generate a transfer error.

48.4.1.5.3 Diagram

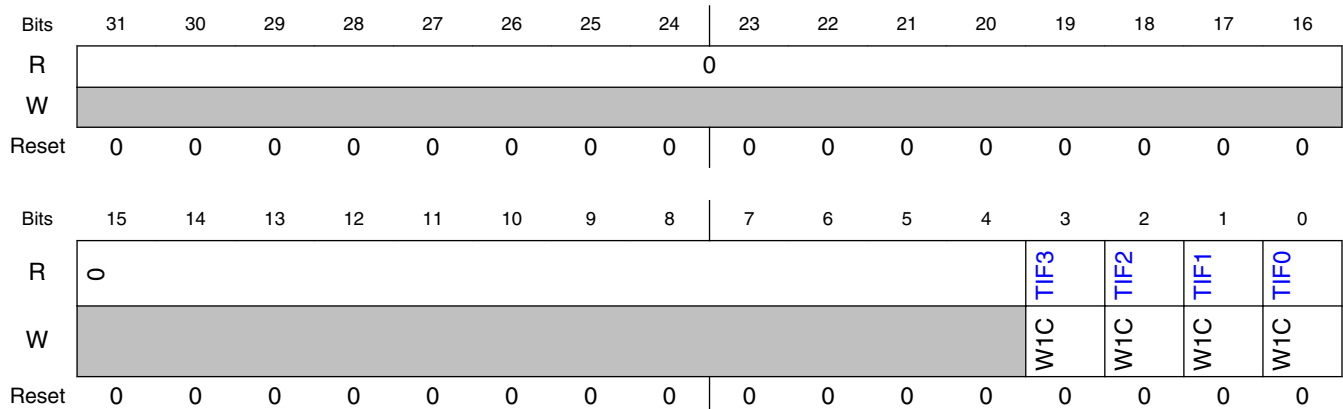

48.4.1.5.4 Fields

Field	Function
31-4 —	This read-only field is reserved and always has the value 0
3 TIF3	<p>Channel 3 Timer Interrupt Flag</p> <ul style="list-style-type: none"> In compare modes: at the end of the timer period, the channel timer interrupt flag is set to 1 In capture modes: when the trigger asserts, the channel timer interrupt flag is set to 1 To clear a channel timer interrupt flag, write logic 1 to it Writing 0 to a channel timer interrupt flag has no effect <p>0b - Timer has not timed out 1b - Timeout has occurred (timer has timed out)</p>
2 TIF2	<p>Channel 2 Timer Interrupt Flag</p> <ul style="list-style-type: none"> In compare modes: at the end of the timer period, the channel timer interrupt flag is set to 1 In capture modes: when the trigger asserts, the channel timer interrupt flag is set to 1 To clear a channel timer interrupt flag, write logic 1 to it Writing 0 to a channel timer interrupt flag has no effect <p>0b - Timer has not timed out 1b - Timeout has occurred (timer has timed out)</p>
1 TIF1	<p>Channel 1 Timer Interrupt Flag</p> <ul style="list-style-type: none"> In compare modes: at the end of the timer period, the channel timer interrupt flag is set to 1 In capture modes: when the trigger asserts, the channel timer interrupt flag is set to 1

Table continues on the next page...

Field	Function
	<ul style="list-style-type: none"> To clear a channel timer interrupt flag, write logic 1 to it Writing 0 to a channel timer interrupt flag has no effect <p>0b - Timer has not timed out 1b - Timeout has occurred (timer has timed out)</p>
0 TIF0	<p>Channel 0 Timer Interrupt Flag</p> <ul style="list-style-type: none"> In compare modes: at the end of the timer period, the channel timer interrupt flag is set to 1 In capture modes: when the trigger asserts, the channel timer interrupt flag is set to 1 To clear a channel timer interrupt flag, write logic 1 to it Writing 0 to a channel timer interrupt flag has no effect <p>0b - Timer has not timed out 1b - Timeout has occurred (timer has timed out)</p>

48.4.1.6 Module Interrupt Enable Register (MIER)

48.4.1.6.1 Offset

Register	Offset
MIER	10h

48.4.1.6.2 Diagram

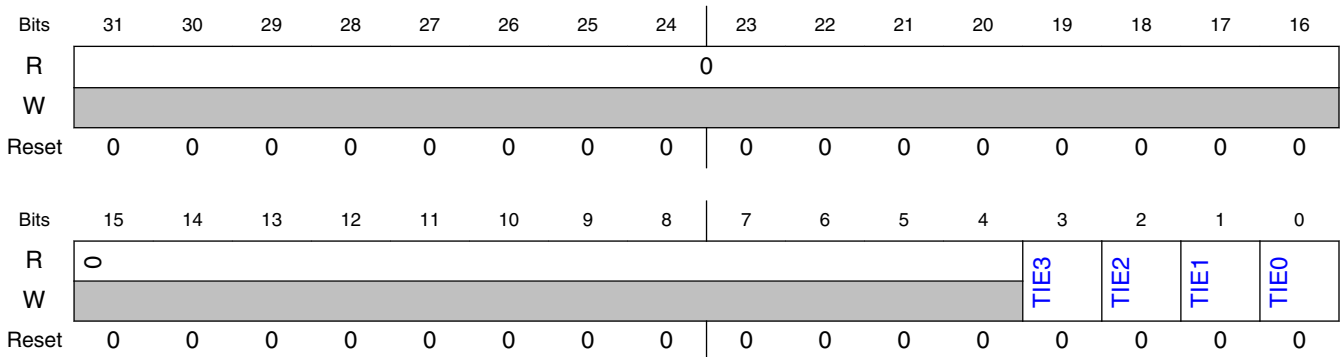

48.4.1.6.3 Fields

Field	Function
31-4	This read-only field is reserved and always has the value 0
—	

Table continues on the next page...

Field	Function
3 TIE3	Channel 3 Timer Interrupt Enable Enables interrupt generation when: <ul style="list-style-type: none"> the Channel 3 Timer Interrupt Enable bit (TIE3) is set to 1 and if the corresponding Timer Interrupt Flag (MSR[TIF3]) is asserted (=1, timeout has occurred) 0b - Disabled 1b - Enabled
2 TIE2	Channel 2 Timer Interrupt Enable Enables interrupt generation when: <ul style="list-style-type: none"> the Channel 2 Timer Interrupt Enable bit (TIE2) is set to 1 and if the corresponding Timer Interrupt Flag (MSR[TIF2]) is asserted (=1, timeout has occurred) 0b - Disabled 1b - Enabled
1 TIE1	Channel 1 Timer Interrupt Enable Enables interrupt generation when: <ul style="list-style-type: none"> the Channel 1 Timer Interrupt Enable bit (TIE1) is set to 1 and if the corresponding Timer Interrupt Flag (MSR[TIF1]) is asserted (=1, timeout has occurred) 0b - Disabled 1b - Enabled
0 TIE0	Channel 0 Timer Interrupt Enable Enables interrupt generation when: <ul style="list-style-type: none"> the Channel 0 Timer Interrupt Enable bit (TIE0) is set to 1 and if the corresponding Timer Interrupt Flag (MSR[TIF0]) is asserted (=1, timeout has occurred) 0b - Disabled 1b - Enabled

48.4.1.7 Set Timer Enable Register (SETTEN)

48.4.1.7.1 Offset

Register	Offset
SETTEN	14h

48.4.1.7.2 Function

The Set Timer Enable register allows the simultaneous enabling of timer channels.

- Timer channels can be enabled by
 - either by writing '1' to Timer Enable bit (T_EN) in the respective TCTRL_n register,
 - or by setting the corresponding Set Timer Enable bit (SET_T_EN_n) in the Set Timer Enable register (SETTEN).

- To disable timer channels simultaneously, use the Clear Timer Enable register (CLR TEN).
- Writing a '0' to the Set Timer Enable register has no effect.

NOTE

Unless the Module Clock Enable bit (MCR[M_CEN]) is set (=1, peripheral clock to timers is enabled), reading or writing the Set Timer Enable register will generate a transfer error.

48.4.1.7.3 Diagram

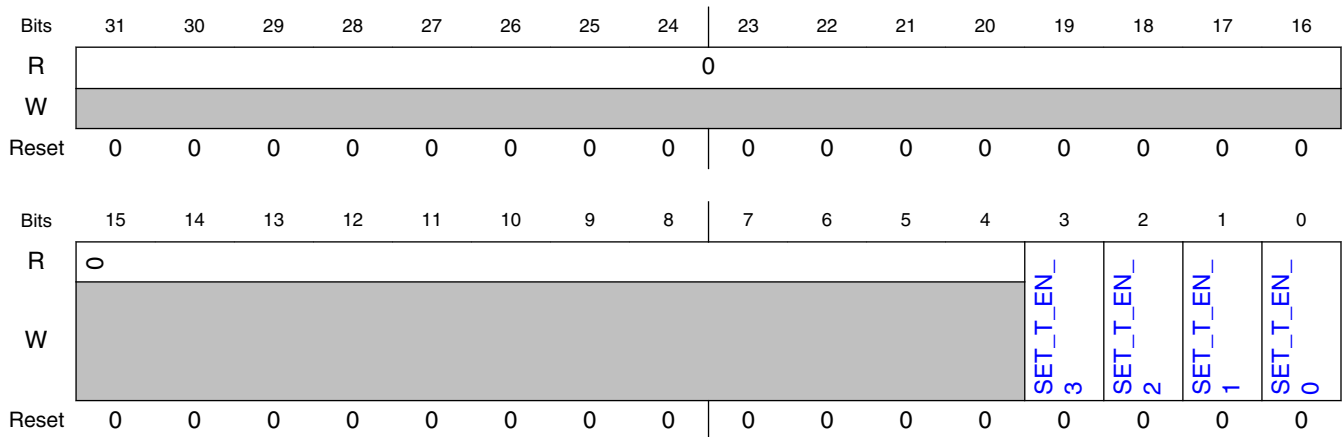

48.4.1.7.4 Fields

Field	Function
31-4 —	This read-only field is reserved and always has the value 0
3 SET_T_EN_3	<p>Set Timer 3 Enable</p> <p>To enable timer channel 3, write '1' to Set Timer 3 Enable bit.</p> <ul style="list-style-type: none"> • The Set Timer 3 Enable bit can be used in addition to the Timer Enable bit (T_EN) in TCTRL3 register. • Writing a 0 to Set Timer 3 Enable bit will not disable the counter. • The Set Timer 3 Enable bit will be cleared <ul style="list-style-type: none"> • when Timer Enable bit (TCTRL3[T_EN]) is set to 0 • or when '1' is written to the Clear Timer 3 Enable bit (CLR TEN[CLR_T_EN_3]). <p>0b - No effect 1b - Enables Timer Channel 3</p>
2 SET_T_EN_2	<p>Set Timer 2 Enable</p> <p>To enable timer channel 2, write '1' to Set Timer 2 Enable bit.</p> <ul style="list-style-type: none"> • The Set Timer 2 Enable bit can be used in addition to the Timer Enable bit (T_EN) in TCTRL2 register.

Table continues on the next page...

Memory Map and Registers

Field	Function
	<ul style="list-style-type: none"> Writing a 0 to Set Timer 2 Enable bit will not disable the counter. The Set Timer 2 Enable bit will be cleared <ul style="list-style-type: none"> when Timer Enable bit (TCTRL2[T_EN]) is set to 0 or when '1' is written to the Clear Timer 2 Enable bit (CLRTEEN[CLR_T_EN_2]). <p>0b - No Effect 1b - Enables Timer Channel 2</p>
1 SET_T_EN_1	<p>Set Timer 1 Enable</p> <p>To enable timer channel 1, write '1' to Set Timer 1 Enable bit.</p> <ul style="list-style-type: none"> The Set Timer 1 Enable bit can be used in addition to the Timer Enable bit (T_EN) in TCTRL1 register. Writing a 0 to Set Timer 1 Enable bit will not disable the counter. The Set Timer 1 Enable bit will be cleared <ul style="list-style-type: none"> when Timer Enable bit (TCTRL1[T_EN]) is set to 0 or when '1' is written to the Clear Timer 1 Enable bit (CLRTEEN[CLR_T_EN_1]). <p>0b - No Effect 1b - Enables Timer Channel 1</p>
0 SET_T_EN_0	<p>Set Timer 0 Enable</p> <p>To enable timer channel 0, write '1' to Set Timer 0 Enable bit.</p> <ul style="list-style-type: none"> The Set Timer 0 Enable bit can be used in addition to the Timer Enable bit (T_EN) in TCTRL0 register. Writing a 0 to Set Timer 0 Enable bit will not disable the counter. The Set Timer 0 Enable bit will be cleared <ul style="list-style-type: none"> when Timer Enable bit (TCTRL0[T_EN]) is set to 0 or when '1' is written to the Clear Timer 0 Enable bit (CLRTEEN[CLR_T_EN_0]). <p>0b - No effect 1b - Enables Timer Channel 0</p>

48.4.1.8 Clear Timer Enable Register (CLRTEEN)

48.4.1.8.1 Offset

Register	Offset
CLRTEEN	18h

48.4.1.8.2 Function

NOTE

Unless the Module Clock Enable bit (MCR[M_CEN]) is set (=1, peripheral clock to timers is enabled), reading or writing the Clear Timer Enable register will generate a transfer error.

48.4.1.8.3 Diagram

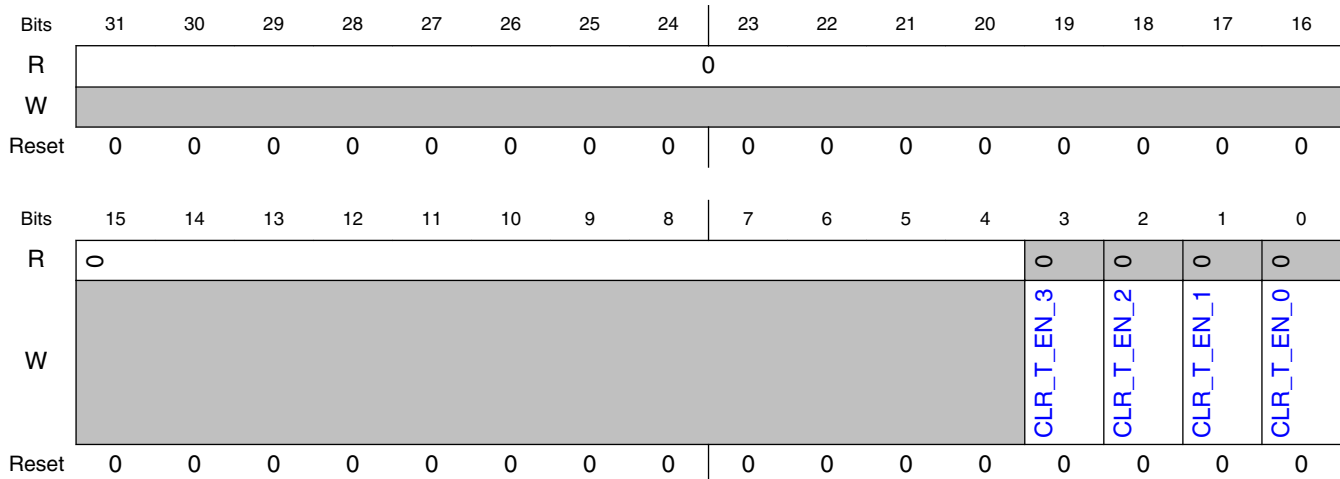

48.4.1.8.4 Fields

Field	Function
31-4 —	This read-only field is reserved and always has the value 0
3 CLR_T_EN_3	<p>Clear Timer 3 Enable</p> <ul style="list-style-type: none"> To disable timer channel 3, write '1' to Clear Timer 3 Enable bit. The Clear Timer 3 Enable bit can be used in addition to Timer Enable bit (T_EN) in TCTRL3 register. Writing a 1 to Clear Timer 3 Enable bit will not enable the counter. The Clear Timer 3 Enable bit is self-clearing, which means that the Clear Timer 3 Enable bit will always read 0. <p>0b - No Action 1b - Clear the Timer Enable bit (TCTRL3[T_EN]) for Timer Channel 3</p>
2 CLR_T_EN_2	<p>Clear Timer 2 Enable</p> <ul style="list-style-type: none"> To disable timer channel 2, write '1' to Clear Timer 2 Enable bit. The Clear Timer 2 Enable bit can be used in addition to Timer Enable bit (T_EN) in TCTRL2 register. Writing a 1 to Clear Timer 2 Enable bit will not enable the counter. The Clear Timer 2 Enable bit is self-clearing, which means that the Clear Timer 2 Enable bit will always read 0. <p>0b - No Action 1b - Clear the Timer Enable bit (TCTRL2[T_EN]) for Timer Channel 2</p>
1 CLR_T_EN_1	<p>Clear Timer 1 Enable</p> <ul style="list-style-type: none"> To disable timer channel 1, write '1' to Clear Timer 1 Enable bit. The Clear Timer 1 Enable bit can be used in addition to Timer Enable bit (T_EN) in TCTRL1 register. Writing a 1 to Clear Timer 1 Enable bit will not enable the counter. The Clear Timer 1 Enable bit is self-clearing, which means that the Clear Timer 1 Enable bit will always read 0.

Table continues on the next page...

Memory Map and Registers

Field	Function
	0b - No Action 1b - Clear the Timer Enable bit (TCTRL1[T_EN]) for Timer Channel 1
0 CLR_T_EN_0	Clear Timer 0 Enable <ul style="list-style-type: none"> To disable timer channel 0, write '1' to Clear Timer 0 Enable bit. The Clear Timer 0 Enable bit can be used in addition to Timer Enable bit (T_EN) in TCTRL0 register. Writing a 1 to Clear Timer 0 Enable bit will not enable the counter. The Clear Timer 0 Enable bit is self-clearing, which means that the Clear Timer 0 Enable bit will always read 0. 0b - No action 1b - Clear the Timer Enable bit (TCTRL0[T_EN]) for Timer Channel 0

48.4.1.9 Timer Value Register (TVAL0 - TVAL3)

48.4.1.9.1 Offset

Register	Offset
TVAL0	20h
TVAL1	30h
TVAL2	40h
TVAL3	50h

48.4.1.9.2 Function

- In compare modes: the Timer Value Registers (TVAL n) select the timeout period for the timer channels.
- In capture modes: the Timer Value Registers (TVAL n) are loaded with the value of the counter when the trigger asserts.

NOTE

Unless the Module Clock Enable bit (MCR[M_CEN]) is set (=1, peripheral clock to timers is enabled), then reading or writing the TVAL n register will generate a transfer error.

48.4.1.9.3 Diagram

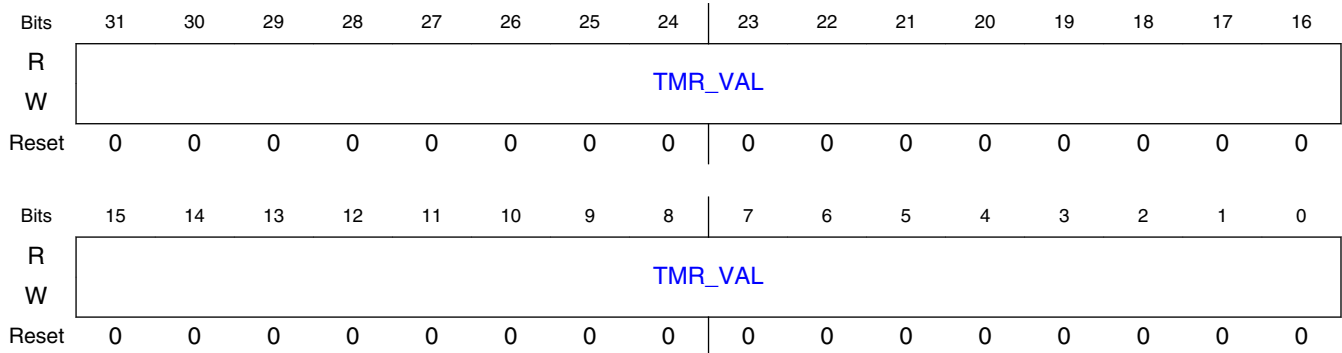

48.4.1.9.4 Fields

Field	Function
31-0 TMR_VAL	<p>Timer Value</p> <ul style="list-style-type: none"> In compare mode: Timer Value (TMR_VAL) is the timer channel start value. <ul style="list-style-type: none"> The timer will count down until the timer reaches 0, then the timer will generate an interrupt and load the Timer Value register (TVAL_n) value again. Writing a new value to the Timer Value register (TVAL_n) will not restart the timer channel; instead the new value will be loaded <i>after the timer expires</i>. To abort the current timer cycle and start a timer period with a new value, the timer channel must be disabled and enabled <i>again</i>. In capture mode: whenever the trigger asserts, the Timer Value register stores the inverse of the counter value. <p>00000000000000000000000000000000b - Invalid load value in compare mode 00000000000000000000000000000001b - Invalid load value in compare mode 00000000000000000000000000000010-11111111111111111111111111111111b - In compare mode: the value to be loaded; in capture mode, the value of the timer</p>

48.4.1.10 Current Timer Value (CVAL0 - CVAL3)

48.4.1.10.1 Offset

Register	Offset
CVAL0	24h
CVAL1	34h
CVAL2	44h
CVAL3	54h

48.4.1.10.2 Function

The Current Timer Value registers indicate the current timer counter value.

48.4.1.10.3 Diagram

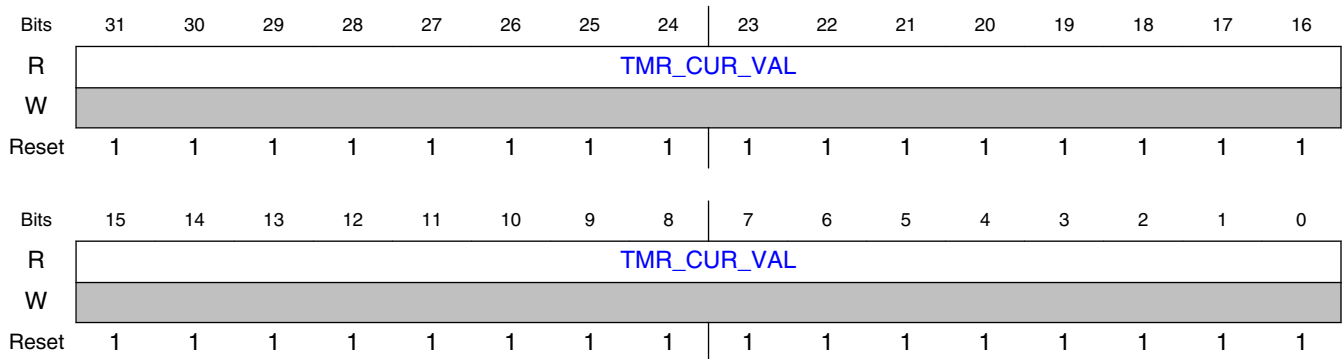

48.4.1.10.4 Fields

Field	Function
31-0	Current Timer Value
TMR_CUR_VAL	Represents the current timer value, if the timer is enabled.

48.4.1.11 Timer Control Register (TCTRL0 - TCTRL3)

48.4.1.11.1 Offset

Register	Offset
TCTRL0	28h
TCTRL1	38h
TCTRL2	48h
TCTRL3	58h

48.4.1.11.2 Function

The Timer Control registers contain the control bits for each timer channel.

NOTE

- Unless the peripheral clock to the timers is enabled (Module Clock Enable bit (MCR[M_CEN]) is set (=1)),

then reading or writing the Timer Control register will generate a transfer error.

- Timer controls should only be updated when the timer is disabled. In the Timer Control Register TCTRLn, these timer controls include:
 - Trigger Select TRG_SEL
 - Trigger Source TRG_SRC
 - Timer Reload On Trigger TROT
 - Timer Stop On Interrupt TSOI
 - Timer Start On Trigger TSOT
 - Timer Operation Mode MODE
 - Chain Channel CHAIN

There are 2 ways to disable a timer: write 1 to the specific timer's Clear Timer Enable register bit (CLR_TEN[CLR_T_EN_n]) or set the timer enable bit (TCTRLn[T_EN]) = 0 for that channel.

48.4.1.11.3 Diagram

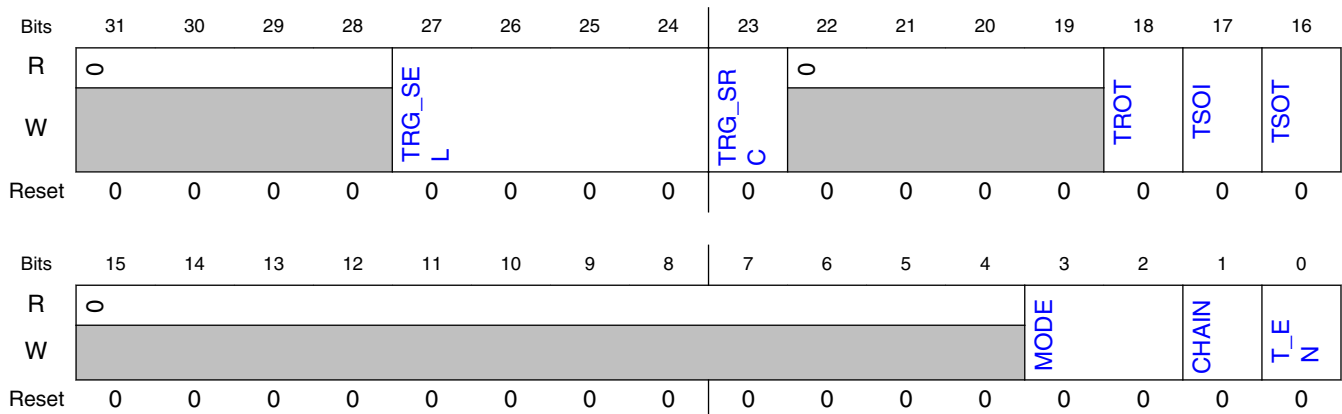

48.4.1.11.4 Fields

Field	Function
31-28 —	This read-only field is reserved and always has the value 0
27-24 TRG_SEL	Trigger Select Selects the trigger to use for starting and/or reloading the LPIT timer. <ul style="list-style-type: none"> • The TRG_SEL field selects one trigger from the set of internal or external triggers that are selected by the Trigger Source bit (TRG_SRC) • Recall that the TRG_SRC bit selects between internal and external trigger signals for each channel

Table continues on the next page...

Memory Map and Registers

Field	Function
	<p>NOTE: The Trigger Select field should only be changed when the LPIT timer channel is disabled.</p> <p>0000-0011b - Timer channel 0 - 3 trigger source is selected</p> <p>0100-1111b - Reserved</p>
23 TRG_SRC	<p>Trigger Source</p> <p>Selects between internal or external trigger sources. The trigger to be used is selected using the TRG_SRC and TRG_SEL bits.</p> <p>Refer to the chip configuration section for available external trigger options. If a channel does not have an associated external trigger, then set the Trigger Source bit (TRG_SRC) = 1.</p> <p>0b - Selects external triggers 1b - Selects internal triggers</p>
22-19 —	This read-only field is reserved and always has the value 0
18 TROT	<p>Timer Reload On Trigger</p> <p>When set, the LPIT timer will reload when a rising edge is detected on the selected trigger input. The trigger input is ignored if the LPIT is disabled during debug mode (DBGEN = 0) or DOZE mode (DOZE_EN = 0)</p> <p>0b - Timer will not reload on the selected trigger 1b - Timer will reload on the selected trigger</p>
17 TSOI	<p>Timer Stop On Interrupt</p> <p>Controls whether the channel timer will stop after it (the channel timer) times out or not.</p> <p>0b - The channel timer does not stop after timeout 1b - The channel timer will stop after a timeout, and the channel timer will restart based on Timer Start On Trigger bit (TSOT). When TSOT = 0, the channel timer will restart after a rising edge on the Timer Enable bit (T_EN) is detected (which means that the timer channel is disabled and then enabled). When TSOT = 1, the channel timer will restart after a rising edge on the selected trigger is detected.</p>
16 TSOT	<p>Timer Start On Trigger</p> <p>Controls when the timer starts decrementing.</p> <p>0b - Timer starts to decrement immediately based on the restart condition (controlled by the Timer Stop On Interrupt bit (TSOI)) 1b - Timer starts to decrement when a rising edge on a selected trigger is detected</p>
15-4 —	This read-only field is reserved and always has the value 0
3-2 MODE	<p>Timer Operation Mode</p> <p>Configures the channel timer's mode of operation. The MODE bits control how the timer decrements.</p> <p>00b - 32-bit Periodic Counter 01b - Dual 16-bit Periodic Counter 10b - 32-bit Trigger Accumulator 11b - 32-bit Trigger Input Capture</p>
1 CHAIN	<p>Chain Channel</p> <p>When enabled, the timer channel will decrement when timer channel N-1 trigger asserts. Timer channel 0 cannot be chained.</p> <p>0b - Channel Chaining is disabled. The channel timer runs independently. 1b - Channel Chaining is enabled. The timer decrements on the previous channel's timeout.</p>
0 T_EN	<p>Timer Enable</p> <p>Enables or disables the Timer Channel</p> <p>0b - Timer Channel is disabled 1b - Timer Channel is enabled</p>

48.5 Functional description

48.5.1 LPIT programming model

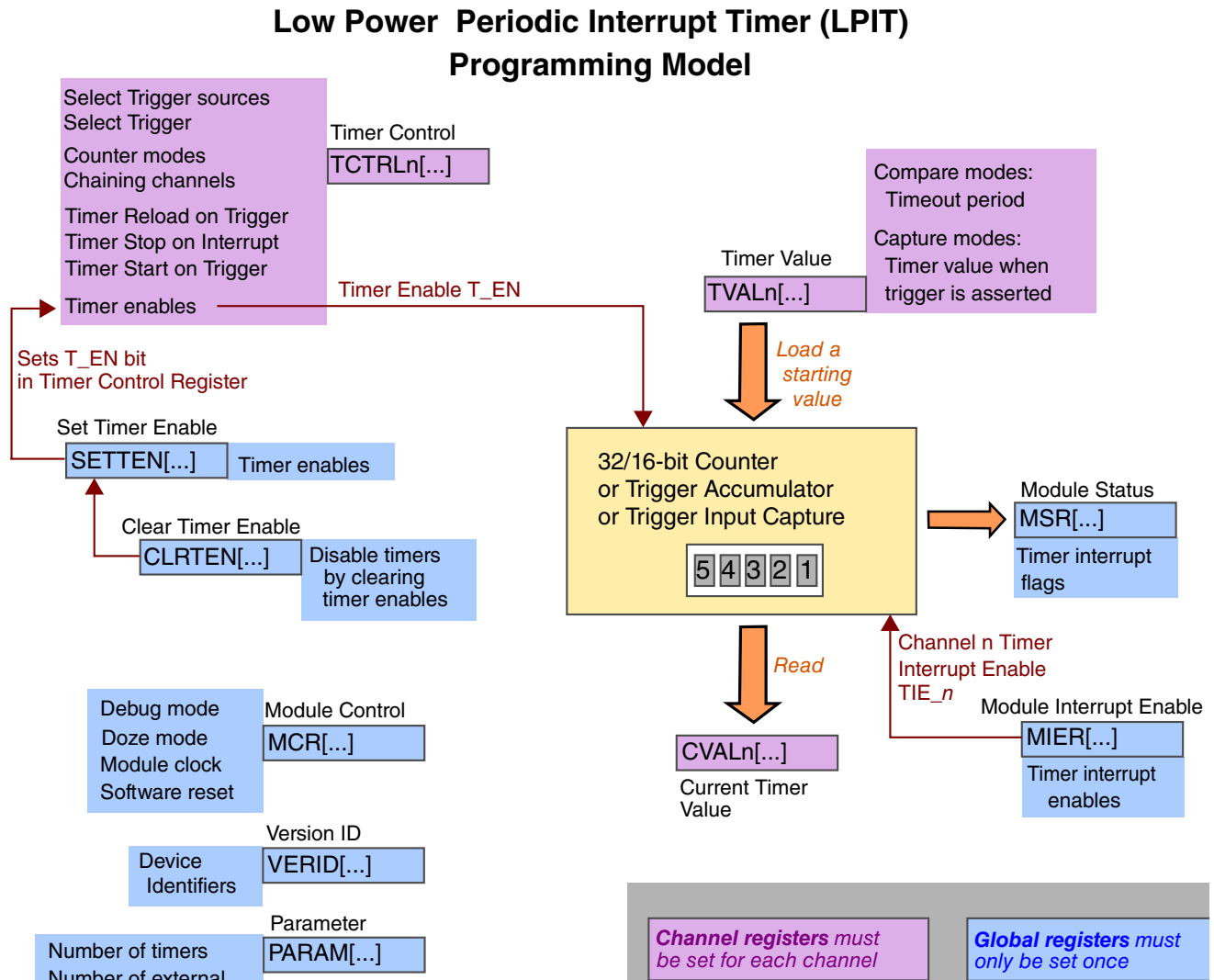

Figure 48-4. Programming Model

Global registers need only be set once:

- Version ID Register (VERID)
- Parameter Register (PARAM)
- Module Control Register (MCR)
- Module Status Register (MSR)
- Module Interrupt Enable Register (MIER)

Functional description

- Set Timer Enable Register (SETTEN)
- Clear Timer Enable Register (CLRTEEN)

Channel registers must be set for each channel:

- Timer Value Register (TVAL0 - TVAL3)
- Current Timer Value (CVAL0 - CVAL3)
- Timer Control Register (TCTRL0 - TCTRL3)

48.5.2 Initialization

Table 48-4. Initializing the LPIT module

Step		How? Why?
1	Enable the peripheral clock	by setting the Module Clock Enable bit (M_CEN) in the Module Control Register (MCR) register. NOTE: <ul style="list-style-type: none"> • Accessing certain registers (MSR, SETTEN, CLRTEEN, TVAL, CVAL, and TCTRL) while M_CEN = 0 will lead to assertion of a transfer error for that bus access. <ul style="list-style-type: none"> • Writing to CVAL and Reserved registers will generate a transfer error. • There might be additional clock gating bits in the device that gate the peripheral clock to this module. When enabling the clock to this module, ensure that software is configuring those additional clock gating bits (in addition to M_CEN bit).
2	Wait for 4 peripheral clock cycles	to allow time for clock synchronization and reset de-assertion.
3	Configure timer control bits	for each timer channel that is to be enabled: <ul style="list-style-type: none"> • timer mode of operation bits TCTRLn[MODE] • trigger source selection bits TCTRLn[TRG_SEL, TRG_SRC] • trigger control bits TCTRLn[TROT, TSOT, TSOI] NOTE: Timer controls should only be updated when the timer is disabled. There are 2 ways to disable a timer: write 1 to the specific timer's Clear Timer Enable register bit (CLRTEEN[CLR_T_EN_n]) or set the timer enable bit (TCTRLn[T_EN]) = 0 for that channel.
4	Configure the channels that are to be chained	by setting the CHAIN bit in the corresponding channel's TCTRLn register.
5	Set the timer timeout value	for channels configured in Compare Mode, by programming the appropriate value in TVAL register for those channels.
6	Configure TIEN bits in MIER register	for those channels that are required to generate interrupts on timer timeouts.
7	Configure the low power modes of the module	by setting the DBG_EN and DOZE_EN bits in the MCR register. This is common to all timer channels.
8	Enable the channel timers	by setting the corresponding T_EN bit in the corresponding channel's TCTRLn register.

Also:

- For channels configured in Capture Mode, the timer value can be read from TVALn register when a channel timeout occurs.
- At any time, the current value of the timer for any channel can be read by reading the corresponding channel's CVALn register. The M_CEN bit must be '1' when doing so.
- The timer interrupt flag bits (TIFn) in MSR register get asserted on timer timeout. To clear these timer interrupt flag bits, write '1' to them.

48.5.3 Timer Modes

The timer mode is configured by setting an appropriate value in the MODE bits in TCTRLn register.

Table 48-5. Timer modes that are supported

Timer Mode	Operation
32-bit Periodic Counter	<ul style="list-style-type: none"> • The counter will load, decrement down to 0 • which will set the timer interrupt flag and assert the output pre-trigger.
Dual 16-bit Periodic Counter	<ul style="list-style-type: none"> • The counter will load, then the lower 16-bits will decrement down to 0 • which will assert the output pre-trigger. • The upper 16-bits will then decrement down to 0 • which will set the timer interrupt flag and then negate the output pre-trigger.
32-bit Trigger Accumulator	<ul style="list-style-type: none"> • The counter will load on the 1st trigger rising edge and then decrement down to 0 on each trigger rising edge • which will set the timer interrupt flag and assert the output pre-trigger.
32-bit Trigger Input Capture	<ul style="list-style-type: none"> • The counter will load with 0xFFFF_FFFF and then decrement down to 0. • If a trigger rising edge is detected, <ul style="list-style-type: none"> • then it will store the inverse of the current counter value in the timer value register • which will set the timer interrupt flag and assert the output pre-trigger.

The timer operation is controlled by Trigger Control bits (TSOT, TSOI, TROT) which control the timer load, reload, start and restart of the timers.

NOTE

- The trigger output is asserted one Peripheral Timer Clock cycle later than pre-trigger output. The trigger output and the pre-trigger output de-assert at the same time.
- The pre-trigger output is asserted for 2 clock cycles and the trigger output is asserted for 1 clock cycle (except in 16-bit Periodic Counter mode, where both pre-trigger and trigger are asserted for many cycles depending on TMR_VAL[31:16]).
- Timer changes *that are based on external triggers* take effect after 4 peripheral clocks after the actual external

trigger assertion (due to clock synchronization, rise edge detection and timer update).

48.5.4 Trigger Control for Timers

Various programmable bits control how the trigger inputs and the timer operate.

TRG_SEL and TRG_SRC select the timer triggers:

- Trigger Select (TRG_SEL) selects the input trigger for the channel from all of the other channel's trigger outputs.
- Trigger Source (TRG_SRC) selects between the internal trigger and the external trigger inputs to the channel.

The selected trigger affects how the timer operates, using the configuration of the TROT, TSOI and TSOT bits.

Table 48-6. How bits control timer operations

If	=	Then
TSOI <i>Timer Stop On Interrupt</i>	1	then the counter stops on a Timer Interrupt flag (MSR[TIFn]) assertion. To reload and decrement, it requires: <ul style="list-style-type: none"> • a trigger (if TSOT = 1) • a T_EN rising edge (if TSOT = 0)
	0	then the counter does not stop after timeout
TROT <i>Timer Reload On Trigger</i>	1	then the counter is loaded on each trigger
	0	then the counter is loaded on every T_EN rising edge or timeout rising edge (timeout not used in Capture modes)
TSOT <i>Timer Start On Trigger</i>	1	then the counter will start to decrement on a trigger. Subsequent triggers are ignored until the counter times out.
	0	then the counter decrements immediately on the next clock edge. When channel is Chained or in Capture mode, TSOT has no effect.

In different timer modes, these programmable bits affect the timer operation differently:

Table 48-7. Time modes and programmable bits

Mode	Which programmable bits affect timer operations
32-bit Periodic Counter	All bits (TSOT, TSOI, TROT) affect the timer operation as described previously.
Dual 16-bit Periodic Counter	
32-bit Trigger Accumulator	<ul style="list-style-type: none"> • Only the TSOI bit controls the timer function. • TROT and TSOT bits have no effect on timer operations.
32-bit Input Trigger Capture	<ul style="list-style-type: none"> • Only TSOI and TROT bits control the timer function. • TSOT bit has no effect on timer operations.

48.5.5 Channel Chaining

Individual timer channels can be chained together to achieve a larger value of timeout. Chaining the timer channel causes them to work in a *'nested loop'* manner thereby leading to an effective timeout value of $TVAL_{CHn} \times (TVAL_{CHn-1} + 1)$.

The channels are chained by setting the CHAIN bit in corresponding channel's $TCTRL_{CHn}$ register. When a channel is chained, that channel's timer decrements on previous channel's timeout pulse, regardless of the timer mode (MODE bits). The TSOT bit does not have any effect if the channel timer (Channel 'n') is chained to previous channel's timer (Channel 'n-1').

48.5.6 Detailed timing

NOTE

The timing diagrams in these sections are not *cycle-accurate* (i.e., some cycles may not be shown), but the timing diagrams do show the timer channel behavior across several clock cycles.

Table 48-8. Timing diagrams list

Mode		Timing Diagram	TSOT	TROT	TSOI	CHAIN
32-bit periodic counter (compare mode)	00	Figure 48-5	0	0	0	0
		Figure 48-6	0	0	1	0
		Figure 48-7	0	1	0	0
		Figure 48-8	0	1	1	0
		Figure 48-9	1	0	0	0
		Figure 48-10	1	0	1	0
		Figure 48-11	1	1	0	0
		Figure 48-12	1	1	1	0
16-bit dual periodic counter (compare mode)	01	Figure 48-13	0	0	0	0
32-bit trigger accumulator mode	10	Figure 48-14	X	X	0	0
		Figure 48-15	X	X	1	0
32-bit trigger capture mode	11	Figure 48-16	X	0	0	0
		Figure 48-17	X	1	0	0
		Figure 48-18	X	0	1	0
Timer chaining: effects on timing operations	-	Figure 48-19	-	-	-	-

48.5.6.1 Mode=00: 32-bit periodic counter (compare mode)

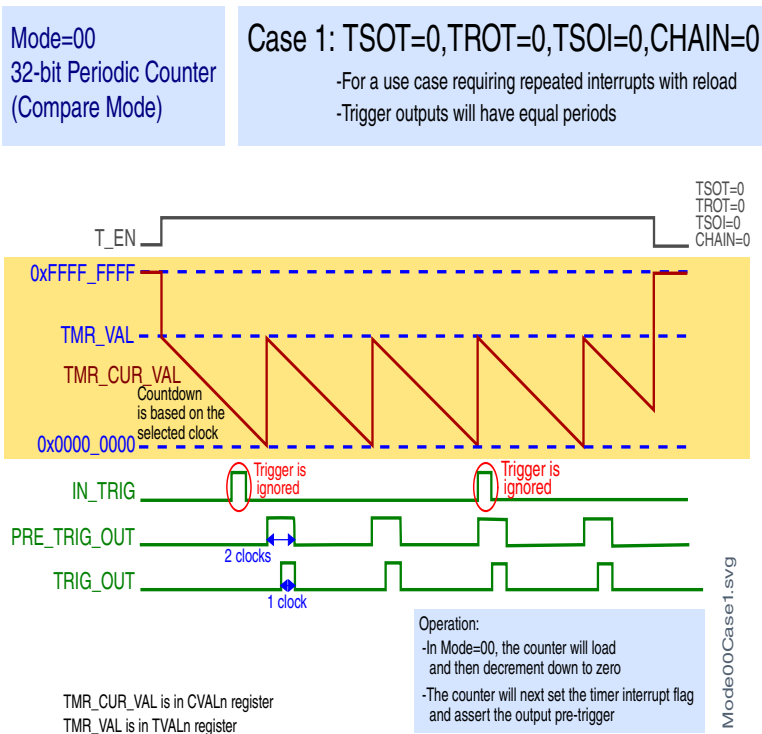

Figure 48-5. Case 1: TSOT = 0, TROT = 0, TSOI = 0, CHAIN = 0

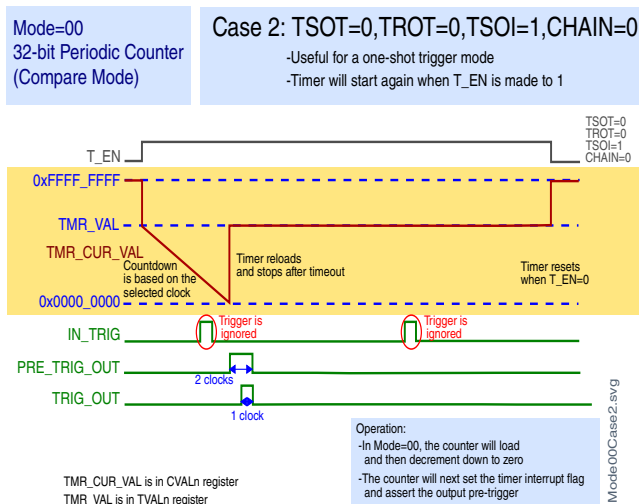

Figure 48-6. Case 2: TSOT = 0, TROT = 0, TSOI = 1, CHAIN = 0

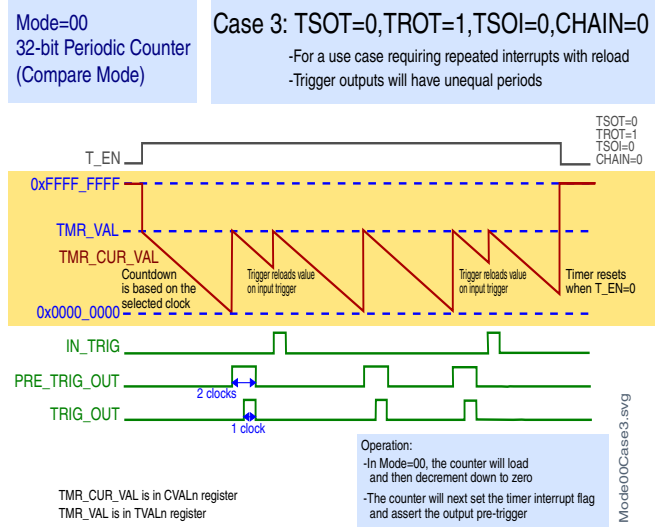

Figure 48-7. Case 3: TSOT = 0, TROT = 1, TSOI = 0, CHAIN = 0

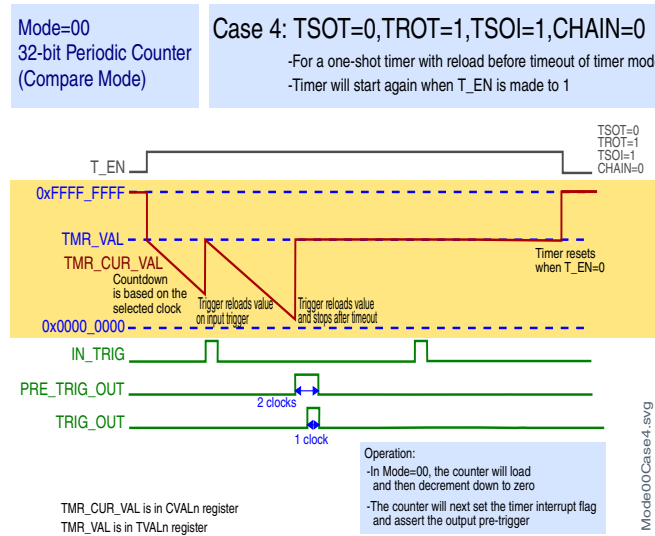

Figure 48-8. Case 4: TSOT = 0, TROT = 1, TSOI = 1, CHAIN = 0

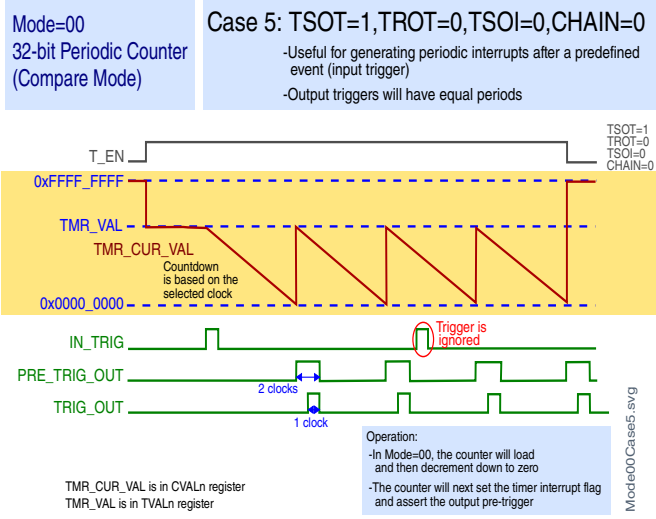

Figure 48-9. Case 5: TSOT = 1, TROT = 0, TSOI = 0, CHAIN = 0

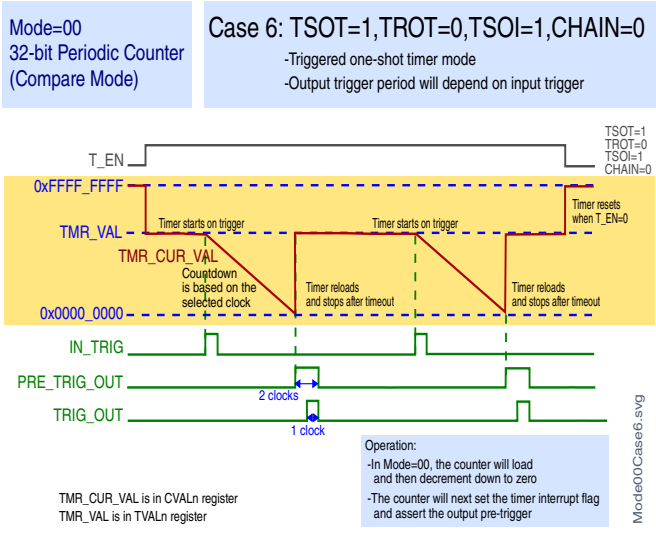

Figure 48-10. Case 6: TSOT = 1, TROT = 0, TSOI = 1, CHAIN = 0

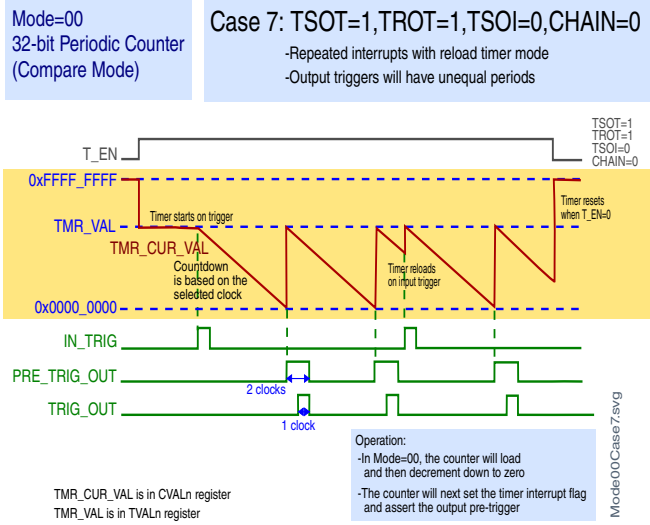

Figure 48-11. Case 7: TSOT = 1, TROT = 1, TSOI = 0, CHAIN = 0

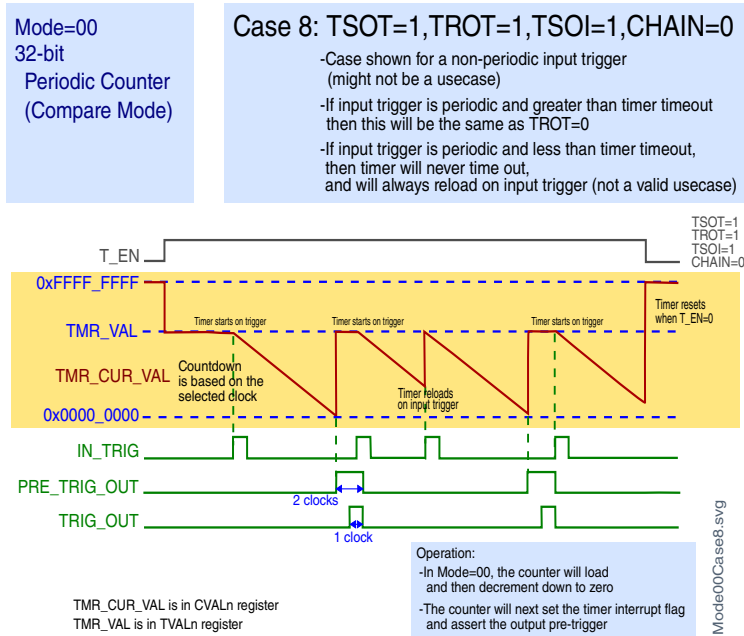

Figure 48-12. Case 8: TSOT = 1, TROT = 1, TSOI = 1, CHAIN = 0

48.5.6.2 Mode=01: 16-bit dual periodic counter (compare mode)

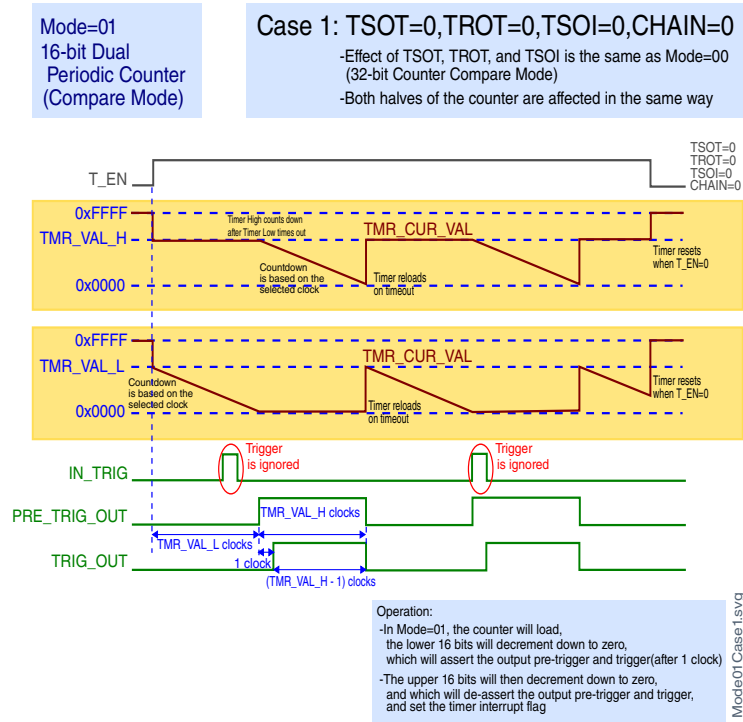

Figure 48-13. Case 1: TSOT = 0, TROT = 0, TSOI = 0, CHAIN = 0

Effect of Timer Control Bits in Mode=01:

- Effect of timer control bits are the same as for Mode=00. Refer to the individual figures of Mode=00.
- The Timer Interrupt (timeout) asserts when {TMR_H, TMR_L} = 0x0000_0000.
- Behavior for Mode = 01 is explained in the next table.

Table 48-9. Mode=01 timer control bits

TSOT	TROT	TSOI	Function	Effect on Timer
0	0	0	<ul style="list-style-type: none"> • For repeated interrupts with reload • Trigger outputs will have equal periods 	Similar to Figure 48-13 .
0	0	1	One-shot mode	<ul style="list-style-type: none"> • Both timers stop after first count down and then time out • Timers will not count again until T_EN is made 1 again • Similar to Figure 48-6.
0	1	0	<ul style="list-style-type: none"> • For repeated interrupts with reload • Trigger outputs will have unequal periods 	<ul style="list-style-type: none"> • Both timers will reload TMR_VAL on trigger rise edge • Output triggers will clear on reload, if asserted • Similar to Figure 48-7.

Table continues on the next page...

Table 48-9. Mode=01 timer control bits (continued)

TSOT	TROT	TSOI	Function	Effect on Timer
0	1	1	Reloadable one-shot mode	<ul style="list-style-type: none"> If a trigger occurs before timeout, then both timers reload and count down (as shown); the timers stop after timeout A trigger assertion after timeout simply reloads TMR_VAL into the timers The timers will not count again until T_EN is set to 1 again Similar to Figure 48-8.
1	0	0	<ul style="list-style-type: none"> For generating periodic interrupts after a predefined event (input trigger) Output triggers will have equal periods 	<p>After T_EN rises, the timers do not start until the first trigger's rising edge</p> <ul style="list-style-type: none"> Subsequent triggers will have no effect Similar to Figure 48-9.
1	0	1	<ul style="list-style-type: none"> Triggered one-shot timer mode Output trigger period will depend on input trigger 	<p>After T_EN rises, the timers do not start until the first trigger's rising edge.</p> <ul style="list-style-type: none"> The timer stops counting after a timeout assertion (a timeout is asserted) The timer does not start counting again until a new trigger's rising edge is detected Similar to Figure 48-10.
1	1	0	<ul style="list-style-type: none"> For repeated interrupts with reload timer mode Output triggers will have unequal periods 	<p>After T_EN rises, the timers do not start until the first trigger's rising edge</p> <ul style="list-style-type: none"> Subsequent triggers will cause the timer to reload TMR_VAL into both counters The output triggers will clear after a reload, if asserted Similar to Figure 48-11.
1	1	1	<ul style="list-style-type: none"> For a non-periodic input trigger If input trigger is periodic and greater than timer timeout, then this will be the same as TROT=0 (which is triggered one-shot timer mode; output trigger period will depend on input trigger) 	<p>After T_EN rises, the timers do not start until the first trigger's rising edge</p> <ul style="list-style-type: none"> The timers stops counting after a timeout assertion (a timeout is asserted) A trigger's rising edge will cause the timers to reload and then count down Similar to Figure 48-12.

48.5.6.3 Mode=10: 32-bit trigger accumulator mode

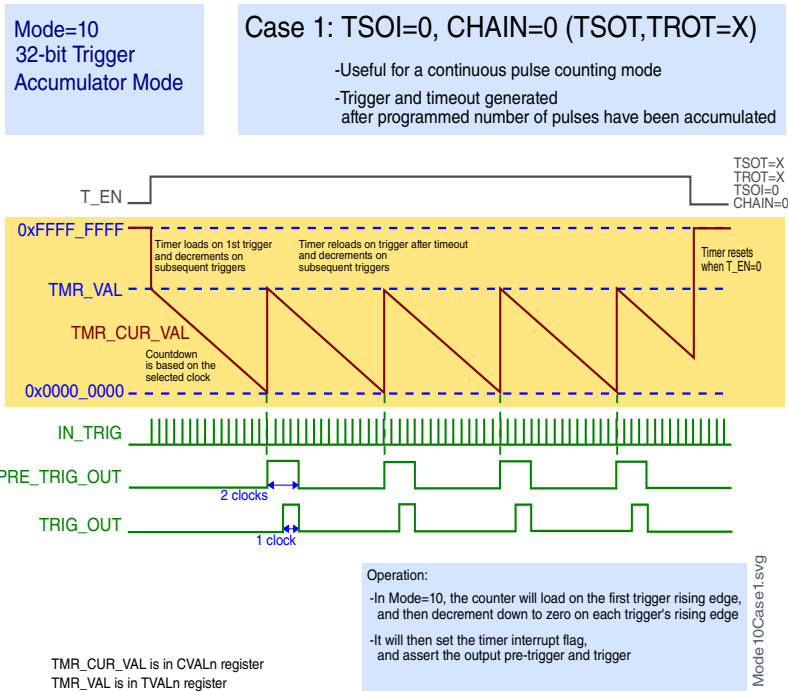

Figure 48-14. Case 1: TSOT = X, TROT = X, TSOI = 0, CHAIN = 0

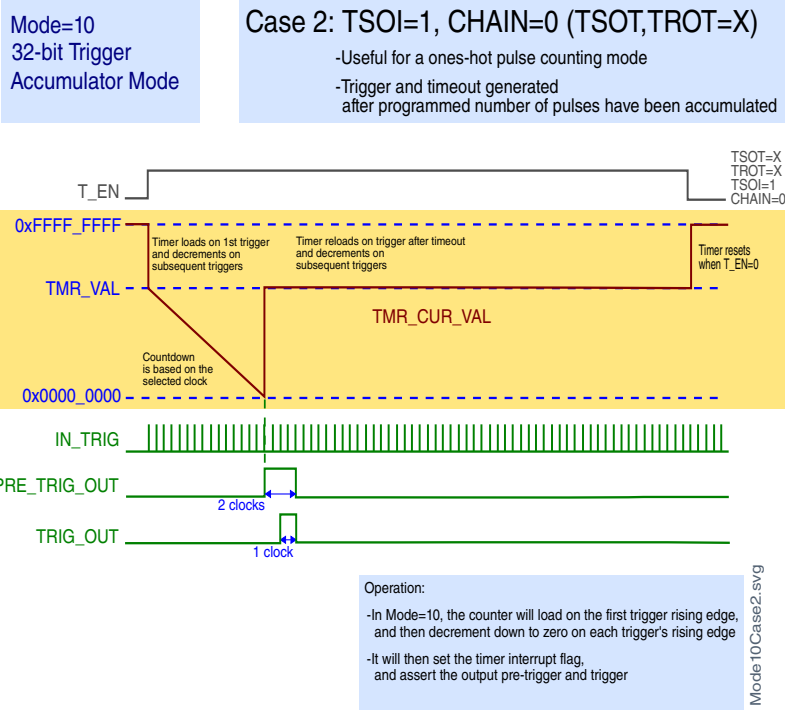

Figure 48-15. Case 2: TSOT = X, TROT = X, TSOI = 1, CHAIN = 0

48.5.6.4 Mode=11: 32-bit trigger capture mode

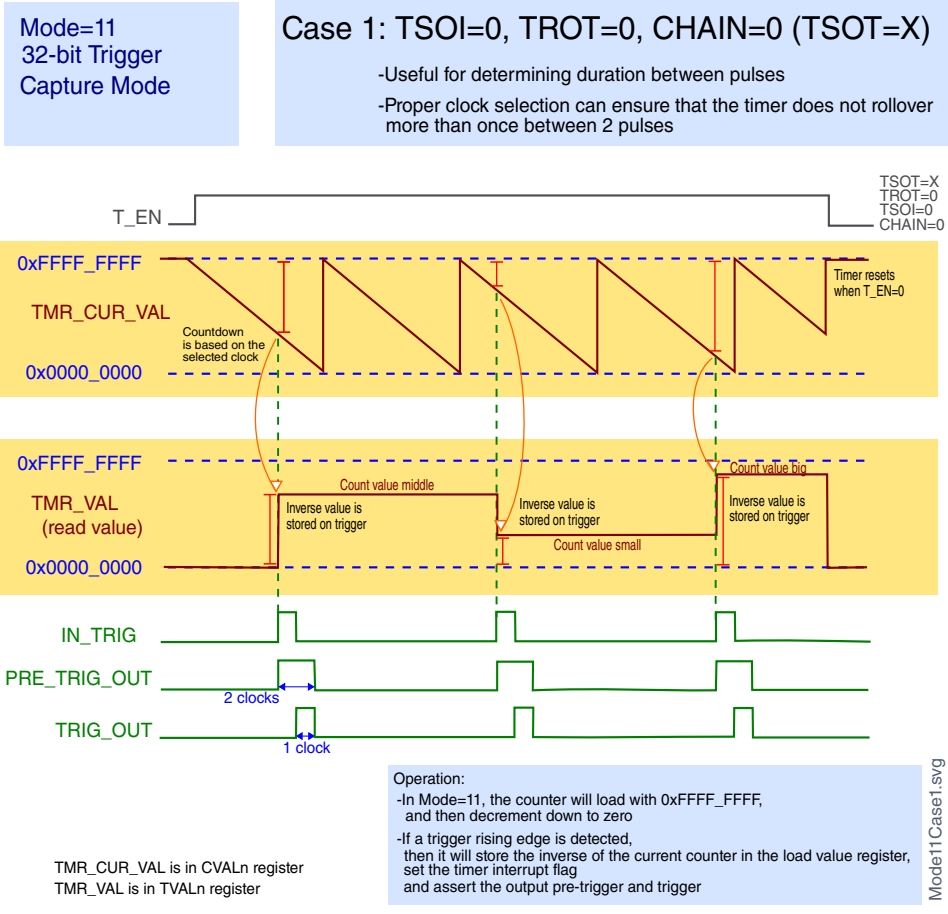

Figure 48-16. Case 1: TSOT = X, TROT = 0, TSOI = 0, CHAIN = 0

Mode=11
32-bit Trigger
Capture Mode

Case 2: TSOI=0, TROT=1, CHAIN=0 (TSOT=X)

- Useful for determining duration between pulses
- Selecting a fast timer clock provides accurate measurements but it can also cause timer rollover inbetween pulses

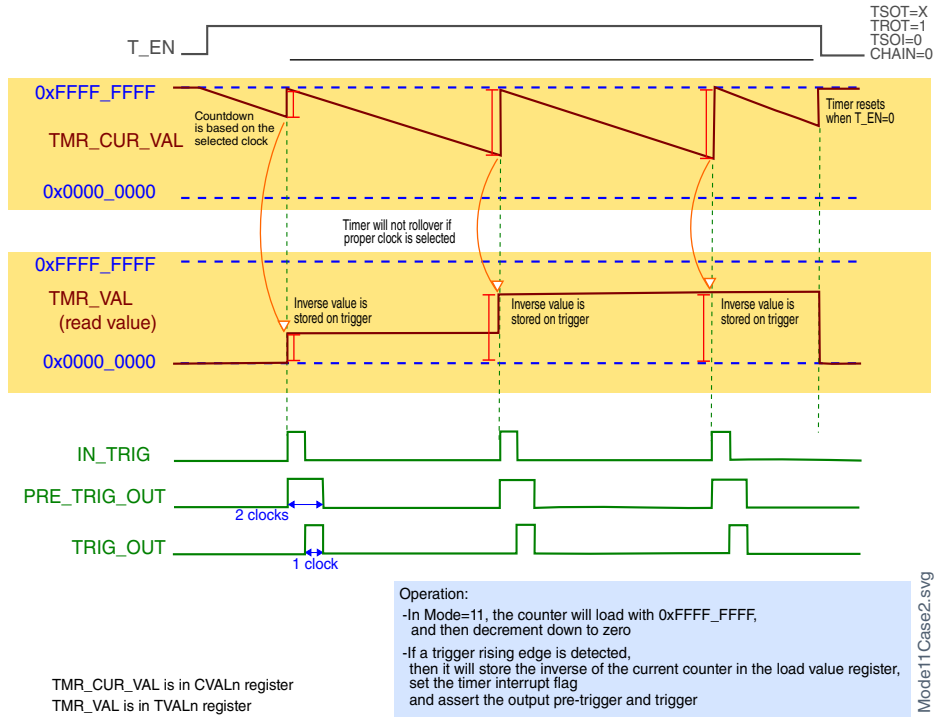

Figure 48-17. Case 2: TSOT = X, TROT = 1, TSOI = 0, CHAIN = 0

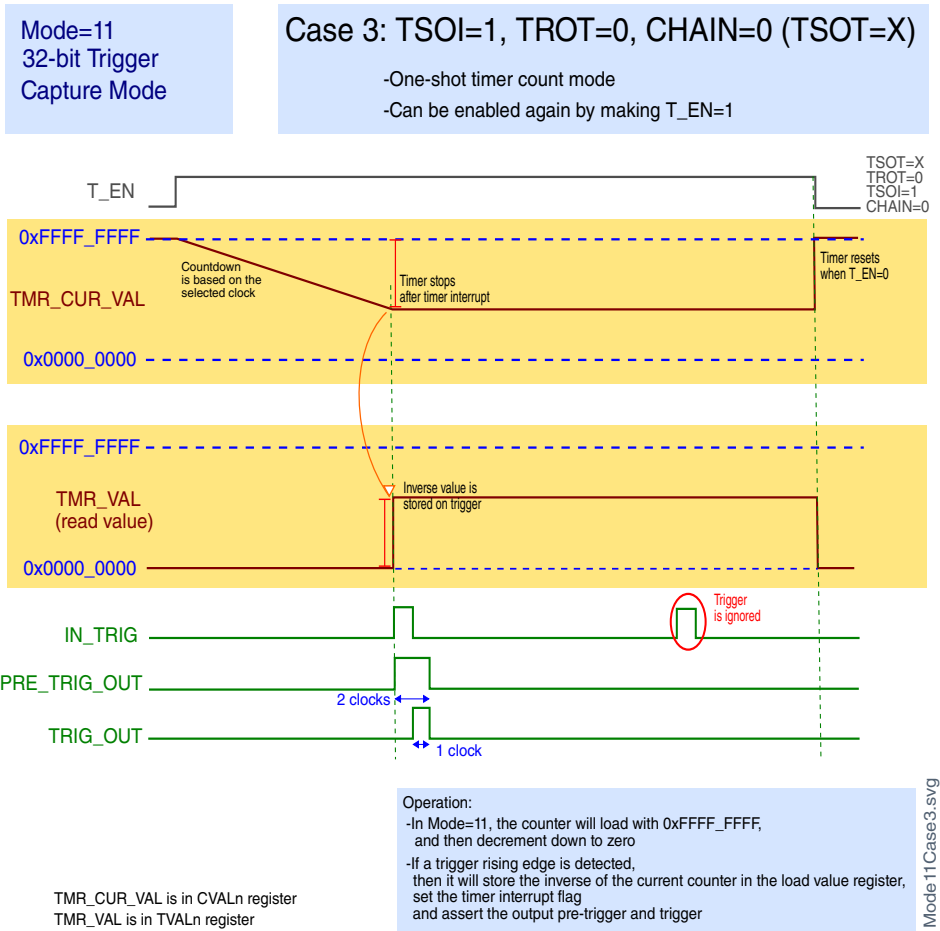

Figure 48-18. Case 3: TSOT = X, TROT = 0, TSOI = 1, CHAIN = 0

Case 4: TSOT = X, TROT = 1, TSOI = 1, CHAIN = 0

Same as previous case (Case 3), except that the timer reloads to 0xFFFF_FFFF and then stops. The timer does not start until T_EN is made 1 again. Case 4 is not a very useful case, because Case 3 covers this.

48.5.6.5 Timer chaining

Effect of Chaining

- Chaining causes Timer “n” to decrement on every timeout pulse (trigger output pulse) from Timer “n – 1”, regardless of what mode is configured in Timer “n”
- Timers “n” and “n – 1” effectively form a larger width timer (64-bits)
- More than 2 timer channels (or all timer channels) can be chained
- It is preferred to have the same trigger source and timer controls configured for chained channels

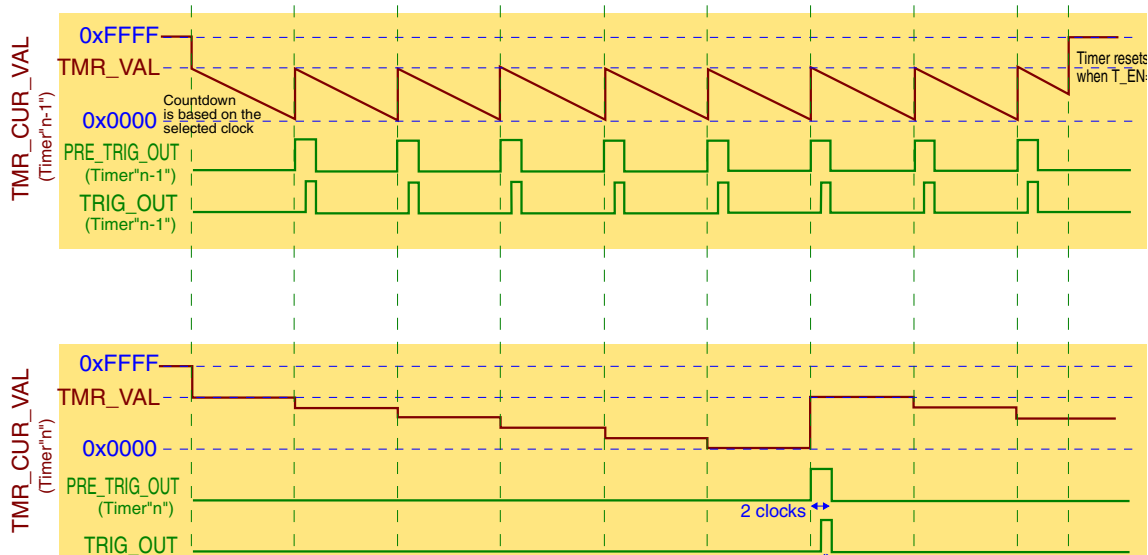

Figure 48-19. Chaining Effects

Chapter 49

Low Power Timer (LPTMR)

49.1 Chip-specific LPTMR information

49.1.1 Instantiation Information

S32K1xx contains one LPTMR module with either a 1 channel 16-bit time counter or a 1 channel 16-bit pulse counter.

NOTE

The read of the LPTimer registers is affected during EEERAM commands. For more information see note 'During execution of the SetRAM 0xFF' in [Chip-specific FTFC information](#).

49.1.1.1 LPT/HSCMP0 pulse counting

LPTMR_ALT0 input is the selectable source to count pulses resulting from HSCMP0 Output (LPT_ALT0 = HSCMP0 Output) via TRGMUX.

NOTE

- Low leakage mode and Wait mode are not supported in this device. See [Module operation in available power modes](#) for details on available power modes.
- For LPTMR_PSR[PCS] bit options refer to table: Peripheral module clocking in section [Module clocks](#).
- f_{LPTMR} referred in the chapter refers to f_{BUS} parameter in the datasheet.

49.1.2 LPTMR pulse counter input options

The LPTMR_CSR[TPS] bitfield configures the input source used in pulse counter mode. The following table shows the chip-specific input assignments for this bitfield.

Table 49-1. Pulse counter input options

LPTMR_CSR[TPS]	Pulse counter input number	Chip input
00	0	TRGMUX output
01	1	LPTMR_ALT1 pin
10	2	LPTMR_ALT2 pin
11	3	LPTMR_ALT3 pin

49.1.3 S32K11X to S32K14X difference

See [Differences between S32K14x/S32K14xW, and S32K11x](#), for differences arising out of CPU and interrupt latency impacting timed events when comparing S32K14X and S32K11X variants.

49.2 Introduction

The low-power timer (LPTMR) can be configured to operate as a time counter with optional prescaler, or as a pulse counter with optional glitch filter, across all power modes, including the low-leakage modes. It can also continue operating through most system reset events, allowing it to be used as a time of day counter.

49.2.1 Features

The features of the LPTMR module include:

- 16-bit time counter or pulse counter with compare
 - Optional interrupt can generate asynchronous wakeup from any low-power mode
 - Hardware trigger output
 - Counter supports free-running mode or reset on compare
- Configurable clock source for prescaler/glitch filter
- Configurable input source for pulse counter
 - Rising-edge or falling-edge

49.2.2 Modes of operation

The following table describes the operation of the LPTMR module in various modes.

Table 49-2. Modes of operation

Modes	Description
Run	The LPTMR operates normally.
Wait	The LPTMR continues to operate normally and can be configured to exit the low-power mode by generating an interrupt request.
Stop	The LPTMR continues to operate normally and can be configured to exit the low-power mode by generating an interrupt request.
Low-Leakage	The LPTMR continues to operate normally and can be configured to exit the low-power mode by generating an interrupt request.
Debug	The LPTMR operates normally in Pulse Counter mode, but the counter does not increment in Time Counter mode.

49.3 LPTMR signal descriptions

Table 49-3. LPTMR signal descriptions

Signal	I/O	Description
LPTMR_ALT n	I	Pulse Counter Input pin

49.3.1 Detailed signal descriptions

Table 49-4. LPTMR interface—detailed signal descriptions

Signal	I/O	Description
LPTMR_ALT n	I	Pulse Counter Input The LPTMR can select one of the input pins to be used in Pulse Counter mode.
		State meaning Assertion—If configured for pulse counter mode with active-high input, then assertion causes the CNR to increment. Deassertion—If configured for pulse counter mode with active-low input, then deassertion causes the CNR to increment.
		Timing Assertion or deassertion may occur at any time; input may assert asynchronously to the bus clock.

49.4 Memory map and register definition

NOTE

The LPTMR registers are reset only on a POR or LVD event.
See [LPTMR power and reset](#) for more details.

49.4.1 LPTMR register descriptions

49.4.1.1 LPTMR memory map

LPTMR0 base address: 4004_0000h

Offset	Register	Width (In bits)	Access	Reset value
0h	Low Power Timer Control Status Register (CSR)	32	RW	0000_0000h
4h	Low Power Timer Prescale Register (PSR)	32	RW	0000_0000h
8h	Low Power Timer Compare Register (CMR)	32	RW	0000_0000h
Ch	Low Power Timer Counter Register (CNR)	32	RW	0000_0000h

49.4.1.2 Low Power Timer Control Status Register (CSR)

49.4.1.2.1 Offset

Register	Offset
CSR	0h

49.4.1.2.2 Diagram

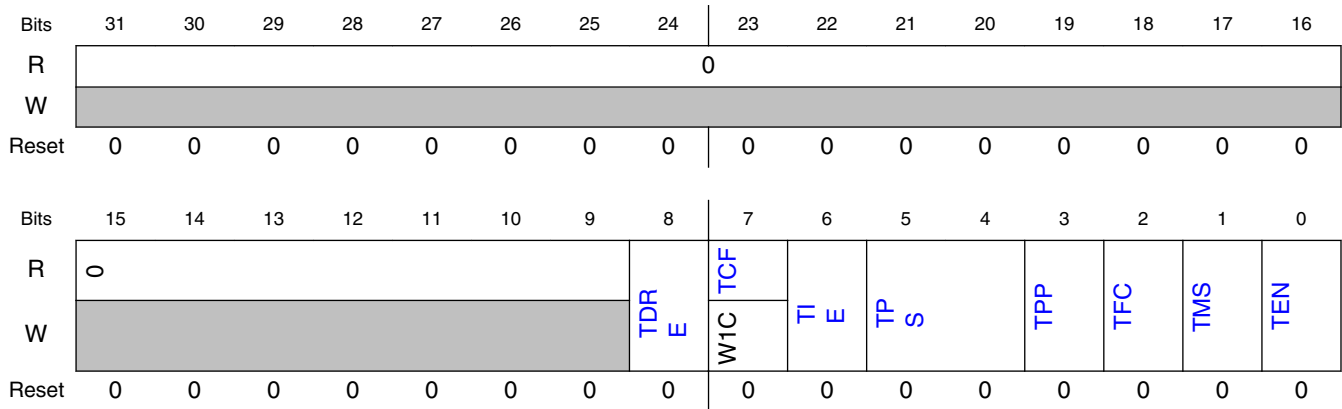

49.4.1.2.3 Fields

Field	Function
31-9 —	Reserved
8 TDRE	<p>Timer DMA Request Enable</p> <p>When TDRE is set, the LPTMR DMA Request is generated whenever TCF is also set and the TCF is cleared when the DMA Controller is done.</p> <p>0b - Timer DMA Request disabled. 1b - Timer DMA Request enabled.</p>
7 TCF	<p>Timer Compare Flag</p> <p>TCF is set when the LPTMR is enabled and the CNR equals the CMR and increments. TCF is cleared when the LPTMR is disabled or a logic 1 is written to it.</p> <p>NOTE: Ensure to clear this field before enabling the Timer interrupt or DMA request.</p> <p>0b - The value of CNR is not equal to CMR and increments. 1b - The value of CNR is equal to CMR and increments.</p>
6 TIE	<p>Timer Interrupt Enable</p> <p>When TIE is set, the LPTMR Interrupt is generated whenever TCF is also set.</p> <p>0b - Timer interrupt disabled. 1b - Timer interrupt enabled.</p>
5-4 TPS	<p>Timer Pin Select</p> <p>Configures the input source to be used in Pulse Counter mode. TPS must be altered only when the LPTMR is disabled. The input connections vary by device. See the chip configuration information about connections to these inputs.</p> <p>00b - Pulse counter input 0 is selected. 01b - Pulse counter input 1 is selected. 10b - Pulse counter input 2 is selected. 11b - Pulse counter input 3 is selected.</p>
3 TPP	<p>Timer Pin Polarity</p> <p>Configures the polarity of the input source in Pulse Counter mode. TPP must be changed only when the LPTMR is disabled.</p> <p>0b - Pulse Counter input source is active-high, and the CNR increments on the rising-edge.</p>

Table continues on the next page...

Memory map and register definition

Field	Function
	1b - Pulse Counter input source is active-low, and the CNR increments on the falling-edge.
2 TFC	Timer Free-Running Counter When clear, TFC configures the CNR to reset whenever TCF is set. When set, TFC configures the CNR to reset on overflow. TFC must be altered only when the LPTMR is disabled. 0b - CNR is reset whenever TCF is set. 1b - CNR is reset on overflow.
1 TMS	Timer Mode Select Configures the mode of the LPTMR. TMS must be altered only when the LPTMR is disabled. 0b - Time Counter mode. 1b - Pulse Counter mode.
0 TEN	Timer Enable When TEN is clear, it resets the LPTMR internal logic, including the CNR and TCF. When TEN is set, the LPTMR is enabled. While writing 1 to this field, CSR[5:1] must not be altered. 0b - LPTMR is disabled and internal logic is reset. 1b - LPTMR is enabled.

49.4.1.3 Low Power Timer Prescale Register (PSR)

49.4.1.3.1 Offset

Register	Offset
PSR	4h

49.4.1.3.2 Diagram

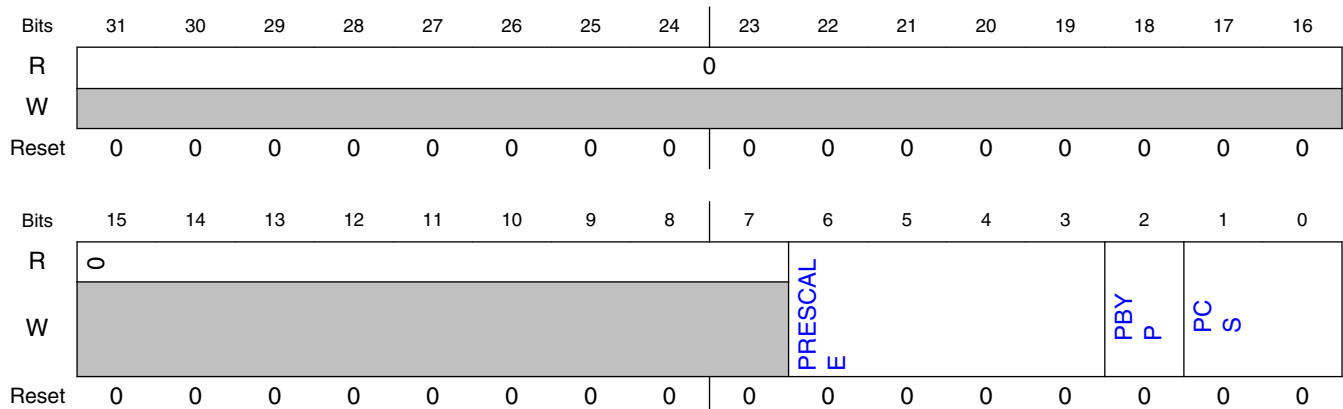

49.4.1.3.3 Fields

Field	Function
31-7 —	Reserved
6-3 PRESCALE	<p>Prescale Value</p> <p>Configures the size of the Prescaler in Time Counter mode or width of the glitch filter in Pulse Counter mode. The width of the glitch filter can vary by 1 cycle due to synchronization of the pulse counter input. PRESCALE must be altered only when the LPTMR is disabled.</p> <p>0000b - Prescaler divides the prescaler clock by 2; glitch filter does not support this configuration. 0001b - Prescaler divides the prescaler clock by 4; glitch filter recognizes change on input pin after 2 rising clock edges. 0010b - Prescaler divides the prescaler clock by 8; glitch filter recognizes change on input pin after 4 rising clock edges. 0011b - Prescaler divides the prescaler clock by 16; glitch filter recognizes change on input pin after 8 rising clock edges. 0100b - Prescaler divides the prescaler clock by 32; glitch filter recognizes change on input pin after 16 rising clock edges. 0101b - Prescaler divides the prescaler clock by 64; glitch filter recognizes change on input pin after 32 rising clock edges. 0110b - Prescaler divides the prescaler clock by 128; glitch filter recognizes change on input pin after 64 rising clock edges. 0111b - Prescaler divides the prescaler clock by 256; glitch filter recognizes change on input pin after 128 rising clock edges. 1000b - Prescaler divides the prescaler clock by 512; glitch filter recognizes change on input pin after 256 rising clock edges. 1001b - Prescaler divides the prescaler clock by 1024; glitch filter recognizes change on input pin after 512 rising clock edges. 1010b - Prescaler divides the prescaler clock by 2048; glitch filter recognizes change on input pin after 1024 rising clock edges. 1011b - Prescaler divides the prescaler clock by 4096; glitch filter recognizes change on input pin after 2048 rising clock edges. 1100b - Prescaler divides the prescaler clock by 8192; glitch filter recognizes change on input pin after 4096 rising clock edges. 1101b - Prescaler divides the prescaler clock by 16,384; glitch filter recognizes change on input pin after 8192 rising clock edges. 1110b - Prescaler divides the prescaler clock by 32,768; glitch filter recognizes change on input pin after 16,384 rising clock edges. 1111b - Prescaler divides the prescaler clock by 65,536; glitch filter recognizes change on input pin after 32,768 rising clock edges.</p>
2 PBYP	<p>Prescaler Bypass</p> <p>When PBYP is set, the selected prescaler clock in Time Counter mode or selected input source in Pulse Counter mode directly clocks the CNR. When PBYP is clear, the CNR is clocked by the output of the prescaler/glitch filter. PBYP must be altered only when the LPTMR is disabled.</p> <p>0b - Prescaler/glitch filter is enabled. 1b - Prescaler/glitch filter is bypassed.</p>
1-0 PCS	<p>Prescaler Clock Select</p> <p>Selects the clock to be used by the LPTMR prescaler/glitch filter. In time counter mode, this field selects the input clock to the prescaler. In pulse counter mode, this field selects the input clock to the glitch filter. PCS must be altered only when the LPTMR is disabled. The clock connections vary by device.</p> <p>NOTE: See the chip configuration details for information on the connections to these inputs.</p> <p>00b - Prescaler/glitch filter clock 0 selected. 01b - Prescaler/glitch filter clock 1 selected. 10b - Prescaler/glitch filter clock 2 selected. 11b - Prescaler/glitch filter clock 3 selected.</p>

49.4.1.4 Low Power Timer Compare Register (CMR)

49.4.1.4.1 Offset

Register	Offset
CMR	8h

49.4.1.4.2 Diagram

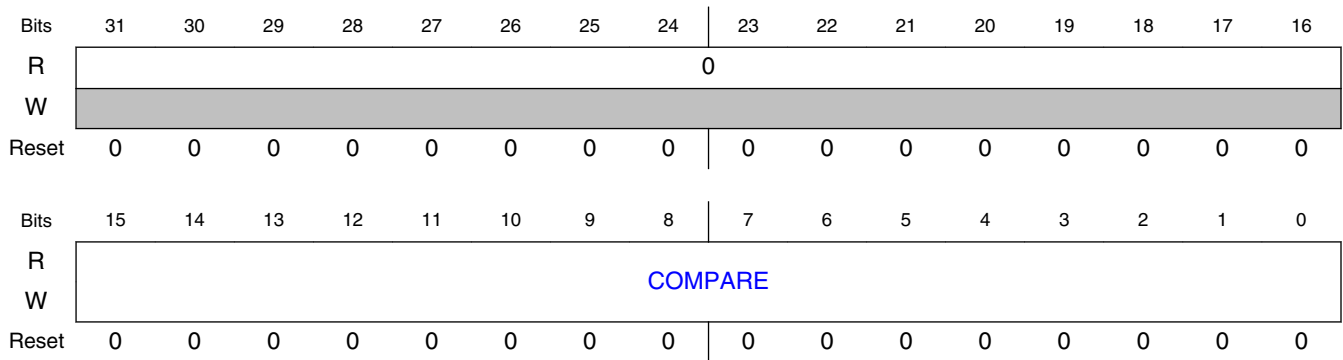

49.4.1.4.3 Fields

Field	Function
31-16 —	Reserved
15-0 COMPARE	Compare Value When the LPTMR is enabled and the CNR equals the value in the CMR and increments, TCF is set and the hardware trigger asserts until the next time the CNR increments. If the CMR is 0, the hardware trigger remains asserted until the LPTMR is disabled. If the LPTMR is enabled, the CMR must be altered only when TCF is set.

49.4.1.5 Low Power Timer Counter Register (CNR)

49.4.1.5.1 Offset

Register	Offset
CNR	Ch

49.4.1.5.2 Diagram

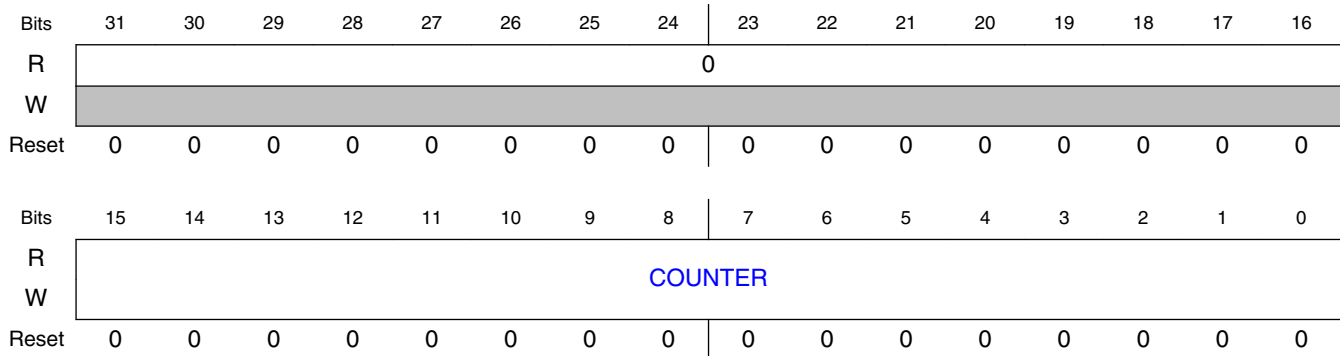

49.4.1.5.3 Fields

Field	Function
31-16 —	Reserved
15-0 COUNTER	Counter Value The CNR returns the current value of the LPTMR counter at the time this register was last written.

49.5 Functional description

49.5.1 LPTMR power and reset

The LPTMR remains powered in all power modes, including low-leakage modes. If the LPTMR is not required to remain operating during a low-power mode, then it must be disabled before entering the mode.

The LPTMR is reset only on global Power On Reset (POR) or Low Voltage Detect (LVD). When configuring the LPTMR registers, the CSR must be initially written with the timer disabled, before configuring the PSR and CMR. Then, CSR[TIE] must be set as the last step in the initialization. This ensures the LPTMR is configured correctly and the LPTMR counter is reset to zero following a warm reset.

49.5.2 LPTMR clocking

The LPTMR prescaler/glitch filter can be clocked by one of the four clocks. The clock source must be enabled before the LPTMR is enabled.

NOTE

The clock source selected by PSR[PCS] may need to be configured to remain enabled in low-power modes, otherwise the LPTMR does not operate during low-power modes.

In Pulse Counter mode with the prescaler/glitch filter bypassed, the selected input source directly clocks the CNR and no other clock source is required. To minimize power in this case, configure the prescaler clock source for a clock that is not toggling.

NOTE

The clock source or pulse input source selected for the LPTMR should not exceed the frequency f_{LPTMR} defined in the device datasheet.

49.5.3 LPTMR prescaler/glitch filter

The LPTMR prescaler and glitch filter share the same logic which operates as a prescaler in Time Counter mode and as a glitch filter in Pulse Counter mode.

NOTE

The prescaler/glitch filter configuration must not be altered when the LPTMR is enabled.

49.5.3.1 Prescaler enabled

In Time Counter mode, when the prescaler is enabled, the output of the prescaler directly clocks the CNR. When the LPTMR is enabled, the CNR increments every 2^2 to 2^{16} prescaler clock cycles. After the LPTMR is enabled, the first increment of the CNR takes an additional one or two prescaler clock cycles due to synchronization logic.

49.5.3.2 Prescaler bypassed

In Time Counter mode, when the prescaler is bypassed, the selected prescaler clock increments the CNR on every clock cycle. When the LPTMR is enabled, the first increment takes an additional one or two prescaler clock cycles due to synchronization logic.

49.5.3.3 Glitch filter

In Pulse Counter mode, when the glitch filter is enabled, the output of the glitch filter directly clocks the CNR. When the LPTMR is first enabled, the output of the glitch filter is asserted, that is, logic 1 for active-high and logic 0 for active-low. The following table shows the change in glitch filter output with the selected input source.

If	Then
The selected input source remains deasserted for at least 2^1 to 2^{15} consecutive prescaler clock rising edges	The glitch filter output also deasserts.
The selected input source remains asserted for at least 2^1 to 2^{15} consecutive prescaler clock rising-edges	The glitch filter output also asserts.

NOTE

The input is only sampled on the rising clock edge.

The CNR increments each time the glitch filter output asserts. In Pulse Counter mode, the maximum rate at which the CNR can increment is once every 2^2 to 2^{16} prescaler clock edges. When first enabled, the glitch filter waits an additional one or two prescaler clock edges due to synchronization logic.

49.5.3.4 Glitch filter bypassed

In Pulse Counter mode, when the glitch filter is bypassed, the selected input source increments the CNR every time it asserts. Before the LPTMR is first enabled, the selected input source is forced to be asserted. This prevents the CNR from incrementing if the selected input source is already asserted when the LPTMR is first enabled.

49.5.4 LPTMR counter

The CNR increments by one on every:

Functional description

- Prescaler clock in Time Counter mode with prescaler bypassed
- Prescaler output in Time Counter mode with prescaler enabled
- Input source assertion in Pulse Counter mode with glitch filter bypassed
- Glitch filter output in Pulse Counter mode with glitch filter enabled

The CNR is reset when the LPTMR is disabled or if the counter register overflows. If CSR[TFC] is cleared, then the CNR is also reset whenever CSR[TCF] is set.

When the core is halted in Debug mode:

- If configured for Pulse Counter mode, the CNR continues incrementing.
- If configured for Time Counter mode, the CNR stops incrementing.

The CNR cannot be initialized, but can be read at any time. On each read of the CNR, software must first write to the CNR with any value. This synchronizes and registers the current value of the CNR into a temporary register. The contents of the temporary register are returned on each read of the CNR.

When reading the CNR, the bus clock must be at least two times faster than the rate at which the LPTMR counter is incrementing, otherwise incorrect data may be returned.

49.5.5 LPTMR compare

When the CNR equals the value of the CMR and increments, the following events occur:

- CSR[TCF] is set.
- LPTMR interrupt is generated if CSR[TIE] is also set.
- LPTMR hardware trigger is generated.
- CNR is reset if CSR[TFC] is clear.

When the LPTMR is enabled, the CMR can be altered only when CSR[TCF] is set. When updating the CMR, the CMR must be written and CSR[TCF] must be cleared before the LPTMR counter has incremented past the new LPTMR compare value.

NOTE

When the LPTMR is enabled in Time Counter mode, the first increment will take an additional one or two clock cycles due to synchronization logic. This will result in the first compare (and therefore interrupt and hardware trigger) occurring slightly later. A faster prescaler clock or larger prescaler value will minimize this impact.

49.5.6 LPTMR interrupt

The LPTMR interrupt is generated whenever CSR[TIE] and CSR[TCF] are set. CSR[TCF] is cleared by disabling the LPTMR or by writing a logic 1 to it.

CSR[TIE] can be altered and CSR[TCF] can be cleared while the LPTMR is enabled.

The LPTMR interrupt is generated asynchronously to the system clock and can be used to generate a wakeup from any low-power mode, including the low-leakage modes, provided the LPTMR is enabled as a wakeup source.

49.5.7 LPTMR hardware trigger

The LPTMR hardware trigger asserts at the same time the CSR[TCF] is set and can be used to trigger hardware events in other peripherals without software intervention. The hardware trigger is always enabled.

When	Then
The CMR is set to 0 with CSR[TFC] clear	The LPTMR hardware trigger asserts on the first compare and does not deassert.
The CMR is set to a nonzero value, or, if CSR[TFC] is set	The LPTMR hardware trigger asserts on each compare and deasserts on the following increment of the CNR.

Chapter 50

Real Time Clock (RTC)

50.1 Chip-specific RTC information

50.1.1 RTC instantiation

The wakeup pin is not available for RTC on this device, therefore the related register bitfields are not applicable (e.g. RTC_CR[WPS], RTC_CR[WPE], and RTC_IER[WPON]). Also there is no integrated capacitor for this device, therefore no tunable capacitors (included in the crystal oscillator) can be configured by software.

NOTE

There is no internal 32.768 kHz crystal oscillator available on this device. All references to 32.768 kHz clock in this chapter refers to RTC_CLK. See RTC clocking in [Table 27-9](#) for available clock sources.

NOTE

The read of the RTC registers is affected during EEERAM commands. For more information see note 'During execution of the SetRAM 0xFF' in [Chip-specific FTFC information](#).

50.1.2 RTC interrupts

Interrupts from RTC are enabled at reset as described in RTC_IER register. Interrupt may occur as soon as they are enabled in NVIC.

50.1.3 Software recommendation

Software reset should be provided to RTC before enabling it.

50.1.4 Multiple trigger

RTC is not able to generate multiple triggers in STOP and VLPS (via TRIGMUX). For instance, triggering LPIT in accumulator mode will not work due multiple trigger requirements. For other power modes, multiple triggers can be generated normally.

50.1.5 S32K11X to S32K14X difference

See [Differences between S32K14x/S32K14xW, and S32K11x](#), for differences arising out of CPU and interrupt latency impacting timed events when comparing S32K14X and S32K11X variants.

50.2 Introduction

50.2.1 Features

The RTC module features include:

- 32-bit seconds counter with roll-over protection and 32-bit alarm
- 16-bit prescaler with compensation that can correct errors between 0.12 ppm and 3906 ppm
- Option to increment prescaler using a 1 kHz LPO (prescaler increments by 32 every clock edge)
- Register write protection
 - Lock register requires POR or software reset to enable write access
- Configurable 1, 2, 4, 8, 16, 32, 64 or 128 Hz square wave output with optional interrupt

50.2.2 Modes of operation

The RTC remains functional in all low power modes and can generate an interrupt to exit any low power mode.

50.2.3 RTC signal descriptions

Table 50-1. RTC signal descriptions

Signal	Description	I/O
RTC_CLKOUT	Prescaler square-wave output or RTC 32.768 kHz clock	O

50.2.3.1 RTC clock output

The RTC_CLKOUT signal can output either a square wave prescaler output (configurable to 1, 2, 4, 8, 16, 32, 64 or 128 Hz) or the RTC 32.768 kHz clock.

50.3 Register definition

All registers must be accessed using 32-bit writes and all register accesses incur three wait states.

Write accesses to any register by non-supervisor mode software, when the supervisor access bit in the control register is clear, will terminate with a bus error.

Read accesses by non-supervisor mode software complete as normal.

Writing to a register protected by the lock register does not generate a bus error, but the write will not complete.

50.3.1 RTC register descriptions

50.3.1.1 RTC memory map

RTC base address: 4003_D000h

Offset	Register	Width (In bits)	Access	Reset value
0h	RTC Time Seconds Register (TSR)	32	RW	0000_0000h
4h	RTC Time Prescaler Register (TPR)	32	RW	0000_0000h

Table continues on the next page...

Register definition

Offset	Register	Width (In bits)	Access	Reset value
8h	RTC Time Alarm Register (TAR)	32	RW	0000_0000h
Ch	RTC Time Compensation Register (TCR)	32	RW	0000_0000h
10h	RTC Control Register (CR)	32	RW	0000_0000h
14h	RTC Status Register (SR)	32	RW	0000_0001h
18h	RTC Lock Register (LR)	32	RW	0000_00FFh
1Ch	RTC Interrupt Enable Register (IER)	32	RW	0000_0007h

50.3.1.2 RTC Time Seconds Register (TSR)

50.3.1.2.1 Offset

Register	Offset
TSR	0h

50.3.1.2.2 Diagram

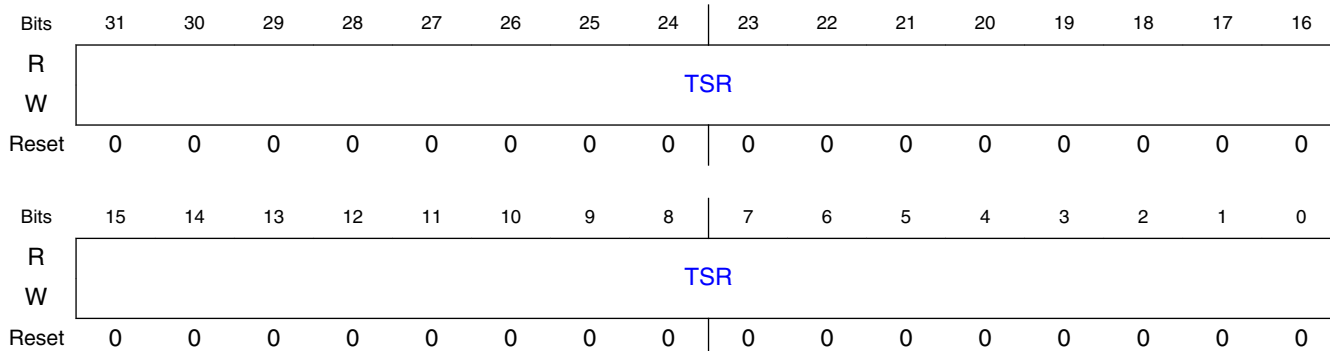

50.3.1.2.3 Fields

Field	Function
31-0	Time Seconds Register
TSR	When the time counter is enabled, the TSR is read only and increments once a second provided SR[TOF] or SR[TIF] are not set. The time counter will read as zero when SR[TOF] or SR[TIF] are set. When the time counter is disabled, the TSR can be read or written. Writing to the TSR when the time counter is disabled will clear the SR[TOF] and/or the SR[TIF]. Writing to TSR with zero is supported, but not recommended because TSR will read as zero when SR[TIF] or SR[TOF] are set (indicating the time is invalid).

50.3.1.3 RTC Time Prescaler Register (TPR)

50.3.1.3.1 Offset

Register	Offset
TPR	4h

50.3.1.3.2 Diagram

Bits	31	30	29	28	27	26	25	24	23	22	21	20	19	18	17	16
R	0															
W																
Reset	0	0	0	0	0	0	0	0	0	0	0	0	0	0	0	0
Bits	15	14	13	12	11	10	9	8	7	6	5	4	3	2	1	0
R	TPR															
W																
Reset	0	0	0	0	0	0	0	0	0	0	0	0	0	0	0	0

50.3.1.3.3 Fields

Field	Function
31-16 —	Reserved
15-0 TPR	Time Prescaler Register When the time counter is enabled, the TPR is read only and increments every 32.768 kHz clock cycle. The time counter will read as zero when SR[TOF] or SR[TIF] are set. When the time counter is disabled, the TPR can be read or written. The TSR[TSR] increments when bit 14 of the TPR transitions from a logic one to a logic zero.

50.3.1.4 RTC Time Alarm Register (TAR)

50.3.1.4.1 Offset

Register	Offset
TAR	8h

50.3.1.4.2 Diagram

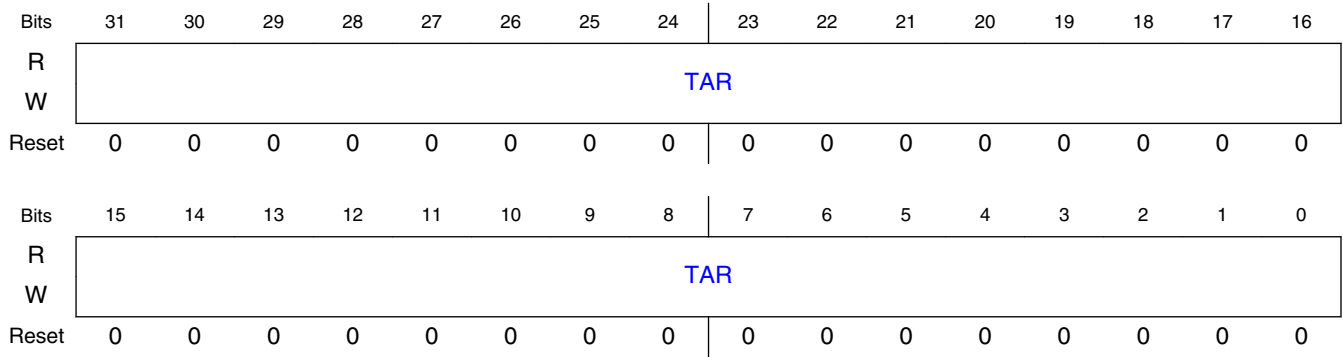

50.3.1.4.3 Fields

Field	Function
31-0	Time Alarm Register
TAR	When the time counter is enabled, the SR[TAF] is set whenever the TAR[TAR] equals the TSR[TSR] and the TSR[TSR] increments. Writing to the TAR clears the SR[TAF].

50.3.1.5 RTC Time Compensation Register (TCR)

50.3.1.5.1 Offset

Register	Offset
TCR	Ch

50.3.1.5.2 Diagram

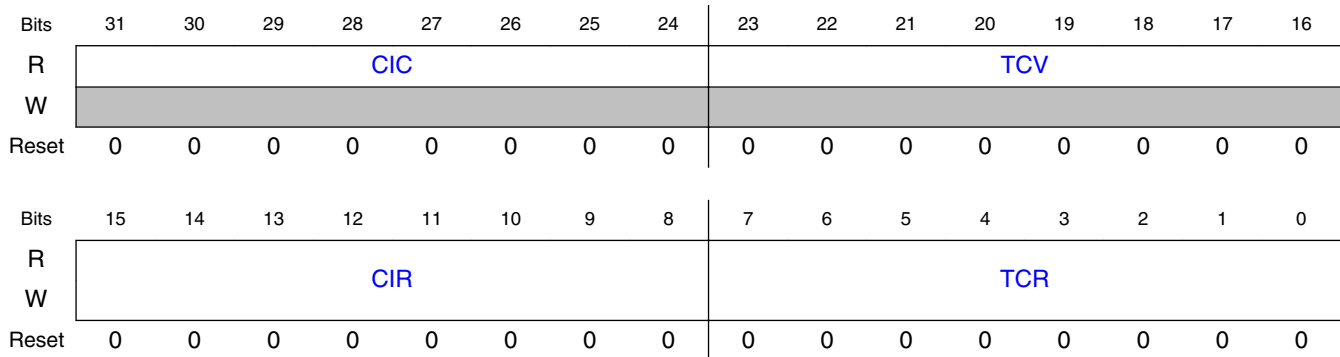

50.3.1.5.3 Fields

Field	Function
31-24 CIC	Compensation Interval Counter Current value of the compensation interval counter. If the compensation interval counter equals zero then it is loaded with the contents of the CIR. If the CIC does not equal zero then it is decremented once a second. Reading this register at the same time as the seconds counter is incrementing can result in an incorrect value being read.
23-16 TCV	Time Compensation Value Current value used by the compensation logic for the present second interval. Updated once a second if the CIC equals 0 with the contents of the TCR field. If the CIC does not equal zero then it is loaded with zero (compensation is not enabled for that second increment). Reading this register at the same time as the seconds counter is incrementing can result in an incorrect value being read.
15-8 CIR	Compensation Interval Register Configures the compensation interval in seconds from 1 to 256 to control how frequently the TCR should adjust the number of 32.768 kHz cycles in each second. The value written should be one less than the number of seconds. For example, write zero to configure for a compensation interval of one second. This register is double buffered and writes do not take affect until the end of the current compensation interval.
7-0 TCR	Time Compensation Register Configures the number of 32.768 kHz clock cycles in each second, equal to 32,768 - TCR (where TCR is a twos complement sign extended value). This register is double buffered and writes do not take affect until the end of the current compensation interval. Some example values are show below. 00000000b - Time Prescaler Register overflows every 32768 clock cycles. 00000001b - Time Prescaler Register overflows every 32767 clock cycles. 01111110b - Time Prescaler Register overflows every 32642 clock cycles. 01111111b - Time Prescaler Register overflows every 32641 clock cycles. 10000000b - Time Prescaler Register overflows every 32896 clock cycles. 10000001b - Time Prescaler Register overflows every 32895 clock cycles. 11111111b - Time Prescaler Register overflows every 32769 clock cycles.

50.3.1.6 RTC Control Register (CR)

50.3.1.6.1 Offset

Register	Offset
CR	10h

50.3.1.6.2 Diagram

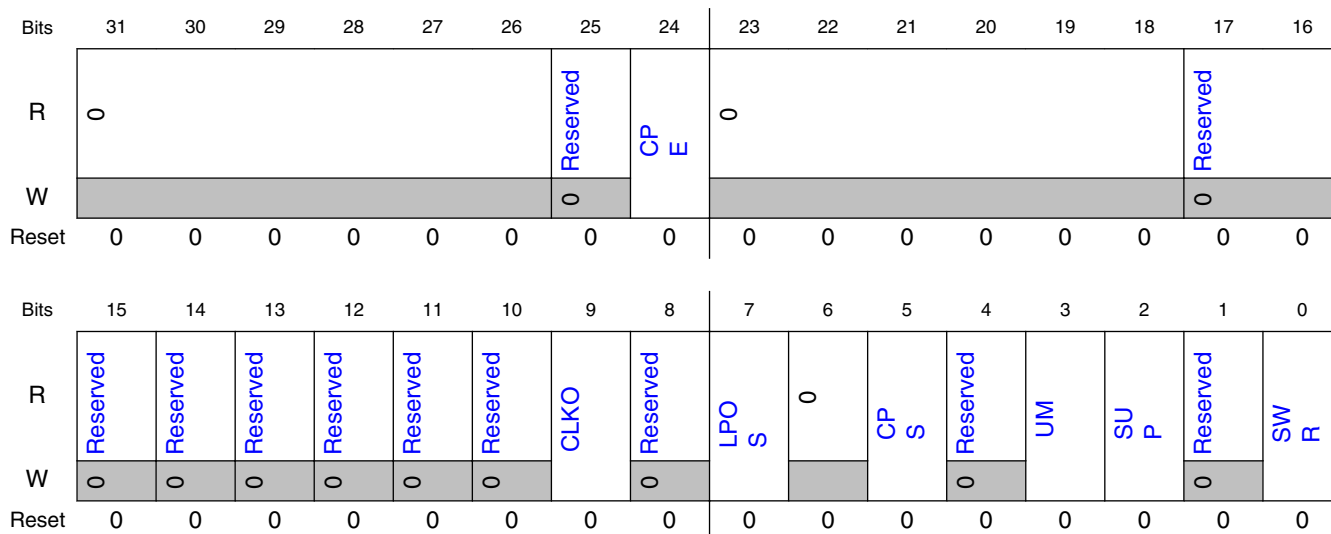

50.3.1.6.3 Fields

Field	Function
31-26 —	Reserved
25 —	Reserved
24 CPE	Clock Pin Enable 0b - The RTC_CLKOUT function is disabled. 1b - Enable RTC_CLKOUT function.
23-18 —	Reserved
17-16 —	Reserved
15 —	Reserved
14 —	Reserved

Table continues on the next page...

Field	Function
13 —	Reserved
12 —	Reserved
11 —	Reserved
10 —	Reserved
9 CLKO	Clock Output 0b - The 32 kHz clock is output to other peripherals. 1b - The 32 kHz clock is not output to other peripherals.
8 —	Reserved
7 LPOS	LPO Select When set, the RTC prescaler increments using the LPO 1 kHz clock and not the RTC 32.768 kHz clock. The LPO increments the prescaler from bit TPR[5] (TPR[4:0] are ignored), supporting close to 1 second increment of the seconds register. Although compensation is supported when clocked from the LPO, TCR[4:0] of the compensation register are also ignored and only TCR[7:5] set the compensation value (can overflow after 1020 to 1027 cycles). 0b - RTC prescaler increments using 32.768 kHz clock. 1b - RTC prescaler increments using 1 kHz LPO, bits [4:0] of the prescaler are ignored.
6 —	Reserved
5 CPS	Clock Pin Select 0b - The prescaler output clock (as configured by TSIC) is output on RTC_CLKOUT. 1b - The RTC 32.768 kHz clock is output on RTC_CLKOUT, provided it is output to other peripherals.
4 —	Reserved
3 UM	Update Mode Allows SR[TCE] to be written even when the Status Register is locked. When set, the SR[TCE] can be written if the SR[TIF] or SR[TOF] are set or if the SR[TCE] is clear. Whenever both SR[TCE] and CR[UM] are set, then SR[TCE] should only be written once either SR[TIF] or SR[TOF] are set. 0b - Registers cannot be written when locked. 1b - Registers can be written when locked under limited conditions.
2 SUP	Supervisor Access 0b - Non-supervisor mode write accesses are not supported and generate a bus error. 1b - Non-supervisor mode write accesses are supported.
1 —	Reserved
0 SWR	Software Reset 0b - No effect. 1b - Resets all RTC registers except for the SWR bit . The SWR bit is cleared by POR and by software explicitly clearing it.

50.3.1.7 RTC Status Register (SR)

50.3.1.7.1 Offset

Register	Offset
SR	14h

50.3.1.7.2 Diagram

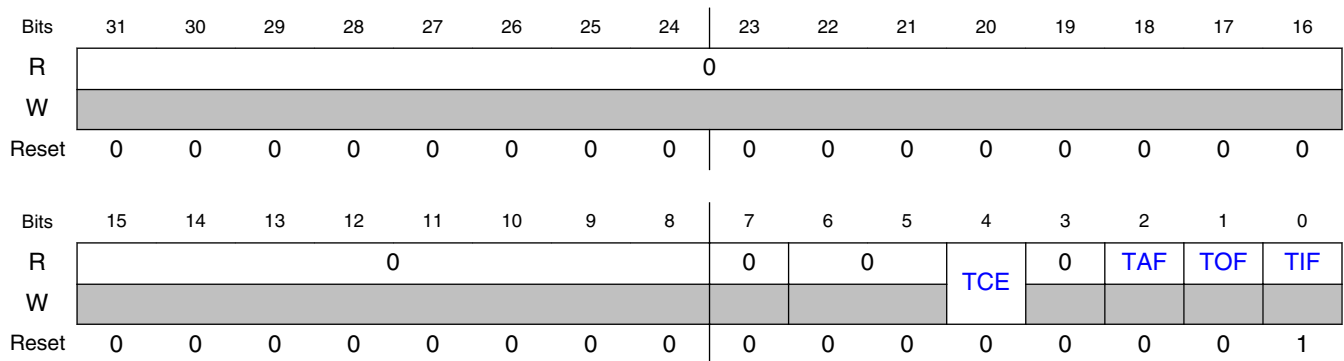

50.3.1.7.3 Fields

Field	Function
31-8 —	Reserved
7 —	Reserved
6-5 —	Reserved
4 TCE	Time Counter Enable When time counter is disabled the TSR register and TPR register are writeable, but do not increment. When time counter is enabled the TSR register and TPR register are not writeable, but increment. 0b - Time counter is disabled. 1b - Time counter is enabled.
3 —	Reserved
2 TAF	Time Alarm Flag Time alarm flag is set when the TAR[TAR] equals the TSR[TSR] and the TSR[TSR] increments. This bit is cleared by writing the TAR register.

Table continues on the next page...

Field	Function
	0b - Time alarm has not occurred. 1b - Time alarm has occurred.
1 TOF	Time Overflow Flag Time overflow flag is set when the time counter is enabled and overflows. The TSR and TPR do not increment and read as zero when this bit is set. This bit is cleared by writing the TSR register when the time counter is disabled. 0b - Time overflow has not occurred. 1b - Time overflow has occurred and time counter is read as zero.
0 TIF	Time Invalid Flag The time invalid flag is set on POR or software reset. The TSR and TPR do not increment and read as zero when this bit is set. This bit is cleared by writing the TSR register when the time counter is disabled. 0b - Time is valid. 1b - Time is invalid and time counter is read as zero.

50.3.1.8 RTC Lock Register (LR)

50.3.1.8.1 Offset

Register	Offset
LR	18h

50.3.1.8.2 Diagram

Bits	31	30	29	28	27	26	25	24	23	22	21	20	19	18	17	16
R	0															
W																
Reset	0	0	0	0	0	0	0	0	0	0	0	0	0	0	0	0
Bits	15	14	13	12	11	10	9	8	7	6	5	4	3	2	1	0
R	0								1						1	
W										LRL	SRL	CRL	TCL			
Reset	0	0	0	0	0	0	0	0	1	1	1	1	1	1	1	1

50.3.1.8.3 Fields

Field	Function
31-8	Reserved

Table continues on the next page...

Register definition

Field	Function
—	
7 —	Reserved
6 LRL	Lock Register Lock After being cleared, this bit can be set only by POR or software reset. 0b - Lock Register is locked and writes are ignored. 1b - Lock Register is not locked and writes complete as normal.
5 SRL	Status Register Lock After being cleared, this bit can be set only by POR or software reset. 0b - Status Register is locked and writes are ignored. 1b - Status Register is not locked and writes complete as normal.
4 CRL	Control Register Lock After being cleared, this bit can only be set by POR. 0b - Control Register is locked and writes are ignored. 1b - Control Register is not locked and writes complete as normal.
3 TCL	Time Compensation Lock After being cleared, this bit can be set only by POR or software reset. 0b - Time Compensation Register is locked and writes are ignored. 1b - Time Compensation Register is not locked and writes complete as normal.
2-0 —	Reserved

50.3.1.9 RTC Interrupt Enable Register (IER)

50.3.1.9.1 Offset

Register	Offset
IER	1Ch

50.3.1.9.2 Diagram

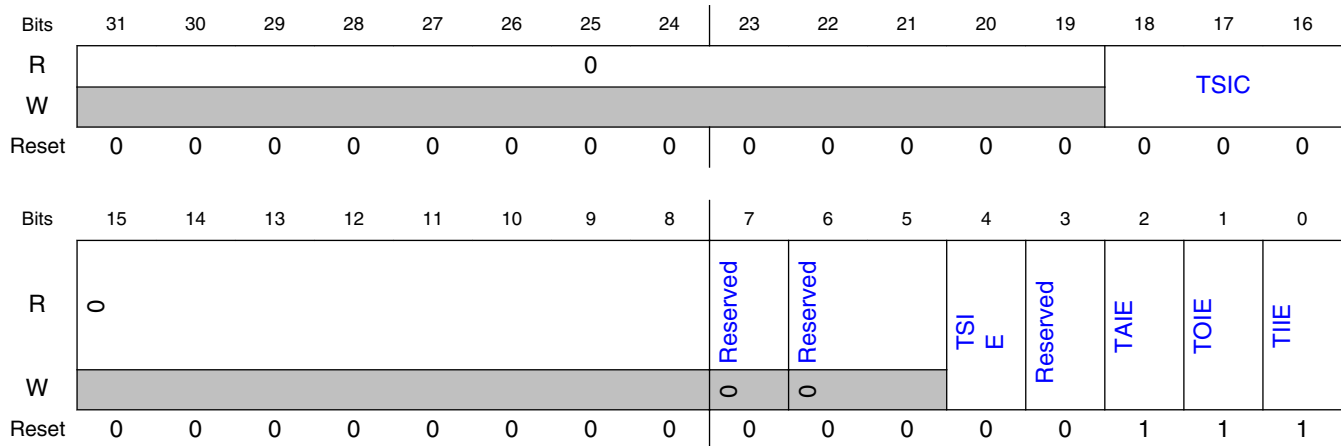

50.3.1.9.3 Fields

Field	Function
31-19 —	Reserved
18-16 TSIC	Timer Seconds Interrupt Configuration Configures the frequency of the RTC Seconds interrupt and the RTC_CLKOUT prescaler output. This field should only be altered when TSIE is clear. 000b - 1 Hz. 001b - 2 Hz. 010b - 4 Hz. 011b - 8 Hz. 100b - 16 Hz. 101b - 32 Hz. 110b - 64 Hz. 111b - 128 Hz.
15-8 —	Reserved
7 —	Reserved
6-5 —	Reserved
4 TSIE	Time Seconds Interrupt Enable The seconds interrupt is an edge-sensitive interrupt with a dedicated interrupt vector. It is generated at least once a second and requires no software overhead (there is no corresponding status flag to clear). The frequency of the seconds interrupt is configured by TSIC. 0b - Seconds interrupt is disabled. 1b - Seconds interrupt is enabled.
3 —	Reserved

Table continues on the next page...

Functional description

Field	Function
2 TAIE	Time Alarm Interrupt Enable 0b - Time alarm flag does not generate an interrupt. 1b - Time alarm flag does generate an interrupt.
1 TOIE	Time Overflow Interrupt Enable 0b - Time overflow flag does not generate an interrupt. 1b - Time overflow flag does generate an interrupt.
0 TIIE	Time Invalid Interrupt Enable 0b - Time invalid flag does not generate an interrupt. 1b - Time invalid flag does generate an interrupt.

50.4 Functional description

50.4.1 Power, clocking, and reset

The RTC is an always powered block that remains active in all low power modes.

The time counter within the RTC is clocked by default from a 32.768 kHz clock. Alternatively, the time counter can be clocked by a LPO 1 kHz clock and the prescaler will increment by 32 for each LPO clock.

The power-on-reset signal initializes all RTC registers to their default state. A software reset bit can also initialize all RTC registers.

50.4.1.1 Oscillator control

The 32.768 kHz crystal oscillator is disabled at POR and must be enabled by software. After enabling the crystal oscillator, wait the oscillator startup time before setting SR[TCE] or using the oscillator clock external to the RTC.

The crystal oscillator includes tunable capacitors that can be configured by software. Do not change the capacitance unless the oscillator is disabled.

50.4.1.2 Software reset

Writing 1 to CR[SWR] forces the equivalent of a POR to the rest of the RTC module. CR[SWR] is not affected by the software reset and must be cleared by software.

50.4.1.3 Supervisor access

When the supervisor access control bit is clear, only supervisor mode software can write to the RTC registers, non-supervisor mode software will generate a bus error. Both supervisor and non-supervisor mode software can always read the RTC registers.

50.4.2 Time counter

The time counter consists of a 32-bit seconds counter that increments once every second and a 16-bit prescaler register that increments once every 32.768 kHz clock cycle. There is also the option to clock the prescaler using a 1 kHz LPO that increments the prescaler by 32 on every clock cycle.

Reading the time counter (either seconds or prescaler) while it is incrementing may return invalid data due to synchronization of the read data bus. If it is necessary for software to read the prescaler or seconds counter when they could be incrementing, it is recommended that two read accesses are performed and that software verifies that the same data was returned for both reads.

The time seconds register and time prescaler register can be written only when SR[TCE] is clear. Always write to the prescaler register before writing to the seconds register, because the seconds register increments on the falling edge of bit 14 of the prescaler register.

The time prescaler register increments provided SR[TCE] is set, SR[TIF] is clear, SR[TOF] is clear, and the 32.768 kHz (or 1 kHz) clock source is present. After enabling the oscillator, wait the oscillator startup time before setting SR[TCE] to allow time for the oscillator clock output to stabilize.

If the time seconds register overflows then the SR[TOF] will set and the time prescaler register will stop incrementing. Clear SR[TOF] by initializing the time seconds register. The time seconds register and time prescaler register read as zero whenever SR[TOF] is set.

SR[TIF] is set on POR and software reset and is cleared by initializing the time seconds register. The time seconds register and time prescaler register read as zero whenever SR[TIF] is set.

50.4.3 Compensation

The compensation logic provides an accurate and wide compensation range and can correct errors as high as 3906 ppm and as low as 0.12 ppm. The compensation factor must be calculated externally to the RTC and supplied by software to the compensation register. The RTC itself does not calculate the amount of compensation that is required, although the 1 Hz clock is output to an external pin in support of external calibration logic.

Crystal compensation can be supported by using firmware and crystal characteristics to determine the compensation amount. Temperature compensation can be supported by firmware that periodically measures the external temperature via ADC and updates the compensation register based on a look-up table that specifies the change in crystal frequency over temperature.

The compensation logic alters the number of 32.768 kHz clock cycles it takes for the prescaler register to overflow and increment the time seconds counter. The time compensation value is used to adjust the number of clock cycles between -127 and +128. Cycles are added or subtracted from the prescaler register when the prescaler register equals 0x3FFF and then increments. The compensation interval is used to adjust the frequency at which the time compensation value is used, that is, from once a second to once every 256 seconds.

Updates to the time compensation register will not take effect until the next time the time seconds register increments and provided the previous compensation interval has expired. When the compensation interval is set to other than once a second then the compensation is applied in the first second interval and the remaining second intervals receive no compensation.

Compensation is disabled by configuring the time compensation register to zero.

When the prescaler is configured to increment using the 1 kHz LPO, the effective compensation value is divided by 32 and can only adjust the number of clock cycles between -4 and +3.

50.4.4 Time alarm

The Time Alarm register (TAR), SR[TAF], and IER[TAIE] allow the RTC to generate an interrupt at a predefined time. The 32-bit TAR is compared with the 32-bit Time Seconds register (TSR) each time it increments. SR[TAF] will set when TAR equals TSR and TSR increments.

SR[TAF] is cleared by writing TAR. This will usually be the next alarm value, although writing a value that is less than TSR, such as 0, will prevent SR[TAF] from setting again. SR[TAF] cannot otherwise be disabled, although the interrupt it generates is enabled or disabled by IER[TAIE].

50.4.5 Update mode

The Update Mode field in the Control register (CR[UM]) configures software write access to the Time Counter Enable (SR[TCE]) field. When CR[UM] is clear, SR[TCE] can be written only when LR[SRL] is set. When CR[UM] is set, SR[TCE] can also be written when SR[TCE] is clear or when SR[TIF] or SR[TOF] are set. This allows the time seconds and prescaler registers to be initialized whenever time is invalidated, while preventing the time seconds and prescaler registers from being changed on the fly. When LR[SRL] is set, CR[UM] has no effect on SR[TCE].

50.4.6 Register lock

The Lock register (LR) can be used to block write accesses to certain registers until the next POR or software reset. Locking the Control register (CR) will disable the software reset. Locking LR will block future updates to LR.

Write accesses to a locked register are ignored and do not generate a bus error.

50.4.7 Interrupt

The RTC interrupt is asserted whenever a status flag and the corresponding interrupt enable bit are both set. It is always asserted on POR, and software reset. The RTC interrupt is enabled at the chip level by enabling the chip-specific RTC clock gate control bit. The RTC interrupt can be used to wakeup the chip from any low-power mode.

The RTC seconds interrupt is an edge-sensitive interrupt with a dedicated interrupt vector that is generated once a second and requires no software overhead (there is no corresponding status flag to clear). It is enabled in the RTC by the time seconds interrupt enable bit and enabled at the chip level by setting the chip-specific RTC clock gate control bit. The frequency of the seconds interrupt defaults to 1 Hz, but can instead be configured to trigger every 2, 4, 8, 16, 32, 64 or 128 Hz.

Chapter 51

Low Power Serial Peripheral Interface (LPSPI)

51.1 Chip-specific LPSPI information

51.1.1 Instantiation Information

The following table summarizes the implementation of this module for each chip in the product series.

Table 51-1. LPSPI configuration

Chip	Instances	TX FIFO (word)	RX FIFO (word)	Chip selects
S32K116	LPSPi0	4	4	1
S32K118	LPSPi0	4	4	
	LPSPi1	4	4	
S32K142	LPSPi0	4	4	
	LPSPi1	4	4	
S32K144	LPSPi0	4	4	
	LPSPi1	4	4	
	LPSPi2	4	4	
S32K144W	LPSPi0	4	4	
	LPSPi1	4	4	
	LPSPi2	4	4	
S32K146	LPSPi0	4	4	
	LPSPi1	4	4	
	LPSPi2	4	4	
S32K148	LPSPi0	4	4	
	LPSPi1	4	4	
	LPSPi2	4	4	

1. The chip selects of LPSPI are package specific per S32K1xx variant. See tab 'PeripheralSummaries' of 'IO Signal Description Input Multiplexing' sheet attached to the Reference Manual for information on available chip selects.

The exact number of chip selects for each module depends on the package; not all chip selects are available on different packages. LPSPI2 does not support any TRGMUX-related feature, such as HREQ source from TRGMUX or any trigger to TRGMUX.

All documented LPSPI registers are present for all LPSPI instances on the device.

Low leakage and Wait modes are not supported in this device. See [Module operation in available power modes](#) for details on available power modes.

NOTE

Quad-data mode is not supported in S32K11x series of devices.

51.2 Introduction

The LPSPI is a low power Serial Peripheral Interface (SPI) module that supports an efficient interface to an SPI bus, either as a master and/or as a slave.

- The LPSPI is designed to use little CPU overhead, with DMA offloading of FIFO register accesses.
- The LPSPI can continue operating in stop modes, if an appropriate clock is available.
- The LPSPI supports DMA accesses and generates a DMA request.

The Serial Peripheral Interface bus (SPI) is a synchronous serial communication interface used in embedded systems, typically to perform short distance communications between microcontrollers and peripheral devices, on printed circuit boards. Typical applications include interfacing to Secure Digital cards and LCD displays.

- SPI devices communicate in full duplex mode using a master-slave scheme with a single master. This enables communication in both directions to happen simultaneously.
- Multiple slave devices are selected using individual slave select (SS) lines.
- The master device originates the frame for reading and writing.
- SPI accesses are always synchronous to the external clock.
- Each SPI can only assert one chip select at a time, but technically there can be multiple SPI slaves sharing the same chip select (in the form of a larger shift register). This requires:
 - the SDO of the master to connect to the SDI of the first slave,
 - the SDO of first slave to connect to the SDI of the next slave,
 - and the SDO of last slave to connect to the SDI of the LPSPI master.

Note that some SPI modules use MISO/MOSI for the input/output data.

51.2.1 Features

The LPSPI supports:

- Word size = 32 bits
- Configurable clock polarity and clock phase
- Master operation supporting up to 4 peripheral chip selects
- Slave operation
- Command/transmit FIFO of 4 words
- Receive FIFO of 4 words
- Flexible timing parameters in master mode, including SCK frequency and delays between PCS and SCK edges
- Support for full duplex transfers supporting 1-bit transmit and receive on each clock edge
- Support for half duplex transfers supporting 1-bit transmit or receive on each clock edge
- Support for half duplex transfers supporting 2-bit transmit or receive on each clock edge (master only)
- Support for half duplex transfers supporting 4-bit transmit or receive on each clock edge (master only)
- Host request can be used to control the start of a SPI bus transfer (master only)
- Receive data match logic supporting wakeup on data match

51.2.2 Block Diagram

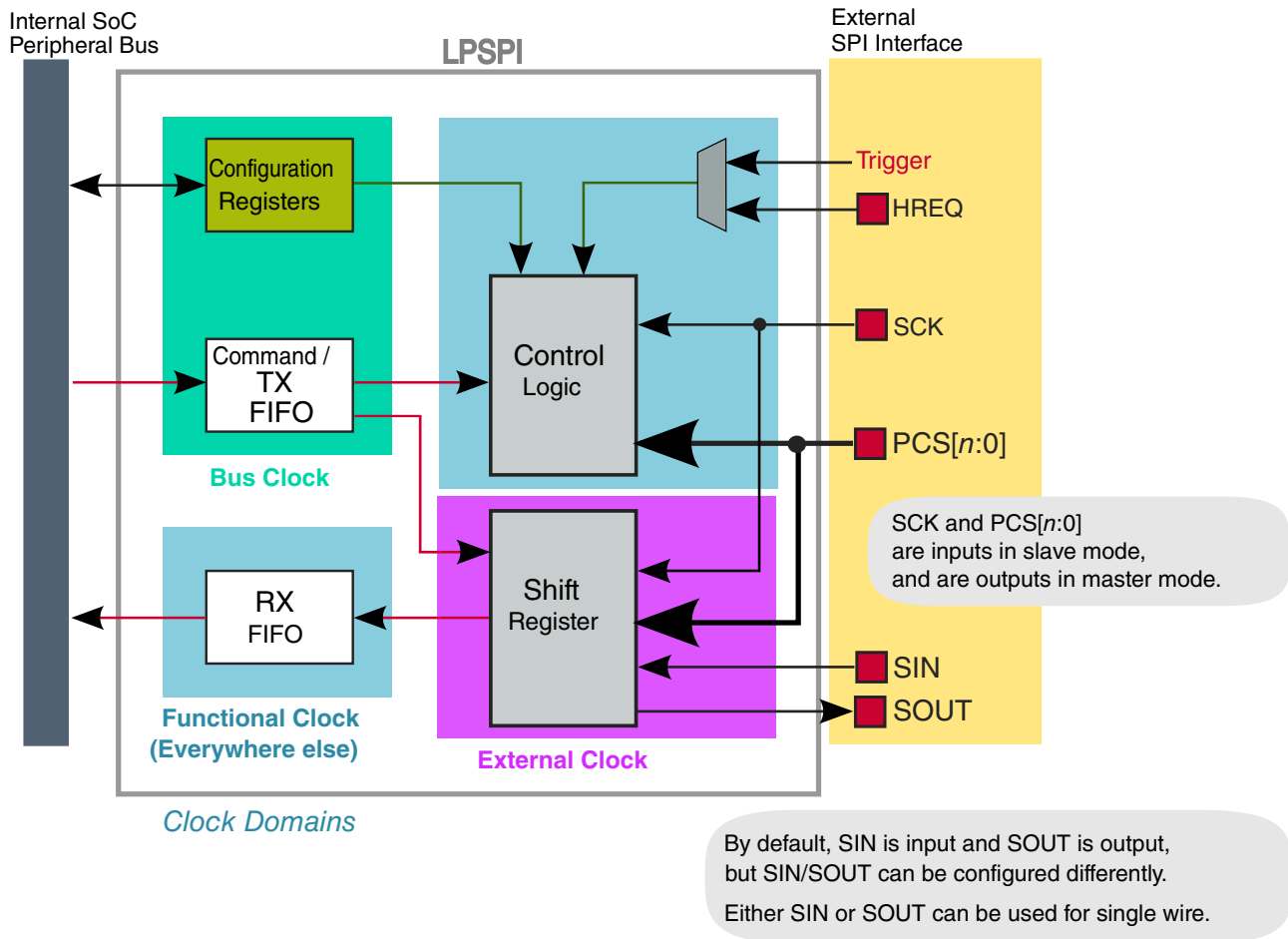

Figure 51-1. Block Diagram

51.2.3 Modes of operation

Table 51-2. Chip modes supported by the LPSPI module

Chip mode	LPSPI Operation
Run	Normal operation
Stop	Can continue operating in stop mode if the Doze Enable bit (CR[DOZEN]) is clear and the LPSPI is using an external or internal clock source that remains operating during stop mode.
Debug (the core is in Debug/Halted mode)	Can continue operating in debug mode, if the Debug Enable bit (CR[DBGEN]) is set.

51.2.4 Signal Descriptions

Table 51-3. Signals

Signal	Name	Description	I/O
SCK	Serial clock	<ul style="list-style-type: none"> Input in slave mode Output in master mode 	I/O
PCS[0]	Peripheral Chip Select	<ul style="list-style-type: none"> Input in slave mode Output in master mode 	I/O
PCS[1] / HREQ	Peripheral Chip Select or Host Request	Host Request pin is selected when HREN=1 and HRSEL=0 <ul style="list-style-type: none"> Input in either slave mode or when used as master Host Request Output in either master mode 	I/O
PCS[2] / DATA[2]	Peripheral Chip Select or data pin 2 during parallel data transfers	<ul style="list-style-type: none"> Input in slave mode Output in master mode Input in half-duplex parallel data receive transfers Output in half-duplex parallel data transmit transfers 	I/O
PCS[3] / DATA[3]	Peripheral Chip Select or data pin 3 during parallel data transfers	<ul style="list-style-type: none"> Input in slave mode Output in master mode Input in half-duplex parallel data receive transfers Output in half-duplex parallel data transmit transfers 	I/O
SOUT / DATA[0]	Serial Data Output	Can be configured as serial data input signal <ul style="list-style-type: none"> Used as data pin 0 in half-duplex parallel data transfers 	I/O
SIN / DATA[1]	Serial Data Input	Can be configured as serial data output signal <ul style="list-style-type: none"> Used as data pin 1 in half-duplex parallel data transfers 	I/O

51.3 Memory Map and Registers

NOTE

Writing a Read-Only (RO) register or reading a Write-Only (WO) register can cause bus errors. This module will not check if programmed values in the registers are correct; the application software must ensure that valid programmed values are being written.

51.3.1 LPSPI register descriptions

51.3.1.1 LPSPI memory map

LPSPi0 base address: 4002_C000h

LPSPi1 base address: 4002_D000h

LPSPi2 base address: 4002_E000h

Offset	Register	Width (In bits)	Access	Reset value
0h	Version ID Register (VERID)	32	RO	0100_0004h
4h	Parameter Register (PARAM)	32	RO	0000_0202h
10h	Control Register (CR)	32	RW	0000_0000h
14h	Status Register (SR)	32	W1C	0000_0001h
18h	Interrupt Enable Register (IER)	32	RW	0000_0000h
1Ch	DMA Enable Register (DER)	32	RW	0000_0000h
20h	Configuration Register 0 (CFGR0)	32	RW	0000_0000h
24h	Configuration Register 1 (CFGR1)	32	RW	0000_0000h
30h	Data Match Register 0 (DMR0)	32	RW	0000_0000h
34h	Data Match Register 1 (DMR1)	32	RW	0000_0000h
40h	Clock Configuration Register (CCR)	32	RW	0000_0000h
58h	FIFO Control Register (FCR)	32	RW	0000_0000h
5Ch	FIFO Status Register (FSR)	32	RO	0000_0000h
60h	Transmit Command Register (TCR)	32	RW	0000_001Fh
64h	Transmit Data Register (TDR)	32	WO	0000_0000h
70h	Receive Status Register (RSR)	32	RO	0000_0002h
74h	Receive Data Register (RDR)	32	RO	0000_0000h

51.3.1.2 Version ID Register (VERID)

51.3.1.2.1 Offset

Register	Offset
VERID	0h

51.3.1.2.2 Function

Contains version numbers for the module design and feature set.

51.3.1.2.3 Diagram

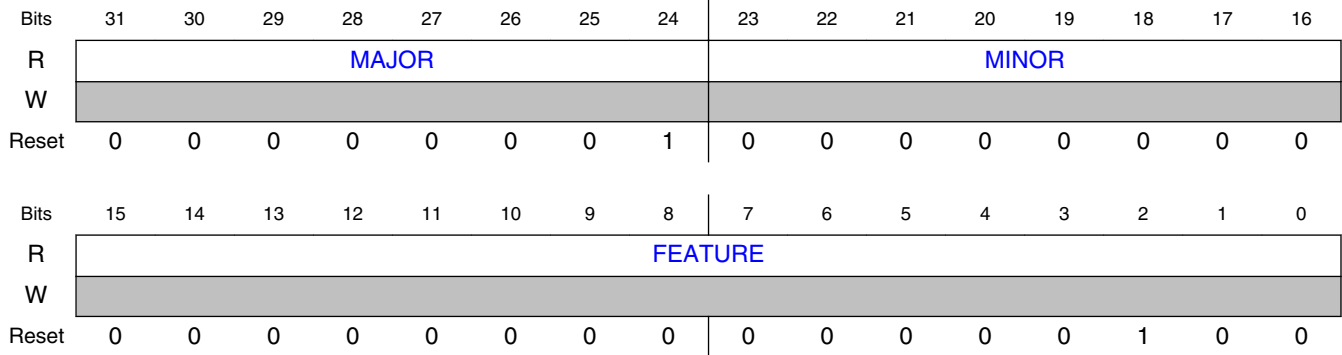

51.3.1.2.4 Fields

Field	Function
31-24 MAJOR	Major Version Number Returns the major version number for the module specification. Read-only field.
23-16 MINOR	Minor Version Number Returns the minor version number for the module specification. Read-only field.
15-0 FEATURE	Module Identification Number Returns the feature set number. Read-only field. 0000000000000100b - Standard feature set supporting a 32-bit shift register.

51.3.1.3 Parameter Register (PARAM)

51.3.1.3.1 Offset

Register	Offset
PARAM	4h

51.3.1.3.2 Function

Contains parameter values that were implemented in the module.

51.3.1.3.3 Diagram

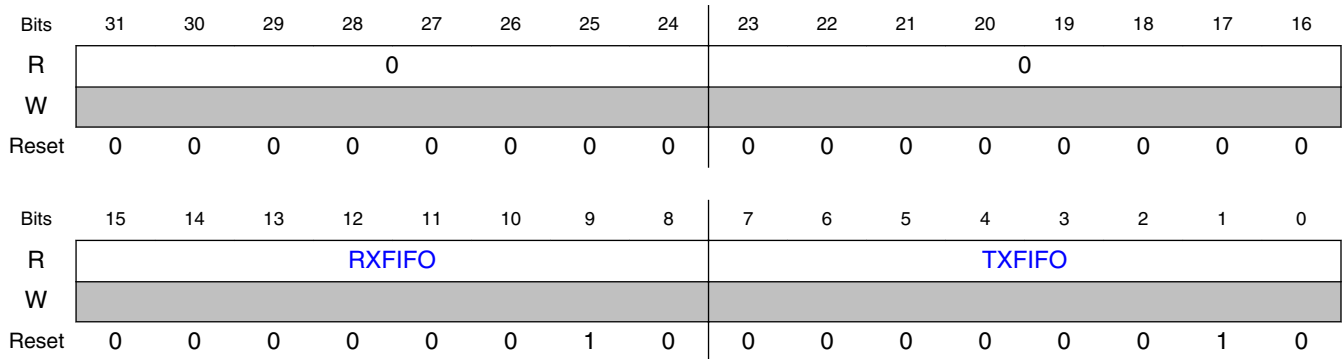

51.3.1.3.4 Fields

Field	Function
31-24 —	Reserved
23-16 —	Reserved
15-8 RXFIFO	Receive FIFO Size Sets the maximum number of words in the receive FIFO, which is 2^{RXFIFO}
7-0 TXFIFO	Transmit FIFO Size Sets the maximum number of words in the transmit FIFO, which is 2^{TXFIFO}

51.3.1.4 Control Register (CR)

51.3.1.4.1 Offset

Register	Offset
CR	10h

51.3.1.4.2 Function

The Control register contains fields associated with the module operation.

51.3.1.4.3 Diagram

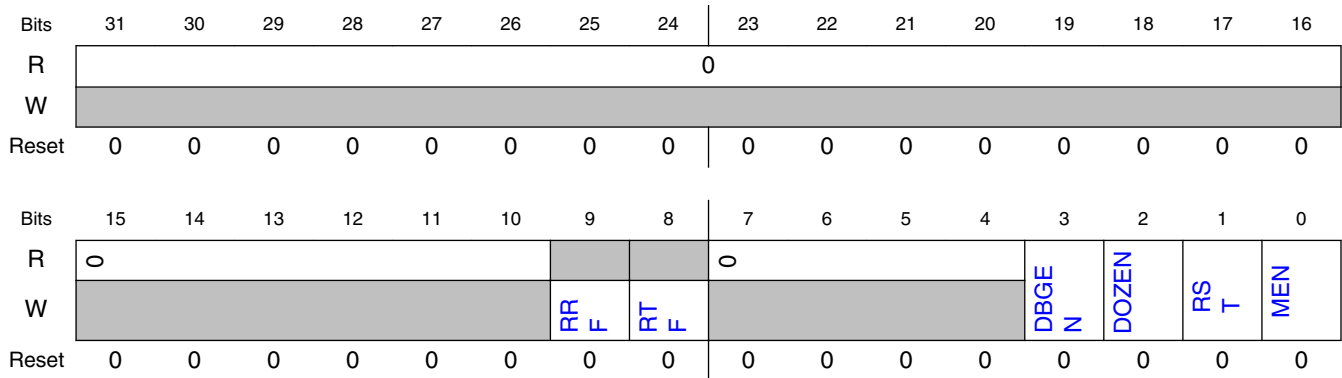

51.3.1.4.4 Fields

Field	Function
31-10 —	Reserved
9 RRF	Reset Receive FIFO 0b - No effect 1b - Receive FIFO is reset
8 RTF	Reset Transmit FIFO 0b - No effect 1b - Transmit FIFO is reset
7-4 —	Reserved
3 DBGEN	Debug Enable Enables or disables the LPSPI module in debug mode. Debug Enable bit should be updated only when the LPSPI module is disabled. 0b - LPSPI module is disabled in debug mode 1b - LPSPI module is enabled in debug mode
2 DOZEN	Doze Mode Enable Enables or disables the LPSPI module in Doze mode. Doze Mode Enable bit should be updated only when the LPSPI module is disabled. 0b - LPSPI module is enabled in Doze mode 1b - LPSPI module is disabled in Doze mode
1 RST	Software Reset Reset all internal logic and registers, except the Control Register. RST remains set until cleared by software. The reset takes effect immediately and remains asserted until negated by software. There is no minimum delay required before clearing the software reset. 0b - Module is not reset 1b - Module is reset
0 MEN	Module Enable 0b - Module is disabled 1b - Module is enabled

51.3.1.5 Status Register (SR)

51.3.1.5.1 Offset

Register	Offset
SR	14h

51.3.1.5.2 Function

The Status register contains the status of data flow.

51.3.1.5.3 Diagram

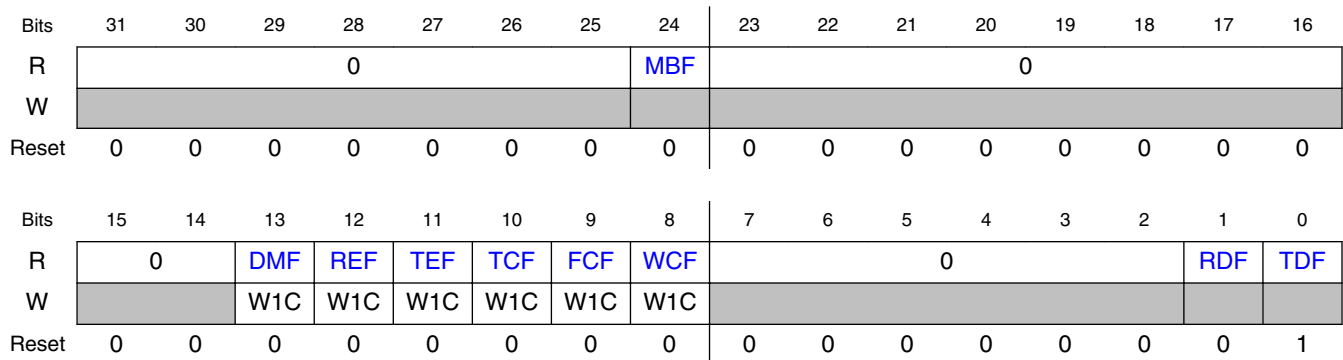

51.3.1.5.4 Fields

Field	Function
31-25 —	Reserved
24 MBF	Module Busy Flag 0b - LPSPI is idle 1b - LPSPI is busy
23-14 —	Reserved
13 DMF	Data Match Flag Indicates that the received data has matched the MATCH0 and/or MATCH1 fields (as configured by CFGR1[MATCFG], Configuration Register 1). 0b - Have not received matching data 1b - Have received matching data
12	Receive Error Flag

Table continues on the next page...

Field	Function
REF	The Receive Error Flag will set when the Receiver FIFO overflows. When the Receive Error Flag is set, it is recommended to first end the transfer, empty the Receive FIFO, clear the Receive Error Flag and then restart the transfer from the beginning. 0b - Receive FIFO has not overflowed 1b - Receive FIFO has overflowed
11 TEF	Transmit Error Flag The Transmit Error Flag will set when the Transmit FIFO underruns. When the Transmit Error Flag is set, it is recommended to first end the transfer, clear the Transmit Error Flag and then restart the transfer from the beginning. 0b - Transmit FIFO underrun has not occurred 1b - Transmit FIFO underrun has occurred
10 TCF	Transfer Complete Flag In master mode when the LPSPI returns to idle state with the transmit FIFO empty, the Transfer Complete Flag will set. 0b - All transfers have not completed 1b - All transfers have completed
9 FCF	Frame Complete Flag The Frame Complete Flag will set at the end of each frame transfer, when the PCS negates. 0b - Frame transfer has not completed 1b - Frame transfer has completed
8 WCF	Word Complete Flag The Word Complete Flag will set when the last bit of a received word is sampled. 0b - Transfer of a received word has not yet completed 1b - Transfer of a received word has completed
7-2 —	Reserved
1 RDF	Receive Data Flag The Receive Data Flag is set whenever the number of words in the receive FIFO is greater than FCR[RXWATER] (FIFO Control Register) 0b - Receive Data is not ready 1b - Receive data is ready
0 TDF	Transmit Data Flag The Transmit Data Flag is set whenever the number of words in the transmit FIFO is equal or less than FCR[TXWATER] (FIFO Control Register) 0b - Transmit data not requested 1b - Transmit data is requested

51.3.1.6 Interrupt Enable Register (IER)

51.3.1.6.1 Offset

Register	Offset
IER	18h

51.3.1.6.2 Function

The Interrupt Enable register contains fields to enable interrupts based on data flow and errors.

51.3.1.6.3 Diagram

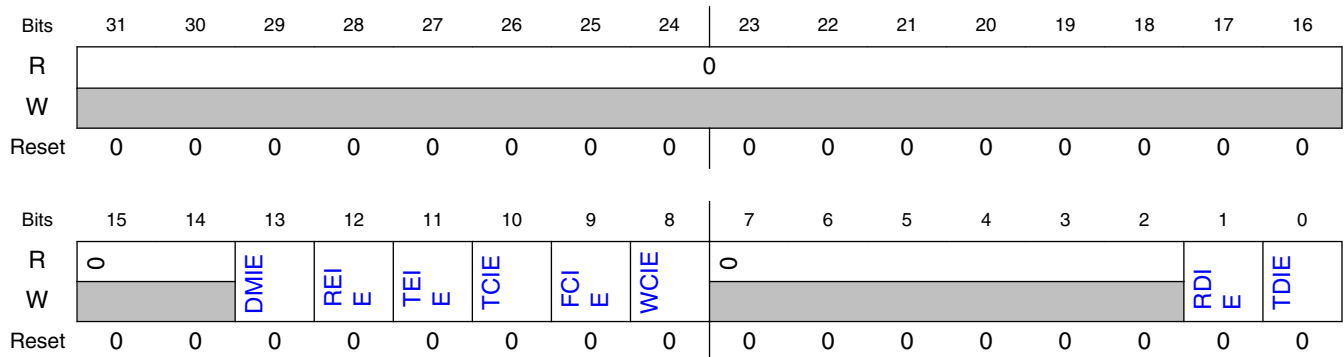

51.3.1.6.4 Fields

Field	Function
31-14 —	Reserved
13 DMIE	Data Match Interrupt Enable 0b - Disabled 1b - Enabled
12 REIE	Receive Error Interrupt Enable 0b - Disabled 1b - Enabled
11 TEIE	Transmit Error Interrupt Enable 0b - Disabled 1b - Enabled
10 TCIE	Transfer Complete Interrupt Enable 0b - Disabled 1b - Enabled
9 FCIE	Frame Complete Interrupt Enable 0b - Disabled 1b - Enabled
8 WCIE	Word Complete Interrupt Enable 0b - Disabled 1b - Enabled
7-2 —	Reserved
1	Receive Data Interrupt Enable 0b - Disabled

Table continues on the next page...

Field	Function
RDIE	1b - Enabled
0	Transmit Data Interrupt Enable
TDIE	0b - Disabled 1b - Enabled

51.3.1.7 DMA Enable Register (DER)

51.3.1.7.1 Offset

Register	Offset
DER	1Ch

51.3.1.7.2 Function

The DMA Enable register contains fields to enable DMA data flow.

51.3.1.7.3 Diagram

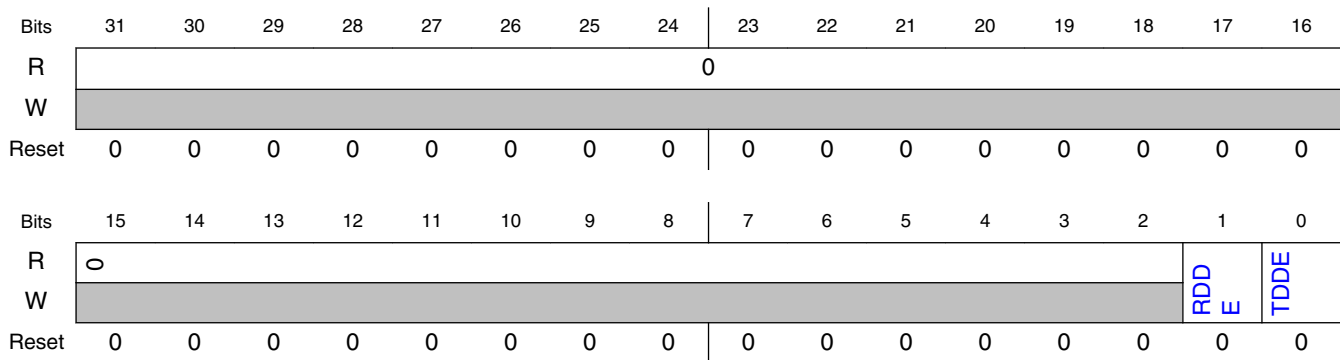

51.3.1.7.4 Fields

Field	Function
31-2	Reserved
—	
1	Receive Data DMA Enable
RDDE	0b - DMA request is disabled 1b - DMA request is enabled
0	Transmit Data DMA Enable

Memory Map and Registers

Field	Function
TDDE	0b - DMA request is disabled 1b - DMA request is enabled

51.3.1.8 Configuration Register 0 (CFGR0)

51.3.1.8.1 Offset

Register	Offset
CFGR0	20h

51.3.1.8.2 Function

The CFGR0 register includes additional fields to configure the LPSPI including Circular FIFO Enable and Receive Data Match Only.

51.3.1.8.3 Diagram

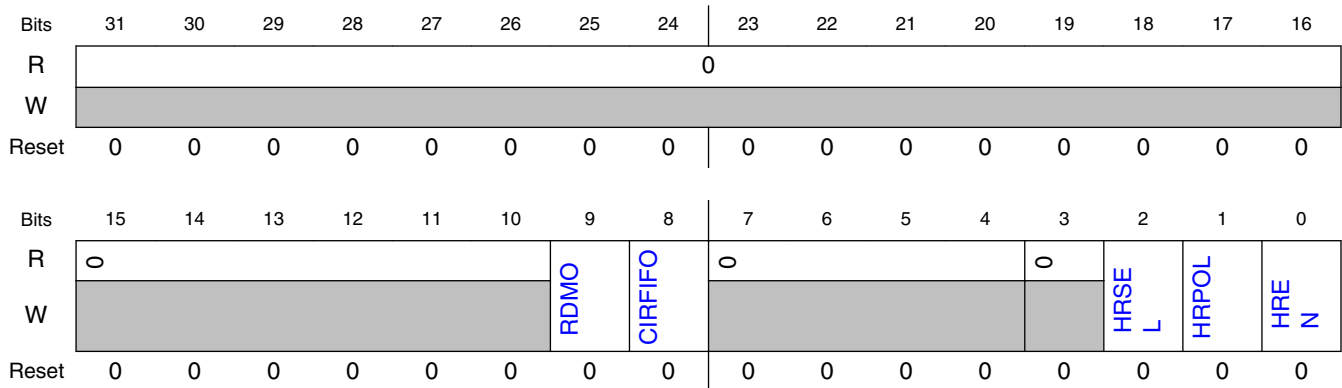

51.3.1.8.4 Fields

Field	Function
31-10 —	Reserved
9 RDMO	Receive Data Match Only When Receive Data Match Only is enabled, all received data that does not cause the Data Match Flag (SR[DMF]) to set is discarded. <ul style="list-style-type: none"> Receive Data Match Only bit should be set when the LPSPI is idle and the Data Match Flag is clear

Table continues on the next page...

Field	Function
	<ul style="list-style-type: none"> After the Data Match Flag (DMF) is set, the Receive Data Match Only bit configuration is ignored When disabling RDMO and to ensure that no receive data is lost, before clearing the Data Match Flag, first clear Receive Data Match Only (RDMO) <p>0b - Received data is stored in the receive FIFO as in normal operations 1b - Received data is discarded unless the Data Match Flag (DMF) is set</p>
8 CIRFIFO	<p>Circular FIFO Enable</p> <p>When enabled, the transmit FIFO read pointer is saved to a temporary register. The transmit FIFO will be emptied as it normally is, but after the LPSPI is idle and the transmit FIFO is empty, then the read pointer value will be restored from the temporary register. This restoring of the read pointer will cause the contents of the transmit FIFO to be cycled through repeatedly.</p> <p>0b - Circular FIFO is disabled 1b - Circular FIFO is enabled</p>
7-4 —	Reserved
3 —	Reserved
2 HRSEL	<p>Host Request Select</p> <p>Selects the source of the host request input. When the host request function is enabled with the LPSPI_HREQ pin, the LPSPI_PCS[1] function is disabled.</p> <p>0b - Host request input is the LPSPI_HREQ pin 1b - Host request input is the input trigger</p>
1 HRPOL	<p>Host Request Polarity</p> <p>Configures the polarity of the host request pin.</p> <p>0b - LPSPI_HREQ pin is active low 1b - LPSPI_HREQ pin is active high</p>
0 HREN	<p>Host Request Enable</p> <p>When enabled in master mode, the LPSPI will only start a new SPI bus transfer if the host request input is asserted. When the LPSPI is busy, the host request input is ignored.</p> <p>0b - Host request is disabled 1b - Host request is enabled</p>

51.3.1.9 Configuration Register 1 (CFGR1)

51.3.1.9.1 Offset

Register	Offset
CFGR1	24h

51.3.1.9.2 Function

The CFGR1 should only be written when the LPSPI is disabled.

51.3.1.9.3 Diagram

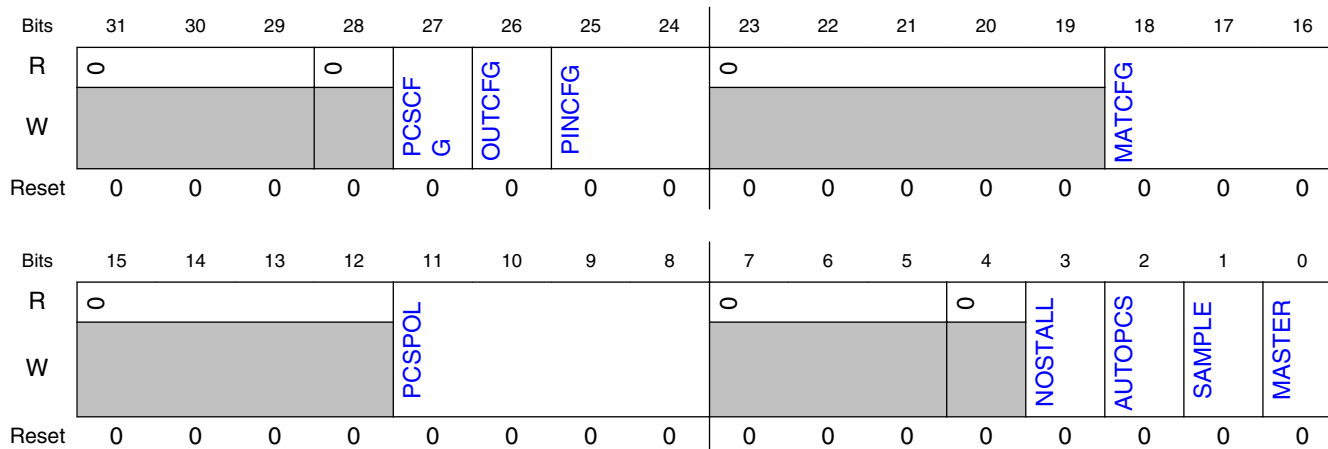

51.3.1.9.4 Fields

Field	Function
31-29 —	Reserved
28 —	Reserved
27 PCSCFG	Peripheral Chip Select Configuration When performing parallel transfers, the Peripheral Chip Select Configuration must be configured to enable the desired transfer. 0b - PCS[3:2] are configured for chip select function 1b - PCS[3:2] are configured for half-duplex 4-bit transfers (PCS[3:2] = DATA[3:2])
26 OUTCFG	Output Configuration Configures if the output data is tristated between accesses (LPSPi_PCS is negated). If performing half-duplex transfers, the Output Configuration bit must be set. 0b - Output data retains last value when chip select is negated 1b - Output data is tristated when chip select is negated
25-24 PINCFG	Pin Configuration Configures which pins are used for input and output data during serial transfers. If performing parallel transfers, the Pin Configuration field must be 00. 00b - SIN is used for input data and SOUT is used for output data 01b - SIN is used for both input and output data, only half-duplex serial transfers are supported 10b - SOUT is used for both input and output data, only half-duplex serial transfers are supported 11b - SOUT is used for input data and SIN is used for output data
23-19 —	Reserved
18-16 MATCFG	Match Configuration Configures the condition that will cause the DMF to set.

Table continues on the next page...

Field	Function
	<p>NOTE: <i>Syntax:</i> * is boolean AND, + is boolean OR</p> <p>000b - Match is disabled 001b - Reserved 010b - 010b - Match is enabled, if 1st data word equals MATCH0 OR MATCH1, i.e., (1st data word = MATCH0 + MATCH1) 011b - 011b - Match is enabled, if any data word equals MATCH0 OR MATCH1, i.e., (any data word = MATCH0 + MATCH1) 100b - 100b - Match is enabled, if 1st data word equals MATCH0 AND 2nd data word equals MATCH1, i.e., [(1st data word = MATCH0) * (2nd data word = MATCH1)] 101b - 101b - Match is enabled, if any data word equals MATCH0 AND the next data word equals MATCH1, i.e., [(any data word = MATCH0) * (next data word = MATCH1)] 110b - 110b - Match is enabled, if (1st data word AND MATCH1) equals (MATCH0 AND MATCH1), i.e., [(1st data word * MATCH1) = (MATCH0 * MATCH1)] 111b - 111b - Match is enabled, if (any data word AND MATCH1) equals (MATCH0 AND MATCH1), i.e., [(any data word * MATCH1) = (MATCH0 * MATCH1)]</p>
15-12 —	Reserved
11-8 PCSPOL	<p>Peripheral Chip Select Polarity</p> <p>Configures the polarity of each Peripheral Chip Select pin. Each PCSPOL bit position (let's call it <i>n</i>) corresponds to a PCS[<i>n</i>] pin. For example, PCSPOL[0] is chip select 0 (at PCS[0] pin), and PCSPOL[1] is chip select 1 (at PCS[1] pin). If a PCSPOL bit:</p> <ul style="list-style-type: none"> • =0, then the PCS[<i>n</i>] pin is active low. • =1, then the PCS[<i>n</i>] pin is active high. <p>NOTE: The entire PCSPOL field is not fully supported in every LPSPI module instance. Refer to the chip-specific information for LPSPI.</p>
7-5 —	Reserved
4 —	Reserved
3 NOSTALL	<p>No Stall</p> <p>In master mode, the LPSPI will stall transfers when the transmit FIFO is empty, ensuring that no transmit FIFO underrun can occur. Setting the No Stall bit will disable this functionality.</p> <p>0b - Transfers will stall when the transmit FIFO is empty 1b - Transfers will not stall, allowing transmit FIFO underruns to occur</p>
2 AUTOPCS	<p>Automatic PCS</p> <p>For correct operations, the LPSPI slave normally requires the PCS to negate between frames. Setting the Automatic PCS bit will cause the LPSPI to generate an internal PCS signal at the end of each transfer word when the Clock Phase bit TCR[CPHA] = 1.</p> <ul style="list-style-type: none"> • When the Automatic PCS bit is set, the SCK must remain idle for at least 4 LPSPI functional clock cycles (divided by the Prescaler Value TCR[PRESCALE] configuration) between each word, to ensure correct operations • In master mode, the Automatic PCS bit is ignored <p>0b - Automatic PCS generation is disabled 1b - Automatic PCS generation is enabled</p>
1 SAMPLE	<p>Sample Point</p> <p>When set, the LPSPI master will sample the input data on a delayed LPSPI_SCK edge, which improves the setup time when sampling data.</p>

Table continues on the next page...

Memory Map and Registers

Field	Function
	<ul style="list-style-type: none"> The input data setup time in master mode with delayed LPSPi_SCK edge is equal to the input data setup time in slave mode In slave mode, the SAMPLE bit is ignored <p>0b - Input data is sampled on SCK edge 1b - Input data is sampled on delayed SCK edge</p>
0 MASTER	<p>Master Mode</p> <p>Configures the LPSPi in master or slave mode. The Master Mode bit directly controls the direction of the LPSPi_SCK and LPCPI_PCS pins.</p> <p>0b - Slave mode 1b - Master mode</p>

51.3.1.10 Data Match Register 0 (DMR0)

51.3.1.10.1 Offset

Register	Offset
DMR0	30h

51.3.1.10.2 Function

For the Data Match register to be available, set CFGR0[RDMO] = 1.

51.3.1.10.3 Diagram

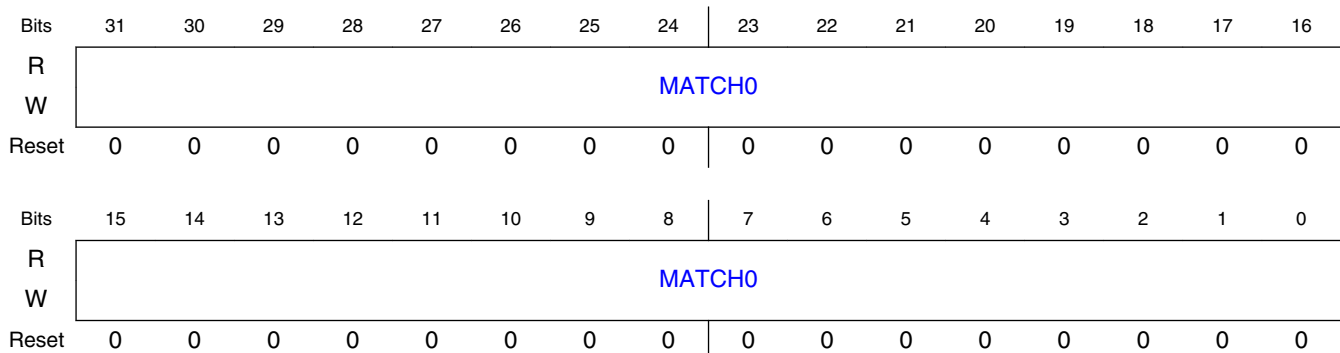

51.3.1.10.4 Fields

Field	Function
31-0	Match 0 Value

Field	Function
MATCH0	When Receive Data Match Only (CFGR0[RDMO]) is enabled, the Match 0 Value is compared against the received data.

51.3.1.11 Data Match Register 1 (DMR1)

51.3.1.11.1 Offset

Register	Offset
DMR1	34h

51.3.1.11.2 Function

The DMR1 register use depends on setting CFGR0[RDMO] = 1.

51.3.1.11.3 Diagram

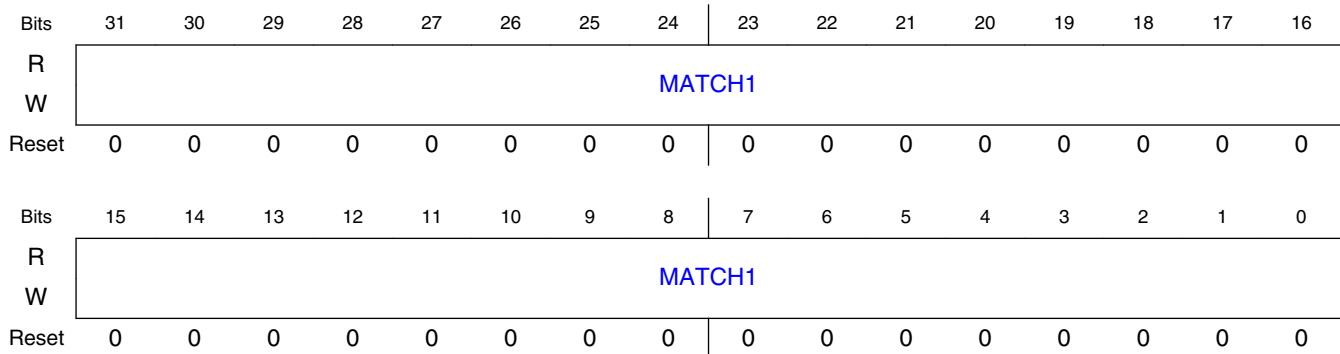

51.3.1.11.4 Fields

Field	Function
31-0	Match 1 Value
MATCH1	When Receive Data Match Only (CFGR0[RDMO]) is enabled, the Match 1 Value is compared against the received data.

51.3.1.12 Clock Configuration Register (CCR)

51.3.1.12.1 Offset

Register	Offset
CCR	40h

51.3.1.12.2 Function

The Clock Configuration Register is only used in master mode, and the Clock Configuration Register cannot be changed when the LPSPI is enabled.

51.3.1.12.3 Diagram

Bits	31	30	29	28	27	26	25	24	23	22	21	20	19	18	17	16
R	SCKPCS								PCSSCK							
W																
Reset	0	0	0	0	0	0	0	0	0	0	0	0	0	0	0	0
Bits	15	14	13	12	11	10	9	8	7	6	5	4	3	2	1	0
R	DBT								SCKDIV							
W																
Reset	0	0	0	0	0	0	0	0	0	0	0	0	0	0	0	0

51.3.1.12.4 Fields

Field	Function
31-24 SCKPCS	<p>SCK-to-PCS Delay</p> <p>In master mode: configures the delay from the last SCK edge to the PCS negation.</p> <ul style="list-style-type: none"> The delay is equal to (SCKPCS + 1) cycles of the LPSPI functional clock divided by the Prescaler Value TCR[PRESCALE] configuration. The minimum delay is 1 cycle.
23-16 PCSSCK	<p>PCS-to-SCK Delay</p> <p>In master mode: configures the delay from the PCS assertion to the first SCK edge.</p> <ul style="list-style-type: none"> The delay is equal to (PCSSCK + 1) cycles of the LPSPI functional clock divided by the Prescaler Value TCR[PRESCALE] configuration. The minimum delay is 1 cycle.
15-8 DBT	<p>Delay Between Transfers</p> <p>In master mode:</p> <ul style="list-style-type: none"> Configures the delay from the PCS negation to the next PCS assertion. <ul style="list-style-type: none"> The delay is equal to (DBT + 2) cycles of the LPSPI functional clock divided by the Prescaler Value TCR[PRESCALE] configuration.

Table continues on the next page...

Field	Function
	<ul style="list-style-type: none"> The minimum delay is 2 cycles. Half of the delay occurs before PCS assertion and the other half of the delay occurs after PCS negation. If the command word is updated between 2 transfers, then the command word is updated half-way between the PCS negation of the last transfer and PCS assertion of the next transfer. The command word sets which PCS signal is used (of PCS[3:0]), the polarity/phase of the SCK signal, and the Prescaler Value. Configures the delay from the last SCK edge of a transfer word and the first SCK edge of the next transfer word, in a continuous transfer. <ul style="list-style-type: none"> The delay is equal to $(DBT + 1)$ cycles of the LPSPi functional clock divided by the Prescaler Value TCR[PRESCALE] configuration. The minimum delay is 1 cycle.
7-0 SCKDIV	<p>SCK Divider</p> <p>In master mode, the SCK Divider configures the divide ratio of the SCK pin.</p> <ul style="list-style-type: none"> The SCK period is equal to $(SCKDIV+2)$ cycles of the LPSPi functional clock divided by the Prescaler Value TCR[PRESCALE] configuration. The minimum SCK period is 2 cycles. If the SCK period is an odd number of cycles, then the 1st half of the SCK period will be 1 cycle longer than the 2nd half of the SCK period.

51.3.1.13 FIFO Control Register (FCR)

51.3.1.13.1 Offset

Register	Offset
FCR	58h

51.3.1.13.2 Function

The FIFO Control register contains the RXWATER and TXWATER control fields.

51.3.1.13.3 Diagram

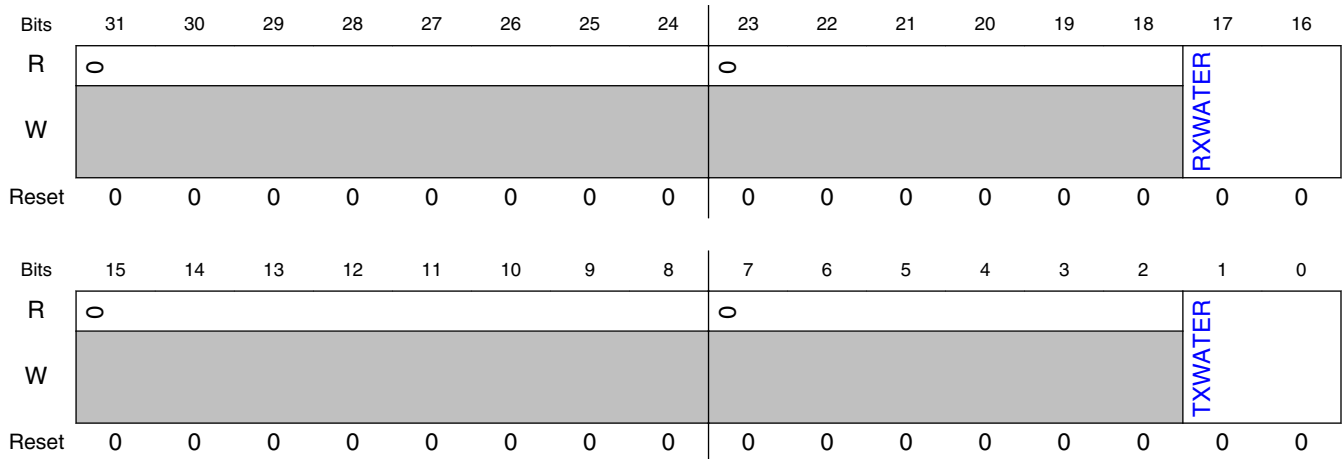

51.3.1.13.4 Fields

Field	Function
31-24 —	Reserved
23-18 —	Reserved
17-16 RXWATER	Receive FIFO Watermark The Receive Data Flag is set whenever the number of words in the receive FIFO is greater than RXWATER. Writing a value equal or greater than the FIFO size will be truncated.
15-8 —	Reserved
7-2 —	Reserved
1-0 TXWATER	Transmit FIFO Watermark The Transmit Data Flag is set whenever the number of words in the transmit FIFO is equal or less than TXWATER. Writing a value equal or greater than the FIFO size will be truncated.

51.3.1.14 FIFO Status Register (FSR)

51.3.1.14.1 Offset

Register	Offset
FSR	5Ch

51.3.1.14.2 Function

The FIFO Status register contains the TXCOUNT and RXCOUNT fields, which hold the number of words currently stored in the FIFO.

51.3.1.14.3 Diagram

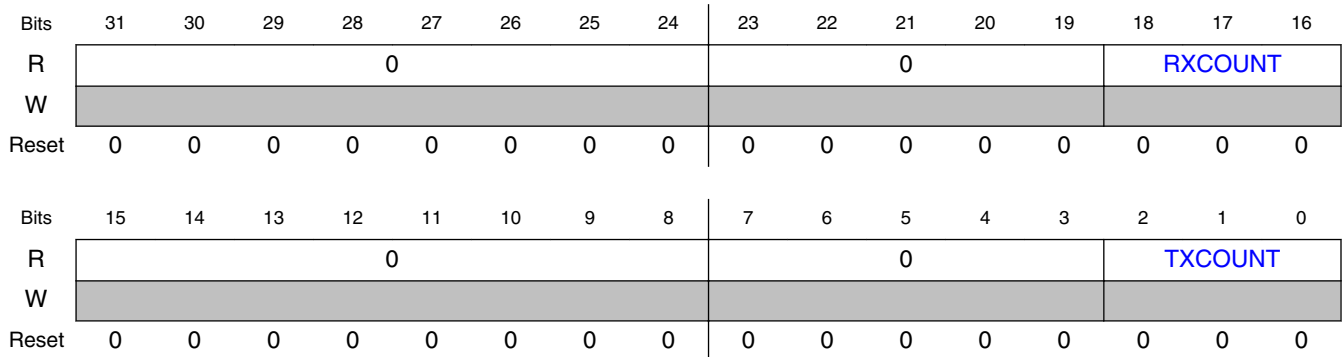

51.3.1.14.4 Fields

Field	Function
31-24 —	Reserved
23-19 —	Reserved
18-16 RXCOUNT	Receive FIFO Count Returns the number of words currently stored in the receive FIFO.
15-8 —	Reserved
7-3 —	Reserved
2-0 TXCOUNT	Transmit FIFO Count Returns the number of words currently stored in the transmit FIFO.

51.3.1.15 Transmit Command Register (TCR)

51.3.1.15.1 Offset

Register	Offset
TCR	60h

51.3.1.15.2 Function

Writes to either the Transmit Command Register or Transmit Data Register will push the data into the transmit FIFO, in the order that the data are written. The Command Register should only be written using 32-bit writes. Command Register writes will be tagged and cause the command register to update, after that entry reaches the top of the FIFO. This allows changes to the command word and the transmit data itself to be interleaved. Changing the command word will cause all subsequent SPI bus transfers to be performed using the new command word.

- **In master mode**, writing a new command word does not initiate a new transfer, unless TXMSK is set. Transfers are initiated by transmit data in the transmit FIFO, or by a new command word (with TXMSK set). Hardware will clear TXMSK when the LPSPI_PCS negates.
- **In master mode**, if the command word is changed before an existing frame has completed, then the existing frame will terminate and the command word will then update. The command word can be changed during a continuous transfer, if CONTC of the new command word is set and the command word is written on a frame size boundary.
- **In slave mode**, the command word should be changed only when the LPSPI is idle and there is no SPI bus transfer.

Avoid register reading problems: Reading the Transmit Command Register will return the current state of the command register. Reading the Transmit Command Register at the same time that the Transmit Command Register is loaded from the transmit FIFO, can return an incorrect Transmit Command Register value. It is recommended:

- to either read the Transmit Command Register when the transmit FIFO is empty,
- or to read the Transmit Command Register more than once and then compare the returned values.

51.3.1.15.3 Diagram

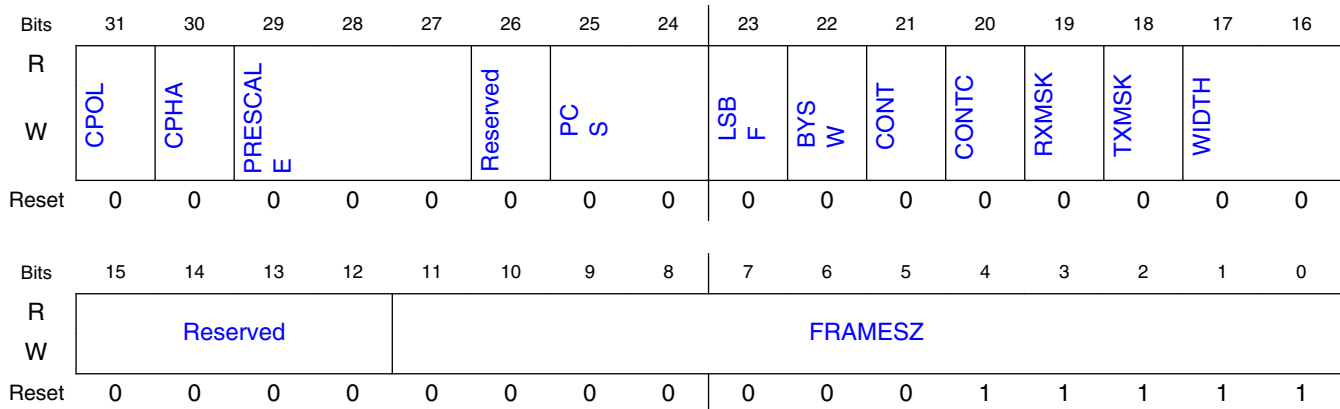

51.3.1.15.4 Fields

Field	Function
31 CPOL	Clock Polarity The Clock Polarity field is only updated when PCS negated. 0b - The inactive state value of SCK is low 1b - The inactive state value of SCK is high
30 CPHA	Clock Phase The Clock Phase field is only updated when PCS negated. 0b - Data is captured on the leading edge of SCK and changed on the following edge of SCK 1b - Data is changed on the leading edge of SCK and captured on the following edge of SCK
29-27 PRESCALE	Prescaler Value For all SPI bus transfers, the Prescaler value applied to the clock configuration register. The Prescaler Value field is only updated when PCS negated. 000b - Divide by 1 001b - Divide by 2 010b - Divide by 4 011b - Divide by 8 100b - Divide by 16 101b - Divide by 32 110b - Divide by 64 111b - Divide by 128
26 —	Reserved
25-24 PCS	Peripheral Chip Select Configures the peripheral chip select used for the transfer. The Peripheral Chip Select field is only updated when PCS negated. NOTE: The entire PCS field is not fully supported in every LPSPI module instance. Refer to the chip-specific information for LPSPI. 00b - Transfer using LPSPi_PCS[0] 01b - Transfer using LPSPi_PCS[1] 10b - Transfer using LPSPi_PCS[2] 11b - Transfer using LPSPi_PCS[3]

Table continues on the next page...

Memory Map and Registers

Field	Function
23 LSBF	LSB First 0b - Data is transferred MSB first 1b - Data is transferred LSB first
22 BYSW	Byte Swap Byte swap will swap the contents of [31:24] with [7:0] and [23:16] with [15:8] for each transmit data word read from the FIFO and for each received data word stored to the FIFO (or compared with match registers). 0b - Byte swap is disabled 1b - Byte swap is enabled
21 CONT	Continuous Transfer <ul style="list-style-type: none"> In master mode, continuous transfer will keep the PCS asserted at the end of the frame size, until a command word is received that starts a new frame. In slave mode, when continuous transfer is enabled, the LPSPi will only transmit the first FRAMESZ bits; after which the LPSPi will transmit received data (assuming a 32-bit shift register) until the next PCS negation. 0b - Continuous transfer is disabled 1b - Continuous transfer is enabled
20 CONTC	Continuing Command In master mode, the Continuing Command bit allows the command word to be changed within a continuous transfer. <ul style="list-style-type: none"> The initial command word must enable continuous transfer (CONT=1), the continuing command must set this bit (CONTC=1), and the continuing command word must be loaded on a frame size boundary. For example, if the continuous transfer has a frame size of 64-bits, then a continuing command word must be loaded on a 64-bit boundary. 0b - Command word for start of new transfer 1b - Command word for continuing transfer
19 RXMSK	Receive Data Mask When set, receive data is masked (receive data is not stored in receive FIFO). 0b - Normal transfer 1b - Receive data is masked
18 TXMSK	Transmit Data Mask When set, transmit data is masked (no data is loaded from transmit FIFO and output pin is tristated). In master mode, the Transmit Data Mask bit will initiate a new transfer which cannot be aborted by another command word; the Transmit Data Mask bit will be cleared by hardware at the end of the transfer. 0b - Normal transfer 1b - Mask transmit data
17-16 WIDTH	Transfer Width Configures between serial (1-bit) or parallel transfers. For half-duplex parallel transfers, either Receive Data Mask (RXMSK) or Transmit Data Mask (TXMSK) must be set. 00b - 1 bit transfer 01b - 2 bit transfer 10b - 4 bit transfer 11b - Reserved
15-12 —	Reserved Software should only write zero to this field.
11-0 FRAMESZ	Frame Size Configures the frame size in number of bits equal to (FRAMESZ + 1).

Field	Function
	<ul style="list-style-type: none"> The minimum frame size is 8 bits The minimum word size is 2 bits; a frame size of 33 bits (or similar) is not supported. If the frame size is larger than 32 bits, then the frame is divided into multiple words of 32-bits; each word is loaded from the transmit FIFO and stored in the receive FIFO separately. If the size of the frame is not divisible by 32, then the last load of the transmit FIFO and store of the receive FIFO will contain the remainder bits. For example, a 72-bit transfer will consist of 3 words: the 1st and 2nd words are 32 bits, and the 3rd word is 8 bits.

51.3.1.16 Transmit Data Register (TDR)

51.3.1.16.1 Offset

Register	Offset
TDR	64h

51.3.1.16.2 Function

Writes to either the Transmit Command Register or Transmit Data Register will push the data into the transmit FIFO, in the order that it (the data) was written. The Data Register can be written using 32-bit, 16-bit or 8-bit writes, but each write will push data into the FIFO with zero pushed in unwritten bytes.

51.3.1.16.3 Diagram

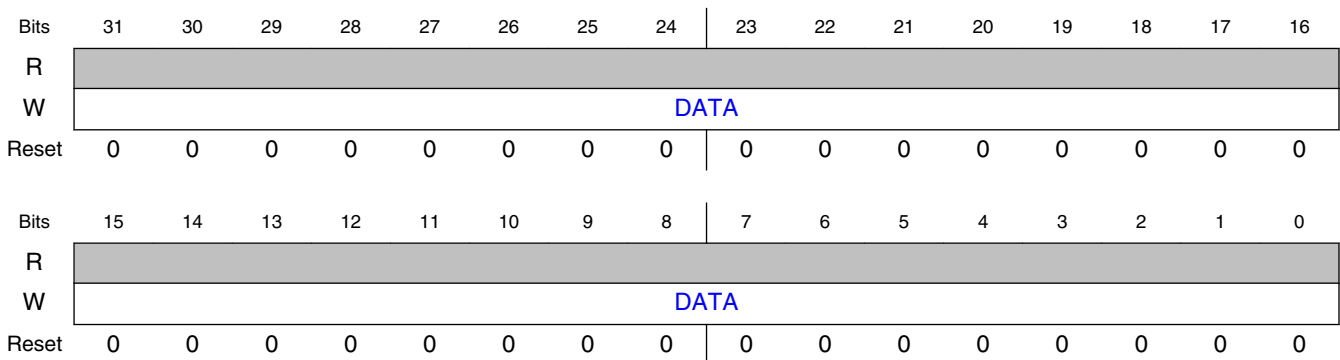

51.3.1.16.4 Fields

Field	Function
31-0	Transmit Data

Memory Map and Registers

Field	Function
DATA	Both 8-bit and 16-bit writes of transmit data will zero-extend the data written and push the data into the transmit FIFO. To zero-extend 8-bit and 16-bit writes (to 32 bits), means that the higher order (most significant) empty parts of the 8-bit and 16-bit writes are filled with zeroes.

51.3.1.17 Receive Status Register (RSR)

51.3.1.17.1 Offset

Register	Offset
RSR	70h

51.3.1.17.2 Function

The Receive Status register contains data flow status fields for FIFO receive.

51.3.1.17.3 Diagram

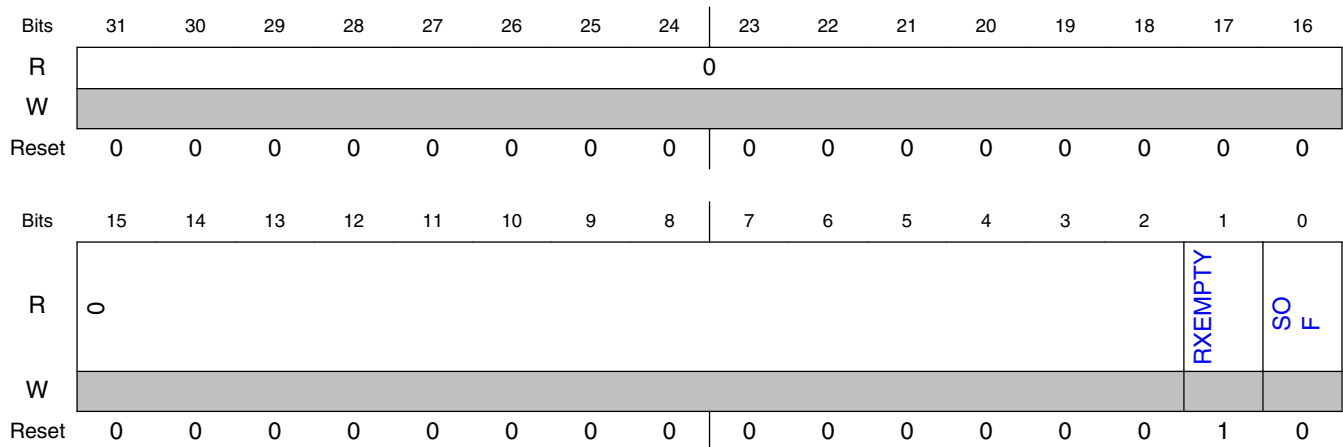

51.3.1.17.4 Fields

Field	Function
31-2	Reserved
—	
1 RXEMPTY	RX FIFO Empty 0b - RX FIFO is not empty 1b - RX FIFO is empty

Table continues on the next page...

Field	Function
0	Start Of Frame
SOF	Indicates that this is the first data word received after LPSPI_PCS assertion. 0b - Subsequent data word received after LPSPI_PCS assertion 1b - First data word received after LPSPI_PCS assertion

51.3.1.18 Receive Data Register (RDR)

51.3.1.18.1 Offset

Register	Offset
RDR	74h

51.3.1.18.2 Function

Pulls the first entry from the receive FIFO.

51.3.1.18.3 Diagram

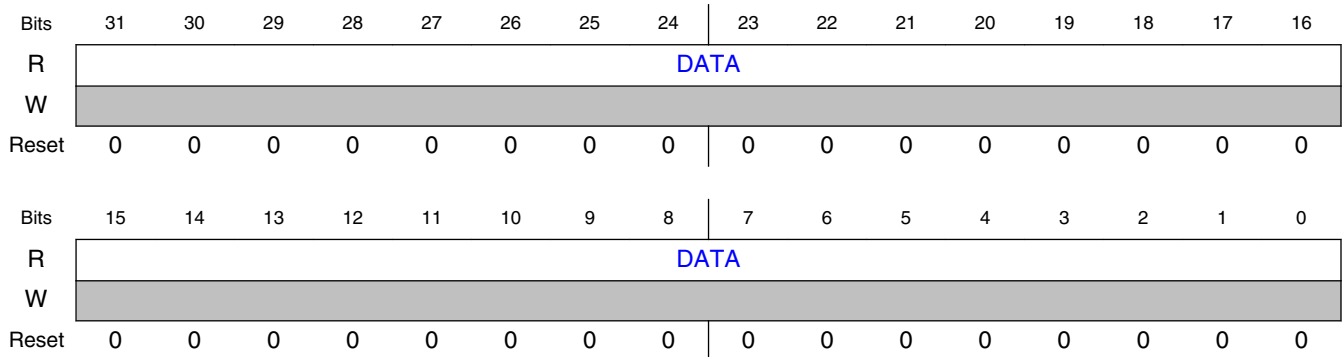

51.3.1.18.4 Fields

Field	Function
31-0	Receive Data
DATA	

51.4 Functional description

51.4.1 Clocking and resets

For device-specific clocking information, refer to the Clocking chapter.

Table 51-4. Clocks

LPSPi Functional clock	<ul style="list-style-type: none"> The LPSPi functional clock is asynchronous to the bus clock. If the LPSPi functional clock remains enabled in low power modes, then LPSPi can perform SPI bus transfers and low power wakeups, in both master and slave modes. The LPSPi divides the functional clock by a prescaler; the resulting frequency must be at least 2 times faster than the SPI external clock frequency (LPSPi_SCK).
External clock	<ul style="list-style-type: none"> The LPSPi shift register is clocked directly by the LPSPi_SCK clock. How the LPSPi_SCK clock is generated or supplied depends upon the mode (master or slave): <ul style="list-style-type: none"> in master mode: the LPSPi_SCK clock is generated internally. in slave mode: the LPSPi_SCK clock is supplied externally.
Bus clock	The bus clock is only used for bus accesses to the LPSPi control and configuration registers. The bus clock frequency must be high enough to support the data bandwidth requirements of the LPSPi registers, including the FIFOs.

Table 51-5. Resets

Chip reset	Resets the LPSPi logic and registers to their default state.
Software reset	<ul style="list-style-type: none"> Resets the LPSPi logic and registers to their default state, except for the Control Register. The LPSPi software reset is in the Control Register CR[RST].
FIFO resets	<ul style="list-style-type: none"> Resets the transmit/command FIFO and the receive FIFO. Control Register CR[RTF](Reset Transmit FIFO) and CR[RRF] (Reset Receive FIFO) are write-only bits. After being reset, a FIFO is empty.

51.4.2 Master Mode

51.4.2.1 Transmit and Command FIFO commands

The transmit and command FIFO is a combined FIFO that includes both transmit data words and command words.

- Transmit data words are stored to the transmit/command FIFO, by writing the Transmit Data Register (TDR).
- Command words are stored to the transmit/command FIFO, by writing the Transmit Command Register (TCR).

When a command word is at the top of the transmit/command FIFO, the actions that can occur depend upon whether the LPSPI module is either busy or between frames, the Continuous Transfer bit (TCR[CONT]), and the Continuing Command bit (TCR[CONTC]).

Table 51-6. Possible actions when a command word is at the top of the transmit/command FIFO

Condition	Action
If the LPSPI is between frames	then the command word is pulled from the FIFO, and that command word controls all subsequent transfers.
If LPSPI is busy and the Continuous Transfer bit (TCR[CONT]) is set or cleared and the Continuing Command bit (TCR[CONTC]) is cleared	then the SPI frame will complete at the end of the existing word, ignoring the FRAMESZ configuration. The command word is then pulled from the FIFO and that command word controls all subsequent transfers (or until the next update to the command word). Note that a command word with CONTC=0 will always terminate (stop) the existing transfer regardless of the previous CONT value.
If the LPSPI is busy and the existing Continuous Transfer bit (TCR[CONT]) is set or cleared and the new Continuing Command bit (TCR[CONTC]) value is set	then the command word must be updated at the frame boundary. The command word is pulled from the FIFO during the last LPSPI_SCK pulse of the existing frame (based on the FRAMESZ configuration), and the frame continues using the new command value for the rest of the frame (or until the next update to the command word). When the Continuing Command bit (TCR[CONTC]) is set, only the lower 24-bits of the command word are updated. If the command word is updated at a word boundary, then the transfer halts (stops) after that word.

NOTE

About the Continuous Transfer bit (CONT) and Continuing Command bit (CONTC):

- Continuous Transfer bit (CONT)=1 is used to keep PCS asserted at end of frame, allowing the transfer to continue.
- Continuing Command bit (CONTC)=1 is used to indicate that this command word should not terminate the existing frame, and the transfer can continue using the new command word.

The Continuing Command bit (CONTC)=1 is restricted in the sense that the new command must load on a frame boundary, and the only way for a transfer to continue from a frame boundary, is when the previous command has the Continuous Transfer bit (CONT)=1.

The current state of the existing command word can be read by reading the Transmit Command Register (TCR). It requires at least 3 LPSPI functional clock cycles for the transmit command register to update after the transmit command register is written (assuming an empty FIFO) and the LPSPI must be enabled (Module Enable CR[MEN] bit is set).

Functional description

Writing the transmit command register does not initiate a SPI bus transfer, unless the Transmit Data Mask (TCR[TXMSK]) bit is set. When the Transmit Data Mask bit is set, a new command word will not be loaded until the end of the existing frame (based on FRAMESZ configuration); at the end of the transfer, the TXMSK bit will be cleared.

In master mode, the LPSPI command word in the Transmit Command Register (TCR) controls SPI attributes (using bits and fields in registers).

Table 51-7. LPSPI Command Word in Master Mode

Transmit Command Register (TCR)		Description	Can this bit/field be modified during a data transfer?
Bit/Field	Name		
CPOL	Clock Polarity	Configures the polarity of the LPSPI_SCK pin. Any change of CPOL value will cause a transition on the LPSPI_SCK pin.	N
CPHA	Clock Phase	Configures the clock phase of the transfer.	N
PRESCALE	Prescaler Value	Configures a prescaler used to divide the LPSPI functional clock, to generate the timing parameters of the SPI bus transfer. Changing PRESCALE in conjunction with PCS enables the LPSPI module to connect to different slave devices at different frequencies.	N
PCS	Peripheral Chip Select	Configures which LPSPI_PCS asserts for the transfer; the polarity of LPSPI_PCS is static and configured by PCSPOL. If PCSCFG is set, then PCS[3:2] should not be selected.	N
LSBF	LSB First	Configures if LSB (bit 0) or MSB (bit 31 for a 32-bit word) is transmitted or received first.	Y
BYSW	Byte Swap	Enables byte swap on each 32-bit word when transmitting and receiving data. Byte swapping can be useful when interfacing to devices that organize data as big-endian.	Y
CONT	Continuous Transfer	Configures for a continuous transfer that keeps PCS asserted between frames (as configured by FRAMESZ). A new command word is required to cause PCS to negate. Also supports changing the command word at the frame size boundaries.	Y
CONTC	Continuing Command	Indicates that this is a new command word for the existing continuous transfer. The CONTC bit when set must only be written to the transmit/command FIFO on a frame boundary.	Y
RXMSK	Receive Data Mask	Masks the receive data and does not store the masked receive data to the receive FIFO or perform receive data matching. Useful for half-duplex transfers or to configure which fields are compared during receive data matching.	Y
TXMSK	Transmit Data Mask	Masks the transmit data, so that masked transmit data is not pulled from transmit FIFO, and the output data pin is tristated (unless configured by Output Config CFGR1[OUTCFG]). Useful for half-duplex transfers.	Y
WIDTH	Transfer Width	Configures the number of bits shifted on each LPSPI_SCK pulse. <ul style="list-style-type: none"> • 1-bit transfers support traditional SPI bus transfers in either half-duplex or full-duplex data formats. • 2-bit and 4-bit half-duplex transfers are useful for interfacing to QuadSPI memory devices, and at least one bit (Transmit Data Mask (TCR[TXMSK] or Receive Data Mask TCR[RXMSK]) must also be set. 	Y

Table continues on the next page...

Table 51-7. LPSPI Command Word in Master Mode (continued)

Transmit Command Register (TCR)		Description	Can this bit/field be modified during a data transfer?
Bit/Field	Name		
FRAMESZ	Frame Size	Configures the frame size in number of bits equal to (FRAMESZ + 1). <ul style="list-style-type: none"> • The minimum frame size is 8 bits. • The minimum word size is 2 bits; a frame size of 33 bits (or similar) is not supported. • If the frame size is larger than 32 bits, then the frame is divided into multiple words of 32-bits; each word is loaded from the transmit FIFO and stored in the receive FIFO separately. • If the size of the frame is not divisible by 32, then the last load of the transmit FIFO and store of the receive FIFO will contain the remainder bits. For example, a 72-bit transfer will consist of 3 words: the 1st and 2nd words are 32-bit, and the 3rd word is 8-bit. 	Y

SPI bus transfers:

- The LPSPI initiates a SPI bus transfer when:
 - data is written to the transmit FIFO
 - and the HREQ pin is asserted (or disabled)
 - and the LPSPI is enabled
- To perform the SPI bus transfer, LPSPI uses the attributes configured in the Transmit Command Register (TCR) and uses the timing parameters in the Clock Configuration Register (CCR).
- The SPI bus transfer ends after the FRAMESZ configuration is reached, or at the end of a word when a new transmit command word is at the top of the transmit/command FIFO.
- The HREQ input is only checked on the next time that the LPSPI goes idle (the LPSPI completes the current transfer and the Transmit Command Register (TCR) is empty).

Circular FIFO: The transmit/command FIFO also supports a Circular FIFO feature, which enables the LPSPI master to (periodically) repeat a short data transfer that can fit within the transmit/command FIFO, without requiring additional FIFO accesses. When the circular FIFO is enabled, the current state of the FIFO read pointer is saved and the status flags do not update. After the transmit/command FIFO is considered empty and the LPSPI is idle, the FIFO read pointer is restored with the saved version, so the contents of the transmit/command FIFO are not permanently pulled from the FIFO while circular FIFO mode is enabled.

51.4.2.2 Receive FIFO and Data Match

The receive FIFO is used to store receive data during SPI bus transfers. When the Receive Data Mask TCR[RXMSK] bit is set, the receive data is discarded instead of being stored in the receive FIFO.

- The receive data is written to the receive FIFO at the end of the frame.
- During a multiple word or continuous transfer, the receive data is also written to the receive FIFO at the same time as the new transmit data is read from the transmit FIFO.
- During a continuous transfer, if the transmit FIFO is empty, then the receive data is only written to the receive FIFO after the transmit FIFO is written or after the Transmit Command Register (TCR) is written to end the frame.

Receive data supports a receive data match function that can match received data against one of two words or against a masked data word. The receive data match function can also be configured to compare only the first one or two received data words since the start of the frame.

- Received data that is already discarded due to the Receive Data Mask TCR[RXMSK] bit cannot cause the data match to set, and will delay the receive data match on the first received data word, until all discarded data is received.
- The receiver data match function can also be configured to discard all received data until a data match is detected, using the Receive Data Match Only CFGR0[RDMO] bit.
- After a receive data match, to allow all subsequent data to be received, first clear the Receive Data Match Only CFGR0[RDMO] bit, then clear the Data Match Flag SR[DMF] bit.

51.4.2.3 Timing Parameters

The timing parameters that are used for all SPI bus transfers are relative to the LPSPI functional clock divided by the PRESCALE configuration. Although the Clock Configuration Register (CCR) cannot be changed when the LPSPI module is busy, to support interfacing to different slave devices at different frequencies, the Prescaler Value TCR[PRESCALE] configuration can be changed between SPI bus transfers using the Transmit Command Register (TCR).

NOTE

The minimum value below is the minimum counter value, but the clock configuration register values must also satisfy the datasheet specs based on the LPSPI functional clock frequency and prescaler value.

Table 51-8. LPSPI Timing Parameters

Clock Configuration Register (CCR)		Description	Min	Max
Bit/Field	Name			
SCKDIV	SCK Divider	Configures the LPSPI_SCK clock period to (SCKDIV +2) cycles. When SCK Divider is configured to an odd number of cycles, the first half of the LPSPI_SCK cycle is one cycle longer than the second half of the LPSPI_SCK cycle.	0 (2 cycles)	255 (257 cycles)
DBT	Delay Between Transfers	Configures the minimum delay between PCS negation and the next PCS assertion to (DBT + 2) cycles. When the command word is updated between transfers, there is a minimum of (DBT/2)+1 cycles between the command word update and any change on LPSPI_PCS pins.	0 (2 cycles)	255 (257 cycles)
DBT	Delay Between Transfers	Configures the delay during a continuous transfer between the last SCK edge of a frame and the first SCK edge of the continuing frame to (DBT + 1) cycles. This is useful when the external slave requires a large delay between different words of an SPI bus transfer.	0 (1 cycle)	255 (256 cycles)
PCSSCK	PCS-to-SCK Delay	Configures the minimum delay between PCS assertion and the first SCK edge to (PCSSCK + 1) cycles.	0 (1 cycle)	255 (256 cycles)
SCKPCS	SCK-to-PCS Delay	Configures the minimum delay between the last SCK edge and the PCS assertion to (SCKPCS + 1) cycles.	0 (1 cycle)	255 (256 cycles)

51.4.2.4 Pin Configuration

- To swap directions or support half-duplex transfers on the same pin, the LPSPI_SIN and LPSPI_SOUT pins can be configured using the Pin Configuration CFGR1[PINCFG].
- To determine if an output data pin (like LPSPI_SOUT) will tristate when the LPSPI_PCS is negated, or if the output data pin will simply retain the last value, use the Output Config CFGR1[OUTCFG].
- When configuring for half-duplex transfers the output data pins must be configured to tristate when LPSPI_PCS is negated; use the Output Config CFGR1[OUTCFG].
- When performing half-duplex 2-bit transfers, the Peripheral Chip Select Configuration CFGR1[PCSCFG] can be set to any value.
- When performing half-duplex 4-bit transfers, the Peripheral Chip Select Configuration CFGR1[PCSCFG] must equal 0x1.

51.4.2.5 Clock Loopback

The LPSPI master can be configured to use 1 of 2 clocks to sample the input data (for example, LPSPI_SIN):

- either the LPSPI_SCK output clock directly
- or a delayed version of the LPSPI_SCK output clock

The delayed version of the LPSPI_SCK is delayed by the LPSPI_SCK pin output delay, plus the LPSPI_SCK pin input delay, and is configured by setting CFGR1[SAMPLE]. Enabling the loopback version of the LPSPI_SCK can improve the setup time of the input data from the slave.

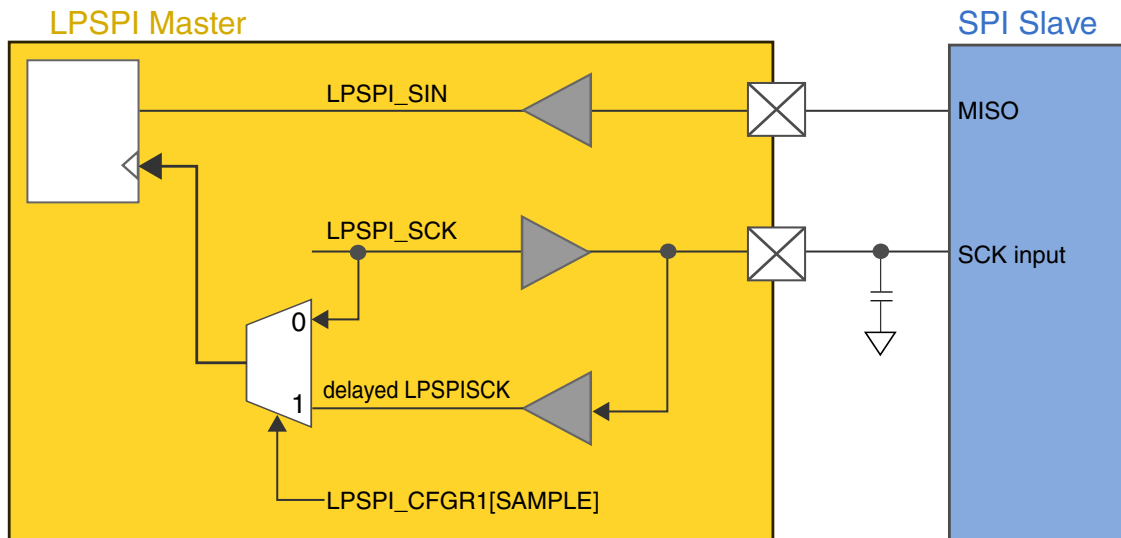

Figure 51-2. Clock Loopback

See the device datasheet for the specific input setup time in master loopback mode.

51.4.3 Slave Mode

LPSPI slave mode:

- uses the same shift register and logic that master mode uses
- does not use the Clock Configuration Register (CCR)
- during SPI bus transfers, requires that the Transmit Command Register (TCR) remain static (unchanging)

51.4.3.1 Transmit and Command FIFO commands

Before enabling the LPSPI in slave mode, the Transmit Command Register (TCR) should be initialized, although the Transmit Command Register register will not update until after the LPSPI is enabled. After being enabled, the Transmit Command Register should only be changed if the LPSPI is idle. In slave mode, the LPSPI command word in the Transmit Command Register (TCR) controls SPI attributes (using bits and fields in registers). Before the LPSPI_PCS input asserts, the transmit FIFO must be filled with transmit data, or the transmit error flag will set.

Table 51-9. LPSPI Command Word in Slave Mode

Transmit Command Register (TCR)		Description
Bit/Field	Name	
CPOL	Clock Polarity	Configures the polarity of the external LPSPI_SCK input.
CPHA	Clock Phase	Configures the clock phase of transfer.
PRESCALE	Prescaler Value	Configures the LPSPI functional clock prescaler.
PCS	Peripheral Chip Select	Configures which LPSPI_PCS is used, the polarity of LPSPI_PCS is static and configured by PCSPOL. If PCSCFG is set, then PCS[3:2] should not be selected.
LSBF	LSB First	Configures if LSB (bit 0) or MSB (bit 31 for a 32-bit word) is transmitted or received first.
BYSW	Byte Swap	Enables byte swap on each 32-bit word when transmitting and receiving data. Byte swapping can be useful when interfacing to devices that organize data as big-endian.
CONT	Continuous Transfer	When Continuous Transfer is set in slave mode and after the first FRAMESZ bits are transferred, the LPSPI will passthrough and transmit the received data until the next PCS negation.
CONTC	Continuing Command	CONTC bit is reserved (in slave mode).
RXMSK	Receive Data Mask	Masks the receive data and does not store the masked receive data to the receive FIFO or perform receive data matching. Useful for half-duplex transfers or to configure which fields are compared during receive data matching.
TXMSK	Transmit Data Mask	Masks the transmit data, so that the masked transmit data is not pulled from transmit FIFO, and the output data pin is tristated (unless configured by Output Config CFGR1[OUTCFG]). Useful for half-duplex transfers.
WIDTH	Transfer Width	Configures the number of bits shifted on each LPSPI_SCK pulse. <ul style="list-style-type: none"> 1-bit transfers support traditional SPI bus transfers in either half-duplex or full-duplex data formats.
FRAMESZ	Frame Size	Configures the frame size in number of bits equal to (FRAMESZ + 1). <ul style="list-style-type: none"> The minimum frame size is 8 bits. The minimum word size is 2 bits; a frame size of 33 bits (or similar) is not supported. If the frame size is larger than 32 bits, then the frame is divided into multiple words of 32-bits; each word is loaded from the transmit FIFO and stored in the receive FIFO separately. If the size of the frame is not divisible by 32, then the last load of the transmit FIFO and store of the receive FIFO will contain the remainder bits. For example, a 72-bit transfer will consist of 3 words: the 1st and 2nd words are 32-bit, and the 3rd word is 8-bit.

51.4.3.2 Receive FIFO and Data Match

The receive FIFO is used to store received data during SPI bus transfers. When the Receive Data Mask TCR[RXMSK] is set, the received data is discarded (instead of storing the received data in the receive FIFO).

Receive data supports a receive data match function that can match received data against one of two words or against a masked data word. The data match function can also be configured to compare only the first one or two received data words since the start of the frame.

- Received data that is already discarded (because the Receive Data Mask TCR[RXMSK] is set) cannot cause the data match to set, and will delay the match on the first received data word, until all discarded data is received.
- The receiver match function can also be configured to discard all received data until a data match is detected, using the Receive Data Match Only CFGR0[RDMO] bit.
- After a receive data match, to allow all subsequent data to be received, first clear the Receive Data Match Only CFGR0[RDMO] bit, then clear the Data Match Flag SR[DMF] bit.

51.4.3.3 Clocked Interface

The LPSPI module supports interfacing to external masters that provide only clock and data pins (LPSPI_PCS is not required). This interface requires:

- using Clock Phase TCR[CPHA] = 1 (data is changed on the leading edge of SCK and captured on the following edge)
- configuring the LPSPI_PCS input to be always asserted (configure the Peripheral Chip Select Polarity CFGR1[PCSPOL[n]] = 1). For example, to configure PCS[0] to be always asserted, set PCSPOL[0] = 1, and don't configure PCS[0] in the pin muxing.
- setting the Automatic PCS CFGR1[AUTOPCS] bit = 1 (Automatic PCS generation is enabled). When Automatic PCS generation (AUTOPCS) is set, a minimum of 4 LPSPI functional clock cycles (divided by PRESCALE configuration) is required between the last LPSPI_SCK edge of one word and the first LPSPI_SCK edge of the next word.

51.4.4 Interrupts and DMA Requests

The next table lists the slave mode sources (status flags) that can generate LPSPI interrupts and LPSPI slave transmit/receive DMA requests.

Table 51-10. LPSPI Interrupts and DMA Requests

Status Register (SR)		Description	Can generate		
Status Flag	Name		Interrupt?	DMA Request?	Low Power Wakeup?
TDF	Transmit Data Flag	Data can be written to transmit FIFO, as configured by the Transmit FIFO Watermark FCR[TXWATER]	Y	TX	Y
RDF	Receive Data Flag	Data can be read from the receive FIFO, as configured by the Receive FIFO Watermark FCR[RXWATER]	Y	RX	Y
WCF	Word Complete Flag	Word is complete, the last bit of the word has been sampled	Y	N	Y
FCF	Frame Complete Flag	Frame is complete, and PCS has negated	Y	N	Y
TCF	Transfer Complete Flag	Transfer is complete, PCS has negated, and the transmit/command FIFO is empty	Y	N	Y
TEF	Transmit Error Flag	Indicates a transmit/command FIFO underrun. In master mode when the No Stall CFGR1[NOSTALL] bit is clear (0, transfers will stall when transmit FIFO is empty), the Transmit Error Flag bit cannot set.	Y	N	Y
REF	Receive Error Flag	Receive error flag, indicates a receive FIFO overflow.	Y	N	Y
DMF	Data Match Flag	Indicates that the received data has matched the configured data match value	Y	N	Y
MBF	Module Busy Flag	LPSPI is busy performing a SPI bus transfer	N	N	N

51.4.5 Peripheral Triggers

The connection of the LPSPI peripheral triggers to other peripherals depend upon the specific device being used.

Table 51-11. LPSPI Triggers

Trigger	Description
Frame Output Trigger	The frame output trigger: <ul style="list-style-type: none"> asserts at the end of each frame (when PCS negates) remains asserted until PCS next asserts
Word Output Trigger	The word output trigger: <ul style="list-style-type: none"> asserts at the end of each received word remains asserted for 1 LPSPI_SCK period
Input Trigger	To control the start of a LPSPI bus transfer, the LPSPI input trigger can be selected instead of the LPSPI_HREQ input.

Table 51-11. LPSPI Triggers

Trigger	Description
	<ul style="list-style-type: none">• The LPSPI input trigger is synchronized, and must assert for at least 2 cycles of the LPSPI functional clock divided by the PRESCALE configuration, so that the input trigger can be detected.• When the LPSPI module is busy, the LPSPI_HREQ input (and therefore the LPSPI input trigger) is ignored .

Chapter 52

Low Power Inter-Integrated Circuit (LPI2C)

52.1 Chip-specific LPI2C information

52.1.1 Instantiation information

The following table summarizes the implementation of this module for each chip in the product series.

Table 52-1. LPI2C configuration

Chip	Instances	TX FIFO (word)	RX FIFO (word)	SMBus	Slave mode enable
S32K116	LPI2C0	4	4	Yes	Yes
S32K118	LPI2C0	4	4	Yes	Yes
S32K142	LPI2C0	4	4	Yes	Yes
S32K144	LPI2C0	4	4	Yes	Yes
S32K144W	LPI2C0	4	4	Yes	Yes
S32K146	LPI2C0	4	4	Yes	Yes
S32K148	LPI2C0	4	4	Yes	Yes
	LPI2C1	4	4	Yes	Yes

Low leakage and Wait mode is not supported in this device. See [Module operation in available power modes](#) for details on available power modes.

HS-Mode (baud-rates above 400 kbps) is not supported on this device.

The LPI2C module includes SMBus support and DMA support.

NOTE

- Only SIRC is the valid clock source in VLP modes. As the SIRC supports the LPI2C data rates, it is recommended to

use SIRC for LPI2C to avoid clock reconfiguration and switching times.

- HREQ is not supported for 32-pin QFN and 48-pin LQFP packages on any S32K1xx device.

52.2 Introduction

The LPI2C is a low power Inter-Integrated Circuit (I2C) module that supports an efficient interface to an I²C bus as a master and/or as a slave.

- The LPI2C implements logic support for standard-mode, fast-mode, fast-mode plus and ultra-fast modes of operation.
- The LPI2C is designed to use little CPU overhead, with DMA offloading of FIFO register accesses.
- The LPI2C can continue operating in stop modes if an appropriate clock is available.

The LPI2C module also complies with the System Management Bus (SMBus) Specification, version 2. The SMBus is a single-ended simple two-wire bus, which is typically used for low bandwidth communications.

NOTE

The I²C (Inter-Integrated Circuit) serial bus is multi-master, multi-slave, packet-switched, and single-ended, and is often used to attach microcontroller ICs to lower-speed peripheral ICs.

52.2.1 Features

The LPI2C supports:

- Standard, Fast, Fast+ and Ultra Fast modes are supported
- High speed mode (HS) in slave mode
- Multi-master support, including synchronization and arbitration. Multi-master means any number of master nodes can be present. Additionally, master and slave roles may be changed between messages (after a STOP is sent).
- Clock stretching: Sometimes multiple I2C nodes may be driving the lines at the same time. If any I2C node is driving a line low, then that line will be low. I2C nodes that are starting to transmit a logical one (by letting the line float high) can detect that the line is low, and thereby know that another I2C node is active at the same time.

- When node detection is used on the SCL line, it is called *clock stretching*, and clock stretching is used as a I2C flow control mechanism for multiple slaves.
- When node detection is used on the SDA line, it is called *arbitration*, and arbitration ensures that there is only one I2C node transmitter at a time.
- General call, 7-bit and 10-bit addressing
- Software reset, START byte and Device ID (also require software support)

The LPI2C master supports:

- Command/transmit FIFO of 4 words.
- Receive FIFO of 4 words.
- Command FIFO will wait for idle I2C bus before initiating transfer
- Command FIFO can initiate (repeated) START and STOP conditions and one or more master-receiver transfers
- STOP condition can be generated from command FIFO, or generated automatically when the transmit FIFO is empty
- Host request input to control the start time of an I2C bus transfer
- Flexible receive data match can generate interrupt on data match and/or discard unwanted data
- Flag and optional interrupt to signal Repeated START condition, STOP condition, loss of arbitration, unexpected NACK, and command word errors
- Supports configurable bus idle timeout and pin-stuck-low timeout

The LPI2C slave supports:

- Separate I2C slave registers to minimize software overhead because of master/slave switching
- Support for 7-bit or 10-bit addressing, address range, SMBus alert and general call address
- Transmit data register that supports interrupt or DMA requests
- Receive data register that supports interrupt or DMA requests
- Software-controllable ACK or NACK, with optional clock stretching on ACK/NACK bit
- Configurable clock stretching, to avoid transmit FIFO underrun and receive FIFO overrun errors
- Flag and optional interrupt at end of packet, STOP condition, or bit error detection

52.2.2 Block Diagram

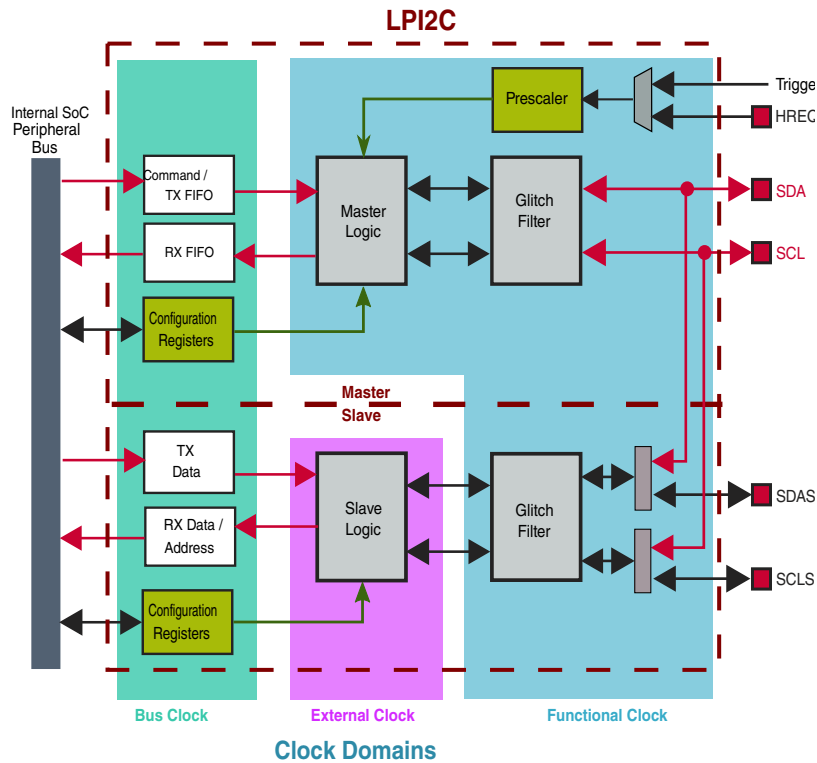

Figure 52-1. LPI2C block diagram

52.2.3 Modes of operation

Table 52-2. Chip modes supported by the LPI2C module

Chip mode	LPI2C Operation
Run	Normal operations
Stop	Can continue operating in stop mode if the Doze Enable bit (MCR[DOZEN]) is clear and the LPI2C is using an external or internal clock source that remains operating during stop mode.
Debug	Can continue operating in debug mode if the Debug Enable bit (MCR[DBGE]) is set.

52.2.4 Signal Descriptions

Table 52-3. Signals

Signal	Name	2-Wire Scheme	4-Wire Scheme	I/O
SCL	LPI2C clock line	SCL	In 4-wire mode, this is the SCL input pin.	I/O
SDA	LPI2C data line	SDA	In 4-wire mode, this is the SDA input pin.	I/O
HREQ	Host request	If host request is asserted and the I2C bus is idle, then it will initiate an LPI2C master transfer.		I
SCLS	Secondary I2C clock line	Not used	In 4-wire mode, this is the SCLS output pin. If LPI2C master/slave are configured to use separate pins, then this the LPI2C slave SCL pin.	I/O
SDAS	Secondary I2C data line	Not used	In 4-wire mode, this is the SDAS output pin. If LPI2C master/slave are configured to use separate pins, then this the LPI2C slave SDA pin.	I/O

52.3 Functional description

52.3.1 Clocking and Resets

For device-specific clocking information, refer to the Clocking chapter.

Table 52-4. Clocks

LPI2C Functional clock	The LPI2C functional clock is asynchronous to the bus clock and can remain enabled in low power modes to support I2C bus transfers by the LPI2C master. The functional clock is also used by the LPI2C slave to support digital filter and data hold time configurations. The LPI2C master divides the functional clock by a prescaler and the resulting frequency must be at least 8 times faster than the I2C bus bandwidth.
External clock	The LPI2C slave logic is clocked directly from the external pins SCL and SDA (or SCLS and SDAS if master and slave are implemented on separate pins). This allows the LPI2C slave to remain operational, even when the LPI2C functional clock is disabled. NOTE: The LPI2C slave digital filter must be disabled if the LPI2C functional clock is disabled, and this can affect compliance with some of the timing parameters of the I2C specification, such as the data hold time.
Bus clock	The bus clock is only used for bus accesses to the control and configuration registers. The bus clock frequency must be sufficient to support the data bandwidth requirements of the LPI2C master and slave registers.

Table 52-5. Resets

Chip reset	The logic and registers for the LPI2C master and slave are reset to their default state on a chip reset.
Software reset	<ul style="list-style-type: none"> The LPI2C master implements a software reset bit in its Control Register. The MCR[RST] will reset all master logic and registers to their default state, except for the MCR itself. The LPI2C slave implements a software reset bit in its Control Register. The SCR[RST] will reset all slave logic and registers to their default state, except for the SCR itself.
FIFO reset	<ul style="list-style-type: none"> The LPI2C master implements write-only control bits that reset the transmit FIFO (MCR[RTF]) and receive FIFO (MCR[RRF]). After a FIFO is reset, that FIFO is empty. The LPI2C slave implements write-only control bits that reset the transmit data register (SCR[RTF]) and receive data register (SCR[RRF]). After a data register is reset, that data register is empty.

52.3.2 Master Mode

The LPI2C master logic operates independently from the slave logic to perform all master mode transfers on the I2C bus.

52.3.2.1 Transmit and Command FIFO commands

The transmit FIFO stores command data to initiate the various I2C operations. The following operations can be initiated through commands in the transmit FIFO:

- START or Repeated START condition with address byte and expecting ACK or NACK.
- Transmit data (this is the default for zero extended byte writes to the transmit FIFO).
- Receive 1-256 bytes of data (can also be configured to discard receive data and not store in receive FIFO).
- STOP condition (can also be configured to send STOP condition when transmit FIFO is empty).

Multiple transmit and receive commands can be inserted between the START condition and STOP condition; transmit and receive commands must not be interleaved (to comply with the I2C specification). The receive data command and the receive data and discard commands can be interleaved, to ensure that only the desired received data is stored in the receive FIFO (or compared with the data match logic).

The LPI2C master will automatically transmit a NACK on the last byte of a receive data command unless the next command in the FIFO is also a receive data command. A NACK is also automatically transmitted if the transmit FIFO is empty when a receive data command completes.

The LPI2C master supports 10-bit addressing through a (repeated) START condition, followed by a transmit data byte containing the second address byte, followed by any number of data bytes with the master-transmit data.

A START or Repeated START condition that is expecting a NACK (for example, HS-mode master code) must be followed by a STOP or (repeated) START condition.

52.3.2.2 Master operations

Whenever the LPI2C is enabled, it monitors the I2C bus to detect when the I2C bus is idle (MSR[BBF]). The I2C bus is no longer considered idle if either SCL or SDA are low, and the I2C bus becomes idle if a STOP condition is detected or if a bus idle timeout is detected (as configured by MCFGR2[BUSIDLE]). After the I2C bus is idle, the transmit FIFO is not empty, and the host request is either asserted or disabled, then the LPI2C master will initiate a transfer on the I2C bus. This involves the following steps:

- Wait the bus idle time equal to $(MCCR0[CLKLO] + 1)$ multiplied by the prescaler (MCFGR1[PRESCALE]).
- Transmit a START condition and address byte using the timing configuration in the Master Clock Configuration Register 0 (MCCR0); if a high speed mode transfer is configured, then the timing configuration from Master Clock Configuration Register 1 (MCCR1) is used instead.
- Perform master-transmit or master-receive transfers, as configured by the transmit FIFO.
- Transmit NACK on the last byte of a master-receive transfer, unless the next command in the transmit FIFO is also a receive data command and the transmit FIFO is not empty.
- Transmit a Repeated START or STOP condition as configured by the transmit FIFO and/or MCFGR1[AUTOSTOP]. A repeated START can change which timing configuration register is used.

When the LPI2C master is disabled (either due to MCR[MEN] being clear or automatically due to mode entry), the LPI2C will continue to empty the transmit FIFO until a STOP condition is transmitted. However, the LPI2C will no longer stall the I2C bus waiting for the transmit or receive FIFO, and after the transmit FIFO is empty, the LPI2C will generate a STOP condition automatically.

The LPI2C master can stall the I2C bus under certain conditions; this will result in SCL pulled low continuously on the first bit of a byte, until the condition is removed:

Functional description

- LPI2C master is enabled and busy, the transmit FIFO is empty, and MCFGR1[AUTOSTOP] is clear.
- LPI2C master is enabled and receiving data, receive data is not being discarded (due to command or receive data match), and the receive FIFO is full.

52.3.2.3 Receive FIFO and Data Matching

The receive FIFO is used to store receive data during master-receiver transfers. Receive data can also be configured to discard receive data instead of storing in the receive FIFO; this is configured by the command word in the transmit FIFO.

Receive data supports a receive data match function that can match received data against one of two bytes or against a masked data byte. The data match function can also be configured to compare only the first one or two received data words since the last (repeated) START condition. Receive data that is already discarded due to the command word cannot cause the data match to set, and will delay the match on the first received data word until after the discarded data is received. The receiver match function can also be configured to discard all receive data until a data match is detected, using the MCFGR0[RDMO] control bit. When clearing the MCFGR0[RDMO] control bit following a data match, clear MCFGR0[RDMO] before clearing MSR[DMF], to allow all subsequent data to be received.

52.3.2.4 Timing Parameters

The following timing parameters can be configured by the LPI2C master. Parameters are configured separately for high speed mode (MCCR1) and other modes (MCCR0). This allows the high speed mode master code to be sent using the regular timing parameters, and then switch to the high speed mode timing (following a repeated START) until the next STOP condition.

The LPI2C master timing parameters in LPI2C functional clock cycles are configured as follows. They must be configured to meet the I2C timing specification for the required mode.

Table 52-6. Timing Parameters

I2C Specification Timing Parameter	I2C Specification Timing Symbol	LPI2C Timing Parameter (LPI2C functional clock cycles)
SCL clock period	tSCL	$(CLKHI + CLKLO + 2 + SCL_LATENCY) \times (2 \wedge PRESCALE)$
hold time (repeated) START condition	tHD:STA	$(SETHOLD + 1) \times (2 \wedge PRESCALE)$
LOW period of the SCL clock	tLOW	$(CLKLO + 1) \times (2 \wedge PRESCALE)$

Table continues on the next page...

Table 52-6. Timing Parameters (continued)

I2C Specification Timing Parameter	I2C Specification Timing Symbol	LPI2C Timing Parameter (LPI2C functional clock cycles)
HIGH period of the SCL clock	tHIGH	$(CLKHI + 1 + SCL_LATENCY) \times (2 \wedge PRESCALE)$
setup time for a repeated START condition or STOP condition	tSU:STA, tSU:STO	$(SETHOLD + 1 + SCL_LATENCY) \times (2 \wedge PRESCALE)$
data hold time	tHD:DAT	$(DATAVD + 1) \times (2 \wedge PRESCALE)$
data setup time	tSU:DAT	$(SDA_LATENCY + 1) \times (2 \wedge PRESCALE)$
bus free time between a STOP and START condition	tBUF	$(CLKLO + 1 + SDA_LATENCY) \times (2 \wedge PRESCALE)$
data valid time, data valid acknowledge time	tVD:DAT, tVD:ACK	$(DATAVD + 1) \times (2 \wedge PRESCALE)$

The latency parameters are defined in the following table, these parameters assume the risetime is less than one LPI2C functional clock cycle. The risetime depends on a number of factors, including the I/O propagation delay, the I2C bus loading and the external pull-up resistor sizing. A larger risetime will increase the number of cycles that the signal takes to propagate through the synchronizer (and glitch filter), which increases the latency.

Table 52-7. Synchronization Latency

Timing Parameter	Timing Definition
SCL_LATENCY	$ROUNDDOWN ((2 + FILTSCL + SCL_RISETIME) / (2 \wedge PRESCALE))$
SDA_LATENCY	$ROUNDDOWN ((2 + FILTSDA + SDA_RISETIME) / (2 \wedge PRESCALE))$

The following timing restrictions must be enforced to avoid unexpected START or STOP conditions on the I2C bus, or to avoid unexpected START or STOP conditions detected by the LPI2C master. The timing restrictions can be summarized as **SDA cannot change when SCL is high outside of a transmitted (repeated) START or STOP condition.**

Table 52-8. LPI2C Timing Parameter Restrictions

Timing Parameter	Minimum	Maximum	Comment
CLKLO	0x03	-	Also: $CLKLO \times (2 \wedge PRESCALE) > SCL_LATENCY$
CLKHI	0x01	-	Configure CLKHI to meet the duty cycle requirements in the I2C specification
SETHOLD	0x02	-	Also: $SETHOLD \times (2 \wedge PRESCALE) > SDA_LATENCY$
DATAVD	0x01	$CLKLO - SDA_LATENCY - 1$	Configure DATAVD to meet the data hold requirement in the I2C specification
FILTSCL	0x00	$[CLKLO \times (2 \wedge PRESCALE)] - 3$	FILTSCL and FILTSDA are the only parameters not multiplied by $(2 \wedge PRESCALE)$

Table continues on the next page...

Table 52-8. LPI2C Timing Parameter Restrictions (continued)

Timing Parameter	Minimum	Maximum	Comment
FILTSDA	FILTSCSCL	$[\text{CLKLO} \times (2^{\wedge} \text{PRESCALE})] - 3$	Configuring FILTSDA greater than FILTSCSCL can delay the SDA input to compensate for board level skew
BUSIDLE	$(\text{CLKLO} + \text{SETHOLD} + 2) \times 2$	-	Must also be greater than $(\text{CLKHI} + 1)$

The timing parameters must be configured to meet the requirements of the I2C specification; this will depend on the mode being supported and the LPI2C functional clock frequency. When switching between two modes using the different clock configuration registers (for example, Fast and HS-mode), the PRESCALE factor must remain constant between the modes. Some example timing configurations are provided below.

Table 52-9. LPI2C Example Timing Configurations

I2C Mode	Clock Frequency	Baud Rate	PRESCALE	FILTSCSCL / FILTSDA	SETHOLD	CLKLO	CLKHI	DATAVD
Fast	8 MHz	400 kbps	0x0	0x0/0x0	0x04	0x0B	0x05	0x02
Fast+	8 MHz	1 Mbps	0x0	0x0/0x0	0x02	0x03	0x01	0x01
Fast	48 MHz	400 kbps	0x0	0x1/0x1	0x1D	0x3E	0x35	0x0F
Fast	48 MHz	400 kbps	0x2	0x1/0x1	0x07	0x11	0x0B	0x03
Fast+	48 MHz	1 Mbps	0x2	0x1/0x1	0x03	0x06	0x04	0x04
HS-mode	48 MHz	3.2 Mbps	0x0	0x0/0x0	0x07	0x08	0x03	0x01
Fast	60 MHz	400 kbps	0x1	0x2/0x2	0x11	0x28	0x1F	0x08
Fast+	60 MHz	1 Mbps	0x1	0x2/0x2	0x07	0x0F	0x0B	0x01
HS-mode	60 MHz	3.33 Mbps	0x1	0x0/0x0	0x04	0x04	0x02	0x01

52.3.2.5 Error Conditions

The LPI2C master will monitor for errors while it is active, the following conditions will generate an error flag and block a new START condition from being sent, until the flag is cleared by software:

- A START or STOP condition is detected and is not generated by the LPI2C master (sets MSR[ALF]).
- Transmitting data on SDA and different values are being received (sets MSR[ALF]).
- NACK is detected when transmitting data, and MCFGR1[IGNACK] is clear (sets MSR[NDF]).
- NACK is detected and is expecting ACK for the address byte, and MCFGR1[IGNACK] is clear (sets MSR[NDF]).

- ACK is detected and is expecting NACK for the address byte, and MCFGR1[IGNACK] is clear (sets MSR[NDF]).
- Transmit FIFO is requesting to transmit or receive data without a START condition (sets MSR[FEF]).
- SCL (or SDA if MCFGR1[TIMECFG] is set) is low for (MCFGR2[TIMELOW] * 256) prescaler cycles without a pin transition (sets MSR[PLTF]).

Software must respond to the MSR[PTLF] flag to terminate the existing command either cleanly (by clearing MCR[MEN]), or abruptly (by setting MCR[SWRST]).

The MCFGR2[BUSIDLE] field can be used to force the I2C bus to be considered idle when SCL and SDA remain high for (BUSIDLE+1) prescaler cycles. The I2C bus is normally considered idle when the LPI2C master is first enabled, but when BUSIDLE is configured greater than zero then SCL and/or SDA must be high for (BUSIDLE+1) prescaler cycles before the I2C bus is first considered idle.

52.3.2.6 Pin Configuration

- **Open-drain support:** The LPI2C master defaults to open-drain configuration of the SDA and SCL pins. Support for true open drain depends on the specific device, and requires the pins where LPI2C pins are muxed to support true open drain.
- **High Speed mode support:** Support for high speed mode also depends on the specific device, and requires the SCL pin to support the current source pull-up required in the I2C specification.
- **Ultra-Fast mode support:** The LPI2C master also supports the output-only push-pull function required for I2C ultra-fast mode using the SDA and SCL pins. Support for ultra-fast mode also requires the IGNACK bit to be set.
- **Push-pull 2-wire support:** A push-pull 2-wire configuration is also available to the LPI2C master that may support a partial high speed mode, if the LPI2C is the only master and all I2C pins on the bus are at the same voltage. This will configure the SCL pin as push-pull for every clock except the 9th clock pulse, to allow high speed mode compatible slaves to perform clock stretching. In this mode, the SDA pin is tristated for master-receive data bits and master-transmit ACK/NACK bits, and is configured as push-pull at other times. To avoid the risk of contention when SDA is push-pull, the pin can be configured for open-drain operation, as part of the device-specific configuration.
- **Push-pull 4-wire support:** The push-pull 4-wire configuration separates the SCL input data and output data into separate pins, and separates the SDA input data and output data into separate pins. The SCL/SDA pins are used for input data; the SCLS/SDAS pins are used for output data, with configurable polarity. This simplifies external connections when connecting the LPI2C to the I2C bus through external level shifters or discrete components. When using this 4-wire configuration, the

LPI2C master logic and LPI2C slave logic are not able to connect to separate I2C buses.

52.3.3 Slave Mode

To perform all slave mode transfers on the I2C bus, the LPI2C slave logic operates independently from the LPI2C master logic.

52.3.3.1 Address Matching

The LPI2C slave can be configured:

- to match one of two addresses, using either 7-bit or 10-bit addressing modes for each address
- to match a range of addresses in either 7-bit or 10-bit addressing modes
- to match the General Call Address, and generate appropriate flags
- to match the SMBus Alert Address, and generate appropriate flags
- to detect the high speed mode master code, and to disable the digital filters and output valid delay time until the next STOP condition is detected

After a valid address is matched, the LPI2C slave will automatically perform slave-transmit or slave-receive transfers until:

- a NACK is detected (unless IGNACK is set)
- a bit error is detected (the LPI2C slave is driving SDA, but a different value is sampled)
- a (repeated) START or STOP condition is detected

52.3.3.2 Transmit and Receive Data

- The Transmit and Receive Data registers are double-buffered and only update during a slave-transmit and slave-receive transfer, respectively.
- The slave address *that was received* can be configured to be read from either the Receive Data register (for example, when using DMA to transfer data), or from the Address Status register.
- The Transmit Data register can be configured to only request data after a slave-transmit transfer is detected, or to request new data whenever the Transmit Data register is empty.
- The Transmit Data register should only be written when the Transmit Data flag is set.
- The Receive Data register should only be read when the Received Data flag is set (or the Address Valid flag is set and RXCFG=1).
- The Address Status register should only be read when the Address Valid flag is set.

52.3.3.3 Clock Stretching

The LPI2C slave supports many configurable options for when clock stretching is performed. The following conditions can be configured to perform clock stretching:

- During the 9th clock pulse of the address byte and the Address Valid flag is set.
- During the 9th clock pulse of a slave-transmit transfer and the Transmit Data flag is set.
- During the 9th clock pulse of a slave-receive transfer and the Receive Data flag is set.
- During the 8th clock pulse of an address byte or a slave-receive transfer and the Transmit ACK flag is set. In high speed mode, this is disabled.
- Clock stretching can also be extended for CLKHOLD cycles, to allow additional setup time to sample the SDA pin externally. In high speed mode, this is disabled.

Unless extended by the CLKHOLD configuration, clock stretching will extend for one peripheral bus clock cycle after SDA updates when clock stretching is enabled.

52.3.3.4 Timing Parameters

The LPI2C slave can configure the following timing parameters. These parameters are disabled when SCR[FILTEN] is clear, when SCR[FILTDZ] is set in Doze mode, and when LPI2C slave detects high speed mode. When disabled, the LPI2C slave is clocked directly from the I2C bus, and may not satisfy all timing requirements of the I2C specification (such as SDA minimum hold time in Standard/Fast mode).

- SDA data valid time from SCL negation to SDA update
- SCL hold time when clock stretching is enabled to increase setup time when sampling SDA externally
- SCL glitch filter time
- SDA glitch filter time

The LPI2C slave imposes the following restrictions on the timing parameters.

- FILTSDA must be configured to greater than or equal to FILTSCL (unless compensating for board level skew between SDA and SCL).
- DATAVD must be configured less than the minimum SCL low period.

52.3.3.5 Error Conditions

The LPI2C slave can detect the following error conditions:

Functional description

- Bit error flag will set when the I2C slave is driving SDA, but samples a different value than what is expected.
- FIFO error flag will set due to a transmit data underrun or a receive data overrun. To eliminate the possibility of underrun and overrun occurring, enable clock stretching.
- FIFO error flag will also set due to an address overrun when RXCFG is set, otherwise an address overrun is not flagged. To eliminate the possibility of overrun occurring, enable clock stretching.

The I2C slave does not implement a timeout due to SCL and/or SDA being stuck low. If this detection is required, then the I2C master logic should be used and so software can reset the I2C slave when this condition is detected.

52.3.4 Interrupts and DMA Requests

Depending on the specific device, interrupts and DMA requests can be combined in some ways:

- The I2C master and slave interrupts may be combined
- The I2C master and slave transmit DMA requests may be combined
- The I2C master and slave receive DMA requests may be combined

52.3.4.1 Master mode

The next table lists the master mode sources that can generate I2C master interrupts and I2C master transmit/receive DMA requests.

Table 52-10. Master Interrupts and DMA Requests

Master Status Register (MSR)		Description	Can generate		
Flag	Name		Interrupt?	DMA Request?	Low Power Wakeup?
TDF	Transmit Data Flag	Data can be written to Transmit FIFO, as configured by the Transmit FIFO Watermark MFCR[TXWATER]	Y	TX	Y
RDF	Receive Data Flag	Data can be read from the Receive FIFO, as configured by the Receive FIFO Watermark MFCR[RXWATER]	Y	RX	Y
EPF	End Packet Flag	Master has transmitted a Repeated START or STOP condition	Y	N	Y
SDF	STOP Detect Flag	Master has transmitted a STOP condition	Y	N	Y
NDF	NACK Detect Flag	<ul style="list-style-type: none">• During an address byte, the master expected an ACK but detected a NACK	Y	N	Y

Table continues on the next page...

Table 52-10. Master Interrupts and DMA Requests (continued)

Master Status Register (MSR)		Description	Can generate		
Flag	Name		Interrupt?	DMA Request?	Low Power Wakeup?
		<ul style="list-style-type: none"> During an address byte, the master expected a NACK but detected an ACK During a master-transmitter data byte, the master detected a NACK 			
ALF	Arbitration Lost Flag	<ul style="list-style-type: none"> The master lost arbitration due to a START/STOP condition detected at the wrong time Or the master was transmitting data but received different data than the data that was transmitted 	Y	N	Y
FEF	FIFO Error Flag	The master is expecting a START condition in the Command FIFO, but the next entry in the Command FIFO is not a START condition	Y	N	Y
PLTF	Pin Low Timeout Flag	Pin low timeout is enabled and SCL (or SDA if configured) is low for longer than the configured timeout	Y	N	Y
DMF	Data Match Flag	The received data matches the configured data match, but the received data is not discarded due to a command FIFO entry	Y	N	Y
MBF	Master Busy Flag	LPI2C master is busy transmitting/receiving data	N	N	N
BBF	Bus Busy Flag	LPI2C master is enabled and activity is detected on I2C bus, but a STOP condition has not been detected and a bus idle timeout (if enabled) has not occurred.	N	N	N

52.3.4.2 Slave mode

The next table lists the slave mode sources that can generate LPI2C slave interrupts and the LPI2C slave transmit/receive DMA requests.

Table 52-11. Slave Interrupts and DMA Requests

Slave Status Register (SSR)		Description	Can generate		
Flag	Name		Interrupt?	DMA Request?	Low Power Wakeup?
TDF	Transmit Data Flag	Data can be written to the Slave Transmit Data Register (STDR)	Y	TX	Y
RDF	Receive Data Flag	Data can be read from the Slave Receive Data Register (SRDR)	Y	RX	Y
AVF	Address Valid Flag	Address can be read from the Slave Address Status Register (SASR)	Y	RX	Y

Table continues on the next page...

Table 52-11. Slave Interrupts and DMA Requests (continued)

Slave Status Register (SSR)		Description	Can generate		
Flag	Name		Interrupt?	DMA Request?	Low Power Wakeup?
TAF	Transmit ACK Flag	ACK/NACK can be written to the Slave Transmit ACK Register (STAR)	Y	N	Y
RSF	Repeated Start Flag	Slave has detected an address match followed by a Repeated START condition	Y	N	Y
SDF	STOP Detect Flag	Slave has detected an address match followed by a STOP condition	Y	N	Y
BEF	Bit Error Flag	Slave was transmitting data, but received different data than what was transmitted	Y	N	Y
FEF	FIFO Error Flag	<ul style="list-style-type: none"> • Transmit data underrun • Receive data overrun • Address status overrun (when Receive Data Configuration SCFGR1[RXCFG] = 1,) <p>FEF flag can only set when clock stretching is disabled.</p>	Y	N	Y
AM0F	Address Match 0 Flag	Slave detected an address match with SAMR[ADDR0] field	Y	N	N
AM1F	Address Match 1 Flag	Slave detected an address match with SAMR[ADDR1] field or using an address range	Y	N	N
GCF	General Call Flag	Slave detected an address match with the General Call address	Y	N	N
SARF	SMBus Alert Response Flag	Slave detected an address match with the SMBus Alert address	Y	N	N
SBF	Slave Busy Flag	LPI2C slave is busy receiving an address byte or is transmitting/receiving data	N	N	N
BBF	Bus Busy Flag	LPI2C slave is enabled and a START condition is detected on I2C bus, but a STOP condition has not been detected	N	N	N

52.3.5 Peripheral Triggers

The connection of the LPI2C peripheral triggers to other peripherals depend upon the specific device being used.

Table 52-12. LPI2C Triggers

Trigger	Description
Master Output Trigger	The LPI2C master generates an output trigger that can be connected to other peripherals on the device. The master output trigger asserts on both a Repeated START or STOP condition, and the master output trigger remains asserted for one cycle of the LPI2C functional clock divided by the prescaler.
Slave Output Trigger	The LPI2C slave generates an output trigger that can be connected to other peripherals on the device. The slave output trigger asserts on both a Repeated START or STOP condition that occurs after a slave address match, and the slave output trigger remains asserted until the next slave SCL pin negation.
Input Trigger	To control the start of a LPI2C bus transfer, the LPI2C input trigger can be selected instead of the HREQ input. The input trigger is synchronized and to be detected, the input trigger must assert for at least 2 cycles of the LPI2C functional clock divided by the PRESCALE configuration. When the LPI2C is busy, the HREQ input (and therefore the input trigger) is ignored.

52.4 Memory Map and Registers

NOTE

Writing a Read-Only (RO) register or reading a Write-Only (WO) register can cause bus errors. This module will not check if programmed values in the registers are correct; the application software must ensure that valid programmed values are being written.

52.4.1 LPI2C register descriptions

52.4.1.1 LPI2C memory map

LPI2C0 base address: 4006_6000h

LPI2C1 base address: 4006_7000h

Memory Map and Registers

Offset	Register	Width (In bits)	Access	Reset value
0h	Version ID Register (VERID)	32	RO	0100_0003h
4h	Parameter Register (PARAM)	32	RO	0000_0202h
10h	Master Control Register (MCR)	32	RW	0000_0000h
14h	Master Status Register (MSR)	32	W1C	0000_0001h
18h	Master Interrupt Enable Register (MIER)	32	RW	0000_0000h
1Ch	Master DMA Enable Register (MDER)	32	RW	0000_0000h
20h	Master Configuration Register 0 (MCFGR0)	32	RW	0000_0000h
24h	Master Configuration Register 1 (MCFGR1)	32	RW	0000_0000h
28h	Master Configuration Register 2 (MCFGR2)	32	RW	0000_0000h
2Ch	Master Configuration Register 3 (MCFGR3)	32	RW	0000_0000h
40h	Master Data Match Register (MDMR)	32	RW	0000_0000h
48h	Master Clock Configuration Register 0 (MCCR0)	32	RW	0000_0000h
50h	Master Clock Configuration Register 1 (MCCR1)	32	RW	0000_0000h
58h	Master FIFO Control Register (MFCR)	32	RW	0000_0000h
5Ch	Master FIFO Status Register (MFSR)	32	RO	0000_0000h
60h	Master Transmit Data Register (MTDR)	32	WO	0000_0000h
70h	Master Receive Data Register (MRDR)	32	RO	0000_4000h
110h	Slave Control Register (SCR)	32	RW	0000_0000h
114h	Slave Status Register (SSR)	32	W1C	0000_0000h
118h	Slave Interrupt Enable Register (SIER)	32	RW	0000_0000h
11Ch	Slave DMA Enable Register (SDER)	32	RW	0000_0000h
124h	Slave Configuration Register 1 (SCFGR1)	32	RW	0000_0000h
128h	Slave Configuration Register 2 (SCFGR2)	32	RW	0000_0000h
140h	Slave Address Match Register (SAMR)	32	RW	0000_0000h
150h	Slave Address Status Register (SASR)	32	RO	0000_4000h
154h	Slave Transmit ACK Register (STAR)	32	RW	0000_0000h
160h	Slave Transmit Data Register (STDR)	32	WO	0000_0000h
170h	Slave Receive Data Register (SRDR)	32	RO	0000_4000h

52.4.1.2 Version ID Register (VERID)

52.4.1.2.1 Offset

Register	Offset
VERID	0h

52.4.1.2.2 Function

Contains version numbers for the module design and feature set.

52.4.1.2.3 Diagram

Bits	31	30	29	28	27	26	25	24	23	22	21	20	19	18	17	16
R	MAJOR								MINOR							
W																
Reset	0	0	0	0	0	0	0	1	0	0	0	0	0	0	0	0
Bits	15	14	13	12	11	10	9	8	7	6	5	4	3	2	1	0
R	FEATURE															
W																
Reset	0	0	0	0	0	0	0	0	0	0	0	0	0	0	1	1

52.4.1.2.4 Fields

Field	Function
31-24 MAJOR	Major Version Number Returns the major version number for the module design specification. Read-only field.
23-16 MINOR	Minor Version Number Returns the minor version number for the module design specification. Read-only field.
15-0 FEATURE	Feature Specification Number Returns the feature set number. Read-only field. 0000000000000010b - Master only, with standard feature set 0000000000000011b - Master and slave, with standard feature set

52.4.1.3 Parameter Register (PARAM)

52.4.1.3.1 Offset

Register	Offset
PARAM	4h

52.4.1.3.2 Function

Contains parameter values that were implemented in the module.

52.4.1.3.3 Diagram

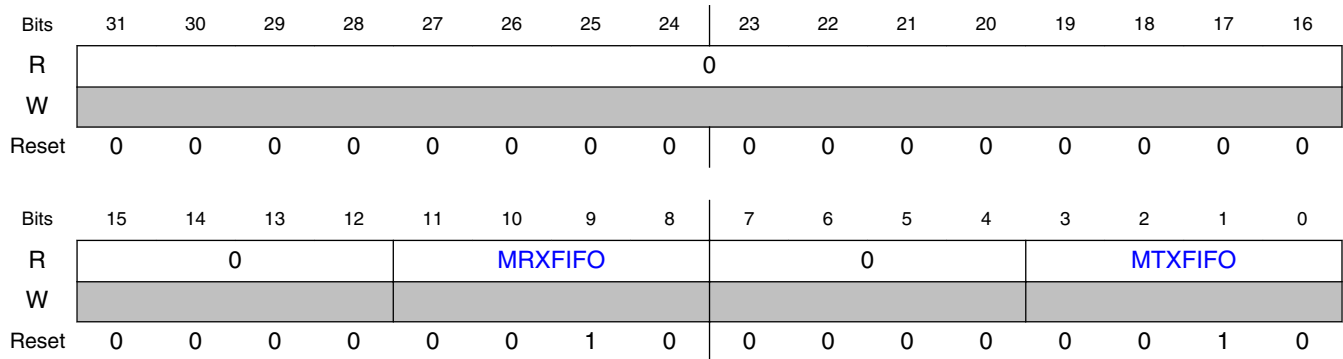

52.4.1.3.4 Fields

Field	Function
31-16 —	Reserved
15-12 —	Reserved
11-8 MRXFIFO	Master Receive FIFO Size Configures the number of words in the master receive FIFO to 2^{MRXFIFO}
7-4 —	Reserved
3-0 MTXFIFO	Master Transmit FIFO Size Configures the number of words in the master transmit FIFO to 2^{MTXFIFO}

52.4.1.4 Master Control Register (MCR)

52.4.1.4.1 Offset

Register	Offset
MCR	10h

52.4.1.4.2 Diagram

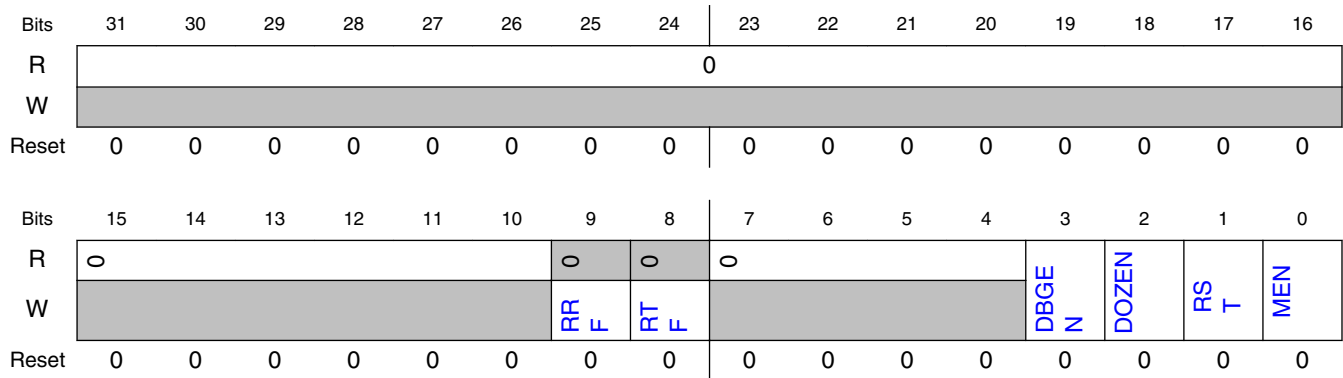

52.4.1.4.3 Fields

Field	Function
31-10 —	Reserved
9 RRF	Reset Receive FIFO 0b - No effect 1b - Receive FIFO is reset
8 RTF	Reset Transmit FIFO 0b - No effect 1b - Transmit FIFO is reset
7-4 —	Reserved
3 DBGEN	Debug Enable 0b - Master is disabled in debug mode 1b - Master is enabled in debug mode
2 DOZEN	Doze mode enable Enables or disables the master in Doze mode 0b - Master is enabled in Doze mode 1b - Master is disabled in Doze mode
1 RST	Software Reset Reset all internal master logic and registers, except the Master Control Register. RST remains set until cleared by software. The reset takes effect immediately and remains asserted until negated by software. There is no minimum delay required before clearing the software reset. 0b - Master logic is not reset 1b - Master logic is reset
0 MEN	Master Enable 0b - Master logic is disabled 1b - Master logic is enabled

52.4.1.5 Master Status Register (MSR)

52.4.1.5.1 Offset

Register	Offset
MSR	14h

52.4.1.5.2 Diagram

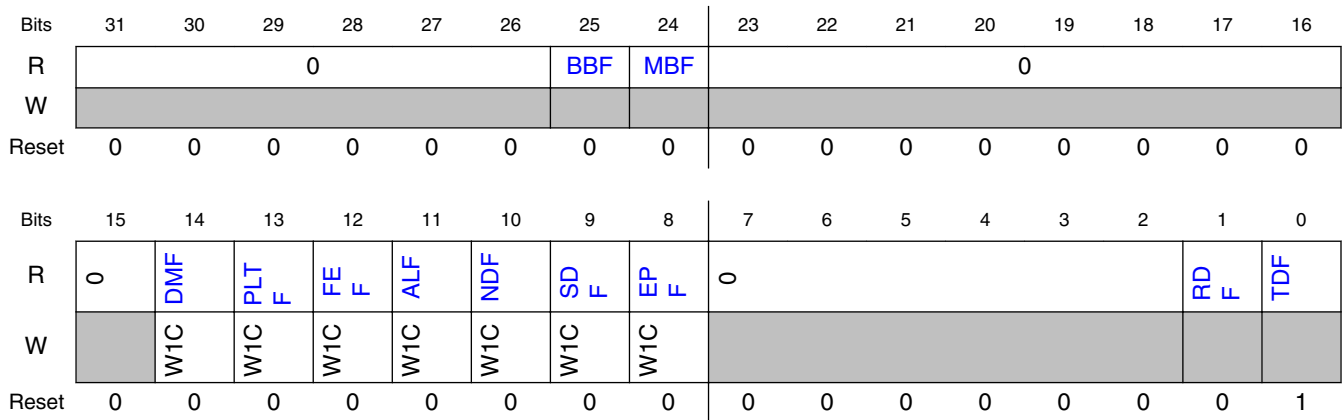

52.4.1.5.3 Fields

Field	Function
31-26 —	Reserved
25 BBF	Bus Busy Flag 0b - I2C Bus is idle 1b - I2C Bus is busy
24 MBF	Master Busy Flag 0b - I2C Master is idle 1b - I2C Master is busy
23-15 —	Reserved
14 DMF	Data Match Flag Indicates that the received data has matched the MATCH0 and/or MATCH1 fields (as configured by MCFGR1[MATCFG], Match Configuration). Received data <i>that is discarded due to CMD field</i> does not cause Data Match Flag to set. 0b - Have not received matching data 1b - Have received matching data
13	Pin Low Timeout Flag

Table continues on the next page...

Field	Function
PLTF	<p>Will set when the SCL and/or SDA input is low for more than PINLOW cycles (Pin Low Timeout, MCFGR3[PINLOW]), even when the LPI2C master is idle.</p> <ul style="list-style-type: none"> • Software is responsible for resolving the pin low condition. • Pin Low Timeout Flag cannot be cleared as long as the pin low timeout continues. • Before the LPI2C can initiate a START condition, the Pin Low Timeout Flag must be cleared. <p>0b - Pin low timeout has not occurred or is disabled 1b - Pin low timeout has occurred</p>
12 FEF	<p>FIFO Error Flag</p> <p>Detects an attempt to send or receive data without first generating a (repeated) START condition. This can occur if the transmit FIFO underflows when the AUTOSTOP bit is set. When FIFO Error Flag is set, the LPI2C master will send a STOP condition (if busy), and will not initiate a new START condition until FIFO Error Flag has been cleared.</p> <p>0b - No error 1b - Master sending or receiving data without a START condition</p>
11 ALF	<p>Arbitration Lost Flag</p> <p>Set:</p> <ul style="list-style-type: none"> • if the LPI2C master transmits a logic one and detects a logic zero on the I2C bus • or if the LPI2C master detects a START or STOP condition while the LPI2C master is transmitting data <p>When the Arbitration Lost Flag sets, the LPI2C master will release the I2C bus (go idle), and the LPI2C master will not initiate a new START condition until the Arbitration Lost Flag has been cleared.</p> <p>0b - Master has not lost arbitration 1b - Master has lost arbitration</p>
10 NDF	<p>NACK Detect Flag</p> <p>Set if the LPI2C master detects a NACK when transmitting an address or data. When set, the master will transmit a STOP condition and will not initiate a new START condition until NACK Detect Flag has been cleared. If a NACK is expected for a given address (as configured by the command word), then the NACK Detect Flag will set if a NACK is not generated.</p> <p>0b - Unexpected NACK was not detected 1b - Unexpected NACK was detected</p>
9 SDF	<p>STOP Detect Flag</p> <p>Set when the LPI2C master generates a STOP condition.</p> <p>0b - Master has not generated a STOP condition 1b - Master has generated a STOP condition</p>
8 EPF	<p>End Packet Flag</p> <p>Set when the LPI2C master generates either a repeated START condition or a STOP condition. Does not set when the master first generates a START condition.</p> <p>0b - Master has not generated a STOP or Repeated START condition 1b - Master has generated a STOP or Repeated START condition</p>
7-2 —	Reserved
1 RDF	<p>Receive Data Flag</p> <p>The Receive Data Flag is set whenever the number of words in the receive FIFO is greater than RXWATER.</p> <p>0b - Receive Data is not ready 1b - Receive data is ready</p>
0 TDF	<p>Transmit Data Flag</p>

Memory Map and Registers

Field	Function
	The Transmit Data Flag is set whenever the number of words in the transmit FIFO is equal or less than TXWATER. 0b - Transmit data is not requested 1b - Transmit data is requested

52.4.1.6 Master Interrupt Enable Register (MIER)

52.4.1.6.1 Offset

Register	Offset
MIER	18h

52.4.1.6.2 Diagram

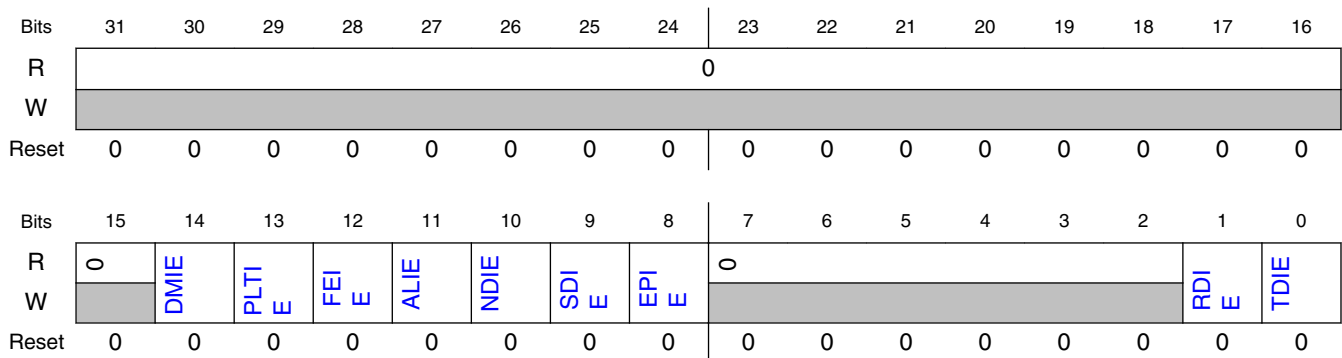

52.4.1.6.3 Fields

Field	Function
31-15 —	Reserved
14 DMIE	Data Match Interrupt Enable 0b - Disabled 1b - Enabled
13 PLTIE	Pin Low Timeout Interrupt Enable 0b - Disabled 1b - Enabled
12 FEIE	FIFO Error Interrupt Enable 0b - Enabled 1b - Disabled

Table continues on the next page...

Field	Function
11 ALIE	Arbitration Lost Interrupt Enable 0b - Disabled 1b - Enabled
10 NDIE	NACK Detect Interrupt Enable 0b - Disabled 1b - Enabled
9 SDIE	STOP Detect Interrupt Enable 0b - Disabled 1b - Enabled
8 EPIE	End Packet Interrupt Enable 0b - Disabled 1b - Enabled
7-2 —	Reserved
1 RDIE	Receive Data Interrupt Enable 0b - Disabled 1b - Enabled
0 TDIE	Transmit Data Interrupt Enable 0b - Disabled 1b - Enabled

52.4.1.7 Master DMA Enable Register (MDER)

52.4.1.7.1 Offset

Register	Offset
MDER	1Ch

52.4.1.7.2 Diagram

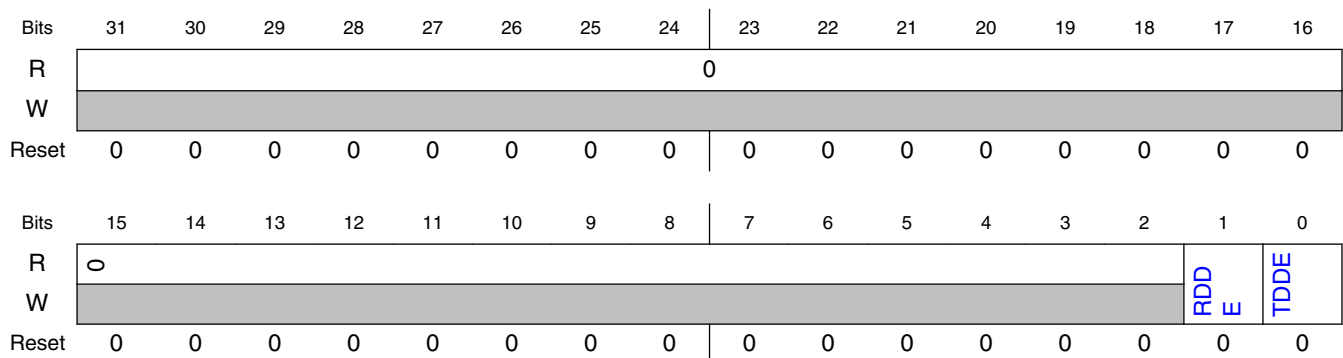

52.4.1.7.3 Fields

Field	Function
31-2 —	Reserved
1 RDDE	Receive Data DMA Enable 0b - DMA request is disabled 1b - DMA request is enabled
0 TDDE	Transmit Data DMA Enable 0b - DMA request is disabled 1b - DMA request is enabled

52.4.1.8 Master Configuration Register 0 (MCFGR0)

52.4.1.8.1 Offset

Register	Offset
MCFGR0	20h

52.4.1.8.2 Diagram

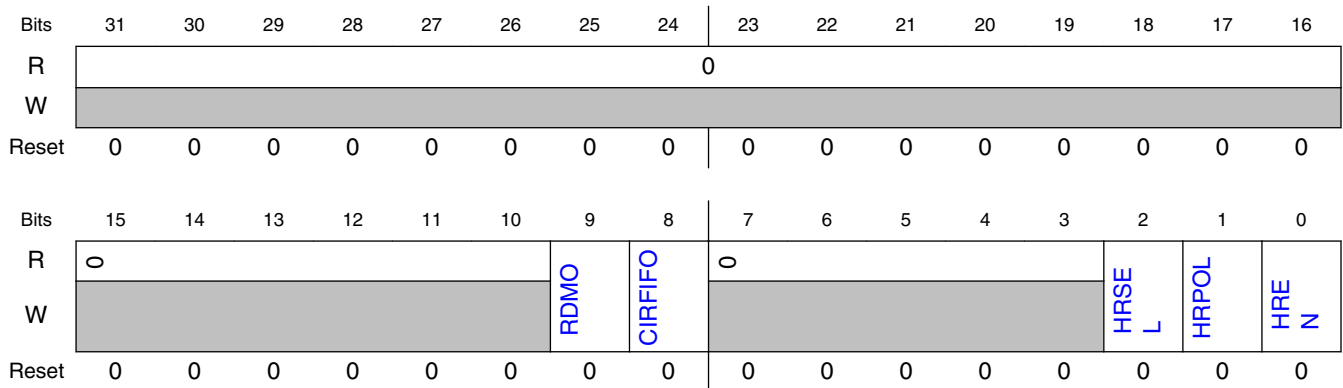

52.4.1.8.3 Fields

Field	Function
31-10 —	Reserved
9	Receive Data Match Only

Table continues on the next page...

Field	Function
RDMO	When enabled, all received data that does not cause the Data Match Flag (MSR[DMF]) to set is discarded. After the Data Match Flag is set, the RDMO configuration is ignored. When disabling RDMO, clear RDMO before clearing the Data Match Flag, to ensure that no receive data is lost. 0b - Received data is stored in the receive FIFO 1b - Received data is discarded unless the the Data Match Flag (MSR[DMF]) is set
8 CIRFIFO	Circular FIFO Enable When enabled, the transmit FIFO read pointer is saved to a temporary register. The transmit FIFO will be emptied as normal, but after the LPI2C master is idle and the transmit FIFO is empty, then the read pointer value will be restored from the temporary register. This will cause the contents of the transmit FIFO to be cycled through repeatedly. If AUTOSTOP is set, then a STOP condition will be sent whenever the transmit FIFO is empty and the read pointer is restored. 0b - Circular FIFO is disabled 1b - Circular FIFO is enabled
7-3 —	Reserved
2 HRSEL	Host Request Select Selects the source of the host request input. When host request input is enabled, the Host Request Select field should remain static (the Host Request Select should not change). 0b - Host request input is pin HREQ 1b - Host request input is input trigger
1 HRPOL	Host Request Polarity Configures the polarity of the host request input pin. When host request input is enabled, the Host Request Polarity field should remain static (Host Request Polarity should not change). 0b - Active low 1b - Active high
0 HREN	Host Request Enable When enabled, the LPI2C master will only initiate a START condition if the host request input is asserted and the bus is idle. A repeated START is not affected by the host request. 0b - Host request input is disabled 1b - Host request input is enabled

52.4.1.9 Master Configuration Register 1 (MCFGR1)

52.4.1.9.1 Offset

Register	Offset
MCFGR1	24h

52.4.1.9.2 Function

The MCFGR1 should only be written when the I2C Master is disabled.

52.4.1.9.3 Diagram

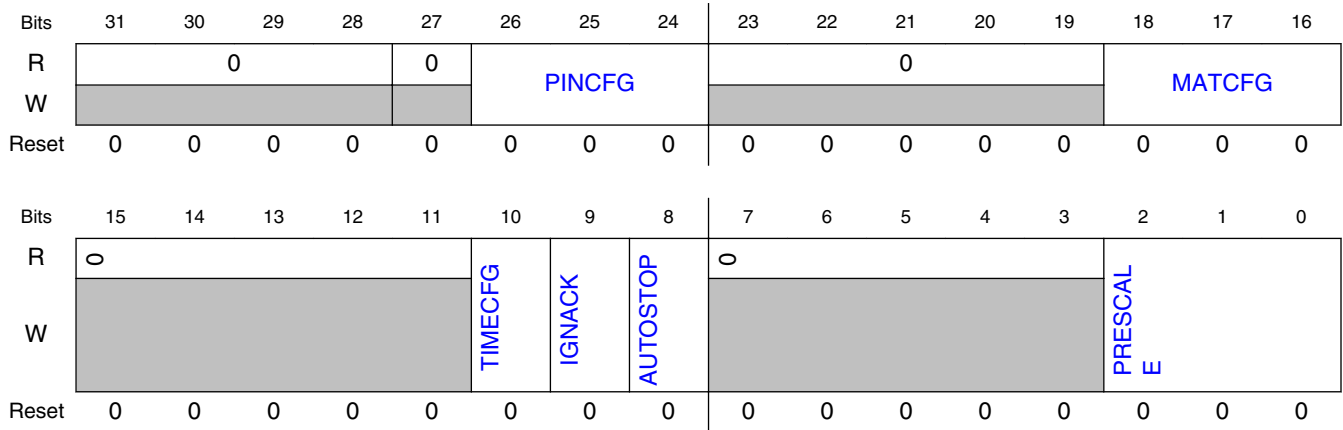

52.4.1.9.4 Fields

Field	Function																											
31-28 —	Reserved																											
27 —	Reserved																											
26-24 PINCFG	Pin Configuration Configures the pin mode for LPI2C. Table 52-13. 2-pin / 4-pin pin configurations for masters and slaves <table border="1" style="width: 100%; border-collapse: collapse;"> <thead> <tr> <th>PINCFG</th> <th>SCL / SDA pins</th> <th>SCLS / SDAS pins</th> </tr> </thead> <tbody> <tr> <td>000</td> <td>Bi-directional open drain for master and slave</td> <td>Not used</td> </tr> <tr> <td>001</td> <td>Output-only (ultra-fast mode) open drain for master and slave</td> <td>Not used</td> </tr> <tr> <td>010</td> <td>Bi-directional push-pull for master and slave</td> <td>Not used</td> </tr> <tr> <td>011</td> <td>Input only for master and slave</td> <td>Output-only push-pull for master and slave</td> </tr> <tr> <td>100</td> <td>Bi-directional open drain for master</td> <td>Bi-directional open drain for slave</td> </tr> <tr> <td>101</td> <td>Output-only (ultra-fast mode) open drain for master</td> <td>Output-only open drain for slave</td> </tr> <tr> <td>110</td> <td>Bi-directional push-pull for master</td> <td>Bi-directional push-pull for slave</td> </tr> <tr> <td>111</td> <td>Input only for master and slave</td> <td>Inverted output-only push-pull for master and slave</td> </tr> </tbody> </table> 000b - 2-pin open drain mode 001b - 2-pin output only mode (ultra-fast mode) 010b - 2-pin push-pull mode 011b - 4-pin push-pull mode	PINCFG	SCL / SDA pins	SCLS / SDAS pins	000	Bi-directional open drain for master and slave	Not used	001	Output-only (ultra-fast mode) open drain for master and slave	Not used	010	Bi-directional push-pull for master and slave	Not used	011	Input only for master and slave	Output-only push-pull for master and slave	100	Bi-directional open drain for master	Bi-directional open drain for slave	101	Output-only (ultra-fast mode) open drain for master	Output-only open drain for slave	110	Bi-directional push-pull for master	Bi-directional push-pull for slave	111	Input only for master and slave	Inverted output-only push-pull for master and slave
PINCFG	SCL / SDA pins	SCLS / SDAS pins																										
000	Bi-directional open drain for master and slave	Not used																										
001	Output-only (ultra-fast mode) open drain for master and slave	Not used																										
010	Bi-directional push-pull for master and slave	Not used																										
011	Input only for master and slave	Output-only push-pull for master and slave																										
100	Bi-directional open drain for master	Bi-directional open drain for slave																										
101	Output-only (ultra-fast mode) open drain for master	Output-only open drain for slave																										
110	Bi-directional push-pull for master	Bi-directional push-pull for slave																										
111	Input only for master and slave	Inverted output-only push-pull for master and slave																										

Table continues on the next page...

Field	Function
	100b - 2-pin open drain mode with separate LPI2C slave 101b - 2-pin output only mode (ultra-fast mode) with separate LPI2C slave 110b - 2-pin push-pull mode with separate LPI2C slave 111b - 4-pin push-pull mode (inverted outputs)
23-19 —	Reserved
18-16 MATCFG	Match Configuration Configures the condition that will cause the DMF to set. 000b - Match is disabled 001b - Reserved 010b - Match is enabled (1st data word equals MATCH0 OR MATCH1) 011b - Match is enabled (any data word equals MATCH0 OR MATCH1) 100b - Match is enabled (1st data word equals MATCH0 AND 2nd data word equals MATCH1) 101b - Match is enabled (any data word equals MATCH0 AND next data word equals MATCH1) 110b - Match is enabled (1st data word AND MATCH1 equals MATCH0 AND MATCH1) 111b - Match is enabled (any data word AND MATCH1 equals MATCH0 AND MATCH1)
15-11 —	Reserved
10 TIMECFG	Timeout Configuration 0b - Pin Low Timeout Flag will set if SCL is low for longer than the configured timeout 1b - Pin Low Timeout Flag will set if either SCL or SDA is low for longer than the configured timeout
9 IGNACK	IGNACK When set, the received NACK field is ignored and assumed to be ACK. IGNACK bit is required to be set in Ultra-Fast Mode. 0b - LPI2C Master will receive ACK and NACK normally 1b - LPI2C Master will treat a received NACK as if it (NACK) was an ACK
8 AUTOSTOP	Automatic STOP Generation When enabled, a STOP condition is generated whenever the LPI2C master is busy and the transmit FIFO is empty. The STOP condition can also be generated using a transmit FIFO command. 0b - No effect 1b - STOP condition is automatically generated whenever the transmit FIFO is empty and the LPI2C master is busy
7-3 —	Reserved
2-0 PRESCALE	Prescaler Configures the clock prescaler used for all LPI2C master logic, except for the digital glitch filters. 000b - Divide by 1 001b - Divide by 2 010b - Divide by 4 011b - Divide by 8 100b - Divide by 16 101b - Divide by 32 110b - Divide by 64 111b - Divide by 128

52.4.1.10 Master Configuration Register 2 (MCFGR2)

52.4.1.10.1 Offset

Register	Offset
MCFGR2	28h

52.4.1.10.2 Function

The Master Configuration Register 2 should only be written when the I2C Master is disabled.

52.4.1.10.3 Diagram

Bits	31	30	29	28	27	26	25	24	23	22	21	20	19	18	17	16
R	0				FILTSDA				0				FILTSCS			
W	—				—				—				—			
Reset	0	0	0	0	0	0	0	0	0	0	0	0	0	0	0	0
Bits	15	14	13	12	11	10	9	8	7	6	5	4	3	2	1	0
R	0				BUSIDLE											
W	—				—											
Reset	0	0	0	0	0	0	0	0	0	0	0	0	0	0	0	0

52.4.1.10.4 Fields

Field	Function
31-28 —	Reserved
27-24 FILTSDA	Glitch Filter SDA Configures the I2C master digital glitch filters for SDA input. <ul style="list-style-type: none"> • A configuration of 0 will disable the glitch filter • Glitches equal to or less than FILTSDA cycles long will be filtered out and ignored • The latency through the glitch filter is equal to FILTSDA cycles, and must be configured to be less than the minimum SCL low or high period • The glitch filter cycle count is not affected by the PRESCALE configuration, and the glitch filter cycle count is automatically bypassed in High Speed mode
23-20 —	Reserved
19-16 FILTSCS	Glitch Filter SCL Configures the I2C master digital glitch filters for SCL input.

Table continues on the next page...

Field	Function
	<ul style="list-style-type: none"> • A configuration of 0 will disable the glitch filter • Glitches equal to or less than FILTSCCL cycles long will be filtered out and ignored • The latency through the glitch filter is equal to FILTSCCL cycles, and must be configured to be less than the minimum SCL low or high period • The glitch filter cycle count is not affected by the PRESCALE configuration, and the glitch filter cycle count is automatically bypassed in High Speed mode
15-12 —	Reserved
11-0 BUSIDLE	Bus Idle Timeout Configures the bus idle timeout period in clock cycles. <ul style="list-style-type: none"> • If both SCL and SDA are high for longer than BUSIDLE cycles, then the I2C bus is assumed to be idle and the master can generate a START condition • When Bus Idle Timeout is set to zero, the Bus Idle Timeout is disabled

52.4.1.11 Master Configuration Register 3 (MCFGR3)

52.4.1.11.1 Offset

Register	Offset
MCFGR3	2Ch

52.4.1.11.2 Function

The MCFGR3 should only be written when the I2C Master is disabled.

52.4.1.11.3 Diagram

Bits	31	30	29	28	27	26	25	24	23	22	21	20	19	18	17	16
R	0															
W	[Greyed out]												PINLOW			
Reset	0	0	0	0	0	0	0	0	0	0	0	0	0	0	0	0
Bits	15	14	13	12	11	10	9	8	7	6	5	4	3	2	1	0
R									0							
W	PINLOW								[Greyed out]							
Reset	0	0	0	0	0	0	0	0	0	0	0	0	0	0	0	0

52.4.1.11.4 Fields

Field	Function
31-20 —	Reserved
19-8 PINLOW	Pin Low Timeout Configures the pin low timeout flag in clock cycles. <ul style="list-style-type: none"> • If SCL or, either SCL or SDA, is low for longer than (PINLOW * 256) cycles, then PLTF is set • When Pin Low Timeout is set to zero, the Pin Low Timeout feature is disabled
7-0 —	Reserved

52.4.1.12 Master Data Match Register (MDMR)

52.4.1.12.1 Offset

Register	Offset
MDMR	40h

52.4.1.12.2 Function

The MDMR should only be written when the I2C Master is disabled or idle.

52.4.1.12.3 Diagram

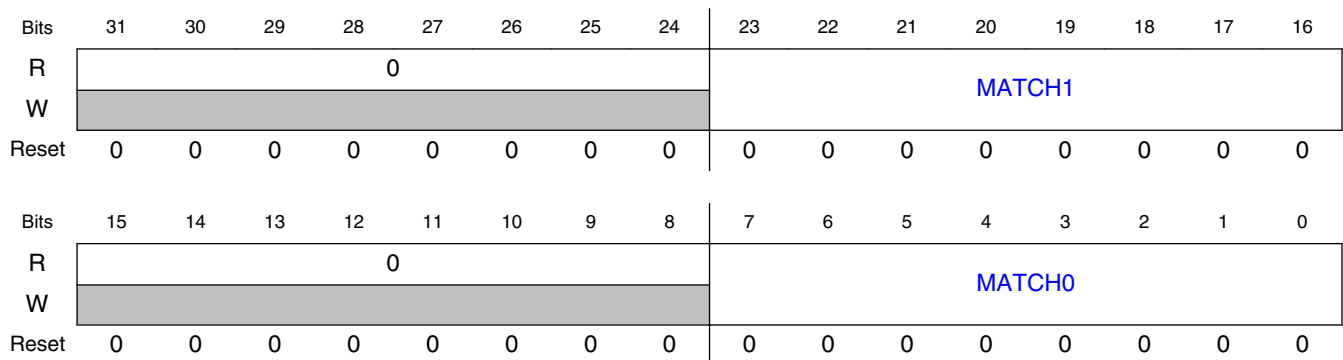

52.4.1.12.4 Fields

Field	Function
31-24 —	Reserved
23-16 MATCH1	Match 1 Value Compared against the received data when receive data match is enabled.
15-8 —	Reserved
7-0 MATCH0	Match 0 Value Compared against the received data when receive data match is enabled.

52.4.1.13 Master Clock Configuration Register 0 (MCCR0)

52.4.1.13.1 Offset

Register	Offset
MCCR0	48h

52.4.1.13.2 Function

The MCCR0 cannot be changed when the I2C master is enabled and is used for standard, fast, fast-mode plus and ultra-fast transfers.

52.4.1.13.3 Diagram

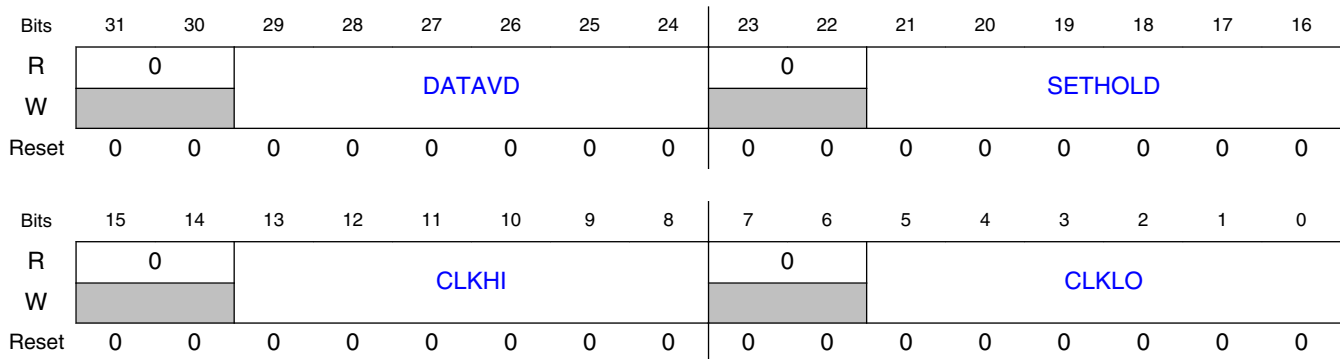

52.4.1.13.4 Fields

Field	Function
31-30 —	Reserved
29-24 DATAVD	Data Valid Delay Minimum number of cycles (minus one) that is used as the data hold time for SDA. Must be configured less than the minimum SCL low period.
23-22 —	Reserved
21-16 SETHOLD	Setup Hold Delay Minimum number of cycles (minus one) that is used by the master <ul style="list-style-type: none"> • as the hold time for a START condition • as the setup and hold time for a repeated START condition • as the setup time for a STOP condition <p>The setup time is extended by the time it takes to detect a rising edge on the external SCL pin. Ignoring any additional board delay due to external loading, this time is equal to $(2 + \text{FILTSCCL}) / 2^{\text{PRESCALE}}$ cycles.</p>
15-14 —	Reserved
13-8 CLKHI	Clock High Period Minimum number of cycles (minus one) that the SCL clock is driven high by the master. The SCL high time is extended by the time it takes to detect a rising edge on the external SCL pin. Ignoring any additional board delay due to external loading, this time is equal to $(2 + \text{FILTSCCL}) / 2^{\text{PRESCALE}}$ cycles.
7-6 —	Reserved
5-0 CLKLO	Clock Low Period Minimum number of cycles (minus one) that the SCL clock is driven low by the master. The Clock Low Period value is also used for the minimum bus free time between a STOP and a START condition; this is extended by the time it takes to detect a rising edge on the external SCL pin. Ignoring any additional board delay due to external loading, this time is equal to $(2 + \text{FILTSCCL}) / 2^{\text{PRESCALE}}$ cycles.

52.4.1.14 Master Clock Configuration Register 1 (MCCR1)

52.4.1.14.1 Offset

Register	Offset
MCCR1	50h

52.4.1.14.2 Function

The MCCR1 cannot be changed when the I2C master is enabled and is used for high speed mode transfers. The separate clock configuration for high speed mode allows arbitration to take place in Fast mode (with timing configured by MCCR0), before switching to high speed mode (with timing configured by MCCR1).

52.4.1.14.3 Diagram

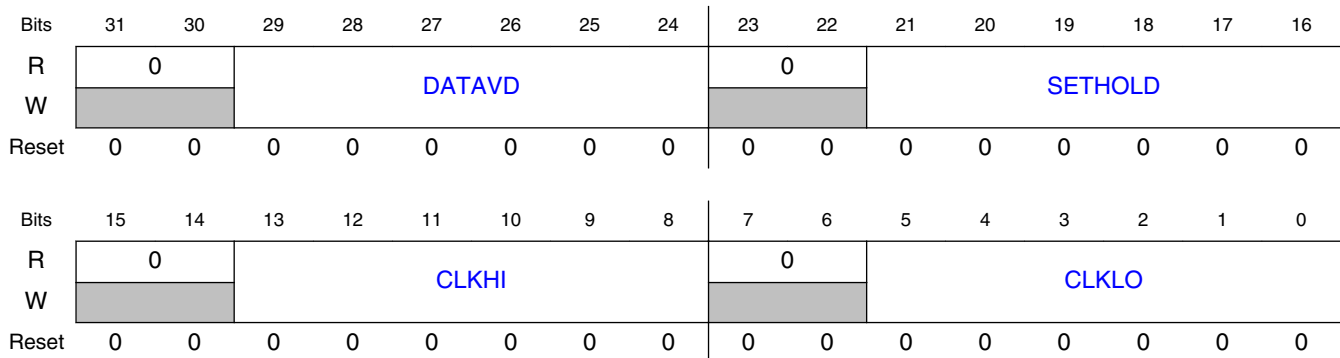

52.4.1.14.4 Fields

Field	Function
31-30 —	Reserved
29-24 DATAVD	Data Valid Delay Minimum number of cycles (minus one) that is used as the data hold time for SDA. The Data Valid Delay must be configured to be less than the minimum SCL low period.
23-22 —	Reserved
21-16 SETHOLD	Setup Hold Delay Minimum number of cycles (minus one) that is used by the master <ul style="list-style-type: none"> • as the hold time for a START condition • as the setup and hold time for a repeated START condition • as the setup time for a STOP condition <p>The setup time is extended by the time it takes to detect a rising edge on the external SCL pin. Ignoring any additional board delay due to external loading, this time is equal to $(2 + \text{FILTSCL}) / 2^{\text{PRESCALE}}$ cycles.</p>
15-14 —	Reserved
13-8 CLKHI	Clock High Period Minimum number of cycles (minus one) that the SCL clock is driven high by the master. The SCL high time is extended by the time it takes to detect a rising edge on the external SCL pin. Ignoring any additional board delay due to external loading, this time is equal to $(2 + \text{FILTSCL}) / 2^{\text{PRESCALE}}$ cycles.

Table continues on the next page...

Memory Map and Registers

Field	Function
7-6 —	Reserved
5-0 CLKLO	Clock Low Period Minimum number of cycles (minus one) that the SCL clock is driven low by the master. The Clock Low Period value is also used for the minimum bus free time between a STOP and a START condition; this is extended by the time it takes to detect a rising edge on the external SCL pin. Ignoring any additional board delay due to external loading, this time is equal to $(2 + \text{FILTSCL}) / 2^{\text{PRESCALE}}$ cycles.

52.4.1.15 Master FIFO Control Register (MFCR)

52.4.1.15.1 Offset

Register	Offset
MFCR	58h

52.4.1.15.2 Function

The Master FIFO control register is only used in Stop mode when the MFCR register is static (i.e., the MFCR register is not changing).

52.4.1.15.3 Diagram

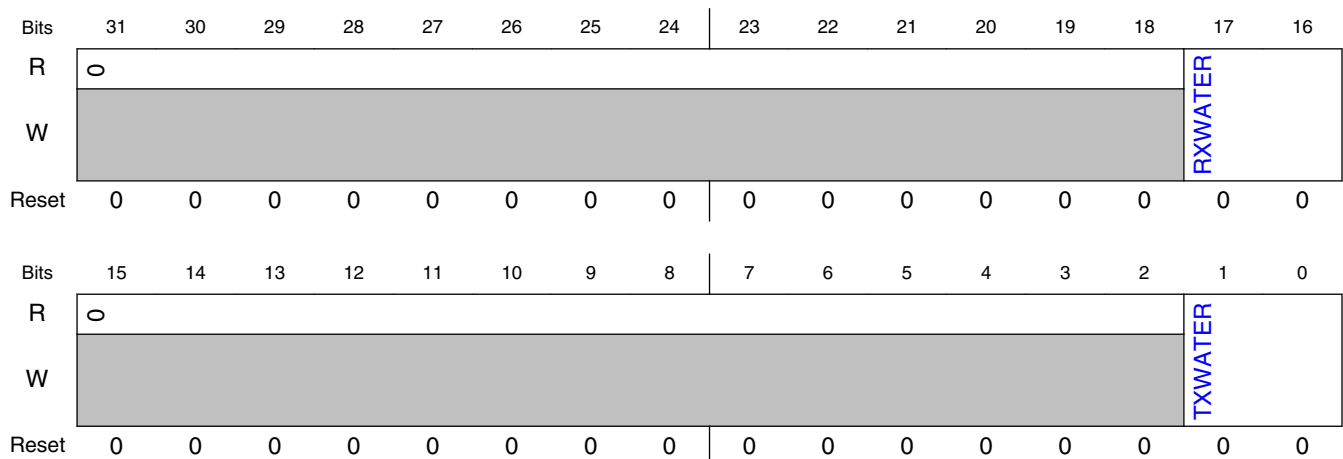

52.4.1.15.4 Fields

Field	Function
31-18 —	Reserved
17-16 RXWATER	Receive FIFO Watermark The Receive Data Flag is set whenever the number of words in the receive FIFO is greater than RXWATER. Writing a value equal to or greater than the FIFO size will be truncated.
15-2 —	Reserved
1-0 TXWATER	Transmit FIFO Watermark The Transmit Data Flag is set whenever the number of words in the transmit FIFO is equal or less than TXWATER. Writing a value equal to or greater than the FIFO size will be truncated.

52.4.1.16 Master FIFO Status Register (MFSR)

52.4.1.16.1 Offset

Register	Offset
MFSR	5Ch

52.4.1.16.2 Diagram

Bits	31	30	29	28	27	26	25	24	23	22	21	20	19	18	17	16
R	0												RXCOUNT			
W																
Reset	0	0	0	0	0	0	0	0	0	0	0	0	0	0	0	0
Bits	15	14	13	12	11	10	9	8	7	6	5	4	3	2	1	0
R	0												TXCOUNT			
W																
Reset	0	0	0	0	0	0	0	0	0	0	0	0	0	0	0	0

52.4.1.16.3 Fields

Field	Function
31-19	Reserved

Table continues on the next page...

Memory Map and Registers

Field	Function
—	
18-16 RXCOUNT	Receive FIFO Count Returns the number of words in the receive FIFO.
15-3 —	Reserved
2-0 TXCOUNT	Transmit FIFO Count Returns the number of words in the transmit FIFO.

52.4.1.17 Master Transmit Data Register (MTDR)

52.4.1.17.1 Offset

Register	Offset
MTDR	60h

52.4.1.17.2 Function

- An 8-bit write to the CMD field will store the data in the Command FIFO, but does not increment the FIFO write pointer.
- An 8-bit write to the DATA field will zero extend the CMD field, unless the CMD field has been written separately since the last FIFO write; it (the 8-bit write) also increments the FIFO write pointer.
- A 16-bit or 32-bit will write both the CMD and DATA fields and increment the FIFO.

52.4.1.17.3 Diagram

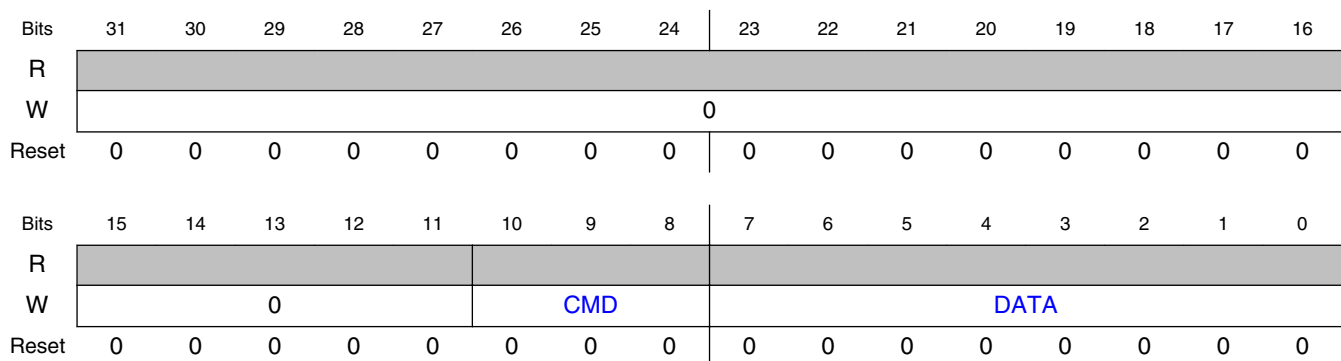

52.4.1.17.4 Fields

Field	Function
31-11 —	Reserved
10-8 CMD	Command Data 000b - Transmit DATA[7:0] 001b - Receive (DATA[7:0] + 1) bytes 010b - Generate STOP condition 011b - Receive and discard (DATA[7:0] + 1) bytes 100b - Generate (repeated) START and transmit address in DATA[7:0] 101b - Generate (repeated) START and transmit address in DATA[7:0]. This transfer expects a NACK to be returned. 110b - Generate (repeated) START and transmit address in DATA[7:0] using high speed mode 111b - Generate (repeated) START and transmit address in DATA[7:0] using high speed mode. This transfer expects a NACK to be returned.
7-0 DATA	Transmit Data Performing an 8-bit write to DATA will zero extend the CMD field.

52.4.1.18 Master Receive Data Register (MRDR)

52.4.1.18.1 Offset

Register	Offset
MRDR	70h

52.4.1.18.2 Diagram

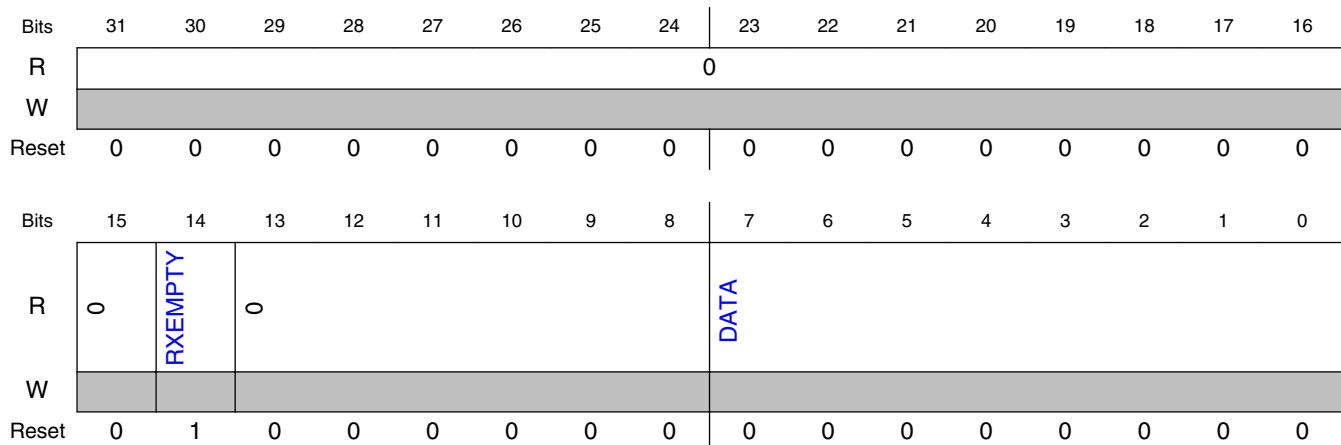

52.4.1.18.3 Fields

Field	Function
31-15 —	Reserved
14 RXEMPTY	RX Empty 0b - Receive FIFO is not empty 1b - Receive FIFO is empty
13-8 —	Reserved
7-0 DATA	Receive Data Reading the Receive Data register returns the data received by the I2C master that has not been discarded. Receive data can be discarded due to the CMD field, or the master can be configured to discard non-matching data.

52.4.1.19 Slave Control Register (SCR)

52.4.1.19.1 Offset

Register	Offset
SCR	110h

52.4.1.19.2 Diagram

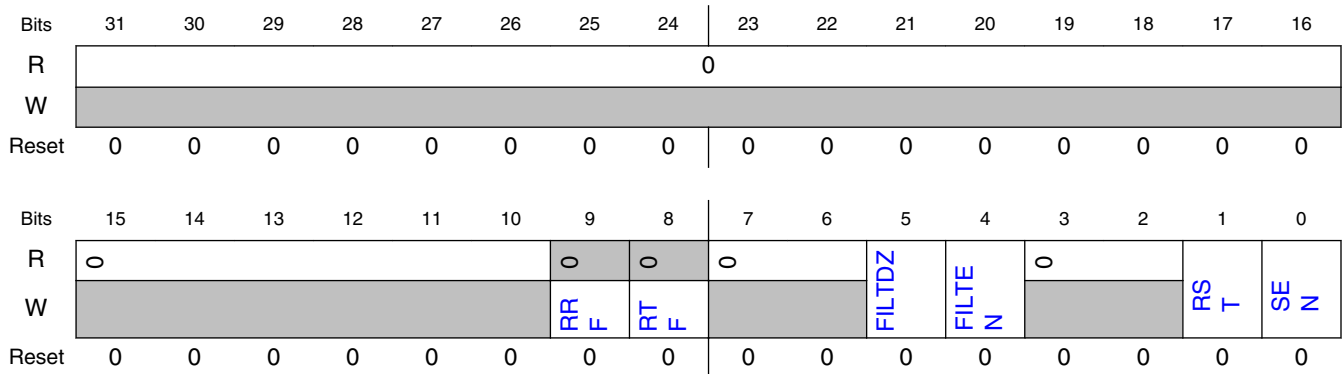

52.4.1.19.3 Fields

Field	Function
31-10 —	Reserved
9 RRF	Reset Receive FIFO 0b - No effect 1b - Receive Data Register is now empty
8 RTF	Reset Transmit FIFO 0b - No effect 1b - Transmit Data Register is now empty
7-6 —	Reserved
5 FILTDZ	Filter Doze Enable Filter Doze Enable bit should only be updated when the I2C Slave is disabled. 0b - Filter remains enabled in Doze mode 1b - Filter is disabled in Doze mode
4 FILTEN	Filter Enable Filter Enable bit should only be updated when the I2C Slave is disabled. 0b - Disable digital filter and output delay counter for slave mode 1b - Enable digital filter and output delay counter for slave mode
3-2 —	Reserved
1 RST	Software Reset The reset takes effect immediately and remains asserted until negated by software. There is no minimum delay required before clearing the software reset. 0b - Slave mode logic is not reset 1b - Slave mode logic is reset
0 SEN	Slave Enable 0b - I2C Slave mode is disabled 1b - I2C Slave mode is enabled

52.4.1.20 Slave Status Register (SSR)

52.4.1.20.1 Offset

Register	Offset
SSR	114h

52.4.1.20.2 Diagram

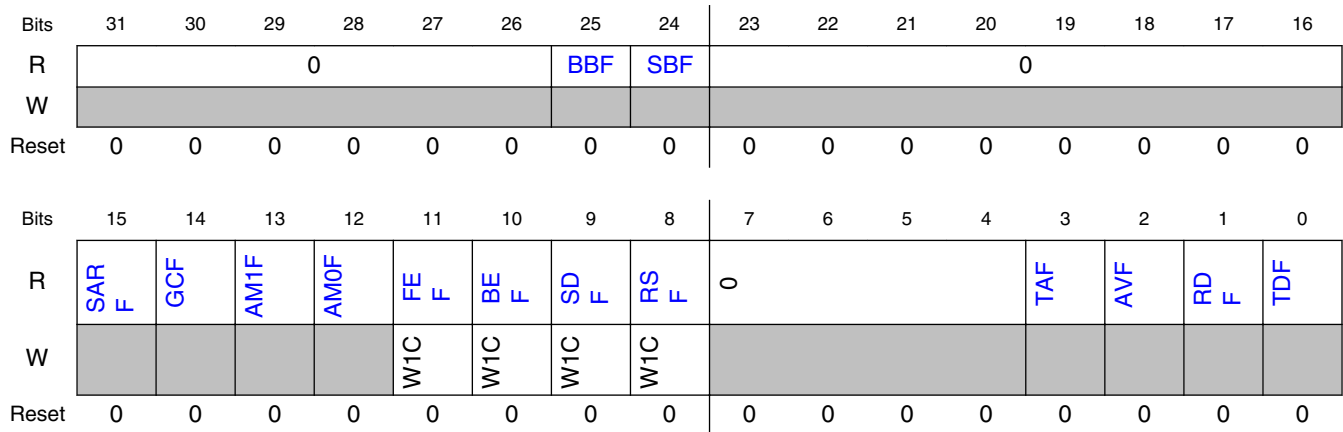

52.4.1.20.3 Fields

Field	Function
31-26 —	Reserved
25 BBF	Bus Busy Flag Indicates if an I2C bus is idle or busy. 0b - I2C Bus is idle 1b - I2C Bus is busy
24 SBF	Slave Busy Flag Indicates if an I2C slave is idle or busy. 0b - I2C Slave is idle 1b - I2C Slave is busy
23-16 —	Reserved
15 SARF	SMBus Alert Response Flag <ul style="list-style-type: none"> SMBus Alert Response Flag is cleared by reading the Address Status Register SMBus Alert Response Flag cannot generate an asynchronous wakeup 0b - SMBus Alert Response is disabled or not detected 1b - SMBus Alert Response is enabled and detected
14 GCF	General Call Flag Indicates whether a slave has detected the General Call Address. <ul style="list-style-type: none"> General Call Flag is cleared by reading the Address Status Register General Call Flag cannot generate an asynchronous wakeup 0b - Slave has not detected the General Call Address or the General Call Address is disabled 1b - Slave has detected the General Call Address
13 AM1F	Address Match 1 Flag Indicates that the received address has matched the ADDR1 field or ADDR0 to ADDR1 range as configured by ADDRCFG.

Table continues on the next page...

Field	Function
	<ul style="list-style-type: none"> Address Match 1 Flag is cleared by reading the Address Status Register Address Match 1 Flag cannot generate an asynchronous wakeup <p>0b - Have not received an ADDR1 or ADDR0/ADDR1 range matching address 1b - Have received an ADDR1 or ADDR0/ADDR1 range matching address</p>
12 AM0F	<p>Address Match 0 Flag</p> <p>Indicates that the received address has matched the ADDR0 field as configured by ADDRCFG.</p> <ul style="list-style-type: none"> Address Match 0 Flag is cleared by reading the Address Status Register Address Match 0 Flag cannot generate an asynchronous wakeup <p>0b - Have not received an ADDR0 matching address 1b - Have received an ADDR0 matching address</p>
11 FEF	<p>FIFO Error Flag</p> <p>FIFO error flag can only be set when clock stretching is disabled.</p> <p>0b - FIFO underflow or overflow was not detected 1b - FIFO underflow or overflow was detected</p>
10 BEF	<p>Bit Error Flag</p> <p>Bit Error Flag will set if the LPI2C slave transmits a logic one and detects a logic zero on the I2C bus. The slave will ignore the rest of the transfer until the next (repeated) START condition.</p> <p>0b - Slave has not detected a bit error 1b - Slave has detected a bit error</p>
9 SDF	<p>STOP Detect Flag</p> <p>STOP Detect Flag will set when the LPI2C slave detects a STOP condition and if the LPI2C slave matched the last address byte.</p> <p>0b - Slave has not detected a STOP condition 1b - Slave has detected a STOP condition</p>
8 RSF	<p>Repeated Start Flag</p> <p>Repeated Start Flag will set when the LPI2C slave detects a repeated START condition and if the LPI2C slave matched the last address byte. The Repeated Start Flag does not set when the slave first detects a START condition.</p> <p>0b - Slave has not detected a Repeated START condition 1b - Slave has detected a Repeated START condition</p>
7-4 —	Reserved
3 TAF	<p>Transmit ACK Flag</p> <p>Transmit ACK Flag is cleared by writing the Transmit ACK register.</p> <p>0b - Transmit ACK/NACK is not required 1b - Transmit ACK/NACK is required</p>
2 AVF	<p>Address Valid Flag</p> <p>Address Valid Flag is cleared by reading the address status register. When Receive Data Configuration (SCFGR1[RXCFCG]) is set, the Address Valid Flag is also cleared by reading the Receive Data register.</p> <p>0b - Address Status Register is not valid 1b - Address Status Register is valid</p>
1 RDF	<p>Receive Data Flag</p> <p>Receive Data Flag is cleared by reading the receive data register. When Receive Data Configuration (SCFGR1[RXCFCG]) is set, the Receive Data Flag is not cleared when reading the Receive Data register and if AVF is set.</p> <p>0b - Receive data is not ready 1b - Receive data is ready</p>

Table continues on the next page...

Memory Map and Registers

Field	Function
0	Transmit Data Flag
TDF	Transmit Data Flag is cleared by writing the Transmit Data register. When Transmit Flag Configuration (TXCFG) is clear, and if a NACK or Repeated START or STOP condition is detected, then Transmit Data Flag is also cleared. 0b - Transmit data not requested 1b - Transmit data is requested

52.4.1.21 Slave Interrupt Enable Register (SIER)

52.4.1.21.1 Offset

Register	Offset
SIER	118h

52.4.1.21.2 Diagram

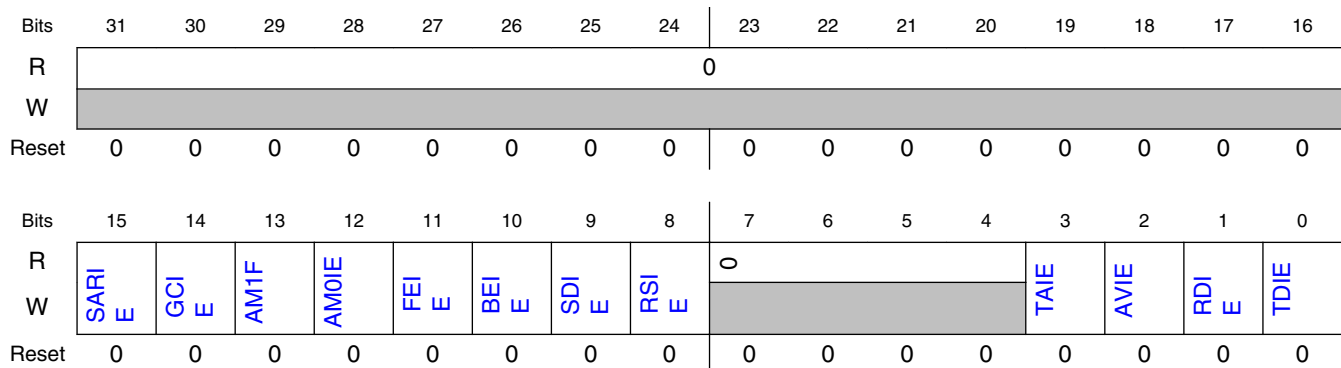

52.4.1.21.3 Fields

Field	Function
31-16	Reserved
—	
15 SARIE	SMBus Alert Response Interrupt Enable 0b - Disabled 1b - Enabled
14 GCIE	General Call Interrupt Enable 0b - Disabled 1b - Enabled

Table continues on the next page...

Field	Function
13 AM1F	Address Match 1 Interrupt Enable 0b - Disabled 1b - Enabled
12 AM0IE	Address Match 0 Interrupt Enable 0b - Enabled 1b - Disabled
11 FEIE	FIFO Error Interrupt Enable 0b - Disabled 1b - Enabled
10 BEIE	Bit Error Interrupt Enable 0b - Disabled 1b - Enabled
9 SDIE	STOP Detect Interrupt Enable 0b - Disabled 1b - Enabled
8 RSIE	Repeated Start Interrupt Enable 0b - Disabled 1b - Enabled
7-4 —	Reserved
3 TAIE	Transmit ACK Interrupt Enable 0b - Disabled 1b - Enabled
2 AVIE	Address Valid Interrupt Enable 0b - Disabled 1b - Enabled
1 RDIE	Receive Data Interrupt Enable 0b - Disabled 1b - Enabled
0 TDIE	Transmit Data Interrupt Enable 0b - Disabled 1b - Enabled

52.4.1.22 Slave DMA Enable Register (SDER)

52.4.1.22.1 Offset

Register	Offset
SDER	11Ch

52.4.1.22.2 Diagram

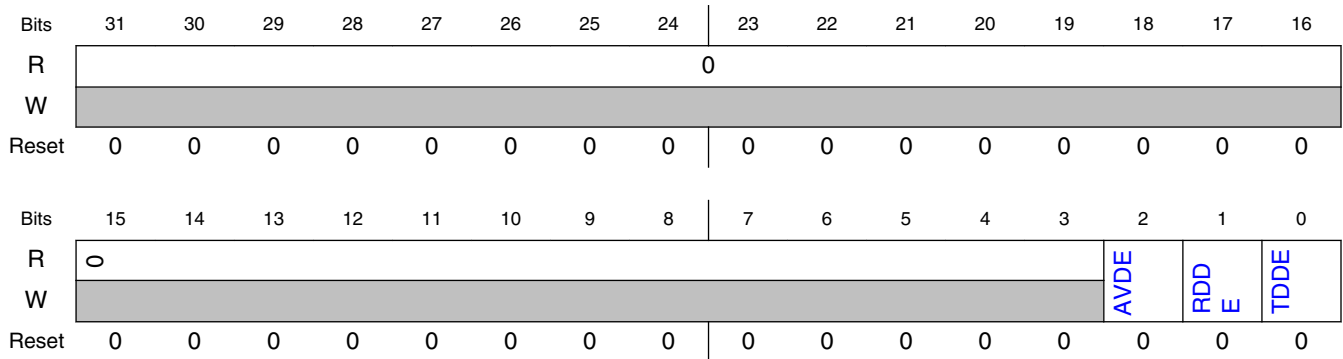

52.4.1.22.3 Fields

Field	Function
31-3 —	Reserved
2 AVDE	Address Valid DMA Enable The Address Valid DMA request is shared with the Receive Data DMA request. If both Address Valid DMA request and Receive Data DMA request are enabled, then set Receive Data Configuration (SCFGR1[RXCFG]), to allow the DMA to read the address from the Receive Data Register. 0b - DMA request is disabled 1b - DMA request is enabled
1 RDDE	Receive Data DMA Enable 0b - DMA request is disabled 1b - DMA request is enabled
0 TDDE	Transmit Data DMA Enable 0b - DMA request is disabled 1b - DMA request is enabled

52.4.1.23 Slave Configuration Register 1 (SCFGR1)

52.4.1.23.1 Offset

Register	Offset
SCFGR1	124h

52.4.1.23.2 Function

The Slave Configuration Register 1 should only be written when the I2C Slave is disabled.

52.4.1.23.3 Diagram

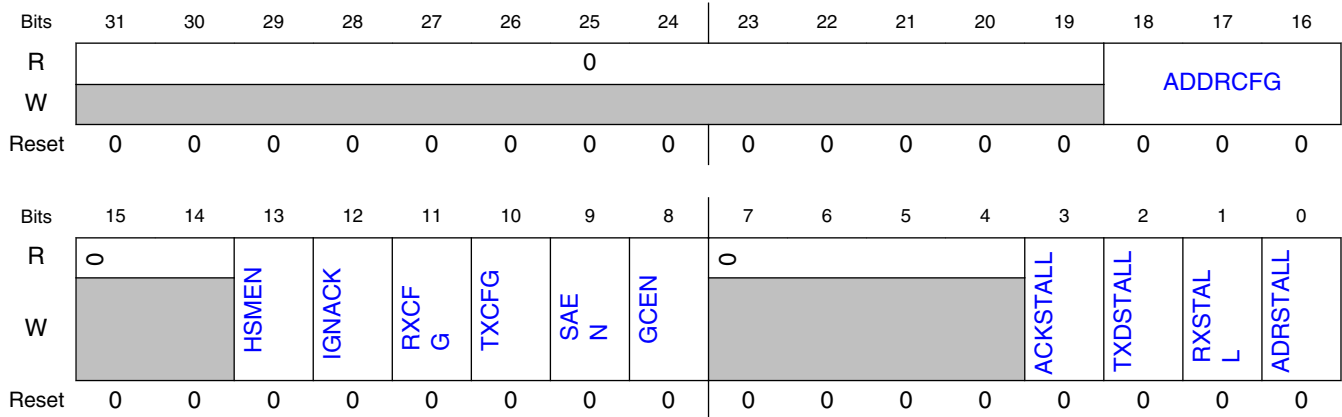

52.4.1.23.4 Fields

Field	Function
31-19 —	Reserved
18-16 ADDRCFG	Address Configuration Configures the condition that will cause an address to match. 000b - Address match 0 (7-bit) 001b - Address match 0 (10-bit) 010b - Address match 0 (7-bit) or Address match 1 (7-bit) 011b - Address match 0 (10-bit) or Address match 1 (10-bit) 100b - Address match 0 (7-bit) or Address match 1 (10-bit) 101b - Address match 0 (10-bit) or Address match 1 (7-bit) 110b - From Address match 0 (7-bit) to Address match 1 (7-bit) 111b - From Address match 0 (10-bit) to Address match 1 (10-bit)
15-14 —	Reserved
13 HSMEN	High Speed Mode Enable Enables detection of the High-Speed Mode master code of slave address 0000_1XX, but does not cause an address match on this code. When set and any HS-mode master code is detected, the FILTEN and ACKSTALL bits are ignored until the next STOP condition is detected. 0b - Disables detection of HS-mode master code 1b - Enables detection of HS-mode master code
12 IGNACK	Ignore NACK When Ignore NACK is set, the LPI2C slave will continue transfers after a NACK is detected. Ignore NACK bit is required to be set in Ultra-Fast Mode. 0b - Slave will end transfer when NACK is detected

Table continues on the next page...

Memory Map and Registers

Field	Function
	1b - Slave will not end transfer when NACK detected
11 RXCFG	<p>Receive Data Configuration</p> <p>0b - Reading the Receive Data register will return received data and clear the Receive Data flag (MSR[RDF]).</p> <p>1b - Reading the Receive Data register when the Address Valid flag (SSR[AVF]) is set, will return the Address Status register and clear the Address Valid flag. Reading the Receive Data register when the Address Valid flag is clear, will return received data and clear the Receive Data flag (MSR[RDF]).</p>
10 TXCFG	<p>Transmit Flag Configuration</p> <p>The transmit data flag will always assert before a NACK is detected at the end of a slave-transmit transfer. This can cause an extra word to be written to the transmit data FIFO.</p> <ul style="list-style-type: none"> When TXCFG=0, the Transmit Data register is automatically emptied when a slave-transmit transfer is detected. This causes the transmit data flag to assert whenever a slave-transmit transfer is detected, and causes the transmit data flag to negate at the end of the slave-transmit transfer. When TXCFG=1, the Transmit Data flag will assert whenever the Transmit Data register is empty, and the Transmit Data flag will negate when the Transmit Data register is full. This allows the Transmit Data register to be filled before a slave-transmit transfer is detected, but can cause the Transmit Data register to be written before a NACK is detected on the last byte of a slave transmit transfer. <p>0b - Transmit Data Flag will only assert during a slave-transmit transfer when the Transmit Data register is empty</p> <p>1b - Transmit Data Flag will assert whenever the Transmit Data register is empty</p>
9 SAEN	<p>SMBus Alert Enable</p> <p>0b - Disables match on SMBus Alert</p> <p>1b - Enables match on SMBus Alert</p>
8 GCEN	<p>General Call Enable</p> <p>0b - General Call address is disabled</p> <p>1b - General Call address is enabled</p>
7-4 —	Reserved
3 ACKSTALL	<p>ACK SCL Stall</p> <p>Enables SCL clock stretching during slave-transmit address byte(s) and slave-receiver address and data byte(s), to allow software to write the Transmit ACK Register before the ACK or NACK is transmitted. Clock stretching occurs when transmitting the 9th bit, and is therefore not compatible with high speed mode.</p> <p>When ACKSTALL is enabled, there is no need to set either RX SCL Stall (SCFGR1[RXSTALL]) or Address SCL Stall (SCFGR1[ADRSTALL]).</p> <p>0b - Clock stretching is disabled</p> <p>1b - Clock stretching is enabled</p>
2 TXDSTALL	<p>TX Data SCL Stall</p> <p>Enables SCL clock stretching when the Transmit Data flag (SSR[TDF]) is set during a slave-transmit transfer. Clock stretching occurs following the 9th bit, and is therefore compatible with high speed mode.</p> <p>0b - Clock stretching is disabled</p> <p>1b - Clock stretching is enabled</p>
1 RXSTALL	<p>RX SCL Stall</p> <p>Enables SCL clock stretching when the Receive Data flag (SSR[RDF]) is set during a slave-receive transfer. Clock stretching occurs following the 9th bit, and is therefore compatible with high speed mode.</p> <p>0b - Clock stretching is disabled</p> <p>1b - Clock stretching is enabled</p>

Table continues on the next page...

Field	Function
0	Address SCL Stall
ADRSTALL	Enables SCL clock stretching when the Address Valid Flag (SSR[AVF]) is asserted. Clock stretching only occurs following the 9th bit, and is therefore compatible with high speed mode. 0b - Clock stretching is disabled 1b - Clock stretching is enabled

52.4.1.24 Slave Configuration Register 2 (SCFGR2)

52.4.1.24.1 Offset

Register	Offset
SCFGR2	128h

52.4.1.24.2 Function

The Slave Configuration Register 2 should only be written when the I2C Slave is disabled.

52.4.1.24.3 Diagram

Bits	31	30	29	28	27	26	25	24	23	22	21	20	19	18	17	16
R	0				FILTSDA				0				FILTSCS			
W	0				0				0				0			
Reset	0	0	0	0	0	0	0	0	0	0	0	0	0	0	0	0
Bits	15	14	13	12	11	10	9	8	7	6	5	4	3	2	1	0
R	0		DATAVD						0				CLKHOLD			
W	0		0						0				0			
Reset	0	0	0	0	0	0	0	0	0	0	0	0	0	0	0	0

52.4.1.24.4 Fields

Field	Function
31-28	Reserved
—	
27-24	Glitch Filter SDA

Table continues on the next page...

Memory Map and Registers

Field	Function
FILTSDA	Configures the I2C slave digital glitch filters for SDA input. <ul style="list-style-type: none"> • A configuration of 0 will disable the glitch filter • Glitches equal to or less than FILTSDA cycles long will be filtered out and ignored • The latency through the glitch filter is equal to FILTSDA+3 cycles, and must be configured to be less than the minimum SCL low or high period • The glitch filter cycle count is not affected by the PRESCALE configuration, and the glitch filter cycle count is disabled in high speed mode
23-20 —	Reserved
19-16 FILTSCS	Glitch Filter SCL Configures the I2C slave digital glitch filters for SCL input. <ul style="list-style-type: none"> • A configuration of 0 will disable the glitch filter • Glitches equal to or less than FILTSCS cycles long will be filtered out and ignored • The latency through the glitch filter is equal to FILTSCS+3 cycles, and must be configured to be less than the minimum SCL low or high period • The glitch filter cycle count is not affected by the PRESCALE configuration, and the glitch filter cycle count is disabled in high speed mode
15-14 —	Reserved
13-8 DATAVD	Data Valid Delay Configures the SDA data valid delay time for the I2C slave, and is equal to FILTSCS+DATAVD+3 cycles. <ul style="list-style-type: none"> • The data valid delay must be configured to be less than the minimum SCL low period • The I2C slave data valid delay time is not affected by the PRESCALE configuration, and the I2C slave data valid delay time is disabled in high speed mode
7-4 —	Reserved
3-0 CLKHOLD	Clock Hold Time Configures the minimum clock hold time for the I2C slave, when clock stretching is enabled. <ul style="list-style-type: none"> • The minimum hold time is equal to CLKHOLD+3 cycles • The I2C slave clock hold time is not affected by the PRESCALE configuration, and the I2C slave clock hold time is disabled in high speed mode

52.4.1.25 Slave Address Match Register (SAMR)

52.4.1.25.1 Offset

Register	Offset
SAMR	140h

52.4.1.25.2 Function

The SAMR should only be written when the I2C Slave is disabled.

52.4.1.25.3 Diagram

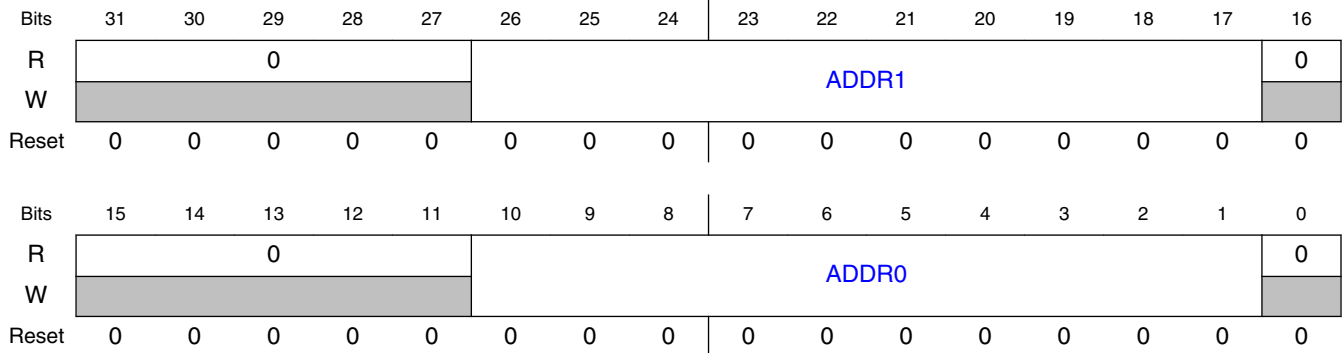

52.4.1.25.4 Fields

Field	Function
31-27 —	Reserved
26-17 ADDR1	Address 1 Value Compared against the received address to detect the Slave Address. <ul style="list-style-type: none"> In 10-bit mode, the first address byte is compared to { 11110, ADDR1[26:25] } and the second address byte is compared to ADDR1[24:17] In 7-bit mode, the address is compared to ADDR1[23:17]
16-11 —	Reserved
10-1 ADDR0	Address 0 Value Compared against the received address to detect the Slave Address. <ul style="list-style-type: none"> In 10-bit mode, the first address byte is compared to { 11110, ADDR0[10:9] } and the second address byte is compared to ADDR0[8:1] In 7-bit mode, the address is compared to ADDR0[7:1]
0 —	Reserved

52.4.1.26 Slave Address Status Register (SASR)

52.4.1.26.1 Offset

Register	Offset
SASR	150h

52.4.1.26.2 Diagram

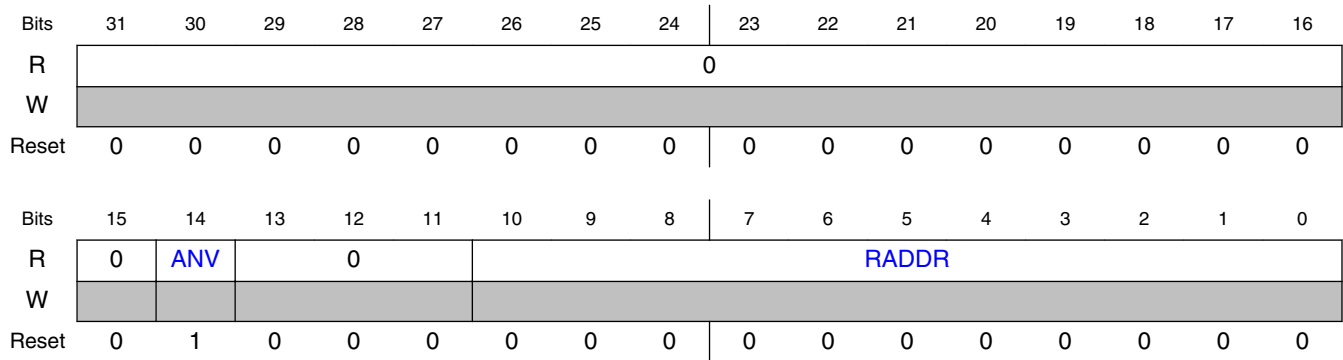

52.4.1.26.3 Fields

Field	Function
31-15 —	Reserved
14 ANV	Address Not Valid 0b - Received Address (RADDR) is valid 1b - Received Address (RADDR) is not valid
13-11 —	Reserved
10-0 RADDR	Received Address The Received Address updates whenever the AMF is set; the AMF is cleared by reading the Slave Address Status register. <ul style="list-style-type: none"> In 7-bit mode, the address byte is store in RADDR[7:0] In 10-bit mode, the first address byte is { 11110, RADDR[10:9], RADDR[0] } and the second address byte is RADDR[8:1]. The R/W bit is therefore always stored in RADDR[0]

52.4.1.27 Slave Transmit ACK Register (STAR)

52.4.1.27.1 Offset

Register	Offset
STAR	154h

52.4.1.27.2 Function

The Slave Transmit ACK Register can only be written when the ACK SCL Stall bit is set in Slave Configuration Register 1 (SCFGR1[ACKSTALL]).

- The ACKSTALL bit will enable clock stretching during the ACK/NACK bit slot, and during this time, the STAR register can be written by software.
- The logic ensures that the clock stretching continues for at least 1 bus clock cycle after the STAR register is updated.
- This clock stretching time can be extended more using the Clock Hold Time field (SCFGR2[CLKHOLD], Slave Configuration Register 2).

52.4.1.27.3 Diagram

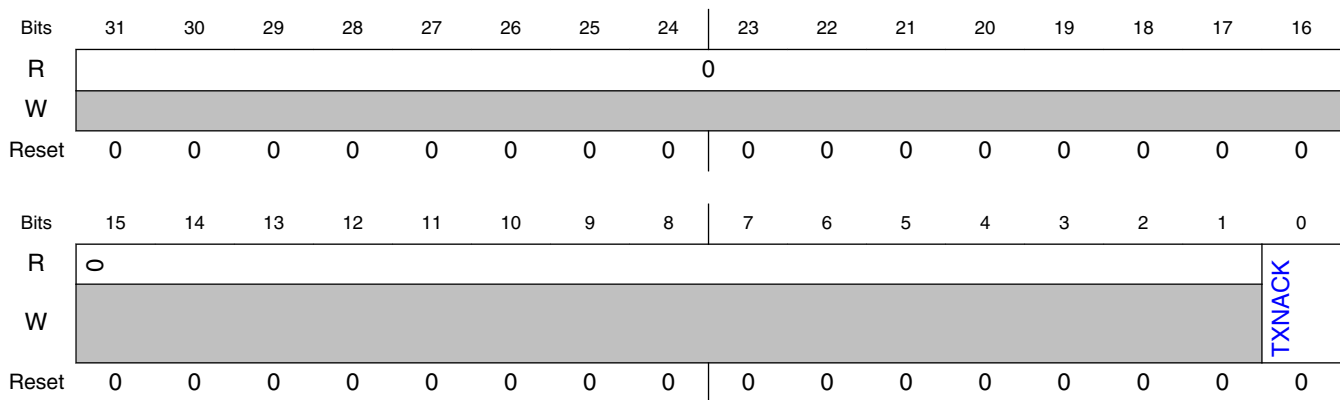

52.4.1.27.4 Fields

Field	Function
31-1 —	Reserved
0 TXNACK	Transmit NACK After receiving each word, software can transmit either an ACK (logic 0) or a NACK (logic 1); Transmit NACK selects which to use: ACK or NACK. <ul style="list-style-type: none"> • When ACKSTALL is set, a Transmit NACK must be written once for each matching address byte and each received word. ACKSTALL must be set, because that will stall the data transfer until software reads the received word (and decides whether to respond with an ACK or NACK). • To configure the default ACK/NACK, Transmit NACK can also be written when LPI2C Slave is disabled or idle. 0b - Write a Transmit ACK for each received word 1b - Write a Transmit NACK for each received word

52.4.1.28 Slave Transmit Data Register (STDR)

52.4.1.28.1 Offset

Register	Offset
STDR	160h

52.4.1.28.2 Function

Clock stretching (enabled or disabled) affects when the transmit data is transferred. The TXDSTALL bit will enable clock stretching during the 1st data bit of a slave-transmit transfer.

- **If clock stretching is enabled (TXDSTALL=1)**, then the transmit data transfer is stalled until the Slave Transmit register (STDR) is updated. Clock stretching is extended by at least 1 bus clock cycle after the Slave Transmit Data Register (STDR) is updated, and clock stretching can be delayed even more using the Clock Hold Time field (SCFGR2[CLKHOLD], Slave Configuration Register 2).
- **If clock stretching is disabled (TXDSTALL=0)**, then the transmit data should be written before the start of the slave-transmit transfer; otherwise (i.e., if the transmit data is not written before the start of the slave-transmit transfer), the FIFO Error Flag (SSR[FEF]) will be set.

52.4.1.28.3 Diagram

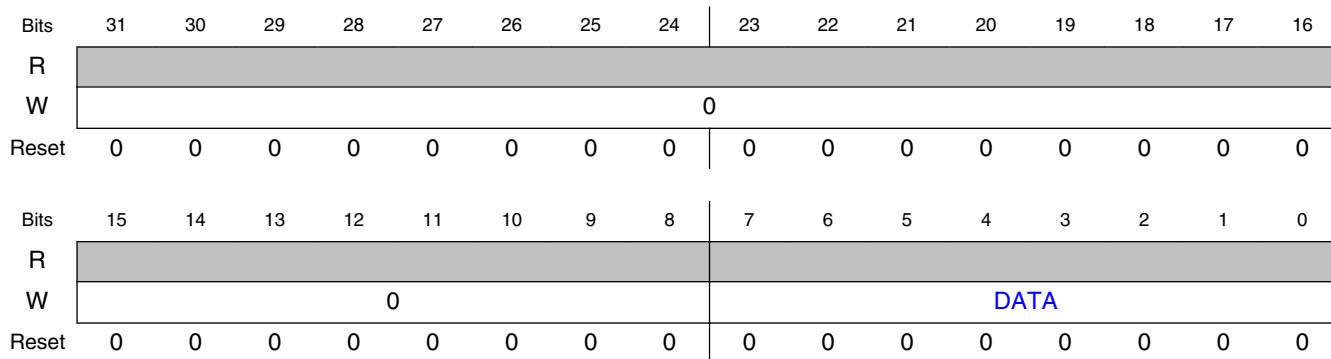

52.4.1.28.4 Fields

Field	Function
31-8	Reserved
—	

Table continues on the next page...

Field	Function
7-0 DATA	Transmit Data Writing to the Slave Transmit Data Register (STDR) will store I2C slave transmit data <i>in</i> the Slave Transmit Data Register

52.4.1.29 Slave Receive Data Register (SRDR)

52.4.1.29.1 Offset

Register	Offset
SRDR	170h

52.4.1.29.2 Diagram

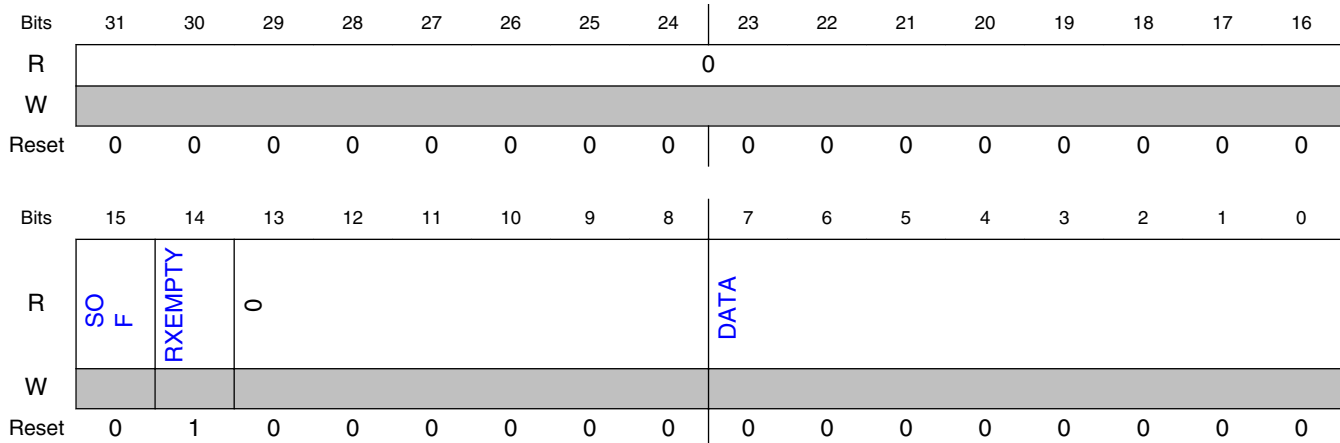

52.4.1.29.3 Fields

Field	Function
31-16 —	Reserved
15 SOF	Start Of Frame 0b - Indicates this is not the first data word since a (repeated) START or STOP condition 1b - Indicates this is the first data word since a (repeated) START or STOP condition
14 RXEMPTY	RX Empty 0b - The Receive Data Register is not empty 1b - The Receive Data Register is empty

Table continues on the next page...

Memory Map and Registers

Field	Function
13-8 —	Reserved
7-0 DATA	Receive Data Reading the Slave Receive Data Register returns the data received by the I2C slave

Chapter 53

Low Power Universal Asynchronous Receiver/Transmitter (LPUART)

53.1 Chip-specific LPUART information

53.1.1 Instantiation Information

The LPUART module supports basic UART with DMA interface function and $\times 4$ to $\times 32$ oversampling of baud-rate. The following tables summarize the implementation of this module for each chip in the product series.

Table 53-1. LPUART instances and features

Chip	Instances	TX FIFO (word)	RX FIFO (word)
S32K116	LPUART0	4	4
	LPUART1	4	4
S32K118	LPUART0	4	4
	LPUART1	4	4
S32K142	LPUART0	4	4
	LPUART1	4	4
S32K144	LPUART0	4	4
	LPUART1	4	4
	LPUART2	4	4
S32K144W	LPUART0	4	4
	LPUART1	4	4
	LPUART2	4	4
S32K146	LPUART0	4	4
	LPUART1	4	4
	LPUART2	4	4
S32K148	LPUART0	4	4
	LPUART1	4	4
	LPUART2	4	4

This module supports LIN master and slave operation.

Low leakage and Wait mode is not supported in this device. RTS and CTS features are not supported to used in VLPS mode. See [Module operation in available power modes](#) for details on available power modes.

53.2 Introduction

53.2.1 Features

Features of the LPUART module include:

- Full-duplex, standard non-return-to-zero (NRZ) format
- Programmable baud rates (13-bit modulo divider) with configurable oversampling ratio from 4x to 32x
- Transmit and receive baud rate can operate asynchronous to the bus clock:
 - Baud rate can be configured independently of the bus clock frequency
 - Supports operation in Stop modes
- Interrupt, DMA or polled operation:
 - Transmit data register empty and transmission complete
 - Receive data register full
 - Receive overrun, parity error, framing error, and noise error
 - Idle receiver detect
 - Active edge on receive pin
 - Break detect supporting LIN
 - Receive data match
- Hardware parity generation and checking
- Programmable 7-bit, 8-bit, 9-bit or 10-bit character length
- Programmable 1-bit or 2-bit stop bits
- Three receiver wakeup methods:
 - Idle line wakeup
 - Address mark wakeup
 - Receive data match
- Automatic address matching to reduce ISR overhead:
 - Address mark matching
 - Idle line address matching
 - Address match start, address match end
- Optional 13-bit break character generation / 11-bit break character detection
- Configurable idle length detection supporting 1, 2, 4, 8, 16, 32, 64 or 128 idle characters

- Selectable transmitter output and receiver input polarity
- Hardware flow control support for request to send (RTS) and clear to send (CTS) signals
- Selectable IrDA 1.4 return-to-zero-inverted (RZI) format with programmable pulse width
- Independent FIFO structure for transmit and receive
 - Separate configurable watermark for receive and transmit requests
 - Option for receiver to assert request after a configurable number of idle characters if receive FIFO is not empty

53.2.2 Modes of operation

53.2.2.1 Stop mode

The LPUART remains functional during Stop mode, provided the CTRL[DOZEEN] bit is clear and the asynchronous transmit and receive clock remain enabled. The LPUART can generate an interrupt or DMA request to cause a wakeup from Stop mode.

If the LPUART is disabled in Stop mode, then it can generate a wakeup via the STAT[RXEDGIF] flag if the receiver detects an active edge.

53.2.2.2 Debug mode

The LPUART remains functional in debug mode.

53.2.3 Signal Descriptions

Signal	Description	I/O
TXD	Transmit data. This pin is normally an output, but is an input (tristated) in single wire mode whenever the transmitter is disabled or transmit direction is configured for receive data.	I/O
RXD	Receive data.	I
CTS_B	Clear to send.	I
RTS_B	Request to send.	O

53.2.4 Block diagram

The following figure shows the transmitter portion of the LPUART.

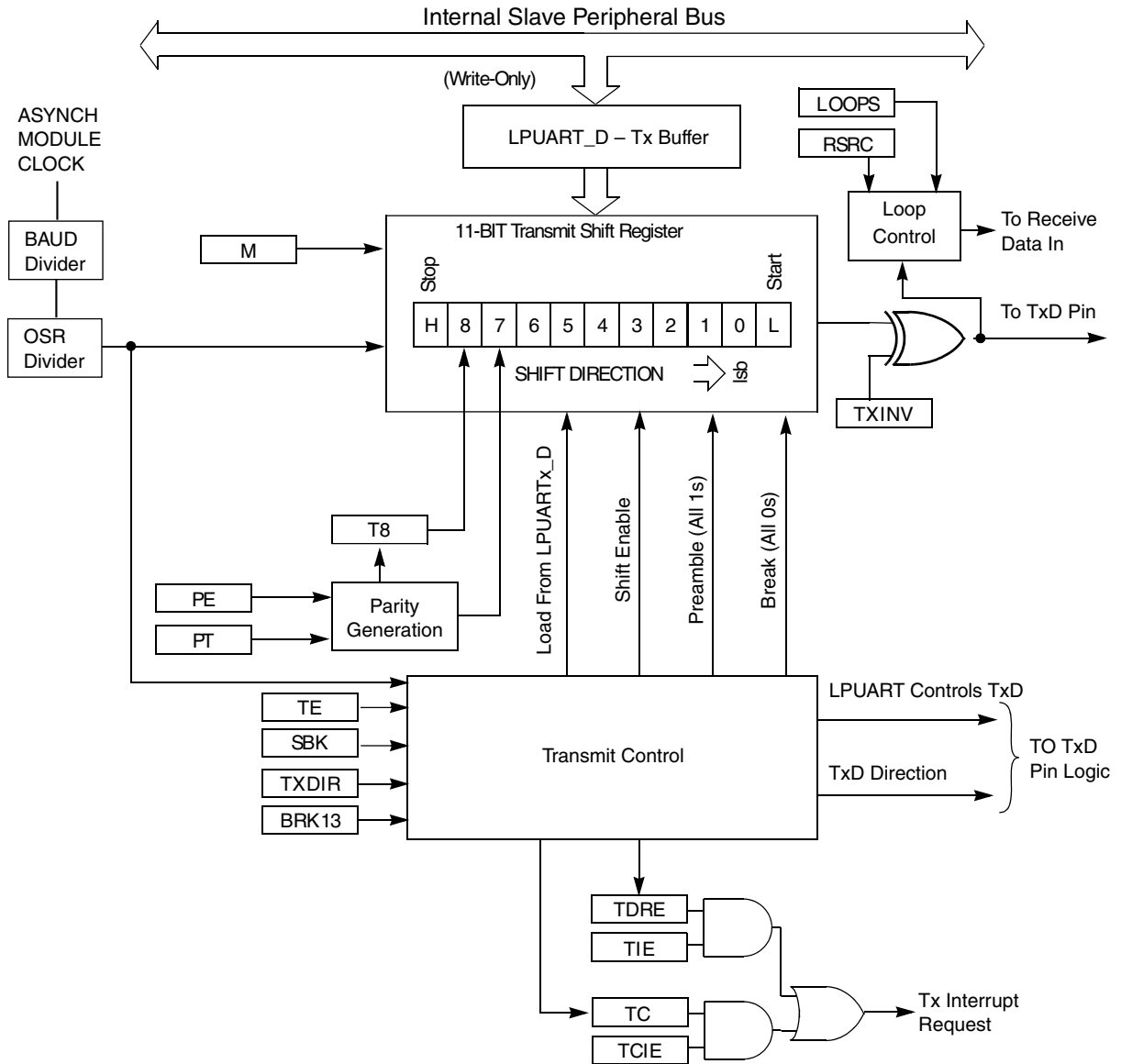

Figure 53-1. LPUART transmitter block diagram

The following figure shows the receiver portion of the LPUART.

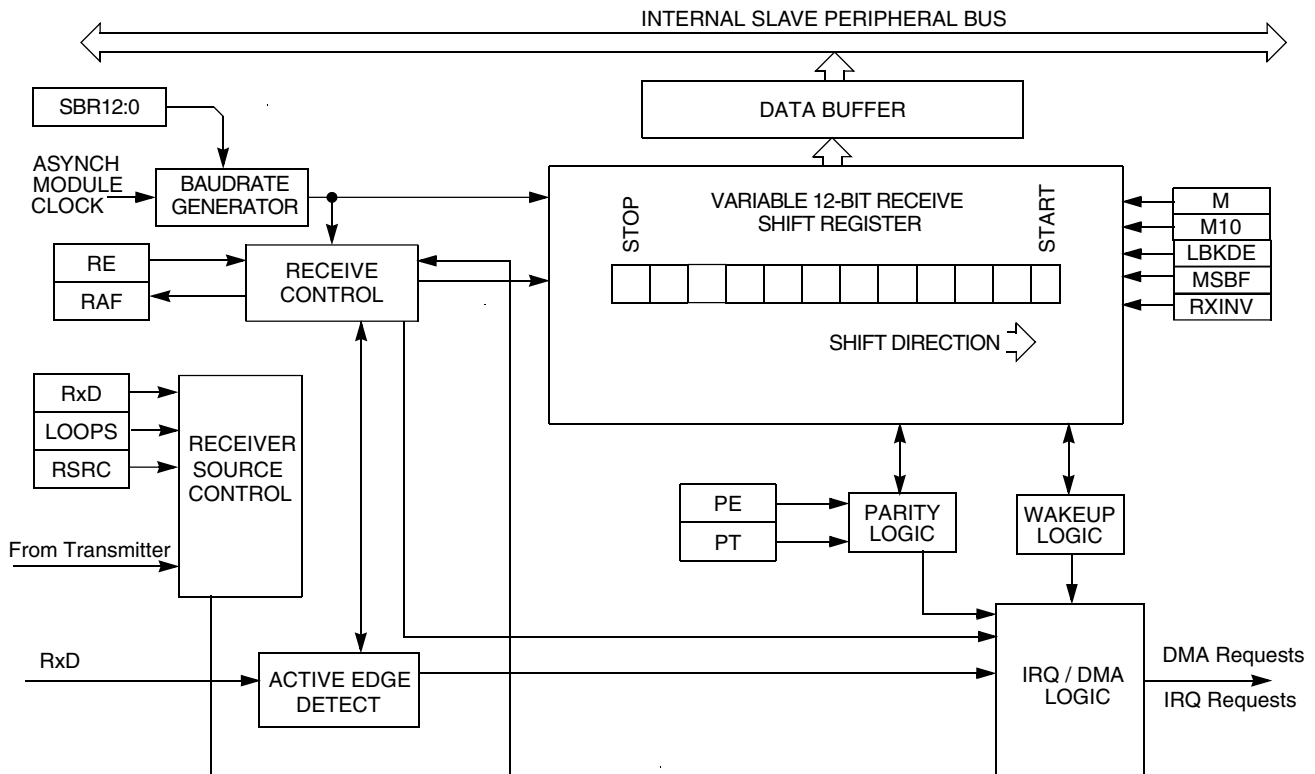

Figure 53-2. LPUART receiver block diagram

53.3 Register definition

The LPUART includes registers to control baud rate, select options, report status, and store transmit/receive data. Access to an address outside the valid memory map generates a bus error.

NOTE

Writing a Read-Only (RO) register or reading a Write-Only (WO) register can cause bus errors. This module does not check if programmed values in the registers are correct; the application software must ensure that valid programmed values are being written.

53.3.1 LPUART register descriptions

53.3.1.1 LPUART memory map

LPUART0 base address: 4006_A000h

LPUART1 base address: 4006_B000h

LPUART2 base address: 4006_C000h

Offset	Register	Width (In bits)	Access	Reset value
0h	Version ID Register (VERID)	32	RO	0401_0003h
4h	Parameter Register (PARAM)	32	RO	0000_0202h
8h	LPUART Global Register (GLOBAL)	32	RW	0000_0000h
Ch	LPUART Pin Configuration Register (PINCFG)	32	RW	0000_0000h
10h	LPUART Baud Rate Register (BAUD)	32	RW	0F00_0004h
14h	LPUART Status Register (STAT)	32	RW	00C0_0000h
18h	LPUART Control Register (CTRL)	32	RW	0000_0000h
1Ch	LPUART Data Register (DATA)	32	RW	0000_1000h
20h	LPUART Match Address Register (MATCH)	32	RW	0000_0000h
24h	LPUART Modem IrDA Register (MODIR)	32	RW	0000_0000h
28h	LPUART FIFO Register (FIFO)	32	RW	00C0_0011h
2Ch	LPUART Watermark Register (WATER)	32	RW	0000_0000h

53.3.1.2 Version ID Register (VERID)

53.3.1.2.1 Offset

Register	Offset
VERID	0h

53.3.1.2.2 Function

The Version ID register indicates the version integrated for this instance on the device and also indicates inclusion/exclusion of several optional features.

53.3.1.2.3 Diagram

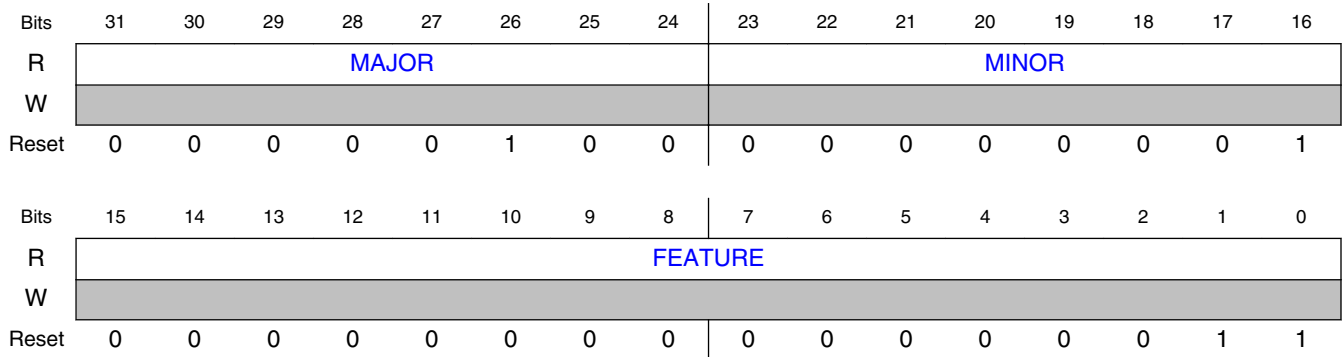

53.3.1.2.4 Fields

Field	Function
31-24 MAJOR	Major Version Number This read only field returns the major version number for the module specification.
23-16 MINOR	Minor Version Number This read only field returns the minor version number for the module specification.
15-0 FEATURE	Feature Identification Number This read only field returns the feature set number. 0000000000000001b - Standard feature set. 000000000000011b - Standard feature set with MODEM/IrDA support.

53.3.1.3 Parameter Register (PARAM)

53.3.1.3.1 Offset

Register	Offset
PARAM	4h

53.3.1.3.2 Function

The Parameter register indicates the parameter configuration for this instance on the device

Register definition

53.3.1.3.3 Diagram

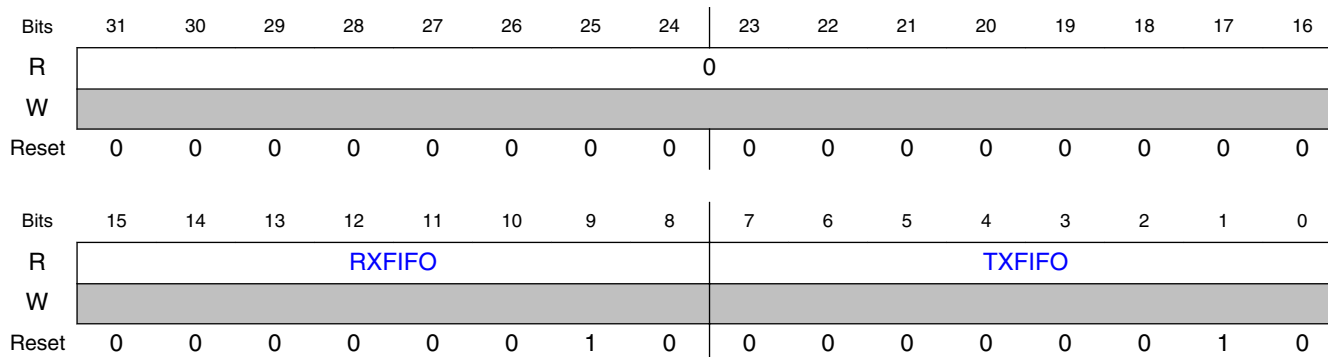

53.3.1.3.4 Fields

Field	Function
31-16 —	Reserved
15-8 RXFIFO	Receive FIFO Size The number of words in the receive FIFO is 2^{RXFIFO} .
7-0 TXFIFO	Transmit FIFO Size The number of words in the transmit FIFO is 2^{TXFIFO} .

53.3.1.4 LPUART Global Register (GLOBAL)

53.3.1.4.1 Offset

Register	Offset
GLOBAL	8h

53.3.1.4.2 Diagram

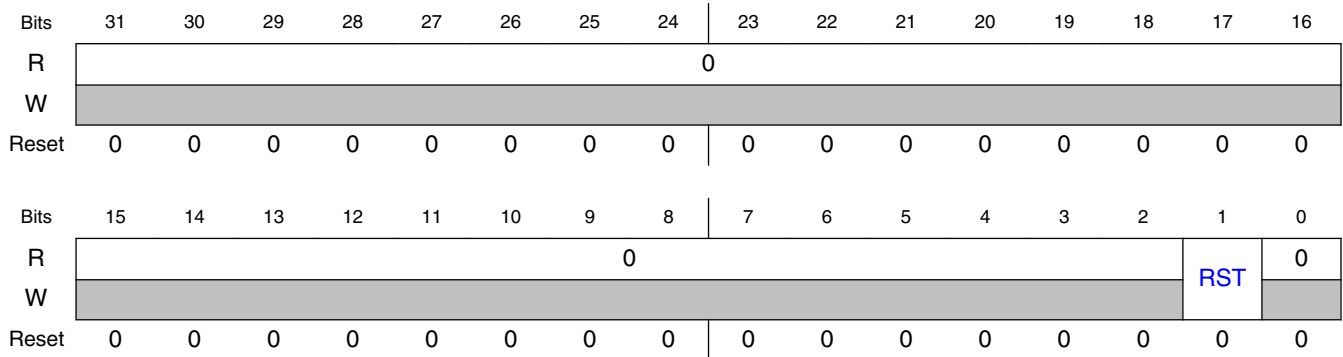

53.3.1.4.3 Fields

Field	Function
31-2 —	Reserved
1 RST	Software Reset Resets all internal logic and registers, except the Global Register. The reset takes effect immediately and remains asserted until negated by software. There is no minimum delay required before clearing the software reset. 0b - Module is not reset. 1b - Module is reset.
0 —	Reserved

53.3.1.5 LPUART Pin Configuration Register (PINCFG)

53.3.1.5.1 Offset

Register	Offset
PINCFG	Ch

Register definition

53.3.1.5.2 Diagram

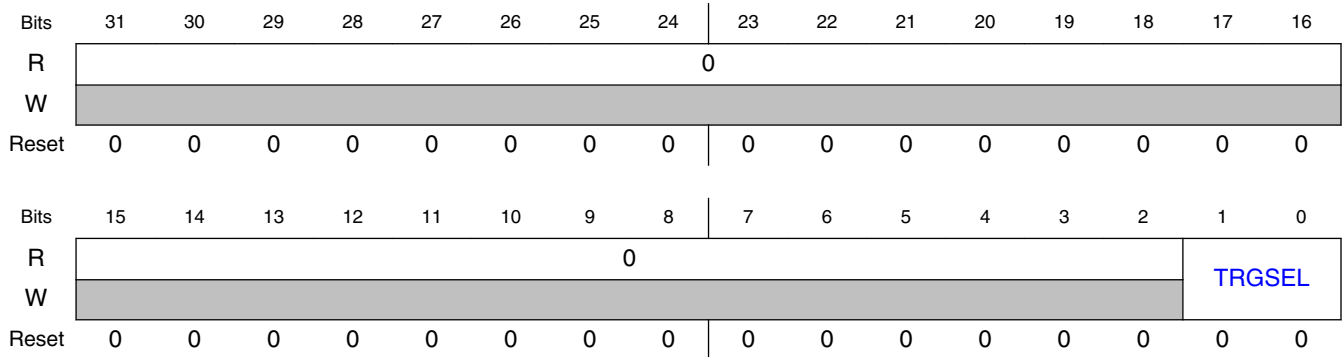

53.3.1.5.3 Fields

Field	Function
31-2 —	Reserved
1-0 TRGSEL	Trigger Select Configures the input trigger usage. This field should only be changed when the transmitter and receiver are both disabled. 00b - Input trigger is disabled. 01b - Input trigger is used instead of RXD pin input. 10b - Input trigger is used instead of CTS_B pin input. 11b - Input trigger is used to modulate the TXD pin output. The TXD pin output (after TXINV configuration) is ANDed with the input trigger.

53.3.1.6 LPUART Baud Rate Register (BAUD)

53.3.1.6.1 Offset

Register	Offset
BAUD	10h

53.3.1.6.2 Diagram

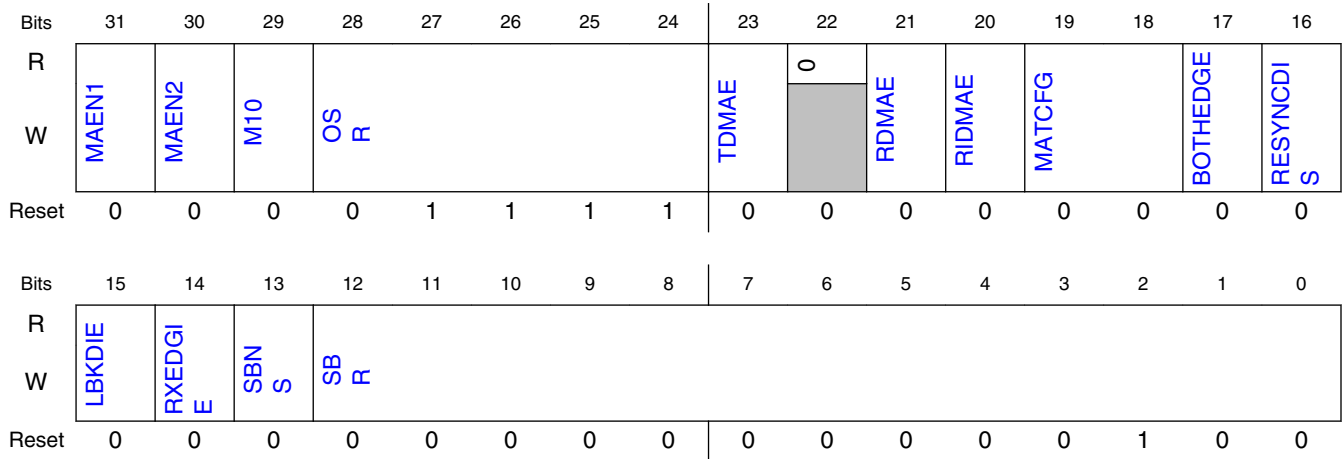

53.3.1.6.3 Fields

Field	Function
31 MAEN1	Match Address Mode Enable 1 0b - Normal operation. 1b - Enables automatic address matching or data matching mode for MATCH[MA1].
30 MAEN2	Match Address Mode Enable 2 0b - Normal operation. 1b - Enables automatic address matching or data matching mode for MATCH[MA2].
29 M10	10-bit Mode select The M10 bit causes a tenth bit to be part of the serial transmission. This bit should only be changed when the transmitter and receiver are both disabled. 0b - Receiver and transmitter use 7-bit to 9-bit data characters. 1b - Receiver and transmitter use 10-bit data characters.
28-24 OSR	Oversampling Ratio This field configures the oversampling ratio for the receiver. This field should only be changed when the transmitter and receiver are both disabled. 00000b - Writing 0 to this field results in an oversampling ratio of 16 00001b - Reserved 00010b - Reserved 00011b - Oversampling ratio of 4, requires BOTHEDGE to be set. 00100b - Oversampling ratio of 5, requires BOTHEDGE to be set. 00101b - Oversampling ratio of 6, requires BOTHEDGE to be set. 00110b - Oversampling ratio of 7, requires BOTHEDGE to be set. 00111b - Oversampling ratio of 8. 01000b - Oversampling ratio of 9. 01001b - Oversampling ratio of 10. 01010b - Oversampling ratio of 11. 01011b - Oversampling ratio of 12. 01100b - Oversampling ratio of 13. 01101b - Oversampling ratio of 14. 01110b - Oversampling ratio of 15. 01111b - Oversampling ratio of 16. 10000b - Oversampling ratio of 17.

Table continues on the next page...

Register definition

Field	Function
	10001b - Oversampling ratio of 18. 10010b - Oversampling ratio of 19. 10011b - Oversampling ratio of 20. 10100b - Oversampling ratio of 21. 10101b - Oversampling ratio of 22. 10110b - Oversampling ratio of 23. 10111b - Oversampling ratio of 24. 11000b - Oversampling ratio of 25. 11001b - Oversampling ratio of 26. 11010b - Oversampling ratio of 27. 11011b - Oversampling ratio of 28. 11100b - Oversampling ratio of 29. 11101b - Oversampling ratio of 30. 11110b - Oversampling ratio of 31. 11111b - Oversampling ratio of 32.
23 TDMAE	Transmitter DMA Enable TDMAE configures the transmit data register empty flag, STAT[TDRE], to generate a DMA request. 0b - DMA request disabled. 1b - DMA request enabled.
22 —	Reserved
21 RDMAE	Receiver Full DMA Enable RDMAE configures the receiver data register full flag, STAT[RDRF], to generate a DMA request. 0b - DMA request disabled. 1b - DMA request enabled.
20 RIDMAE	Receiver Idle DMA Enable RIDMAE configures the receiver idle flag, STAT[IDLE], to generate a DMA request. 0b - DMA request disabled. 1b - DMA request enabled.
19-18 MATCFG	Match Configuration Configures the match addressing mode used. This field should only be changed when the transmitter and receiver are both disabled. 00b - Address Match Wakeup 01b - Idle Match Wakeup 10b - Match On and Match Off 11b - Enables RWU on Data Match and Match On/Off for transmitter CTS input
17 BOTHEDGE	Both Edge Sampling Enables sampling of the received data on both edges of the baud rate clock, effectively doubling the number of times the receiver samples the input data for a given oversampling ratio. This bit must be set for oversampling ratios between x4 and x7 and is optional for higher oversampling ratios. This bit should only be changed when the receiver is disabled. 0b - Receiver samples input data using the rising edge of the baud rate clock. 1b - Receiver samples input data using the rising and falling edge of the baud rate clock.
16 RESYNCDIS	Resynchronization Disable When set, disables the resynchronization of the received data word when a data one followed by data zero transition is detected. This bit should only be changed when the receiver is disabled. 0b - Resynchronization during received data word is supported 1b - Resynchronization during received data word is disabled
15 LBKDIE	LIN Break Detect Interrupt Enable LBKDIE enables the LIN break detect flag, STAT[LBKDIF], to generate interrupt requests.

Table continues on the next page...

Field	Function
	0b - Hardware interrupts from STAT[LBKDIF] flag are disabled (use polling). 1b - Hardware interrupt requested when STAT[LBKDIF] flag is 1.
14 RXEDGIE	RX Input Active Edge Interrupt Enable Enables the receive input active edge, STAT[RXEDGIF], to generate interrupt requests. Changing CTRL[LOOP] or CTRL[RSRC] when RXEDGIE is set can cause the STAT[RXEDGIF] flag to set. 0b - Hardware interrupts from STAT[RXEDGIF] are disabled. 1b - Hardware interrupt is requested when STAT[RXEDGIF] flag is 1.
13 SBNS	Stop Bit Number Select SBNS determines whether data characters have one or two stop bits. This bit should only be changed when the transmitter and receiver are both disabled. 0b - One stop bit. 1b - Two stop bits.
12-0 SBR	Baud Rate Modulo Divisor. The 13 bits in SBR[12:0] set the modulo divide rate for the baud rate generator. When SBR is 1 - 8191, the baud rate equals "baud clock / ((OSR+1) × SBR)". The 13-bit baud rate setting [SBR12:SBR0] must be updated only when the transmitter and receiver are both disabled (CTRL[RE] and CTRL[TE] are both 0).

53.3.1.7 LPUART Status Register (STAT)

53.3.1.7.1 Offset

Register	Offset
STAT	14h

53.3.1.7.2 Diagram

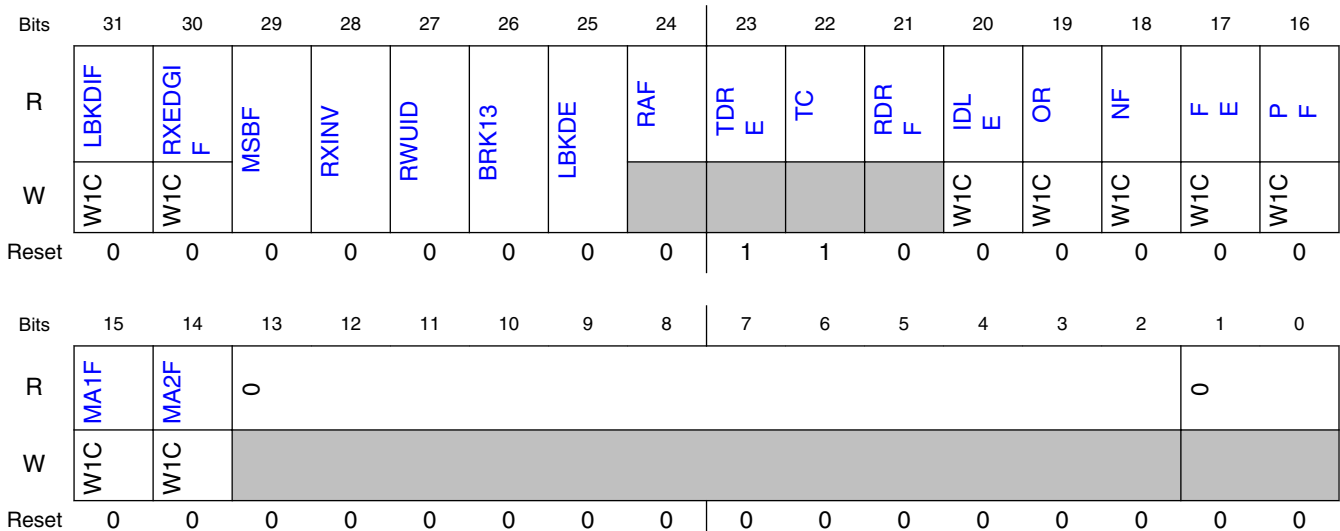

53.3.1.7.3 Fields

Field	Function
31 LBKDIF	<p>LIN Break Detect Interrupt Flag</p> <p>LBKDIF is set when the LIN break detect circuitry is enabled and a LIN break character is detected. LBKDIF is cleared by writing a 1 to it.</p> <p>0b - No LIN break character has been detected. 1b - LIN break character has been detected.</p>
30 RXEDGIF	<p>RXD Pin Active Edge Interrupt Flag</p> <p>RXEDGIF is set whenever the receiver is enabled and an active edge, falling if RXINV = 0, rising if RXINV=1, on the RXD pin occurs. RXEDGIF is cleared by writing a 1 to it.</p> <p>0b - No active edge on the receive pin has occurred. 1b - An active edge on the receive pin has occurred.</p>
29 MSBF	<p>MSB First</p> <p>Setting this bit reverses the order of the bits that are transmitted and received on the wire. This bit does not affect the polarity of the bits, the location of the parity bit or the location of the start or stop bits. This bit should only be changed when the transmitter and receiver are both disabled.</p> <p>0b - LSB (bit0) is the first bit that is transmitted following the start bit. Further, the first bit received after the start bit is identified as bit0. 1b - MSB (bit9, bit8, bit7 or bit6) is the first bit that is transmitted following the start bit depending on the setting of CTRL[M], CTRL[PE] and BAUD[M10]. Further, the first bit received after the start bit is identified as bit9, bit8, bit7 or bit6 depending on the setting of CTRL[M] and CTRL[PE].</p>
28 RXINV	<p>Receive Data Inversion</p> <p>Setting this bit reverses the polarity of the received data input. This bit should only be changed when the receiver is disabled.</p> <p>NOTE: Setting RXINV inverts the RXD input for all cases: data bits, start and stop bits, break, and idle.</p> <p>0b - Receive data not inverted. 1b - Receive data inverted.</p>
27 RWUID	<p>Receive Wake Up Idle Detect</p> <p>For RWU on idle character, RWUID controls whether the idle character that wakes up the receiver sets the IDLE bit. For address match wakeup, RWUID controls if the IDLE bit is set when the address does not match. This bit should only be changed when the receiver is disabled.</p> <p>0b - During receive standby state (RWU = 1), the IDLE bit does not get set upon detection of an idle character. During address match wakeup, the IDLE bit does not set when an address does not match. 1b - During receive standby state (RWU = 1), the IDLE bit gets set upon detection of an idle character. During address match wakeup, the IDLE bit does set when an address does not match.</p>
26 BRK13	<p>Break Character Generation Length</p> <p>BRK13 selects a longer transmitted break character length. Detection of a framing error is not affected by the state of this bit. This bit should only be changed when the transmitter is disabled. A break character can be sent by setting CTRL[SBK] or by writing the transmit FIFO with DATA[FRETSC] set and DATA[R9T9] clear.</p> <p>0b - Break character is transmitted with length of 9 to 13 bit times. 1b - Break character is transmitted with length of 12 to 15 bit times.</p>
25 LBKDE	<p>LIN Break Detection Enable</p> <p>LBKDE selects a longer break character detection length. While LBKDE is set, receive data is not stored in the receive data buffer.</p>

Table continues on the next page...

Field	Function
	<p>NOTE: The LBKDE bit enables the LIN break detect circuit and disables writing receive data to FIFO. So it essentially ignores all characters except a LIN break.</p> <p>0b - LIN break detect is disabled, normal break character can be detected.</p> <p>1b - LIN break detect is enabled. LIN break character is detected at length of 11 bit times (if M = 0) or 12 (if M = 1) or 13 (M10 = 1).</p>
24 RAF	<p>Receiver Active Flag</p> <p>RAF is set when the receiver detects the beginning of a valid start bit, and RAF is cleared automatically when the receiver detects an idle line.</p> <p>0b - LPUART receiver idle waiting for a start bit.</p> <p>1b - LPUART receiver active (RXD input not idle).</p>
23 TDRE	<p>Transmit Data Register Empty Flag</p> <p>When the transmit FIFO is enabled, TDRE is set when the number of datawords in the transmit FIFO (DATA register) is equal to or less than the number indicated by WATER[TXWATER]. To clear TDRE, write to the DATA register until the number of words in the transmit FIFO is greater than the number indicated by WATER[TXWATER]. When the transmit FIFO is disabled, TDRE is set when the transmit DATA register is empty. To clear TDRE, write to the DATA register.</p> <p>TDRE is not affected by a character that is in the process of being transmitted; it is updated at the start of each transmitted character.</p> <p>0b - Transmit data buffer full.</p> <p>1b - Transmit data buffer empty.</p>
22 TC	<p>Transmission Complete Flag</p> <p>TC is cleared when there is a transmission in progress or when a preamble or break character is loaded. TC is set when the transmit buffer is empty and no data, preamble, or break character is being transmitted. When TC is set, the transmit data output signal becomes idle (logic 1). TC is cleared by writing to the DATA register to transmit new data, queuing a preamble by clearing and then setting CTRL[TE], queuing a break character by writing 1 to CTRL[SBK].</p> <p>0b - Transmitter active (sending data, a preamble, or a break).</p> <p>1b - Transmitter idle (transmission activity complete).</p>
21 RDRF	<p>Receive Data Register Full Flag</p> <p>When the receive FIFO is enabled, RDRF is set when the number of datawords in the receive buffer is greater than the number indicated by WATER[RXWATER]. To clear RDRF, read the DATA register until the number of datawords in the receive data buffer is equal to or less than the number indicated by WATER[RXWATER]. When the receive FIFO is disabled, RDRF is set when the receive buffer (the DATA register) is full. To clear RDRF, read the DATA register.</p> <p>A character that is in the process of being received does not cause a change in RDRF until the entire character is received. Even if RDRF is set, the character continues to be received until an overrun condition occurs once the entire character is received.</p> <p>0b - Receive data buffer empty.</p> <p>1b - Receive data buffer full.</p>
20 IDLE	<p>Idle Line Flag</p> <p>IDLE is set when the LPUART receive line becomes idle for a full character time after a period of activity. When CTRL[ILT] is cleared, the receiver starts counting idle bit times after the start bit. If the receive character is all 1s, these bit times and the stop bits time count toward the full character time of logic high, 10 to 13 bit times, needed for the receiver to detect an idle line. When CTRL[ILT] is set, the receiver doesn't start counting idle bit times until after the stop bits. The stop bits and any logic high bit times at the end of the previous character do not count toward the full character time of logic high needed for the receiver to detect an idle line.</p> <p>To clear IDLE, write logic 1 to the IDLE flag. After IDLE has been cleared, it cannot be set again until after a new character has been stored in the receive buffer or a LIN break character has set the LBKDIF flag. IDLE is set only once even if the receive line remains idle for an extended period.</p>

Table continues on the next page...

Register definition

Field	Function
	<p>0b - No idle line detected. 1b - Idle line was detected.</p>
19 OR	<p>Receiver Overrun Flag</p> <p>OR is set when software fails to prevent the receive data register from overflowing with data. The OR bit is set immediately after the stop bit has been completely received for the dataword that overflows the buffer and all the other error flags (FE, NF, and PF) are prevented from setting. The data in the shift register is lost, but the data already in the LPUART data registers is not affected. If LBKDE is enabled and a LIN Break is detected, the OR field asserts if LBKDIF is not cleared before the next data character is received.</p> <p>While the OR flag is set, no additional data is stored in the data buffer even if sufficient room exists. To clear OR, write logic 1 to the OR flag.</p> <p>0b - No overrun. 1b - Receive overrun (new LPUART data lost).</p>
18 NF	<p>Noise Flag</p> <p>The advanced sampling technique used in the receiver takes three samples in each of the received bits. If any of these samples disagrees with the rest of the samples within any bit time in the frame then noise is detected for that character. NF is set whenever the next character to be read from the DATA register was received with noise detected within the character. To clear NF, write logic 1 to the NF field.</p> <p>0b - No noise detected. 1b - Noise detected in the received character in the DATA register.</p>
17 FE	<p>Framing Error Flag</p> <p>FE is set whenever the next character to be read from the DATA register was received with logic 0 detected where a stop bit was expected. To clear FE, write logic 1 to the FE field.</p> <p>0b - No framing error detected. This does not guarantee the framing is correct. 1b - Framing error.</p>
16 PF	<p>Parity Error Flag</p> <p>PF is set whenever the next character to be read from the DATA register was received when parity is enabled (PE = 1) and the parity bit in the received character does not agree with the expected parity value. To clear PF, write a logic 1 to the PF field.</p> <p>0b - No parity error. 1b - Parity error.</p>
15 MA1F	<p>Match 1 Flag</p> <p>MA1F is set whenever the next character to be read from the DATA register matches MA1. To clear MA1F, write a logic 1 to the MA1F field.</p> <p>0b - Received data is not equal to MA1 1b - Received data is equal to MA1</p>
14 MA2F	<p>Match 2 Flag</p> <p>MA2F is set whenever the next character to be read from the DATA register matches MA2. To clear MA2F, write a logic 1 to the MA2F field.</p> <p>0b - Received data is not equal to MA2 1b - Received data is equal to MA2</p>
13-2 —	Reserved
1-0 —	Reserved

53.3.1.8 LPUART Control Register (CTRL)

53.3.1.8.1 Offset

Register	Offset
CTRL	18h

53.3.1.8.2 Function

This read/write register controls various optional features of the LPUART system. This register should only be altered when the transmitter and receiver are both disabled.

53.3.1.8.3 Diagram

Bits	31	30	29	28	27	26	25	24	23	22	21	20	19	18	17	16
R	R8T9	R9T8	TXDIR	TXINV	ORIE	NEIE	FEIE	PEIE	TIIE	TCIE	RIIE	ILIE	TE	RE	RWU	SBK
W																
Reset	0	0	0	0	0	0	0	0	0	0	0	0	0	0	0	0
Bits	15	14	13	12	11	10	9	8	7	6	5	4	3	2	1	0
R	MA1IE	MA2IE	0		M7	IDLECF			LOOPS	DOZEEN	RSRC	M	WAKE	ILT	PE	PT
W																
Reset	0	0	0	0	0	0	0	0	0	0	0	0	0	0	0	0

53.3.1.8.4 Fields

Field	Function
31 R8T9	Receive Bit 8 / Transmit Bit 9 R8 is the ninth data bit received when the LPUART is configured for 9-bit or 10-bit data formats. When reading 9-bit or 10-bit data, read R8 before reading the DATA register. T9 is the tenth data bit transmitted when the LPUART is configured for 10-bit data formats. When writing 10-bit data, write T9 before writing the DATA register. If T9 does not need to change from its previous value, such as when it is used to generate address mark or parity, they it need not be written each time the DATA register is written. NOTE: R8 is a read-only bit and T9 is a write-only bit, the value read is different from the value written.
30 R9T8	Receive Bit 9 / Transmit Bit 8 R9 is the tenth data bit received when the LPUART is configured for 10-bit data formats. When reading 10-bit data, read R9 before reading the DATA register

Table continues on the next page...

Register definition

Field	Function
	<p>T8 is the ninth data bit transmitted when the LPUART is configured for 9-bit or 10-bit data formats. When writing 9-bit or 10-bit data, write T8 before writing the DATA register. If T8 does not need to change from its previous value, such as when it is used to generate address mark or parity, then it need not be written each time the DATA register is written.</p> <p>NOTE: R9 is a read-only bit and T8 is a write-only bit, the value read is different from the value written.</p>
29 TXDIR	<p>TXD Pin Direction in Single-Wire Mode</p> <p>When the LPUART is configured for single-wire half-duplex operation (LOOPS = RSRC = 1), this bit determines the direction of data at the TXD pin. When clearing TXDIR, the transmitter finishes receiving the current character (if any) before the receiver starts receiving data from the TXD pin.</p> <p>0b - TXD pin is an input in single-wire mode. 1b - TXD pin is an output in single-wire mode.</p>
28 TXINV	<p>Transmit Data Inversion</p> <p>Setting this bit reverses the polarity of the transmitted data output.</p> <p>NOTE: Setting TXINV inverts the TXD output for all cases: data bits, start and stop bits, break, and idle.</p> <p>0b - Transmit data not inverted. 1b - Transmit data inverted.</p>
27 ORIE	<p>Overrun Interrupt Enable</p> <p>This bit enables the overrun flag (OR) to generate hardware interrupt requests.</p> <p>0b - OR interrupts disabled; use polling. 1b - Hardware interrupt requested when OR is set.</p>
26 NEIE	<p>Noise Error Interrupt Enable</p> <p>This bit enables the noise flag (NF) to generate hardware interrupt requests.</p> <p>0b - NF interrupts disabled; use polling. 1b - Hardware interrupt requested when NF is set.</p>
25 FEIE	<p>Framing Error Interrupt Enable</p> <p>This bit enables the framing error flag (FE) to generate hardware interrupt requests.</p> <p>0b - FE interrupts disabled; use polling. 1b - Hardware interrupt requested when FE is set.</p>
24 PEIE	<p>Parity Error Interrupt Enable</p> <p>This bit enables the parity error flag (PF) to generate hardware interrupt requests.</p> <p>0b - PF interrupts disabled; use polling. 1b - Hardware interrupt requested when PF is set.</p>
23 TIE	<p>Transmit Interrupt Enable</p> <p>Enables STAT[TDRE] to generate interrupt requests.</p> <p>0b - Hardware interrupts from TDRE disabled; use polling. 1b - Hardware interrupt requested when TDRE flag is 1.</p>
22 TCIE	<p>Transmission Complete Interrupt Enable for</p> <p>TCIE enables the transmission complete flag, TC, to generate interrupt requests.</p> <p>0b - Hardware interrupts from TC disabled; use polling. 1b - Hardware interrupt requested when TC flag is 1.</p>
21 RIE	<p>Receiver Interrupt Enable</p> <p>Enables STAT[RDRF] to generate interrupt requests.</p> <p>0b - Hardware interrupts from RDRF disabled; use polling. 1b - Hardware interrupt requested when RDRF flag is 1.</p>
20 ILIE	<p>Idle Line Interrupt Enable</p> <p>ILIE enables the idle line flag, STAT[IDLE], to generate interrupt requests.</p> <p>0b - Hardware interrupts from IDLE disabled; use polling.</p>

Table continues on the next page...

Field	Function
	1b - Hardware interrupt requested when IDLE flag is 1.
19 TE	<p>Transmitter Enable</p> <p>Enables the LPUART transmitter. TE can also be used to queue an idle preamble by clearing and then setting TE. When TE is cleared, this register bit reads as 1 until the transmitter has completed the current character and the TXD pin is tristated.</p> <p>A single idle character can also be queued by writing to the transmit FIFO with DATA[FRETSC] set and DATA[R9T9] set.</p> <p>0b - Transmitter disabled. 1b - Transmitter enabled.</p>
18 RE	<p>Receiver Enable</p> <p>Enables the LPUART receiver. When RE is written to 0, this register bit reads as 1 until the receiver finishes receiving the current character (if any).</p> <p>0b - Receiver disabled. 1b - Receiver enabled.</p>
17 RWU	<p>Receiver Wakeup Control</p> <p>This field can be set to place the LPUART receiver in a standby state. RWU automatically clears when an RWU event occurs, that is, an IDLE event when CTRL[WAKE] is clear or an address match when CTRL[WAKE] is set with STAT[RWUID] is clear.</p> <p>NOTE: RWU must be set only with CTRL[WAKE] = 0 (wake up on idle) if the channel is currently not idle. This can be determined by STAT[RAF]. If the flag is set to wake up an IDLE event and the channel is already idle, it is possible that the LPUART will discard data. This is because the data must be received or a LIN break detected after an IDLE is detected before IDLE is allowed to be reasserted.</p> <p>0b - Normal receiver operation. 1b - LPUART receiver in standby waiting for wakeup condition.</p>
16 SBK	<p>Send Break</p> <p>Writing a 1 and then a 0 to SBK queues a break character in the transmit data stream. Additional break characters of 9 to 13 bits, or 12 to 15 bits if STAT[BRK13] is set, bit times of logic 0 are queued as long as SBK is set. Depending on the timing of the set and clear of SBK relative to the character currently being transmitted, a second break character may be queued before software clears SBK.</p> <p>A single break character can also be queued by writing to the transmit FIFO with DATA[FRETSC] set and DATA[R9T9] clear.</p> <p>0b - Normal transmitter operation. 1b - Queue break character(s) to be sent.</p>
15 MA1IE	<p>Match 1 Interrupt Enable</p> <p>0b - MA1F interrupt disabled 1b - MA1F interrupt enabled</p>
14 MA2IE	<p>Match 2 Interrupt Enable</p> <p>0b - MA2F interrupt disabled 1b - MA2F interrupt enabled</p>
13-12 —	Reserved
11 M7	<p>7-Bit Mode Select</p> <p>This bit should only be changed when the transmitter and receiver are both disabled.</p> <p>0b - Receiver and transmitter use 8-bit to 10-bit data characters. 1b - Receiver and transmitter use 7-bit data characters.</p>
10-8	Idle Configuration

Table continues on the next page...

Register definition

Field	Function
IDLECFG	Configures the number of idle characters that must be received before the IDLE flag is set. 000b - 1 idle character 001b - 2 idle characters 010b - 4 idle characters 011b - 8 idle characters 100b - 16 idle characters 101b - 32 idle characters 110b - 64 idle characters 111b - 128 idle characters
7 LOOPS	Loop Mode Select When LOOPS is set, the RXD pin is disconnected from the LPUART and the transmitter output is internally connected to the receiver input. The transmitter and the receiver must be enabled to use the loop function. 0b - Normal operation - RXD and TXD use separate pins. 1b - Loop mode or single-wire mode where transmitter outputs are internally connected to receiver input (see RSRC bit).
6 DOZEEN	Doze Enable 0b - LPUART is enabled in Doze mode. 1b - LPUART is disabled in Doze mode.
5 RSRC	Receiver Source Select This field has no meaning or effect unless the LOOPS field is set. When LOOPS is set, the RSRC field determines the source for the receiver shift register input. 0b - Provided LOOPS is set, RSRC is cleared, selects internal loop back mode and the LPUART does not use the RXD pin. 1b - Single-wire LPUART mode where the TXD pin is connected to the transmitter output and receiver input.
4 M	9-Bit or 8-Bit Mode Select 0b - Receiver and transmitter use 8-bit data characters. 1b - Receiver and transmitter use 9-bit data characters.
3 WAKE	Receiver Wakeup Method Select Determines which condition wakes the LPUART when RWU=1: <ul style="list-style-type: none"> Address mark in the bit preceding the stop bit (or bit preceding the parity bit when parity is enabled) of the received data character, or An idle condition on the receive pin input signal. 0b - Configures RWU for idle-line wakeup. 1b - Configures RWU with address-mark wakeup.
2 ILT	Idle Line Type Select Determines when the receiver starts counting logic 1s as idle character bits. The count begins either after a valid start bit or after the stop bit. If the count begins after the start bit, then a string of logic 1s preceding the stop bit can cause false recognition of an idle character. Beginning the count after the stop bit avoids false idle character recognition, but requires properly synchronized transmissions. NOTE: In case the LPUART is programmed with ILT = 1, a logic 0 is automatically shifted after a received stop bit, therefore resetting the idle count. 0b - Idle character bit count starts after start bit. 1b - Idle character bit count starts after stop bit.
1 PE	Parity Enable Enables hardware parity generation and checking. When parity is enabled, the bit immediately before the stop bit is treated as the parity bit. 0b - No hardware parity generation or checking. 1b - Parity enabled.

Table continues on the next page...

Field	Function
0	Parity Type
PT	Provided parity is enabled (PE = 1), this bit selects even or odd parity. Odd parity means the total number of 1s in the data character, including the parity bit, is odd. Even parity means the total number of 1s in the data character, including the parity bit, is even. 0b - Even parity. 1b - Odd parity.

53.3.1.9 LPUART Data Register (DATA)

53.3.1.9.1 Offset

Register	Offset
DATA	1Ch

53.3.1.9.2 Function

NOTE

This register is two separate registers. Reads return the contents of the read-only receive data buffer and writes go to the write-only transmit data buffer.

Reads and writes of this register are also involved in the automatic flag clearing mechanisms for some of the LPUART status flags.

53.3.1.9.3 Diagram

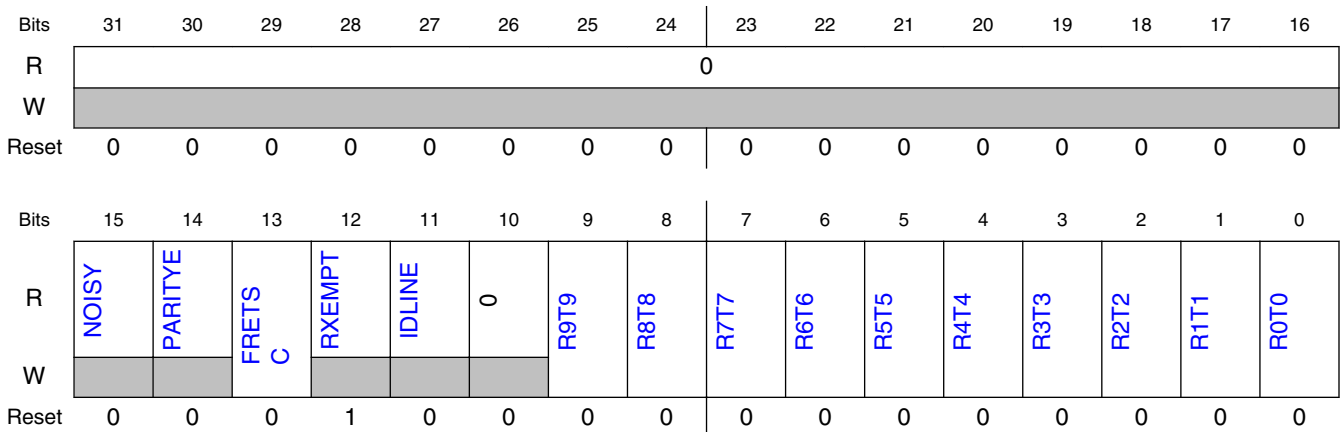

53.3.1.9.4 Fields

Field	Function
31-16 —	Reserved
15 NOISY	NOISY The current received dataword contained in DATA[R9:R0] was received with noise. 0b - The dataword was received without noise. 1b - The data was received with noise.
14 PARITYE	PARITYE The current received dataword contained in DATA[R9:R0] was received with a parity error. 0b - The dataword was received without a parity error. 1b - The dataword was received with a parity error.
13 FRETSC	Frame Error / Transmit Special Character For reads, indicates the current received dataword contained in DATA[R9:R0] was received with a frame error. For writes, indicates a break or idle character is to be transmitted instead of the contents in DATA[T9:T0]. T9 is used to indicate a break character when 0 and a idle character when 1, the contents of DATA[T8:T0] should be zero. 0b - The dataword was received without a frame error on read, or transmit a normal character on write. 1b - The dataword was received with a frame error, or transmit an idle or break character on transmit.
12 RXEMPT	Receive Buffer Empty Asserts when there is no data in the receive buffer. This field does not take into account data that is in the receive shift register. 0b - Receive buffer contains valid data. 1b - Receive buffer is empty, data returned on read is not valid.
11 IDLINE	Idle Line Indicates the receiver line was idle before receiving the character in DATA[9:0]. Unlike the IDLE flag, this bit can set for the first character received when the receiver is first enabled. 0b - Receiver was not idle before receiving this character. 1b - Receiver was idle before receiving this character.
10 —	Reserved
9 R9T9	R9T9 Read receive data buffer 9 or write transmit data buffer 9.
8 R8T8	R8T8 Read receive data buffer 8 or write transmit data buffer 8.
7 R7T7	R7T7 Read receive data buffer 7 or write transmit data buffer 7.
6 R6T6	R6T6 Read receive data buffer 6 or write transmit data buffer 6.
5 R5T5	R5T5 Read receive data buffer 5 or write transmit data buffer 5.
4 R4T4	R4T4 Read receive data buffer 4 or write transmit data buffer 4.

Table continues on the next page...

Field	Function
3 R3T3	R3T3 Read receive data buffer 3 or write transmit data buffer 3.
2 R2T2	R2T2 Read receive data buffer 2 or write transmit data buffer 2.
1 R1T1	R1T1 Read receive data buffer 1 or write transmit data buffer 1.
0 R0T0	R0T0 Read receive data buffer 0 or write transmit data buffer 0.

53.3.1.10 LPUART Match Address Register (MATCH)

53.3.1.10.1 Offset

Register	Offset
MATCH	20h

53.3.1.10.2 Diagram

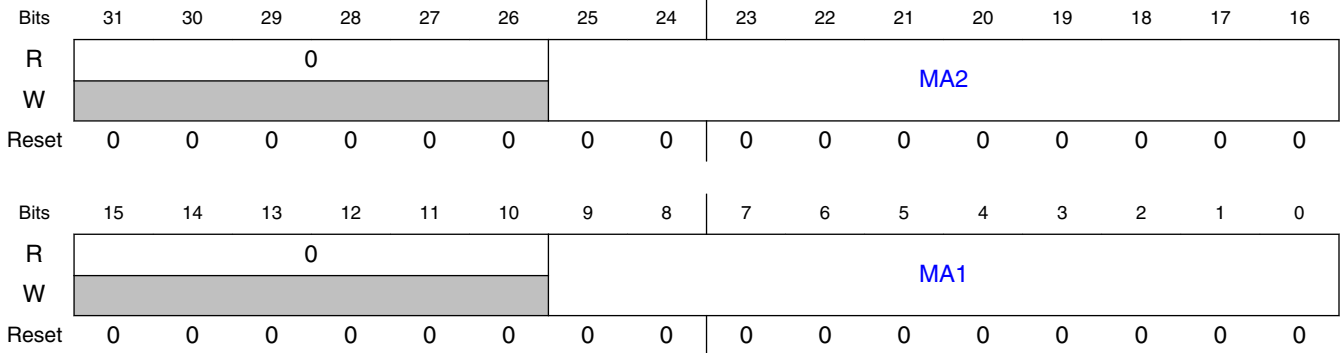

53.3.1.10.3 Fields

Field	Function
31-26 —	Reserved
25-16 MA2	Match Address 2

Table continues on the next page...

Register definition

Field	Function
	The MA1 and MA2 fields are compared to input data addresses when the most significant bit is set and the associated BAUD[MAEN] bit is set. If a match occurs, the following data is transferred to the DATA register. If a match fails, the following data is discarded. Software should only write a MAX field when the associated BAUD[MAEN] bit is clear.
15-10 —	Reserved
9-0 MA1	Match Address 1 The MA1 and MA2 fields are compared to input data addresses when the most significant bit is set and the associated BAUD[MAEN] bit is set. If a match occurs, the following data is transferred to the DATA register. If a match fails, the following data is discarded. Software should only write a MAX field when the associated BAUD[MAEN] bit is clear.

53.3.1.11 LPUART Modem IrDA Register (MODIR)

53.3.1.11.1 Offset

Register	Offset
MODIR	24h

53.3.1.11.2 Function

The MODEM register controls options for setting the modem configuration.

53.3.1.11.3 Diagram

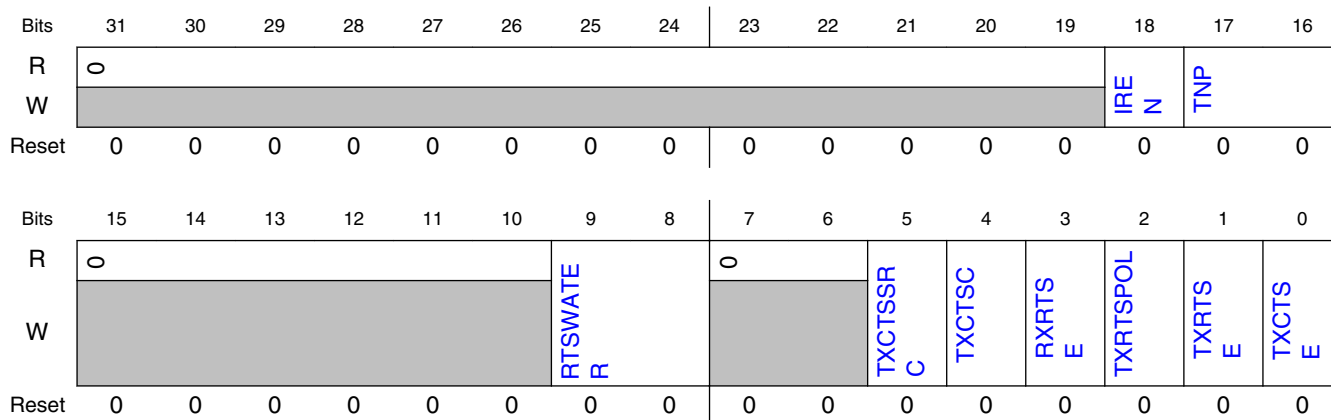

53.3.1.11.4 Fields

Field	Function
31-19 —	Reserved
18 IREN	Infrared enable Enables/disables the infrared modulation/demodulation. This bit should only be changed when the transmitter and receiver are both disabled. 0b - IR disabled. 1b - IR enabled.
17-16 TNP	Transmitter narrow pulse Configures whether the LPUART transmits a 1/OSR, 2/OSR, 3/OSR or 4/OSR narrow pulse when IR is enabled. This bit should only be changed when the transmitter and receiver are both disabled. The IR pulse width should be configured to less than half of the oversampling ratio. Common pulse widths are 3/16, 1/16, 1/32 or 1/4 of the bit length. These can be configured by selecting the appropriate oversample ratio and pulse width. 00b - 1/OSR. 01b - 2/OSR. 10b - 3/OSR. 11b - 4/OSR.
15-10 —	Reserved
9-8 RTSWATER	Receive RTS Configuration Configures the assertion and negation of the RX RTS_B output. The RX RTS_B output negates when the number of empty words in the receive FIFO is greater or equal to RTSWATER. If RTSWATER is configured to zero, RTS_B negates when the receive FIFO is full. For the purpose of RX RTS_B generation, the number of words in the receive FIFO updates when a start bit is detected. This supports additional latency between RTS_B negation and the external transmitter ceasing transmission. If both RX RTS_B and address/data matching is enabled, then RTS_B could assert at the end of a character if there is not a match. This field should only be changed when the receiver is disabled.
7-6 —	Reserved
5 TXCTSSRC	Transmit CTS Source Configures the source of the CTS input. 0b - CTS input is the CTS_B pin. 1b - CTS input is the inverted Receiver Match result.
4 TXCTSC	Transmit CTS Configuration Configures if the CTS state is checked at the start of each character or only when the transmitter is idle. 0b - CTS input is sampled at the start of each character. 1b - CTS input is sampled when the transmitter is idle.
3 RXRTSE	Receiver request-to-send enable Allows the RTS output to control the CTS input of the transmitting device to prevent receiver overrun. This bit should only be changed when the receiver is disabled. NOTE: Do not set both RXRTSE and TXRTSE. 0b - The receiver has no effect on RTS.

Table continues on the next page...

Register definition

Field	Function
	1b - RTS is deasserted if the receiver data register is full or a start bit has been detected that would cause the receiver data register to become full. RTS is asserted if the receiver data register is not full and has not detected a start bit that would cause the receiver data register to become full.
2 TXRTSPOL	Transmitter request-to-send polarity Controls the polarity of the transmitter RTS. TXRTSPOL does not affect the polarity of the receiver RTS. RTS remains negated in the active low state unless TXRTSE is set. This bit should only be changed when the transmitter is disabled. 0b - Transmitter RTS is active low. 1b - Transmitter RTS is active high.
1 TXRTSE	Transmitter request-to-send enable Controls RTS before and after a transmission. This bit should only be changed when the transmitter is disabled. 0b - The transmitter has no effect on RTS. 1b - When a character is placed into an empty transmitter data buffer , RTS asserts one bit time before the start bit is transmitted. RTS deasserts one bit time after all characters in the transmitter data buffer and shift register are completely sent, including the last stop bit.
0 TXCTSE	Transmitter clear-to-send enable TXCTSE controls the operation of the transmitter. TXCTSE can be set independently from the state of TXRTSE and RXRTSE. 0b - CTS has no effect on the transmitter. 1b - Enables clear-to-send operation. The transmitter checks the state of CTS each time it is ready to send a character. If CTS is asserted, the character is sent. If CTS is deasserted, the signal TXD remains in the mark state and transmission is delayed until CTS is asserted. Changes in CTS as a character is being sent do not affect its transmission.

53.3.1.12 LPUART FIFO Register (FIFO)

53.3.1.12.1 Offset

Register	Offset
FIFO	28h

53.3.1.12.2 Function

This register provides the ability for the programmer to turn on and off FIFO functionality. It also provides the size of the FIFO that has been implemented. This register may be read at any time. This register must be written only when CTRL[RE] and CTRL[TE] are cleared/not set and when the data buffer/FIFO is empty.

53.3.1.12.3 Diagram

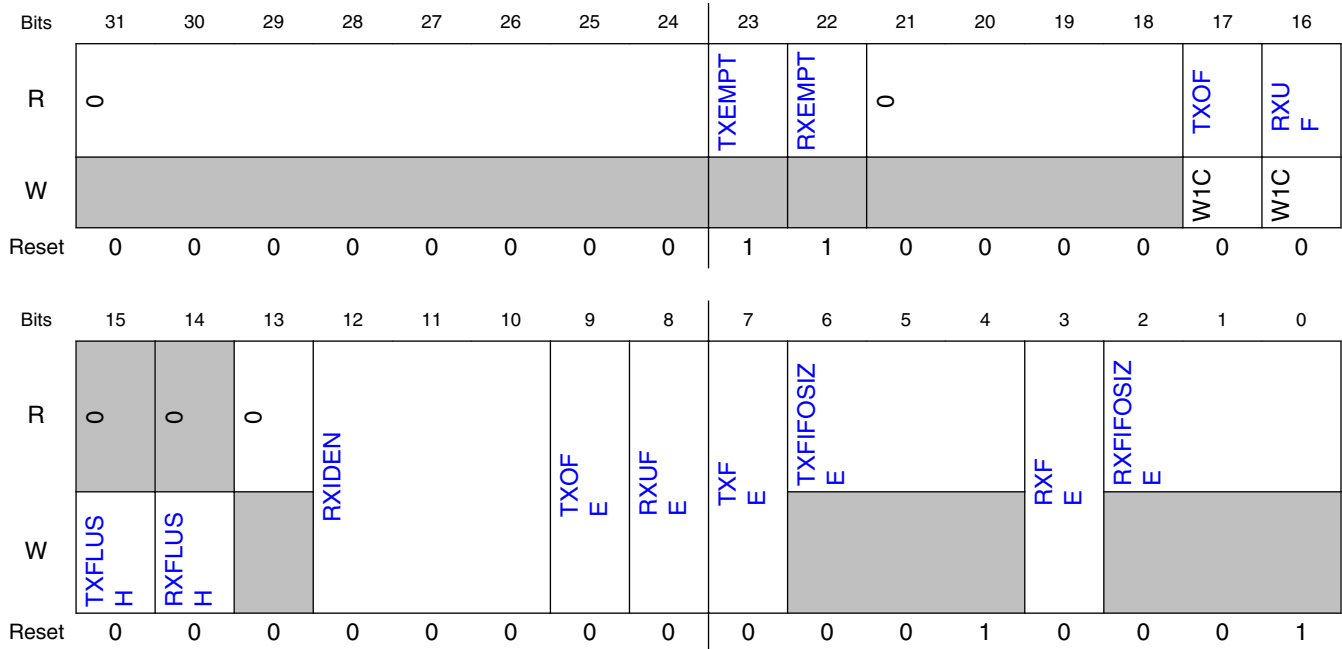

53.3.1.12.4 Fields

Field	Function
31-24 —	Reserved
23 TXEMPT	Transmit Buffer/FIFO Empty Asserts when there is no data in the Transmit FIFO/buffer. This field does not take into account data that is in the transmit shift register. 0b - Transmit buffer is not empty. 1b - Transmit buffer is empty.
22 RXEMPT	Receive Buffer/FIFO Empty Asserts when there is no data in the receive FIFO/Buffer. This field does not take into account data that is in the receive shift register. 0b - Receive buffer is not empty. 1b - Receive buffer is empty.
21-18 —	Reserved
17 TXOF	Transmitter Buffer Overflow Flag Indicates that more data has been written to the transmit buffer than it can hold. This field asserts regardless of the value of TXOFE. However, an interrupt is issued to the host only if TXOFE is set. This flag is cleared by writing a 1. 0b - No transmit buffer overflow has occurred since the last time the flag was cleared. 1b - At least one transmit buffer overflow has occurred since the last time the flag was cleared.
16	Receiver Buffer Underflow Flag

Table continues on the next page...

Register definition

Field	Function
RXUF	Indicates that more data has been read from the receive buffer than was present. This field asserts regardless of the value of RXUFE. However, an interrupt is issued to the host only if RXUFE is set. This flag is cleared by writing a 1. 0b - No receive buffer underflow has occurred since the last time the flag was cleared. 1b - At least one receive buffer underflow has occurred since the last time the flag was cleared.
15 TXFLUSH	Transmit FIFO/Buffer Flush Writing to this field causes all data that is stored in the transmit FIFO/buffer to be flushed. This does not affect data that is in the transmit shift register. 0b - No flush operation occurs. 1b - All data in the transmit FIFO/Buffer is cleared out.
14 RXFLUSH	Receive FIFO/Buffer Flush Writing to this field causes all data that is stored in the receive FIFO/buffer to be flushed. This does not affect data that is in the receive shift register. 0b - No flush operation occurs. 1b - All data in the receive FIFO/buffer is cleared out.
13 —	Reserved
12-10 RXIDEN	Receiver Idle Empty Enable When set, enables the assertion of RDRF when the receiver is idle for a number of idle characters and the FIFO is not empty. 000b - Disable RDRF assertion due to partially filled FIFO when receiver is idle. 001b - Enable RDRF assertion due to partially filled FIFO when receiver is idle for 1 character. 010b - Enable RDRF assertion due to partially filled FIFO when receiver is idle for 2 characters. 011b - Enable RDRF assertion due to partially filled FIFO when receiver is idle for 4 characters. 100b - Enable RDRF assertion due to partially filled FIFO when receiver is idle for 8 characters. 101b - Enable RDRF assertion due to partially filled FIFO when receiver is idle for 16 characters. 110b - Enable RDRF assertion due to partially filled FIFO when receiver is idle for 32 characters. 111b - Enable RDRF assertion due to partially filled FIFO when receiver is idle for 64 characters.
9 TXOFE	Transmit FIFO Overflow Interrupt Enable When this field is set, the TXOF flag generates an interrupt to the host. 0b - TXOF flag does not generate an interrupt to the host. 1b - TXOF flag generates an interrupt to the host.
8 RXUFE	Receive FIFO Underflow Interrupt Enable When this field is set, the RXUF flag generates an interrupt to the host. 0b - RXUF flag does not generate an interrupt to the host. 1b - RXUF flag generates an interrupt to the host.
7 TXFE	Transmit FIFO Enable When this field is set, the built-in FIFO structure for the transmit buffer is enabled. The size of the FIFO structure is indicated by TXFIFOSIZE. If this field is not set, the transmit buffer operates as a FIFO of depth one dataword regardless of the value in TXFIFOSIZE. Both CTRL[TE] and CTRL[RE] must be cleared prior to changing this field. 0b - Transmit FIFO is not enabled. Buffer is depth 1. 1b - Transmit FIFO is enabled. Buffer is depth indicated by TXFIFOSIZE.
6-4 TXFIFOSIZE	Transmit FIFO Buffer Depth The maximum number of transmit datawords that can be stored in the transmit buffer. This field is read only. 000b - Transmit FIFO/Buffer depth = 1 dataword. 001b - Transmit FIFO/Buffer depth = 4 datawords. 010b - Transmit FIFO/Buffer depth = 8 datawords. 011b - Transmit FIFO/Buffer depth = 16 datawords.

Table continues on the next page...

Field	Function
	100b - Transmit FIFO/Buffer depth = 32 datawords. 101b - Transmit FIFO/Buffer depth = 64 datawords. 110b - Transmit FIFO/Buffer depth = 128 datawords. 111b - Transmit FIFO/Buffer depth = 256 datawords
3 RXFE	Receive FIFO Enable When this field is set, the built-in FIFO structure for the receive buffer is enabled. The size of the FIFO structure is indicated by the RXFIFOSIZE field. If this field is not set, the receive buffer operates as a FIFO of depth one dataword regardless of the value in RXFIFOSIZE. Both CTRL[TE] and CTRL[RE] must be cleared prior to changing this field. 0b - Receive FIFO is not enabled. Buffer is depth 1. 1b - Receive FIFO is enabled. Buffer is depth indicted by RXFIFOSIZE.
2-0 RXFIFOSIZE	Receive FIFO Buffer Depth The maximum number of receive datawords that can be stored in the receive buffer before an overrun occurs. This field is read only. 000b - Receive FIFO/Buffer depth = 1 dataword. 001b - Receive FIFO/Buffer depth = 4 datawords. 010b - Receive FIFO/Buffer depth = 8 datawords. 011b - Receive FIFO/Buffer depth = 16 datawords. 100b - Receive FIFO/Buffer depth = 32 datawords. 101b - Receive FIFO/Buffer depth = 64 datawords. 110b - Receive FIFO/Buffer depth = 128 datawords. 111b - Receive FIFO/Buffer depth = 256 datawords.

53.3.1.13 LPUART Watermark Register (WATER)

53.3.1.13.1 Offset

Register	Offset
WATER	2Ch

53.3.1.13.2 Function

This register provides the ability to set a programmable threshold for notification of needing additional transmit data. This register may be read at any time but must be written only when CTRL[TE] is not set.

53.3.1.13.3 Diagram

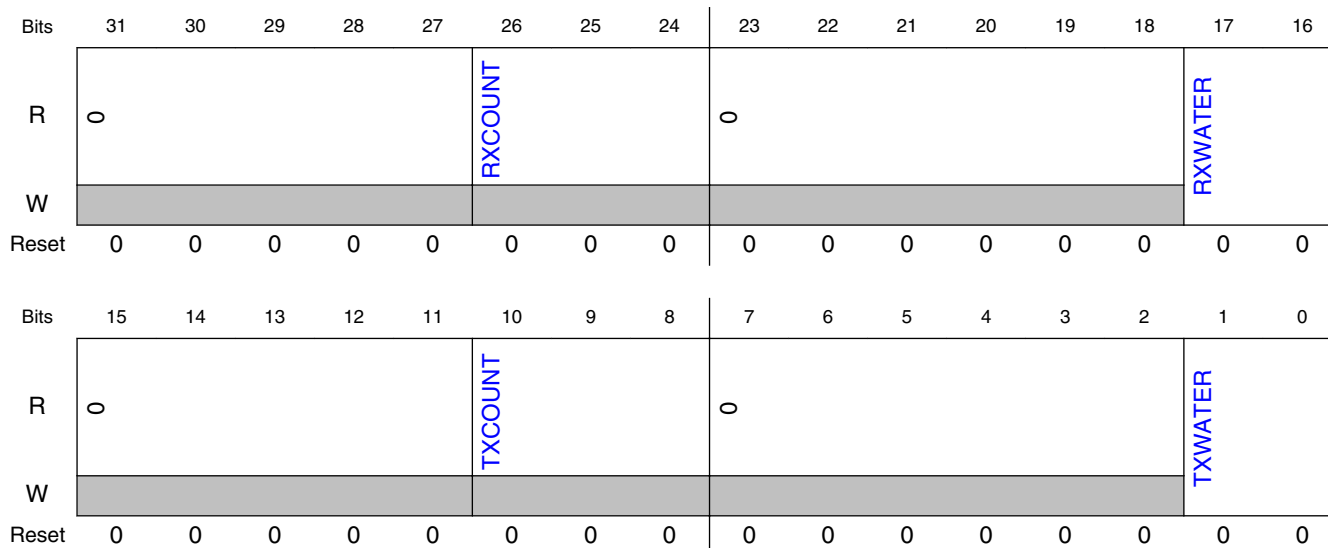

53.3.1.13.4 Fields

Field	Function
31-27 —	Reserved
26-24 RXCOUNT	Receive Counter The value in this register indicates the number of datawords that are in the receive FIFO/buffer. If a dataword is being received, that is, in the receive shift register, it is not included in the count. This value may be used in conjunction with FIFO[RXFIFOSIZE] to calculate how much room is left in the receive FIFO/buffer.
23-18 —	Reserved
17-16 RXWATER	Receive Watermark When the number of datawords in the receive FIFO/buffer is greater than the value in this register field, an interrupt or a DMA request is generated. For proper operation, the value in RXWATER must be set to be less than the receive FIFO/buffer size as indicated by FIFO[RXFIFOSIZE] and FIFO[RXFE].
15-11 —	Reserved
10-8 TXCOUNT	Transmit Counter The value in this register indicates the number of datawords that are in the transmit FIFO/buffer. If a dataword is being transmitted, that is, in the transmit shift register, it is not included in the count. This value may be used in conjunction with FIFO[TXFIFOSIZE] to calculate how much room is left in the transmit FIFO/buffer.
7-2 —	Reserved
1-0	Transmit Watermark

Field	Function
TXWATER	When the number of datawords in the transmit FIFO/buffer is equal to or less than the value in this register field, an interrupt or a DMA request is generated. For proper operation, the value in TXWATER must be set to be less than the size of the transmit buffer/FIFO size as indicated by FIFO[TXFIFOSIZE] and FIFO[TXFE].

53.4 Functional description

The LPUART supports full-duplex, asynchronous, NRZ serial communication and comprises a baud rate generator, transmitter, and receiver block. The transmitter and receiver operate independently, although they use the same baud rate generator. The following describes each of the blocks of the LPUART.

53.4.1 Clocking and Resets

Table 53-2. Clocks

LPUART Functional clock	The LPUART functional clock is asynchronous to the bus clock and can remain enabled in low power modes to support transmit and/or receive, including low power wakeups.
Bus clock	The bus clock is only used for bus accesses to the control and configuration registers. The bus clock frequency must be sufficient to support the data bandwidth requirements of the LPUART transmit and receive registers, including the FIFOs.

Table 53-3. Resets

Chip reset	The logic and registers for the LPUART transmitter and receiver are reset to their default state on a chip reset.
Software reset	Resets the LPUART logic and registers to their default state, except for the Global Register. The LPUART software reset is in the Global Register GLOBAL[RST].
FIFO reset	The LPUART implements write-only control bits that reset the transmit FIFO (FIFO[TXFLUSH]) and receive FIFO (FIFO[RXFLUSH]). After a FIFO is reset, that FIFO is empty.

53.4.2 Baud rate generation

A 13-bit modulus counter in the baud rate generator derives the baud rate for both the receiver and the transmitter. The value from 1 to 8191 written to BAUD[SBR] determines the baud clock divisor for the asynchronous LPUART baud clock. The baud rate clock drives the receiver, while the transmitter is driven by a bit clock which is generated from baud rate clock divided by the over sampling ratio. Depending on the over sampling ratio, the receiver has an acquisition rate of 4 to 32 samples per bit time.

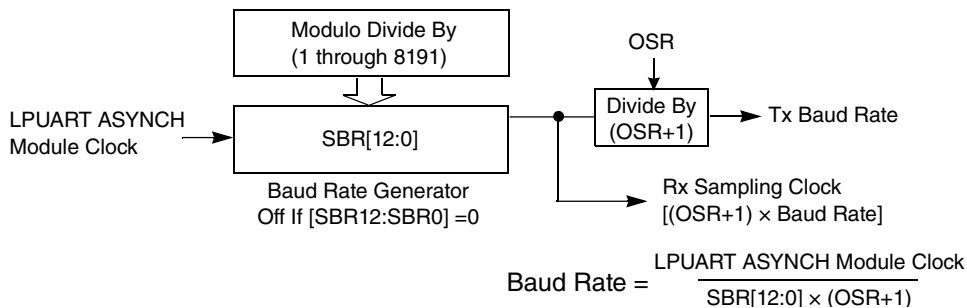

Figure 53-3. LPUART baud rate generation

Baud rate generation is subject to two sources of error:

- Integer division of the asynchronous LPUART baud clock may not give the exact target frequency.
- Synchronization with the asynchronous LPUART baud clock can cause phase shift.

The baud rate generation is a free-running counter that continues whenever the transmitter or receiver is enabled. The transmitter bit clock continues whenever the transmitter is enabled, each transmitted character aligns to the next edge of the transmit bit clock.

53.4.3 Transmitter functional description

This section describes the overall block diagram for the LPUART transmitter, as well as specialized functions for sending break and idle characters.

The transmitter output (TXD) idle state defaults to logic high, CTRL[TXINV] is cleared following reset. The transmitter output is inverted by setting CTRL[TXINV]. The transmitter is enabled by setting the CTRL[TE] bit. This queues a preamble character that is one full character frame of the idle state. The transmitter then remains idle until data is available in the transmit data buffer. Programs store data into the transmit data buffer by writing to the DATA register.

The central element of the LPUART transmitter is the transmit shift register that is 9-bit to 13 bits long depending on the setting in the CTRL[M], CTRL[M7], BAUD[M10] and BAUD[SBNS] control bits. For the remainder of this section, assume CTRL[M], CTRL[M7], BAUD[M10] and BAUD[SBNS] are cleared, selecting the normal 8-bit data mode. In 8-bit data mode, the shift register holds a start bit, eight data bits, and a stop bit. When the transmit shift register is available for a new character, the value waiting in the

transmit data register is transferred to the shift register, synchronized with the baud rate clock, and the transmit data register empty (STAT[TDRE]) status flag is set to indicate another character may be written to the transmit data buffer at the DATA register.

If no new character is waiting in the transmit data buffer after a stop bit is shifted out the TXD pin, the transmitter sets the transmit complete flag and enters an idle mode, with TXD high, waiting for more characters to transmit.

Writing 0 to CTRL[TE] does not immediately disable the transmitter. The current transmit activity in progress must first be completed (that could include a data character, idle character or break character), although the transmitter does not start transmitting another character.

53.4.3.1 Send break and queued idle

The CTRL[SBK] bit sends break characters originally used to gain the attention of old teletype receivers. Break characters are a full character time of logic 0, 9-bit to 12-bit times including the start and stop bits. A longer break of 13-bit times can be enabled by setting STAT[BRK13]. Normally, a program would wait for STAT[TDRE] to become set to indicate the last character of a message has moved to the transmit shifter, write 1, and then write 0 to the CTRL[SBK] bit. This action queues a break character to be sent as soon as the shifter is available. If CTRL[SBK] remains 1 when the queued break moves into the shifter, synchronized to the baud rate clock, an additional break character is queued. When the LPUART is the receiving device, a break character is received as 0s in all data bits and a framing error (STAT[FE] = 1) is detected.

A break character can also be transmitted by writing to the DATA register with bit 13 set and the data bits clear. This supports transmitting the break character as part of the normal data stream and also allows the DMA to transmit a break character.

When idle-line wakeup is used, a full character time of idle (logic 1) is needed between messages to wake up any sleeping receivers. Normally, a program would wait for STAT[TDRE] to become set to indicate the last character of a message has moved to the transmit shifter, then write 0 and then write 1 to the CTRL[TE] bit. This action queues an idle character to be sent as soon as the shifter is available. As long as the character in the shifter does not finish while CTRL[TE] is cleared, the LPUART transmitter never actually releases control of the TXD pin.

An idle character can also be transmitted by writing to the DATA register with bit 13 set and the data bits also set. This supports transmitting the idle character as part of the normal data stream and also allows the DMA to transmit a idle character.

The length of the break character is affected by the STAT[BRK13], CTRL[M], CTRL[M7], BAUD[M10] and BAUD[SNBS] bits as shown below.

Table 53-4. Break character length

BRK13	M	M10	M7	SNBS	Break character length
0	0	0	0	0	10 bit times
0	0	0	0	1	11 bit times
0	0	0	1	0	9 bit times
0	0	0	1	1	10 bit times
0	1	0	X	0	11 bit times
0	1	0	X	1	12 bit times
0	X	1	X	0	12 bit times
0	X	1	X	1	13 bit times
1	0	0	0	0	13 bit times
1	0	0	0	1	13 bit times
1	0	0	1	0	12 bit times
1	0	0	1	1	12 bit times
1	1	0	X	0	14 bit times
1	1	0	X	1	14 bit times
1	X	1	X	0	15 bit times
1	X	1	X	1	15 bit times

53.4.3.2 Hardware flow control

The transmitter supports hardware flow control by gating the transmission with the value of CTS_B. If the clear-to-send operation is enabled, the character is transmitted when CTS_B is asserted. If CTS_B is deasserted in the middle of a transmission with characters remaining in the transmitter data buffer, the character in the shift register is sent and TXD remains in the mark state until CTS_B is reasserted. The CTS_B pin must assert for longer than one bit period to guarantee a new transmission is started when the transmitter is idle with data to send.

If the clear-to-send operation is disabled, the transmitter ignores the state of CTS_B.

The transmitter's CTS_B signal can also be enabled even if the same LPUART receiver's RTS_B signal is disabled.

53.4.3.3 Transceiver driver enable

The transmitter can use RTS_B as an enable signal for the driver of an external transceiver. See [Transceiver driver enable using RTS_B](#) for details. If the request-to-send operation is enabled, when a character is placed into an empty transmitter data buffer, RTS_B asserts one bit time before the start bit is transmitted. RTS_B remains asserted for the whole time that the transmitter data buffer has any characters. RTS_B deasserts one bit time after all characters in the transmitter data buffer and shift register are completely sent, including the last stop bit. Transmitting a break character also asserts RTS_B, with the same assertion and deassertion timing as having a character in the transmitter data buffer.

The transmitter's RTS_B signal asserts only when the transmitter is enabled. However, the transmitter's RTS_B signal is unaffected by its CTS_B signal. RTS_B remains asserted until the transfer is completed, even if the transmitter is disabled mid-way through a data transfer.

53.4.3.4 Transceiver driver enable using RTS_B

RS-485 is a multiple drop communication protocol in which the LPUART transceiver's driver is 3-stated unless the LPUART is driving. The RTS_B signal can be used by the transmitter to enable the driver of a transceiver. The polarity of RTS_B can be matched to the polarity of the transceiver's driver enable signal.

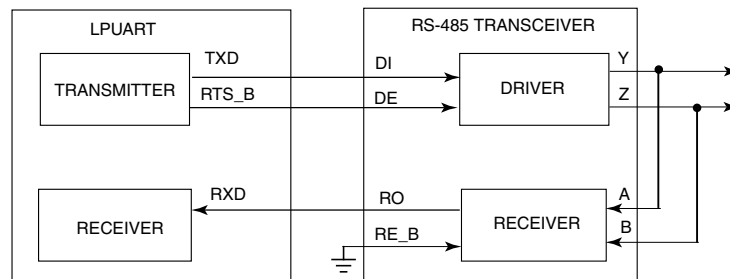

Figure 53-4. Transceiver driver enable using RTS_B

In the figure, the receiver enable signal is asserted. Another option for this connection is to connect RTS_B to both DE and RE_B. The transceiver's receiver is disabled while driving. A pullup can pull RXD to a non-floating value during this time. This option can be refined further by operating the LPUART in single wire mode, freeing the RXD pin for other uses.

53.4.4 Receiver functional description

In this section, the receiver block diagram is a guide for the overall receiver functional description. Next, the data sampling technique used to reconstruct receiver data is described in more detail. Finally, different variations of the receiver wakeup function are explained.

The receiver input is inverted by setting STAT[RXINV]. The receiver is enabled by setting the CTRL[RE] bit. Character frames consist of a start bit of logic 0, seven to ten data bits (msb or lsb first), and one or two stop bits of logic 1. For information about 7-bit, 9-bit or 10-bit data mode, refer to [Data Modes](#). For the remainder of this discussion, assume the LPUART is configured for normal 8-bit data mode.

After receiving the stop bit into the receive shifter, and provided the receive data register is not already full, the data character is transferred to the receive data register and the receive data register full (STAT[RDRF]) status flag is set. If [RDRF] was already set indicating the receive data register (buffer) was already full, the overrun (OR) status flag is set and the new data is lost. Because the LPUART receiver is double-buffered, the program has one full character time after [RDRF] is set before the data in the receive data buffer must be read to avoid a receiver overrun.

When a program detects that the receive data register is full (STAT[RDRF] = 1), it gets the data from the receive data register by reading the DATA register. Refer to [Interrupts and status flags](#) for details about flag clearing.

53.4.4.1 Data sampling technique

The LPUART receiver supports a configurable oversampling rate of between $4\times$ and $32\times$ of the baud rate clock for sampling. The receiver starts by taking logic level samples at the oversampling rate times the baud rate to search for a falling edge on the RXD serial data input pin. A falling edge is defined as a logic 0 sample after three consecutive logic 1 samples. The oversampling baud rate clock divides the bit time into 4 to 32 segments from 1 to OSR (where OSR is the configured oversampling ratio). When a falling edge is located, three more samples are taken at $(OSR/2)$, $(OSR/2)+1$, and $(OSR/2)+2$ to make sure this was a real start bit and not merely noise. If at least two of these three samples are 0, the receiver assumes it is synchronized to a received character. If another falling edge is detected before the receiver is considered synchronized, the receiver restarts the sampling from the first segment.

The receiver then samples each bit time, including the start and stop bits, at $(OSR/2)$, $(OSR/2)+1$, and $(OSR/2)+2$ to determine the logic level for that bit. The logic level is interpreted to be that of the majority of the samples taken during the bit time. If any

sample in any bit time, including the start and stop bits, in a character frame fails to agree with the logic level for that bit, the noise flag (STAT[NF]) is set when the received character is transferred to the receive data buffer.

When the LPUART receiver is configured to sample on both edges of the baud rate clock, the number of segments in each received bit is effectively doubled (from 1 to $OSR \times 2$). The start and data bits are then sampled at OSR , $OSR+1$ and $OSR+2$. Sampling on both edges of the clock must be enabled for oversampling rates of $4\times$ to $7\times$ and is optional for higher oversampling rates.

The "synchronization" is a feature of the LPUART module to synchronize the internal oversampling counter with detected falling edge on Rx signal, and to adjust the data sampling window. The falling edge detection needs three consecutive '1' prior to '1'-'>'0' transition. After the initial falling edge detection for the start bit, the circuit continuously monitors the next falling edge, and resets the counter once another falling edge is detected. This is called "resynchronization".

- When LPUART_BAUD[RESYNCDIS] = 0, this falling edge detection and resynchronization is performed not only for the start bit but also for the rest of character reception after the start bit.
- When LPUART_BAUD[RESYNCDIS] = 1, the falling edge detection and resynchronization is performed only for the start bit. The use case for disabling the resynchronization is protocols that require this (for example, LIN 2.1 prohibits resynchronization within a byte).

See the following table and figure.

Table 53-5. LPUART resynchronization

Resynchronization	LPUART_BAUD[RESYNCDIS]=0	LPUART_BAUD[RESYNCDIS]=1
For the starting bit falling edge	Yes	Yes
For every falling edges after the start bit	Yes	No

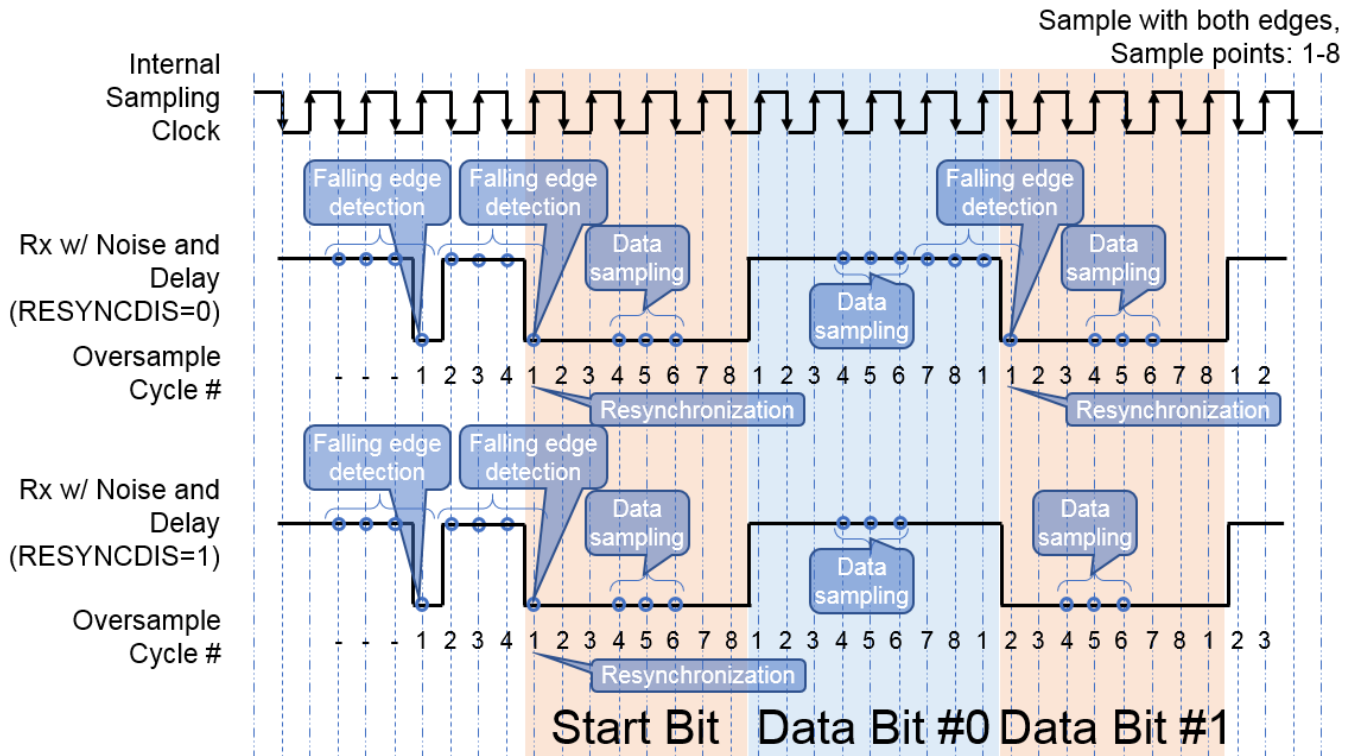

Figure 53-5. LPUART resynchronization

53.4.4.2 Receiver wakeup operation

Receiver wakeup and receiver address matching is a hardware mechanism that allows an LPUART receiver to ignore the characters in a message intended for a different receiver.

During receiver wakeup, all receivers evaluate the first character(s) of each message, and as soon as they determine the message is intended for a different receiver, they write logic 1 to the receiver wake up control bit (CTRL[RWU]). When CTRL[RWU] and STAT[RWUID] bit are set, the status flags associated with the receiver, with the exception of the idle bit, STAT[IDLE], are inhibited from setting, thus eliminating the software overhead for handling the unimportant message characters. At the end of a message, or at the beginning of the next message, all receivers automatically force CTRL[RWU] to 0 so all receivers wake up in time to look at the first character(s) of the next message.

During receiver address matching, the address matching is performed in hardware and the LPUART receiver ignores all characters that do not meet the address match requirements.

Table 53-6. Receiver Wakeup Options

RWU	MA1 MA2	MATCFG	WAKE:RWUID	Receiver Wakeup
0	0	X	X	Normal operation

Table continues on the next page...

Table 53-6. Receiver Wakeup Options (continued)

RWU	MA1 MA2	MATCFG	WAKE:RWUID	Receiver Wakeup
1	0	00	00	Receiver wakeup on idle line, IDLE flag not set
1	0	00	01	Receiver wakeup on idle line, IDLE flag set
1	0	00	10	Receiver wakeup on address mark
1	1	11	10	Receiver wakeup on data match
0	1	00	X0	Address mark address match, IDLE flag not set for discarded characters
0	1	00	X1	Address mark address match, IDLE flag set for discarded characters
0	1	01	X0	Idle line address match
0	1	10	X0	Address match on and address match off, IDLE flag not set for discarded characters
0	1	10	X1	Address match on and address match off, IDLE flag set for discarded characters

53.4.4.2.1 Idle-line wakeup

When wake is cleared, the receiver is configured for idle-line wakeup. In this mode, CTRL[RWU] is cleared automatically when the receiver detects a full character time of the idle-line level. The CTRL[M], CTRL[M7] and BAUD[M10] control bit selects 7-bit to 10-bit data mode and the BAUD[SBNS] bit selects 1-bit or 2-bit stop bit number that determines how many bit times of idle are needed to constitute a full character time, 9 to 13 bit times because of the start and stop bits.

When CTRL[RWU] is one and STAT[RWUID] is 0, the idle condition that wakes up the receiver does not set the STAT[IDLE] flag. The receiver wakes up and waits for the first data character of the next message that sets the STAT[RDRF] flag and generates an interrupt if enabled. When STAT[RWUID] is 1, any idle condition sets the STAT[IDLE] flag and generates an interrupt if enabled, regardless of whether CTRL[RWU] is 0 or 1.

The idle-line type (CTRL[ILT]) control bit selects one of two ways to detect an idle line. When CTRL[ILT] is cleared, the idle bit counter starts after the start bit so the stop bit and any logic 1s at the end of a character count toward the full character time of idle. When CTRL[ILT] is set, the idle bit counter does not start until after the stop bit time, so the idle detection is not affected by the data in the last character of the previous message.

53.4.4.2.2 Address-mark wakeup

When CTRL[WAKE] is set, the receiver is configured for address-mark wakeup. In this mode, CTRL[RWU] is cleared automatically when the receiver detects a logic 1 in the most significant bit of the received character. When parity is enabled, the second most significant bit is used for address-mark wakeup.

Address-mark wakeup allows messages to contain idle characters, but requires one bit be reserved for use in address frames. The logic 1 in the most significant bit (or second most significant bit when parity is enabled) of an address frame clears the CTRL[RWU] bit and sets the STAT[RDRF] flag. In this case, the character with the address-mark bit is received even though the receiver was sleeping during most of this character time.

53.4.4.2.3 Data match wakeup

When CTRL[RWU] is set, CTRL[WAKE] is set and BAUD[MATCFG] equals 11, the receiver is configured for data match wakeup. In this mode, CTRL[RWU] is cleared automatically when the receiver detects a character that matches MATCH[MA1] field when BAUD[MAEN1] is set, or that matches MATCH[MA2] when BAUD[MAEN2] is set.

53.4.4.2.4 Address Match operation

Address match operation is enabled when the BAUD[MAEN1] or BAUD[MAEN2] bit is set and BAUD[MATCFG] is equal to 00. In this function, a character received by the RXD pin with a logic 1 in the most significant bit (or second most significant bit when parity is enabled) is considered an address and is compared with the associated MATCH[MA1] or MATCH[MA2] field. The character is only transferred to the receive buffer, and STAT[RDRF] is set, if the comparison matches. All subsequent characters received with a logic 0 in the most significant bit (or second most significant bit when parity is enabled) are considered to be data associated with the address and are transferred to the receive data buffer. If no marked address match occurs then no transfer is made to the receive data buffer, and all following characters with logic zero in the most significant bit (or second most significant bit when parity is enabled) are also discarded. If both the BAUD[MAEN1] and BAUD[MAEN2] bits are negated, the receiver operates normally and all data received is transferred to the receive data buffer.

Address match operation functions in the same way for both MATCH[MA1] and MATCH[MA2] fields.

- If only one of BAUD[MAEN1] and BAUD[MAEN2] is asserted, a marked address is compared only with the associated match register field and data is transferred to the receive data buffer only on a match.
- If BAUD[MAEN1] and BAUD[MAEN2] are asserted, a marked address is compared with both match registers and data is transferred only on a match with either of the MATCH[MA1] or MATCH[MA2] fields.

53.4.4.2.5 Idle Match operation

Idle match operation is enabled when the BAUD[MAEN1] or BAUD[MAEN2] bit is set and BAUD[MATCFG] is equal to 01. In this function, the first character received by the RXD pin after an idle line condition is considered an address and is compared with the associated MATCH[MA1] or MATCH[MA2] field. The character is only transferred to the receive buffer, and STAT[RDRF] is set, if the comparison matches. All subsequent characters are considered to be data associated with the address and are transferred to the receive data buffer until the next idle line condition is detected. If no address match occurs then no transfer is made to the receive data buffer, and all following frames until the next idle condition are also discarded. If both the BAUD[MAEN1] and BAUD[MAEN2] bits are negated, the receiver operates normally and all data received is transferred to the receive data buffer.

Idle match operation functions in the same way for both MATCH[MA1] or MATCH[MA2] fields.

- If only one of BAUD[MAEN1] and BAUD[MAEN2] is asserted, the first character after an idle line is compared only with the associated match register and data is transferred to the receive data buffer only on a match.
- If BAUD[MAEN1] and BAUD[MAEN2] are asserted, the first character after an idle line is compared with both MATCH[MA1] or MATCH[MA2] fields and data is transferred only on a match with either of the fields.

53.4.4.2.6 Match On Match Off operation

Match on, match off operation is enabled when both BAUD[MAEN1] and BAUD[MAEN2] are set and BAUD[MATCFG] is equal to 10. In this function, a character received by the RXD pin that matches MATCH[MA1] is received and transferred to the receive buffer, and STAT[RDRF] is set. All subsequent characters are considered to be data and are also transferred to the receive data buffer, until a character

is received that matches MATCH[MA2] field. The character that matches MATCH[MA2] and all following characters are discarded; this continues until another character that matches MATCH[MA1] is received. If both the BAUD[MAEN1] and BAUD[MAEN2] bits are negated, the receiver operates normally and all data received is transferred to the receive data buffer.

NOTE

Match on, match off operation requires both BAUD[MAEN1] and BAUD[MAEN2] to be asserted.

53.4.4.3 Hardware flow control

To support hardware flow control, the receiver can be programmed to automatically deassert and assert RTS_B.

- RTS_B remains asserted until the transfer is complete, even if the transmitter is disabled midway through a data transfer. See [Transceiver driver enable using RTS_B](#) for more details.
- If the receiver request-to-send functionality is enabled, the receiver automatically deasserts RTS_B if the number of characters in the receiver data register is full or a start bit is detected that causes the receiver data register to be full.
- The receiver asserts RTS_B when the number of characters in the receiver data register is not full and has not detected a start bit that causes the receiver data register to be full. It is not affected if STAT[RDRF] is asserted.
- Even if RTS_B is deasserted, the receiver continues to receive characters until the receiver data buffer is overrun.
- If the receiver request-to-send functionality is disabled, the receiver RTS_B remains deasserted.

53.4.4.4 Infrared decoder

The infrared decoder converts the received character from the IrDA format to the NRZ format used by the receiver. It also has a OSR oversampling baud rate clock counter that filters noise and indicates when a 1 is received.

53.4.4.4.1 Start bit detection

When STAT[RXINV] is cleared, the first falling edge of the received character corresponds to the start bit. The infrared decoder resets its counter. At this time, the receiver also begins its start bit detection process. After the start bit is detected, the

receiver synchronizes its bit times to this start bit time. For the rest of the character reception, the infrared decoder's counter and the receiver's bit time counter count independently from each other.

53.4.4.4.2 Noise filtering

Any further rising edges detected during the first half of the infrared decoder counter are ignored by the decoder. Any pulses less than one oversampling baud clock can be undetected by it regardless of whether it is seen in the first or second half of the count.

53.4.4.4.3 Low-bit detection

During the second half of the decoder count, a rising edge is decoded as a 0, which is sent to the receiver. The decoder counter is also reset.

53.4.4.4.4 High-bit detection

At OSR oversampling baud rate clocks after the previous rising edge, if a rising edge is not seen, then the decoder sends a 1 to the receiver.

If the next bit is a 0, which arrives late, then a low-bit is detected according to [Low-bit detection](#). The value sent to the receiver is changed from 1 to a 0. Then, if a noise pulse occurs outside the receiver's bit time sampling period, then the delay of a 0 is not recorded as noise.

53.4.5 Additional LPUART functions

The following sections describe additional LPUART functions.

53.4.5.1 Data Modes

The LPUART transmitter and receiver can be configured to operate in 7-bit data mode by setting CTRL[M7], 9-bit data mode by setting the CTRL[M] or 10-bit data mode by setting BAUD[M10]. In 9-bit mode, there is a ninth data bit and in 10-bit mode, there is a tenth data bit. For the transmit data buffer, these bits are stored in CTRL[T8] and CTRL[T9]. For the receiver, these bits are held in CTRL[R8] and CTRL[R9]. They are also accessible via 16-bit or 32-bit accesses to the DATA register.

For coherent 8-bit writes to the transmit data buffer, write to CTRL[T8] and CTRL[T9] before writing to DATA[7:0]. For 16-bit and 32-bit writes to the DATA register, all 10 transmit bits are written to the transmit data buffer at the same time.

If the bit values to be transmitted as the ninth and tenth bit of a new character are the same as for the previous character, it is not necessary to write to CTRL[T8] and CTRL[T9] again. When data is transferred from the transmit data buffer to the transmit shifter, the value in CTRL[T8] and CTRL[T9] is copied at the same time data is transferred from DATA[7:0] to the shifter.

The 9-bit data mode is typically used with parity to allow eight bits of data plus the parity in the ninth bit, or it is used with address-mark wakeup so the ninth data bit can serve as the wakeup bit. The 10-bit data mode is typically used with parity and address-mark wakeup so the ninth data bit can serve as the wakeup bit and the tenth bit as the parity bit. In custom protocols, the ninth and/or tenth bits can also serve as software-controlled markers.

53.4.5.2 Idle length

An idle character is a character where the start bit, all data bits and stop bits are in the mark position. The CTRL[ILT] bit can be configured to start detecting an idle character from the previous start bit (any data bits and stop bits count towards the idle character detection) or from the previous stop bit.

The number of idle characters that must be received before an idle line condition is detected can also be configured using the CTRL[IDLECFG] field. This field configures the number of idle characters that must be received before the STAT[IDLE] flag is set, the STAT[RAF] flag is cleared and the DATA[IDLINE] flag is set with the next received character.

Idle-line wakeup and idle match operation are also affected by the CTRL[IDLECFG] field. When address match or match on/off operation is enabled, setting the STAT[RWUID] bit causes any discarded characters to be treated as if they were idle characters.

53.4.5.3 Loop mode

When CTRL[LOOPS] is set, the CTRL[RSRC] bit chooses between loop mode (CTRL[RSRC] = 0) or single-wire mode (CTRL[RSRC] = 1). Loop mode is sometimes used to check software, independent of connections in the external system, to help isolate system problems. In this mode, the transmitter output is internally connected to the receiver input and the RXD pin is not used by the LPUART.

53.4.5.4 Single-wire operation

When CTRL[LOOPS] is set, the CTRL[RSRC] bit chooses between loop mode (CTRL[RSRC] = 0) or single-wire mode (CTRL[RSRC] = 1). Single-wire mode implements a half-duplex serial connection. The receiver is internally connected to the transmitter output and to the TXD pin (the RXD pin is not used).

In single-wire mode, the CTRL[TXDIR] bit controls the direction of serial data on the TXD pin. When CTRL[TXDIR] is cleared, the TXD pin is an input to the receiver and the transmitter is temporarily disconnected from the TXD pin so an external device can send serial data to the receiver. When CTRL[TXDIR] is set, the TXD pin is an output driven by the transmitter, the internal loop back connection is disabled, and as a result the receiver cannot receive characters that are sent out by the transmitter.

53.4.6 Infrared interface

The LPUART provides the capability of transmitting narrow pulses to an IR LED and receiving narrow pulses and transforming them to serial bits, which are sent to the LPUART. The IrDA physical layer specification defines a half-duplex infrared communication link for exchanging data. The full standard includes data rates up to 16 Mbits/s. This module covers data rates only between 2.4 kbits/s and 115.2 kbits/s.

The LPUART has an infrared transmit encoder and receive decoder. The LPUART transmits serial bits of data that are encoded by the infrared submodule to transmit a narrow pulse for every zero bit. No pulse is transmitted for every one bit. When receiving data, the IR pulses are detected using an IR photo diode and transformed to CMOS levels by the IR receive decoder, external from the LPUART. The narrow pulses are then stretched by the infrared receive decoder to get back to a serial bit stream to be received by the LPUART. The polarity of transmitted pulses and expected receive pulses can be inverted so that a direct connection can be made to external IrDA transceiver modules that use active high pulses.

The infrared submodule receives its clock sources from the LPUART. One of these two clocks are selected in the infrared submodule to generate either 1/OSR, 2/OSR, 3/OSR, or 4/OSR narrow pulses during transmission.

53.4.6.1 Infrared transmit encoder

The infrared transmit encoder converts serial bits of data from transmit shift register to the TXD signal. A narrow pulse is transmitted for a 0 bit and no pulse for a 1 bit. The narrow pulse is sent at the start of the bit with a duration of $1/OSR$, $2/OSR$, $3/OSR$, or $4/OSR$ of a bit time. A narrow low pulse is transmitted for a 0 bit when CTRL[TXINV] is cleared, while a narrow high pulse is transmitted for a 0 bit when CTRL[TXINV] is set.

53.4.6.2 Infrared receive decoder

The infrared receive block converts data from the RXD signal to the receive shift register. A narrow pulse is expected for each 0 received and no pulse is expected for each 1 received. A narrow low pulse is expected for a 0 bit when STAT[RXINV] is cleared, while a narrow high pulse is expected for a 0 bit when STAT[RXINV] is set. This receive decoder meets the edge jitter requirement as defined by the IrDA serial infrared physical layer specification.

53.4.7 Interrupts and status flags

The LPUART transmitter has two status flags that can optionally generate hardware interrupt requests. Transmit data register empty (STAT[TDRE]) indicates when there is room in the transmit data buffer to write another transmit character to the DATA register. If the transmit interrupt enable (CTRL[TIE]) bit is set, a hardware interrupt is requested when STAT[TDRE] is set. Transmit complete (STAT[TC]) indicates that the transmitter is finished transmitting all data, preamble, and break characters and is idle with TXD at the inactive level. This flag is often used in systems with modems to determine when it is safe to turn off the modem. If the transmit complete interrupt enable (CTRL[TCIE]) bit is set, a hardware interrupt is requested when STAT[TC] is set. Instead of hardware interrupts, software polling may be used to monitor the STAT[TDRE] and STAT[TC] status flags if the corresponding CTRL[TIE] or CTRL[TCIE] local interrupt masks are cleared.

When a program detects that the receive data register is full (STAT[RDRF] = 1), it gets the data from the receive data register by reading the DATA register. The STAT[RDRF] flag is cleared by reading the DATA register.

The IDLE status flag includes logic that prevents it from getting set repeatedly when the RXD line remains idle for an extended period of time. IDLE is cleared by writing 1 to the STAT[IDLE] flag. After STAT[IDLE] has been cleared, it cannot become set again until the receiver has received at least one new character and has set STAT[RDRF].

If the associated error was detected in the received character that caused STAT[RDRF] to be set, the error flags - noise flag (STAT[NF]), framing error (STAT[FE]), and parity error flag (STAT[PF]) - are set at the same time as STAT[RDRF]. These flags are not set in overrun cases.

If STAT[RDRF] was already set when a new character is ready to be transferred from the receive shifter to the receive data buffer, the overrun (STAT[OR]) flag is set instead of the data along with any associated NF, FE, or PF condition is lost.

If the received character matches the contents of MATCH[MA1] and/or MATCH[MA2] then the STAT[MA1F] and/or STAT[MA2F] flags are set at the same time that STAT[RDRF] is set.

At any time, an active edge on the RXD serial data input pin causes the STAT[RXEDGIF] flag to set. The STAT[RXEDGIF] flag is cleared by writing a 1 to it. This function depends on the receiver being enabled (CTRL[RE] = 1).

53.4.8 Peripheral Triggers

The connection of the LPUART peripheral triggers with other peripherals are device specific.

53.4.8.1 Output Triggers

The LPUART generates the following output triggers that can be connected to other peripherals on the device.

- The transmit word trigger asserts at the end of each transmitted word, it negates after one bit period.
- The receive word trigger asserts at the end of each received word that is written to the receive FIFO, for one oversampling clock period.
- The receive idle trigger asserts at when the idle flag would set, for one oversampling clock period.

53.4.8.2 Input Trigger

The LPUART supports one peripheral input trigger, that can be configured in one of the following ways.

Functional description

- The input trigger can be connected in place of the CTS_B pin input. The input trigger must assert for longer than one bit clock period when the transmitter is idle with data to send to guarantee a new transmission.
- The input trigger can modulate the transmit data output (trigger is logically ANDed with the TXD output). The input trigger is expected to be generated from a PWM source with a period that is less than the bit clock frequency.
- The input trigger can be connected in place of the RXD pin input. The input trigger is expected to be generated from a receive data source, such as analog comparator or external pin.

Chapter 54

Flexible I/O (FlexIO)

54.1 Chip-specific FlexIO information

54.1.1 FlexIO Configuration

Table 54-1. FlexIO Configuration

	Timers	Shifters	Pins
Number	4	4	8

Low leakage and Wait mode is not supported in this device. See [Module operation in available power modes](#) for details on available power modes.

NOTE

Accessing FlexIO registers with FlexIO peripheral clock (FlexIO clock) disabled will result in transfer error or stall the bus.

54.2 Introduction

54.2.1 Overview

The FlexIO is a highly configurable module providing a wide range of functionality including:

- Emulation of a variety of serial communication protocols
- Flexible 16-bit timers with support for a variety of trigger, reset, enable and disable conditions

54.2.2 Features

The FlexIO module is capable of supporting a wide range of protocols including, but not limited to:

- UART
- I2C
- SPI
- I2S
- PWM/Waveform generation

The following key features are provided:

- Array of 32-bit shift registers with transmit, receive and data match modes
- Double buffered shifter operation for continuous data transfer
- Shifter concatenation to support large transfer sizes
- Automatic start/stop bit generation
- Interrupt, DMA or polled transmit/receive operation
- Programmable baud rates independent of bus clock frequency
- Highly flexible 16-bit timers with support for a variety of internal or external trigger, reset, enable and disable conditions

54.2.3 Block Diagram

The following diagram gives a high-level overview of the configuration of FlexIO timers and shifters.

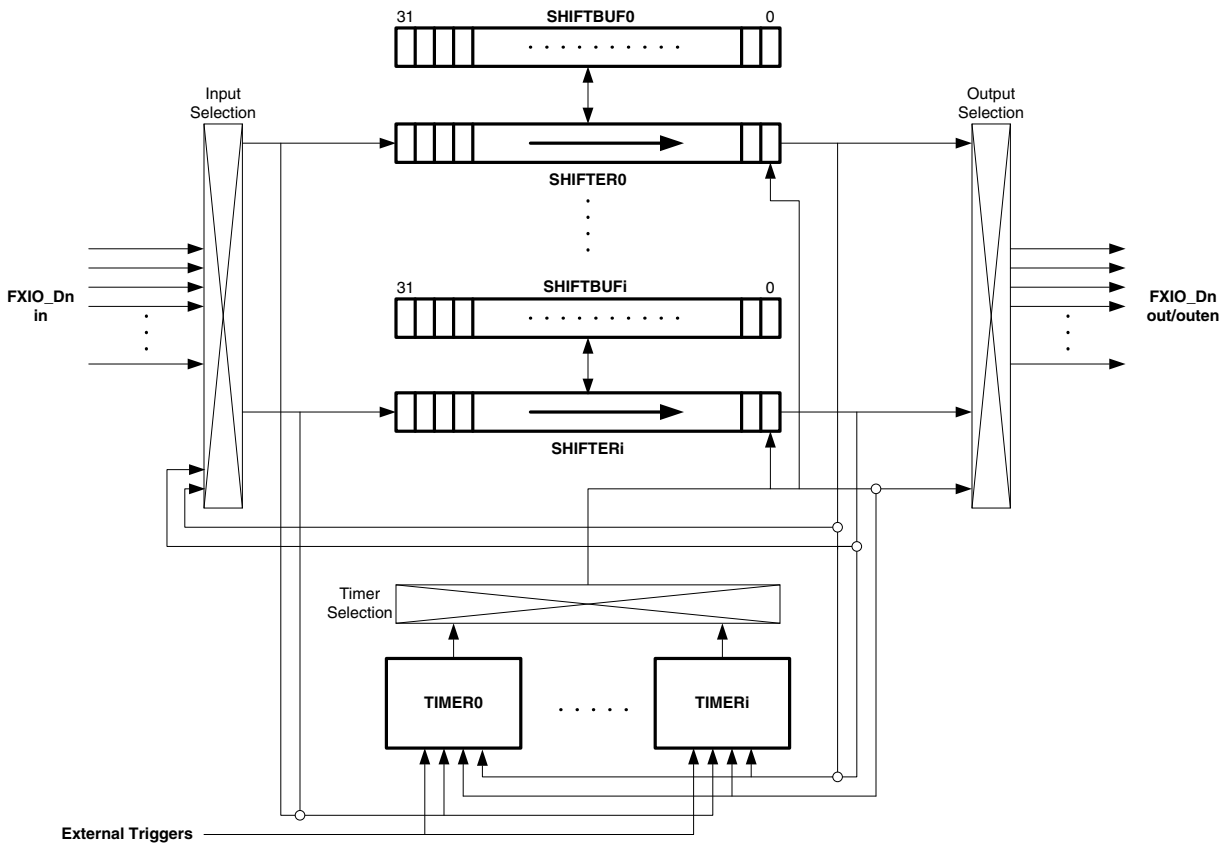

Figure 54-1. FlexIO block diagram

54.2.4 Modes of operation

The FlexIO module supports the chip modes described in the following table.

Table 54-2. Chip modes supported by the FlexIO module

Chip mode	FlexIO Operation
Run	Normal operation
Debug	Can continue operating provided the Debug Enable bit (CTRL[DBGE]) is set.

54.2.5 FlexIO Signal Descriptions

Signal	Description	I/O
FXIO_Dn (n=0...7)	Bidirectional FlexIO Shifter and Timer pin inputs/outputs	I/O

54.3 Memory Map and Registers

54.3.1 FLEXIO register descriptions

NOTE

An invalid register access will result in a bus error. This includes reading a write-only register, writing a read-only register or accessing an invalid address.

54.3.1.1 FLEXIO memory map

FlexIO base address: 4005_A000h

Offset	Register	Width (In bits)	Access	Reset value
0h	Version ID Register (VERID)	32	RO	0101_0000h
4h	Parameter Register (PARAM)	32	RO	0408_0404h
8h	FlexIO Control Register (CTRL)	32	RW	0000_0000h
Ch	Pin State Register (PIN)	32	RO	0000_0000h
10h	Shifter Status Register (SHIFTSTAT)	32	W1C	0000_0000h
14h	Shifter Error Register (SHIFTEERR)	32	W1C	0000_0000h
18h	Timer Status Register (TIMSTAT)	32	W1C	0000_0000h
20h	Shifter Status Interrupt Enable (SHIFTSIEN)	32	RW	0000_0000h
24h	Shifter Error Interrupt Enable (SHIFTEIEN)	32	RW	0000_0000h
28h	Timer Interrupt Enable Register (TIMIEN)	32	RW	0000_0000h
30h	Shifter Status DMA Enable (SHIFTSDEN)	32	RW	0000_0000h
80h - 8Ch	Shifter Control N Register (SHIFTCTL0 - SHIFTCTL3)	32	RW	0000_0000h
100h - 10Ch	Shifter Configuration N Register (SHIFTCFG0 - SHIFTCFG3)	32	RW	0000_0000h
200h - 20Ch	Shifter Buffer N Register (SHIFTBUF0 - SHIFTBUF3)	32	RW	0000_0000h
280h - 28Ch	Shifter Buffer N Bit Swapped Register (SHIFTBUFBIS0 - SHIFTBUFBIS3)	32	RW	0000_0000h
300h - 30Ch	Shifter Buffer N Byte Swapped Register (SHIFTBUFBYS0 - SHIFBUFBYS3)	32	RW	0000_0000h
380h - 38Ch	Shifter Buffer N Bit Byte Swapped Register (SHIFTBUFBBS0 - SHIFBUFBBS3)	32	RW	0000_0000h
400h - 40Ch	Timer Control N Register (TIMCTL0 - TIMCTL3)	32	RW	0000_0000h
480h - 48Ch	Timer Configuration N Register (TIMCFG0 - TIMCFG3)	32	RW	0000_0000h
500h - 50Ch	Timer Compare N Register (TIMCMP0 - TIMCMP3)	32	RW	0000_0000h

54.3.1.2 Version ID Register (VERID)

54.3.1.2.1 Offset

Register	Offset
VERID	0h

54.3.1.2.2 Diagram

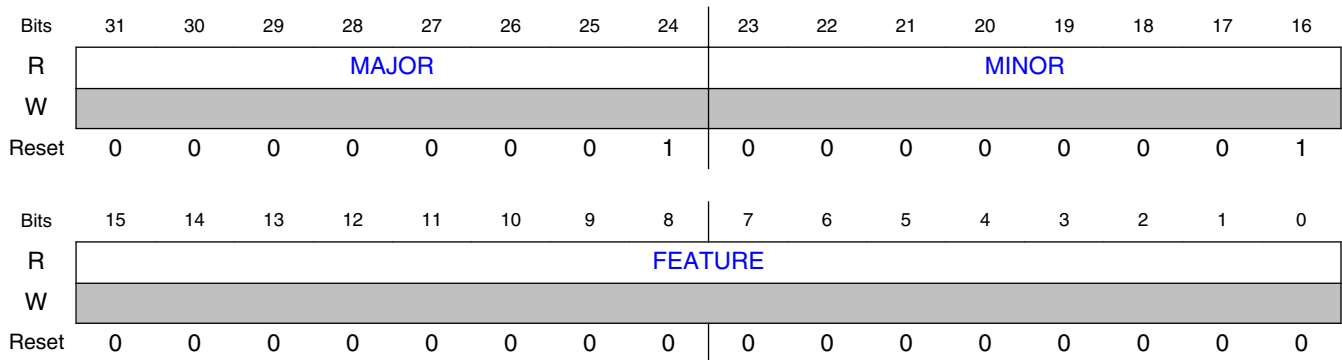

54.3.1.2.3 Fields

Field	Function
31-24 MAJOR	Major Version Number This read only field returns the major version number for the module specification.
23-16 MINOR	Minor Version Number This read only field returns the minor version number for the module specification.
15-0 FEATURE	Feature Specification Number This read only field returns the feature set number. 0000000000000000b - Standard features implemented. 0000000000000001b - Supports state, logic and parallel modes.

54.3.1.3 Parameter Register (PARAM)

54.3.1.3.1 Offset

Register	Offset
PARAM	4h

54.3.1.3.2 Diagram

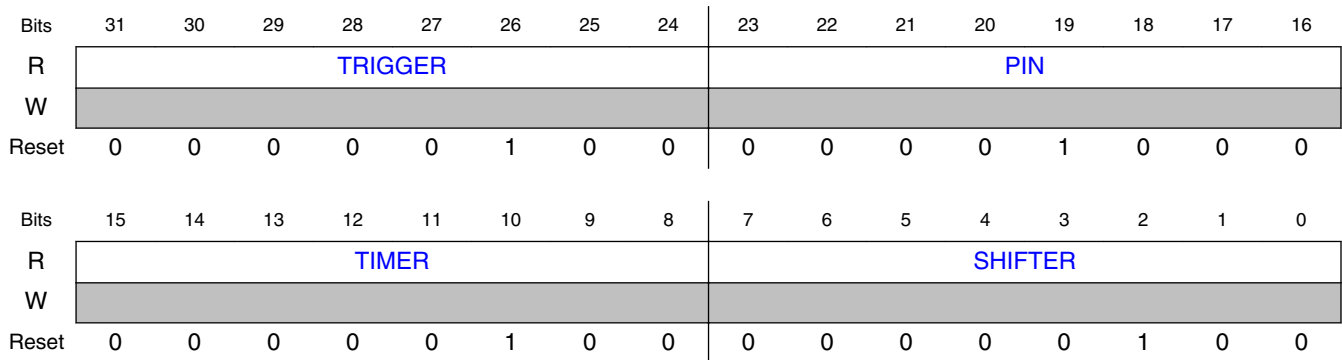

54.3.1.3.3 Fields

Field	Function
31-24 TRIGGER	Trigger Number Number of external triggers implemented.
23-16 PIN	Pin Number Number of Pins implemented.
15-8 TIMER	Timer Number Number of Timers implemented.
7-0 SHIFTER	Shifter Number Number of Shifters implemented.

54.3.1.4 FlexIO Control Register (CTRL)

54.3.1.4.1 Offset

Register	Offset
CTRL	8h

54.3.1.4.2 Diagram

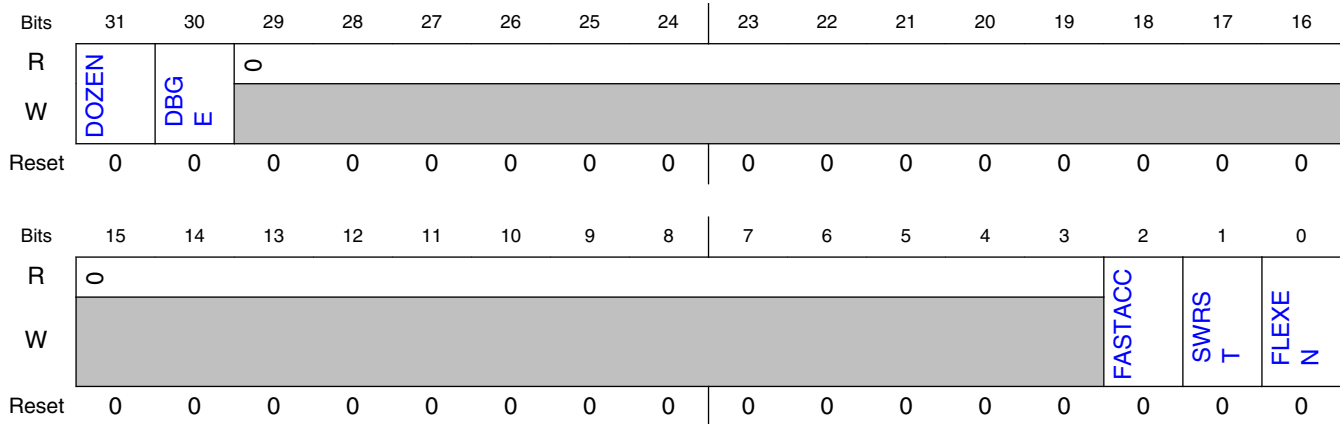

54.3.1.4.3 Fields

Field	Function
31 DOZEN	Doze Enable Disables FlexIO operation in Doze modes. 0b - FlexIO enabled in Doze modes. 1b - FlexIO disabled in Doze modes.
30 DBGE	Debug Enable Enables FlexIO operation in Debug mode. 0b - FlexIO is disabled in debug modes. 1b - FlexIO is enabled in debug modes
29-3 —	Reserved
2 FASTACC	Fast Access Enables fast register accesses to FlexIO registers, but requires the FlexIO functional clock to be at least twice the frequency of the bus clock. 0b - Configures for normal register accesses to FlexIO 1b - Configures for fast register accesses to FlexIO
1 SWRST	Software Reset The FlexIO Control Register is not affected by the software reset, all other logic in the FlexIO is affected by the software reset and register accesses are ignored until this bit is cleared. This register bit will remain set until cleared by software, and the reset has cleared in the FlexIO clock domain. 0b - Software reset is disabled 1b - Software reset is enabled, all FlexIO registers except the Control Register are reset.
0 FLEXEN	FlexIO Enable 0b - FlexIO module is disabled. 1b - FlexIO module is enabled.

54.3.1.5 Pin State Register (PIN)

54.3.1.5.1 Offset

Register	Offset
PIN	Ch

54.3.1.5.2 Diagram

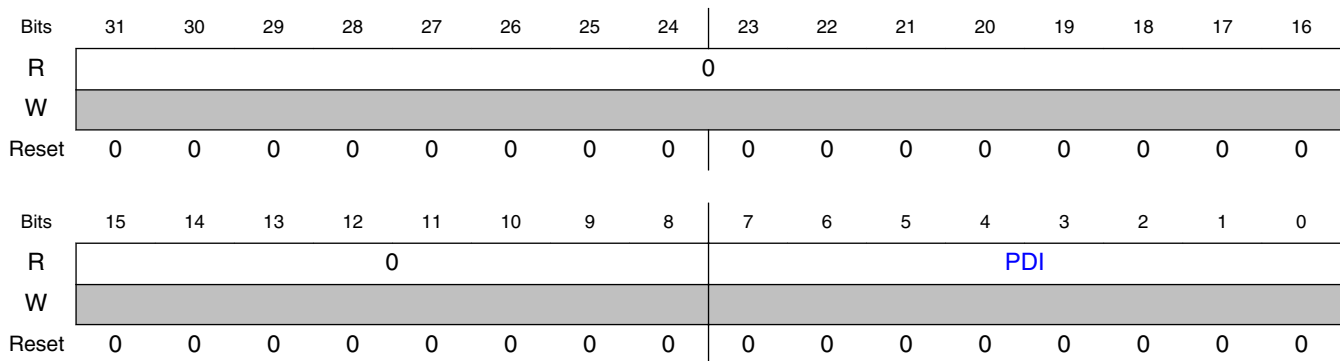

54.3.1.5.3 Fields

Field	Function
31-8 —	Reserved
7-0 PDI	Pin Data Input Returns the input data on each of the FlexIO pins.

54.3.1.6 Shifter Status Register (SHIFTSTAT)

54.3.1.6.1 Offset

Register	Offset
SHIFTSTAT	10h

54.3.1.6.2 Diagram

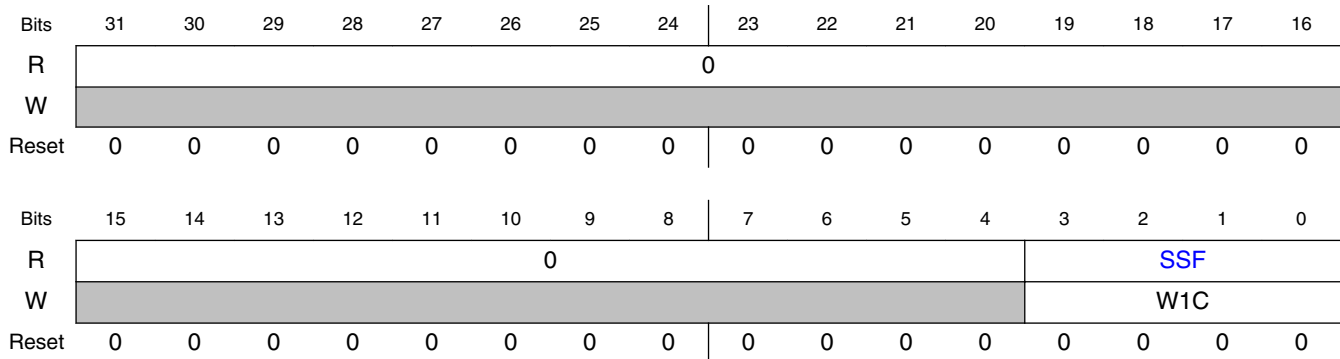

54.3.1.6.3 Fields

Field	Function
31-4 —	Reserved
3-0 SSF	<p>Shifter Status Flag</p> <p>The shifter status flag is updated when one of the following events occurs:</p> <p>For SMOD=Receive, the status flag is set when SHIFTBUF has been loaded with data from Shifter (SHIFTBUF is full), and the status flag is cleared when SHIFTBUF register is read.</p> <p>For SMOD=Transmit, the status flag is set when SHIFTBUF data has been transferred to the Shifter (SHIFTBUF is empty) or when initially configured for SMOD=Transmit, and the status flag is cleared when the SHIFTBUF register is written.</p> <p>For SMOD=Match Store, the status flag is set when a match has occurred between SHIFTBUF and Shifter, and the status flag is cleared when the SHIFTBUF register is read.</p> <p>For SMOD=Match Continuous, returns the current match result between the SHIFTBUF and Shifter.</p> <p>The status flag can also be cleared by writing a logic one to the flag for all modes except Match Continuous .</p> <p>0b - Status flag is clear. 1b - Status flag is set.</p>

54.3.1.7 Shifter Error Register (SHIFTErr)

54.3.1.7.1 Offset

Register	Offset
SHIFTErr	14h

54.3.1.7.2 Diagram

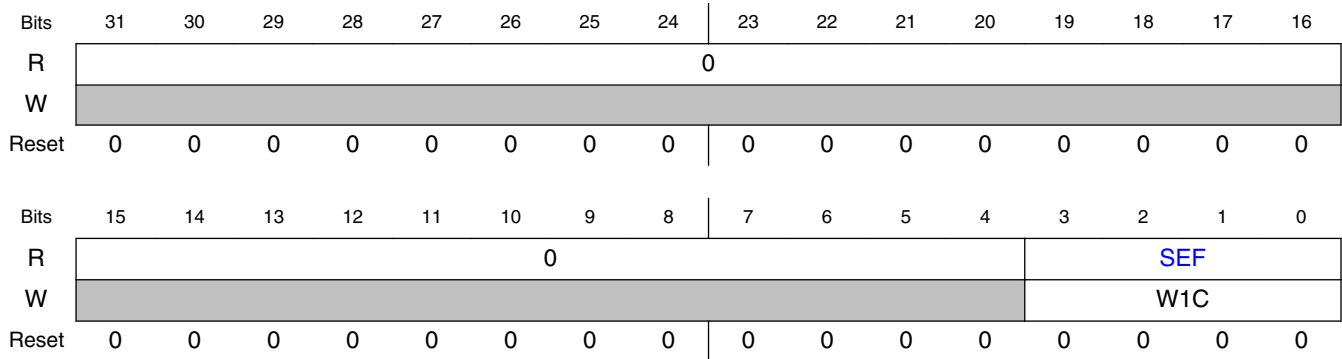

54.3.1.7.3 Fields

Field	Function
31-4 —	Reserved
3-0 SEF	<p>Shifter Error Flags</p> <p>The shifter error flag is set when one of the following events occurs:</p> <p>For SMOD=Receive, indicates Shifter was ready to store new data into SHIFTBUF before the previous data was read from SHIFTBUF (SHIFTBUF Overrun), or indicates that the received start or stop bit does not match the expected value.</p> <p>For SMOD=Transmit, indicates Shifter was ready to load new data from SHIFTBUF before new data had been written into SHIFTBUF (SHIFTBUF Underrun).</p> <p>For SMOD=Match Store, indicates a match event occurred before the previous match data was read from SHIFTBUF (SHIFTBUF Overrun).</p> <p>For SMOD=Match Continuous, the error flag is set when a match has occurred between SHIFTBUF and Shifter.</p> <p>Can be cleared by writing logic one to the flag. For SMOD=Match Continuous, can also be cleared when the SHIFTBUF register is read.</p> <p>0b - Shifter Error Flag is clear. 1b - Shifter Error Flag is set.</p>

54.3.1.8 Timer Status Register (TIMSTAT)

54.3.1.8.1 Offset

Register	Offset
TIMSTAT	18h

54.3.1.8.2 Diagram

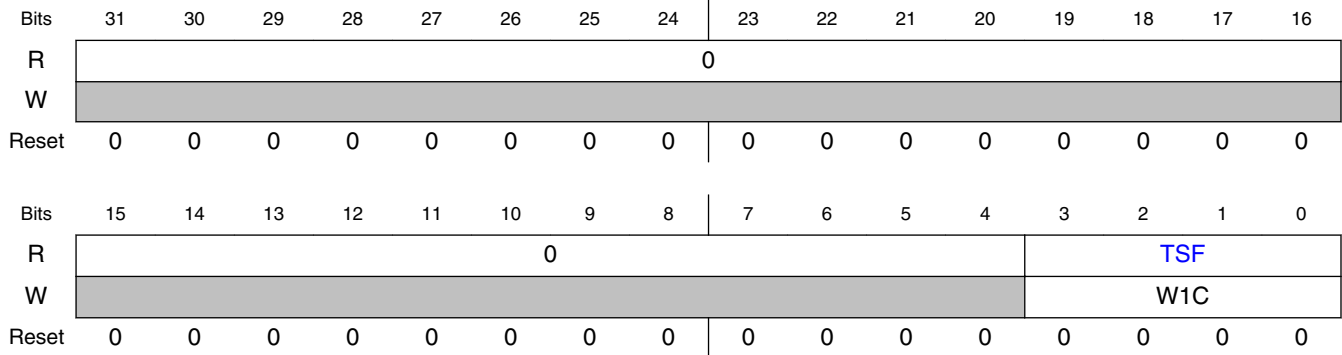

54.3.1.8.3 Fields

Field	Function
31-4 —	Reserved
3-0 TSF	<p>Timer Status Flags</p> <p>The timer status flag sets depending on the timer mode, and can be cleared by writing logic one to the flag.</p> <p>In 8-bit baud counter mode, the timer status flag is set when the upper 8-bit counter equals zero and decrements.</p> <p>In 8-bit high PWM mode, the timer status flag is set when the upper 8-bit counter equals zero and decrements.</p> <p>In 16-bit counter mode, the timer status flag is set when the 16-bit counter equals zero and decrements.</p> <p>0b - Timer Status Flag is clear. 1b - Timer Status Flag is set.</p>

54.3.1.9 Shifter Status Interrupt Enable (SHIFTSIEN)

54.3.1.9.1 Offset

Register	Offset
SHIFTSIEN	20h

54.3.1.9.2 Diagram

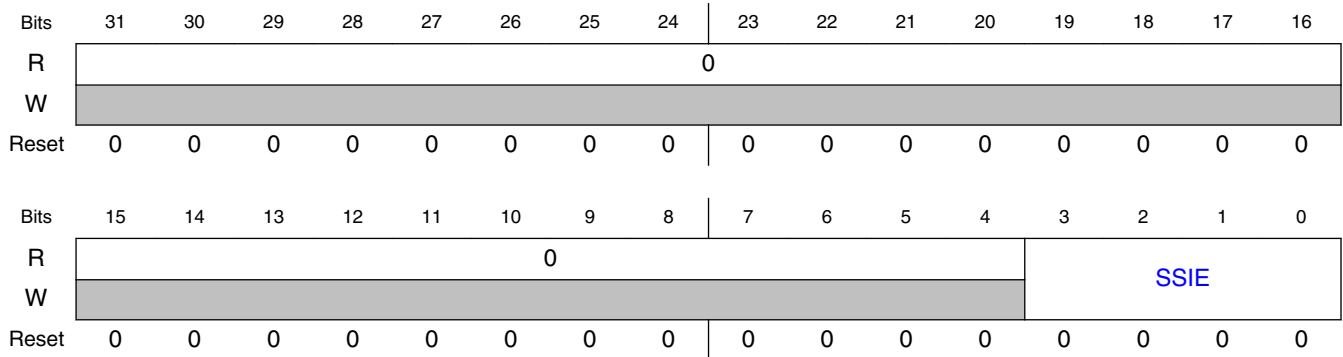

54.3.1.9.3 Fields

Field	Function
31-4 —	Reserved
3-0 SSIE	Shifter Status Interrupt Enable Enables interrupt generation when corresponding SSF is set. 0b - Shifter Status Flag interrupt disabled. 1b - Shifter Status Flag interrupt enabled.

54.3.1.10 Shifter Error Interrupt Enable (SHIFTEIEN)

54.3.1.10.1 Offset

Register	Offset
SHIFTEIEN	24h

54.3.1.10.2 Diagram

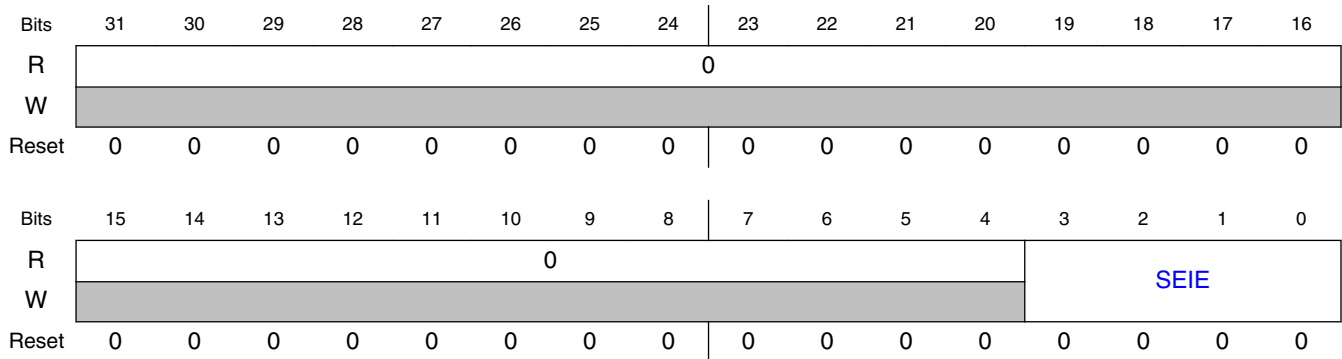

54.3.1.10.3 Fields

Field	Function
31-4 —	Reserved
3-0 SEIE	Shifter Error Interrupt Enable Enables interrupt generation when corresponding SEF is set. 0b - Shifter Error Flag interrupt disabled. 1b - Shifter Error Flag interrupt enabled.

54.3.1.11 Timer Interrupt Enable Register (TIMIEN)

54.3.1.11.1 Offset

Register	Offset
TIMIEN	28h

54.3.1.11.2 Diagram

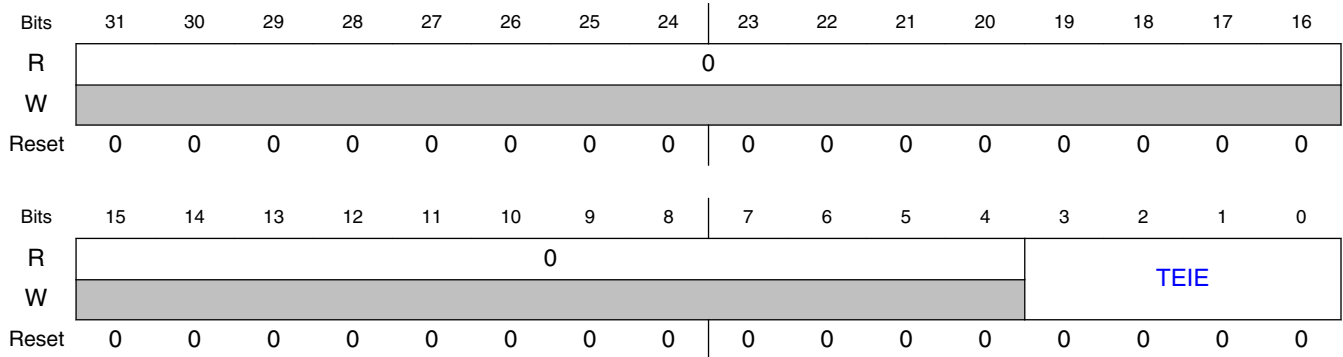

54.3.1.11.3 Fields

Field	Function
31-4 —	Reserved
3-0 TEIE	Timer Status Interrupt Enable Enables interrupt generation when corresponding TSF is set. 0b - Timer Status Flag interrupt is disabled. 1b - Timer Status Flag interrupt is enabled.

54.3.1.12 Shifter Status DMA Enable (SHIFTSDEN)

54.3.1.12.1 Offset

Register	Offset
SHIFTSDEN	30h

54.3.1.12.2 Diagram

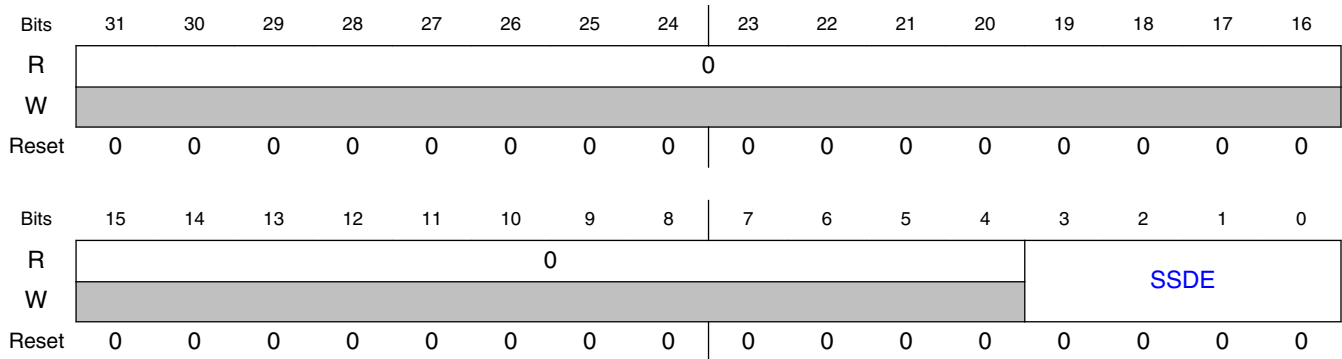

54.3.1.12.3 Fields

Field	Function
31-4 —	Reserved
3-0 SSDE	Shifter Status DMA Enable Enables DMA request generation when corresponding SSF is set. 0b - Shifter Status Flag DMA request is disabled. 1b - Shifter Status Flag DMA request is enabled.

54.3.1.13 Shifter Control N Register (SHIFTCTL0 - SHIFTCTL3)

54.3.1.13.1 Offset

Register	Offset
SHIFTCTL0	80h
SHIFTCTL1	84h
SHIFTCTL2	88h
SHIFTCTL3	8Ch

54.3.1.13.2 Diagram

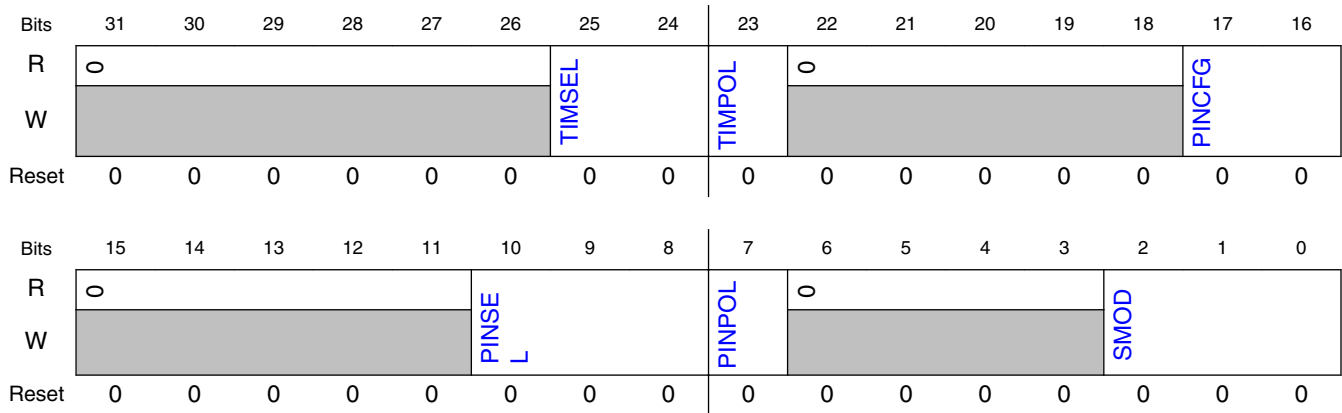

54.3.1.13.3 Fields

Field	Function
31-26 —	Reserved
25-24 TIMSEL	Timer Select Selects which Timer is used for controlling the logic/shift register and generating the Shift clock. TIMSEL=i will select TIMERi.
23 TIMPOL	Timer Polarity 0b - Shift on posedge of Shift clock 1b - Shift on negedge of Shift clock
22-18 —	Reserved
17-16 PINCFG	Shifter Pin Configuration For pins configured as an output (PINCFG=11), this field will take effect when the register is written. 00b - Shifter pin output disabled 01b - Shifter pin open drain or bidirectional output enable 10b - Shifter pin bidirectional output data 11b - Shifter pin output
15-11 —	Reserved
10-8 PINSEL	Shifter Pin Select Selects which pin is used by the Shifter input or output. PINSEL=i will select the FXIO_Di pin. For pins configured as an output (PINCFG=11), this field will take effect when the register is written.
7 PINPOL	Shifter Pin Polarity For pins configured as an output (PINCFG=11), this field will take effect when the register is written. 0b - Pin is active high 1b - Pin is active low
6-3 —	Reserved

Table continues on the next page...

Field	Function
2-0 SMOD	Shifter Mode Configures the mode of the Shifter. 000b - Disabled. 001b - Receive mode. Captures the current Shifter content into the SHIFTBUF on expiration of the Timer. 010b - Transmit mode. Load SHIFTBUF contents into the Shifter on expiration of the Timer. 011b - Reserved. 100b - Match Store mode. Shifter data is compared to SHIFTBUF content on expiration of the Timer. 101b - Match Continuous mode. Shifter data is continuously compared to SHIFTBUF contents. 110b - Reserved. 111b - Reserved.

54.3.1.14 Shifter Configuration N Register (SHIFTCFG0 - SHIFTCFG3)

54.3.1.14.1 Offset

Register	Offset
SHIFTCFG0	100h
SHIFTCFG1	104h
SHIFTCFG2	108h
SHIFTCFG3	10Ch

54.3.1.14.2 Diagram

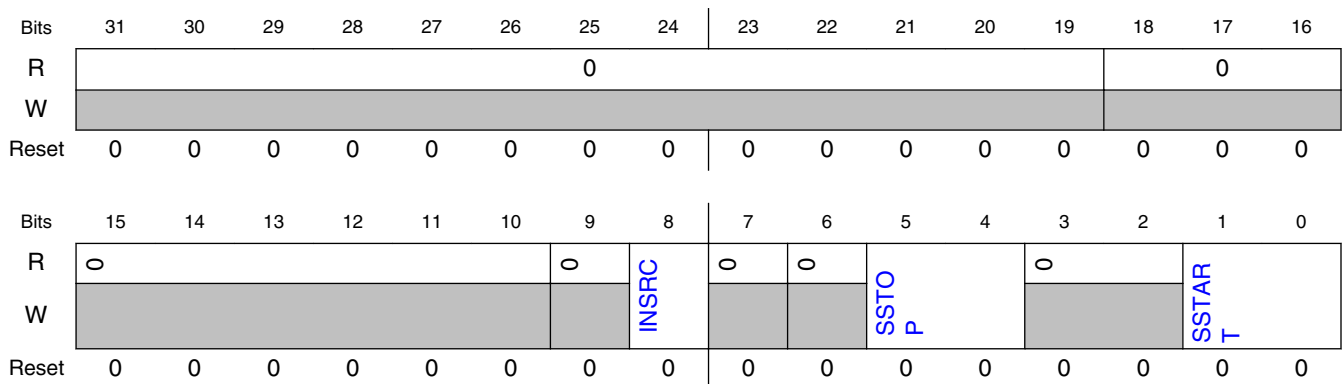

54.3.1.14.3 Fields

Field	Function
31-19 —	Reserved
18-16 —	Reserved
15-10 —	Reserved
9 —	Reserved
8 INSRC	Input Source Selects the input source for the shifter. Configuring INSRC=1 is not supported for the last shifter. 0b - Pin 1b - Shifter N+1 Output
7 —	Reserved
6 —	Reserved
5-4 SSTOP	Shifter Stop bit For SMOD=Transmit, this field allows automatic stop bit insertion if the selected timer has also enabled a stop bit. For SMOD=Receive or Match Store, this field allows automatic stop bit checking if the selected timer has also enabled a stop bit. 00b - Stop bit disabled for transmitter/receiver/match store 01b - Reserved for transmitter/receiver/match store 10b - Transmitter outputs stop bit value 0 on store, receiver/match store sets error flag if stop bit is not 0 11b - Transmitter outputs stop bit value 1 on store, receiver/match store sets error flag if stop bit is not 1
3-2 —	Reserved
1-0 SSTART	Shifter Start bit For SMOD=Transmit, this field allows automatic start bit insertion if the selected timer has also enabled a start bit. For SMOD=Receive or Match Store, this field allows automatic start bit checking if the selected timer has also enabled a start bit. 00b - Start bit disabled for transmitter/receiver/match store, transmitter loads data on enable 01b - Start bit disabled for transmitter/receiver/match store, transmitter loads data on first shift 10b - Transmitter outputs start bit value 0 before loading data on first shift, receiver/match store sets error flag if start bit is not 0 11b - Transmitter outputs start bit value 1 before loading data on first shift, receiver/match store sets error flag if start bit is not 1

54.3.1.15 Shifter Buffer N Register (SHIFTBUF0 - SHIFTBUF3)

54.3.1.15.1 Offset

Register	Offset
SHIFTBUF0	200h
SHIFTBUF1	204h
SHIFTBUF2	208h
SHIFTBUF3	20Ch

54.3.1.15.2 Diagram

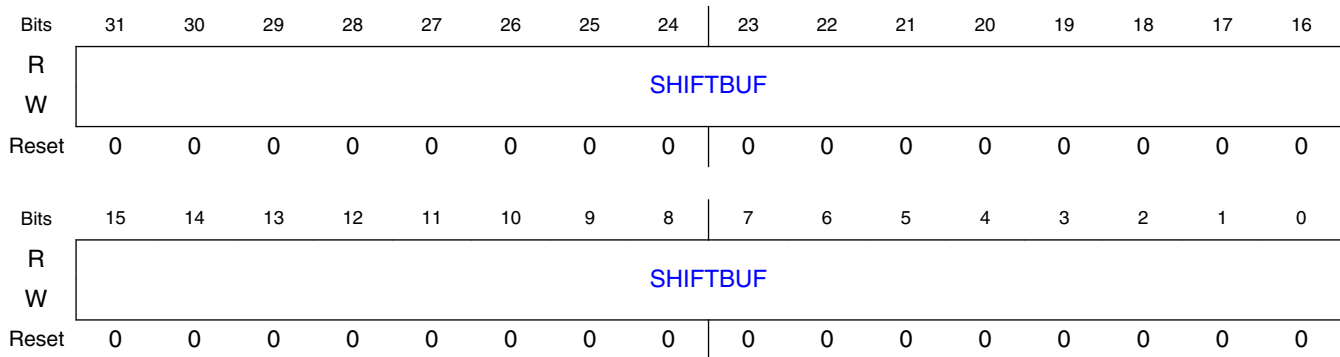

54.3.1.15.3 Fields

Field	Function
31-0 SHIFTBUF	<p>Shift Buffer</p> <p>Shift buffer data is used for a variety of functions depending on the SMOD setting:</p> <p>For SMOD=Receive, Shifter data is transferred into SHIFTBUF at the expiration of Timer. The SHIFTBUF register should only be read when the corresponding shifter status flag is set, indicating new Shifter data is available.</p> <p>For SMOD=Transmit, SHIFTBUF data is transferred into the Shifter before the Timer begins.</p> <p>For SMOD=Match Store, SHIFTBUF[31:16] contains the data to be matched with the Shifter contents and SHIFTBUF[15:0] can be used to mask the match result (1=mask, 0=no mask). The Match is checked when the Timer expires and Shifter data [31:16] is written to SHIFTBUF[31:16] whenever a match event occurs. The SHIFTBUF register should only be read when the corresponding shifter status flag is set, indicating new Shifter data is available.</p> <p>For SMOD=Match Continuous, SHIFTBUF[31:16] contains the data to be matched with the Shifter contents and SHIFTBUF[15:0] can be used to mask the match result (1=mask, 0=no mask).</p>

54.3.1.16 Shifter Buffer N Bit Swapped Register (SHIFTBUFBIS0 - SHIFTBUFBIS3)

54.3.1.16.1 Offset

Register	Offset
SHIFTBUFBIS0	280h
SHIFTBUFBIS1	284h
SHIFTBUFBIS2	288h
SHIFTBUFBIS3	28Ch

54.3.1.16.2 Diagram

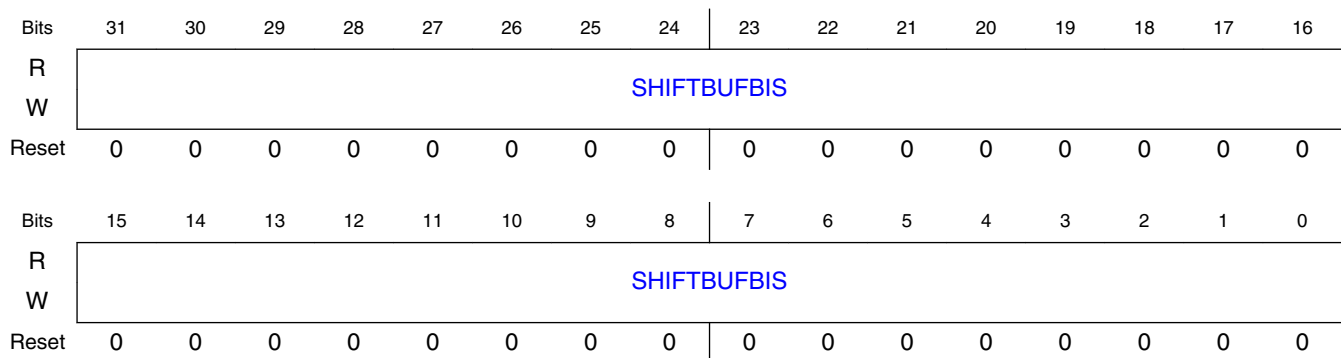

54.3.1.16.3 Fields

Field	Function
31-0	Shift Buffer
SHIFTBUFBIS	Alias to SHIFTBUF register, except reads/writes to this register are bit swapped. Reads return SHIFTBUF[0:31].

54.3.1.17 Shifter Buffer N Byte Swapped Register (SHIFTBUFBYS0 - SHIFTBUFBYS3)

54.3.1.17.1 Offset

Register	Offset
SHIFTBUFBYS0	300h
SHIFTBUFBYS1	304h
SHIFTBUFBYS2	308h
SHIFTBUFBYS3	30Ch

54.3.1.17.2 Diagram

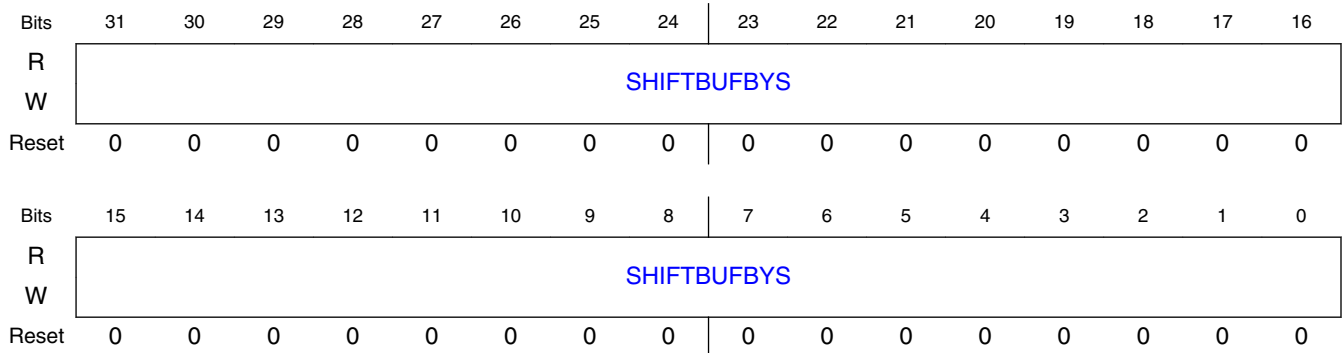

54.3.1.17.3 Fields

Field	Function
31-0	Shift Buffer
SHIFTBUFBYS	Alias to SHIFTBUF register, except reads/writes to this register are byte swapped. Reads return { SHIFTBUF[7:0], SHIFTBUF[15:8], SHIFTBUF[23:16], SHIFTBUF[31:24] }.

54.3.1.18 Shifter Buffer N Bit Byte Swapped Register (SHIFTBUF BBS0 - SHIFTBUFBBS3)

54.3.1.18.1 Offset

Register	Offset
SHIFTBUFBBS0	380h
SHIFTBUFBBS1	384h
SHIFTBUFBBS2	388h
SHIFTBUFBBS3	38Ch

54.3.1.18.2 Diagram

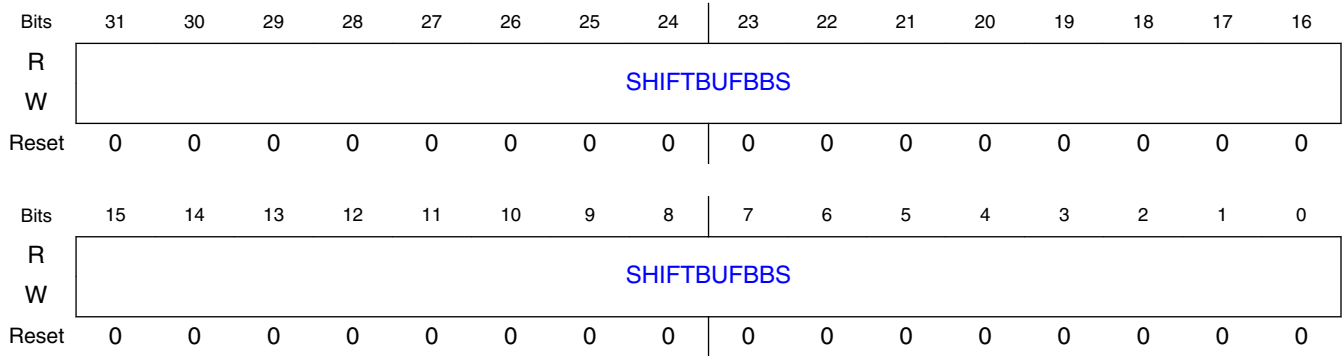

54.3.1.18.3 Fields

Field	Function
31-0	Shift Buffer
SHIFTBUFBBS	Alias to SHIFTBUF register, except reads/writes to this register are bit swapped within each byte. Reads return { SHIFTBUF[24:31], SHIFTBUF[16:23], SHIFTBUF[8:15], SHIFTBUF[0:7] }.

54.3.1.19 Timer Control N Register (TIMCTL0 - TIMCTL3)

54.3.1.19.1 Offset

Register	Offset
TIMCTL0	400h
TIMCTL1	404h
TIMCTL2	408h
TIMCTL3	40Ch

54.3.1.19.2 Diagram

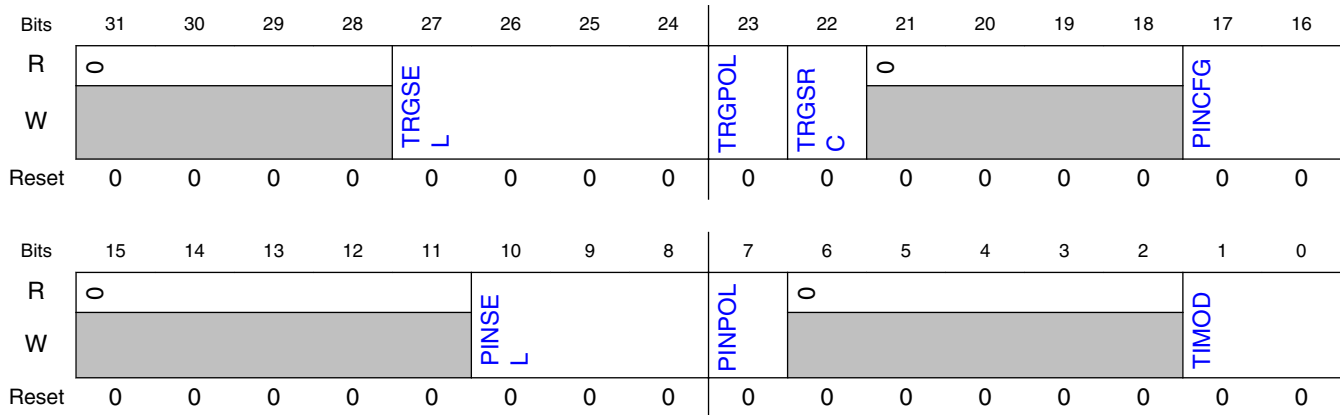

54.3.1.19.3 Fields

Field	Function
31-28 —	Reserved
27-24 TRGSEL	<p>Trigger Select</p> <p>The valid values for TRGSEL will depend on the FLEXIO_PARAM register.</p> <ul style="list-style-type: none"> When TRGSRC = 1, the valid values for N will depend on PIN, TIMER, SHIFTER fields in the FLEXIO_PARAM register. When TRGSRC = 0, the valid values for N will depend on TRIGGER field in FLEXIO_PARAM register. <p>Refer to the chip-specific FlexIO information for external trigger selection.</p> <p>NOTE: For a pin, N=0 to 7. For a Shifter, N=0 to 3. For a Timer, N=0 to 3.</p> <p>When TRGSRC = 0 the trigger selection is configured as follows:</p> <ul style="list-style-type: none"> N - External trigger N input <p>When TRGSRC = 1 the internal trigger can be configured to select an input pin as follows:</p> <ul style="list-style-type: none"> 2*N - Pin N input <p>When TRGSRC = 1 the internal trigger can be configured to select a shifter/timer signal as follows:</p> <ul style="list-style-type: none"> 4*N+1 - Shifter N status flag 4*N+3 - Timer N trigger output <p>In other words, the expanded internal trigger selection (TRGSRC = 1) is as follows:</p> <ul style="list-style-type: none"> 0000 = Pin 0 0001 = Shifter 0 Flag 0010 = Pin 1 0011 = Timer 0 Trigger 0100 = Pin 2 0101 = Shifter 1 Flag 0110 = Pin 3 0111 = Timer 1 Trigger ... This continues up to the Pin 7, Shifter 3 and Timer 3.
23	Trigger Polarity

Table continues on the next page...

Memory Map and Registers

Field	Function
TRGPOL	0b - Trigger active high 1b - Trigger active low
22 TRGSRC	Trigger Source 0b - External trigger selected 1b - Internal trigger selected
21-18 —	Reserved
17-16 PINCFG	Timer Pin Configuration Configures the direction of the Timer pin. For pins configured as an output (PINCFG=11), this field will take effect when the register is written. 00b - Timer pin output disabled 01b - Timer pin open drain or bidirectional output enable 10b - Timer pin bidirectional output data 11b - Timer pin output
15-11 —	Reserved
10-8 PINSEL	Timer Pin Select Selects which pin is used by the Timer input or output. PINSEL=i will select the FXIO_Di pin. For pins configured as an output (PINCFG=11), this field will take effect when the register is written.
7 PINPOL	Timer Pin Polarity For pins configured as an output (PINCFG=11), this field will take effect when the register is written. 0b - Pin is active high 1b - Pin is active low
6-2 —	Reserved
1-0 TIMOD	Timer Mode In 8-bit baud counter mode, the lower 8-bits of the counter and compare register are used to configure the baud rate of the timer shift clock, and the upper 8-bits are used to configure the shifter bit count. In 8-bit PWM high mode, the lower 8-bits of the counter and compare register are used to configure the high period of the timer shift clock, and the upper 8-bits are used to configure the low period of the timer shift clock. The shifter bit count is configured using another timer or external signal. In 16-bit counter mode, the full 16-bits of the counter and compare register are used to configure either the baud rate of the shift clock or the shifter bit count. 00b - Timer Disabled. 01b - Dual 8-bit counters baud mode. 10b - Dual 8-bit counters PWM high mode. 11b - Single 16-bit counter mode.

54.3.1.20 Timer Configuration N Register (TIMCFG0 - TIMCFG3)

54.3.1.20.1 Offset

Register	Offset
TIMCFG0	480h
TIMCFG1	484h
TIMCFG2	488h
TIMCFG3	48Ch

54.3.1.20.2 Function

The options to enable or disable the timer using the Timer N-1 enable or disable are reserved when N is evenly divisible by 4 (eg: Timer 0).

NOTE

The pin and trigger level/edges specified below refer to the signal state after being modified by the PINPOL or TRGPOL setting in the TIMCTL register. For example, "Trigger low" means a trigger is actually at logic level 1 if the TRGPOL is set to 1 (active low).

54.3.1.20.3 Diagram

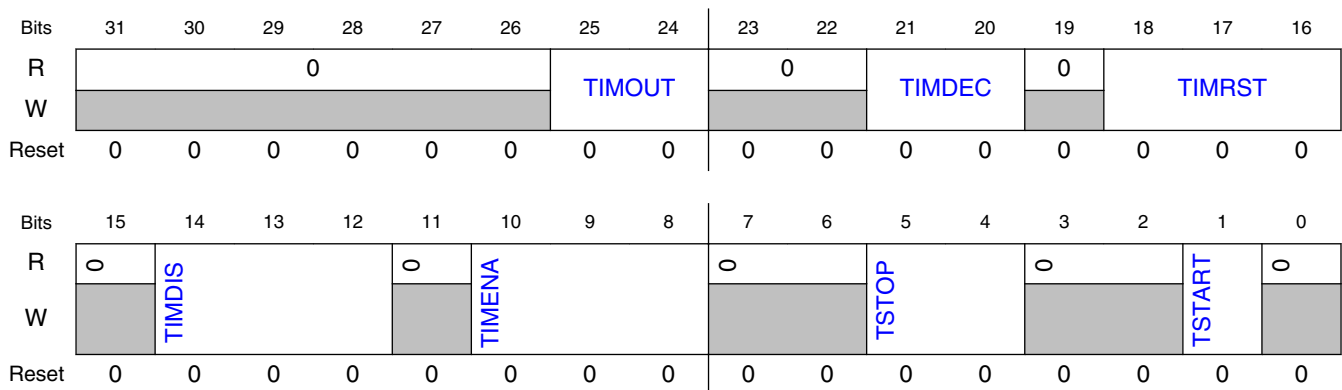

54.3.1.20.4 Fields

Field	Function
31-26	Reserved
—	
25-24	Timer Output
TIMOUT	Configures the initial state of the Timer Output and whether it is affected by the Timer reset.

Table continues on the next page...

Memory Map and Registers

Field	Function
	00b - Timer output is logic one when enabled and is not affected by timer reset 01b - Timer output is logic zero when enabled and is not affected by timer reset 10b - Timer output is logic one when enabled and on timer reset 11b - Timer output is logic zero when enabled and on timer reset
23-22 —	Reserved
21-20 TIMDEC	Timer Decrement Configures the source of the Timer decrement and the source of the Shift clock. 00b - Decrement counter on FlexIO clock, Shift clock equals Timer output. 01b - Decrement counter on Trigger input (both edges), Shift clock equals Timer output. 10b - Decrement counter on Pin input (both edges), Shift clock equals Pin input. 11b - Decrement counter on Trigger input (both edges), Shift clock equals Trigger input.
19 —	Reserved
18-16 TIMRST	Timer Reset Configures the condition that causes the timer counter (and optionally the timer output) to be reset. In 8-bit counter mode, the timer reset will only reset the lower 8-bits that configure the baud rate. In all other modes, the timer reset will reset the full 16-bits of the counter. 000b - Timer never reset 001b - Reserved 010b - Timer reset on Timer Pin equal to Timer Output 011b - Timer reset on Timer Trigger equal to Timer Output 100b - Timer reset on Timer Pin rising edge 101b - Reserved 110b - Timer reset on Trigger rising edge 111b - Timer reset on Trigger rising or falling edge
15 —	Reserved
14-12 TIMDIS	Timer Disable Configures the condition that causes the Timer to be disabled and stop decrementing. 000b - Timer never disabled 001b - Timer disabled on Timer N-1 disable 010b - Timer disabled on Timer compare (upper 8-bits match and decrement) 011b - Timer disabled on Timer compare (upper 8-bits match and decrement) and Trigger Low 100b - Timer disabled on Pin rising or falling edge 101b - Timer disabled on Pin rising or falling edge provided Trigger is high 110b - Timer disabled on Trigger falling edge 111b - Reserved
11 —	Reserved
10-8 TIMENA	Timer Enable Configures the condition that causes the Timer to be enabled and start decrementing. 000b - Timer always enabled 001b - Timer enabled on Timer N-1 enable 010b - Timer enabled on Trigger high 011b - Timer enabled on Trigger high and Pin high 100b - Timer enabled on Pin rising edge 101b - Timer enabled on Pin rising edge and Trigger high 110b - Timer enabled on Trigger rising edge 111b - Timer enabled on Trigger rising or falling edge

Table continues on the next page...

Field	Function
7-6 —	Reserved
5-4 TSTOP	<p>Timer Stop Bit</p> <p>The stop bit can be added on a timer compare (between each word) or on a timer disable. When stop bit is enabled, configured shifters will output the contents of the stop bit when the timer is disabled. When stop bit is enabled on timer disable, the timer remains disabled until the next rising edge of the shift clock. If configured for both timer compare and timer disable, only one stop bit is inserted on timer disable.</p> <p>00b - Stop bit disabled 01b - Stop bit is enabled on timer compare 10b - Stop bit is enabled on timer disable 11b - Stop bit is enabled on timer compare and timer disable</p>
3-2 —	Reserved
1 TSTART	<p>Timer Start Bit</p> <p>When start bit is enabled, configured shifters will output the contents of the start bit when the timer is enabled and the timer counter will reload from the compare register on the first rising edge of the shift clock.</p> <p>0b - Start bit disabled 1b - Start bit enabled</p>
0 —	Reserved

54.3.1.21 Timer Compare N Register (TIMCMP0 - TIMCMP3)

54.3.1.21.1 Offset

Register	Offset
TIMCMP0	500h
TIMCMP1	504h
TIMCMP2	508h
TIMCMP3	50Ch

Functional description

54.3.1.21.2 Diagram

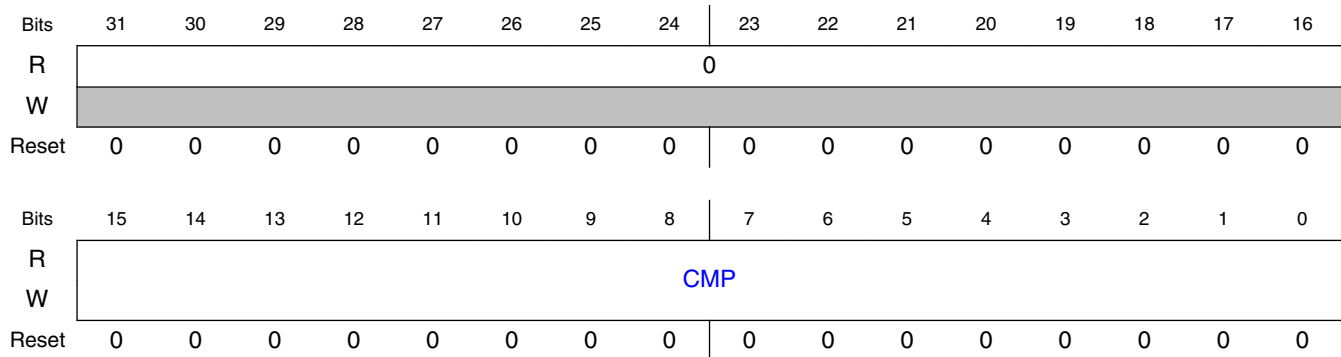

54.3.1.21.3 Fields

Field	Function
31-16 —	Reserved
15-0 CMP	<p>Timer Compare Value</p> <p>The timer compare value is loaded into the timer counter when the timer is first enabled, when the timer is reset and when the timer decrements down to zero.</p> <p>In 8-bit baud counter mode, the lower 8-bits configure the baud rate divider equal to $(CMP[7:0] + 1) * 2$. The upper 8-bits configure the number of bits in each word equal to $(CMP[15:8] + 1) / 2$.</p> <p>In 8-bit PWM high mode, the lower 8-bits configure the high period of the output to $(CMP[7:0] + 1)$ and the upper 8-bits configure the low period of the output to $(CMP[15:8] + 1)$.</p> <p>In 16-bit counter mode, the compare value can be used to generate the baud rate divider (if shift clock source is timer output) to equal $(CMP[15:0] + 1) * 2$. When the shift clock source is a pin or trigger input, the compare register is used to set the number of bits in each word equal to $(CMP[15:0] + 1) / 2$.</p>

54.4 Functional description

54.4.1 Clocking and Resets

54.4.1.1 Functional clock

The FlexIO functional clock is asynchronous to the bus clock and can remain enabled in low power modes. The FlexIO functional clock must be enabled before accessing any FlexIO registers. Provided the FlexIO functional clock is at least two times faster than the bus clock, the CTRL[FASTACC] bit can be set to support fast register accesses.

54.4.1.2 Bus clock

The bus clock is only used for bus accesses to the control and configuration registers.

54.4.1.3 Chip reset

The logic and registers for the FlexIO are reset to their default state on a chip reset.

54.4.1.4 Software reset

The FlexIO implements a software reset bit in its Control Register. The CTRL[RST] will reset all logic and registers to their default state, except for the CTRL itself.

54.4.2 Shifter operation

Shifters are responsible for buffering and shifting data into or out of the FlexIO. The timing of shift, load and store events are controlled by the Timer assigned to the Shifter via the SHIFTCTL[TIMSEL] register. The Shifters are designed to support either DMA, interrupt or polled operation. The following block diagram provides a detailed view of the Shifter microarchitecture.

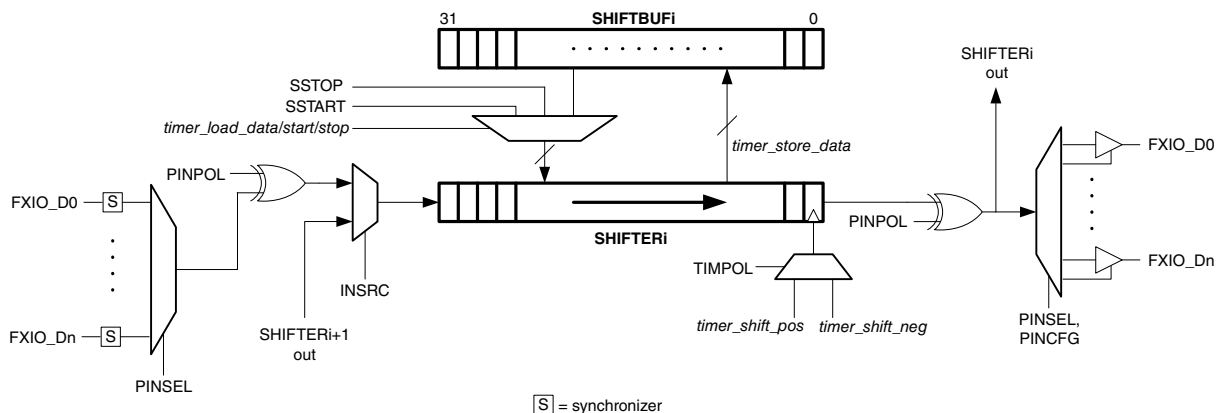

Figure 54-2. Shifter Microarchitecture

54.4.2.1 Transmit Mode

When configured for Transmit mode (SHIFTCTL[SMOD]=Transmit), the shifter will load data from the SHIFTBUF register and shift data out when a load event is signalled by the assigned Timer. An optional start/stop bit can also be automatically loaded before/after SHIFTBUF data by configuring the SHIFTCFG[SSTART], TIMCFG[TSTART] or SHIFTCFG[SSTOP], TIMCFG[TSTOP] registers in the Shifter and Timer. Note that the shifter will immediately load a stop bit when the Shifter is initially configured for Transmit mode if a stop bit is enabled.

The Shifter Status Flag (SHIFTSTAT[SSF]) and any enabled interrupts or DMA requests will set when data has been loaded from the SHIFTBUF register into the Shifter or when the Shifter is initially configured into Transmit mode. The flag will clear when new data has been written into the SHIFTBUF register.

The Shifter Error Flag (SHIFTErr[SEF]) and any enabled interrupts will set when an attempt to load data from an empty SHIFTBUF register occurs (buffer underrun). The flag can be cleared by writing it with logic 1.

54.4.2.2 Receive Mode

When configured for Receive mode (SHIFTCTL[SMOD]=Receive), the shifter will shift data in and store data into the SHIFTBUF register when a store event is signalled by the assigned Timer. Checking for a start/stop bit can be enabled before/after shifter data is sampled by configuring the SHIFTCFG[SSTART], TIMCFG[TSTART] or SHIFTCFG[SSTOP], TIMCFG[TSTOP] registers in the Shifter and Timer.

The Shifter Status Flag (SHIFTSTAT[SSF]) and any enabled interrupts or DMA requests will set when data has been stored into the SHIFTBUF register from the Shifter. The flag will clear when the data has been read from the SHIFTBUF register.

The Shifter Error Flag (SHIFTErr[SEF]) and any enabled interrupts will set when an attempt to store data into a full SHIFTBUF register occurs (buffer overrun) or when a mismatch occurs on a start/stop bit check. The flag can be cleared by writing it with logic 1.

54.4.2.3 Match Store Mode

When configured for Match Store mode (SHIFTCTL[SMOD]=Match Store), the shifter will shift data in, check for a match result and store matched data into the SHIFTBUF register when a store event is signalled by the assigned Timer. Checking for a start/stop

bit can be enabled before/after shifter data is sampled by configuring the SHIFTCFG[SSTART], TIMCFG[TSTART] or SHIFTCFG[SSTOP], TIMCFG[TSTOP] registers in the Shifter and Timer. Up to 16-bits of data can be compared using SHIFTBUF[31:16] to configure the data to be matched and SHIFTBUF[15:0] to mask the match result.

The Shifter Status Flag (SHIFTSTAT[SSF]) and any enabled interrupts or DMA requests will set when a match occurs and matched data has been stored into the SHIFTBUF register from the Shifter. The flag will clear when the matched data has been read from the SHIFTBUF register.

The Shifter Error Flag (SHIFTErr[SEF]) and any enabled interrupts will set when an attempt to store matched data into a full SHIFTBUF register occurs (buffer overrun) or when a mismatch occurs on a start/stop bit check. The flag can be cleared by writing it with logic 1.

54.4.2.4 Match Continuous Mode

When configured for Match Continuous mode (SHIFTCTL[SMOD]=Match Continuous), the shifter will shift data in and continuously check for a match result whenever a shift event is signalled by the assigned Timer. Up to 16-bits of data can be compared using SHIFTBUF[31:16] to configure the data to be matched and SHIFTBUF[15:0] to mask the match result.

The Shifter Status Flag (SHIFTSTAT[SSF]) and any enabled interrupts or DMA requests will set when a match occurs. The flag will clear automatically as soon as there is no longer a match between Shifter data and SHIFTBUF register.

The Shifter Error Flag (SHIFTErr[SEF]) and any enabled interrupts will set when a match occurs. The flag will clear when there is a read from the SHIFTBUF register or it written with logic 1.

54.4.3 Timer Operation

The FlexIO 16-bit timers control the loading, shifting and storing of the shift registers, the counters load the contents of the compare register and decrement down to zero on the FlexIO clock. They can perform generic timer functions such as generating a clock or select output or a PWM waveform. Timers can be configured to enable in response to a trigger, pin or shifter condition; decrement always or only on a trigger or pin edge; reset in response to a trigger or pin condition; and disable on a trigger or pin condition or on a timer compare. Timers can optionally include a start condition and/or stop condition.

Each timer operates independently, although a timer can be configured to enable or disable at the same time as the previous timer (eg: timer1 can enable or disable at the same time as timer 0) and a timer output can be used to trigger any other timer. The trigger used by each timer is configured independently and can be configured to be a timer output, shifter status flag, pin input or an external trigger input (refer to the chip-specific FlexIO information for details on the external trigger connections). The trigger configuration is separate from the pin configuration, which can be configured for input, output data or output enable.

The Timer Configuration Register (TIMCFGn) should be configured before setting the Timer Mode (TIMOD).

54.4.3.1 Timer 8-bit Baud Counter Mode

In 8-bit Baud Counter Mode, the 16-bit counter is divided into two 8-bit counters. The lower 8-bits are used to configure the baud rate of the shift clock and the upper 8-bits are used to configure the number of shift clock edges in the transfer. When the lower 8-bits decrement to zero, the timer output is toggled and the lower 8-bits reload from the compare register. The upper 8-bits decrement when the lower 8-bits equal zero and decrement.

Note that a timer reset event in 8-bit Baud Counter Mode will only reset the lower 8-bit counter, the upper 8-bit counter is not affected and can decrement if the timer reset is configured to update the state of the timer output, and the timer output toggles as a result of the timer reset event.

A timer compare event occurs when the upper 8-bits equal zero and decrements. The timer status flag is set on a timer compare event.

54.4.3.2 Timer 8-bit High PWM Mode

In 8-bit High PWM Mode, the 16-bit counter is divided into two 8-bit counters. The lower 8-bits are used to configure the timer output high period and the upper 8-bits are used to configure the timer output low period. The lower 8-bits decrement when the output is high. When the lower 8-bits equal zero and decrement, the timer output is cleared and the lower 8-bits are reloaded from the compare register. The upper 8-bits decrement when the output is low. When the upper 8-bits equal zero and decrement, the timer output is set and the upper 8-bits are reloaded from the compare register.

A timer compare event occurs when the upper 8-bits equal zero and decrements. The timer status flag is set on a timer compare event.

54.4.3.3 Timer 16-bit Counter Mode

In 16-bit Counter Mode, the 16-bit counter can be used to configure either the baud rate of the shift clock (eg: TIMDEC[1:0] != 10 or 11) or the number of shift clock edges in the transfer (eg: TIMDEC[1:0] = 10 or 11). When the 16-bit counter equals zero and decrements, the timer output toggles and the counter reloads from the compare register.

A timer compare event occurs when the 16-bit counter equals zero and decrements. The timer status flag is set on a timer compare event.

54.4.3.4 Timer Enable and Start Bit

When the TIMOD is configured for the desired mode, and the condition configured by timer enable (TIMENA) is detected then the following events occur.

- Timer counter will load the current value of the compare Register and start decrementing as configured by TIMDEC.
- Timer output may update to its initial state depending on the TIMOUT configuration. Shifters that are controlled by this timer do not see this as a rising edge on the timer shift clock.
- Transmit shifters controlled by this timer will either output their start bit value, or load the shift register from the shift buffer and output the first bit, as configured by SSTART.

If the Timer start bit is enabled, the timer counter will reload with the compare register on the first rising edge of the shift clock after the timer starts decrementing. If there is no falling edge on the shift clock before the first rising edge (for example, when TIMOUT=1), a shifter that is configured to shift on falling edge and load on the first shift will not load correctly.

54.4.3.5 Timer Decrement and Reset

The Timer will then generate the timer output and timer shift clock depending on the TIMOD and TIMDEC fields. The shifter clock is either equal to the timer output (when TIMDEC != 10 or 11) or equal to the decrement clock (when TIMDEC = 10 or 11). When TIMDEC is configured to decrement from a pin or trigger, the timer will decrement on both rising and falling edges.

When the Timer is configured to reset as configured in the TIMRST field then the Timer counter will load the current value of the compare register again. The timer output and timer shift clock can be configured to update on timer reset, as configured by TIMOUT. This can result in a timer shift clock edge if the timer output toggles as a result of the timer reset. In 8-bit Baud Counter mode this would also decrement the upper 8-bits of the counter.

In general, when the timer counter decrements to zero a timer compare event is triggered. The timer compare event will cause the timer counter to load the contents of the timer compare register, the timer output to toggle, any configured transmit shift registers to load, and any configured receive shift registers to store. Depending on the timer mode, the timer status flag may also be set.

54.4.3.6 Timer Disable and Stop Bit

When the is Timer is configured to add a stop bit on each compare, the following additional events will occur.

- Transmit shifters controlled by this timer will output their stop bit value (if configured by SSTOP).
- Receive shifters controlled by this timer will store the contents of the shift register in their shift buffer, as configured by SSTOP.
- On the first rising edge of the shifter clock after the compare, the timer counter will reload the current value of the Compare Register.

Transmit shifters must be configured to load on the first shift when the timer is configured to insert a stop bit on each compare.

When the condition configured by timer disable (TIMDIS) is detected, the following events occur.

- Timer counter will reload the current value of the Compare Register and start decrementing as configured by TIMDEC.
- Timer output will clear. Shifters that are controlled by this timer do not see this as a falling edge on the timer shift clock, but can generate a shift event if the timer shift clock would otherwise generate one.
- Transmit shifters controlled by this timer will output their stop bit value (if configured by SSTOP).
- Receive shifters controlled by this timer will store the contents of the shift register in their shift buffer, as configured by SSTOP.

If the timer stop bit is enabled, the timer counter will continue decrementing until the next rising edge of the shift clock is detected, at which point it will finish. Although the timer output is forced low during the stop bit, the timer shift clock can toggle during the stop bit, but does not generate shift events.

A timer enable condition can be detected in the same cycle as a timer disable condition (if timer stop bit is disabled), or on the first rising edge of the shift clock after the disable condition (if stop bit is enabled). Receive shift registers with stop bit enabled will store the contents of the shift register into the shift buffer and verify the state of the input data on the configured shift edge while the timer is in the stop state condition. If there is no configured edge between the timer disable and the next rising edge of the shift clock then the final store and verify do not occur.

54.4.4 Pin operation

The pin configuration for each timer and shifter can be configured to use any FlexIO pin with either polarity. Each timer and shifter can be configured as an input, output data, output enable or bidirectional output. A pin configured for output enable can be used as an open drain (with inverted polarity, since the output enable assertion would cause logic zero to be output on the pin) or to control the enable on the bidirectional output. Any timer or shifter could be configured to control the output enable for a pin where the bidirectional output data is driven by another timer or shifter.

54.4.4.1 Pin Synchronization

When configuring a pin as an input (this includes a timer trigger configured as a pin input), the input signal is first synchronized to the FlexIO clock before the signal is used by a timer or shifter. This introduces a small latency of between 0.5 to 1.5 FlexIO clock cycles when using an external pin input to generate an output or control a shifter. This sets the maximum setup time at 1.5 FlexIO clock cycles.

If an input is used by more than one timer or shifter then the synchronization occurs once to ensure any edge is seen on the same cycle by all timers and shifters using that input.

Note that FlexIO pins are also connected internally, configuring a FlexIO shifter or timer to output data on an unused pin will make an internal connection that allows other shifters and timer to use this pin as an input. This allows a shifter output to be used to trigger a timer or a timer output to be shifted into a shifter. This path is also synchronized to the FlexIO clock and therefore incurs a 1 cycle latency.

So when using a Pin input as a Timer Trigger, Timer Clock or Shifter Data Input, the following synchronization delays occur:

Functional description

1. 0.5 to 1.5 FlexIO clock cycles for external pin
2. 1 FlexIO clock cycle for an internally driven pin

For timing considerations such as output valid time and input setup time for specific applications (SPI Master, SPI Slave, I2C Master, I2S Master, I2S Slave) please refer to the FlexIO Application Information Section.

54.4.5 Interrupts and DMA Requests

The following table illustrates the status flags that can generate the FlexIO interrupt and DMA requests.

Table 54-3. FlexIO Interrupts and DMA Requests

Flag	Description	Interrupt	DMA Request	Low Power Wakeup
SSF	Shifter Status Flag.	Y	Y	Y
SEF	Shifter Error Flag.	Y	N	Y
TSF	Timer Status Flag.	Y	N	Y

54.4.6 Peripheral Triggers

The connection of the FlexIO peripheral triggers with other peripherals are device specific.

54.4.6.1 Output Triggers

Each FlexIO Timer generates an output trigger equal to the timer output. The output trigger is not affected by the timer pin polarity configuration.

54.4.6.2 Input Trigger

FlexIO supports multiple external trigger inputs that can be used to trigger one or more FlexIO timers. The external triggers are synchronized to the FlexIO functional clock and must assert for at least two cycles of the FlexIO functional clock to be sampled correctly.

54.5 Application Information

This section provides examples for a variety of FlexIO module applications.

54.5.1 UART Transmit

UART transmit can be supported using one Timer, one Shifter and one Pin (two Pins if supporting CTS). The start and stop bit insertion is handled automatically and multiple transfers can be supported using DMA controller. The timer status flag can be used to indicate when the stop bit of each word is transmitted.

Break and idle characters require software intervention, before transmitting a break or idle character the SSTART and SSTOP fields should be altered to transmit the required state and the data to transmit must equal 0xFF or 0x00. Supporting a second stop bit requires the stop bit to be inserted into the data stream using software (and increasing the number of bits to transmit). Note that when performing byte writes to SHIFTBUFn (or SHIFTBUFBIS for transmitting MSB first), the rest of the register remains unaltered allowing an address mark bit or additional stop bit to remain undisturbed.

FlexIO does not support automatic insertion of parity bits.

Table 54-4. UART Transmit Configuration

Register	Value	Comments
SHIFTCFGn	0x0000_0032	Configure start bit of 0 and stop bit of 1.
SHIFTCTLn	0x0003_0002	Configure transmit using Timer 0 on posedge of clock with output data on Pin 0. Can invert output data by setting PINPOL, or can support open drain by setting PINPOL=0x1 and PINCFG=0x1.
TIMCMPn	0x0000_0F01	Configure 8-bit transfer with baud rate of divide by 4 of the FlexIO clock. Set TIMCMP[15:8] = (number of bits x 2) - 1. Set TIMCMP[7:0] = (baud rate divider / 2) - 1.
TIMCFGn	0x0000_2222	Configure start bit, stop bit, enable on trigger asserted and disable on compare. Can support CTS by configuring TIMEN=0x3.
TIMCTLn	0x01C0_0001	Configure dual 8-bit counter using Shifter 0 status flag as inverted internal trigger source. Can support CTS by configuring PINSEL=0x1 (for Pin 1) and PINPOL=0x1.

Table continues on the next page...

Table 54-4. UART Transmit Configuration (continued)

Register	Value	Comments
SHIFTBUF _n	Data to transmit	Transmit data can be written to SHIFTBUF[7:0] to initiate an 8-bit transfer, use the Shifter Status Flag to indicate when data can be written using interrupt or DMA request. Can support MSB first transfer by writing to SHIFTBUFBS[7:0] register instead.

54.5.2 UART Receive

UART receive can be supported using one Timer, one Shifter and one Pin (two Timers and two Pins if supporting RTS). The start and stop bit verification is handled automatically and multiple transfers can be supported using the DMA controller. The timer status flag can be used to indicate when the stop bit of each word is received.

Triple voting of the received data is not supported by FlexIO, data is sampled only once in the middle of each bit. Another timer can be used to implement a glitch filter on the incoming data, another Timer can also be used to detect an idle line of programmable length. Break characters will cause the error flag to set and the shifter buffer register will return 0x00.

FlexIO does not support automatic verification of parity bits.

Table 54-5. UART Receiver Configuration

Register	Value	Comments
SHIFTCFG _n	0x0000_0032	Configure start bit of 0 and stop bit of 1.
SHIFCTL _n	0x0080_0001	Configure receive using Timer 0 on negege of clock with input data on Pin 0. Can invert input data by setting PINPOL.
TIMCMP _n	0x0000_0F01	Configure 8-bit transfer with baud rate of divide by 4 of the FlexIO clock. Set TIMCMP[15:8] = (number of bits x 2) - 1. Set TIMCMP[7:0] = (baud rate divider / 2) - 1.
TIMCFG _n	0x0204_2422	Configure start bit, stop bit, enable on pin posedge and disable on compare. Enable resynchronization to received data with TIMOUT=0x2 and TIMRST=0x4.
TIMCTL _n	0x0000_0081	Configure dual 8-bit counter using inverted Pin 0 input.

Table continues on the next page...

Table 54-5. UART Receiver Configuration (continued)

Register	Value	Comments
SHIFTBUF _n	Data to receive	Received data can be read from SHIFTBUFBYS[7:0], use the Shifter Status Flag to indicate when data can be read using interrupt or DMA request. Can support MSB first transfer by reading from SHIFTBUFBIS[7:0] register instead.

The UART Receiver with RTS configuration uses a 2nd Timer to generate the RTS output. The RTS will assert when the start bit is detected and negate when the data is read from the shifter buffer register. No start bit will be detected while the RTS is asserted, the received data is simply ignored.

Table 54-6. UART Receiver with RTS Configuration

Register	Value	Comments
SHIFTCFG _n	0x0000_0032	Configure start bit of 0 and stop bit of 1.
SHIFTCTL _n	0x0080_0001	Configure receive using Timer 0 on negege of clock with input data on Pin 0. Can invert input data by setting PINPOL.
TIMCMP _n	0x0000_0F01	Configure 8-bit transfer with baud rate of divide by 4 of the FlexIO clock. Set TIMCMP[15:8] = (number of bits x 2) - 1. Set TIMCMP[7:0] = (baud rate divider / 2) - 1.
TIMCFG _n	0x0204_2522	Configure start bit, stop bit, enable on pin posedge with trigger asserted and disable on compare. Enable resynchronization to received data with TIMOUT=0x2 and TIMRST=0x4.
TIMCTL _n	0x02C0_0081	Configure dual 8-bit counter using inverted Pin 0 input. Trigger is internal using inverted Pin 1 input.
TIMCMP _(n+1)	0x0000_FFFF	Never compare.
TIMCFG _(n+1)	0x0030_6100	Enable on Timer N enable and disable on trigger falling edge. Decrement on trigger to ensure no compare.
TIMCTL _(n+1)	0x0143_0003	Configure 16-bit counter and output on Pin 1. Trigger is internal using Shifter 0 flag.
SHIFTBUF _n	Data to receive	Received data can be read from SHIFTBUFBYS[7:0], use the Shifter Status Flag to indicate when data can be read using interrupt or DMA request. Can support MSB first transfer by reading from SHIFTBUFBIS[7:0] register instead.

54.5.3 SPI Master

SPI master mode can be supported using two Timers, two Shifters and four Pins. Either CPHA=0 or CPHA=1 can be supported and transfers can be supported using the DMA controller. For CPHA=1, the select can remain asserted for multiple transfers and the timer status flag can be used to indicate the end of the transfer.

The stop bit is used to guarantee a minimum of 1 clock cycle between the slave select negating and before the next transfer. Writing to the transmit buffer by either core or DMA is used to initiate each transfer.

Due to synchronization delays, the setup time for the serial input data is 1.5 FlexIO clock cycles, so the maximum baud rate is divide by 4 of the FlexIO clock frequency.

Table 54-7. SPI Master (CPHA=0) Configuration

Register	Value	Comments
SHIFTCFGn	0x0000_0000	Start and stop bit disabled.
SHIFTCTLn	0x0083_0002	Configure transmit using Timer 0 on negeedge of clock with output data on Pin 0.
SHIFTCFG(n+1)	0x0000_0000	Start and stop bit disabled.
SHIFTCTL(n+1)	0x0000_0101	Configure receive using Timer 0 on posedge of clock with input data on Pin 1.
TIMCMPn	0x0000_3F01	Configure 32-bit transfer with baud rate of divide by 4 of the FlexIO clock. Set TIMCMP[15:8] = (number of bits x 2) - 1. Set TIMCMP[7:0] = (baud rate divider / 2) - 1.
TIMCFGn	0x0100_2222	Configure start bit, stop bit, enable on trigger high and disable on compare, initial clock state is logic 0.
TIMCTLn	0x01C3_0201	Configure dual 8-bit counter using Pin 2 output (shift clock), with Shifter 0 flag as the inverted trigger. Set PINPOL to invert the output shift clock.
TIMCMP(n+1)	0x0000_FFFF	Never compare.
TIMCFG(n+1)	0x0000_1100	Enable when Timer 0 is enabled and disable when Timer 0 is disabled.
TIMCTL(n+1)	0x0003_0383	Configure 16-bit counter (never compare) using inverted Pin 3 output (as slave select).
SHIFTBUFn	Data to transmit	Transmit data can be written to SHIFTBUF, use the Shifter Status Flag to indicate when data can be written using interrupt or DMA request. Can

Table continues on the next page...

Table 54-7. SPI Master (CPHA=0) Configuration (continued)

Register	Value	Comments
		support MSB first transfer by writing to SHIFTBUFBBSS register instead.
SHIFTBUF(n+1)	Data to receive	Received data can be read from SHIFTBUFBYS, use the Shifter Status Flag to indicate when data can be read using interrupt or DMA request. Can support MSB first transfer by reading from SHIFTBUFBIS register instead.

Table 54-8. SPI Master (CPHA=1) Configuration

Register	Value	Comments
SHIFTCFGn	0x0000_0021	Start bit loads data on first shift.
SHIFTCTLn	0x0003_0002	Configure transmit using Timer 0 on posedge of clock with output data on Pin 0.
SHIFTCFG(n+1)	0x0000_0000	Start and stop bit disabled.
SHIFTCTL(n+1)	0x0080_0101	Configure receive using Timer 0 on negedge of clock with input data on Pin 1.
TIMCMPn	0x0000_3F01	Configure 32-bit transfer with baud rate of divide by 4 of the FlexIO clock. Set TIMCMP[15:8] = (number of bits x 2) - 1. Set TIMCMP[7:0] = (baud rate divider / 2) - 1.
TIMCFGn	0x0100_2222	Configure start bit, stop bit, enable on trigger high and disable on compare, initial clock state is logic 0.
TIMCTLn	0x01C3_0201	Configure dual 8-bit counter using Pin 2 output (shift clock), with Shifter 0 flag as the inverted trigger. Set PINPOL to invert the output shift clock. Set TIMDIS=3 to keep slave select asserted for as long as there is data in the transmit buffer.
TIMCMP(n+1)	0x0000_FFFF	Never compare.
TIMCFG(n+1)	0x0000_1100	Enable when Timer 0 is enabled and disable when Timer 0 is disabled.
TIMCTL(n+1)	0x0003_0383	Configure 16-bit counter (never compare) using inverted Pin 3 output (as slave select).
SHIFTBUFn	Data to transmit	Transmit data can be written to SHIFTBUF, use the Shifter Status Flag to indicate when data can be written using interrupt or DMA request. Can support MSB first transfer by writing to SHIFTBUFBBSS register instead.

Table continues on the next page...

Table 54-8. SPI Master (CPHA=1) Configuration (continued)

Register	Value	Comments
SHIFTBUF(n+1)	Data to receive	Received data can be read from SHIFTBUFBYS, use the Shifter Status Flag to indicate when data can be read using interrupt or DMA request. Can support MSB first transfer by reading from SHIFTBUFBIS register instead.

54.5.4 SPI Slave

SPI slave mode can be supported using one Timer, two Shifters and four Pins. Either CPHA=0 or CPHA=1 can be supported and transfers can be supported using the DMA controller. For CPHA=1, the select can remain asserted for multiple transfers and the timer status flag can be used to indicate the end of the transfer.

The transmit data must be written to the transmit buffer register before the external slave select asserts, otherwise the shifter error flag will be set.

Due to synchronization delays, the output valid time for the serial output data is 2.5 FlexIO clock cycles, so the maximum baud rate is divide by 6 of the FlexIO clock frequency.

Table 54-9. SPI Slave (CPHA=0) Configuration

Register	Value	Comments
SHIFTCFGn	0x0000_0000	Start and stop bit disabled.
SHIFTCTLn	0x0083_0002	Configure transmit using Timer 0 on falling edge of shift clock with output data on Pin 0.
SHIFTCFG(n+1)	0x0000_0000	Start and stop bit disabled.
SHIFTCTL(n+1)	0x0000_0101	Configure receive using Timer 0 on rising edge of shift clock with input data on Pin 1.
TIMCMPn	0x0000_003F	Configure 32-bit transfer. Set TIMCMP[15:0] = (number of bits x 2) - 1.
TIMCFGn	0x0120_0600	Configure enable on trigger rising edge, initial clock state is logic 0 and decrement on pin input.
TIMCTLn	0x06C0_0203	Configure 16-bit counter using Pin 2 input (shift clock), with Pin 3 input (slave select) as the inverted trigger.
SHIFTBUFn	Data to transmit	Transmit data can be written to SHIFTBUF, use the Shifter Status Flag to indicate when data can be written using interrupt or DMA request. Can

Table continues on the next page...

Table 54-9. SPI Slave (CPHA=0) Configuration (continued)

Register	Value	Comments
		support MSB first transfer by writing to SHIFTBUFBBBS register instead.
SHIFTBUF(n+1)	Data to receive	Received data can be read from SHIFTBUFBYS, use the Shifter Status Flag to indicate when data can be read using interrupt or DMA request. Can support MSB first transfer by reading from SHIFTBUFBIS register instead.

Table 54-10. SPI Slave (CPHA=1) Configuration

Register	Value	Comments
SHIFTCFGn	0x0000_0001	Shifter configured to load on first shift and stop bit disabled.
SHIFTCTLn	0x0003_0002	Configure transmit using Timer 0 on rising edge of shift clock with output data on Pin 0.
SHIFTCFG(n+1)	0x0000_0000	Start and stop bit disabled.
SHIFTCTL(n+1)	0x0080_0101	Configure receive using Timer 0 on falling edge of shift clock with input data on Pin 1.
TIMCMPn	0x0000_003F	Configure 32-bit transfer. Set $TIMCMP[15:0] = (\text{number of bits} \times 2) - 1$.
TIMCFGn	0x0120_6602	Configure start bit, enable on trigger rising edge, disable on trigger falling edge, initial clock state is logic 0 and decrement on pin input.
TIMCTLn	0x06C0_0203	Configure 16-bit counter using Pin 2 input (shift clock), with Pin 3 input (slave select) as the inverted trigger.
SHIFTBUFn	Data to transmit	Transmit data can be written to SHIFTBUF, use the Shifter Status Flag to indicate when data can be written using interrupt or DMA request. Can support MSB first transfer by writing to SHIFTBUFBBS register instead.
SHIFTBUF(n+1)	Data to receive	Received data can be read from SHIFTBUFBYS, use the Shifter Status Flag to indicate when data can be read using interrupt or DMA request. Can support MSB first transfer by reading from SHIFTBUFBIS register instead.

54.5.5 I2C Master

I2C master mode can be supported using two Timers, two Shifters and two Pins. One timer is used to generate the SCL output and one timer is used to control the shifters. The two shifters are used to transmit and receive for every word, when receiving the transmitter must transmit 0xFF to tristate the output. FlexIO inserts a stop bit after every word to generate/verify the ACK/NACK. FlexIO waits for the first write to the transmit data buffer before enabling SCL generation. Data transfers can be supported using the DMA controller and the shifter error flag will set on transmit underrun or receive overflow.

The first timer generates the bit clock for the entire packet (START to Repeated START/STOP), so the compare register needs to be programmed with the total number of clock edges in the packet (minus one). The timer supports clock stretching using the reset counter when pin equal to output (although this increases both the clock high and clock low periods by at least 1 FlexIO clock cycle each). The second timer uses the SCL input pin to control the transmit/receive shift registers, this enforces an SDA data hold time by an extra 2 FlexIO clock cycles.

Both the transmit and receive shifters need to be serviced for each word in the transfer, the transmit shifter must transmit 0xFF when receiving and the receive shifter returns the data actually present on the SDA pin. The transmit shifter will load 1 additional word on the last falling edge of SCL pin, this word should be 0x00 if generating a STOP condition or 0xFF if generating a repeated START condition. During the last word of a master-receiver transfer, the transmit SSTOP bit should be set by software to generate a NACK.

The receive shift register will assert an error interrupt if a NACK is detected, but software is responsible for generating the STOP or repeated START condition. If a NACK is detected during master-transmit, the interrupt routine should immediately write the transmit shifter register with 0x00 (if generating STOP) or 0xFF (if generating repeated START). Software should then wait for the next rising edge on SCL and then disable both timers. The transmit shifter should then be disabled after waiting the setup delay for a repeated START or STOP condition.

Due to synchronization delays, the data valid time for the transmit output is 2 FlexIO clock cycles, so the maximum baud rate is divide by 6 of the FlexIO clock frequency.

The I2C master data valid is delayed 2 cycles because the clock output is passed through a synchronizer before clocking the transmit/receive shifter (to guarantee some SDA hold time). Since the SCL output is synchronous with FlexIO clock, the synchronization delay is 1 cycle and then 1 cycle to generate the output.

Table 54-11. I2C Master Configuration

Register	Value	Comments
SHIFTCFGn	0x0000_0032	Start bit enabled (logic 0) and stop bit enabled (logic 1).
SHIFTCTLn	0x0101_0082	Configure transmit using Timer 1 on rising edge of clock with inverted output enable (open drain output) on Pin 0.
SHIFTCFG(n+1)	0x0000_0020	Start bit disabled and stop bit enabled (logic 0) for ACK/NACK detection.
SHIFTCTL(n+1)	0x0180_0001	Configure receive using Timer 1 on falling edge of clock with input data on Pin 0.
TIMCMPn	0x0000_2501	Configure 2 word transfer with baud rate of divide by 4 of the FlexIO clock. Set $TIMCMP[15:8] = (\text{number of words} \times 18) + 1$. Set $TIMCMP[7:0] = (\text{baud rate divider} / 2) - 1$.
TIMCFGn	0x0102_2222	Configure start bit, stop bit, enable on trigger high, disable on compare, reset if output equals pin. Initial clock state is logic 0 and is not affected by reset.
TIMCTLn	0x01C1_0101	Configure dual 8-bit counter using Pin 1 output enable (SCL open drain), with Shifter 0 flag as the inverted trigger.
TIMCMP(n+1)	0x0000_000F	Configure 8-bit transfer. Set $TIMCMP[15:0] = (\text{number of bits} \times 2) - 1$.
TIMCFG(n+1)	0x0020_1112	Enable when Timer 0 is enabled, disable when Timer 0 is disabled, enable start bit and stop bit at end of each word, decrement on pin input.
TIMCTL(n+1)	0x01C0_0183	Configure 16-bit counter using inverted Pin 1 input (SCL).
SHIFTBUFn	Data to transmit	Transmit data can be written to $SHIFTBUFBBS[7:0]$, use the Shifter Status Flag to indicate when data can be written using interrupt or DMA request.
SHIFTBUF(n+1)	Data to receive	Received data can be read from $SHIFTBUFBIS[7:0]$, use the Shifter Status Flag to indicate when data can be read using interrupt or DMA request.

54.5.6 I2S Master

I2S master mode can be supported using two Timers, two Shifters and four Pins. One timer is used to generate the bit clock and control the shifters and one timer is used to generate the frame sync. FlexIO waits for the first write to the transmit data buffer before

enabling bit clock and frame sync generation. Data transfers can be supported using the DMA controller and the shifter error flag will set on transmit underrun or receive overflow.

The bit clock frequency is an even integer divide of the FlexIO clock frequency, and the initial frame sync assertion occurs at the same time as the first bit clock edge. The timer uses the start bit to ensure the frame sync is generated one clock cycle before the first output data.

Due to synchronization delays, the setup time for the receiver input is 1.5 FlexIO clock cycles, so the maximum baud rate is divide by 4 of the FlexIO clock frequency.

Table 54-12. I2S Master Configuration

Register	Value	Comments
SHIFTCFGn	0x0000_0001	Load transmit data on first shift and stop bit disabled.
SHIFTCTLn	0x0003_0002	Configure transmit using Timer 0 on rising edge of clock with output data on Pin 0.
SHIFTCFG(n+1)	0x0000_0000	Start and stop bit disabled.
SHIFTCTL(n+1)	0x0080_0101	Configure receive using Timer 0 on falling edge of clock with input data on Pin 1.
TIMCMPn	0x0000_3F01	Configure 32-bit transfer with baud rate of divide by 4 of the FlexIO clock. Set TIMCMP[15:8] = (number of bits x 2) - 1. Set TIMCMP[7:0] = (baud rate divider / 2) - 1.
TIMCFGn	0x0000_0202	Configure start bit, enable on trigger high and never disable. Initial clock state is logic 1.
TIMCTLn	0x01C3_0201	Configure dual 8-bit counter using Pin 2 output (bit clock), with Shifter 0 flag as the inverted trigger. Set PINPOL to invert the output shift clock.
TIMCMP(n+1)	0x0000_007F	Configure 32-bit transfer with baud rate of divide by 4 of the FlexIO clock. Set TIMCMP[15:0] = (number of bits x baud rate divider) - 1.
TIMCFG(n+1)	0x0000_0100	Enable when Timer 0 is enabled and never disable.
TIMCTL(n+1)	0x0003_0383	Configure 16-bit counter using inverted Pin 3 output (as frame sync).
SHIFTBUFn	Data to transmit	Transmit data can be written to SHIFTBUFBIS, use the Shifter Status Flag to indicate when data can be written using interrupt or DMA request. Can support LSB first transfer by writing to SHIFTBUF register instead.

Table continues on the next page...

Table 54-12. I2S Master Configuration (continued)

Register	Value	Comments
SHIFTBUF(n+1)	Data to receive	Received data can be read from SHIFTBUFBS, use the Shifter Status Flag to indicate when data can be read using interrupt or DMA request. Can support LSB first transfer by reading from SHIFTBUF register instead.

54.5.7 I2S Slave

I2S slave mode can be supported using three Timers, two Shifters and four Pins (for single transmit and single receive, other combinations of transmit and receive are possible).

The transmit data must be written to the transmit buffer register before the external frame sync asserts, otherwise the shifter error flag will be set.

Due to synchronization delays, the output valid time for the serial output data is 2.5 FlexIO clock cycles, so the maximum baud rate is divide by 6 of the FlexIO clock frequency.

The output valid time of I2S slave is max 2.5 cycles because there is a maximum 1.5 cycle delay on the clock synchronization plus 1 cycle to output the data

Timer 2 detects the falling edge of frame sync (start of new frame) and asserts output until falling edge of bit clock (when frame sync is normally sampled). Timer 0 detects falling edge of bit clock with Timer 2 output asserted and asserts output for length of frame. Timer 1 detects rising edge of bit clock with Timer 0 output asserted and controls shift registers for 32-bit transfers.

Table 54-13. I2S Slave Configuration

Register	Value	Comments
SHIFTCFGn	0x0000_0000	Start and stop bit disabled.
SHIFTCTLn	0x0103_0002	Configure transmit using Timer 1 on rising edge of shift clock with output data on Pin 0.
SHIFTCFG(n+1)	0x0000_0000	Start and stop bit disabled.
SHIFTCTL(n+1)	0x0180_0101	Configure receive using Timer 1 on falling edge of shift clock with input data on Pin 1.
TIMCMPn	0x0000_007F	Configure two 32-bit transfers per frame. Set TIMCMP[15:0] = (number of bits x 4) - 1.

Table continues on the next page...

Table 54-13. I2S Slave Configuration (continued)

Register	Value	Comments
TIMCFGn	0x0020_2500	Configure enable on pin rising edge (inverted bit clock) with trigger high (Timer 2) and disable on compare, initial clock state is logic 1 and decrement on pin input (bit clock).
TIMCTLn	0x0B40_0283	Configure 16-bit counter using inverted Pin 2 input (bit clock), with Timer 2 output as the trigger.
TIMCMP(n+1)	0x0000_003F	Configure 32-bit transfers. Set TIMCMP[15:0] = (number of bits x 2) - 1.
TIMCFG(n+1)	0x0020_2500	Configure enable on pin (bit clock) rising edge with trigger (Timer 0) high and disable on compare, initial clock state is logic 1 and decrement on pin input (bit clock).
TIMCTL(n+1)	0x0340_0283	Configure 16-bit counter using inverted Pin 2 input (bit clock), with Timer 0 output as the trigger.
TIMCMP(n+2)	0x0000_0000	Compare on zero (first edge).
TIMCFG(n+2)	0x0020_6400	Configure enable on inverted pin (frame sync) rising edge and disable on trigger falling edge (bit clock), initial clock state is logic 1 and decrement on inverted pin input (frame sync).
TIMCTL(n+2)	0x0440_0383	Configure 16-bit counter using inverted Pin 3 input (frame sync), with Pin 2 input (bit clock) as the trigger.
SHIFTBUFn	Data to transmit	Transmit data can be written to SHIFTBUFBIS, use the Shifter Status Flag to indicate when data can be written using interrupt or DMA request. Can support LSB first transfer by writing to SHIFTBUF register instead.
SHIFTBUF(n+1)	Data to receive	Received data can be read from SHIFTBUFBIS, use the Shifter Status Flag to indicate when data can be read using interrupt or DMA request. Can support LSB first transfer by reading from SHIFTBUF register instead.

Chapter 55

FlexCAN

55.1 Chip-specific FlexCAN information

55.1.1 Instantiation information

The following table summarizes the implementation of this module for each chip in the product series.

Table 55-1. FlexCAN instances and features

Chip	Instances	Number of Message Buffers (MB)	ISO CAN FD feature ¹	PNET feature	External time tick	CTRL2 register ² reset value
S32K116	FlexCAN0	32 MBs	Yes	Yes	Yes	0x00A0_0000
S32K118	FlexCAN0	32 MBs	Yes	Yes	Yes	0x00A0_0000
S32K142	FlexCAN0	32 MBs	Yes	Yes	Yes	0x00A0_0000
	FlexCAN1	16 MBs	No	No	No	0x00B0_0000
S32K144	FlexCAN0	32 MBs	Yes	Yes	Yes	0x00A0_0000
	FlexCAN1	16 MBs	No	No	No	0x00B0_0000
	FlexCAN2	16 MBs	No	No	No	0x00B0_0000
S32K14xW	FlexCAN0	64 MBs	Yes	Yes	Yes	0x00A0_0000
	FlexCAN1	64 MBs	Yes	No	No	0x00A0_0000
S32K146	FlexCAN0	32 MBs	Yes	Yes	Yes	0x00A0_0000
	FlexCAN1	32 MBs	Yes	No	No	0x00A0_0000
	FlexCAN2	16 MBs	No	No	No	0x00B0_0000
S32K148	FlexCAN0	32 MBs	Yes	Yes	Yes	0x00A0_0000
	FlexCAN1	32 MBs	Yes	No	No	0x00A0_0000
	FlexCAN2	32 MBs	Yes	No	No	0x00A0_0000

1. Refer to 10th character (Ordering Option Y) in orderable product part number for the availability of ISO CAN FD feature (for details see device datasheet). The entire number of Message Buffers are still available for the products with SIM_SDID[6]=0 under CAN classical mode.
2. Bit fields CTRL2[PREXCEN] and CTRL2[EDFLTDIS] are implemented in instances supporting ISO CAN FD feature only.

55.1.2 FlexCAN register information

The [CAN memory map](#) shows a superset of registers implemented for the S32K1xx series. S32K14xW has some differences in register/register bit field implementation, which are listed in the following note. See the following sections for details.

NOTE

- For S32K14xW, the address range from offset 0x80 to 0x47F allocates the sixty-four 128-bit message buffers (MBs).
- S32K14xW has two additional registers - [Interrupt Masks 2 register \(IMASK2\)](#) and [Interrupt Flags 2 register \(IFLAG2\)](#) - for FlexCAN0 and FlexCAN1 instances as described in the following sections.
- The [Rx Individual Mask registers \(RXIMR0 - RXIMR63\)](#) array ranges from 0 - 63 for S32K14xW.
- The [CAN FD Control register \(FDCTRL\)](#) in S32K14xW has an additional register bit field implemented - [MBDSR1](#).

55.1.2.1 Interrupt Masks 2 register (IMASK2)

55.1.2.1.1 Offset

Register	Offset
IMASK2	24h

55.1.2.1.2 Function

This register allows any number of a range of the 32 message buffer interrupts to be enabled or disabled for MB63 to MB32. It contains one interrupt mask bit per buffer, enabling the CPU to determine which buffer generates an interrupt after a successful transmission or reception, that is, when the corresponding IFLAG2 bit is set.

55.1.2.1.3 Diagram

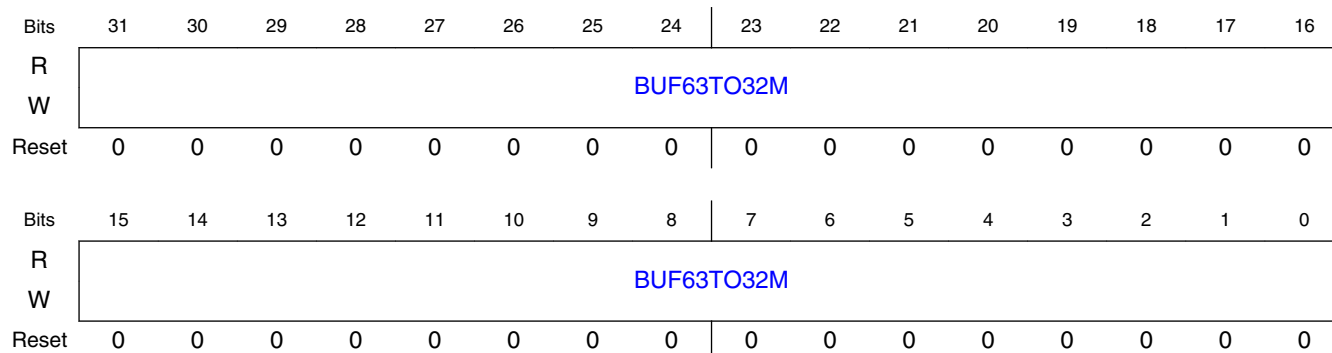

55.1.2.1.4 Fields

Field	Function
31-0 BUF63TO32M	Buffer MB i Mask Each bit enables or disables the corresponding FlexCAN message buffer interrupt for MB63 to MB32. NOTE: Setting or clearing a bit in the IMASK2 Register can assert or negate an interrupt request, if the corresponding IFLAG2 bit is set. 0b - The corresponding buffer interrupt is disabled. 1b - The corresponding buffer interrupt is enabled.

55.1.2.2 Interrupt Flags 2 register (IFLAG2)

55.1.2.2.1 Offset

Register	Offset
IFLAG2	2Ch

55.1.2.2.2 Function

This register defines the flags for the 32 message buffer interrupts for MB63 to MB32. It contains one interrupt flag bit per buffer. Each successful transmission or reception sets the respective IFLAG2 bit. If the corresponding IMASK2 bit is set, an interrupt will be generated. The interrupt flag must be cleared by writing 1 to it. Writing 0 has no effect.

Before updating MCR[MAXMB], CPU must service the IFLAG2 bits whose MB value is greater than the MAXMB to be updated; otherwise, they will remain set and be inconsistent with the number of MBs available.

55.1.2.2.3 Diagram

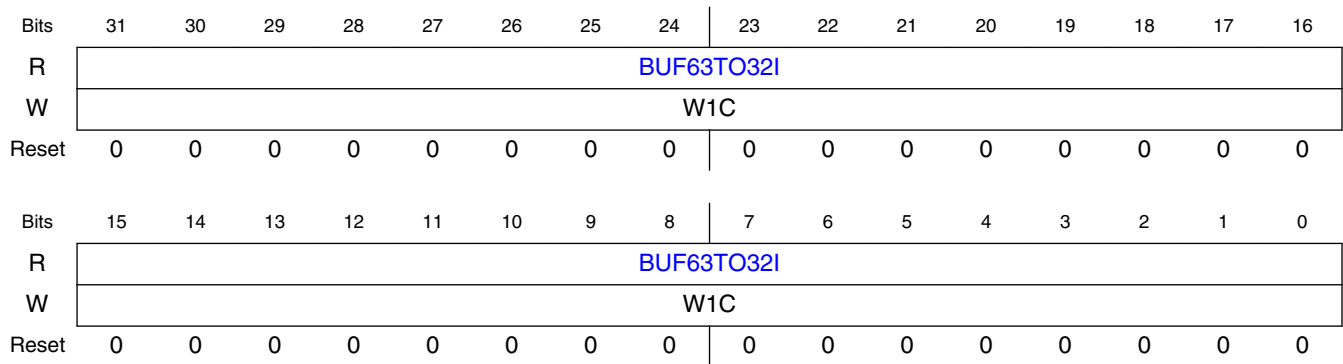

55.1.2.2.4 Fields

Field	Function
31-0	Buffer MB i Interrupt
BUF63TO32I	Each bit flags the corresponding FlexCAN message buffer interrupt for MB63 to MB32. 0b - The corresponding buffer has no occurrence of successfully completed transmission or reception. 1b - The corresponding buffer has successfully completed transmission or reception.

55.1.2.3 Rx Individual Mask registers (RXIMR0 - RXIMR63)

55.1.2.3.1 Offset

For n = 0 to 63:

Register	Offset
RXIMRn	880h + (n × 4h)

55.1.2.3.2 Function

The RX Individual Mask Registers are used to store the acceptance masks for ID filtering in Rx MBs and the Rx FIFO.

When the Rx FIFO is disabled (MCR[RFEN] bit is negated), an individual mask is provided for each available Rx mailbox on a one-to-one correspondence. When the Rx FIFO is enabled (MCR[RFEN] bit is asserted), an individual mask is provided for each Rx FIFO ID filter table element on a one-to-one correspondence depending on the setting of CTRL2[RFFN] (see [Rx FIFO](#)).

RXIMR0 stores the individual mask associated with either MB0 or ID filter table element 0, RXIMR1 stores the individual mask associated with either MB1 or ID filter table element 1, and so on.

RXIMR registers can only be accessed by the CPU when the module is in Freeze mode; otherwise, they are blocked by hardware. These registers are not affected by reset. They are located in RAM and must be explicitly initialized prior to any reception.

It is possible for the RXIMR memory region to be accessed as general purpose memory. See [Bus interface](#) for more information.

55.1.2.3.3 Diagram

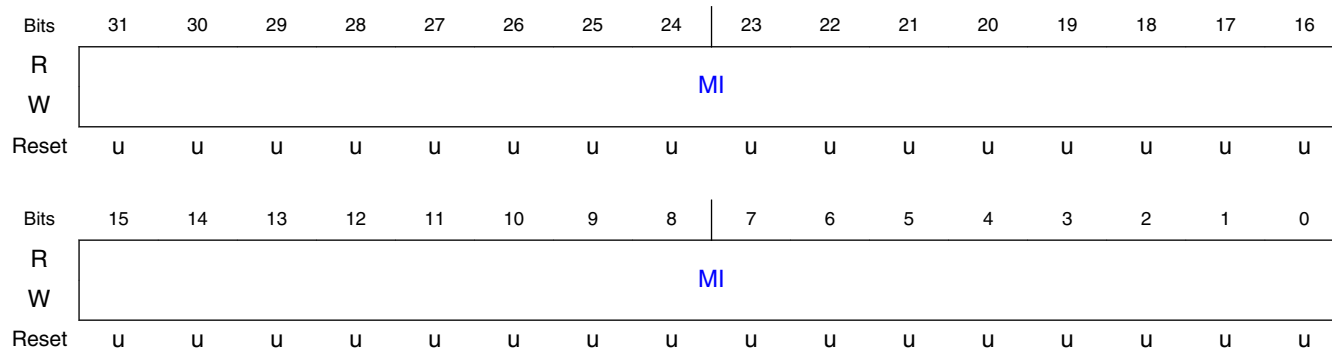

55.1.2.3.4 Fields

Field	Function
31-0	Individual Mask Bits
MI	<p>Each individual mask bit masks the corresponding bit in both the mailbox filter and Rx FIFO ID filter table element in distinct ways.</p> <p>For mailbox filters, see the RXMGMASK register description.</p> <p>For Rx FIFO ID filter table elements, see the RXFGMASK register description.</p> <p>0b - The corresponding bit in the filter is "don't care." 1b - The corresponding bit in the filter is checked.</p>

55.1.2.4 CAN FD Control register (FDCTRL)

55.1.2.4.1 Offset

Register	Offset
FDCTRL	C00h

55.1.2.4.2 Function

This register contains control bits for the CAN FD operation. It also defines the data size of message buffers allocated in different partitions of RAM (memory blocks) as described in the table below.

When an 8-byte payload is selected:

- Block R0 allocates MB0 to MB31.
- Block R1 allocates MB32 to MB63.

When a payload larger than 8 bytes is selected, the maximum number of MBs in a block is limited as described below:

Table 55-2. Number of message buffers

Payload size	Maximum number of message buffers per RAM block
8 bytes	32
16 bytes	21
32 bytes	12
64 bytes	7

NOTE

One memory block fits exactly 32 MBs with an 8-byte payload. For other possible payload sizes, empty memory may exist between the last MB in a block and the beginning of the next block. This empty memory corresponds to less than one MB, and must not be used.

The contents of this register are not affected by soft reset.

55.1.2.4.3 Diagram

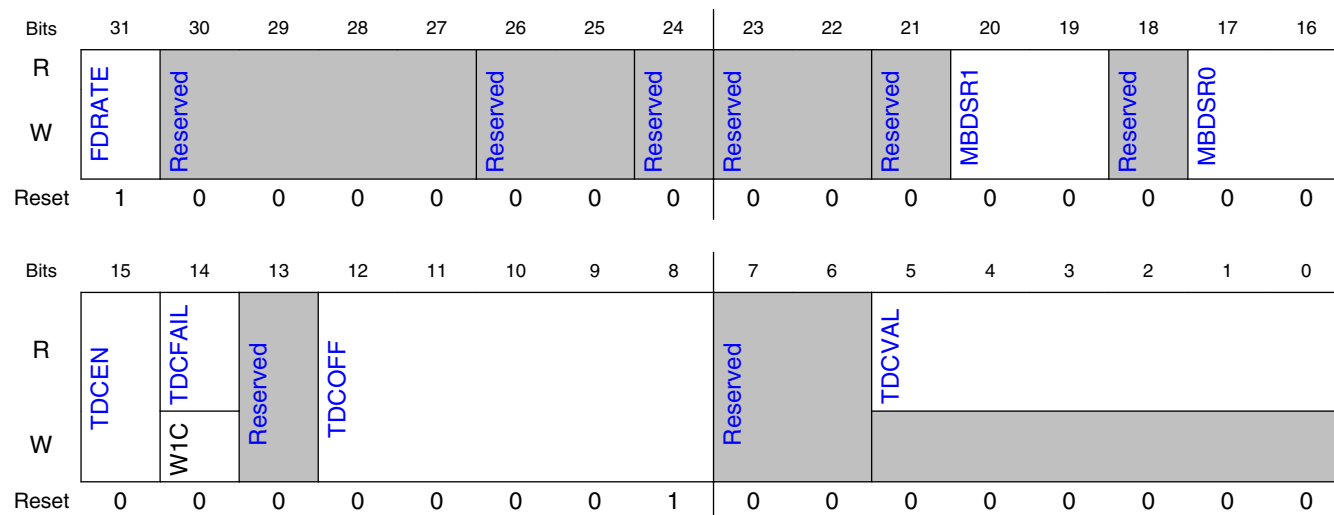

55.1.2.4.4 Fields

Field	Function
31 FDRATE	<p>Bit Rate Switch Enable</p> <p>This bit enables the effect of the Bit Rate Switch (BRS bit) during the data phase of Tx messages. The CPU can write this bit any time. However, its effect turns active only when the CAN bus is in Wait for Bus Idle, Bus Idle, or Bus Off state, or when the current frame under reception or transmission reaches the interframe space.</p> <p>By negating FDCTRL[FDRATE], the CPU can force all bits in CAN FD messages to be transmitted in nominal bit rate, no matter what the value is in the BRS bit of the Tx MBs.</p> <p>0b - Transmit a frame in nominal rate. The BRS bit in the Tx MB has no effect. 1b - Transmit a frame with bit rate switching if the BRS bit in the Tx MB is recessive.</p>
30-27 —	Reserved
26-25 —	Reserved
24 —	Reserved
23-22 —	Reserved
21 —	Reserved
20-19 MBDSR1	<p>Message Buffer Data Size for Region 1</p> <p>This two-bit field selects the data size (8, 16, 32, or 64 bytes) for region R1 of message buffers allocated in RAM.</p> <p>It can be written in Freeze mode only.</p>

Table continues on the next page...

Chip-specific FlexCAN information

Field	Function
	00b - Selects 8 bytes per message buffer. 01b - Selects 16 bytes per message buffer. 10b - Selects 32 bytes per message buffer. 11b - Selects 64 bytes per message buffer.
18 —	Reserved
17-16 MBDSR0	Message Buffer Data Size for Region 0 This two-bit field selects the data size (8, 16, 32, or 64 bytes) for region R0 of message buffers allocated in RAM. It can be written in Freeze mode only. 00b - Selects 8 bytes per message buffer. 01b - Selects 16 bytes per message buffer. 10b - Selects 32 bytes per message buffer. 11b - Selects 64 bytes per message buffer.
15 TDCEN	Transceiver Delay Compensation Enable This bit can be used to enable and disable the TDC feature. It can be written in Freeze mode only. NOTE: See Transmitter delay compensation in the CAN Protocol standard (ISO 11898-1) for details. NOTE: TDC must be disabled when Loop Back mode is enabled (see CTRL1[LPB]). 0b - TDC is disabled 1b - TDC is enabled
14 TDCFAIL	Transceiver Delay Compensation Fail This bit indicates when the Transceiver Delay Compensation (TDC) mechanism is out of range, unable to compensate the transceiver's loop delay and successfully compare the delayed received bits to the transmitted ones (see Transceiver delay compensation). TDCFAIL sets in the first time FlexCAN detects the out of range condition. The CPU needs to write one to clear it. 0b - Measured loop delay is in range. 1b - Measured loop delay is out of range.
13 —	Reserved
12-8 TDCOFF	Transceiver Delay Compensation Offset This bit field contains the offset value to be added to the measured transceiver's loop delay in order to define the position of the delayed comparison point when bit rate switching is active. See Transceiver delay compensation for more details on how the loop delay measurement is performed. TDCOFF can be written in Freeze mode only. Its value can be defined in Protocol Engine (PE) Clock periods (CANCLK, see Protocol timing for more details), and must be selected to be smaller than the CAN bit duration in the data bit rate for proper operation. NOTE: It is not recommended to have TDCOFF equal to zero.
7-6 —	Reserved
5-0 TDCVAL	Transceiver Delay Compensation Value This register contains the value of the transceiver loop delay measured from the transmitted EDL to R0 transition edge to the respective received one added to the TDCOFF value specified in the FDCTRL register. This value is an integer multiple of the Protocol Engine (PE) Clock period (CANCLK). See Protocol timing for more details on how the loop delay measurement is performed.

55.1.3 Reset value of MDIS bit

The CAN_MCR[MDIS] bit is set after reset. Therefore, FlexCAN module is disabled following a reset.

55.1.4 FlexCAN external time tick

On this device, LPIT channel 0 trigger output acts as external time tick source for FlexCAN0.

55.1.5 FlexCAN Interrupts

The FlexCAN has multiple sources of interrupt requests. However, some of these sources are OR'd together to generate a single interrupt request. See below for the mapping of the individual interrupt sources to the interrupt request:

Table 55-3. FlexCAN Interrupts

Request	For CAN with FD	For CAN without FD
Message Buffer	Message buffer interrupts	Message buffer interrupts
Bus off	Bus off	Bus off
Error	<ul style="list-style-type: none"> • Bit1 error or Bit1 error in Data Phase of CAN FD frames • Bit0 error or Bit0 error in Data Phase of CAN FD frames • Acknowledge error • Cyclic redundancy check error or Cyclic redundancy in Data Phase of CAN FD frames • Form error or Form error in Data Phase of CAN FD frames • Stuffing error or Stuffing error in Data Phase of CAN FD frames • Transmit error warning • Receive error warning • CAN-FD error 	<ul style="list-style-type: none"> • Bit1 error • Bit0 error • Acknowledge error • Cyclic redundancy check (CRC) error • Form error • Stuffing error • Transmit error warning • Receive error warning
Transmit Warning	Transmit Warning	Transmit Warning
Receive Warning	Receive Warning	Receive Warning

55.1.6 FlexCAN Operation in Low Power Modes

The FlexCAN module is operational in VLPR mode. With the 4 MHz system clock (in VLPR mode), the fastest supported FlexCAN transfer rate is 250 kbps. The bit timing parameters in the module must be adjusted for the new frequency, but full functionality is possible.

See [Module operation in available power modes](#) for details on available power modes.

55.1.7 FlexCAN oscillator clock

FlexCAN oscillator clock is SOSCDIV2_CLK as mentioned in section [Table 27-9](#)

55.1.8 Supported baud rate

The following table details the supported baud rate for each chip in the product series, considering payload of 8 bytes.

Chip	Number of MBs	PE clock frequency (MHz)	CHI clock frequency (MHz)	Maximum achievable baud rate (Mbps)
S32K14x	32	16	80	3.2
	16			1
S32K14x	32	80	80	8
	16			1
S32K1xx (VLPR)	32	4	4	0.667
	16			
S32K11x	32	16	48	3.2
	32	48		8
S32K14xW	64	16	80	3.2
		80		8
S32K14xW (VLPR)	64	1	1	0.125

55.1.9 Requirements for entering FlexCAN modes: Freeze, Disable, Stop

Follow the procedure described in [Freeze mode entry](#) to place the FlexCAN module in that mode.

On this chip, the FlexCAN module cannot directly enter:

- Module Disable mode
- Stop mode

To enter these modes, the FlexCAN module must first enter Freeze mode. To enter this mode, the FlexCAN module must first enter Freeze mode. See the following information about each of the modes.

55.1.9.1 Freeze mode entry

See [Freeze mode](#) for details about this mode.

On this chip, the procedure to enter Freeze mode is:

1. Set both CAN_MCR[FRZ] (Freeze Enable) and CAN_MCR[HALT] (Halt) to 1.
2. Check whether CAN_MCR[MDIS] (Module Disable) is set to 1. If it is, clear it to 0.
3. Poll the MCR register until CAN_MCR[FRZACK] (Freeze Mode Acknowledge) is set to 1 or the timeout is reached.

NOTE

The minimum timeout duration must be equivalent to:

- a. 730 CAN Nominal bits if CAN_MCR[FDEN] (CAN FD Operation Enable) is set to 1 (CAN bits calculated at arbitration bit rate),
 - b. 180 CAN bits if CAN_MCR[FDEN] is cleared to 0.
4. If CAN_MCR[FRZACK] is set to 1, no further action is required. Skip steps 5 to 8.
 5. If the timeout is reached because CAN_MCR[FRZACK] remains cleared to 0, then set CAN_MCR[SOFTRST] (Soft Reset) to 1.
 6. Poll MCR until CAN_MCR[SOFTRST] is cleared to 0.
 7. Reconfigure the Module Control register (CAN_MCR).
 8. Reconfigure all the Interrupt Mask registers (CAN_IMASK_n).

After these steps are complete, the module is in Freeze mode.

55.1.9.2 Module Disable mode entry

See [Module Disable mode](#) for details about this mode.

CAUTION

In the detailed description of this mode, the list of FlexCAN behavior that begins with "If the module is disabled during transmission or reception" does not apply to this chip.

On this chip, the procedure to enter Module Disable mode is:

1. Enter Freeze mode by following the procedure described in [Freeze mode entry](#).
2. Request Module Disable mode by setting CAN_MCR[MDIS] to 1.
3. Poll CAN_MCR until CAN_MCR[LPMACK] is set to 1. The minimum timeout duration for setting CAN_MCR[LPMACK] is 2 CAN Nominal bits.

55.1.9.3 Stop mode entry

See [Stop mode](#) for details about this mode.

CAUTION

In the detailed description of this mode, the list of FlexCAN behavior that begins with "If Stop mode is requested during transmission or reception" does not apply to this chip.

On this chip, the procedure to enter Stop mode is:

1. Enter Freeze mode by following the procedure described in [Freeze mode entry](#).
2. Request Stop mode.
3. Poll MCR until CAN_MCR[LPMACK] is set to 1. The minimum timeout duration for setting CAN_MCR[LPMACK] is 2 CAN Nominal bits.

55.2 Overview

The FlexCAN module is a communication controller implementing the CAN protocol according to the ISO 11898-1 standard and CAN 2.0 B protocol specifications.

The CAN protocol was primarily designed to be used as a vehicle serial data bus, meeting the specific real-time processing and reliable operation requirements in the EMI environment of a vehicle. The FlexCAN module is a full implementation of the CAN protocol specification, the CAN with Flexible Data rate (CAN FD) protocol, and the CAN 2.0 version B protocol, which supports both standard and extended message frames and long payloads.

NOTE

Rx FIFO cannot be used in FD mode.

55.2.1 Block diagram

A general block diagram is shown in [Figure 55-1](#), which describes the main subblocks implemented in the FlexCAN module.

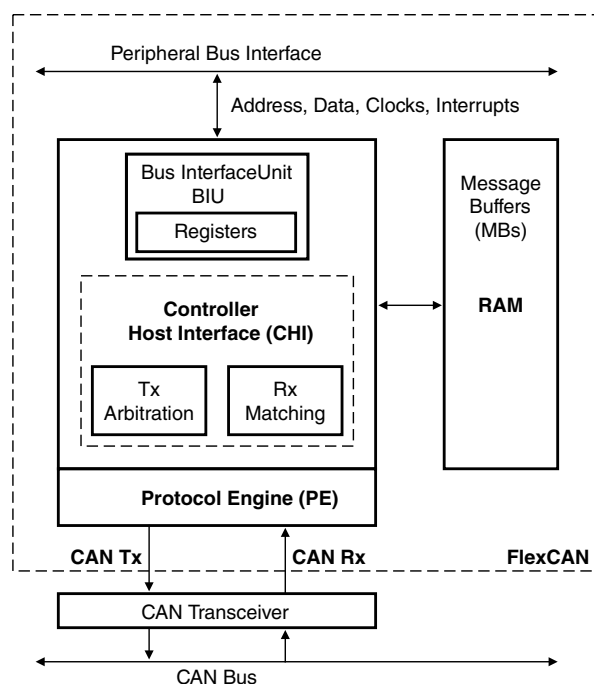

Figure 55-1. FlexCAN block diagram

The Protocol Engine (PE) submodule manages the serial communication on the CAN bus:

- Requesting RAM access for receiving and transmitting message frames
- Validating received messages
- Performing error handling
- Detecting CAN FD messages

The Controller Host Interface (CHI) submodule manages message buffer selection for reception and transmission, taking care of arbitration and ID matching algorithms for both CAN FD and non-CAN FD message formats.

The Bus Interface Unit (BIU) submodule controls access to and from the internal interface bus, in order to establish connection to the CPU and to other blocks. Clocks, address and data buses, interrupt outputs, DMA and test signals are accessed through the BIU.

55.2.2 Features

The FlexCAN module includes these distinctive features:

- Full implementation of the CAN with Flexible Data Rate (CAN FD) protocol specification and CAN protocol specification, Version 2.0 B
 - Standard data frames
 - Extended data frames
 - Zero to sixty four bytes data length
 - Programmable bit rate (see the chip-specific FlexCAN information for the specific maximum rate configuration)
 - Content-related addressing
- Compliant with the ISO 11898-1 standard
- Flexible mailboxes configurable to store 0 to 8, 16, 32, or 64 bytes data length
- Each mailbox configurable as receive or transmit, all supporting standard and extended messages
- Individual Rx Mask registers per mailbox
- Full-featured Rx FIFO with storage capacity for up to six frames and automatic internal pointer handling with DMA support
- Transmission abort capability
- Flexible message buffers (MBs), totaling 32 message buffers of 8 bytes data length each, configurable as Rx or Tx
- Programmable clock source to the CAN Protocol Interface, either peripheral clock or oscillator clock
- RAM not used by reception or transmission structures can be used as general purpose RAM space
- Listen-Only mode capability
- Programmable Loop-Back mode supporting self-test operation
- Programmable transmission priority scheme: lowest ID, lowest buffer number, or highest priority
- Time stamp based on 16-bit free running timer, with an optional external time tick
- Global network time, synchronized by a specific message
- Maskable interrupts
- Independence from the transmission medium (an external transceiver is assumed)
- Short latency time due to an arbitration scheme for high-priority messages
- Low power modes or matching with received frames (Pretended Networking)
- Transceiver delay compensation feature when transmitting CAN FD messages at faster data rates
- Remote request frames may be managed automatically or by software
- CAN bit time settings and configuration bits can only be written in Freeze mode
- Tx mailbox status (Lowest priority buffer or empty buffer)
- Identifier Acceptance Filter Hit Indicator (IDHIT) register for received frames

- SYNCH bit available in Error in Status 1 register to indicate that the module is synchronous with CAN bus
- CRC status for transmitted message
- Rx FIFO Global Mask register
- Selectable priority between mailboxes and Rx FIFO during matching process
- Powerful Rx FIFO ID filtering, capable of matching incoming IDs against either 128 extended, 256 standard, or 512 partial (8 bit) IDs, with up to 32 individual masking capability
- 100% backward compatibility with previous FlexCAN version
- Supports Pretended Networking functionality in low power: Stop mode

55.3 Functional description

The FlexCAN module is a CAN protocol engine with a very flexible mailbox system for transmitting and receiving CAN frames. The mailbox system is composed of a set of message buffers (MB) that store configuration and control data, time stamp, message ID, and data (see [Message buffer structure](#)). The memory corresponding to the first 38 MBs can be configured to support a FIFO reception scheme with a powerful ID filtering mechanism, capable of checking incoming frames against a table of IDs (up to 128 extended IDs or 256 standard IDs or 512 8-bit ID slices), with individual mask register for up to 32 ID filter table elements.

For Classical CAN frames, simultaneous reception through FIFO and mailbox is supported. For CAN FD frames, reception is supported through mailboxes only. For mailbox reception, a matching algorithm makes it possible to store received frames only into MBs that have the same ID programmed in the ID field. A masking scheme makes it possible to match the ID programmed on the MB with a range of IDs on received CAN frames. For transmission, an arbitration algorithm decides the prioritization of MBs to be transmitted based on the message ID (optionally augmented by 3 local priority bits) or the MB ordering.

Before proceeding with the functional description, an important concept must be explained. A message buffer is said to be active at a given time if it can participate in both the matching and arbitration processes. An Rx MB with a 0b code is inactive (see [Table 55-27](#)). Similarly, a Tx MB with a 1000b or 1001b code is also inactive (see [Table 55-28](#)).

The FlexCAN module is also able to receive and transmit messages in CAN FD format. The message buffers are sized to adequately store the quantity of data bytes selected by the FDCTRL[MBDSRn] fields. The quantity of FD MBs available for a given quantity of data bytes is described in the FDCTRL register. See also [FlexCAN memory partition for CAN FD](#).

55.3.1 Modes of operation

The FlexCAN module has these functional modes:

- Normal mode (User or Supervisor):

In Normal mode, the module operates receiving and/or transmitting message frames, errors are managed normally, and all CAN Protocol functions are enabled. User and Supervisor modes differ in the access to some restricted control registers.

- Freeze mode:

Freeze mode is enabled when MCR[FRZ] is asserted. If enabled, Freeze mode is entered when MCR[HALT] is set or when Debug mode is requested at chip level and MCR[FRZ_ACK] is asserted by the FlexCAN. In this mode, no transmission or reception of frames is done and synchronicity to the CAN bus is lost. See [Freeze mode](#) for more information.

- Loop-Back mode:

The module enters this mode when CTRL1[LPB] is asserted. In this mode, FlexCAN performs an internal loop back that can be used for self-test operation. The bit stream output of the transmitter is internally fed back to the receiver input. The Rx CAN input pin is ignored and the Tx CAN output goes to the recessive state (logic '1'). FlexCAN behaves as it normally does when transmitting and treats its own transmitted message as a message received from a remote node. In this mode, FlexCAN ignores the bit sent during the ACK slot in the CAN frame acknowledge field to ensure proper reception of its own message. Both transmit and receive interrupts are generated.

- Listen-Only mode:

The module enters this mode when CTRL1[LOM] is asserted. In this mode, transmission is disabled, all error counters are frozen, and the module operates in a CAN Error Passive mode. Only messages acknowledged by another CAN station

will be received. If FlexCAN detects a message that has not been acknowledged, it will flag a BIT0 error (without changing the REC), as if it was trying to acknowledge the message.

- **CAN FD Active mode:**

In this mode, FlexCAN is capable of transmitting and receiving all messages formatted according to the CAN FD, Standard (2.0) and 2.0B Protocol in an interleaved fashion. The CPU can set the FlexCAN into CAN FD Active mode by configuring MCR[FDEN] in Freeze mode.

It is important to know which features are available in CAN FD active mode. This table lists the differences between FD and classical modes.

Table 55-4. Differences between CAN classical and CAN FD

Feature	CAN classical	CAN FD
Rx FIFO DMA	Yes	No
Rx FIFO	Yes	No
Pretended network support	Yes	No

For low-power operation, the FlexCAN module has:

- **Module Disable mode:**

This low-power mode is entered when MCR[MDIS] is asserted by the CPU and MCR[LPM_ACK] is asserted by FlexCAN. When disabled, the module issues a request to disable the clocks to the CAN Protocol Engine and Controller Host Interface submodules. Exit from this mode is done by negating MCR[MDIS]. See [Module Disable mode](#) for more information.

- **Stop mode:**

This low power mode is entered when Stop mode is requested at chip level and MCR[LPM_ACK] is asserted by the FlexCAN. When in Stop Mode, the module puts itself in an inactive state and then informs the CPU that the clocks can be shut down globally. Exit from this mode happens when the Stop mode request is removed. See [Stop mode](#) for more information.

- **Pretended Network mode:**

This mode can be selected to operate together with Stop mode. Before entering in one of these low power modes you must assert MCR[PNET_EN]. When in low power mode, CHI sub-block clocks are shut down and CAN_PE sub-block is kept clocked, so that the Rx receive process is still active to filter incoming messages (see

[Receive process under Pretended Networking mode](#)) as defined by the configuration registers (see Pretended Networking Control 1 Register (CTRL1_PN)). Upon detecting a wakeup event, a Wake Up interrupt is issued to the system.

55.3.1.1 Modes of operation details

The FlexCAN module has functional modes and low-power modes. See [Modes of operation](#) for an introductory description of all the modes of operation. The following sub-sections contain functional details on Freeze mode and the low-power modes.

CAUTION

"Permanent Dominant" failure on CAN Bus line is not supported by FlexCAN. If a Low-Power request or Freeze mode request is done during a "Permanent Dominant", the corresponding acknowledge can never be asserted.

55.3.1.1.1 Freeze mode

This mode is requested either by the CPU through the assertion of MCR[HALT] or when the chip is put into Debug mode. In both cases it is also necessary that MCR[FRZ] be asserted and the module not be in a low-power mode.

The acknowledgement is obtained through the assertion by the FlexCAN of MECR[FRZ_ACK]. The CPU must only consider the FlexCAN in Freeze mode when both request and acknowledgement conditions are satisfied.

When Freeze mode is requested, FlexCAN does the following:

- Waits to be in either Intermission, Passive Error, Bus Off, or Idle state.
- Waits for all internal activities like arbitration, matching, move-in, and move-out to finish. A pending move-in does not prevent entering Freeze mode.
- Ignores the Rx input pin and drives the Tx pin as recessive.
- Stops the prescaler, thus halting all CAN protocol activities.
- Grants write access to the Error Counters register, which is read-only in other modes.
- Sets MCR[NOTRDY] and MCR[FRZACK].

After requesting Freeze mode, the user must wait for MCR[FRZ_ACK] to be asserted before executing any other action; otherwise FlexCAN may operate in an unpredictable way. In Freeze mode, all memory-mapped registers are accessible, except for CTRL1[CLKSRC], which can be read but cannot be written.

Exiting Freeze mode is done in one of the following ways:

- CPU negates MCR[FRZ].
- The chip is removed from Debug mode and/or the HALT bit is negated.

MCR[FRZ_ACK] is negated after the protocol engine recognizes the negation of the freeze request. When out of Freeze mode, FlexCAN tries to resynchronize to the CAN bus by waiting for 11 consecutive recessive bits.

55.3.1.1.2 Module Disable mode

This low-power mode is normally used to temporarily disable a complete FlexCAN block, with no power consumption. It is requested by the CPU through the assertion of MCR[MDIS], and the acknowledgement is obtained through the assertion by the FlexCAN of MCR[LPMACK]. The CPU must only consider the FlexCAN in Disable mode when both request and acknowledgement conditions are satisfied.

If the module is disabled during Freeze mode, it requests to disable the clocks to the PE and CHI submodules, sets MCR[LPMACK] and negates MCR[FRZACK].

It is not recommended to use Module Disable mode under Pretended Networking mode. Negate MCR[MDIS] and wait for MCR[LPMACK] to negate before setting MCR[PNET_EN].

If the module is disabled during transmission or reception, FlexCAN does the following:

- Waits to be in either Idle or Bus Off state, or else waits for the third bit of Intermission and then checks it to be recessive.
- Waits for all internal activities like arbitration, matching, move-in, and move-out to finish. A pending move-in is not taken into account.
- Ignores its Rx input pin and drives its Tx pin as recessive.
- Shuts down the clocks to the PE and CHI submodules
- Sets MCR[NOTRDY] and MCR[LPMACK].

The Bus Interface Unit continues to operate, enabling the CPU to access memory-mapped registers, except the Rx Mailboxes Global Mask registers, the Rx Buffer 14 Mask register, the Rx Buffer 15 Mask register, the Rx FIFO Global Mask register. The Rx FIFO Information register, the message buffers, the Rx Individual Mask registers, and the reserved words within RAM may not be accessed when the module is in Disable mode. Exiting from this mode is done by negating the MDIS bit by the CPU, which causes the FlexCAN to request to resume the clocks and negate the LPMACK bit after the CAN protocol engine recognizes the negation of disable mode requested by the CPU.

55.3.1.1.3 Stop mode

This is a system low-power mode in which all chip clocks can be stopped for maximum power savings. The Stop mode is globally requested by the CPU and acknowledgement is obtained through the assertion by the FlexCAN of a Stop Acknowledgement signal. The CPU must only consider the FlexCAN in Stop mode when both request and acknowledgement conditions are satisfied.

If FlexCAN receives the global Stop mode request during Freeze mode, it sets MCR[LPMACK], negates MCR[FRZACK], and then sends the Stop Acknowledge signal to the CPU, in order to shut down the clocks globally.

If Stop mode is requested during transmission or reception, FlexCAN does the following:

- Waits to be in either Idle or Bus Off state, or else waits for the third bit of Intermission and checks it to be recessive
- Waits for all internal activities like arbitration, matching, move-in, and move-out to finish. A pending move-in is not taken into account.
- Ignores its Rx input pin and drives its Tx pin as recessive
- Sets MCR[NOTRDY] and MCR[LPMACK]
- Sends a Stop Acknowledge signal to the CPU, so that it can shut down the clocks globally

Stop mode is exited when the CPU resumes the clocks and removes the Stop mode request.

After the CAN protocol engine recognizes the negation of the Stop mode request, the FlexCAN negates MCR[LPMACK]. FlexCAN will then wait for 11 consecutive recessive bits to synchronize to the CAN bus.

55.3.1.1.4 Pretended Networking mode

This is a special low-power mode used to receive wakeup messages with low power consumption. This mode can be selected to operate together with Stop mode. Before entering one of these low-power modes, MCR [PNET_EN] must be asserted. After

entering the low-power mode, CHI subblock is shut down and CAN_PE subblock is kept active, so that the Rx receive process is still active to filter incoming messages (see [Receive process under Pretended Networking mode](#)) as defined by the configuration registers (see [Pretended Networking Control 1 Register \(CTRL1_PN\)](#)). Upon detecting a wakeup event, a Wake Up interrupt is issued to the system.

To enter Pretended Networking mode, FlexCAN must be in normal mode (neither in Freeze nor in Disable mode). Under Pretended Networking mode, FlexCAN keeps itself synchronized with the CAN BUS in Stop mode. Then, when Stop mode is requested, FlexCAN performs the following steps:

- Waits to be in Idle state, or else waits for the third bit of Intermission, and then checks it to be recessive.
- Sets MCR[LPM_ACK].
- Requests the shutdown of the CHI submodule clock, while keeping the PE submodule clock active.

FlexCAN can exit Pretended Networking mode by the following ways:

- The CPU removes the Stop Mode request.
- FlexCAN will wait until Bus Idle or third bit of Intermission state to negate MCR[LPM_ACK].

The above exit ways can be triggered either by the FlexCAN action upon detecting a wakeup event and issuing the respective interrupt, or by the CPU itself upon being waked up by another method. In consequence, FlexCAN will wait until the Bus Idle state or until the third bit of Intermission state to negate MCR[LPM_ACK] and resume Normal mode. This procedure ensures that FlexCAN will be synchronized to the CAN bus after exiting Pretended Networking mode. The CPU must wait for MCR[LPM_ACK] to be negated before performing any access to FlexCAN.

NOTE

For more information about the difference between FD and non-FD regarding this feature, see [Table 55-4](#).

55.3.2 Transmit process

To transmit a CAN frame, the CPU must prepare a message buffer for transmission by executing the following procedure:

1. Check whether the respective interrupt bit is set and clear it.
2. If the MB is active (transmission pending), write the ABORT code (1001b) to the CODE field of the Control and Status word to request an abort of the transmission.

3. Wait for the corresponding IFLAG bit to be asserted by polling the IFLAG register, or by the interrupt request if enabled by the respective IMASK bit.
4. Read back the CODE field to check if the transmission was aborted or transmitted (see [Transmission abort mechanism](#)).
5. Clear the corresponding interrupt flag.
6. Write the ID register (containing the local priority if enabled via MCR[LPRIO_EN]).
7. Write payload data bytes.
8. Configure the Control and Status word with the desired configuration.
 - a. Set ID type via MB_CS[IDE].
 - b. Set Remote Transmission Request (if needed) via MB_CS[RTR].
 - c. If MCR[FDEN] is enabled, also configure the MB_CS[EDL] and MB_CS[BRS] fields. For details about the relationship between the written value and transmitted value of the MB_CS[ESI] field, see [Table 55-9](#).¹
 - d. Set Data Length Code in bytes via MB_CS[DLC]. See [Table 55-29](#) for detailed information.
 - e. Activate the message buffer to transmit the CAN frame by setting MB_CS[CODE] to Ch.

NOTE

It is strongly recommended that all the fields in MB_CS word be configured in only one 32-bit write operation to maximize software performance. If the fields are configured in separate writes, the MB_CS[CODE] must be the last write in the C/S word.

When the MB is activated, it participates in the arbitration process and is eventually transmitted according to its priority. When the DLC value stored in the MB selected for transmission is larger than the respective MB payload size, FlexCAN adds the necessary number of bytes with constant CCh pattern to complete the expected DLC.

At the end of the successful transmission:

- The value of the free running timer is written into the Time Stamp field.
- The CODE field in the Control and Status word is updated.
- Both CRC and FDCRC registers are updated.
- A status flag is set in the Interrupt Flag register.
- An interrupt is generated if allowed by the corresponding Interrupt Mask Register bit.

1. The ESI field does not need to be written, and will automatically be transmitted dominant by error active nodes and recessive by error passive nodes. Note that there is an exception if the FlexCAN is operating as a network gateway: In that case, the CPU writes the MB_CS[ESI] bit according to the error status of the node which sent the message.

The new CODE field after transmission depends on the code that was used to activate the MB (see [Table 55-27](#) and [Table 55-28](#) in [Message buffer structure](#)).

When the Abort feature is enabled (MCR[AEN] is asserted), after the Interrupt flag is asserted for a mailbox configured as transmit buffer, the mailbox is blocked. Therefore the CPU is not able to update it until the Interrupt Flag is negated by the CPU. This means that the CPU must clear the corresponding IFLAG bit before starting to prepare this MB for a new transmission or reception.

NOTE

If backwards compatibility is desired (MCR[AEN] is negated), write the INACTIVE code (1000b) to the CODE field to inactivate the MB. However, in this case the pending frame may be transmitted without notification (see [Mailbox inactivation](#)).

55.3.3 Arbitration process

The arbitration process scans the mailboxes, searching for the Tx mailbox that holds the message to be sent in the next opportunity. This mailbox is called the arbitration winner.

The scan starts from the lowest number mailbox and runs toward the higher ones.

The arbitration process is triggered in the following events:

- From the CRC field of the CAN frame. The start point depends on the value of CTRL2[TASD].
- During the Error Delimiter field of a CAN frame.
- During the Overload Delimiter field of a CAN frame.
- When the winner is inactivated and the CAN bus has still not reached the first bit of the Intermission field.
- When there is a CPU write to the C/S word of a winner MB and the CAN bus has still not reached the first bit of the Intermission field.
- When CHI is in Idle state and the CPU writes to the C/S word of any MB.
- When FlexCAN exits Bus Off state.
- Upon leaving Freeze mode or Low Power mode.

If the arbitration process does not manage to evaluate all mailboxes before the CAN bus has reached the first bit of the Intermission field, the temporary arbitration winner is invalidated and the FlexCAN will not compete for the CAN bus in the next opportunity.

The arbitration process selects the winner among the active Tx mailboxes at the end of the scan according to the settings of both CTRL1[LBUF] and MCR[LPRIOEN].

55.3.3.1 Lowest-number mailbox first

If CTRL1[LBUF] is asserted, the first (lowest number) active Tx mailbox found is the arbitration winner. MCR[LPRIOEN] has no effect when CTRL1[LBUF] is asserted.

55.3.3.2 Highest-priority mailbox first

If CTRL1[LBUF] is negated, then the arbitration process searches the active Tx mailbox with the highest priority, which means that this mailbox's frame would have a higher probability to win the arbitration on CAN bus when multiple external nodes compete for the bus at the same time.

The sequence of bits considered for this arbitration is called the *arbitration value* of the mailbox. The highest-priority Tx mailbox is the one that has the lowest arbitration value among all Tx mailboxes.

If two or more mailboxes have equivalent arbitration values, the mailbox with the lowest number is the arbitration winner.

The composition of the arbitration value depends on the MCR[LPRIOEN] setting.

55.3.3.2.1 Local priority disabled

If MCR[LPRIOEN] is negated the arbitration value is built in the exact sequence of bits as they would be transmitted in a CAN frame (see the following table) in such a way that the local priority is disabled.

Table 55-5. Composition of the arbitration value when local priority is disabled

Format	Mailbox arbitration value (32 bits)				
Standard (IDE = 0)	Standard ID (11 bits)	RTR (1 bit)	IDE (1 bit)	- (18 bits)	- (1 bit)
Extended (IDE = 1)	Extended ID[28:18] (11 bits)	SRR (1 bit)	IDE (1 bit)	Extended ID[17:0] (18 bits)	RTR (1 bit)

55.3.3.2.2 Local priority enabled

To enable local priority, MCR[LPRIOEN] must be asserted. In this case the mailbox PRIO field is included at the very left of the arbitration value (see the following table).

Table 55-6. Composition of the arbitration value when local priority is enabled

Format	Mailbox arbitration value (35 bits)					
Standard (IDE = 0)	PRI0 (3 bits)	Standard ID (11 bits)	RTR (1 bit)	IDE (1 bit)	- (18 bits)	- (1 bit)
Extended (IDE = 1)	PRI0 (3 bits)	Extended ID[28:18] (11 bits)	SRR (1 bit)	IDE (1 bit)	Extended ID[17:0] (18 bits)	RTR (1 bit)

Because the PRI0 field is the most significant part of the arbitration value, mailboxes with low PRI0 values have higher priority than mailboxes with high PRI0 values regardless of the rest of their arbitration values.

Note that the PRI0 field is not part of the frame on the CAN bus. Its purpose is only to affect the internal arbitration process.

55.3.3.3 Arbitration process (continued)

After the arbitration winner is found, its content is copied to a hidden auxiliary MB called Tx Serial Message Buffer (Tx SMB), which has the same structure as a normal MB but is not user accessible. This operation is called move-out and after it is done, write access to the C/S word of the corresponding MB is blocked (if MCR[AEN] is asserted). Write access is restored in the following events:

- After the MB is transmitted and the corresponding IFLAG bit is cleared by the CPU.
- FlexCAN enters Freeze mode or Bus Off.
- FlexCAN loses the bus arbitration or there is an error during the transmission.

At the first opportunity window on the CAN bus, the message on the Tx SMB is transmitted according to the CAN protocol rules.

Arbitration process can be triggered in the following situations:

- During Rx and Tx frames from CAN CRC field to end of frame. CTRL2[TASD] value may be changed to optimize the arbitration start point.
- During CAN Bus Off state from TX_ERR_CNT=124 to 128. CTRL2[TASD] value may be changed to optimize the arbitration start point.
- During C/S write by CPU in Bus Idle. First C/S write starts arbitration process, and a second C/S write during this same arbitration restarts the process. If other C/S writes are performed, Tx arbitration process is pending. If there is no arbitration winner after the arbitration process has finished, then the TX arbitration machine begins a new arbitration process. If there is a pending arbitration and Bus Idle state starts, then an arbitration process is triggered. In this case the first and second C/S write in Bus Idle will not restart the arbitration process. It is possible that there is not enough time

to finish arbitration in Wait For Bus Idle state and the next state is Idle. In this case the scan is not interrupted, and it is completed during Bus Idle state. During this arbitration C/S write does not cause arbitration restart.

- Arbitration winner deactivation during a valid arbitration window.
- Upon exiting Freeze mode (first bit of the Wait For Bus Idle state). If there is a re-synchronization during Wait For Bus Idle, the arbitration process is restarted.

Arbitration process stops in the following situations:

- All mailboxes were scanned.
- A Tx active mailbox is found if lowest buffer feature is enabled.
- Arbitration winner inactivation or abort during any arbitration process.
- There was not enough time to finish Tx arbitration process (for instance, when a deactivation was performed near the end of frame). In this case arbitration process is pending.
- Error or overload flag in the bus.
- Low Power or Freeze mode request in Idle state.

Arbitration is considered pending as described below:

- It was not possible to finish arbitration process in time.
- C/S write during arbitration if write is performed in a MB whose number is lower than the Tx arbitration pointer.
- Any C/S write if there is no Tx arbitration process in progress.
- Rx Match has just updated a Rx code to Tx code.
- Entering Bus Off state.

C/S write during arbitration has the following effect:

- If C/S write is performed in the arbitration winner, a new process is restarted immediately.
- If C/S write is performed in a MB whose number is higher than the Tx arbitration pointer, the ongoing arbitration process will scan this MB as normal.

55.3.4 Receive process

To be able to receive CAN frames into a mailbox, the CPU must prepare it for reception by executing the following steps:

1. If the mailbox is active (either Tx or Rx) inactivate the mailbox (see [Mailbox inactivation](#)), preferably with a safe inactivation (see [Transmission abort mechanism](#)).
2. Write the ID word into the mailbox.

3. Write the EMPTY code (0100b) to the CODE field of the Control and Status word to activate the mailbox. No setup is required for EDL, BRS, and ESI bits—they are overwritten by the respective bit fields in the received message.

After the MB is activated, it will be able to receive frames that match the programmed filter. At the end of a successful reception, the mailbox is updated by the move-in process (see [Move-in](#)) as follows:

1. The received data field (8 bytes at most for Classical CAN message format and up to 64 bytes for CAN FD message format) is stored.
2. The received Identifier field is stored.
3. The value of the Free Running Timer at the time of the second bit of frame's Identifier field is written into the mailbox's Time Stamp field.
4. The received SRR, IDE, RTR, EDL, BRS, ESI, and DLC fields are stored.
5. The CODE field in the Control and Status word is updated (see [Table 55-27](#) and [Table 55-28](#) in Section [Message buffer structure](#)).
6. A status flag is set in the Interrupt Flag Register and an interrupt is generated if allowed by the corresponding Interrupt Mask Register bit.

The recommended way for the CPU to service (read) the frame received in a mailbox is by the following procedure:

1. Read the Control and Status word of that mailbox.
2. Check if the BUSY bit is deasserted, indicating that the mailbox is locked. Repeat step 1) while it is asserted. See [Mailbox lock mechanism](#).
3. Read the contents of the mailbox. After the mailbox is locked, its contents won't be modified by FlexCAN move-in processes. See [Move-in](#).
4. Acknowledge the proper flag at IFLAG registers.
5. Read the free running timer to unlock the mailbox.

The CPU should poll for frame reception by the status flag bit for the specific mailbox in one of the IFLAG registers and not by the CODE field of that mailbox. Polling the CODE field does not work because after a frame is received and the CPU services the mailbox (by reading the C/S word followed by unlocking the mailbox), the CODE field will not return to EMPTY. It will remain FULL, as explained in [Table 55-27](#). If the CPU tries to work around this behavior by writing to the C/S word to force an EMPTY code after reading the mailbox without a prior safe inactivation, a newly received frame matching the filter of that mailbox may be lost.

CAUTION

In summary: never do polling by reading directly the C/S word of the mailboxes. Instead, read the IFLAG registers.

Note that the received frame's Identifier field is always stored in the matching mailbox, thus the contents of the ID field in a mailbox may change if the match was due to masking. When MCR[SRXDIS] is asserted, FlexCAN will not store frames transmitted by itself in any MB, even if it contains a matching Rx mailbox, and no interrupt flag or interrupt signal will be generated. Otherwise, when MCR[SRXDIS] is deasserted, FlexCAN can receive frames transmitted by itself if a matching Rx mailbox exists.

To be able to receive CAN frames through the Rx FIFO, the CPU must enable and configure the Rx FIFO during Freeze mode (see [Rx FIFO](#)). Upon receiving the Frames Available in Rx FIFO interrupt (see the description of IFLAG1[BUF5I] "Frames available in Rx FIFO"), the CPU should service the received frame using the following procedure:

1. Read the Control and Status word (optional: needed only if a mask was used for IDE and RTR bits).
2. Read the ID field (optional: needed only if a mask was used).
3. Read the data field.
4. Read the RXFIR register. (This step is optional, and is executed only if the IDHIT (Identifier Acceptance Filter Hit Indicator) is required in the application.)
5. Clear the Frames Available in Rx FIFO interrupt by writing one to IFLAG1[BUF5I] (mandatory: releases the MB and allows the CPU to read the next Rx FIFO entry).

When MCR[DMA] is asserted, upon receiving a frame in FIFO, IFLAG1[BUF5I] generates a DMA request and does not generate a CPU interrupt (see [Rx FIFO under DMA operation](#)). The IMASK1 bits in Rx FIFO region are not used.

The DMA controller must service the received frame using the following procedure:

1. Read the Control and Status word (read 80h address, optional).
2. Read the ID field (read 84h address, optional).
3. Read all data bytes (start read at 88h address, optional).
4. Read the last data bytes (read 8Ch address is mandatory).

55.3.5 Matching process

The matching process scans the MB memory looking for Rx MBs programmed with the same ID as the one received from the CAN bus. If the FIFO is enabled, the priority of scanning can be selected between mailboxes and FIFO filters. The matching starts from the lowest number message buffer toward the higher ones. If no match is found within the first structure then the other is scanned subsequently. In the event that the FIFO is full, the matching algorithm always looks for a matching MB outside the FIFO region.

For Rx FIFO see [Rx FIFO](#).

As the frame is being received, it is stored in a hidden auxiliary MB called Rx Serial Message Buffer (Rx SMB).

The matching process start point depends on the following conditions:

- If the received frame is a remote frame, the start point is the CRC field of the frame.
- If the received frame is a data frame with DLC field equal to zero, the start point is the CRC field of the frame.
- If the received frame is a data frame with DLC field different than zero, the start point is the DATA field of the frame.

If a matching ID is found in the FIFO table or in one of the mailboxes, the contents of the Rx SMB are transferred to the FIFO or to the matched mailbox by the move-in process. If any CAN protocol error is detected then no match results are transferred to the FIFO or to the matched mailbox at the end of reception.

The matching process scans all matching elements of both Rx FIFO (if enabled) and the active Rx mailboxes (CODE is EMPTY, FULL, OVERRUN, or RANSWER) in search of a successful comparison with the matching elements of the Rx SMB that is receiving the frame on the CAN bus. The Rx SMB has the same structure as a mailbox. The reception structures (Rx FIFO or mailboxes) associated with the matching elements that had a successful comparison are the *matched structures*. The *matching winner* is selected at the end of the scan among those matched structures and depends on conditions described ahead. See the following table.

Table 55-7. Matching architecture

Structure	SMB[RTR]	CTRL2[RRS]	CTRL2[EAC EN]	MB[IDE]	MB[RTR]	MB[ID ¹]	MB[CODE]
Mailbox	0	—	0	cmp ²	no_cmp ³	cmp_msk ⁴	EMPTY or FULL or OVERRUN
Mailbox	0	—	1	cmp_msk	cmp_msk	cmp_msk	EMPTY or FULL or OVERRUN
Mailbox	1	0	—	cmp	no_cmp	cmp	RANSWER
Mailbox	1	1	0	cmp	no_cmp	cmp_msk	EMPTY or FULL or OVERRUN
Mailbox	1	1	1	cmp_msk	cmp_msk	cmp_msk	EMPTY or FULL or OVERRUN
FIFO ⁵	—	—	—	cmp_msk	cmp_msk	cmp_msk	—

1. For mailbox structure, If SMB[IDE] is asserted, the ID is 29 bits (ID Standard + ID Extended). If SMB[IDE] is negated, the ID is only 11 bits (ID Standard). For FIFO structure, the ID depends on IDAM.
2. cmp: Compares the Rx SMB contents with the MB contents regardless the masks.

Functional description

3. no_cmp: The Rx SMB contents are not compared with the MB contents.
4. cmp_msk: Compares the Rx SMB contents with MB contents taking into account the masks.
5. SMB[IDE] and SMB[RTR] are not taken into account when IDAM is type C.

A reception structure is free-to-receive when any of the following conditions is satisfied:

- The CODE field of the mailbox is EMPTY.
- The CODE field of the mailbox is either FULL or OVERRUN and it has already been serviced (the C/S word was read by the CPU and unlocked as described in [Mailbox lock mechanism](#)).
- The CODE field of the mailbox is either FULL or OVERRUN and an inactivation (see [Mailbox inactivation](#)) is performed.
- The Rx FIFO is not full.

The scan order for mailboxes and Rx FIFO is from the matching element with lowest number to the higher ones.

The matching winner search for mailboxes is affected by MCR[IRMQ]. If it is negated, the matching winner is the first matched mailbox regardless if it is free-to-receive or not. If it is asserted, the matching winner is selected according to the priority below:

1. the first free-to-receive matched mailbox;
2. the last non free-to-receive matched mailbox.

It is possible to select the priority of scan between mailboxes and Rx FIFO with CTRL2[MRP].

If the selected priority is Rx FIFO first:

- If the Rx FIFO is a matched structure and is free-to-receive, then the Rx FIFO is the matching winner regardless of the scan for mailboxes.
- Otherwise (the Rx FIFO is not a matched structure or is not free-to-receive), then the matching winner is searched among mailboxes as described above.

If the selected priority is mailboxes first:

- If a free-to-receive matched mailbox is found, it is the matching winner regardless of the scan for Rx FIFO.
- If no matched mailbox is found, then the matching winner is searched in the scan for the Rx FIFO.
- If both conditions above are not satisfied and a non-free-to-receive matched mailbox is found, then the matching winner determination is conditioned by MCR[IRMQ]:
 - If MCR[IRMQ] is negated, the matching winner is the first matched mailbox.
 - If MCR[IRMQ] is asserted, the matching winner is the Rx FIFO if it is a free-to-receive matched structure; otherwise, the matching winner is the last non-free-to-receive matched mailbox.

See the following table for a summary of matching possibilities.

Table 55-8. Matching possibilities and resulting reception structures

RFEN	IRMQ	MRP	Matched in MB	Matched in FIFO	Reception structure	Description
No FIFO, only MB, match is always MB first						
0	0	X ¹	None ²	— ³	None	Frame lost by no match
0	0	X	Free ⁴	—	First MB	
0	1	X	None	—	None	Frame lost by no match
0	1	X	Free	—	First MB	
0	1	X	Not free	—	Last MB	Overrun
FIFO enabled, no match in FIFO is as if FIFO does not exist						
1	0	X	None	None ⁵	None	Frame lost by no match
1	0	X	Free	None	First MB	
1	1	X	None	None	None	Frame lost by no match
1	1	X	Free	None	First MB	
1	1	X	Not free	None	Last MB	Overrun
FIFO enabled, Queue disabled						
1	0	0	X	Not full ⁶	FIFO	
1	0	0	None	Full ⁷	None	Frame lost by FIFO full (FIFO overflow)
1	0	0	Free	Full	First MB	
1	0	0	Not free	Full	First MB	
1	0	1	None	Not full	FIFO	
1	0	1	None	Full	None	Frame lost by FIFO full (FIFO overflow)
1	0	1	Free	X	First MB	
1	0	1	Not free	X	First MB	Overrun
FIFO enabled, queue enabled						
1	1	0	X	Not full	FIFO	
1	1	0	None	Full	None	Frame lost by FIFO full (FIFO overflow)
1	1	0	Free	Full	First MB	
1	1	0	Not free	Full	Last MB	Overrun
1	1	1	None	Not full	FIFO	
1	1	1	Free	X	First MB	
1	1	1	Not free	Not full	FIFO	
1	1	1	Not free	Full	Last MB	Overrun

Functional description

1. This is a don't care condition.
2. Matched in MB "None" means that the frame has not matched any MB (free-to-receive or non-free-to-receive).
3. This is a forbidden condition.
4. Matched in MB "Free" means that the frame matched at least one MB free-to-receive regardless of whether it has matched MBs non-free-to-receive.
5. Matched in FIFO "None" means that the frame has not matched any filter in FIFO. It is as if the FIFO didn't exist (CTRL2[RFEN]=0).
6. Matched in FIFO "Not full" means that the frame has matched a FIFO filter and has empty slots to receive it.
7. Matched in FIFO "Full" means that the frame has matched a FIFO filter but couldn't store it because it has no empty slots to receive it.

If a non-safe mailbox inactivation (see [Mailbox inactivation](#)) occurs during matching process and the mailbox inactivated is the temporary matching winner, then the temporary matching winner is invalidated. The matching elements scan is not stopped nor restarted—it continues normally. The consequence is that the current matching process works as if the matching elements compared before the inactivation did not exist, therefore a message may be lost.

Suppose, for example, that the FIFO is disabled, IRMQ is enabled, there are two MBs with the same ID, and FlexCAN starts receiving messages with that ID. Let us say that these MBs are the second and the fifth in the array. When the first message arrives, the matching algorithm finds the first match in MB number 2. The code of this MB is EMPTY, so the message is stored there. When the second message arrives, the matching algorithm finds MB number 2 again, but it is not "free-to-receive", so it keeps looking, finds MB number 5 and stores the message there. If yet another message with the same ID arrives, the matching algorithm finds out that there are no matching MBs that are "free-to-receive", so it decides to overwrite the last matched MB, which is number 5. In doing so, it sets the CODE field of the MB to indicate OVERRUN.

The ability to match the same ID in more than one MB can be exploited to implement a reception queue (in addition to the full featured FIFO) to allow more time for the CPU to service the MBs. By programming more than one MB with the same ID, received messages are queued into the MBs. The CPU can examine the Time Stamp field of the MBs to determine the order in which the messages arrived.

Matching to a range of IDs is possible by using ID acceptance masks. FlexCAN supports individual masking per MB (see the description of [Rx Individual Mask Registers \(RXIMR0 - RXIMR31\)](#)). During the matching algorithm, if a mask bit is asserted, then the corresponding ID bit is compared. If the mask bit is negated, the corresponding ID bit is a "don't care". Note that the Individual Mask Registers are implemented in RAM, so they are not initialized out of reset. Also, they can only be programmed when the module is in Freeze mode; otherwise, they are blocked by hardware.

FlexCAN also supports an alternate masking scheme with only four mask registers (RXFGMASK, RXMGMASK, RX14MASK, and RX15MASK) for backwards compatibility with legacy applications. This alternate masking scheme is enabled when the IRMQ bit in the MCR register is negated.

55.3.6 Receive process under Pretended Networking mode

Pretended Networking mode adds specific wakeup functionality in low power mode (Stop mode). When Pretended Networking mode (PN) is enabled by asserting MCR[PNET_EN], FlexCAN continues processing Rx CAN messages under low power mode, and is able to detect specific wakeup messages by filtering them against ID and payload target values using preselected matching criteria. Wakeup functionality is not available for messages in CAN FD format. When in Pretended Networking mode, CAN FD format messages are ignored.

PN registers are located in the 0B00h–0B7Ch address range and can be written only in Freeze mode. These registers are used for writing PN configuration (both control and target values) prior to entering Pretended Networking mode, and for reading wakeup flags and the received message ID and data when returning back to normal mode after wakeup. The CPU must wait for MCR[LPMACK] to be negated before performing any access to FlexCAN PN registers.

PN control registers are described in Pretended Networking Control 1 Register (CTRL1_PN) and Pretended Networking Control 2 Register (CTRL2_PN). The control bit fields that configure the filtering criteria are:

- PLFS: payload filtering selection
- IDFS: ID filtering selection
- FCS: filtering combination selection

PN target values are:

- FLT_IDE: IDE target value used to filter the incoming message by its format (standard or extended).
- FLT_RTR: RTR target value used to filter the incoming message by its type (data or remote frame).
- FLT_DLC_HI and FLT_DLC_LO: target DLC range used to filter the size of payload part of an incoming message.
- FLT_ID1: ID target value used to filter the incoming message ID (equal to, smaller than or equal, greater than or equal, or the lower limit value in an ID range).
- FLT_ID2: ID target value used as the upper limit in an ID range.
- PL1: Payload target value used to filter the incoming message payload (equal to, smaller than or equal, greater than or equal, or the lower limit value in a payload range).
- PL2: Payload target value used as the upper limit in a payload range.

IDE, RTR, ID, and payload filters have their respective masks. These masks determine which bits are taken into account in equality comparisons ("1's" in certain mask positions) and which ones are don't care ("0's" in other mask positions). ID and payload masks are used only for exact ID and/or exact payload comparisons.

The ID of Rx incoming messages can be filtered based on the following criteria:

- A match with the exact ID value by detecting the equality between the ID field of the incoming message and the content of target FLT_ID1 register. The ID mask is used.
- A match with the maximum range of ID, that is, any message with ID value smaller than or equal to the content of target FLT_ID1 register is accepted. The ID mask is not used.
- A match with the minimum range of ID, that is, any message with ID value greater than or equal to the content of target FLT_ID1 register is accepted. The ID mask is not used.
- A match inside a range of IDs, that is, any message with an ID value that is greater than or equal to the content of target FLT_ID1 register and smaller than or equal to the content of target FLT_ID2_IDMASK register is accepted. The ID mask is not used.

See CTRL1_PN[IDFS] in [Pretended Networking Control 1 Register \(CTRL1_PN\)](#).

The above criteria for ID filtering must be coherent with FLT_IDE and FLT_RTR target values in FLT_ID1 register. Only Rx frames that match the respective IDE and RTR bits to the contents of FLT_IDE and FLT_RTR bit fields will be compared. When a range of IDs is selected (CTRL1_PN[IDFS] = 11), both FLT_ID1 and FLT_ID2 are referred to the same FLT_IDE and FLT_RTR bits in FLT_ID1 register.

The ID mask is applied only to the exact ID comparison filtering option (CTRL1_PN[IDFS] = 00) to determine which bits are taken into account in the comparison. For the exact match option, the mask can select any bit within the ID field. For maximum range, minimum range, and inside range comparisons, the ID mask is not considered.

The IDE and RTR masks are applied in both exact and range ID comparison filtering options to determine which bits are taken into account in comparison.

Similarly to the ID criteria, 64-bit data or payloads (PL) of Rx incoming messages can be filtered based on the following criteria:

- A match with the exact payload value by detecting the equality between the payload field of the incoming message and the content of PL1 register. The payload mask is used.

- A match with the maximum range of payload, that is, any message with payload value smaller than or equal to the content of PL1 register is accepted. The payload mask is not used.
- A match with the minimum range of payload, that is, any message with payload value greater than or equal to the content of PL1 register is accepted. The payload mask is not used.
- A match inside a range of payloads, that is, any message with a payload value that is greater than or equal to the content of PL1 register and smaller than or equal to the content of PL2 register is accepted. The payload mask is not used.

See CTRL1_PN[PLFS] in [Pretended Networking Control 1 Register \(CTRL1_PN\)](#).

The above criteria for payload filtering must be coherent with FLT_DLC upper and lower limit values in FLT_DLC register. The payload of an Rx incoming message is filtered in accordance with the selected criteria only if the DLC value of the Rx incoming message is inside a DLC range:

- Greater than or equal to the FLT_DLC_LO (lower limit)
- Lower than or equal to the FLT_DLC_HI (upper limit)

Conversely, a DLC value out of the specified range results in a mismatch. By making FLT_DLC_LO = FLT_DLC_HI, only payloads of the specified quantity of bytes will be filtered. DLC is not maskable.

When the inside range of payloads option is selected (CTRL1_PN[PLFS] = 11), both PL1 and PL2 are considered with the 8-byte data length. All the data bytes excluded by the DLC of the received message are considered with value zero.

Payload mask is only used in the exact match option (CTRL1_PN[PLFS] = 00) to select which bits or bytes in the 8-byte data field of both Rx incoming message and the contents of PL1 register are selected for matching. Mask length must be in accordance with the expected range of DLC values. For maximum range, minimum range, and inside range comparisons, the payload mask is not considered.

When a remote frame is received by FlexCAN and CTRL1[FCS] is configured to select the payload comparison, the payload filtering is not considered and the comparison results in a mismatch.

Rx incoming messages can also be filtered based upon the quantity and rate of message reception, specifically:

Functional description

- Several messages that match the filtering criteria for ID or payload for a predefined number of times. This number can be configured in the 1 to 255 range. See the Pretended Networking Control 1 Register (CTRL1_PN).
- No message matching the filtering criteria for ID or payload up to a timeout trigger. That is, non-reception of a matching message for a defined quantity of time. See the Pretended Networking Control 2 Register (CTRL2_PN).

FlexCAN can generate a wakeup timeout event from an internal timer with associated comparator circuitry capable of generating a timeout flag when the counting reaches the pre-defined timeout value, as specified in CTRL2_PN[MATCHTO].

The above filtering criteria can be used together as follows:

- Message ID filtering only
- Message ID filtering and Payload filtering
- Message ID filtering only occurring N times
- Message ID filtering and Payload filtering occurring N times

The timeout counter runs concurrently with the reception filtering process. Both engines, timeout counter and message filtering, are independent. If an incoming message matches the selected filter criteria, the timeout counter keeps counting until the CPU wakes up. Conversely, if the timeout counter reaches the target value then the message filtering process continues to filter incoming messages until the CPU wakes up.

WU_MTC[MOUNTER] will report the number of matched messages that occurred under Pretended Networking mode up to the moment the CPU wakes up.

Under Pretended Networking mode, the wakeup event that may occur will set the respective wakeup flag (see Pretended Networking Wake Up Match Register (WU_MTC)):

- In case of a successful match in accordance with the selected filtering criteria, WU_MTC[WUMF].
- In case of a timeout trigger, WU_MTC[WTOF].

Any of these flags will generate interrupts to the CPU, provided the respective mask bits are enabled (CTRL1_PN[WUMF_MSK] or CTRL1_PN[WTOF_MSK]).

There are four Wake up Message Buffers (WMBs) used to store incoming messages in Pretended Networking mode. Up to four messages can be stored (see [Wake Up Message Buffer register for C/S \(WMB0_CS - WMB3_CS\)](#)).

When CTRL1_PN[NMATCH] value is one, only one message is received if the filtering criteria are matched, and this message is stored in WMB0.

If NMATCH value is between two and four, WMB1, WMB2, and WMB3 are used to store the second, third, and fourth matching messages, respectively.

If NMATCH is greater than four, the last four matching messages are stored in the WMBs. The WMB index indicates the arrival order. The last message is stored in WMB3.

Only the valid data bytes of the incoming match message are stored in the data field of WMBs. The non-valid data bytes are read as zero. If DLC=0 and RTR=1, the data field is filled with zeroes. In any of the above cases, the wakeup interrupt is generated just when the filtering criteria is completed and CTRL1_PN[WUMF_MSK] is enabled.

When a non-match wakeup event occurs (timeout or external) and MCOUNTER register is equal to or greater than four, the message stored in WMB0 does not have valid content. WMB0 is used as a buffer for the current message in the CAN bus. Messages received during Pretended Networking mode don't have time stamps, and the respective field in the WMB structure must be ignored.

Under low power mode (Stop), all processes are shut down except for the PN functionality inside CAN_PE sub-block, which is kept clocked by the oscillator clock (see [Clock domains and restrictions](#)). FlexCAN continues to receive Rx incoming messages but only compares them to the predefined target values and in accordance with the selected filtering criteria. The matching, arbitration, move-in and move-out processes, normally available in Normal mode, are not performed under Pretended Networking mode.

FlexCAN under Pretended Networking reacts to messages on the CAN bus in the same manner as in Normal mode (that is, it generates acknowledge bits, detect and count errors, etc.).

55.3.7 Move process

There are two types of move process: move-in and move-out.

55.3.7.1 Move-in

The move-in process is the copy of a message received by an Rx SMB to an Rx mailbox or FIFO that has matched it. If the move destination is the Rx FIFO, attributes of the message are also copied to the CAN_RXFIR FIFO. Each Rx SMB has its own move-in process, but only one is performed at a given time as described ahead. The move-in starts only when the message held by the Rx SMB has a corresponding matching winner (see [Matching process](#)) and all of the following conditions are true:

- The CAN bus has either reached or already gone past:

Functional description

- The second bit of Intermission field next to the frame that carried the message that is in the Rx SMB.
- The first bit of an overload frame next to the frame that carried the message that is in the Rx SMB.
- There is no ongoing matching process.
- The destination mailbox is not locked by the CPU.
- There is no ongoing move-in process from another Rx SMB. If more than one move-in process is to be started at the same time, both are performed and the newest substitutes for the oldest.

The term pending move-in is used throughout the documentation and stands for a move-to-be that still does not satisfy all of the aforementioned conditions.

The move-in is cancelled and the Rx SMB is able to receive another message if any of the following conditions is satisfied:

- The destination mailbox is inactivated after the CAN bus has reached the first bit of Intermission field next to the frame that carried the message and its matching process has finished.
- There is a previous pending move-in to the same destination mailbox.
- The Rx SMB is receiving a frame transmitted by the FlexCAN itself and self-reception is disabled (MCR[SRXDIS] is asserted).
- Any CAN protocol error is detected.

Note that the pending move-in is not cancelled if the module enters Freeze or Low-Power mode. It stays on hold, only waiting for Freeze and Low-Power mode to be exited and the module to be unlocked. If an MB is unlocked during Freeze mode, the move-in happens immediately.

The move-in process is the execution by the FlexCAN of the following steps:

1. Push IDHIT into the RXFIR FIFO if the message is destined for the Rx FIFO.
2. Read all data words from the Rx SMB in accordance with the selected payload size for the Rx storage element.
3. Write all data words to the Rx mailbox in accordance with the selected payload size for the Rx storage element. If the data size of the storage element is smaller than the original payload size described in the message's DLC field, the payload is truncated and the high order bytes that do not fit the destination size are lost.
4. Read the Control/Status and ID words from the Rx SMB.
5. Write Control/Status and ID words to the Rx mailbox, and update the CODE field.

The move-in process is not atomic, in such a way that it is immediately cancelled by the inactivation of the destination mailbox (see [Mailbox inactivation](#)). In this case the mailbox may remain partially updated, thus incoherent. The exception is if the move-in destination is a Rx FIFO message buffer; then the process cannot be cancelled.

The BUSY Bit (least significant bit of the CODE field) of the destination message buffer is asserted while the move-in is being performed to alert the CPU that the message buffer content is temporarily incoherent.

55.3.7.2 Move-out

The move-out process is the copy of the content from a Tx Mailbox to the Tx SMB when a message for transmission is available (see [Arbitration process](#)). The move-out occurs in the following conditions:

- The first bit of Intermission field
- During Bus Off state when TX Error Counter is in the 124 to 128 range
- During Bus Idle state
- During Wait For Bus Idle state

The move-out process is not atomic. Only the CPU has priority to access the memory concurrently out of Bus Idle state. In Bus Idle, the move-out has the lowest priority to the concurrent memory accesses.

55.3.8 Data coherence

In order to maintain data coherency and FlexCAN proper operation, the CPU must obey the rules described in [Transmit process](#) and [Receive process](#).

55.3.8.1 Transmission abort mechanism

The abort mechanism provides a safe way to request the abort of a pending transmission. A feedback mechanism is provided to inform the CPU if the transmission was aborted or if the frame could not be aborted and was transmitted instead.

Two primary conditions must be fulfilled in order to abort a transmission:

- MCR[AEN] must be asserted.
- The first CPU action must be the writing of abort code (1001b) into the CODE field of the Control and Status word.

Active MBs configured for transmission must be aborted first before they can be updated. If the abort code is written to a Mailbox that is currently being transmitted or to a Mailbox that was already loaded into the Tx SMB for transmission, the write operation is blocked and the transmission is not disturbed. However, the abort request is captured and kept pending until one of the following conditions is satisfied:

- The module loses the bus arbitration.
- There is an error during the transmission.
- The module is put into Freeze mode.
- The module enters Bus Off state.
- There is an overload frame.

If none of the conditions above are reached:

- The MB is transmitted correctly.
- The interrupt flag is set in the IFLAG register.
- An interrupt to the CPU is generated (if enabled).

The abort request is automatically cleared when the interrupt flag is set. On the other hand, if only one of the above conditions is reached, the frame is not transmitted; therefore:

- The abort code is written into the CODE field.
- The interrupt flag is set in the IFLAG.
- An interrupt is (optionally) generated to the CPU.

If the CPU writes the abort code before the transmission begins internally, then the write operation is not blocked; therefore, the MB is updated and the interrupt flag is set. In this way the CPU only needs to read the abort code to make sure the active MB was safely inactivated. Although the AEN bit is asserted and the CPU wrote the abort code, in this case the MB is inactivated and not aborted, because the transmission did not start yet. One Mailbox is aborted only when the abort request is captured and kept pending until one of the previous conditions is satisfied.

55.3.8.2 Mailbox inactivation

Inactivation is a mechanism provided to protect the mailbox against updates by the FlexCAN internal processes, thus allowing the CPU to rely on mailbox data coherence after having updated it, even in Normal mode.

Inactivation of transmission mailboxes must be performed just when MCR[AEN] is deasserted.

If a mailbox is inactivated, it participates in neither the arbitration process nor the matching process until it is reactivated. See [Transmit process](#) and [Receive process](#) for more detailed instructions on how to inactivate and reactivate a mailbox.

To inactivate a mailbox, the CPU must update its CODE field to INACTIVE (either 0b or 1000b).

Because you will not be able to synchronize the CODE field update with the FlexCAN internal processes, an inactivation can have the following consequences:

- A frame in the bus that matches the filtering of the inactivated Rx mailbox may be lost without notice, even if there are other mailboxes with the same filter.
- A frame containing the message within the inactivated Tx mailbox may be transmitted without setting the respective IFLAG.

In order to perform a safe inactivation and avoid the above consequences for Tx mailboxes, the CPU must use the transmission abort mechanism (see [Transmission abort mechanism](#)).

The inactivation automatically unlocks the mailbox (see [Mailbox lock mechanism](#)).

NOTE

Message buffers that are part of the Rx FIFO cannot be inactivated. There is no write protection on the FIFO region by FlexCAN. CPU must maintain data coherency in the FIFO region when RFEN is asserted.

55.3.8.3 Mailbox lock mechanism

Other than mailbox inactivation, FlexCAN has another data coherence mechanism for the receive process. When the CPU reads the Control and Status word of an Rx MB with codes FULL or OVERRUN, FlexCAN assumes that the CPU wants to read the whole MB in an atomic operation, and therefore it sets an internal lock flag for that MB. The lock is released when the CPU reads the free running timer (global unlock operation), or when it reads the Control and Status word of another MB regardless of its code. A CPU write into the C/S word also unlocks the MB, but this procedure is not recommended for normal unlock use because it cancels a pending move and potentially may lose a received message. The MB locking prevents a new frame from being written into the MB while the CPU is reading it.

NOTE

The locking mechanism applies only to Rx MBs that are not part of the FIFO and have a code different than INACTIVE (0b) or EMPTY¹ (0100b). Also, Tx MBs cannot be locked.

Suppose, for example, that the FIFO is disabled and the second and the fifth MBs of the array are programmed with the same ID, and FlexCAN has already received and stored messages into these two MBs. Suppose now that the CPU decides to read MB number 5 and at the same time another message with the same ID is arriving. When the CPU reads the Control and Status word of MB number 5, this MB is locked. The new message arrives and the matching algorithm finds out that there are no free-to-receive MBs, so it decides to override MB number 5. However, this MB is locked, so the new message cannot be written there. It will remain in the Rx SMB waiting for the MB to be unlocked, and only then will be written to the MB.

If the MB is not unlocked in time and yet another new message with the same ID arrives, then the new message overwrites the one on the Rx SMB and there will be no indication of lost messages either in the CODE field of the MB or in the Error and Status Register.

While the message is being moved in from the Rx SMB to the MB, the BUSY bit on the CODE field is asserted. If the CPU reads the Control and Status word and finds out that the BUSY bit is set, it should defer accessing the MB until the BUSY bit is negated.

Note

If the BUSY bit is asserted or if the MB is empty, then reading the Control and Status word does not lock the MB.

Inactivation takes precedence over locking. If the CPU inactivates a locked Rx MB, then its lock status is negated and the MB is marked as invalid for the current matching round. Any pending message on the Rx SMB will not be transferred anymore to the MB. An MB is unlocked when the CPU reads the Free Running Timer Register (see [Free Running Timer \(TIMER\)](#)), or the C/S word of another MB.

Lock and unlock mechanisms have the same functionality in both Normal and Freeze modes.

An unlock during Normal or Freeze mode results in the move-in of the pending message. However, the move-in is postponed if an unlock occurs during a low power mode (see [Modes of operation](#)), and it takes place only when the module returns to Normal or Freeze modes.

55.3.9 Rx FIFO

The Rx FIFO is receive-only and is enabled by asserting MCR[RFEN]. The reset value of this bit is zero to maintain software backward compatibility with previous versions of the module that did not have the FIFO feature.

1. In previous FlexCAN versions, reading the C/S word locked the MB even if it was EMPTY. This behavior is maintained when the IRMQ bit is negated.

CAUTION

Rx FIFO must not be enabled when CAN FD feature is enabled.

The FIFO is 6-message deep. The memory region occupied by the FIFO structure (both message buffers and FIFO engine) is described in [Rx FIFO structure](#). The CPU can read the received messages sequentially, in the order they were received, by repeatedly reading a message buffer structure at the output of the FIFO.

IFLAG1[BUF5I] (Frames available in Rx FIFO) is asserted when there is at least one frame available to be read from the FIFO. An interrupt is generated if it is enabled by the corresponding mask bit. Upon receiving the interrupt, the CPU can read the message (accessing the output of the FIFO as a message buffer) and the RXFIR register, and then clear the interrupt. If there are more messages in the FIFO the act of clearing the interrupt updates the output of the FIFO with the next message and updates RXFIR with the attributes of that message, reissuing the interrupt to the CPU. Otherwise, the flag remains negated. The output of the FIFO is valid only while IFLAG1[BUF5I] is asserted.

IFLAG1[BUF6I] (Rx FIFO Warning) is asserted when the number of unread messages within the Rx FIFO is increased to five from four due to the reception of a new one, meaning that the Rx FIFO is almost full. The flag remains asserted until the CPU clears it.

IFLAG1[BUF7I] (Rx FIFO Overflow) is asserted when an incoming message was lost because the Rx FIFO is full. Note that the flag will not be asserted when the Rx FIFO is full and the message was captured by a Mailbox. The flag remains asserted until the CPU clears it.

Clearing one of those three flags does not affect the state of the other two.

An interrupt is generated if an IFLAG bit is asserted and the corresponding mask bit is asserted too.

A powerful filtering scheme is provided to accept only frames intended for the target application, reducing the interrupt servicing workload. The filtering criteria is specified by programming a table of up to 128 32-bit registers, according to CTRL2[RFFN] setting, that can be configured to one of the following formats (see also [Rx FIFO structure](#)):

- Format A: 128 IDAFs (extended or standard IDs including IDE and RTR)
- Format B: 256 IDAFs (standard IDs or extended 14-bit ID slices including IDE and RTR)
- Format C: 512 IDAFs (standard or extended 8-bit ID slices)

Note

A chosen format is applied to all entries of the filter table. It is not possible to mix formats within the table.

Every frame available in the FIFO has a corresponding IDHIT (Identifier Acceptance Filter Hit Indicator) that can be read in the IDHIT field from C/S word, as shown in the Rx FIFO Structure description. Another way the CPU can obtain this information is by accessing the RXFIR register. RXFIR[IDHIT] refers to the message at the output of the FIFO and is valid while the IFLAG1[BUF5I] flag is asserted. The RXFIR register must be read only before clearing the flag, which guarantees that the information refers to the correct frame within the FIFO.

Up to 32 elements of the filter table are individually affected by the Individual Mask Registers (RXIMRx), according to the setting of CTRL2[RFFN], allowing very powerful filtering criteria to be defined. If MCR[IRMQ] is negated, then the FIFO filter table is affected by RXFGMASK.

NOTE

For more information about the difference between FD and non-FD regarding this feature, see [Table 55-4](#).

55.3.9.1 Rx FIFO under DMA operation

The receive-only FIFO can support DMA. This feature is enabled by asserting both MCR[RFEN] and MCR[DMA]. The reset value of MCR[DMA] is zero to maintain backward compatibility with previous versions of the module that did not have the DMA feature.

The DMA controller can read the received message by reading a message buffer structure at the FIFO output port at the 80h–8Ch address range.

NOTE

FlexCAN supports 32-bit access only for DMA transfers.

When MCR[DMA] is asserted the CPU must not access the FIFO output port address range. Before enabling MCR[DMA], the CPU must service the IFLAGs asserted in the Rx FIFO region. Otherwise, these IFLAGs may show that the FIFO has data to be serviced, and mistakenly generate a DMA request. Before disabling MCR[DMA], the CPU must perform a clear FIFO operation.

IFLAG1[BUF5I] (Frames available in Rx FIFO) is asserted when there is at least one frame available to be read from the FIFO. Consequently a DMA request is generated simultaneously. Upon receiving the request, the DMA controller can read the message (accessing the output of the FIFO as a message buffer). The DMA reading process must

end by reading address 8Ch, which clears IFLAG1[BUF5I] and updates both the FIFO output with the next message (if FIFO is not empty) and the RXFIR register with the attributes of the new message. If there are more messages stored in the FIFO, IFLAG1[BUF5I] will be re-asserted and another DMA request is issued. Otherwise, the flag remains negated.

NOTE

RXFIR register contents cannot be read after DMA completes the FIFO read. The IDHIT information is also available in the C/S word at address 080h (see [Rx FIFO structure](#)).

IFLAG1[BUF6I] and IFLAG1[BUF7I] are not used when the DMA feature is enabled.

When FlexCAN is working with DMA, the CPU does not receive any Rx FIFO interruption and must not clear the related IFLAGs. In addition, the related IMASKs are not used to mask the generation of DMA requests.

NOTE

For more information about the difference between FD and non-FD regarding this feature, see [Table 55-4](#).

55.3.9.2 Clear FIFO operation

When MCR[RFEN] is asserted, the clear FIFO operation is a feature used to empty FIFO contents. With MCR[RFEN] asserted the Clear FIFO occurs when the CPU writes one in IFLAG1[BUF0I]. This operation can only be performed in Freeze mode and is blocked by hardware in other modes. This operation does not clear the FIFO IFLAGs; consequently the CPU must service all FIFO IFLAGs before executing the clear FIFO task.

When Rx FIFO is working with DMA, the clear FIFO operation clears IFLAG1[BUF5I] and the DMA request is canceled.

CAUTION

Clear FIFO operation does not clear IFLAGs, except when MCR[DMA] is asserted; in this case only IFLAG1[BUF5I] is cleared.

55.3.10 CAN protocol related features

This section describes the CAN protocol related features.

55.3.10.1 CAN FD ISO compliance

The CAN FD protocol has been improved to increase the failure detection capability that was in the original CAN FD protocol, which is also called non-ISO CAN FD, by CAN in Automation (CiA). A three-bit stuff counter and a parity bit have been introduced in the improved CAN FD protocol, now called ISO CAN FD. The CRC calculation has also been modified. All these improvements make the ISO CAN FD protocol incompatible with the non-FD CAN FD protocol. The non-ISO CAN FD is still supported by FlexCAN so that it can be used mainly during an intermediate phase, for evaluation and development purposes.

Therefore, it is strongly recommended to configure FlexCAN to the ISO CAN FD protocol by setting the ISOCANFDEN field in the CTRL2 register.

55.3.10.2 CAN FD frames

The ISO 11898-1 standard specifies the Classical Frame format compliant to ISO 11898-1 (2003) and introduces the CAN Flexible Data Rate Frame format. The Classical Frame format allows bit rates up to 1 Mbit/s and payloads up to 8 bytes per frame. The Flexible Data Rate Frame format allows bit rates higher than 1 Mbit/s and payloads longer than 8 bytes per frame. FlexCAN can receive and transmit CAN FD messages interleaved with Classical CAN messages.

There are three additional control bits in the CAN FD frame. The Extended Data Length (EDL) bit enables a longer data payload with different data length coding. The Bit Rate Switch (BRS) bit decides whether the bit rate is switched inside a CAN FD format frame. The Error State Indicator (ESI) flag is transmitted dominant by error active nodes, and recessive by error passive nodes. There are no Remote Frames (see [Remote frames](#)) in the CAN FD format. A message configured to transmit a Remote Frame is always sent out in the Classical CAN format. When an FD frame is received and matches a mailbox, the RTR bit in the receiving message buffer is negated. The RTR bit must be considered in classical frames only.

CAN FD messages may be formatted as long frames where the data field exceeds 8 bytes, and may range from 12 up to 64 bytes. They can also be configured to support bit rate switching, where the control field, the data field, and the CRC field of a CAN frame are transmitted with a higher bit rate than the beginning and the end of the frame. Messages in Classical CAN format are limited to transport a maximum payload of 8 bytes at nominal rate. The following figure illustrates the message formats for Classical and FD frames with either standard or extended ID.

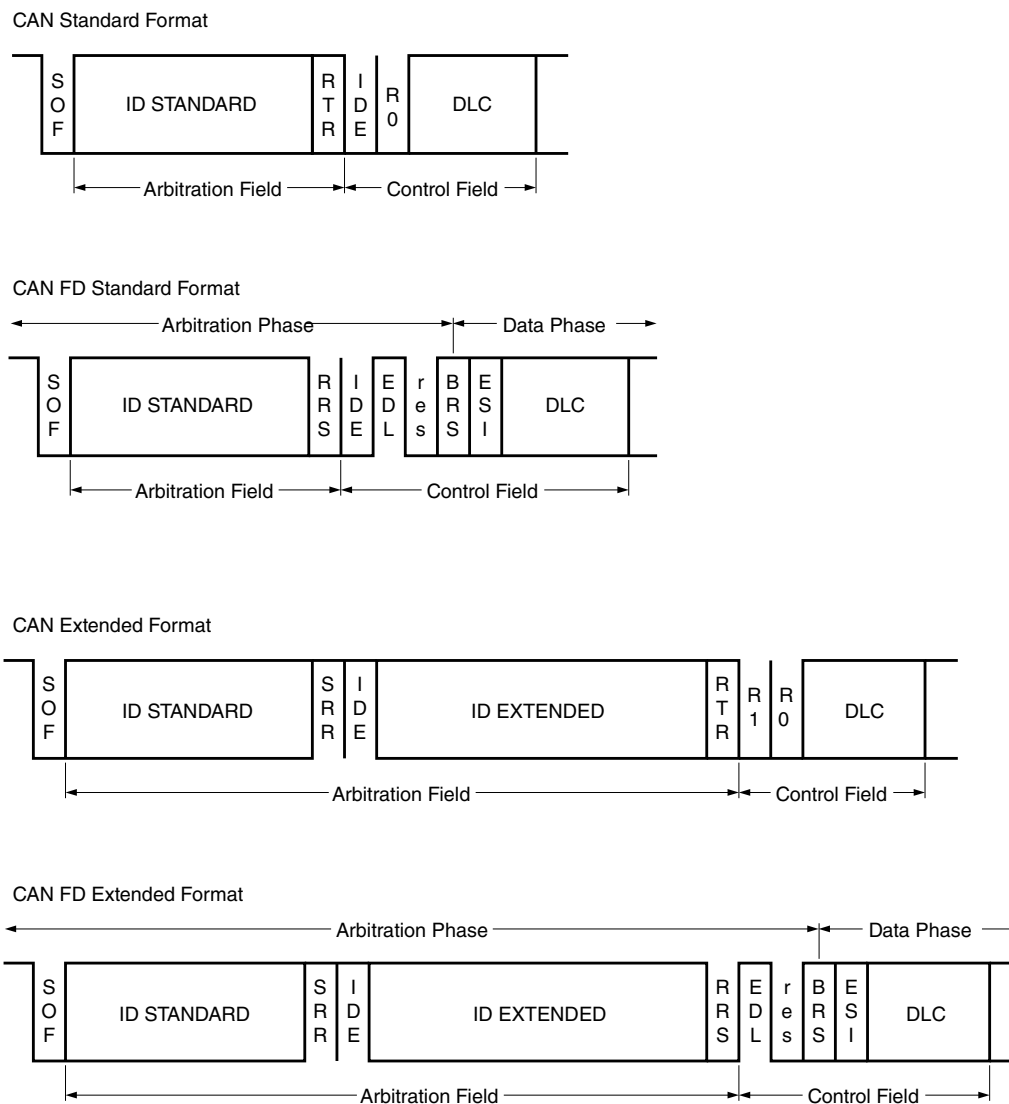

Figure 55-2. CAN message formats

The ability to receive and transmit CAN FD messages is enabled by MCR[FDEN]. Either a recessive R0 bit in CAN frames with 11-bit identifiers or a recessive R1 bit in CAN frames with 29-bit identifiers are decoded as an EDL bit (not a reserved one). A CAN FD frame is recognized by a recessive EDL bit, and a Classical CAN frame is recognized by a dominant EDL bit. The BRS bit specifies whether this frame switches the bit rate in its data phase. A long frame is decoded in accordance with the DLC field value (see DLC definition in [Message buffer structure](#)).

CAN FD messages can be transmitted with two different bit rates. The first part of a CAN FD frame, from the Start Of Frame (SOF) bit until the Bit Rate Switch (BRS) bit, also called the arbitration phase, is transmitted with the nominal bit rate based on a set of nominal CAN bit timing configuration values. The second part, from the BRS bit until the CRC Delimiter bit, also named the data phase, is transmitted with the data bit rate

defined by a second set of CAN data bit timing configuration values. Finally, from the CRC Delimiter until the Intermission bits, the transmission returns to nominal bit rate. In CAN FD frames with bit rate switching, the bit timing is changed inside the frame at the sample point of the BRS bit if this bit is recessive. Before the BRS bit, in the CAN FD arbitration phase, the nominal CAN bit timing is used as defined by the CBT register (also by CTRL1 register for backward compatibility). Upon detecting a recessive BRS bit, the CAN data bit timing is used as defined by the FDCBT register.

NOTE

If the length of the time quantum in the nominal bit timing and the length of the time quantum in the data bit timing are not identical, a quantization error of up to one time quantum of the arbitration phase may be present as a phase error. This situation can occur after the switch from arbitration to data phase and will last until the next synchronization event. Thus, the length of the time quantum should be the same in nominal and data bit timing in order to minimize the chance of error frames on the CAN bus, and to optimize the clock tolerance in networks that use FD frames.

FDCTRL[FDRATE] enables the transmission of all frames with bit rate switching if the BRS bit in the selected Tx MB is set. If FDRATE is negated, the transmission is performed at nominal rate regardless of the BRS bit value. FDCTRL[FDRATE] can be written any time but takes effect only for the next message transmitted or received.

The nominal bit timing is resumed at either the sample point of the CRC Delimiter bit or when an error is detected, whichever occurs first. The following figure describes the mechanism for entering and leaving the data phase when BRS bit is recessive.

CAN FD Frame

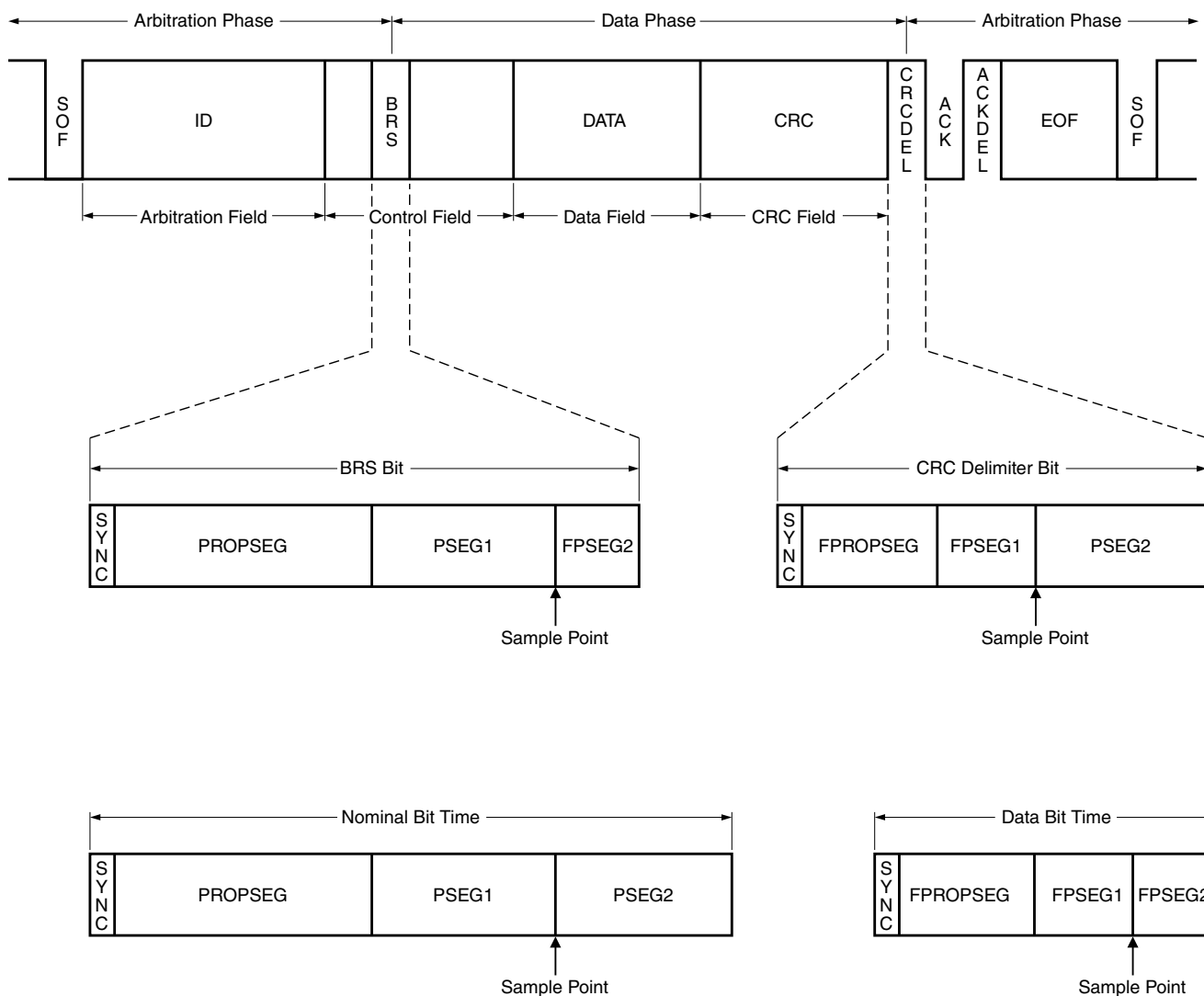

Figure 55-3. Bit rate switching mechanism for CAN FD messages

NOTE

In Classical CAN frames, the CRC delimiter is one single recessive bit. In CAN FD frames, the CRC delimiter may consist of one or two recessive bits. FlexCAN sends only one recessive bit as the CRC delimiter, but it accepts two recessive bits before the edge from recessive to dominant that starts the acknowledge slot. As a receiver, FlexCAN sends its acknowledge bit after the first CRC delimiter bit. In CAN FD frames, FlexCAN accepts a two-bit dominant ACK slot as a valid ACK to compensate for phase shifts between the receivers.

The maximum configurable bit rate in the CAN FD data phase depends on the clock frequency of CAN_PE subblock. For example, with a CAN_PE clock frequency of 40 MHz and the shortest configurable bit time of 5 time quanta, the bit rate in the data phase is 8 Mbit/s.³

The value of the ESI bit is determined either by the transmitter's error state at the start of the transmission, if the frame is originated in the FlexCAN node, or by the original transmitting node in case FlexCAN is acting as a gateway for the message. If the transmitter is error passive, ESI is transmitted recessive; otherwise, it is transmitted dominant. The permutations of the relationship between the written value and the transmitted value of the ESI are shown in this table.

Table 55-9. Written versus transmitted values of ESI field

FlexCAN fault confinement status at start of frame	ESI bit Of Tx MB	Transmitted ESI
Error active	0	0 (Error Active)
Error passive	0	1 (Error Passive)
Error active	1	1 (Error Passive)
Error passive	1	1 (Error Passive)

There are different CRC polynomials for different CAN frame formats. The first polynomial, CRC_15, is used for all frames in Classical CAN format. The second, CRC_17, is used for frames in CAN FD format with a data field up to sixteen bytes long. The third, CRC_21, is used for frames in CAN FD format with a data field longer than sixteen bytes. Each polynomial results in a Hamming distance of 6. At the start of the frame, all three CRC polynomials are calculated concurrently. The CRC sequence to be transmitted is selected by the values of the EDL bit and the DLC bit field. When receiving a message, FlexCAN decodes EDL and DLC to select the adequate CRC polynomial to check for a CRC error.

In CAN FD format frames, stuff bits are included in the bit stream for CRC calculation. In Classical CAN format frames, stuff bits are not included. After the transmission of the last bit relevant to the CRC calculation, the FDCRC register stores the calculated CRC for the transmitted message, with the adequate length in accordance to the type of message, for both CAN FD and non-FD messages. The CRCR register reports a valid CRC for Classical CAN messages only.

In CAN FD format frames, the CAN bit stuffing method is changed for the CRC sequence so that the stuff bits are inserted at fixed positions. When FlexCAN is transmitting a CAN FD frame, a fixed stuff bit is inserted just before the first bit of the CRC sequence, even if the last bits of the preceding field do not fulfill the CAN stuff

3. The frequency used in this example may not be supported on this chip; it is shown only to demonstrate how the maximum configurable bit rate is calculated.

condition. Additional stuff bits are inserted after each fourth bit of the CRC sequence. The value of any fixed stuff bit is the inverse value of its preceding bit. When FlexCAN is receiving a CAN FD frame, it discards the fixed stuff bits from the bit stream for the CRC check. A stuff error is detected if the fixed stuff bit has the same value as its preceding bit.

FlexCAN detects errors in CAN FD frames the same way as in Classical CAN frames. The error counters `RXERRCNT` and `TXERRCNT` in the `ECR` register accumulate the counts of Rx and Tx errors, respectively, for both FD and non-FD frames indiscriminately. There are two extra error counters (`RXERRCNT_FAST` and `TXERRCNT_FAST`) that accumulate Rx and Tx errors occurring in the data phase of CAN FD frames with the BRS bit set only. The rules for updating the error counters are the same for both CAN FD and non-FD frames (see `ECR` register).

Error Flags `BITERR1`, `BITERR0`, `ACKERR`, `CRCERR`, `FRMERR`, and `STFERR` in the `ESR1` register report errors in both CAN FD and non-FD frames. They also generate the `ERRINT` interrupt if `CTRL1[ERRMSK]` is asserted. The `ESR1` register has additional error flags (`BITERR1_FAST`, `BITERR0_FAST`, `CRCERR_FAST`, `FRMERR_FAST`, and `STFERR_FAST`) to individually indicate the occurrence of errors in the data phase of CAN FD frames with the BRS bit set. There is no `ACKERR` detected in the data phase of a CAN FD frame. Fault confinement status reported in `ESR1[FLTCONF]` is the same for both CAN FD and Classical CAN frames, and is based on `RXERRCNT` and `TXERRCNT` error counters only. Information contained in `RXERRCNT_FAST` and `TXERRCNT_FAST` counters may be considered as status to help detect the error nature related to the bit rate value.

When FlexCAN is in the data phase, either transmitting or receiving a CAN FD message, and detects an error, it immediately switches back to the arbitration phase and to the nominal rate to start an error flag.

Resynchronization and hard synchronization occur in CAN FD frames in the same way as in Classical CAN ones. Additionally, a hard synchronization is also performed at the recessive to dominant edge from `EDL` to `R0` in CAN FD format frames. FlexCAN does not resynchronize while transmitting in the CAN FD data phase.

55.3.10.3 Transceiver delay compensation

The CAN FD protocol allows the transmission and reception of data at a higher bit rate than the nominal rate used in the arbitration phase when the message's BRS bit is set. This feature enables the use of rates up to 8 Mbps.

During the data phase of a CAN FD frame, the transmitter detects a bit error if it cannot receive its own latest transmitted bit at the sample point of that bit. When bit rate switching is enabled (BRS bit is asserted), the length of the CAN bit time in the data phase can become shorter than the transceiver's loop delay, thus impeding the correct comparison between the transmitted bit and the received bit within the current CAN bit time interval.

Note that the TDC process defines a secondary sample point where the transmitted bit is correctly compared with the received bit in order to check for bit errors.

The TDC mechanism can be enabled by `FDCTRL[TDCEN]` and is effective only during the data phase of FD frames having the BRS bit set. It has no effect either on non-FD frames, or on FD frames transmitted at normal bit rate. The TDC is active from the sample point of the BRS bit until the sample point of the CRC Delimiter bit, provided the respective message under transmission has the BRS bit set. When it is active, a comparison is done between the real received bit and the delayed transmitted bit, where the delay is calculated based on the measured transceiver loop delay.

NOTE

The actual value of the CRC Delimiter bit is disregarded by transmitters using the transceiver delay compensation mechanism. A global error at the end of the CRC field will cause the receivers to send error frames that the transmitter will detect during Acknowledge or End of Frame.

For every transmitted FD frame having the BRS bit set, the delay measurement is triggered by the transition from the recessive EDL bit to the dominant R0 bit (as shown in the next figure). The loop delay is measured in Protocol Engine (PE) clock periods (CANCLK, see [Protocol timing](#)), from the transmitted EDL-R0 edge to the received EDL-R0 edge. The position of the secondary sample point is defined by the measured loop delay time added to an offset value specified in `FDCTRL[TDCOFF]`. `FDCTRL[TDCVAL]` stores the result of this calculation. The `TDCVAL` value saturates at its maximum value of 63 CANCLK when the delay measurement is too long.

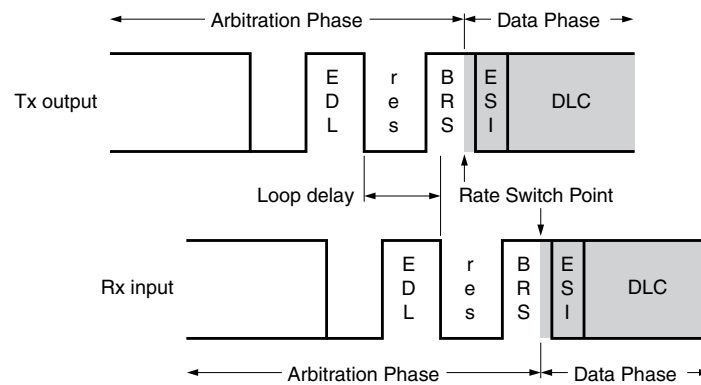

Figure 55-4. Transceiver loop delay measurement

The measured loop delay is not enough to be used to define the secondary sample point because it relates to the CAN bit edges. The transceiver delay compensation offset TDCOFF is used to shift the secondary sample point from the edge to an intermediate point inside the bit time, far away from its edges. Therefore, the TDCOFF value cannot be larger than the CAN bit duration in the data phase.

If the secondary sample point is set very near the CAN bit edge (SYNC field), then problems may occur during the bit sampling in the data phase. For the TDC to work reliably, the offset has to use optimal settings. To be sure the bit sampling is performed in the best region, the TDC offset should be configured as shown in this equation:

$$\text{Offset} = (\text{FPSEG1} + \text{FPROPSEG} + 2) \times (\text{FPRESDIV} + 1)$$

The following figure shows the SSP position when these settings are used.

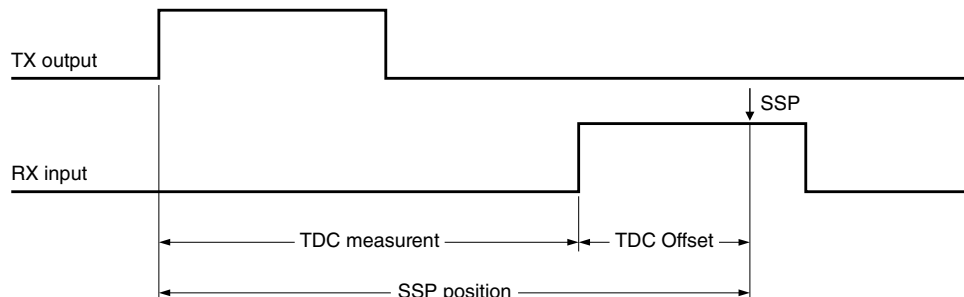

Figure 55-5. SSP position with optimal values

During the data phase of CAN FD frames with bit rate switching enabled, at the onset of every Tx CAN bit, the transmitted Tx bit value is temporarily stored in a buffer and a time countdown based on `FDCTRL[TDCVAL]` is started which ends with the comparison of the received Rx bit (delayed by the external loop delay plus the specified offset) with the stored Tx bit. If a bit error is detected at the secondary sample point, the FlexCAN issues an error flag to the CAN bus at the next sample point.

During the arbitration phase the delay compensation is always disabled. The maximum delay which can be compensated by the FlexCAN's transceiver delay compensation during the data phase is 3 CAN bit times – 2 T_q. Beyond this limit, the FDCTRL[TDCFAIL] flag is set to indicate when the transceiver delay compensation mechanism is out of range, unable to compensate the transceiver loop delay.

55.3.10.4 Remote frames

A remote frame is a special kind of frame. You can program a mailbox to be a remote request frame by configuring the mailbox as Transmit with the RTR bit set to one. After the remote request frame is transmitted successfully, the mailbox becomes a receive message buffer, with the same ID as before.

When a remote request frame is received by FlexCAN, it can be treated in three ways, depending on remote request storing (CTRL2[RRS]) and Rx FIFO Enable (MCR[RFEN]):

- If RRS is negated the frame's ID is compared to the IDs of the transmit message buffers with the CODE field 1010b. If there is a matching ID, then this mailbox frame will be transmitted. Note that if the matching mailbox has the RTR bit set, then FlexCAN will transmit a remote frame as a response. The received remote request frame is not stored in a receive buffer. It is only used to trigger a transmission of a frame in response. The mask registers are not used in remote frame matching, and all ID bits (except RTR) of the incoming received frame should match. In the case that a remote request frame is received and matches a mailbox, this message buffer immediately enters the internal arbitration process, but is considered as a normal Tx mailbox, with no higher priority. The data length of this frame is independent of the DLC field in the remote frame that initiated its transmission.
- If RRS is asserted the frame's ID is compared to the IDs of the receive mailboxes with the CODE field 0100b, 0010b, or 0110b. If there is a matching ID, then this mailbox will store the remote frame in the same fashion of a data frame. No automatic remote response frame will be generated. The mask registers are used in the matching process.
- If RFEN is asserted FlexCAN will not generate an automatic response for remote request frames that match the FIFO filtering criteria. If the remote frame matches one of the target IDs, it will be stored in the FIFO and presented to the CPU. Note that for filtering formats A and B, it is possible to select whether remote frames are accepted or not. For format C, remote frames are always accepted (if they match the ID). Remote request frames are considered as normal frames, and generate a FIFO overflow when a successful reception occurs and the FIFO is already full.

NOTE

There is no remote frame in the CAN FD format. The RTR bit is replaced by a fixed dominant RRS bit. FlexCAN receives and transmits remote frames in the Classical CAN format.

55.3.10.5 Overload frames

FlexCAN does transmit overload frames when the following conditions are detected on the CAN bus:

- Detection of a dominant bit in the first/second bit of Intermission
- Detection of a dominant bit at the 7th bit (last) of End of Frame field (Rx frames)
- Detection of a dominant bit at the 8th bit (last) of Error Frame Delimiter or Overload Frame Delimiter

55.3.10.6 Time stamp

The value of the free running timer is sampled at the beginning of the Identifier field on the CAN bus, and is stored at the end of move-in in the TIME STAMP field, providing network behavior with respect to time.

When CTRL2[TIMER_SRC] is asserted, the free running timer is continuously clocked by an external time tick.

When CTRL2[TIMER_SRC] is negated, the free running timer is clocked by the FlexCAN bit-clock, which defines the baud rate on the CAN bus. During a message transmission/reception, it increments by one for each bit that is received or transmitted. When there is no message on the bus, it counts using the previously programmed baud rate.

The free running timer is not incremented during Disable, Stop, and Freeze modes. It can be reset upon a specific frame reception, enabling network time synchronization. See the TSYN description in Control 1 register (CTRL1).

55.3.10.7 Protocol timing

The following figure shows the structure of the clock generation circuitry that feeds the CAN Protocol Engine (PE) submodule. The clock source field CTRL1[CLKSRC] defines whether the internal clock is connected to the output of a crystal oscillator (oscillator clock) or to the peripheral clock. In order to guarantee reliable operation, the clock source should be selected when the module is in Disable mode (MCR[MDIS] is set).

NOTE

Please see the clock distribution chapter (module clocks table) to identify the proper clock source.

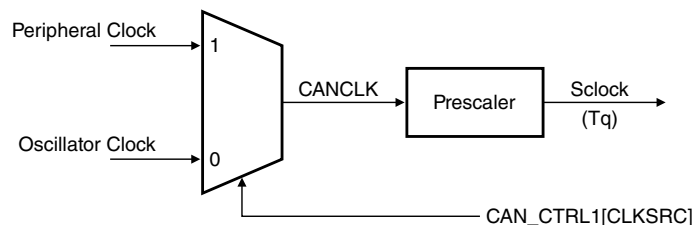

Figure 55-6. CAN engine clocking scheme

The oscillator clock should be selected whenever a tight tolerance (up to 0.1%) is required in the CAN bus timing. The crystal oscillator clock has better jitter performance than the peripheral clock.

The FlexCAN module supports a variety of means to set up bit timing parameters that are required by the CAN protocol. The Control 1 register (CTRL1) has various fields used to control bit timing parameters: PRESDIV, PROPSEG, PSEG1, PSEG2, and RJW.

The CAN Bit Timing register (CBT) extends the range of the CAN bit timing variables in CTRL1. The CAN FD Bit Timing register (FDCBT) provides a second set of CAN bit timing variables to be applied at the data phase of CAN FD frames with the Bit Rate Switch (BRS) set.

NOTE

When the CAN FD feature is enabled, always set CBT[BTF] and configure the CAN bit timing variables in CBT. See [CAN Bit Timing Register \(CBT\)](#).

The PRESDIV field (as well as its extended range EPRESDIV and FDPRESDIV for the data phase bits of CAN FD messages) defines the prescaler value (see the equation below) that generates the serial clock (Sclock), whose period defines the time quantum used to compose the CAN waveform. A time quantum (Tq) is the atomic unit of time managed by the CAN engine.

$$T_q = \frac{(\text{PRES DIV} + 1)}{f_{\text{CANCLK}}}$$

Figure 55-7. Time quantum

The bit rate, which defines the rate the CAN message is either received or transmitted, is given by the formula:

$$\text{CAN Bit Time} = (\text{Number of Time Quanta in 1 bit time}) * T_q$$

$$\text{Bit Rate} = \frac{1}{\text{CAN Bit Time}}$$

Figure 55-8. CAN bit time and baud rate

A bit time is subdivided into three segments¹ (see [Figure 55-9](#), [Figure 55-10](#) and [Table 55-10](#)):

- **SYNC_SEG:** This segment has a fixed length of one time quantum. Signal edges are expected to happen within this section.
- **Time Segment 1:** This segment includes the propagation segment and the phase segment 1 of the CAN standard. It can be programmed by setting CTRL1[PROPSEG] and CTRL1[PSEG1] so that their sum (plus 2) is in the range of 2 to 16 time quanta. When CBT[BTF] is asserted, FlexCAN uses EPROPSEG and EPSEG1 fields from CBT register so that their sum (plus 2) is in the range of 2 to 96 time quanta. For messages in CAN FD format with the BRS bit set, FlexCAN uses FDPROPSEG and FDPSEG1 from FDCBT instead, so that their sum (plus 1) is in the range of 2 to 39 time quanta.
- **Time Segment 2:** This segment represents the phase segment 2 of the CAN standard. It can be programmed by setting CTRL1[PSEG2] (plus 1) to be 2 to 8 time quanta long. When CBT[BTF] is asserted, FlexCAN uses EPSEG2 fields of CBT register so that its value (plus 1) is in the range of 2 to 32 time quanta. For messages in CAN FD format with the BRS bit set, FlexCAN uses FDPSEG2 from FDCBT instead, so that its value (plus 1) is in the range of 2 to 8 time quanta. The time segment 2 cannot be smaller than the Information Processing Time (IPT), which value is 2 time quanta in FlexCAN.

NOTE

The bit time defined by the above time segments must not be smaller than five time quanta. For bit time calculations, use an

1. For further explanation of the underlying concepts, see ISO 11898-1. See also the CAN 2.0A/B protocol specification for bit timing.

Information Processing Time (IPT) of two, which is the value implemented in the FlexCAN module.

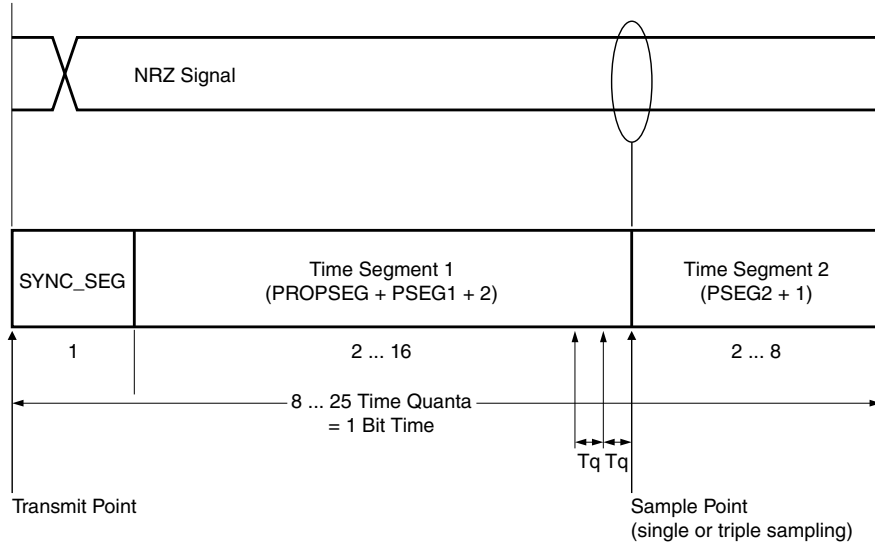

Figure 55-9. Segments within the bit time (example using CTRL1 bit timing variables for Classical CAN format)

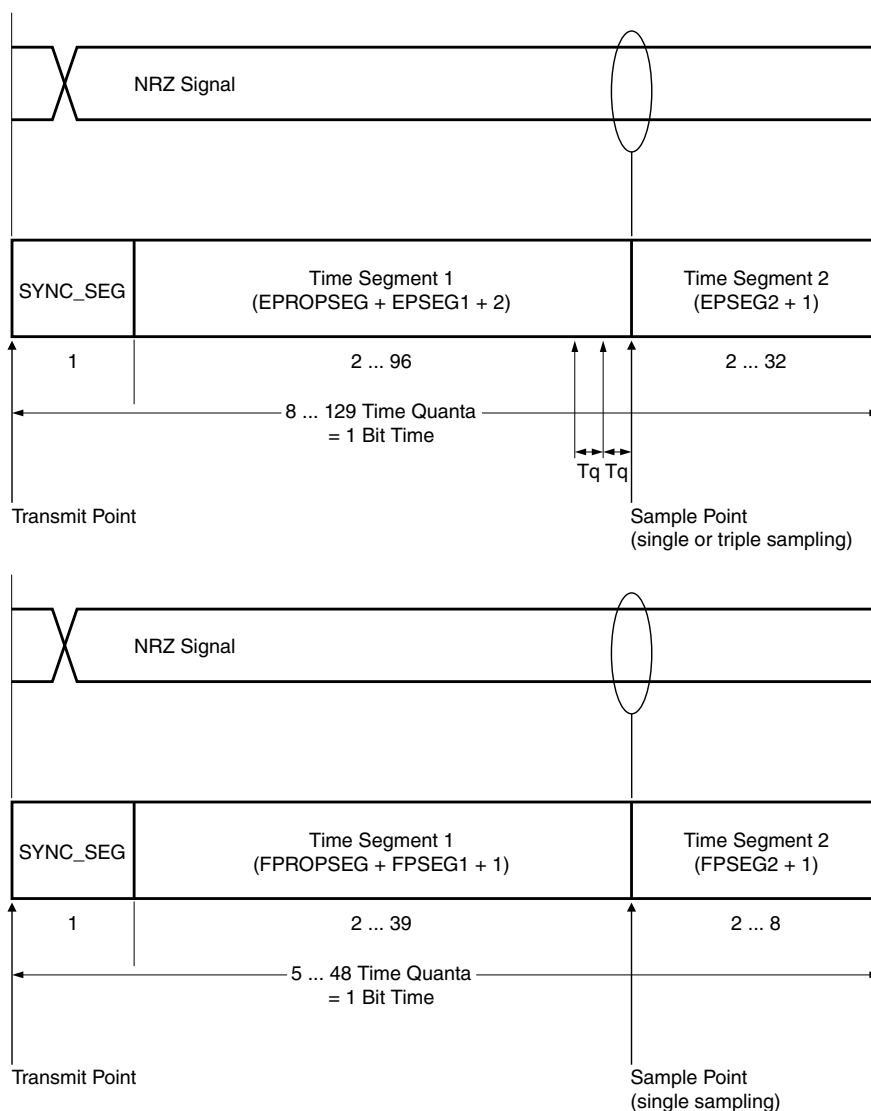

Figure 55-10. Segments within the bit time (example using CBT and FDCBT bit timing variables for CAN FD format)

Table 55-10. Time segment syntax

Syntax	Description
SYNC_SEG	System expects transitions to occur on the bus during this period.
TSEG1	Corresponds to the sum of PROPSEG and PSEG1.
TSEG2	Corresponds to the PSEG2 value.
Transmit point	A node in transmit mode transfers a new value to the CAN bus at this point.
Sample point	A node samples the bus at this point. If the three samples per bit option is selected, then this point marks the position of the third sample.

The following table gives some examples of the CAN compliant segment settings for Classical CAN format (Bosch CAN 2.0B) (non-FD) messages.

Table 55-11. Bosch CAN 2.0B standard compliant bit time segment settings

Time segment 1	Time segment 2	Re-synchronization jump width
5 .. 10	2	1 .. 2
4 .. 11	3	1 .. 3
5 .. 12	4	1 .. 4
6 .. 13	5	1 .. 4
7 .. 14	6	1 .. 4
8 .. 15	7	1 .. 4
9 .. 16	8	1 .. 4

Note

The user must ensure the bit time settings are in compliance with the CAN Protocol standard (ISO 11898-1).

Whenever CAN bit is used as a measure of time duration (for example, estimating the occurrence of a CAN bit event in a message), the number of peripheral clocks in one CAN bit (NumClkBit) can be calculated as:

$$\text{NumClkBit} = \frac{f_{\text{SYS}}}{f_{\text{CANCLK}}} \times (\text{PRES DIV} + 1) \times (\text{PROPSEG} + \text{PSEG1} + \text{PSEG2} + 4)$$

Figure 55-11. Number of peripheral clocks per CAN bit when CTRL2[BTE] = 0

where:

- NumClkBit is the number of peripheral clocks in one CAN bit.
- f_{CANCLK} is the Protocol Engine (PE) Clock (see [Figure 55-6](#)), in Hz.
- f_{SYS} is the frequency of operation of the system (CHI) clock, in Hz.
- PSEG1 is the value in CTRL1[PSEG1] field.
- PSEG2 is the value in CTRL1[PSEG2] field.
- PROPSEG is the value in CTRL1[PROPSEG] field.
- PRES DIV is the value in CTRL1[PRES DIV] field.

The formula above is also applicable to the alternative CAN bit timing variables described in the CAN Bit Timing register (CBT) and also to the CAN FD Bit Timing register (FDCBT).

For example, 180 CAN bits = (180 x NumClkBit) peripheral clock periods.

55.3.10.8 Arbitration and matching timing

During normal reception and transmission, the matching, arbitration, move-in, and move-out processes are executed during certain time windows inside the CAN frame, as shown in the following figures.

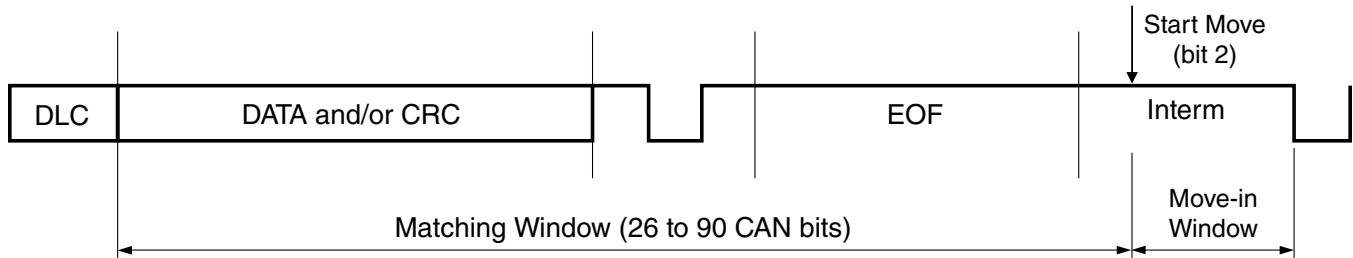

Figure 55-12. Matching and move-in time windows

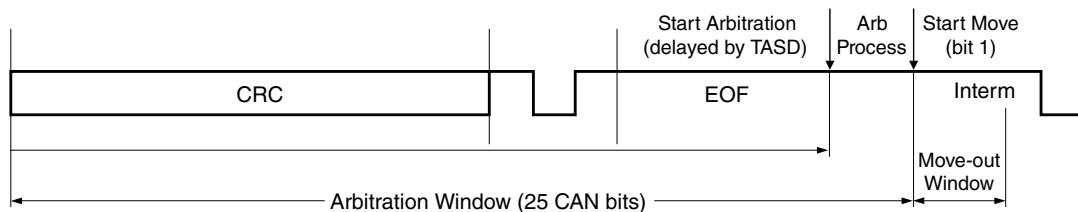

Figure 55-13. Arbitration and move-out time windows

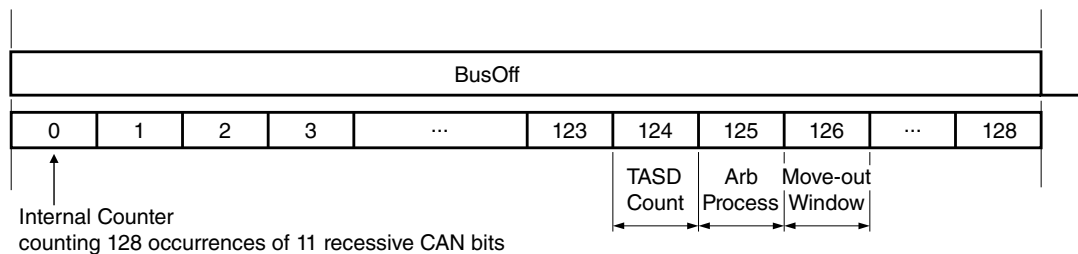

Figure 55-14. Arbitration at the end of bus off and move-out time windows

NOTE

In the preceding figures, the matching and arbitration timing does not take into account the delay caused by the concurrent memory access due to the CPU or other internal FlexCAN subblocks.

55.3.10.9 Tx arbitration start delay

CTRL2[TASD] (Tx Arbitration Start Delay) is a variable that indicates the number of CAN bits used by FlexCAN to delay the Tx arbitration process start point from the first bit of CRC field of the current frame. This variable can be written only in Freeze mode because it is blocked by hardware in other modes.

The transmission performance is impacted by the ability of the CPU to reconfigure message buffers (MBs) for transmission after the end of the internal arbitration process, where FlexCAN finds the winner MB for transmission (see [Arbitration process](#)). If the arbitration ends too early before the first bit of Intermission field, then there is a chance that the CPU reconfigures some Tx MBs and the winner MB is no longer the best candidate to be transmitted.

TASD is useful to optimize the transmission performance by defining the arbitration start point, as shown in the next figure, based on factors such as:

- Peripheral-to-oscillator clock ratio
- CAN bit timing variables that determine the CAN bit rate
- Number of message buffers (MBs) in use by the matching and arbitration processes

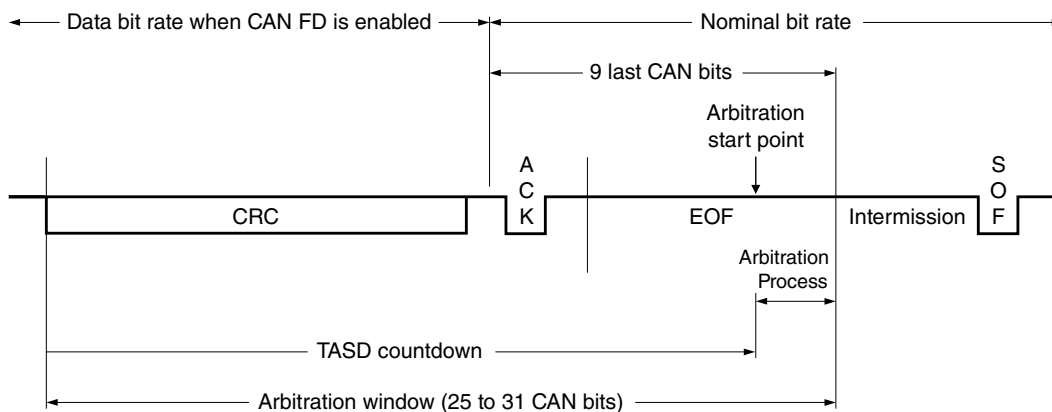

Figure 55-15. Optimal Tx Arbitration start point

The duration of an arbitration process, in terms of CAN bits, is directly proportional to the number of available MBs and to the CAN bit rate, and inversely proportional to the peripheral clock frequency.

The optimal arbitration timing is that in which the last MB is scanned just before the first bit of the Intermission field of a CAN frame. For instance, if there are few MBs and the peripheral/oscillator clock ratio is high and the CAN baud rate is low, then the arbitration can be placed closer to the frame's end, adding more delay to its start point, and vice-versa.

If T ASD is set to 0 then the arbitration start is not delayed and more time is reserved for arbitration. On the other hand, if T ASD is close to 24 then the CPU can configure a Tx MB later and less time is reserved for arbitration. If too little time is reserved for arbitration the FlexCAN may be not be able to find a winner MB in time to be transmitted with the best chance to win the bus arbitration against external nodes on the CAN bus.

The optimal T ASD value can be calculated as follows:

For CAN FD frames and $(MAXMB + 1) \leq NMB_{END}$

$$TASD = 31 - \frac{2 * (MAXMB + 1) + 4}{CPCB_N}$$

For CAN FD frames and $(MAXMB + 1) > NMB_{END}$

$$TASD = 22 - \frac{2 * (MAXMB + 1) - NMB_{END}}{CPCB_F}$$

For non-FD frames

$$TASD = 25 - \frac{2 * (MAXMB + 1) + 4}{CPCB}$$

Figure 55-16. Optimal value for T ASD

where:

$$NMB_{END} = \frac{(9 * CPCB_N) - 4}{2}$$

$$BITRATE_N = \left(\frac{f_{CANCLK}}{[1 + (EPSEG1 + 1) + (EPSEG2 + 1) + (EPROPSEG + 1)] * (EPRESDIV + 1)} \right)$$

$$BITRATE_F = \left(\frac{f_{CANCLK}}{[1 + (FPSEG1 + 1) + (FPSEG2 + 1) + FPROPSEG] * (FPRESDIV + 1)} \right)$$

$$CPCB_N = \frac{f_{SYS}}{BITRATE_N}$$

$$CPCB_F = \frac{f_{SYS}}{BITRATE_F}$$

$$CPCB = CPCB_N$$

Figure 55-17. Variables used in T ASD calculation

- MAXMB is the value in CTRL1[MAXMB].
- NMB_{END} is the number of message buffers that can be scanned by the arbitration process during the 9 last CAN bits at the end of a frame (see the figure above).
- BITRATE_N is the CAN bit rate in bits per second calculated by the nominal CAN bit time variables.
- BITRATE_F is the CAN bit rate in bits per second calculated by the data CAN bit time variables.

Functional description

- $CPCB_N$ is the number of peripheral clocks per CAN bit in nominal bit rate for CAN FD frames.
- $CPCB_F$ is the number of peripheral clocks per CAN bit in data bit rate for CAN FD frames.
- $CPCB$ is the number of peripheral clocks per CAN bit for non-FD frames.
- f_{CANCLK} is the oscillator clock, in Hz.
- f_{SYS} is the peripheral clock, in Hz.
- EPSEG1 is the value in CBT[EPSEG1] (CTRL1[PSEG1] can also be used).
- EPSEG2 is the value in CBT[EPSEG2] (CTRL1[PSEG2] can also be used).
- EPROPSEG is the value in CBT[EPROPSEG] (CTRL1[PROPSEG] can also be used).
- EPRESDIV is the value in CBT[EPRESDIV] (CTRL1[PRESDIV] can also be used).
- FPSEG1 is the value in FDCBT[FPSEG1].
- FPSEG2 is the value in FDCBT[FPSEG2].
- FPROPSEG is the value in FDCBT[FPROPSEG].
- FPRESDIV is the value in FDCBT[FPRESDIV].

See also [Protocol timing](#) for more details.

The following tables give the T ASD value calculated for some configuration cases.

Case 1:

- Clock ratio = 2:1 (example: peripheral clock 80 MHz and oscillator clock 40 MHz)
- Bit rate in arbitration phase = 1 Mbaud

Table 55-12. T ASD values:

Number of message buffers	T ASD value	Maximum bit rate in data phase (MBd)
16	24	Invalid
32	24	8.0

Case 2:

- Clock ratio = 1:1 (example: peripheral clock 40 MHz and oscillator clock 40 MHz)
- Bit rate in arbitration phase = 1 Mbaud

Table 55-13. T ASD values:

Number of message buffers	T ASD value	Maximum bit rate in data phase (MBd)
16	24	Invalid
32	23	6.67

Case 3:

- Clock ratio = 2:1 (example: peripheral clock 40 MHz and oscillator clock 20 MHz)
- Bit rate in arbitration phase = 1 Mbaud

Table 55-14. T ASD values:

Number of message buffers	T ASD value	Maximum bit rate in data phase (MBd)
16	24	Invalid
32	23	4.0

55.3.11 Clocks

The following table describes the clock sources for FlexCAN. Please see chip clocking chapter for clock setting, configuration and gating information.

Table 55-15. FlexCAN clocks

Clock name	Description
ipg_clk	Peripheral clock
ipg_clk_chi	Control Host Interface (CHI) clock
ipg_clk_pe	Protocol Engine (PE) clock
ipg_clk_pe_nogate	Protocol Engine clock (no gating)
ipg_clk_s	Peripheral access clock

55.3.11.1 Clock domains and restrictions

The FlexCAN module has two clock domains asynchronous to each other:

- The bus domain feeds the Control Host Interface (CHI) submodule.
- The oscillator domain feeds the CAN Protocol Engine (PE) submodule.

When CTRL1[CLKSRC] is set, synchronous operation occurs because both domains are connected to the peripheral clock (creating a 1:1 ratio between the peripheral and oscillator clocks).

When the two domains are connected to clocks with different frequencies and/or phases, there are restrictions on the frequency relationship between the two clock domains. In the case of asynchronous operation, the bus domain clock frequency must always be greater than the oscillator domain clock frequency.

NOTE

Asynchronous operation with a 1:1 ratio between peripheral and oscillator clocks is not allowed.

When doing matching and arbitration, FlexCAN needs to scan the whole message buffer memory during the time slot of one CAN frame, comprised of a number of CAN bits. In order to have sufficient time to do that, the following requirements must be observed:

- The peripheral clock frequency cannot be smaller than the oscillator clock frequency.
- There must be a minimum number of peripheral clocks per CAN bit, as specified in the table shown below.

Table 55-16. Minimum number of peripheral clocks per CAN bit for Classical CAN format

Number of mailboxes	Value of MCR[RFEN]	Minimum number of peripheral clocks per CAN bit
16	0	16
32	0	16
16	1	16
32	1	17

For classical frame format, the minimum number of peripheral clocks per CAN bit specified in the preceding table determines the minimum peripheral clock frequency for a given number of mailboxes and for an expected CAN bit rate. The CAN bit rate depends on the number of time quanta in a CAN bit, which can be defined by adjusting one or more of the bit timing values contained in either the Control 1 register (CTRL1) or CAN Bit Time register (CBT). The time quantum (Tq) is defined in [Protocol timing](#). The minimum number of time quanta per CAN bit must be 8; therefore, the oscillator clock frequency should be at least 8 times the CAN bit rate.

For CAN FD frame format, there are some constraints that need to be satisfied. The number of peripheral clocks per CAN bit in nominal bit rate (NumClkNomBit) can be calculated by the equation below.

$$\begin{aligned} \text{NumClkNomBit} &= \frac{f_{\text{SYS}}}{f_{\text{CANCLK}}} \times (\text{PRES DIV} + 1) \times (\text{PROPSEG} + \text{PSEG1} + \text{PSEG2} + 4) \\ &= \frac{f_{\text{SYS}}}{\text{NomBitRate}} \end{aligned}$$

Figure 55-18. Number of peripheral clocks per nominal CAN bit

where PRES DIV, PSEG1, and PSEG2 are CAN bit time values in CTRL1 register. Alternatively, EPRES DIV, EPSEG1, and EPSEG2 values in CBT register can be used instead. NumClkNomBit can also be calculated as a function of the expected nominal bit rate used in the arbitration phase (NomBitRate), as shown in the equation above.

The number of CAN bits in the data phase of an FD frame with the BRS bit set (fast CAN bits, in short) depends on the number of data bytes in the payload. The number of fast CAN bits (NumOfFastBits) can be determined in the table below. The fewer the number of data bytes, the fewer the number of fast CAN bits, and less time is available for FlexCAN to scan the whole message buffer memory during the internal matching and arbitration processes.

Table 55-17. Number of fast CAN bits in a CAN FD frame

Minimum number of data bytes	DLC field	NumOfFastBits
0	0h	21
1	1h	29
2	2h	37
3	3h	45
4	4h	53
5	5h	61
6	6h	69
7	7h	77
8	8h	85
12	9h	117
16	Ah	149
20	Bh	186
24	Ch	218
32	Dh	282
48	Eh	410
64	Fh	538

The critical part of a CAN FD frame is during the data phase, where the CAN bit rate is faster than in the arbitration phase. The minimum number of peripheral clocks per fast CAN bit (MinNumClkFastBit_A) can be calculated to guarantee that enough time is available for FlexCAN to scan the message buffer memory during reception and transmission. The equation below calculates this constraint.

$$\text{MinNumClkFastBit}_A = \frac{(8.5 \times \text{MaxNumOfMb}) + 64 - (9 \times \text{NumClkNomBit})}{\text{NumOfFastBits}}$$

Figure 55-19. Minimum number of peripheral clocks per fast CAN bit for FlexCAN scan process

where MaxNumOfMb is the maximum number of available mailboxes defined in MCR[MAXMB].

Functional description

The clock domain crossing circuit between the CHI and PE subblocks also imposes a minimum number of peripheral clocks per fast CAN bit for the handshake mechanism to work properly without losing status information through the interface, as shown in the equation below.

$$\text{MinNumClkFastBit}_B = 3 \times \left(1 + \frac{f_{\text{SYS}}}{f_{\text{CANCLK}}} \right)$$

Figure 55-20. Minimum number of peripheral clocks per fast CAN bit for FlexCAN clock domain interface

Therefore, the minimum number of peripheral clocks per fast CAN bit (MinNumClkFastBit) is determined by the larger of the two values calculated above.

$$\text{MinNumClkFastBit} = \text{Maximum} (\text{MinNumClkFastBit}_A, \text{MinNumClkFastBit}_B)$$

Figure 55-21. Minimum number of peripheral clocks per fast CAN bit

Then, the maximum CAN bit rate in the data phase of CAN FD frames (DataBitRateMAX) can be calculated as below.

$$\text{DataBitrate}_{\text{MAX}} = \frac{f_{\text{CANCLK}}}{\text{ROUNDUP} \left(\frac{\text{MinNumClkFastBit} \times f_{\text{CANCLK}}}{f_{\text{SYS}}} \right)}$$

Figure 55-22. Maximum achievable baud rate for data phase

The peripheral and oscillator clock frequencies, the maximum number of mailboxes, and the expected nominal bit rate affect the maximum data bit rate attainable by FlexCAN in CAN FD mode. Also, the data bit rate depends on the minimum payload size of FD frames used in a given application.

To illustrate how the CAN FD bit rate is affected by the configuration of FlexCAN variables, an application example with the peripheral and oscillator clock frequencies set to 50 MHz and 40 MHz, respectively, is considered.

1. Considering the nominal bit rate as 1 Mbps, the number of peripheral clocks per CAN bit in nominal bit rate is calculated as below.

$$\text{NumClkNomBit} = \frac{50 \times 10^6}{1 \times 10^6} = 50$$

Figure 55-23. Calculation example for number of peripheral clocks per nominal CAN bit

2. The number of fast CAN bits (NumOfFastBits) is determined in the table presented above. For example, if the minimum payload in FD frames is 8 bytes, then there are 85 CAN bits in the data phase.
3. Assuming the maximum number of mailboxes is 96, the minimum number of peripheral clocks per fast CAN bit (MinNumClkFastBit) can be calculated.

$$\text{MinNumClkFastBit}_A = \frac{(8.5 \times 96) + 64 - (9 \times 50)}{85} = 5.06$$

Figure 55-24. Calculation example for number of peripheral clocks per fast CAN bit for FlexCAN scan process

$$\text{MinNumClkFastBit}_B = 3 \times \left(1 + \frac{50}{40} \right) = 6.75$$

Figure 55-25. Calculation example for number of peripheral clocks per fast CAN bit for FlexCAN clock domain interface

$$\text{MinNumClkFastBit} = \text{Maximum}(5.06, 6.75) = 6.75$$

Figure 55-26. Calculation example for number of peripheral clocks per fast CAN bit
4. The maximum CAN bit rate in the data phase can finally be found.

$$\text{DataBitRate}_{\text{MAX}} = \frac{40 \times 10^6}{\text{ROUNDUP}\left(\frac{6.75 \times 40 \times 10^6}{50 \times 10^6}\right)} = 6.667 \text{ Mbps}$$

Figure 55-27. Calculation example for maximum achievable baud rate

As demonstrated in this example, even though the oscillator clock frequency (40 MHz) is adequate to generate a data rate of 8 Mbps in CAN FD mode, the specific FlexCAN configuration limits this rate to 6.667 Mbps. This limitation is mainly due to the low peripheral clock frequency that imposes the MinNumClkFastBitB bound.

The table below shows the maximum data rate for CAN FD according to clock frequencies, payload size, and number of available mailboxes. See in this table that, for some cases, if the number of available mailboxes is reduced, the FlexCAN can then achieve a data rate up to 8 Mbps.

Table 55-18. Maximum CAN bit rate in data phase on CAN FD frames

Peripheral clock frequency (MHz)	Payload size	Number of available mailboxes	Maximum data rate (Mbps)
40	8	94	6.667
40	8	114	5.0
40	12	117	6.667
40	12	128	5.714
50	12 to 64	128	6.667
60	8	126	8.0
60	12	128	8.0
67	6	128	8.0
80	3	128	8.0
100	0	128	8.0

55.3.12 Reset

You can reset FlexCAN in the following ways:

1. Chip level hard reset, which resets all memory-mapped registers asynchronously.
2. MCR[SOFTRST], which resets some of the memory-mapped registers synchronously. See [Table 55-21](#) to see what registers are affected by soft reset.

Soft reset is synchronous and has to follow an internal request/acknowledge procedure across clock domains. Therefore, it may take some time to fully propagate its effects. MCR[SOFTRST] remains asserted while soft reset is pending, so software can poll this bit to know when the reset has completed. Also, soft reset cannot be applied while clocks are shut down in a low-power mode. The low-power mode should be exited and the clocks resumed before applying soft reset.

The clock source should be selected when the module is in Disable mode (see CTRL1[CLKSRC] description in [Control 1 Register \(CTRL1\)](#)). After the clock source is selected and the module is enabled (MCR[MDIS] bit negated), FlexCAN automatically enters Freeze mode. In Freeze mode, FlexCAN is un-synchronized to the CAN bus, MCR[HALT] and MCR[FRZ] are set, the internal state machines are disabled, then MCR[FRZACK] and MCR[NOTRDY] are set. The Tx pin is in recessive state and FlexCAN does not initiate any transmission or reception of CAN frames. Note that the message buffers and the Rx Individual Mask registers are not affected by reset, so they are not automatically initialized.

55.3.13 Interrupts

The module has many interrupt sources: interrupts due to message buffers and interrupts due to the ORed interrupts from MBs, Bus Off, Bus Off Done, Error, Error Fast (errors detected in the data phase of CAN FD format messages with the BRS bit set), Wake Up Match, Wake Up Timeout, Tx Warning, and Rx Warning.

Each one of the message buffers can be an interrupt source, if its corresponding IMASK bit is set. There is no distinction between Tx and Rx interrupts for a particular buffer, under the assumption that the buffer is initialized for either transmission or reception. Each of the buffers has an assigned flag bit in the IFLAG registers. The bit is set when the corresponding buffer completes a successful transfer and is cleared when the CPU writes one to it (unless another interrupt is generated at the same time).

Note

It must be guaranteed that the CPU clears only the bit causing the current interrupt. For this reason, bit manipulation instructions (BSET) must not be used to clear interrupt flags. These instructions may cause accidental clearing of interrupt flags which are set after entering the current interrupt service routine.

If the Rx FIFO is enabled ($MCR[RFEN] = 1$) and DMA is disabled ($MCR[DMA] = 0$), the interrupts corresponding to MBs 0 to 7 have different meanings. Bit 7 of the IFLAG1 register becomes the "FIFO Overflow" flag; bit 6 becomes the "FIFO Warning" flag, bit 5 becomes the "Frames Available in FIFO" flag and bits 4-0 are unused. See the description of [Interrupt Flags 1 Register \(IFLAG1\)](#) for more information.

If both Rx FIFO and DMA are enabled ($MCR[RFEN]$ and $MCR[DMA] = 1$) the FlexCAN does not generate any FIFO interrupt. Bit 5 of the IFLAG1 register still indicates "Frames Available in FIFO" and generates a DMA request. Bits 7, 6, 4-0 are unused.

CAUTION

FIFO cannot be enabled when CAN FD feature is enabled.

For a combined interrupt where multiple MB interrupt sources are OR'd together, the interrupt is generated when any of the associated MBs (or FIFO, if applicable) generates an interrupt. In this case, the CPU must read the IFLAG registers to determine which MB or FIFO source caused the interrupt.

The following interrupt sources generate interrupts like the MB interrupt sources, and can be read from ESR1 register

- Bus Off
- Bus Off Done
- Error
- Error Fast
- Tx Warning
- Rx Warning

The Bus Off, Error, Tx Warning, and Rx Warning interrupt mask bits are located in the CTRL1 register.

The interrupt sources for Pretended Networking (Wake up by Match Flag and Wake up by Timeout Flag) can be read in the WU_MTC register and the respective interrupt mask bits are located in CTRL1_PN register.

55.3.14 Bus interface

CPU access to FlexCAN registers is subject to the following rules:

- Unrestricted read and write access to supervisor registers (registers identified with S/U in [Table 55-21](#) in Supervisor Mode or with S only) results in an access error.
- Read and write access to implemented reserved address space results in an access error.
- Write access to positions whose bits are all currently read-only results in an access error. If at least one of the bits is not read-only then no access error is issued. Write permission to positions or some of their bits can change depending on the mode of operation or transitory state. See register and field descriptions for details.
- Read and write access to unimplemented address space results in access error.
- Read and write access to RAM located positions during Low Power mode results in an access error.
- It is possible for the RXIMR memory region to be considered as general purpose memory and available for access. There are two ways of doing this:
 - a. If MCR[IRMQ] is cleared, the individual masks (RXIMR) are disabled. In this case the RXIMR memory region is considered as general purpose memory.
 - b. If MCR[MAXMB] is programmed with a value smaller than the available number of MBs, then the unused memory space can be used as general purpose RAM space. Note that reserved words within RAM cannot be used. As an example, suppose FlexCAN's RAM can support up to 16 MBs, CTRL2[RFFN] is 0h, and MCR[MAXMB] is programmed with zero. The maximum number of MBs in this case becomes one. The RAM starts at 0080h, and the space 0080h–008Fh is used by the one MB. The memory space 0090h–017Fh is available. The space 0180h–087Fh is reserved. The space 0880h–0883h is used by the one individual mask and the available memory in the mask registers space would be 0884h–08BFh. From 08C0h–09DFh there are reserved words for internal use which cannot be used as general purpose RAM. As a general rule, free memory space for general purpose depends only on MAXMB.
 - c. If MCR[FDEN] is enabled, general purpose memory can be used out of Freeze mode only.

Table 55-19. Access permissions

Supervisor access	0				1		
Supervisor mode - MCR[SUPV] = 1	0			1	any		
Modes of operation	Normal	Freeze	Low power	*	Normal	Freeze	Low power
MCR	bus error	bus error	bus error	bus error	read/write	read/write	read/write
CTRL1	read/write	read write	read/write	bus error	read/write	read/write	read/write

Table continues on the next page...

Table 55-19. Access permissions (continued)

Supervisor access	0				1		
Supervisor mode - MCR[SUPV] = 1	0			1	any		
Modes of operation	Normal	Freeze	Low power	*	Normal	Freeze	Low power
TIMER	read/write	read/write	read/write	bus error	read/write	read/write	read/write
TCR	bus error	bus error	bus error	bus error	bus error	bus error	bus error
RXMGMASK ¹	bus error for write operation	read/write	bus error for write operation	bus error	bus error for write operation	read/write	bus error for write operation
RX14MASK ¹	bus error for write operation	read/write	bus error for write operation	bus error	bus error for write operation	read/write	bus error for write operation
RX15MASK ¹	bus error for write operation	read/write	bus error for write operation	bus error	bus error for write operation	read/write	bus error for write operation
ECR	bus error for write operation	read/write	bus error for write operation	bus error	bus error for write operation	read/write	bus error for write operation
ESR1	read/write	read/write	read/write	bus error	read/write	read/write	read/write
IMASK1	read/write	read/write	read/write	bus error	read/write	read/write	read/write
IFLAG1	read/write	read/write	read/write	bus error	read/write	read/write	read/write
CTRL2	read/write	read/write	read/write	bus error	read/write	read/write	read/write
ESR2	read/write	read/write	read/write	bus error	read/write	read/write	read/write
CRCR	bus error for write operation	bus error for write operation	bus error for write operation	bus error	bus error for write operation	bus error for write operation	bus error for write operation
RXFGMASK ¹	bus error for write operation	read/write	bus error for write operation	bus error	bus error for write operation	read/write	bus error for write operation
RXFIR ¹	bus error for write operation	bus error for write operation	bus error for write operation	bus error	bus error for write operation	bus error for write operation	bus error for write operation
CBT	bus error for write operation	read/write	bus error for write operation	bus error	bus error for write operation	read/write	bus error for write operation
DBG1	bus error for write operation	bus error for write operation	bus error for write operation	bus error for write operation	bus error for write operation	bus error for write operation	bus error for write operation
DBG2	bus error for write operation	bus error for write operation	bus error for write operation	bus error for write operation	bus error for write operation	bus error for write operation	bus error for write operation
MB ^{1, 2}	read/write	read/write	read/write	bus error	read/write	read/write	read/write
FIFO header ¹	read/write	read/write	read/write	bus error	read/write	read/write	read/write
FIFO reserved space ¹	bus error	bus error	bus error	bus error	bus error	bus error	bus error
FIFO filters ¹	read/write	read/write	read/write	bus error	read/write	read/write	read/write
RXIMR ¹	bus error	read/write	bus error	bus error	bus error	read/write	bus error

Table continues on the next page...

Table 55-19. Access permissions (continued)

Supervisor access	0				1		
Supervisor mode - MCR[SUPV] = 1	0			1	any		
Modes of operation	Normal	Freeze	Low power	*	Normal	Freeze	Low power
CTRL1_PN	read/write ³	read/write	read/write ³	bus error	read/write ³	read/write	read/write ³
CTRL2_PN	read/write ³	read/write	read/write ³	bus error	read/write ³	read/write	read/write ³
WU_MTC	read/write	read/write	read/write	bus error	read/write	read/write	read/write
FLT_ID1	read/write ³	read/write	read/write ³	bus error	read/write ³	read/write	read/write ³
FLT_DLC	read/write ³	read/write	read/write ³	bus error	read/write ³	read/write	read/write ³
PL1_LO	read/write ³	read/write	read/write ³	bus error	read/write ³	read/write	read/write ³
PL1_HI	read/write ³	read/write	read/write ³	bus error	read/write ³	read/write	read/write ³
FLT_ID2_IDMASK	read/write ³	read/write	read/write ³	bus error	read/write ³	read/write	read/write ³
PL2_PLMASK_LO	read/write ³	read/write	read/write ³	bus error	read/write ³	read/write	read/write ³
PL2_PLMASK_HI	read/write ³	read/write	read/write ³	bus error	read/write ³	read/write	read/write ³
WMB0	read/write ³	read/write ³	read/write ³	bus error	read/write ³	read/write ³	read/write ³
WMB1	read/write ³	read/write ³	read/write ³	bus error	read/write ³	read/write ³	read/write ³
WMB2	read/write ³	read/write ³	read/write ³	bus error	read/write ³	read/write ³	read/write ³
WMB3	read/write ³	read/write ³	read/write ³	bus error	read/write ³	read/write	read/write ³
FDCTRL	read/write	read/write	read/write	bus error	read/write	read/write	read/write
FDCBT	read/write ³	read/write	read/write ³	bus error	read/write ³	read/write	read/write ³
FDCRC	bus error for write operation	bus error for write operation	bus error for write operation	bus error	bus error for write operation	bus error for write operation	bus error for write operation
General purpose RAM ¹	read/write	read/write	read/write	bus error	read/write	read/write	read/write
Reserved space (used) ¹	bus error	bus error	bus error	bus error	bus error	bus error	bus error
Reserved space (empty) ¹	bus error	bus error	bus error	bus error	bus error	bus error	bus error

1. Access in low power is only possible if RAM_clk and ipg_clk are enabled.
2. If MCR[RFEN] = 1, see FIFO access rules below.
3. Write operation has no effect.

55.4 FlexCAN signal descriptions

The FlexCAN module has two I/O signals connected to the external chip pins. These signals are summarized in the following table and described in more detail in the next subsections.

Table 55-20. FlexCAN signal descriptions

Signal	Description	I/O
CAN Rx	CAN receive pin	Input
CAN Tx	CAN transmit pin	Output

55.4.1 CAN Rx

This pin is the receive pin from the CAN bus transceiver. Dominant state is represented by logic level 0. Recessive state is represented by logic level 1.

55.4.2 CAN Tx

This pin is the transmit pin to the CAN bus transceiver. Dominant state is represented by logic level 0. Recessive state is represented by logic level 1.

55.5 Memory map/register definition

This section describes the registers and data structures in the FlexCAN module. The base address of the module depends on the particular memory map of the chip.

55.5.1 FlexCAN memory mapping

The address space occupied by FlexCAN has 128 bytes for registers starting at the module base address, followed by embedded RAM starting at address offset 0080h.

Each individual register is identified by its complete name and the corresponding mnemonic. The access type can be Supervisor (S) or Unrestricted (U). Most of the registers can be configured to have either Supervisor or Unrestricted access by programming MCR[SUPV]. These registers are identified as S/U in the Access column of [Table 55-21](#).

NOTE

An invalid register access will result in a bus error. This includes reading a write-only register, writing a read-only register, or accessing an invalid address.

Table 55-21. Register access and reset information

Register	Access type	Affected by hard reset	Affected by soft reset
Module Configuration Register (MCR)	S	Yes	Yes
Control 1 Register (CTRL1)	S/U	Yes	No
Free Running Timer Register (TIMER)	S/U	Yes	Yes

Table continues on the next page...

Table 55-21. Register access and reset information (continued)

Register	Access type	Affected by hard reset	Affected by soft reset
Rx Mailboxes Global Mask Register (RXMGMASK)	S/U	No	No
Rx Buffer 14 Mask Register (RX14MASK)	S/U	No	No
Rx Buffer 15 Mask Register (RX15MASK)	S/U	No	No
Error Counter Register (ECR)	S/U	Yes	Yes
Error and Status 1 Register (ESR1)	S/U	Yes	Yes
Interrupt Masks 1 Register (IMASK1)	S/U	Yes	Yes
Interrupt Flags 1 Register (IFLAG1)	S/U	Yes	Yes
Control 2 Register (CTRL2)	S/U	Yes	No
Error and Status 2 Register (ESR2)	S/U	Yes	Yes
CRC Register (CRCR)	S/U	Yes	Yes
Rx FIFO Global Mask Register (RXFGMASK)	S/U	No	No
Rx FIFO Information Register (RXFIR)	S/U	No	No
CAN Bit Timing Register (CBT)	S/U	Yes	No
Message buffers	S/U	No	No
Rx Individual Mask Registers	S/U	No	No
Pretended Networking Control 1 Register (CTRL1_PN)	S/U	Yes	Yes
Pretended Networking Control 2 Register (CTRL2_PN)	S/U	Yes	Yes
Pretended Networking Wake Up Match Register (WU_MTC)	S/U	Yes	Yes
Pretended Networking ID Filter 1 Register (FLT_ID1)	S/U	Yes	Yes
Pretended Networking DLC Filter Register (FLT_DLC)	S/U	Yes	Yes
Pretended Networking Payload Low Filter 1 Register (PL1_LO)	S/U	Yes	Yes
Pretended Networking Payload High Filter 1 Register (PL1_HI)	S/U	Yes	Yes
Pretended Networking ID Filter 2 Register / ID Mask Register (FLT_ID2_IDMASK)	S/U	Yes	Yes
Pretended Networking Payload Low Filter 2 Register / Payload Low Mask Register (PL2_PLMASK_LO)	S/U	Yes	Yes
Pretended Networking Payload High Filter 2 Register / Payload High Mask Register (PL2_PLMASK_HI)	S/U	Yes	Yes
Pretended Networking Wake Up Message Buffer 0 Register (WMB0)	S/U	Yes	No
Pretended Networking Wake Up Message Buffer 1 Register (WMB1)	S/U	Yes	No
Pretended Networking Wake Up Message Buffer 2 Register (WMB2)	S/U	Yes	No
Pretended Networking Wake Up Message Buffer 3 Register (WMB3)	S/U	Yes	No
CAN FD Control Register (FDCTRL)	S/U	Yes	No
CAN FD Bit Timing Register (FDCBT)	S/U	Yes	No
CAN FD CRC Register (FDCRC)	S/U	Yes	Yes

The FlexCAN module can store CAN messages for transmission and reception using mailboxes and Rx FIFO structures.

55.5.2 CAN register descriptions

The table below shows the FlexCAN memory map.

The address range from offset 80h–27Fh allocates the thirty-two 128-bit message buffers (MBs).

The memory maps for the message buffers are in [FlexCAN message buffer memory map](#).

55.5.2.1 CAN memory map

FlexCAN0 base address: 4002_4000h

FlexCAN1 base address: 4002_5000h

FlexCAN2 base address: 4002_B000h

Offset	Register	Width (In bits)	Access	Reset value
0h	Module Configuration Register (MCR)	32	RW	D890_000Fh
4h	Control 1 Register (CTRL1)	32	RW	0000_0000h
8h	Free Running Timer (TIMER)	32	RW	0000_0000h
10h	Rx Mailboxes Global Mask Register (RXMGMASK)	32	RW	Table 55-21
14h	Rx 14 Mask Register (RX14MASK)	32	RW	Table 55-21
18h	Rx 15 Mask Register (RX15MASK)	32	RW	Table 55-21
1Ch	Error Counter (ECR)	32	RW	0000_0000h
20h	Error and Status 1 Register (ESR1)	32	R2C	0000_0000h
28h	Interrupt Masks 1 Register (IMASK1)	32	RW	0000_0000h
30h	Interrupt Flags 1 Register (IFLAG1)	32	W1C	0000_0000h
34h	Control 2 Register (CTRL2)	32	RW	00A0_0000h
38h	Error and Status 2 Register (ESR2)	32	RO	0000_0000h
44h	CRC Register (CRCR)	32	RO	0000_0000h
48h	Rx FIFO Global Mask Register (RXFGMASK)	32	RW	Table 55-24
4Ch	Rx FIFO Information Register (RXFIR)	32	RO	Table 55-24
50h	CAN Bit Timing Register (CBT)	32	RW	0000_0000h
880h - 8FCh	Rx Individual Mask Registers (RXIMR0 - RXIMR31)	32	RW	Table 55-24
B00h	Pretended Networking Control 1 Register (CTRL1_PN)	32	RW	0000_0100h
B04h	Pretended Networking Control 2 Register (CTRL2_PN)	32	RW	0000_0000h
B08h	Pretended Networking Wake Up Match Register (WU_MTC)	32	W1C	0000_0000h

Table continues on the next page...

Memory map/register definition

Offset	Register	Width (In bits)	Access	Reset value
B0Ch	Pretended Networking ID Filter 1 Register (FLT_ID1)	32	RW	0000_0000h
B10h	Pretended Networking DLC Filter Register (FLT_DLC)	32	RW	0000_0008h
B14h	Pretended Networking Payload Low Filter 1 Register (PL1_LO)	32	RW	0000_0000h
B18h	Pretended Networking Payload High Filter 1 Register (PL1_HI)	32	RW	0000_0000h
B1Ch	Pretended Networking ID Filter 2 Register / ID Mask Register (FLT_ID2_IDMASK)	32	RW	0000_0000h
B20h	Pretended Networking Payload Low Filter 2 Register / Payload Low Mask register (PL2_PLMASK_LO)	32	RW	0000_0000h
B24h	Pretended Networking Payload High Filter 2 low order bits / Payload High Mask register (PL2_PLMASK_HI)	32	RW	0000_0000h
B40h	Wake Up Message Buffer register for C/S (WMB0_CS)	32	RO	0000_0000h
B44h	Wake Up Message Buffer Register for ID (WMB0_ID)	32	RO	0000_0000h
B48h	Wake Up Message Buffer Register for Data 0-3 (WMB0_D03)	32	RO	0000_0000h
B4Ch	Wake Up Message Buffer Register Data 4-7 (WMB0_D47)	32	RO	0000_0000h
B50h	Wake Up Message Buffer register for C/S (WMB1_CS)	32	RO	0000_0000h
B54h	Wake Up Message Buffer Register for ID (WMB1_ID)	32	RO	0000_0000h
B58h	Wake Up Message Buffer Register for Data 0-3 (WMB1_D03)	32	RO	0000_0000h
B5Ch	Wake Up Message Buffer Register Data 4-7 (WMB1_D47)	32	RO	0000_0000h
B60h	Wake Up Message Buffer register for C/S (WMB2_CS)	32	RO	0000_0000h
B64h	Wake Up Message Buffer Register for ID (WMB2_ID)	32	RO	0000_0000h
B68h	Wake Up Message Buffer Register for Data 0-3 (WMB2_D03)	32	RO	0000_0000h
B6Ch	Wake Up Message Buffer Register Data 4-7 (WMB2_D47)	32	RO	0000_0000h
B70h	Wake Up Message Buffer register for C/S (WMB3_CS)	32	RO	0000_0000h
B74h	Wake Up Message Buffer Register for ID (WMB3_ID)	32	RO	0000_0000h
B78h	Wake Up Message Buffer Register for Data 0-3 (WMB3_D03)	32	RO	0000_0000h
B7Ch	Wake Up Message Buffer Register Data 4-7 (WMB3_D47)	32	RO	0000_0000h
C00h	CAN FD Control Register (FDCTRL)	32	RW	8000_0100h
C04h	CAN FD Bit Timing Register (FDCBT)	32	RW	0000_0000h
C08h	CAN FD CRC Register (FDCRC)	32	RO	0000_0000h

55.5.2.2 Module Configuration Register (MCR)

55.5.2.2.1 Offset

Register	Offset
MCR	0h

55.5.2.2.2 Function

This register defines global system configurations, such as the module operation modes and the maximum message buffer configuration.

55.5.2.2.3 Diagram

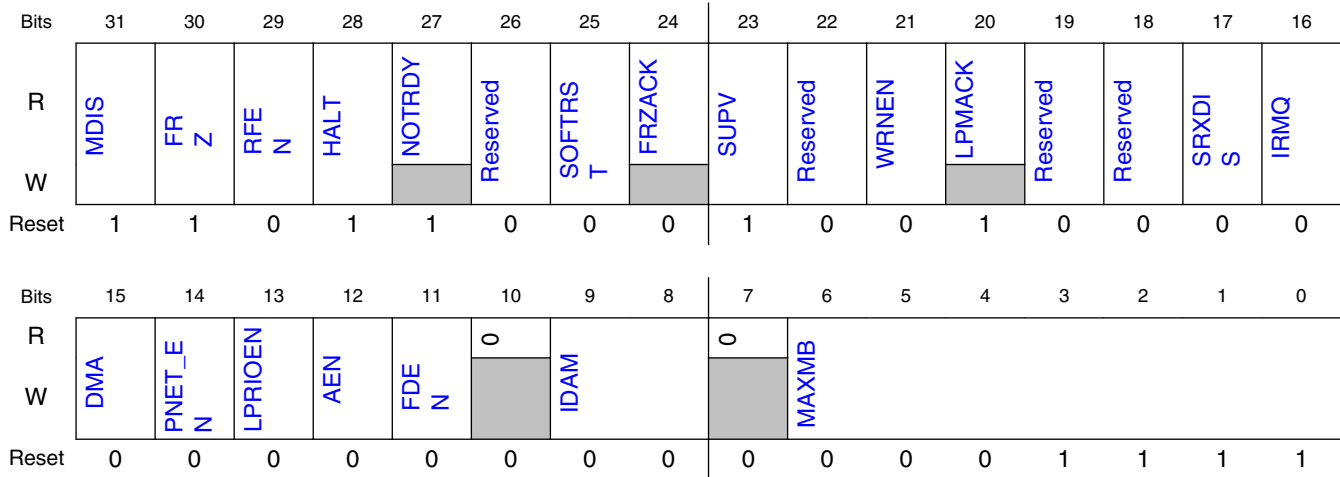

55.5.2.2.4 Fields

Field	Function
31 MDIS	Module Disable This bit controls whether FlexCAN is enabled or not. When disabled, FlexCAN disables the clocks to the CAN Protocol Engine and Controller Host Interface submodules. This bit is not affected by soft reset. 0b - Enable the FlexCAN module. 1b - Disable the FlexCAN module.
30 FRZ	Freeze Enable The FRZ bit specifies the FlexCAN behavior when MCR[HALT] is set or when Debug mode is requested at chip level. When FRZ is asserted, FlexCAN is enabled to enter Freeze mode. Negation of this bit field causes FlexCAN to exit from Freeze mode. 0b - Not enabled to enter Freeze mode. 1b - Enabled to enter Freeze mode.
29 RFEN	Rx FIFO Enable This bit controls whether the Rx FIFO feature is enabled or not. When RFEN is set, MBs 0 to 5 cannot be used for normal reception and transmission because the corresponding memory region (80h–DCh) is used by the FIFO engine as well as additional MBs (up to 32, depending on CTRL2[RFFN] setting) which are used as Rx FIFO ID filter table elements. RFEN also impacts the definition of the minimum number of peripheral clocks per CAN bit as described in Table 55-16 . This bit can be written in Freeze mode only, because it is blocked by hardware in other modes. NOTE: This bit cannot be set when CAN FD operation is enabled (see FDEN bit). 0b - Rx FIFO not enabled. 1b - Rx FIFO enabled.
28	Halt FlexCAN

Table continues on the next page...

Memory map/register definition

Field	Function
HALT	Assertion of this bit puts the FlexCAN module into Freeze mode. The CPU should clear it after initializing the message buffers and the Control registers CTRL1 and CTRL2. No reception or transmission is performed by FlexCAN before this bit is cleared. Freeze mode cannot be entered when FlexCAN is in a low power mode. 0b - No Freeze mode request. 1b - Enters Freeze mode if the FRZ bit is asserted.
27 NOTRDY	FlexCAN Not Ready This read-only bit indicates that FlexCAN is either in Disable mode, Stop mode or Freeze mode. It is negated when FlexCAN has exited these modes. This bit is not affected by soft reset. 0b - FlexCAN module is either in Normal mode, Listen-Only mode, or Loop-Back mode. 1b - FlexCAN module is either in Disable mode, Stop mode, or Freeze mode.
26 —	Reserved When writing to this field, always write the reset value.
25 SOFTRST	Soft Reset When SOFTRST is asserted, FlexCAN resets its internal state machines and some of the memory-mapped registers. SOFTRST can be asserted directly by the CPU when it writes to the MCR register. Because soft reset is synchronous and has to follow a request/acknowledge procedure across clock domains, it may take some time to fully propagate its effect. The SOFTRST bit remains asserted when reset is pending, and is automatically negated when reset completes. Therefore, software can poll this bit to know when the soft reset has completed. Soft reset cannot be applied when clocks are shut down in a low power mode. The module should be first removed from low power mode, and then soft reset can be applied. This bit is not affected by soft reset. 0b - No reset request. 1b - Resets the registers affected by soft reset.
24 FRZACK	Freeze Mode Acknowledge This read-only bit indicates that FlexCAN is in Freeze mode and its prescaler is stopped. The Freeze mode request cannot be granted until current transmission or reception processes have finished. Therefore the software can poll the FRZACK bit to know when FlexCAN has actually entered Freeze mode. If Freeze mode request is negated, then this bit is negated after the FlexCAN prescaler is running again. If Freeze mode is requested when FlexCAN is in a low power mode, then the FRZACK bit will be set only when the low-power mode is exited. See Freeze mode . This bit is not affected by soft reset. NOTE: FRZACK will be asserted within 178 CAN bits from the Freeze mode request by the CPU, and negated within 2 CAN bits after the Freeze mode request removal (see Protocol timing). 0b - FlexCAN not in Freeze mode, prescaler running. 1b - FlexCAN in Freeze mode, prescaler stopped.
23 SUPV	Supervisor Mode This bit configures the FlexCAN to be either in Supervisor or User mode. The registers affected by this bit are marked as S/U in the "Access type" column of Table 55-21 . Reset value of this bit is 1, so the affected registers start with Supervisor access allowance only. This bit can be written only in Freeze mode because it is blocked by hardware in other modes. 0b - FlexCAN is in User mode. Affected registers allow both Supervisor and Unrestricted accesses. 1b - FlexCAN is in Supervisor mode. Affected registers allow only Supervisor access. Unrestricted access behaves as though the access was done to an unimplemented register location.
22 —	Reserved When writing to this field, always write the reset value.
21 WRNEN	Warning Interrupt Enable When asserted, this bit enables the generation of the TWRNINT and RWRNINT flags in the Error and Status Register 1 (ESR1). If WRNEN is negated, the TWRNINT and RWRNINT flags will always be zero,

Table continues on the next page...

Field	Function
	independent of the values of the error counters, and no warning interrupt will ever be generated. This bit can be written in Freeze mode only, because it is blocked by hardware in other modes. 0b - TWRNINT and RWRNINT bits are zero, independent of the values in the error counters. 1b - TWRNINT and RWRNINT bits are set when the respective error counter transitions from less than 96 to greater than or equal to 96.
20 LPMACK	Low-Power Mode Acknowledge This read-only bit indicates that FlexCAN is in a low-power mode (Disable mode, Stop mode). A low-power mode cannot be entered until all current transmission or reception processes have finished, so the CPU can poll the LPMACK bit to know when FlexCAN has actually entered low power mode. This bit is not affected by soft reset. NOTE: LPMACK will be asserted within 180 CAN bits from the low-power mode request by the CPU, and negated within 2 CAN bits after the low-power mode request removal (see Protocol timing). When FlexCAN is in Pretended Networking mode LPMACK will be negated within 180 CAN bits after the low-power mode request removal. 0b - FlexCAN is not in a low-power mode. 1b - FlexCAN is in a low-power mode.
19 —	Reserved When writing to this field, always write the reset value.
18 —	Reserved When writing to this field, always write the reset value.
17 SRXDIS	Self Reception Disable This bit defines whether FlexCAN is allowed to receive frames transmitted by itself. If this bit is asserted, frames transmitted by the module will not be stored in any MB, regardless if the MB is programmed with an ID that matches the transmitted frame, and no interrupt flag or interrupt signal will be generated due to the frame reception. This bit can be written only in Freeze mode because it is blocked by hardware in other modes. 0b - Self-reception enabled. 1b - Self-reception disabled.
16 IRMQ	Individual Rx Masking And Queue Enable This bit indicates whether Rx matching process will be based either on individual masking and queue or on masking scheme with RXMGMASK, RX14MASK, RX15MASK, and RXFGMASK. This bit can be written in Freeze mode only because it is blocked by hardware in other modes. 0b - Individual Rx masking and queue feature are disabled. For backward compatibility with legacy applications, the reading of C/S word locks the MB even if it is EMPTY. 1b - Individual Rx masking and queue feature are enabled.
15 DMA	DMA Enable DMA controls whether the DMA feature is enabled or not. The DMA feature can only be used in Rx FIFO, so consequently MCR[RFEN] must be asserted. When DMA and RFEN are set, IFLAG1[BUF5I] generates the DMA request and no RX FIFO interrupt is generated. This bit can be written in Freeze mode only as it is blocked by hardware in other modes. 0b - DMA feature for RX FIFO disabled. 1b - DMA feature for RX FIFO enabled.
14 PNET_EN	Pretended Networking Enable This bit enables the Pretended Networking functionality. When in Stop mode, PE sub-block is kept operational, making it able to process Rx message filtering as defined by the Pretended Networking configuration registers. See Receive process under Pretended Networking mode . This bit can be written in Freeze mode only. NOTE: This field is not supported in every instance. The following table includes only supported registers.

Table continues on the next page...

Memory map/register definition

Field	Function		
	Instance	Field supported in	Field not supported in
	FlexCAN0	MCR	—
	FlexCAN1	—	MCR
	FlexCAN2	—	MCR
	0b - Pretended Networking mode is disabled. 1b - Pretended Networking mode is enabled.		
13 LPRIEN	Local Priority Enable This bit is provided for backwards compatibility with legacy applications. It controls whether the local priority feature is enabled or not. It is used to expand the ID used during the arbitration process. With this expanded ID concept, the arbitration process is done based on the full 32-bit word, but the actual transmitted ID still has 11-bit for standard frames and 29-bit for extended frames. This bit can be written only in Freeze mode because it is blocked by hardware in other modes. 0b - Local Priority disabled. 1b - Local Priority enabled.		
12 AEN	Abort Enable When asserted, this bit enables the Tx abort mechanism. This mechanism guarantees a safe procedure for aborting a pending transmission, so that no frame is sent in the CAN bus without notification. This bit can be written only in Freeze mode because it is blocked by hardware in other modes. NOTE: When MCR[AEN] is asserted, only the abort mechanism (see Transmission abort mechanism) must be used for updating mailboxes configured for transmission. CAUTION: Writing the Abort code into Rx mailboxes can cause unpredictable results when MCR[AEN] is asserted. 0b - Abort disabled. 1b - Abort enabled.		
11 FDEN	CAN FD operation enable This bit enables the CAN with Flexible Data rate (CAN FD) operation. This bit can be written in Freeze mode only. NOTE: FlexCAN is able to transmit FD frame format according to ISO 11898-1. NOTE: The Rx FIFO Enable (RFEN) bit cannot be set if FDEN is asserted. 0b - CAN FD is disabled. FlexCAN is able to receive and transmit messages in CAN 2.0 format. 1b - CAN FD is enabled. FlexCAN is able to receive and transmit messages in both CAN FD and CAN 2.0 formats.		
10 —	Reserved		
9-8 IDAM	ID Acceptance Mode This 2-bit field identifies the format of the Rx FIFO ID filter table elements. Note that all elements of the table are configured at the same time by this field (they are all the same format). See Rx FIFO structure . This field can be written only in Freeze mode because it is blocked by hardware in other modes. 00b - Format A: One full ID (standard and extended) per ID filter table element. 01b - Format B: Two full standard IDs or two partial 14-bit (standard and extended) IDs per ID filter table element. 10b - Format C: Four partial 8-bit standard IDs per ID filter table element. 11b - Format D: All frames rejected.		
7 —	Reserved		

Table continues on the next page...

Field	Function
6-0 MAXMB	<p>Number Of The Last Message Buffer</p> <p>This 7-bit field defines the number of the last message buffers that will take part in the matching and arbitration processes. The reset value (0Fh) is equivalent to a 16 MB configuration. This field can be written only in Freeze mode because it is blocked by hardware in other modes.</p> <p>Number of the last MB = MAXMB</p> <p>NOTE: MAXMB must be programmed with a value smaller than or equal to the number of available message buffers, as described in FlexCAN memory partition for CAN FD.</p> <p>Additionally, the definition of MAXMB value must take into account the region of MBs occupied by Rx FIFO and its ID filters table space defined by CTRL2[RFFN]. MAXMB also impacts the definition of the minimum number of peripheral clocks per CAN bit as described in Table 55-16.</p>

55.5.2.3 Control 1 Register (CTRL1)

55.5.2.3.1 Offset

Register	Offset
CTRL1	4h

55.5.2.3.2 Function

This Register is defined for specific FlexCAN control features related to the CAN bus, such as bit rate, programmable sampling point within an Rx bit, Loop Back mode, Listen-Only mode, Bus Off recovery behavior, and interrupt enabling (Bus-Off, Error, Warning). It also determines the division factor for the clock prescaler.

The CAN bit timing variables (PRES DIV, PROPSEG, PSEG1, PSEG2, and RJW) can also be configured in the CBT register, which extends the range of all these variables. If CBT[BTF] is set, PRES DIV, PROPSEG, PSEG1, PSEG2, and RJW fields of CTRL1 become read only.

NOTE

When the CAN FD feature is enabled, do not use the PRES DIV, RJW, PSEG1, PSEG2, and PROPSEG fields of the CTRL1 register for CAN bit timing. Instead use the CBT register's EPRES DIV, ERJW, EPSEG1, EPSEG2, and EPROPSEG fields.

NOTE

The CAN bit variables in CTRL1 and in CBT are stored in the same register.

The contents of this register are not affected by soft reset.

55.5.2.3.3 Diagram

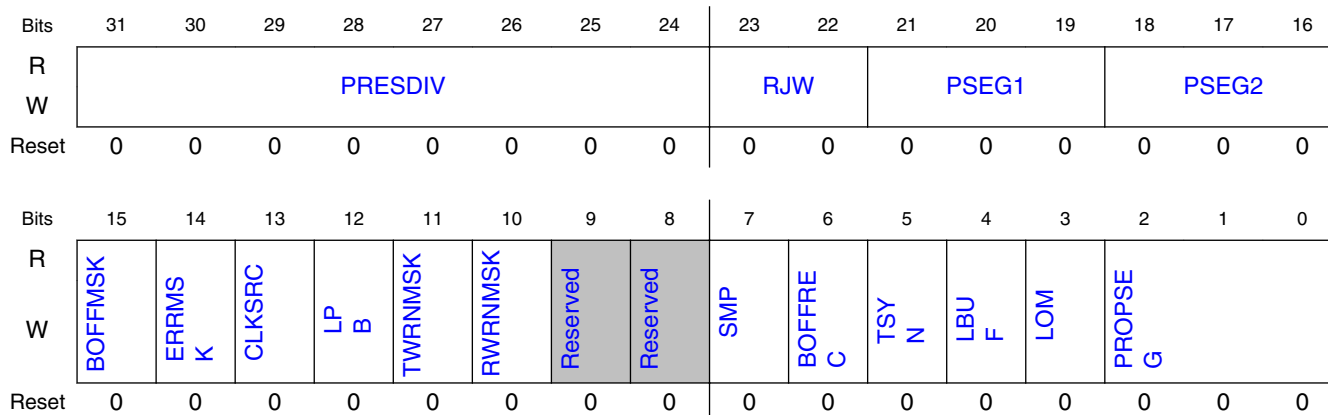

55.5.2.3.4 Fields

Field	Function
31-24 PRESDIV	<p>Prescaler Division Factor</p> <p>This 8-bit field defines the ratio between the PE clock frequency and the serial clock (Sclock) frequency. The Sclock period defines the time quantum of the CAN protocol. For the reset value, the Sclock frequency is equal to the PE clock frequency. The maximum value of this field is FFh, which gives a minimum Sclock frequency equal to the PE clock frequency divided by 256. See Protocol timing for more information. This field can be written only in Freeze mode because it is blocked by hardware in other modes.</p> <p>Sclock frequency = PE clock frequency / (PRESDIV + 1).</p>
23-22 RJW	<p>Resync Jump Width</p> <p>This 2-bit field defines the maximum number of time quanta that a bit time can be changed by one resynchronization. One time quantum is equal to the Sclock period. The valid programmable values are 0–3. See Protocol timing for more information. This field can be written only in Freeze mode because it is blocked by hardware in other modes.</p> <p>Resync Jump Width = RJW + 1.</p>
21-19 PSEG1	<p>Phase Segment 1</p> <p>This 3-bit field defines the length of phase segment 1 in the bit time. The valid programmable values are 0–7. See Protocol timing for more information. This field can be written only in Freeze mode because it is blocked by hardware in other modes.</p> <p>Phase Buffer Segment 1 = (PSEG1 + 1) × Time-Quanta.</p>
18-16 PSEG2	<p>Phase Segment 2</p>

Table continues on the next page...

Field	Function
	<p>This 3-bit field defines the length of phase segment 2 in the bit time. The valid programmable values are 1–7. See Protocol timing for more information. This field can be written only in Freeze mode because it is blocked by hardware in other modes.</p> <p>Phase Buffer Segment 2 = (PSEG2 + 1) × Time-Quanta.</p>
15 BOFFMSK	<p>Bus Off Interrupt Mask</p> <p>This bit provides a mask for the Bus Off interrupt ESR1[BOFFINT].</p> <p>0b - Bus Off interrupt disabled. 1b - Bus Off interrupt enabled.</p>
14 ERRMSK	<p>Error Interrupt Mask</p> <p>This bit provides a mask for the Error interrupt ESR1[ERRINT].</p> <p>0b - Error interrupt disabled. 1b - Error interrupt enabled.</p>
13 CLKSRC	<p>CAN Engine Clock Source</p> <p>This bit selects the clock source to the CAN Protocol Engine (PE) to be either the peripheral clock or the oscillator clock. The selected clock is the one fed to the prescaler to generate the serial clock (Sclk). In order to guarantee reliable operation, this bit can be written only in Disable mode because it is blocked by hardware in other modes. See Protocol timing.</p> <p>NOTE: The user must ensure the protocol engine clock tolerance according to the CAN Protocol standard (ISO 11898-1).</p> <p>NOTE: See the clock distribution chapter (module clocks table) to identify the proper clock source.</p> <p>0b - The CAN engine clock source is the oscillator clock. Under this condition, the oscillator clock frequency must be lower than the bus clock. 1b - The CAN engine clock source is the peripheral clock.</p>
12 LPB	<p>Loop Back Mode</p> <p>This bit configures FlexCAN to operate in Loop-Back mode. In this mode, FlexCAN performs an internal loop back that can be used for self-test operation. The bit stream output of the transmitter is fed back internally to the receiver input. The Rx CAN input pin is ignored and the Tx CAN output goes to the recessive state (logic 1). FlexCAN behaves as it normally does when transmitting, and treats its own transmitted message as a message received from a remote node.</p> <p>In this mode, FlexCAN ignores the bit sent during the ACK slot in the CAN frame acknowledge field, generating an internal acknowledge bit to ensure proper reception of its own message. Both transmit and receive interrupts are generated. This bit can be written only in Freeze mode because it is blocked by hardware in other modes.</p> <p>NOTE: In this mode, MCR[SRXDIS] cannot be asserted because this will impede the self-reception of a transmitted message.</p> <p>NOTE: FDCTRL[TDCEN] must be disabled when LPB is asserted.</p> <p>0b - Loop Back disabled. 1b - Loop Back enabled.</p>
11 TWRNMSK	<p>Tx Warning Interrupt Mask</p> <p>This bit provides a mask for the Tx Warning interrupt associated with the TWRNINT flag in the Error and Status Register 1 (ESR1). This bit is read as zero when MCR[WRNEN] is negated. This bit can be written only if MCR[WRNEN] is asserted.</p> <p>0b - Tx Warning interrupt disabled. 1b - Tx Warning interrupt enabled.</p>
10 RWRNMSK	<p>Rx Warning Interrupt Mask</p> <p>This bit provides a mask for the Rx Warning interrupt associated with the RWRNINT flag in the Error and Status Register 1 (ESR1). This bit is read as zero when MCR[WRNEN] bit is negated. This bit can be written only if MCR[WRNEN] bit is asserted.</p> <p>0b - Rx Warning interrupt disabled. 1b - Rx Warning interrupt enabled.</p>

Table continues on the next page...

Memory map/register definition

Field	Function
9 —	Reserved
8 —	Reserved
7 SMP	<p>CAN Bit Sampling</p> <p>This bit defines the sampling mode of CAN bits at the Rx input. It can be written in Freeze mode only, because it is blocked by hardware in other modes.</p> <p>NOTE: For proper operation, to assert SMP it is necessary to guarantee a minimum value of two TQs in CTRL1[PSEG1] (or CBT[EPSEG1]). This bit cannot be asserted when CAN FD is enabled (MCR[FDEN] = 1).</p> <p>0b - Just one sample is used to determine the bit value. 1b - Three samples are used to determine the value of the received bit: the regular one (sample point) and two preceding samples; a majority rule is used.</p>
6 BOFFREC	<p>Bus Off Recovery</p> <p>This bit defines how FlexCAN recovers from Bus Off state. If this bit is negated, automatic recovering from Bus Off state occurs according to the CAN Specification 2.0B. If the bit is asserted, automatic recovering from Bus Off is disabled and the module remains in Bus Off state until the bit is negated by the user. If the negation occurs before 128 sequences of 11 recessive bits are detected on the CAN bus, then Bus Off recovery happens as if the BOFFREC bit had never been asserted. If the negation occurs after 128 sequences of 11 recessive bits occurred, then FlexCAN will resynchronize to the bus by waiting for 11 recessive bits before joining the bus. After negation, the BOFFREC bit can be reasserted again during Bus Off, but it will be effective only the next time the module enters Bus Off. If BOFFREC was negated when the module entered Bus Off, asserting it during Bus Off will not be effective for the current Bus Off recovery.</p> <p>NOTE: See Bus off in the CAN Protocol standard (ISO 11898-1) for details.</p> <p>0b - Automatic recovering from Bus Off state enabled. 1b - Automatic recovering from Bus Off state disabled.</p>
5 TSYN	<p>Timer Sync</p> <p>This bit enables a mechanism that resets the free running timer each time a message is received in message buffer 0. This feature provides means to synchronize multiple FlexCAN stations with a special "SYNC" message, that is, global network time. If MCR[RFEN] is set (Rx FIFO enabled), the first available mailbox, according to CTRL2[RFFN] setting, is used for timer synchronization instead of MB0. This bit can be written in Freeze mode only because it is blocked by hardware in other modes.</p> <p>0b - Timer sync feature disabled 1b - Timer sync feature enabled</p>
4 LBUF	<p>Lowest Buffer Transmitted First</p> <p>This bit defines the ordering mechanism for message buffer transmission. When asserted, MCR[LPRIOEN] does not affect the priority arbitration. This bit can be written in Freeze mode only, because it is blocked by hardware in other modes.</p> <p>0b - Buffer with highest priority is transmitted first. 1b - Lowest number buffer is transmitted first.</p>
3 LOM	<p>Listen-Only Mode</p> <p>This bit configures FlexCAN to operate in Listen-Only mode. In this mode, transmission is disabled, all error counters described in the ECR register are frozen, and the module operates in a CAN Error Passive mode. Only messages acknowledged by another CAN station will be received. If FlexCAN detects a message that has not been acknowledged, it will flag a BIT0 error without changing the receive error counter (ECR[RXERRCNT]), as if it was trying to acknowledge the message.</p> <p>Listen-Only mode is acknowledged by the state of ESR1[FLTCONF] indicating Passive Error. There can be some delay between the Listen-Only mode request and acknowledge.</p>

Table continues on the next page...

Field	Function
	This bit can be written in Freeze mode only because it is blocked by hardware in other modes. 0b - Listen-Only mode is deactivated. 1b - FlexCAN module operates in Listen-Only mode.
2-0 PROPSEG	Propagation Segment This 3-bit field defines the length of the propagation segment in the bit time. The valid programmable values are 0–7. This field can be written only in Freeze mode because it is blocked by hardware in other modes. Propagation segment time = (PROPSEG + 1) × time-quanta. Time-quantum = one Sclock period.

55.5.2.4 Free Running Timer (TIMER)

55.5.2.4.1 Offset

Register	Offset
TIMER	8h

55.5.2.4.2 Function

This register represents a 16-bit free-running counter that can be read and written by the CPU. The timer starts from 0h after Reset, counts linearly to FFFFh, and wraps around.

When CTRL2[TIMER_SRC] is asserted, the timer is continuously incremented by an external time tick. The time tick must be synchronous to the peripheral clock, with a minimum pulse width of one clock cycle.

When CTRL2[TIMER_SRC] is negated, the timer is incremented by the CAN bit clock, which defines the baud rate on the CAN bus. During a message transmission/reception, it increments by one for each bit that is received or transmitted. When there is no message on the bus, it counts using the previously programmed baud rate. The timer is not incremented during Disable, Stop, Pretended Networking, and Freeze modes.

The timer value is captured when the second bit of the identifier field of any frame is on the CAN bus. This captured value is written into the time stamp entry in a message buffer after a successful reception or transmission of a message.

If CTRL1[TSYN] is asserted, the timer is reset whenever a message is received in the first available mailbox, according to CTRL2[RFFN] setting.

The CPU can write to this register anytime. However, if the write occurs at the same time that the timer is being reset by a reception in the first mailbox, then the write value is discarded.

Reading this register affects the mailbox unlocking procedure (see [Mailbox lock mechanism](#)).

55.5.2.4.3 Diagram

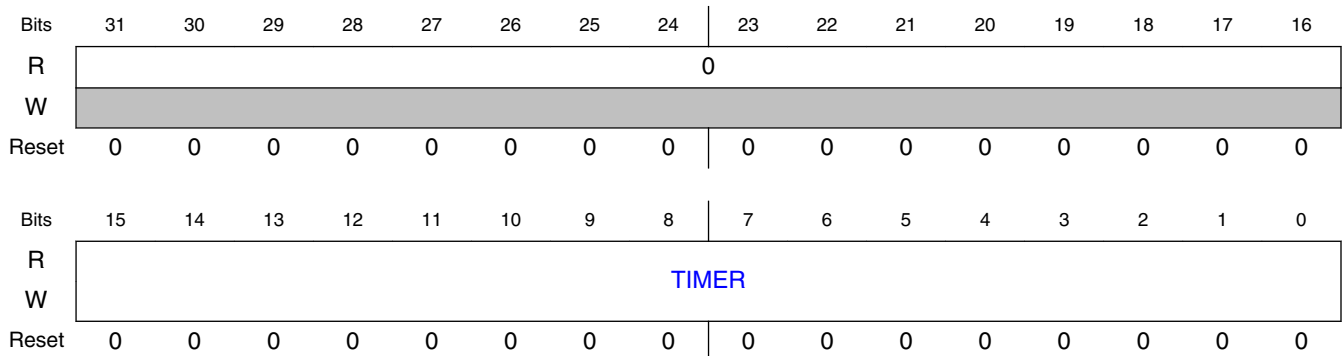

55.5.2.4.4 Fields

Field	Function
31-16 —	Reserved
15-0 TIMER	Timer Value Contains the free-running counter value.

55.5.2.5 Rx Mailboxes Global Mask Register (RXMGMASK)

55.5.2.5.1 Offset

Register	Offset
RXMGMASK	10h

55.5.2.5.2 Function

This register is located in RAM.

RXMGMASK is provided for legacy application support.

- When MCR[IRMQ] is negated, RXMGMASK is always in effect (the bits in the MG field will mask the mailbox filter bits).
- When MCR[IRMQ] is asserted, RXMGMASK has no effect (the bits in the MG field will not mask the mailbox filter bits).

RXMGMASK is used to mask the filter fields of all Rx MBs, excluding MBs 14-15, which have individual mask registers.

This register can only be written in Freeze mode as it is blocked by hardware in other modes.

55.5.2.5.3 Diagram

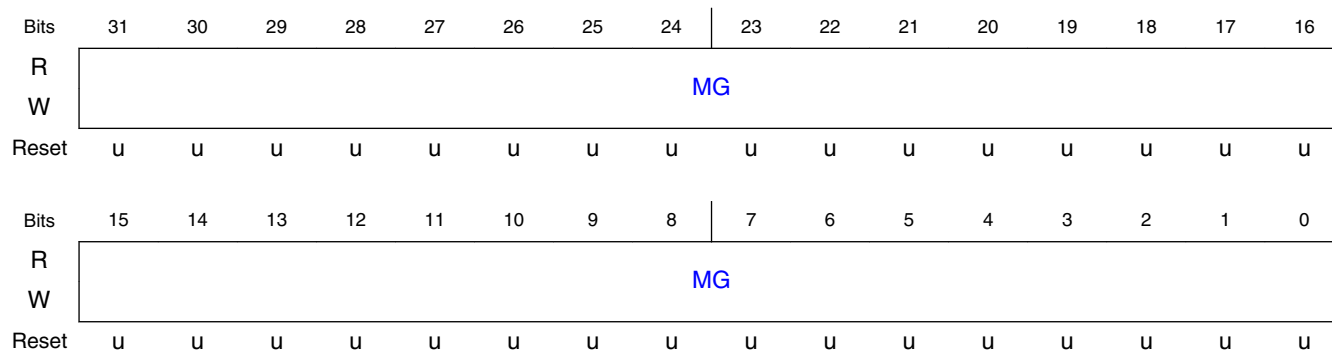

55.5.2.5.4 Fields

Field	Function																																														
31-0 MG	<p>Rx Mailboxes Global Mask Bits</p> <p>These bits mask the mailbox filter bits. Note that the alignment with the ID word of the mailbox is not perfect as the two most significant MG bits affect the fields RTR and IDE, which are located in the Control and Status word of the mailbox. The following table shows in detail which MG bits mask each mailbox filter field.</p> <table border="1"> <thead> <tr> <th rowspan="2">SMB[RTR]⁻¹</th> <th rowspan="2">CTRL2[RRS]</th> <th rowspan="2">CTRL2[EACE N]</th> <th colspan="4">Mailbox filter fields</th> </tr> <tr> <th>MB[RTR]</th> <th>MB[IDE]</th> <th>MB[ID]</th> <th>Reserved</th> </tr> </thead> <tbody> <tr> <td>0</td> <td>—</td> <td>0</td> <td>note ⁻¹</td> <td>note ⁻¹</td> <td>MG[28:0]</td> <td>MG[31:29]</td> </tr> <tr> <td>0</td> <td>—</td> <td>1</td> <td>MG[31]</td> <td>MG[30]</td> <td>MG[28:0]</td> <td>MG[29]</td> </tr> <tr> <td>1</td> <td>0</td> <td>—</td> <td>—</td> <td>—</td> <td>—</td> <td>MG[31:0]</td> </tr> <tr> <td>1</td> <td>1</td> <td>0</td> <td>—</td> <td>—</td> <td>MG[28:0]</td> <td>MG[31:29]</td> </tr> <tr> <td>1</td> <td>1</td> <td>1</td> <td>MG[31]</td> <td>MG[30]</td> <td>MG[28:0]</td> <td>MG[29]</td> </tr> </tbody> </table> <p>1. RTR bit of the incoming frame. It is saved into an auxiliary MB called Rx serial message buffer (Rx SMB).</p>	SMB[RTR] ⁻¹	CTRL2[RRS]	CTRL2[EACE N]	Mailbox filter fields				MB[RTR]	MB[IDE]	MB[ID]	Reserved	0	—	0	note ⁻¹	note ⁻¹	MG[28:0]	MG[31:29]	0	—	1	MG[31]	MG[30]	MG[28:0]	MG[29]	1	0	—	—	—	—	MG[31:0]	1	1	0	—	—	MG[28:0]	MG[31:29]	1	1	1	MG[31]	MG[30]	MG[28:0]	MG[29]
SMB[RTR] ⁻¹	CTRL2[RRS]				CTRL2[EACE N]	Mailbox filter fields																																									
		MB[RTR]	MB[IDE]	MB[ID]		Reserved																																									
0	—	0	note ⁻¹	note ⁻¹	MG[28:0]	MG[31:29]																																									
0	—	1	MG[31]	MG[30]	MG[28:0]	MG[29]																																									
1	0	—	—	—	—	MG[31:0]																																									
1	1	0	—	—	MG[28:0]	MG[31:29]																																									
1	1	1	MG[31]	MG[30]	MG[28:0]	MG[29]																																									

Memory map/register definition

Field	Function
	2. If CTRL2[EACEN] is negated, the RTR bit of mailbox is never compared with the RTR bit of the incoming frame. 3. If CTRL2[EACEN] is negated, the IDE bit of mailbox is always compared with the IDE bit of the incoming frame. 0b - The corresponding bit in the filter is "don't care." 1b - The corresponding bit in the filter is checked.

1. RTR bit of the incoming frame. It is saved into an auxiliary MB called Rx serial message buffer (Rx SMB).
2. If CTRL2[EACEN] is negated, the RTR bit of mailbox is never compared with the RTR bit of the incoming frame.
3. If CTRL2[EACEN] is negated, the IDE bit of mailbox is always compared with the IDE bit of the incoming frame.

55.5.2.6 Rx 14 Mask Register (RX14MASK)

55.5.2.6.1 Offset

Register	Offset
RX14MASK	14h

55.5.2.6.2 Function

This register is located in RAM.

RX14MASK is provided for legacy application support. When MCR[IRMQ] is asserted, RX14MASK has no effect.

RX14MASK is used to mask the filter fields of message buffer 14.

This register can only be programmed when the module is in Freeze mode as it is blocked by hardware in other modes.

55.5.2.6.3 Diagram

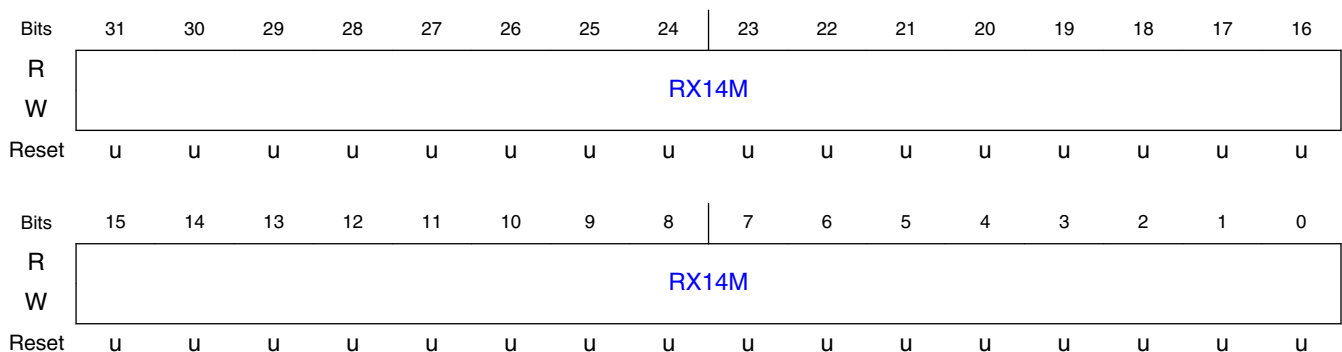

55.5.2.6.4 Fields

Field	Function
31-0 RX14M	<p>Rx Buffer 14 Mask Bits</p> <p>Each mask bit masks the corresponding mailbox 14 filter field in the same way that RXMGMASK masks other mailboxes' filters. See the description of the RXMGMASK register.</p> <p>0b - The corresponding bit in the filter is "don't care." 1b - The corresponding bit in the filter is checked.</p>

55.5.2.7 Rx 15 Mask Register (RX15MASK)

55.5.2.7.1 Offset

Register	Offset
RX15MASK	18h

55.5.2.7.2 Function

This register is located in RAM.

RX15MASK is provided for legacy application support. When MCR[IRMQ] is asserted, RX15MASK has no effect.

RX15MASK is used to mask the filter fields of message buffer 15.

This register can be programmed only when the module is in Freeze mode because it is blocked by hardware in other modes.

55.5.2.7.3 Diagram

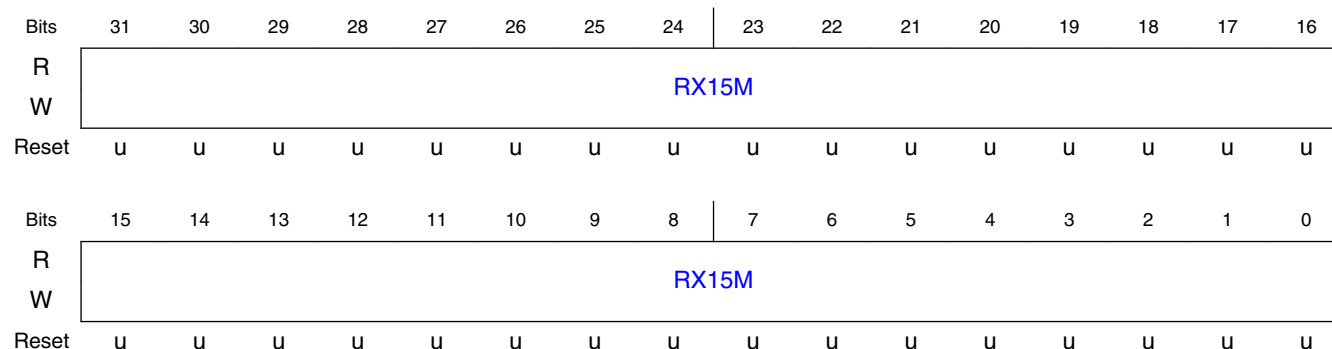

55.5.2.7.4 Fields

Field	Function
31-0 RX15M	<p>Rx Buffer 15 Mask Bits</p> <p>Each mask bit masks the corresponding mailbox 15 filter field in the same way that RXMGMASK masks other mailboxes' filters. See the description of the RXMGMASK register.</p> <p>0b - The corresponding bit in the filter is "don't care." 1b - The corresponding bit in the filter is checked.</p>

55.5.2.8 Error Counter (ECR)

55.5.2.8.1 Offset

Register	Offset
ECR	1Ch

55.5.2.8.2 Function

This register has four 8-bit fields reflecting the value of the FlexCAN error counters:

- Transmit Error Counter (TXERRCNT field)
- Receive Error Counter (RXERRCNT field)
- Transmit Error Counter for errors detected in the data phase of CAN FD messages with the BRS bit set (TXERRCNT_FAST field)
- Receive Error Counter for errors detected in the data phase of CAN FD messages with the BRS bit set (RXERRCNT_FAST field)

The TXERRCNT and RXERRCNT counters take into account all errors in both CAN FD and non-FD message formats. TXERRCNT_FAST and RXERRCNT_FAST are dedicated to count only the errors that occur in the data phase of CAN FD frames with the BRS bit set.

The Fault Confinement state (ESR1[FLTCONF]) is updated based on TXERRCNT and RXERRCNT counters only. TXERRCNT and RXERRCNT counters can be written in Freeze mode only. TXERRCNT_FAST and RXERRCNT_FAST counters are read-only except in Freeze mode when the CPU can write value zero. The rules for increasing and decreasing these counters are described in the CAN protocol and are completely implemented in the FlexCAN module.

The following are the basic rules for FlexCAN bus state transitions:

- If the value of TXERRCNT or RXERRCNT becomes greater than or equal to 128, ESR1[FLTCONF] is updated to reflect Error Passive state.
- If the FlexCAN state is Error Passive, and either TXERRCNT or RXERRCNT decrements to a value less than or equal to 127 when the other already satisfies this condition, ESR1[FLTCONF] is updated to reflect Error Active state.
- If the value of TXERRCNT becomes greater than 255, ESR1[FLTCONF] is updated to reflect Bus Off state, and an interrupt may be issued. The value of TXERRCNT is then reset to zero.
- If FlexCAN is in Bus Off state, then TXERRCNT is cascaded together with another internal counter to count the 128th occurrences of 11 consecutive recessive bits on the bus. Hence, TXERRCNT is reset to zero and counts in a manner where the internal counter counts 11 such bits and then wraps around when incrementing the TXERRCNT. When TXERRCNT reaches the value of 128, ESR1[FLTCONF] is updated to be Error Active and both error counters are reset to zero. At any instance of dominant bit following a stream of less than 11 consecutive recessive bits, the internal counter resets itself to zero without affecting the TXERRCNT value. The TXERRCNT_FAST counter is frozen during Bus Off.
- If during system startup only one node is operating, then its TXERRCNT increases in each message it is trying to transmit, as a result of acknowledge errors (indicated by the ACKERR bit in the Error and Status Register). After the transition to Error Passive state, TXERRCNT does not increment anymore by acknowledge errors. Therefore the device never goes to the Bus Off state.
- If RXERRCNT increases to a value greater than 127, it is not incremented further, even if more errors are detected when being a receiver. At the next successful message reception, the counter is set to a value between 119 and 127 to return to Error Active state.
- TXERRCNT_FAST and RXERRCNT_FAST error counter values increment and decrement based on errors detected only in the data phase of CAN FD frames with the BRS bit set, following the same increment and decrement rules as TXERRCNT and RXERRCNT counters. These counters do not wrap around and get stuck at their maximum value (255). They stop counting and keep their values frozen when FlexCAN is in Bus Off state. They are reset when FlexCAN leaves Bus Off state and restart counting after FlexCAN returns to Error Active state.
- When FlexCAN is in Pretended Networking mode, RXERRCNT and RXERRCNT_FAST keep counting errors and error flags are stored. TXERRCNT and TXERRCNT_FAST preserve their values and do not change, because no transmission occurs under Pretended Networking mode. Error counters and error flags that changed values when in Pretended Networking mode are updated in ECR and ESR1 when FlexCAN returns to Normal mode. The FAST error flags in ESR1 register will not be set if FlexCAN is in Pretended Networking mode.

NOTE

See Fault confinement in the CAN Protocol standard (ISO 11898-1) for details.

55.5.2.8.3 Diagram

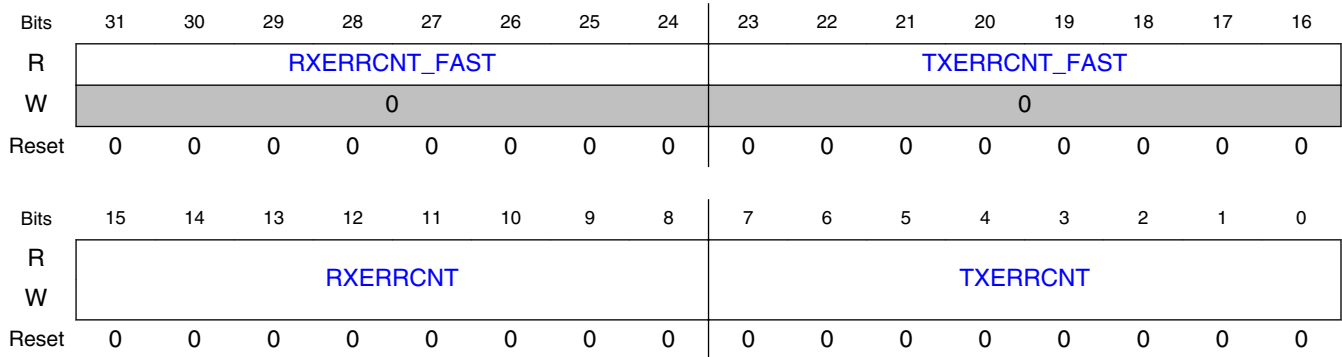

55.5.2.8.4 Fields

Field	Function
31-24 RXERRCNT_FAST	Receive Error Counter for fast bits Receive error counter for errors detected in the data phase of received CAN FD messages with the BRS bit set. The RXERRCNT_FAST counter is read-only except in Freeze mode, where the CPU can write an 8-bit zero value only.
23-16 TXERRCNT_FAST	Transmit Error Counter for fast bits Transmit error counter for errors detected in the data phase of transmitted CAN FD messages with the BRS bit set. The TXERRCNT_FAST counter is read-only except in Freeze mode, where the CPU can write an 8-bit zero value only.
15-8 RXERRCNT	Receive Error Counter Receive error counter for all errors detected in received messages. The RXERRCNT counter is read-only except in Freeze mode, where it can be written by the CPU.
7-0 TXERRCNT	Transmit Error Counter Transmit error counter for all errors detected in transmitted messages. The TXERRCNT counter is read-only except in Freeze mode, where it can be written by the CPU.

55.5.2.9 Error and Status 1 Register (ESR1)

55.5.2.9.1 Offset

Register	Offset
ESR1	20h

55.5.2.9.2 Function

This register reports various error conditions detected in the reception and transmission of a CAN frame, some general status of the device, and is the source of some interrupts to the CPU. The reported error conditions are:

NOTE

Reading Host can clear these field.

- Errors detected in CAN frames of any format:
 - BIT1ERR
 - BIT0ERR
 - ACKKERR
 - CRCERR
 - FRMERR
 - STFERR
- Errors detected in the data phase of CAN FD frames with the BRS bit set only:
 - BIT1ERR_FAST
 - BIT0ERR_FAST
 - CRCERR_FAST
 - FRMERR_FAST
 - STFERR_FAST

An error detected in a single CAN frame may be reported by one or more error flags. Also, error reporting is cumulative, in case more error events happen in the next frames when the CPU does not attempt to read this register.

Status bits:

- TXWRN
- RXWRN
- IDLE
- TX
- FLTCONF
- RX
- SYNCH

Interrupt bits:

- BOFFINT
- BOFFDONEINT
- ERRINT
- ERRINT_FAST

Memory map/register definition

- TWRNINT
- RWRNINT

It is recommended that the CPU use the following procedure when servicing interrupt requests generated by these bits:

1. Read this register to capture all error condition and status bits. This action clears the respective bits that were set since the last read access.
2. Write 1 to clear the interrupt bit that has triggered the interrupt request.
3. Write 1 to clear the ERR_OVR bit, if it is set.

Starting from all error flags cleared, a first error event sets either the ERRINT or the ERRINT_FAST (provided the corresponding mask bit is asserted). If other error events in subsequent frames happen before the CPU serves the interrupt request, the ERR_OVR bit is set to indicate that errors from different frames have accumulated.

Table 55-22. Can bus status

SYNCH	IDLE	TX	RX	FlexCAN state
0	0	0	0	Not synchronized to CAN bus
1	1	x	x	Idle
1	0	1	0	Transmitting
1	0	0	1	Receiving

NOTE

See Fault confinement in the CAN Protocol standard (ISO 11898-1) for details.

55.5.2.9.3 Diagram

Bits	31	30	29	28	27	26	25	24	23	22	21	20	19	18	17	16
R	BIT1ERR_FAS T	BIT0ERR_FAS T	0	CRCERR_FAS T	FRMERR_FAS T	STFERR_FAS T	0				ERROV R	ERRINT_FAS T	BOFFDONEINT	SYNCH	TWRNINT	RWRNINT
W											W1C	W1C	W1C		W1C	W1C
Reset	0	0	0	0	0	0	0	0	0	0	0	0	0	0	0	0
Bits	15	14	13	12	11	10	9	8	7	6	5	4	3	2	1	0
R	BIT1ER R	BIT0ER R	ACKERR	CRCER R	FRMER R	STFER R	TXWRN	RXWRN	IDL E	TX	FLTCONF		R X	BOFFINT	ERRIN T	0
W														W1C	W1C	
Reset	0	0	0	0	0	0	0	0	0	0	0	0	0	0	0	0

55.5.2.9.4 Fields

Field	Function
31 BIT1ERR_FAST	Bit1 Error in the Data Phase of CAN FD frames with the BRS bit set This bit indicates when an inconsistency occurs between the transmitted and the received bit in the data phase of CAN FD frames with the BRS bit set. After a read operation, the field's value clears to 0. 0b - No such occurrence. 1b - At least one bit sent as recessive is received as dominant.
30 BIT0ERR_FAST	Bit0 Error in the Data Phase of CAN FD frames with the BRS bit set This bit indicates when an inconsistency occurs between the transmitted and the received bit in the data phase of CAN FD frames with the BRS bit set. After a read operation, the field's value clears to 0. 0b - No such occurrence. 1b - At least one bit sent as dominant is received as recessive.
29 —	Reserved
28 CRCERR_FAST	Cyclic Redundancy Check Error in the CRC field of CAN FD frames with the BRS bit set This bit indicates that a CRC error has been detected by the receiver node in the CRC field of CAN FD frames with the BRS bit set, that is, the calculated CRC is different from the received. After a read operation, the field's value clears to 0. 0b - No such occurrence. 1b - A CRC error occurred since last read of this register.

Table continues on the next page...

Memory map/register definition

Field	Function
27 FRMERR_FAST	<p>Form Error in the Data Phase of CAN FD frames with the BRS bit set</p> <p>This bit indicates that a form error has been detected by the receiver node in the data phase of CAN FD frames with the BRS bit set, that is, a fixed-form bit field contains at least one illegal bit.</p> <p>After a read operation, the field's value clears to 0.</p> <p>0b - No such occurrence. 1b - A form error occurred since last read of this register.</p>
26 STFERR_FAST	<p>Stuffing Error in the Data Phase of CAN FD frames with the BRS bit set</p> <p>This bit indicates that a stuffing error has been detected in the data phase of CAN FD frames with the BRS bit set.</p> <p>After a read operation, the field's value clears to 0.</p> <p>0b - No such occurrence. 1b - A stuffing error occurred since last read of this register.</p>
25-22 —	Reserved
21 ERROVR	<p>Error Overrun</p> <p>This bit indicates that an error condition occurred when any error flag is already set. This bit is cleared by writing it to 1.</p> <p>0b - Overrun has not occurred. 1b - Overrun has occurred.</p>
20 ERRINT_FAST	<p>Error interrupt for errors detected in Data Phase of CAN FD frames with BRS bit set</p> <p>This bit indicates that at least one of the error bits detected in the data phase of CAN FD frames with the BRS bit set (BIT1ERR_FAST, BIT0ERR_FAST, CRCERR_FAST, FRMERR_FAST, or STFERR_FAST) is set. If the corresponding mask bit CTRL2[ERRMSK_FAST] is set, an interrupt is generated to the CPU. This bit is cleared by writing it to 1. Writing 0 has no effect.</p> <p>0b - No such occurrence. 1b - Indicates setting of any error bit detected in the data phase of CAN FD frames with the BRS bit set.</p>
19 BOFFDONEINT	<p>Bus Off Done Interrupt</p> <p>This bit is set when the Tx Error Counter (TXERRCNT) has finished counting 128 occurrences of 11 consecutive recessive bits on the CAN bus and is ready to leave Bus Off. If the corresponding mask bit in the Control 2 Register (BOFFDONEMSK) is set, an interrupt is generated to the CPU. This bit is cleared by writing it to 1. Writing 0 has no effect.</p> <p>0b - No such occurrence. 1b - FlexCAN module has completed Bus Off process.</p>
18 SYNCH	<p>CAN Synchronization Status</p> <p>This read-only flag indicates whether the FlexCAN is synchronized to the CAN bus and able to participate in the communication process. It is set and cleared by the FlexCAN. See the table in the overall ESR1 register description.</p> <p>0b - FlexCAN is not synchronized to the CAN bus. 1b - FlexCAN is synchronized to the CAN bus.</p>
17 TWRNINT	<p>Tx Warning Interrupt Flag</p> <p>If MCR[WRNEN] is asserted, TWRNINT is set when the TXWRN flag transitions from 0 to 1, meaning that the Tx error counter reached 96. If the corresponding mask bit in the Control 1 Register (CTRL1[TWRNMSK]) is set, an interrupt is generated to the CPU. This bit is cleared by writing it to 1. When MCR[WRNEN] is negated, this flag is masked. CPU must clear this flag before disabling MCR[WRNEN]. Otherwise it will be set when MCR[WRNEN] is set again. Writing 0 has no effect. This flag is not generated during Bus Off state. This bit is not updated during Freeze mode.</p>

Table continues on the next page...

Field	Function
	<p>When FlexCAN returns to Normal mode from Pretended Network mode (see Receive process under Pretended Networking mode), this bit is not updated.</p> <p>0b - No such occurrence. 1b - The Tx error counter transitioned from less than 96 to greater than or equal to 96.</p>
16 RWRNINT	<p>Rx Warning Interrupt Flag</p> <p>If MCR[WRNEN] is asserted, RWRNINT is set when the RXWRN flag transitions from 0 to 1, meaning that the Rx error counters reached 96. If the corresponding mask bit in the Control 1 Register (CTRL1[RWRNMSK]) is set, an interrupt is generated to the CPU. This bit is cleared by writing it to 1. When WRNEN is negated, this flag is masked. CPU must clear this flag before disabling the bit. Otherwise it will be set when WRNEN is set again. Writing 0 has no effect. This bit is not updated during Freeze mode.</p> <p>When FlexCAN returns to Normal mode from Pretended Network mode (see Receive process under Pretended Networking mode), this bit is updated to reflect the Rx error counter state.</p> <p>0b - No such occurrence. 1b - The Rx error counter transitioned from less than 96 to greater than or equal to 96.</p>
15 BIT1ERR	<p>Bit1 Error</p> <p>This bit indicates when an inconsistency occurs between the transmitted and the received bit in a non-CAN FD message or in the arbitration or data phase of a CAN FD message.</p> <p>This bit is updated when FlexCAN returns to Normal mode from Pretended Network mode.</p> <p>NOTE: This bit is not set by a transmitter in case of arbitration field or ACK slot, or in case of a node sending a passive error flag that detects dominant bits.</p> <p>After a read operation, the field's value clears to 0.</p> <p>0b - No such occurrence. 1b - At least one bit sent as recessive is received as dominant.</p>
14 BIT0ERR	<p>Bit0 Error</p> <p>This bit indicates when an inconsistency occurs between the transmitted and the received bit in a non-CAN FD message or in the arbitration or data phase of a CAN FD message.</p> <p>This bit is updated when FlexCAN returns to Normal mode from Pretended Network mode.</p> <p>After a read operation, the field's value clears to 0.</p> <p>0b - No such occurrence. 1b - At least one bit sent as dominant is received as recessive.</p>
13 ACKERR	<p>Acknowledge Error</p> <p>This bit indicates that an Acknowledge Error has been detected by the transmitter node, that is, a dominant bit has not been detected during the ACK SLOT.</p> <p>This bit is updated when FlexCAN returns to Normal mode from Pretended Network mode.</p> <p>After a read operation, the field's value clears to 0.</p> <p>0b - No such occurrence. 1b - An ACK error occurred since last read of this register.</p>
12 CRCERR	<p>Cyclic Redundancy Check Error</p> <p>This bit indicates that a Cyclic Redundancy Check (CRC) error has been detected by the receiver node either in a non-FD message or in the arbitration or data phase of a frame in CAN FD format, that is, the calculated CRC is different from the received.</p> <p>This bit is updated when FlexCAN returns to Normal mode from Pretended Network mode.</p> <p>After a read operation, the field's value clears to 0.</p> <p>0b - No such occurrence.</p>

Table continues on the next page...

Memory map/register definition

Field	Function
	1b - A CRC error occurred since last read of this register.
11 FRMERR	<p>Form Error</p> <p>This bit indicates that a form error has been detected in a non-FD message or else in an FD message's arbitration or data phase by the receiver node, that is, a fixed-form bit field contains at least one illegal bit. This bit is updated when FlexCAN returns to Normal mode from Pretended Network mode.</p> <p>After a read operation, the field's value clears to 0.</p> <p>0b - No such occurrence. 1b - A Form Error occurred since last read of this register.</p>
10 STFERR	<p>Stuffing Error</p> <p>This bit indicates that a stuffing error has been detected in a non-FD message or else in an FD message's arbitration or data phase by the receiver node. This bit is updated when FlexCAN returns to Normal mode from Pretended Network mode.</p> <p>After a read operation, the field's value clears to 0.</p> <p>0b - No such occurrence. 1b - A stuffing error occurred since last read of this register.</p>
9 TXWRN	<p>TX Error Warning</p> <p>This bit indicates when repetitive errors are occurring during message transmission and is affected by the value of TXERRCNT in ECR register only. This bit is not updated during Freeze mode.</p> <p>After a read operation, the field's value clears to 0.</p> <p>0b - No such occurrence. 1b - TXERRCNT is greater than or equal to 96.</p>
8 RXWRN	<p>Rx Error Warning</p> <p>This bit indicates when repetitive errors are occurring during message reception and is affected by the value of RXERRCNT in ECR register only. This bit is not updated during Freeze mode.</p> <p>Additionally, it is updated when FlexCAN returns to Normal mode from Pretended Networking mode.</p> <p>After a read operation, the field's value clears to 0.</p> <p>0b - No such occurrence. 1b - RXERRCNT is greater than or equal to 96.</p>
7 IDLE	<p>IDLE</p> <p>This bit indicates when CAN bus is in IDLE state. See the table in the overall ESR1 register description.</p> <p>0b - No such occurrence. 1b - CAN bus is now IDLE.</p>
6 TX	<p>FlexCAN In Transmission</p> <p>This bit indicates if FlexCAN is transmitting a message. See the table in the overall ESR1 register description.</p> <p>0b - FlexCAN is not transmitting a message. 1b - FlexCAN is transmitting a message.</p>
5-4 FLTCONF	<p>Fault Confinement State</p> <p>This 2-bit field indicates the confinement state of the FlexCAN module.</p> <p>If CTRL1[LOM] is asserted, after a delay that depends on the CAN bit timing, ESR1[FLTCONF] will indicate Error Passive. The very same delay affects the way that ESR1[FLTCONF] reflects an update to ECR register by the CPU. It may be necessary to wait up to one CAN bit time to get them coherent again.</p> <p>This bit field is affected by soft reset, but if the LOM bit is asserted, its reset value lasts just one CAN bit. After this time, ESR1[FLTCONF] reports Error Passive.</p>

Table continues on the next page...

Field	Function
	00b - Error Active 01b - Error Passive 1xb - Bus Off
3 RX	FlexCAN In Reception This bit indicates if FlexCAN is receiving a message. See the table in the overall ESR1 register description. 0b - FlexCAN is not receiving a message. 1b - FlexCAN is receiving a message.
2 BOFFINT	Bus Off Interrupt This bit is set when FlexCAN enters Bus Off state. If the corresponding mask bit in the Control Register 1 (CTRL1[BOFFMSK]) is set, an interrupt is generated to the CPU. This bit is cleared by writing it to 1. Writing 0 has no effect. 0b - No such occurrence. 1b - FlexCAN module entered Bus Off state.
1 ERRINT	Error Interrupt This bit indicates that at least one of the error bits (BIT1ERR, BIT0ERR, ACKERR, CRCERR, FRMERR, or STFERR) is set. If the corresponding mask bit CTRL1[ERRMSK] is set, an interrupt is generated to the CPU. This bit is cleared by writing it to 1. Writing 0 has no effect. 0b - No such occurrence. 1b - Indicates setting of any error bit in the Error and Status register.
0 —	Reserved

55.5.2.10 Interrupt Masks 1 Register (IMASK1)

55.5.2.10.1 Offset

Register	Offset
IMASK1	28h

55.5.2.10.2 Function

This register allows any number of a range of the 32 message buffer interrupts to be enabled or disabled for MB31 to MB0. It contains one interrupt mask bit per buffer, enabling the CPU to determine which buffer generates an interrupt after a successful transmission or reception, that is, when the corresponding IFLAG1 bit is set.

55.5.2.10.3 Diagram

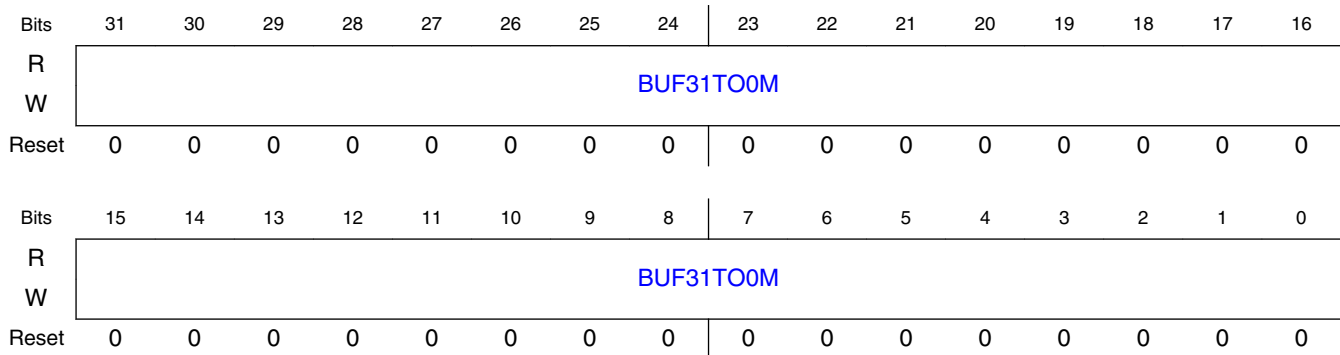

55.5.2.10.4 Fields

Field	Function
31-0 BUF31TO0M	Buffer MBi Mask Each bit enables or disables the corresponding FlexCAN message buffer interrupt for MB31 to MB0. NOTE: Setting or clearing a bit in the IMASK1 Register can assert or negate an interrupt request, if the corresponding IFLAG1 bit is set. 0b - The corresponding buffer interrupt is disabled. 1b - The corresponding buffer interrupt is enabled.

55.5.2.11 Interrupt Flags 1 Register (IFLAG1)

55.5.2.11.1 Offset

Register	Offset
IFLAG1	30h

55.5.2.11.2 Function

This register defines the flags for the 32 message buffer interrupts for MB31 to MB0. It contains one interrupt flag bit per buffer. Each successful transmission or reception sets the corresponding IFLAG1 bit. If the corresponding IMASK1 bit is set, an interrupt will be generated. The interrupt flag must be cleared by writing 1 to it. Writing 0 has no effect. There is an exception when DMA for Rx FIFO is enabled, as described below.

The BUF7I to BUF5I flags are also used to represent FIFO interrupts when the Rx FIFO is enabled. When MCR[RFEN] is set and MCR[DMA] is negated, the function of the eight least significant interrupt flags changes: BUF7I, BUF6I, and BUF5I indicate operating conditions of the FIFO, BUF0I is used to empty FIFO, and BUF4I to BUF1I bits are reserved.

Before enabling MCR[RFEN], the CPU must service the IFLAG bits asserted in the Rx FIFO region; see [Rx FIFO](#). Otherwise, these IFLAG bits will mistakenly show the related MBs now belonging to FIFO as having contents to be serviced. When MCR[RFEN] is negated, the FIFO flags must be cleared. The same care must be taken when a CTRL2[RFFN] value is selected, extending Rx FIFO filters beyond MB7. For example, when RFFN is 8h, the MB0–23 range is occupied by Rx FIFO filters and related IFLAG bits must be cleared.

When both the MCR[RFEN] and MCR[DMA] bits are asserted (DMA feature for Rx FIFO enabled), the function of the eight least significant interrupt flags (BUF7I–BUF0I) are changed to support the DMA operation. BUF7I and BUF6I are not used, as well as BUF4I–BUF1I. BUF5I indicates operating condition of FIFO, and BUF0I is used to empty FIFO. Moreover, BUF5I does not generate a CPU interrupt, but generates a DMA request. IMASK1 bits in Rx FIFO region are not considered when bit MCR[DMA] is enabled. In addition the CPU must not clear the flag BUF5I when DMA is enabled. Before enabling MCR[DMA], the CPU must service the IFLAGs asserted in the Rx FIFO region. When MCR[DMA] is negated, the FIFO must be empty. FIFO must be disabled when MCR[FDEN] is enabled.

Before updating MCR[MAXMB], CPU must service the IFLAG1 bits whose MB value is greater than the MCR[MAXMB] to be updated; otherwise, they will remain set and be inconsistent with the number of MBs available.

55.5.2.11.3 Diagram

Bits	31	30	29	28	27	26	25	24	23	22	21	20	19	18	17	16	
R	BUF31TO8I																
W	W1C																
Reset	0	0	0	0	0	0	0	0	0	0	0	0	0	0	0	0	
Bits	15	14	13	12	11	10	9	8	7	6	5	4	3	2	1	0	
R	BUF31TO8I								BUF7I	BUF6I	BUF5I	BUF4TO1I				BUF0I	
W	W1C								W1C	W1C	W1C	W1C	W1C				W1C
Reset	0	0	0	0	0	0	0	0	0	0	0	0	0	0	0	0	

55.5.2.11.4 Fields

Field	Function
31-8 BUF31TO8I	<p>Buffer MBi Interrupt</p> <p>Each bit flags the corresponding FlexCAN message buffer interrupt for MB31 to MB8.</p> <p>0b - The corresponding buffer has no occurrence of successfully completed transmission or reception. 1b - The corresponding buffer has successfully completed transmission or reception.</p>
7 BUF7I	<p>Buffer MB7 Interrupt Or Rx FIFO Overflow</p> <p>When MCR[RFEN] is cleared (Rx FIFO disabled), this bit flags the interrupt for MB7.</p> <p>NOTE: This flag is cleared by the FlexCAN whenever MCR[RFEN] is changed by CPU writes.</p> <p>The BUF7I flag represents Rx FIFO overflow when MCR[RFEN] is set. In this case, the flag indicates that a message was lost because the Rx FIFO is full. Note that the flag will not be asserted when the Rx FIFO is full and the message was captured by a mailbox.</p> <p>0b - No occurrence of MB7 completing transmission/reception when MCR[RFEN]=0, or of Rx FIFO overflow when MCR[RFEN]=1 1b - MB7 completed transmission/reception when MCR[RFEN]=0, or Rx FIFO overflow when MCR[RFEN]=1</p>
6 BUF6I	<p>Buffer MB6 Interrupt Or Rx FIFO Warning</p> <p>When MCR[RFEN] is cleared (Rx FIFO disabled), this bit flags the interrupt for MB6.</p> <p>NOTE: This flag is cleared by the FlexCAN whenever MCR[RFEN] is changed by CPU writes.</p> <p>The BUF6I flag represents Rx FIFO warning when MCR[RFEN] is set. In this case, the flag indicates when the number of unread messages within the Rx FIFO is increased to five from four due to the reception of a new one, meaning that the Rx FIFO is almost full. Note that if the flag is cleared when the number of unread messages is greater than four, it does not assert again until the number of unread messages within the Rx FIFO is decreased to be equal to or less than four.</p> <p>0b - No occurrence of MB6 completing transmission/reception when MCR[RFEN]=0, or of Rx FIFO almost full when MCR[RFEN]=1 1b - MB6 completed transmission/reception when MCR[RFEN]=0, or Rx FIFO almost full when MCR[RFEN]=1</p>
5 BUF5I	<p>Buffer MB5 Interrupt Or Frames available in Rx FIFO</p> <p>When MCR[RFEN] is cleared (Rx FIFO disabled), this field flags the interrupt for MB5.</p> <p>NOTE: This flag is cleared by the FlexCAN whenever MCR[RFEN] is changed by CPU writes.</p> <p>When MCR[RFEN] is set (Rx FIFO enabled), the BUF5I flag represents "Frames available in Rx FIFO" and indicates that at least one frame is available to be read from the Rx FIFO. When the MCR[DMA] bit is enabled, this flag generates a DMA request and the CPU must not clear this bit by writing 1 in BUF5I.</p> <p>0b - No occurrence of MB5 completing transmission/reception when MCR[RFEN]=0, or of frame(s) available in the FIFO, when MCR[RFEN]=1 1b - MB5 completed transmission/reception when MCR[RFEN]=0, or frame(s) available in the Rx FIFO when MCR[RFEN]=1. It generates a DMA request in case of MCR[RFEN] and MCR[DMA] are enabled.</p>
4-1 BUF4TO1I	<p>Buffer MBi Interrupt Or Reserved</p> <p>When MCR[RFEN] is cleared (Rx FIFO disabled), these bits flag the interrupts for MB4 to MB1.</p> <p>NOTE: These flags are cleared by the FlexCAN whenever MCR[RFEN] is changed by CPU writes.</p> <p>The BUF4TO1I flags are reserved when MCR[RFEN] is set.</p>

Table continues on the next page...

Field	Function
	0b - The corresponding buffer has no occurrence of successfully completed transmission or reception when MCR[RFEN]=0. 1b - The corresponding buffer has successfully completed transmission or reception when MCR[RFEN]=0.
0 BUF0I	Buffer MB0 Interrupt Or Clear FIFO bit When MCR[RFEN] is cleared (Rx FIFO disabled), this field flags the interrupt for MB0. If the Rx FIFO is enabled, this bit is used to trigger the clear FIFO operation. This operation empties FIFO contents. Before performing this operation the CPU must service all FIFO related IFLAGs. When MCR[DMA] is enabled this operation also clears the BUF5I flag and consequently aborts the DMA request. The clear FIFO operation occurs when the CPU writes 1 in BUF0I. It is only allowed in Freeze mode and is blocked by hardware in other conditions. 0b - The corresponding buffer has no occurrence of successfully completed transmission or reception when MCR[RFEN]=0. 1b - The corresponding buffer has successfully completed transmission or reception when MCR[RFEN]=0.

55.5.2.12 Control 2 Register (CTRL2)

55.5.2.12.1 Offset

Register	Offset
CTRL2	34h

55.5.2.12.2 Function

This register complements Control1 register, providing control bits for memory write access in Freeze mode, for extending FIFO filter quantity, and to adjust the operation of internal FlexCAN processes like matching and arbitration.

The contents of this register are not affected by soft reset.

This table shows how the Rx FIFO filter structure is determined by the value of CTRL2[RFFN]. See the CTRL2[RFFN] field description for more information.

Table 55-23. Rx FIFO filter: possible structures

RFFN[3:0]	Number of Rx FIFO filter elements	Message buffers occupied by Rx FIFO and ID filter table	Remaining available mailboxes	Rx FIFO ID filter table elements affected by Rx individual masks	Rx FIFO ID filter table elements affected by Rx FIFO global mask
0h	8	MB 0-7	MB 8-31	Elements 0-7	none
1h	16	MB 0-9	MB 10-31	Elements 0-9	Elements 10-15

Table continues on the next page...

Table 55-23. Rx FIFO filter: possible structures (continued)

RFFN[3:0]	Number of Rx FIFO filter elements	Message buffers occupied by Rx FIFO and ID filter table	Remaining available mailboxes	Rx FIFO ID filter table elements affected by Rx individual masks	Rx FIFO ID filter table elements affected by Rx FIFO global mask
2h	24	MB 0-11	MB 12-31	Elements 0-11	Elements 12-23
3h	32	MB 0-13	MB 14-31	Elements 0-13	Elements 14-31
4h	40	MB 0-15	MB 16-31	Elements 0-15	Elements 16-39
5h	48	MB 0-17	MB 18-31	Elements 0-17	Elements 18-47
6h	56	MB 0-19	MB 20-31	Elements 0-19	Elements 20-55
7h	64	MB 0-21	MB 22-31	Elements 0-21	Elements 22-63
8h	72	MB 0-23	MB 24-31	Elements 0-23	Elements 24-71
9h	80	MB 0-25	MB 26-31	Elements 0-25	Elements 26-79
Ah	88	MB 0-27	MB 28-31	Elements 0-27	Elements 28-87
Bh	96	MB 0-29	MB 30-31	Elements 0-29	Elements 30-95
Ch	104	MB 0-31	none	Elements 0-31	Elements 32-103

55.5.2.12.3 Diagram

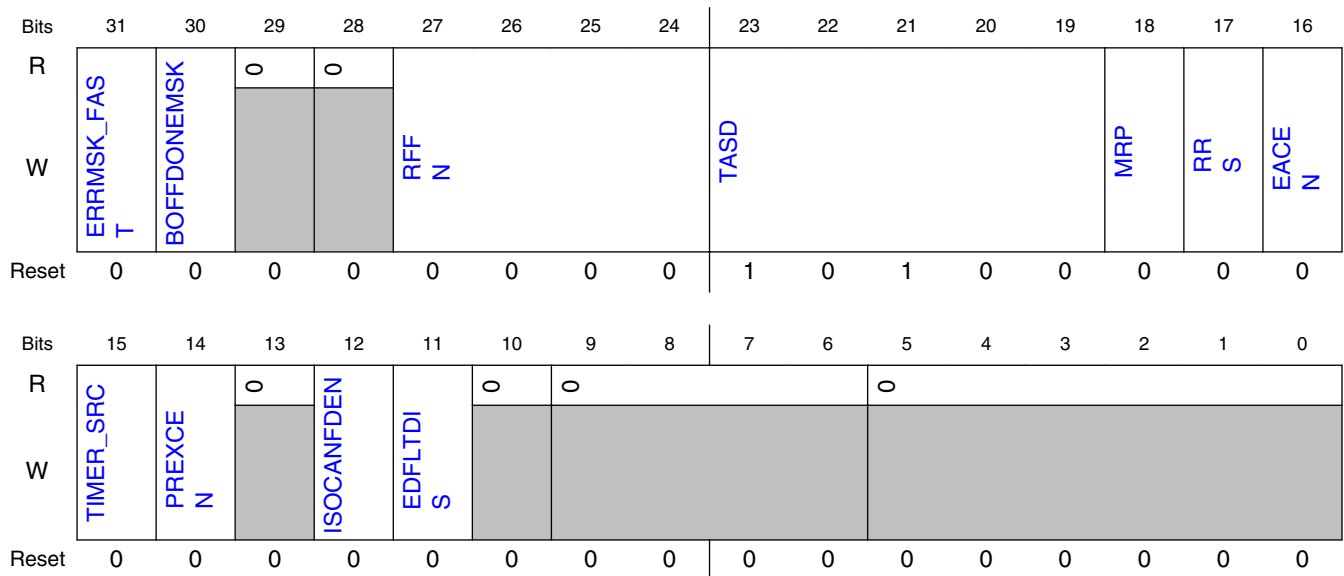

55.5.2.12.4 Fields

Field	Function
ERRMSK_FAST	Error Interrupt Mask for errors detected in the data phase of fast CAN FD frames. This bit provides a mask for the ERRINT_FAST interrupt in ESR1 register. 0b - ERRINT_FAST error interrupt disabled.

Table continues on the next page...

Field	Function
	1b - ERRINT_FAST error interrupt enabled.
30 BOFFDONEMSK	Bus Off Done Interrupt Mask This bit provides a mask for the bus off done interrupt in ESR1 register. 0b - Bus off done interrupt disabled. 1b - Bus off done interrupt enabled.
29 —	Reserved
28 —	Reserved
27-24 RFFN	<p>Number Of Rx FIFO Filters</p> <p>This 4-bit field defines the number of Rx FIFO filters, as shown in Table 55-23. The maximum selectable number of filters is determined by the chip. This field can only be written in Freeze mode as it is blocked by hardware in other modes. This field must not be programmed with values that cause the number of message buffers occupied by Rx FIFO and ID Filter to exceed the number of mailboxes present, as defined by MCR[MAXMB].</p> <p>NOTE: Each group of eight filters occupies a memory space equivalent to two message buffers, which means that the more filters are implemented the fewer mailboxes will be available.</p> <p>Considering that the Rx FIFO occupies the memory space originally reserved for MB0-5, RFFN should be programmed with a value corresponding to a number of filters not greater than the number of available memory words, which can be calculated as follows:</p> $(\text{SETUP_MB} - 6) \times 4$ <p>where SETUP_MB is the smaller of the parameter NUMBER_OF_MB and MCR[MAXMB].</p> <p>The number of remaining mailboxes available will be:</p> $(\text{SETUP_MB} - 8) - (\text{RFFN} \times 2)$ <p>If the number of Rx FIFO filters programmed through RFFN exceeds the SETUP_MB value (memory space available), then the exceeding ones will not be functional.</p> <p>NOTE:</p> <ul style="list-style-type: none"> The number of the last remaining available mailboxes is defined by the smaller of NUMBER_OF_MB minus 1 and MCR[MAXMB]. If Rx Individual Mask registers are not enabled then all Rx FIFO filters are affected by the Rx FIFO Global Mask.
23-19 TASD	<p>Tx Arbitration Start Delay</p> <p>This 5-bit field indicates how many CAN bits the Tx arbitration process start point can be delayed from the first bit of CRC field on CAN bus. See Tx arbitration start delay for more details. This field can be written only in Freeze mode because it is blocked by hardware in other modes.</p>
18 MRP	<p>Mailboxes Reception Priority</p> <p>If this bit is set the matching process starts from the mailboxes and if no match occurs the matching continues on the Rx FIFO. This bit can be written only in Freeze mode because it is blocked by hardware in other modes.</p> <p>0b - Matching starts from Rx FIFO and continues on mailboxes. 1b - Matching starts from mailboxes and continues on Rx FIFO.</p>
17 RRS	<p>Remote Request Storing</p> <p>If this bit is asserted a remote request frame is submitted to a matching process and stored in the corresponding message buffer in the same fashion as a data frame. No automatic remote response frame will be generated.</p> <p>If this bit is negated the remote request frame is submitted to a matching process and an automatic remote response frame is generated if a message buffer with CODE = 1010b is found with the same ID.</p>

Table continues on the next page...

Memory map/register definition

Field	Function												
	<p>This bit can be written only in Freeze mode because it is blocked by hardware in other modes.</p> <p>0b - Remote response frame is generated. 1b - Remote request frame is stored.</p>												
16 EACEN	<p>Entire Frame Arbitration Field Comparison Enable For Rx Mailboxes</p> <p>This bit controls the comparison of IDE and RTR bits within Rx mailbox filters with their corresponding bits in the incoming frame by the matching process. This bit does not affect matching for Rx FIFO. This bit can be written only in Freeze mode because it is blocked by hardware in other modes.</p> <p>0b - Rx mailbox filter's IDE bit is always compared and RTR is never compared despite mask bits. 1b - Enables the comparison of both Rx mailbox filter's IDE and RTR bit with their corresponding bits within the incoming frame. Mask bits do apply.</p>												
15 TIMER_SRC	<p>Timer Source</p> <p>Selects the time tick source used for incrementing the free running timer counter. This bit can be written in Freeze mode only.</p> <p>NOTE: This field is not supported in every instance. The following table includes only supported registers.</p> <table border="1"> <thead> <tr> <th>Instance</th> <th>Field supported in</th> <th>Field not supported in</th> </tr> </thead> <tbody> <tr> <td>FlexCAN0</td> <td>CTRL2</td> <td>—</td> </tr> <tr> <td>FlexCAN1</td> <td>—</td> <td>CTRL2</td> </tr> <tr> <td>FlexCAN2</td> <td>—</td> <td>CTRL2</td> </tr> </tbody> </table> <p>0b - The free running timer is clocked by the CAN bit clock, which defines the baud rate on the CAN bus. 1b - The free running timer is clocked by an external time tick. The period can be either adjusted to be equal to the baud rate on the CAN bus, or a different value as required. See the device-specific section for details about the external time tick.</p>	Instance	Field supported in	Field not supported in	FlexCAN0	CTRL2	—	FlexCAN1	—	CTRL2	FlexCAN2	—	CTRL2
Instance	Field supported in	Field not supported in											
FlexCAN0	CTRL2	—											
FlexCAN1	—	CTRL2											
FlexCAN2	—	CTRL2											
14 PREXCEN	<p>Protocol Exception Enable</p> <p>This bit enables the protocol exception feature.</p> <p>This field is writable only in Freeze mode.</p> <p>NOTE: See Protocol exception event in the CAN Protocol standard (ISO 11898-1) for details. 0b - Protocol exception is disabled. 1b - Protocol exception is enabled.</p>												
13 —	Reserved												
12 ISOCANFDEN	<p>ISO CAN FD Enable</p> <p>This field enables the CAN FD protocol according to ISO specification (ISO 11898-1) (see CAN FD ISO compliance).</p> <p>This field is writable only in Freeze mode.</p> <p>NOTE: FlexCAN is able to transmit FD frame format according to CAN Protocol standard (ISO 11898-1). 0b - FlexCAN operates using the non-ISO CAN FD protocol. 1b - FlexCAN operates using the ISO CAN FD protocol (ISO 11898-1).</p>												
11 EDFLTDIS	<p>Edge Filter Disable</p> <p>This bit disables the edge filter used during the bus integration state.</p>												

Table continues on the next page...

Field	Function
	<p>When the Edge Filter is enabled, two consecutive nominal time quanta with dominant bus state are required to detect an edge that causes synchronization. When synchronization occurs, the counting of the sequence of eleven consecutive recessive bits is restarted. The edge filter prevents the dominant pulses that are shorter than a nominal bit time (present during the data phase of an FD frame) from being mistaken for an idle condition.</p> <p>This field is writable only in Freeze mode.</p> <p>NOTE: See Bus Integration state in the CAN Protocol standard (ISO 11898-1) for details. 0b - Edge filter is enabled 1b - Edge filter is disabled</p>
10 —	Reserved
9-6 —	Reserved
5-0 —	Reserved

55.5.2.13 Error and Status 2 Register (ESR2)

55.5.2.13.1 Offset

Register	Offset
ESR2	38h

55.5.2.13.2 Function

This register reports some general status information.

55.5.2.13.3 Diagram

Bits	31	30	29	28	27	26	25	24	23	22	21	20	19	18	17	16
R	0								LPTM							
W	—															
Reset	0	0	0	0	0	0	0	0	0	0	0	0	0	0	0	0
Bits	15	14	13	12	11	10	9	8	7	6	5	4	3	2	1	0
R	0	VPS	IMB	0												
W	—															
Reset	0	0	0	0	0	0	0	0	0	0	0	0	0	0	0	0

55.5.2.13.4 Fields

Field	Function
31-23 —	Reserved
22-16 LPTM	<p>Lowest Priority Tx Mailbox</p> <p>If ESR2[VPS] is asserted, this field indicates the lowest number inactive mailbox (see the ESR2[IMB] bit description). If there is no inactive mailbox then the mailbox indicated depends on the value of CTRL1[LBUF]. If CTRL1[LBUF] is negated, then the mailbox indicated is the one that has the greatest arbitration value (see Highest-priority mailbox first). If CTRL1[LBUF] is asserted then the mailbox indicated is the highest number active Tx mailbox. If a Tx mailbox is being transmitted it is not considered in LPTM calculation. If ESR2[IMB] is not asserted and a frame is transmitted successfully, LPTM is updated with its mailbox number.</p>
15 —	Reserved
14 VPS	<p>Valid Priority Status</p> <p>This bit indicates whether ESR2[IMB] and ESR2[LPTM] contents are currently valid or not. It is asserted upon every complete Tx arbitration process unless the CPU writes to Control and Status word of a mailbox that has already been scanned, that is, it is behind Tx Arbitration Pointer, during the Tx arbitration process. If there is no inactive mailbox and only one Tx mailbox that is being transmitted then VPS is not asserted. This bit is negated upon the start of every Tx arbitration process or upon a write to Control and Status word of any mailbox.</p> <p>NOTE: ESR2[VPS] is not affected by any CPU write into Control Status (C/S) of an MB that is blocked by abort mechanism. When MCR[AEN] is asserted, the abort code write in C/S of an MB that is being transmitted (pending abort), or any write attempt into a Tx MB with IFLAG set is blocked.</p> <p>0b - Contents of IMB and LPTM are invalid. 1b - Contents of IMB and LPTM are valid.</p>
13 IMB	<p>Inactive Mailbox</p> <p>If ESR2[VPS] is asserted, this bit indicates whether there is any inactive mailbox (CODE field is either 1000b or 0b). This bit is asserted in the following cases:</p> <ul style="list-style-type: none"> • During arbitration, if an ESR2[LPTM] is found and it is inactive. • If ESR2[IMB] is not asserted and a frame is transmitted successfully. <p>This bit is always cleared in start of arbitration (see Arbitration process).</p> <p>NOTE: ESR2[LPTM] mechanism has the following behavior: if an MB is successfully transmitted and ESR2[IMB]=0 (no inactive mailbox), then ESR2[VPS] and ESR2[IMB] are asserted and the index related to the MB just transmitted is loaded into ESR2[LPTM].</p> <p>0b - If ESR2[VPS] is asserted, the ESR2[LPTM] is not an inactive mailbox. 1b - If ESR2[VPS] is asserted, there is at least one inactive mailbox. LPTM content is the number of the first one.</p>
12-0 —	Reserved

55.5.2.14 CRC Register (CRCR)

55.5.2.14.1 Offset

Register	Offset
CRCR	44h

55.5.2.14.2 Function

This register provides information about the CRC of transmitted messages for non-FD messages. This register only reports the 15 low order bits of CRC calculations for messages in CAN FD format that require either 17 or 21 bits. For CAN FD format frames, the FDCRC register must be used. This register is updated at the same time the Tx interrupt flag is asserted.

NOTE

See CRC sequence calculation in the CAN Protocol standard (ISO 11898-1) for details.

55.5.2.14.3 Diagram

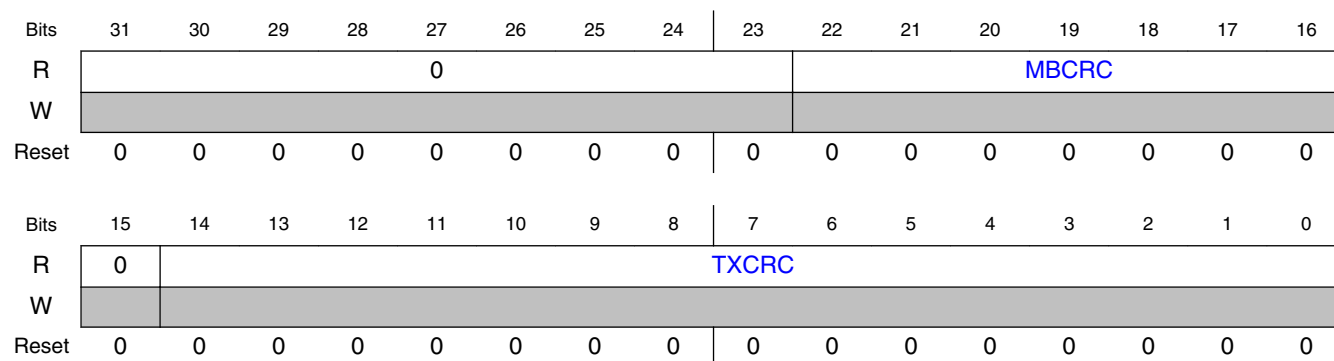

55.5.2.14.4 Fields

Field	Function
31-23 —	Reserved
22-16 MBCRC	CRC Mailbox This field indicates the number of the mailbox corresponding to the value in CRCR[TXCRC] field.
15 —	Reserved
14-0	Transmitted CRC value

Memory map/register definition

Field	Function
TXCRC	This field indicates the CRC value of the last transmitted message for non-FD frames. For FD frames, CRC value is reported in FDCRC register.

55.5.2.15 Rx FIFO Global Mask Register (RXFGMASK)

55.5.2.15.1 Offset

Register	Offset
RXFGMASK	48h

55.5.2.15.2 Function

This register is located in RAM.

If Rx FIFO is enabled, RXFGMASK is used to mask the Rx FIFO ID filter table elements that do not have a corresponding RXIMR according to CTRL2[RFFN] field setting.

This register can only be written in Freeze mode as it is blocked by hardware in other modes.

The following table shows how the FGM bits correspond to each IDAF field.

Table 55-24. Correspondence of Rx FIFO global mask bits to IDF fields

Rx FIFO ID filter table elements format (MCR[IDAM])	Identifier acceptance filter fields					Reserved
	RTR	IDE	RXIDA	RXIDB ¹	RXIDC ²	
A	FGM[31]	FGM[30]	FGM[29:1]	—	—	FGM[0]
B	FGM[31], FGM[15]	FGM[30], FGM[14]	—	FGM[29:16], FGM[13:0]	—	—
C	—	—	—	—	FGM[31:24], FGM[23:16], FGM[15:8], FGM[7:0]	—

1. If MCR[IDAM] is equivalent to format B, only the fourteen most significant bits of the identifier of the incoming frame are compared with the Rx FIFO filter.
2. If MCR[IDAM] is equivalent to format C, only the eight most significant bits of the identifier of the incoming frame are compared with the Rx FIFO filter.

55.5.2.15.3 Diagram

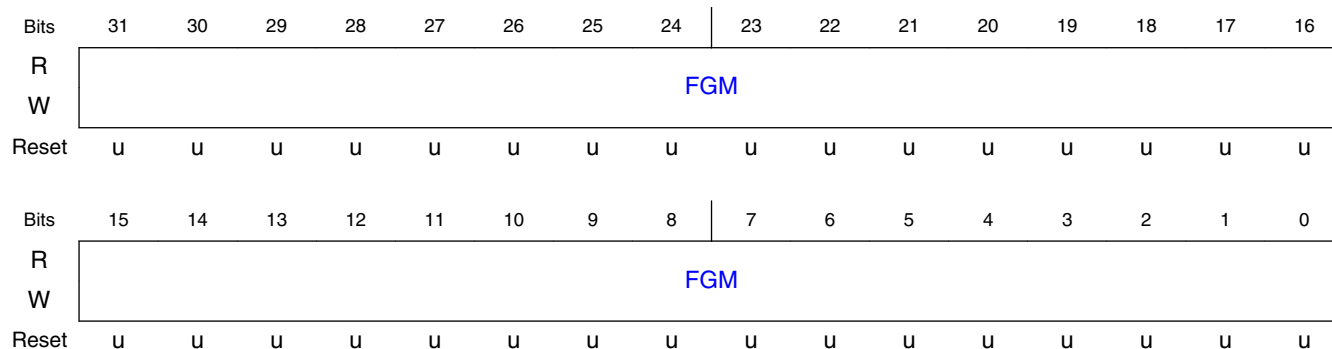

55.5.2.15.4 Fields

Field	Function
31-0	Rx FIFO Global Mask Bits
FGM	These bits mask the ID filter table elements bits in a perfect alignment. 0b - The corresponding bit in the filter is "don't care." 1b - The corresponding bit in the filter is checked.

55.5.2.16 Rx FIFO Information Register (RXFIR)

55.5.2.16.1 Offset

Register	Offset
RXFIR	4Ch

55.5.2.16.2 Function

RXFIR provides information on Rx FIFO.

This register is the port through which the CPU accesses the output of the RXFIR FIFO located in RAM. The RXFIR FIFO is written by the FlexCAN whenever a new message is moved into the Rx FIFO. Also, its output is updated whenever the output of the Rx FIFO is updated with the next message. See [Rx FIFO](#) for instructions on reading this register.

55.5.2.16.3 Diagram

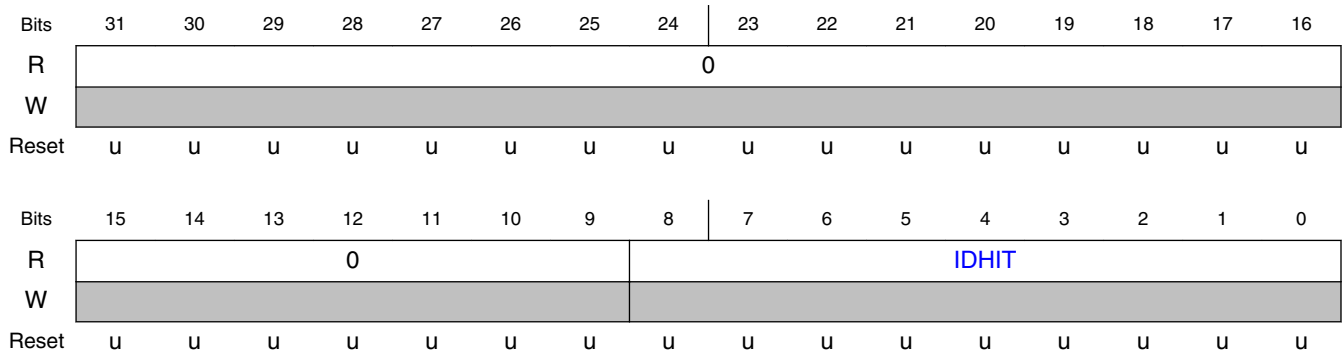

55.5.2.16.4 Fields

Field	Function
31-9 —	Reserved
8-0 IDHIT	Identifier Acceptance Filter Hit Indicator This field indicates which Identifier Acceptance filter was hit by the received message that is in the output of the Rx FIFO. If multiple filters match the incoming message ID then the first matching IDAF found (lowest number) by the matching process is indicated. This field is valid only when IFLAG1[BUF5!] is asserted.

55.5.2.17 CAN Bit Timing Register (CBT)

55.5.2.17.1 Offset

Register	Offset
CBT	50h

55.5.2.17.2 Function

This register is an alternative way to store the CAN bit timing variables described in CTRL1 register. EPRESDIV, EPROPSEG, EPSEG1, EPSEG2, and ERJW are extended versions of PRESDIV, PROPSEG, PSEG1, PSEG2, and RJW fields respectively.

The BTF bit selects the use of the timing variables defined in this register.

The contents of this register are not affected by soft reset.

NOTE

The CAN bit variables in CTRL1 and in CBT are stored in the same register.

NOTE

When the CAN FD feature is enabled (MCR[FDEN] is set), always set CBT[BTF].

NOTE

The user must ensure bit time settings and protocol engine tolerance are in compliance with the CAN Protocol standard (ISO 11898-1).

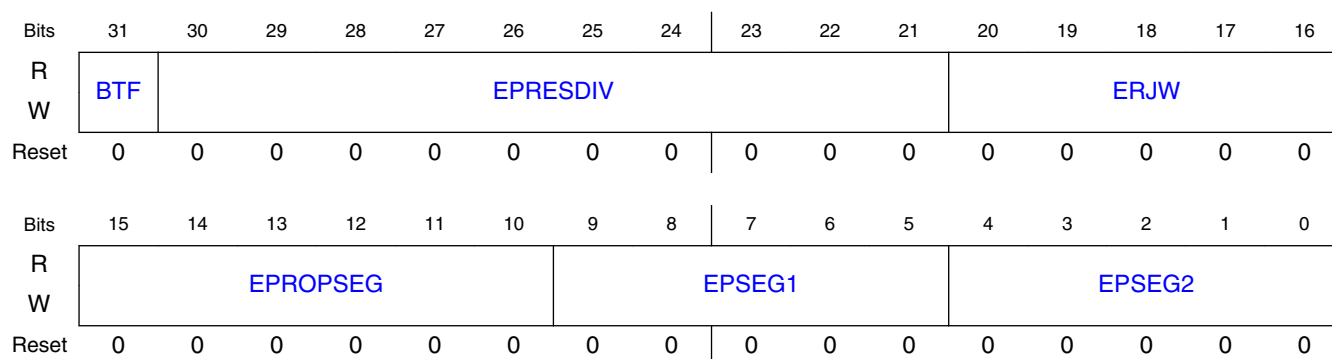
55.5.2.17.3 Diagram**55.5.2.17.4 Fields**

Field	Function
31 BTF	Bit Timing Format Enable Enables the use of extended CAN bit timing fields EPRES DIV, EPROPSEG, EPSEG1, EPSEG2. and ERJW replacing the CAN bit timing variables defined in CTRL1 register. This field can be written in Freeze mode only. 0b - Extended bit time definitions disabled. 1b - Extended bit time definitions enabled.
30-21 EPRES DIV	Extended Prescaler Division Factor This 10-bit field defines the ratio between the PE clock frequency and the serial clock (Sclock) frequency when CBT[BTF] is asserted, otherwise it has no effect. It extends the CTRL1[PRES DIV] value range. The Sclock period defines the time quantum of the CAN protocol. For the reset value, the Sclock frequency is equal to the PE clock frequency (see Protocol timing). This field can be written only in Freeze mode because it is blocked by hardware in other modes. Sclock frequency = PE clock frequency / (EPRES DIV + 1)
20-16 ERJW	Extended Resync Jump Width

Table continues on the next page...

Memory map/register definition

Field	Function
	<p>This 5-bit field defines the maximum number of time quanta that a bit time can be changed by one re-synchronization when CBT[BTF] bit is asserted, otherwise it has no effect. It extends the CTRL1[RJW] value range.</p> <p>One time quantum is equal to the Sclock period. This field can be written only in Freeze mode because it is blocked by hardware in other modes.</p> <p>Resync Jump Width = ERJW + 1.</p>
15-10 EPROPSEG	<p>Extended Propagation Segment</p> <p>This 6-bit field defines the length of the propagation segment in the bit time when CBT[BTF] bit is asserted, otherwise it has no effect. It extends the CTRL1[PROPSEG] value range. This field can be written only in Freeze mode because it is blocked by hardware in other modes.</p> <p>Propagation Segment Time = (EPROPSEG + 1) × Time-Quanta.</p> <p>Time-Quantum = one Sclock period.</p>
9-5 EPSEG1	<p>Extended Phase Segment 1</p> <p>This 5-bit field defines the length of phase segment 1 in the bit time when CBT[BTF] bit is asserted, otherwise it has no effect. It extends the CTRL1[PSEG1] value range. This field can be written only in Freeze mode because it is blocked by hardware in other modes.</p> <p>Phase Buffer Segment 1 = (EPSEG1 + 1) × Time-Quanta.</p> <p>Time-Quantum = one Sclock period.</p>
4-0 EPSEG2	<p>Extended Phase Segment 2</p> <p>This 5-bit field defines the length of phase segment 2 in the bit time when CBT[BTF] bit is asserted, otherwise it has no effect. It extends the CTRL1[PSEG2] value range. This field can be written only in Freeze mode because it is blocked by hardware in other modes.</p> <p>Phase Buffer Segment 1 = (EPSEG2 + 1) × Time-Quanta.</p> <p>Time-Quantum = one Sclock period.</p>

55.5.2.18 Rx Individual Mask Registers (RXIMR0 - RXIMR31)

55.5.2.18.1 Offset

For n = 0 to 31:

Register	Offset
RXIMRn	880h + (n × 4h)

55.5.2.18.2 Function

The RX Individual Mask registers are used to store the acceptance masks for ID filtering in Rx MBs and the Rx FIFO.

When the Rx FIFO is disabled (MCR[RFEN] bit is negated), an individual mask is provided for each available Rx mailbox on a one-to-one correspondence. When the Rx FIFO is enabled (MCR[RFEN] bit is asserted), an individual mask is provided for each Rx FIFO ID filter table element on a one-to-one correspondence depending on the setting of CTRL2[RFFN] (see [Rx FIFO](#)).

RXIMR0 stores the individual mask associated with either MB0 or ID filter table element 0, RXIMR1 stores the individual mask associated with either MB1 or ID filter table element 1, and so on.

RXIMR registers can only be accessed by the CPU when the module is in Freeze mode; otherwise, they are blocked by hardware. These registers are not affected by reset. They are located in RAM and must be explicitly initialized prior to any reception.

It is possible for the RXIMR memory region to be accessed as general purpose memory. See [Bus interface](#) for more information.

55.5.2.18.3 Diagram

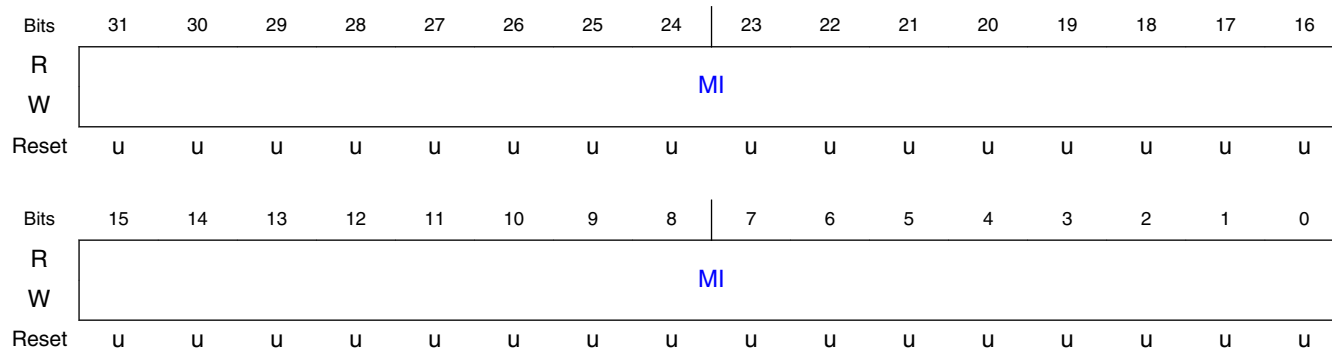

55.5.2.18.4 Fields

Field	Function
31-0	Individual Mask Bits
MI	<p>Each individual mask bit masks the corresponding bit in both the mailbox filter and Rx FIFO ID filter table element in distinct ways.</p> <p>For mailbox filters, see the RXMGMASK register description.</p> <p>For Rx FIFO ID filter table elements, see the RXFGMASK register description.</p> <p>0b - The corresponding bit in the filter is "don't care." 1b - The corresponding bit in the filter is checked.</p>

55.5.2.19 Pretended Networking Control 1 Register (CTRL1_PN)

55.5.2.19.1 Offset

Register	Offset
CTRL1_PN	B00h

55.5.2.19.2 Function

This register contains control bits for Pretended Networking mode filtering selection. Configure this register with the filter criteria to be used to receive wakeup messages. It can be written in Freeze mode only, except WTOF_MSK and WUMF_MSK bits.

NOTE

Each module instance supports a different number of registers.

Instance	Register supported	Register not supported
FlexCAN0	CTRL1_PN	—
FlexCAN1	—	CTRL1_PN
FlexCAN2	—	CTRL1_PN

55.5.2.19.3 Diagram

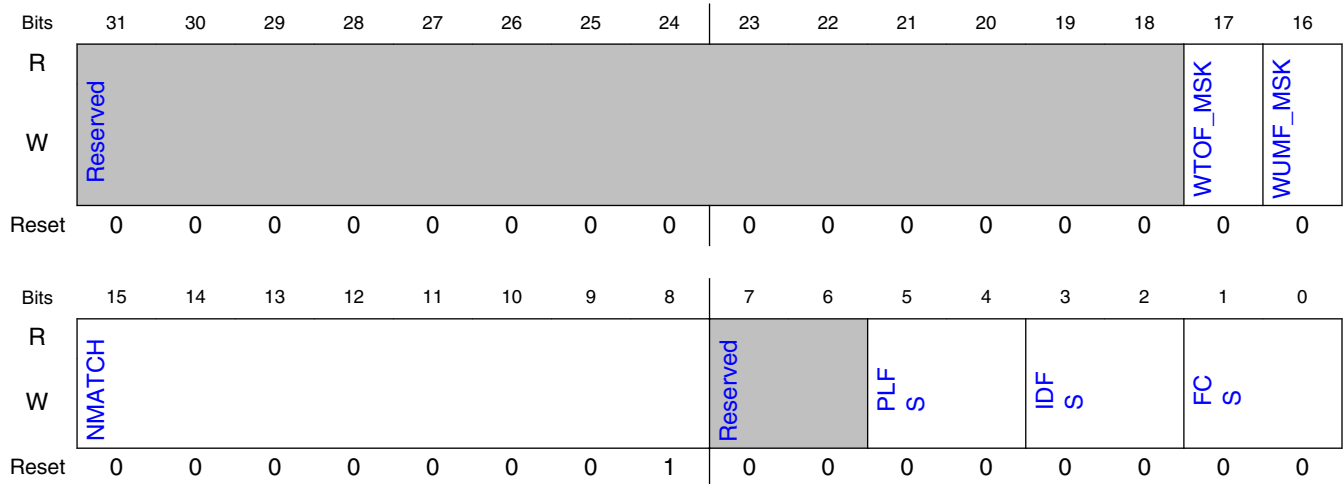

55.5.2.19.4 Fields

Field	Function
31-18 —	Reserved
17 WTOF_MSK	Wake Up by Timeout Flag Mask Bit This bit masks the generation of a wakeup event originated by a timeout. 0b - Timeout wakeup event is disabled 1b - Timeout wakeup event is enabled
16 WUMF_MSK	Wake Up by Match Flag Mask Bit This bit masks the generation of a wakeup event originated by a successful filtered Rx message. 0b - Wakeup match event is disabled 1b - Wakeup match event is enabled
15-8 NMATCH	Number of Messages Matching the Same Filtering Criteria This 8-bit field defines the number of times a given message must match the predefined filtering criteria for ID and/or PL before generating a wakeup event. This quantity can be configured in the 1 to 255 range by using values from 01h–FFh, respectively. 00000001b - Received message must match the predefined filtering criteria for ID and/or PL once before generating a wakeup event. 00000010b - Received message must match the predefined filtering criteria for ID and/or PL twice before generating a wakeup event. 11111111b - Received message must match the predefined filtering criteria for ID and/or PL 255 times before generating a wakeup event.
7-6 —	Reserved
5-4 PLFS	Payload Filtering Selection This 2-bit field selects the level of payload filtering to be applied when FlexCAN is under Pretended Networking mode. Filtering does not accept remote messages (RTR=1) when payload filtering is active. 00b - Match upon a payload contents against an exact target value 01b - Match upon a payload value greater than or equal to a specified target value 10b - Match upon a payload value smaller than or equal to a specified target value 11b - Match upon a payload value inside a range, greater than or equal to a specified lower limit, and smaller than or equal to a specified upper limit
3-2 IDFS	ID Filtering Selection This 2-bit field selects the level of ID filtering to be applied when FlexCAN is under Pretended Networking mode. In ID filtering, the IDE and RTR bits are also considered as part of the reception filter if IDE_MSK and RTR_MSK bits in the FLT_ID2_IDMASK register are set. 00b - Match upon ID contents against an exact target value 01b - Match upon an ID value greater than or equal to a specified target value 10b - Match upon an ID value smaller than or equal to a specified target value 11b - Match upon an ID value inside a range, greater than or equal to a specified lower limit, and smaller than or equal to a specified upper limit
1-0 FCS	Filtering Combination Selection This 2-bit field selects the filtering criteria to be applied when FlexCAN is under Pretended Networking mode. See Receive process under Pretended Networking mode for more details. 00b - Message ID filtering only 01b - Message ID filtering and payload filtering 10b - Message ID filtering occurring a specified number of times 11b - Message ID filtering and payload filtering a specified number of times

55.5.2.20 Pretended Networking Control 2 Register (CTRL2_PN)

55.5.2.20.1 Offset

Register	Offset
CTRL2_PN	B04h

55.5.2.20.2 Function

This register contains configuration bits for the timeout value under Pretended Networking mode. It can be written in Freeze mode only.

NOTE

Each module instance supports a different number of registers.

Instance	Register supported	Register not supported
FlexCAN0	CTRL2_PN	—
FlexCAN1	—	CTRL2_PN
FlexCAN2	—	CTRL2_PN

55.5.2.20.3 Diagram

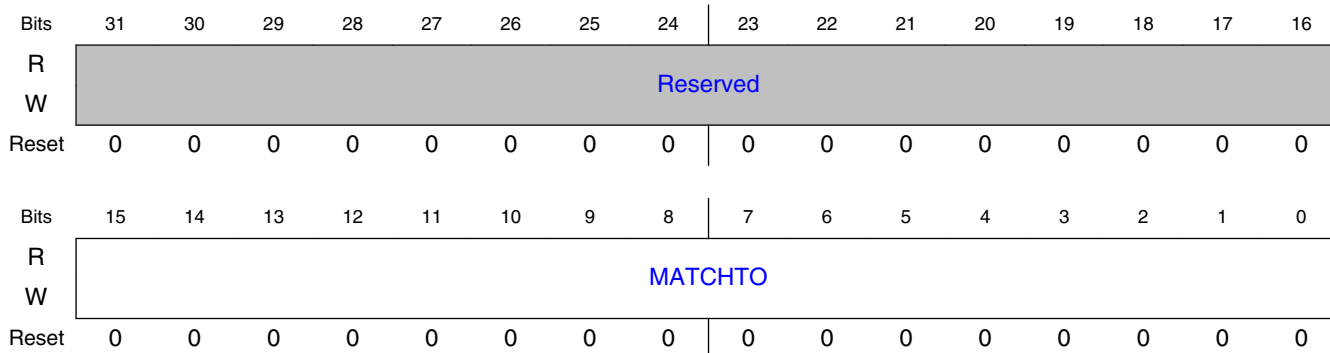

55.5.2.20.4 Fields

Field	Function
31-16	Reserved

Table continues on the next page...

Field	Function
—	
15-0 MATCHTO	<p>Timeout for No Message Matching the Filtering Criteria</p> <p>This 16-bit field defines a timeout value that generates a wakeup event if MCR[PNET_EN] is asserted. If the timeout counter reaches the target value, when FlexCAN is under Pretended Networking mode, then a wakeup event is generated. The timeout limit can be configured from 1 to 65535 to control an internal 16-bit up-count timer to produce a trigger upon reaching this configured value. The internal timer is incremented based on periodic time ticks, which period is 64 times the CAN Bit Time unit. When MATCHTO is configured with 0000h the timeout is disabled.</p>

55.5.2.21 Pretended Networking Wake Up Match Register (WU_MTC)

55.5.2.21.1 Offset

Register	Offset
WU_MTC	B08h

55.5.2.21.2 Function

This read-only register contains wakeup information related to the matching processes performed while FlexCAN receives frames under Pretended Networking mode.

NOTE

Each module instance supports a different number of registers.

Instance	Register supported	Register not supported
FlexCAN0	WU_MTC	—
FlexCAN1	—	WU_MTC
FlexCAN2	—	WU_MTC

55.5.2.21.3 Diagram

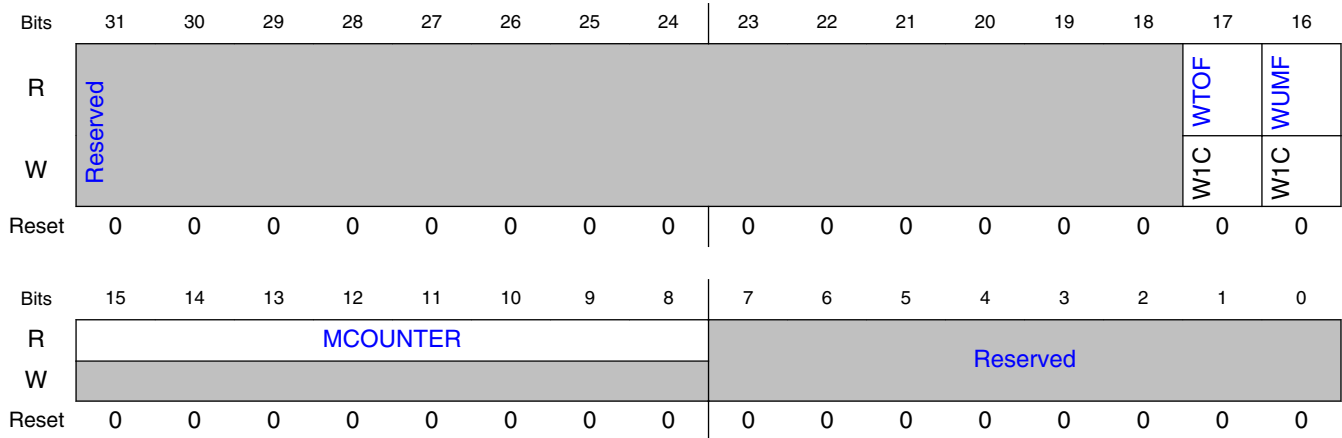

55.5.2.21.4 Fields

Field	Function
31-18 —	Reserved
17 WTOF	Wake Up by Timeout Flag Bit This bit identifies whether the FlexCAN has detected a timeout event during a time interval defined by CTRL2_PN[MATCHTO]. This flag generates a wakeup event if CTRL1_PN[WTOF_MSK] is enabled. 0b - No wakeup by timeout event detected 1b - Wakeup by timeout event detected
16 WUMF	Wake Up by Match Flag Bit This bit identifies whether the FlexCAN has detected a matching Rx incoming message, which passed the filtering criteria specified in CTRL1_PN register. This flag generates a wakeup event if CTRL1_PN[WUMF_MSK] is enabled. 0b - No wakeup by match event detected 1b - Wakeup by match event detected
15-8 MCOUNTER	Number of Matches when in Pretended Networking This 8-bit field reports the number of times a given message has matched the predefined filtering criteria for ID and/or PL before a wakeup event. This register is reset by FlexCAN when it enters in Pretended Networking mode, and is not affected by soft reset.
7-0 —	Reserved

55.5.2.22 Pretended Networking ID Filter 1 Register (FLT_ID1)

55.5.2.22.1 Offset

Register	Offset
FLT_ID1	B0Ch

55.5.2.22.2 Function

This register contains FLT_ID1 target value, as well as IDE and RTR target values used to filter an incoming message ID. The FLT_ID1 is used either for equal to, smaller than, greater than comparisons, or as the lower limit value in a ID range detection. It can be written in Freeze mode only.

NOTE

Each module instance supports a different number of registers.

Instance	Register supported	Register not supported
FlexCAN0	FLT_ID1	—
FlexCAN1	—	FLT_ID1
FlexCAN2	—	FLT_ID1

55.5.2.22.3 Diagram

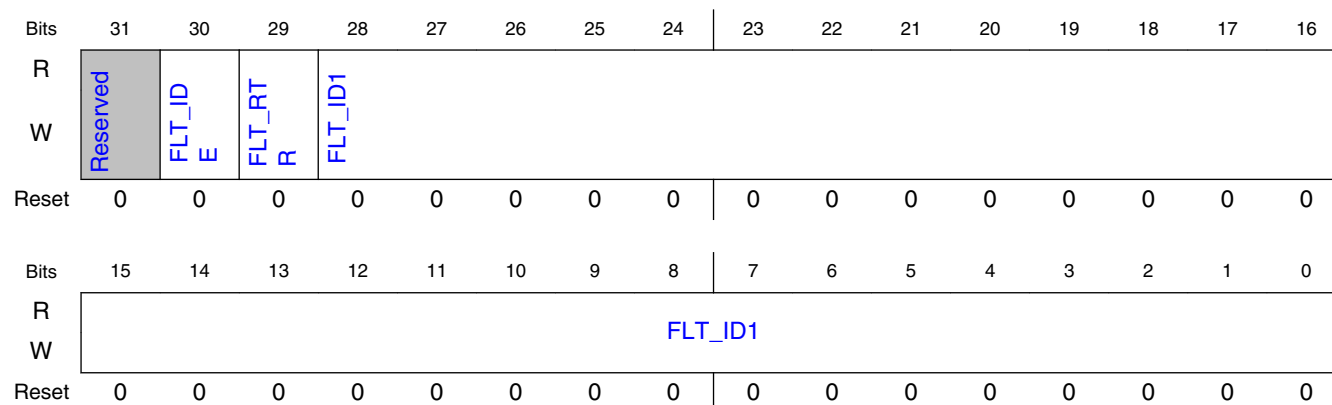

55.5.2.22.4 Fields

Field	Function
31	Reserved

Table continues on the next page...

Memory map/register definition

Field	Function
—	
30 FLT_IDE	ID Extended Filter This bit identifies whether the frame format is standard or extended. It is used as part of the ID reception filter. 0b - Accept standard frame format 1b - Accept extended frame format
29 FLT_RTR	Remote Transmission Request Filter This bit identifies whether the frame is remote or not. It is used as part of the ID reception filter. 0b - Reject remote frame (accept data frame) 1b - Accept remote frame
28-0 FLT_ID1	ID Filter 1 for Pretended Networking filtering This 29-bit field defines either the 29 bits of an extended frame format, considering all bits, or the 11 bits of a standard frame format, considering just the 11 leftmost bits.

55.5.2.23 Pretended Networking DLC Filter Register (FLT_DLC)

55.5.2.23.1 Offset

Register	Offset
FLT_DLC	B10h

55.5.2.23.2 Function

This register contains the DLC inside range target values (FLT_DLC_LO and FLT_DLC_HI) used to filter an incoming message. The DLC range is used only for payload filtering. It can be written in Freeze mode only.

NOTE

When a fixed quantity of data bytes is required, both FLT_DLC_LO and FLT_DLC_HI need to be configured with the same value, otherwise a range of DLC is considered for filtering (see [Receive process under Pretended Networking mode](#)).

NOTE

Each module instance supports a different number of registers.

Instance	Register supported	Register not supported
FlexCAN0	FLT_DLC	—
FlexCAN1	—	FLT_DLC
FlexCAN2	—	FLT_DLC

55.5.2.23.3 Diagram

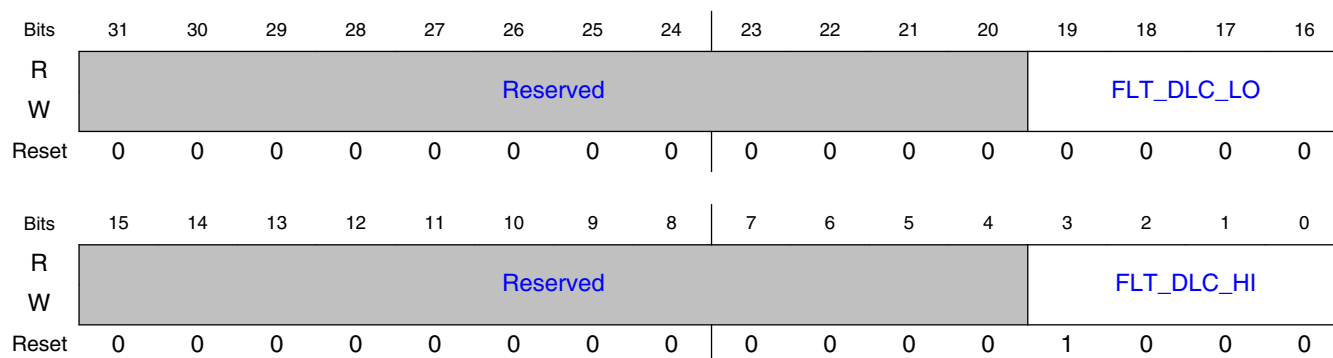

55.5.2.23.4 Fields

Field	Function
31-20 —	Reserved
19-16 FLT_DLC_LO	Lower Limit for Length of Data Bytes Filter This field specifies the lower limit for the number of data bytes considered valid for payload comparison. It is used as part of payload reception filter.
15-4 —	Reserved
3-0 FLT_DLC_HI	Upper Limit for Length of Data Bytes Filter This field specifies the upper limit for the number of data bytes considered valid for payload comparison. It is used as part of payload reception filter.

55.5.2.24 Pretended Networking Payload Low Filter 1 Register (PL1_LO)

55.5.2.24.1 Offset

Register	Offset
PL1_LO	B14h

55.5.2.24.2 Function

This register contains payload filter 1 low order bits of the target value used to filter incoming message payload. It is used either for “equal to”, “smaller than or equal”, “greater than or equal” comparisons, or as the lower limit value in a payload range detection. It can be written in Freeze mode only.

NOTE

Each module instance supports a different number of registers.

Instance	Register supported	Register not supported
FlexCAN0	PL1_LO	—
FlexCAN1	—	PL1_LO
FlexCAN2	—	PL1_LO

55.5.2.24.3 Diagram

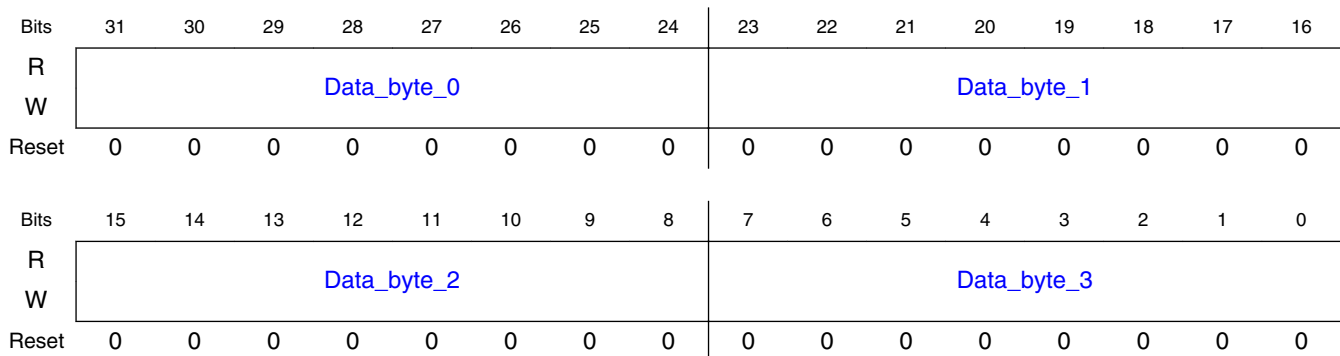

55.5.2.24.4 Fields

Field	Function
31-24 Data_byte_0	Payload Filter 1 low order bits for Pretended Networking payload filtering corresponding to data byte 0.
23-16	Payload Filter 1 low order bits for Pretended Networking payload filtering corresponding to data byte 1.

Table continues on the next page...

Field	Function
Data_byte_1	
15-8 Data_byte_2	Payload Filter 1 low order bits for Pretended Networking payload filtering corresponding to data byte 2.
7-0 Data_byte_3	Payload Filter 1 low order bits for Pretended Networking payload filtering corresponding to data byte 3.

55.5.2.25 Pretended Networking Payload High Filter 1 Register (PL1_HI)

55.5.2.25.1 Offset

Register	Offset
PL1_HI	B18h

55.5.2.25.2 Function

This register contains payload filter 1 high order bits of the target value used to filter incoming message payload. It is used either for equal to, smaller than or equal to, greater than or equal to comparisons, or as the lower limit value in a payload range detection. It can be written in Freeze mode only.

NOTE

Each module instance supports a different number of registers.

Instance	Register supported	Register not supported
FlexCAN0	PL1_HI	—
FlexCAN1	—	PL1_HI
FlexCAN2	—	PL1_HI

55.5.2.25.3 Diagram

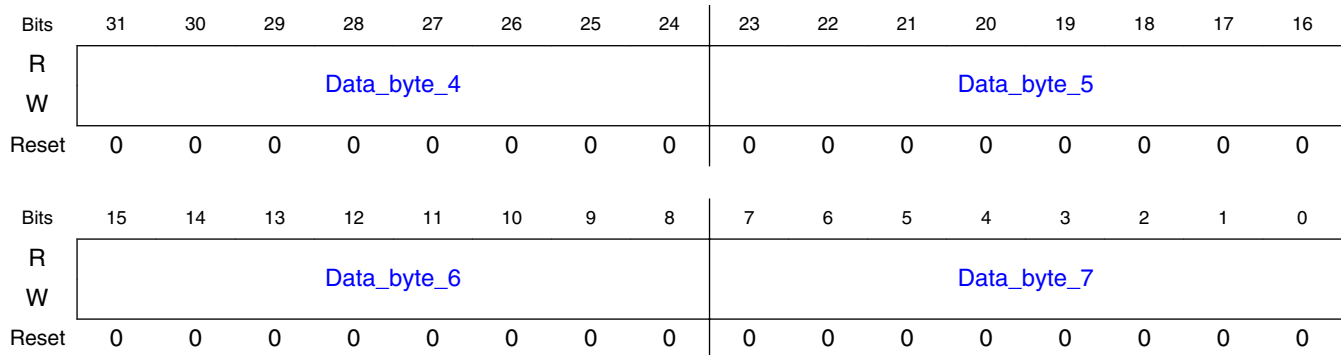

55.5.2.25.4 Fields

Field	Function
31-24 Data_byte_4	Payload Filter 1 high order bits for Pretended Networking payload filtering corresponding to data byte 4.
23-16 Data_byte_5	Payload Filter 1 high order bits for Pretended Networking payload filtering corresponding to data byte 5.
15-8 Data_byte_6	Payload Filter 1 high order bits for Pretended Networking payload filtering corresponding to data byte 6.
7-0 Data_byte_7	Payload Filter 1 high order bits for Pretended Networking payload filtering corresponding to data byte 7.

55.5.2.26 Pretended Networking ID Filter 2 Register / ID Mask Register (FLT_ID2_IDMASK)

55.5.2.26.1 Offset

Register	Offset
FLT_ID2_IDMASK	B1Ch

55.5.2.26.2 Function

This register contains FLT_ID2 target value used only as the upper limit value in ID range detection. Also, when exact ID filtering criteria is selected, this register is used to store the ID mask. IDE_MSK and RTR_MSK bits are used in both ID filtering (exact and

range) to enable FLT_IDE and FLT_RTR respectively to be used as part of ID reception filter. This register can be written in Freeze mode only.

NOTE

Each module instance supports a different number of registers.

Instance	Register supported	Register not supported
FlexCAN0	FLT_ID2_IDMASK	—
FlexCAN1	—	FLT_ID2_IDMASK
FlexCAN2	—	FLT_ID2_IDMASK

55.5.2.26.3 Diagram

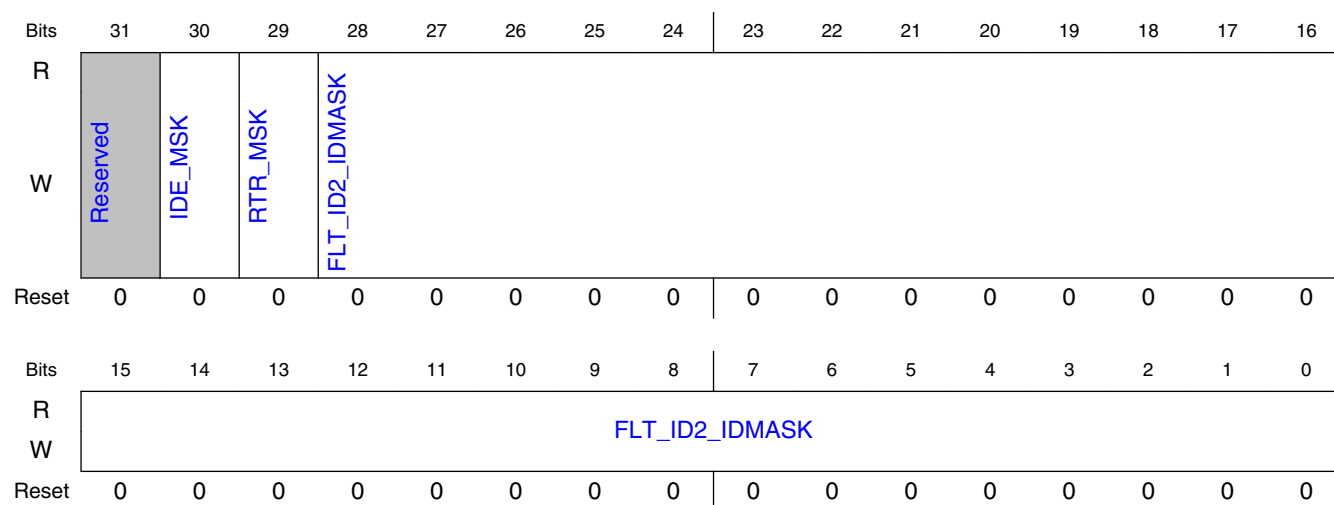

55.5.2.26.4 Fields

Field	Function
31 —	Reserved
30 IDE_MSK	ID Extended Mask Bit This bit indicates whether the frame format (standard/extended) is used as part of the ID reception filter. 0b - The corresponding bit in the filter is “don’t care” 1b - The corresponding bit in the filter is checked
29 RTR_MSK	Remote Transmission Request Mask Bit This bit indicates whether the frame type (data/remote) is part of the ID reception filter. 0b - The corresponding bit in the filter is “don’t care” 1b - The corresponding bit in the filter is checked

Table continues on the next page...

Memory map/register definition

Field	Function
28-0 FLT_ID2_IDMASK	<p>ID Filter 2 for Pretended Networking Filtering / ID Mask Bits for Pretended Networking ID Filtering</p> <p>This register is used to define either the ID filter value in extended frame format (29 bits), considering the FLT_ID2[28:0], or the ID filter value in standard frame format (11 bits), considering the FLT_ID2[28:18] (other bits in the [17:0] range have no meaning). Used only in range of ID filtering.</p> <p>It can also be used to define either the mask values for the extended frame format (29 bits), considering the IDMASK[28:0], or for the standard frame format (11 bits), considering the IDMASK[28:18] (other bits in the [17:0] range have no meaning). Used only in exact ID filtering.</p>

55.5.2.27 Pretended Networking Payload Low Filter 2 Register / Payload Low Mask register (PL2_PLMASK_LO)

55.5.2.27.1 Offset

Register	Offset
PL2_PLMASK_LO	B20h

55.5.2.27.2 Function

This register has two functions. First, it contains the low order bits for the payload filter 2 used only as the upper limit value in a payload range detection. Second, when exact payload filtering criteria is selected, this register is used as payload mask. Otherwise, this register is unused. It can be written in Freeze mode only.

NOTE

Each module instance supports a different number of registers.

Instance	Register supported	Register not supported
FlexCAN0	PL2_PLMASK_LO	—
FlexCAN1	—	PL2_PLMASK_LO
FlexCAN2	—	PL2_PLMASK_LO

55.5.2.27.3 Diagram

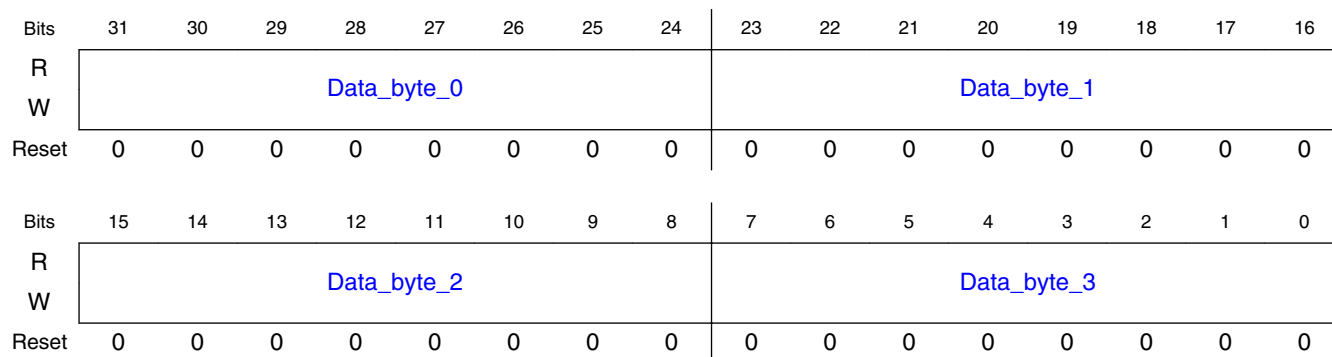

55.5.2.27.4 Fields

Field	Function
31-24 Data_byte_0	Payload Filter 2 low order bits / Payload Mask low order bits for Pretended Networking payload filtering corresponding to the data byte 0.
23-16 Data_byte_1	Payload Filter 2 low order bits / Payload Mask low order bits for Pretended Networking payload filtering corresponding to the data byte 1.
15-8 Data_byte_2	Payload Filter 2 low order bits / Payload Mask low order bits for Pretended Networking payload filtering corresponding to the data byte 2.
7-0 Data_byte_3	Payload Filter 2 low order bits / Payload Mask low order bits for Pretended Networking payload filtering corresponding to the data byte 3.

55.5.2.28 Pretended Networking Payload High Filter 2 low order bits / Payload High Mask register (PL2_PLMASK_HI)

55.5.2.28.1 Offset

Register	Offset
PL2_PLMASK_HI	B24h

55.5.2.28.2 Function

This register has two functions. First, it contains the high order bits for the Payload Filter 2 used only as the upper limit value in a payload range detection. Second, when exact payload filtering criteria is selected, this register is used as payload mask. Otherwise, this register is unused. It can be written in Freeze mode only.

NOTE

Each module instance supports a different number of registers.

Instance	Register supported	Register not supported
FlexCAN0	PL2_PLMASK_HI	—
FlexCAN1	—	PL2_PLMASK_HI
FlexCAN2	—	PL2_PLMASK_HI

55.5.2.28.3 Diagram

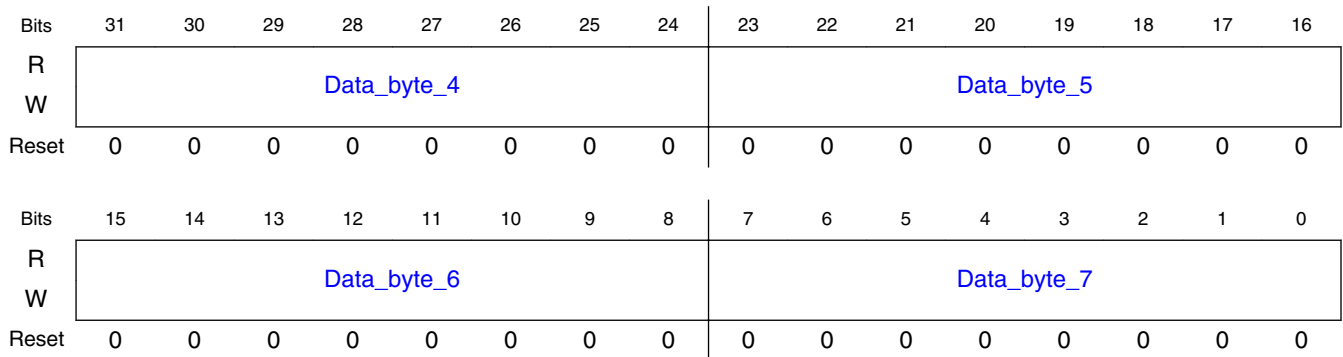

55.5.2.28.4 Fields

Field	Function
31-24 Data_byte_4	Payload Filter 2 high order bits / Payload Mask high order bits for Pretended Networking payload filtering corresponding to the data byte 4.
23-16 Data_byte_5	Payload Filter 2 high order bits / Payload Mask high order bits for Pretended Networking payload filtering corresponding to the data byte 5.
15-8 Data_byte_6	Payload Filter 2 high order bits / Payload Mask high order bits for Pretended Networking payload filtering corresponding to the data byte 6.
7-0 Data_byte_7	Payload Filter 2 high order bits / Payload Mask high order bits for Pretended Networking payload filtering corresponding to the data byte 7.

55.5.2.29 Wake Up Message Buffer register for C/S (WMB0_CS - WMB3_CS)

55.5.2.29.1 Offset

Register	Offset
WMB0_CS	B40h
WMB1_CS	B50h
WMB2_CS	B60h
WMB3_CS	B70h

55.5.2.29.2 Function

Each of the four WMBs contains a register to store the Control Status (C/S) information (IDE, RTR, and DLC fields) of an incoming Rx message.

NOTE

The C/S registers are located at B40h for WMB0, B50h for WMB1, B60h for WMB2, and B70h for WMB3.

NOTE

Each module instance supports a different number of registers.

Instance	Register supported	Register not supported
FlexCAN0	WMB0_CS–WMB3_CS	—
FlexCAN1	—	WMB0_CS–WMB3_CS
FlexCAN2	—	WMB0_CS–WMB3_CS

55.5.2.29.3 Diagram

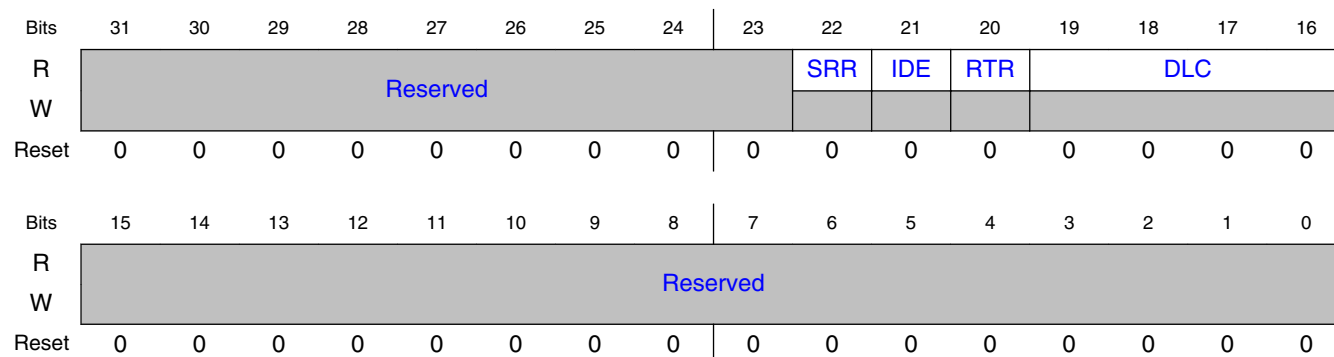

55.5.2.29.4 Fields

Field	Function
31-23 —	Reserved
22 SRR	Substitute Remote Request This bit can be received either recessive or dominant.
21 IDE	ID Extended Bit This bit identifies whether the frame format is standard or extended. 0b - Frame format is standard 1b - Frame format is extended
20 RTR	Remote Transmission Request Bit This bit identifies whether the frame is remote or not. 0b - Frame is data one (not remote) 1b - Frame is a remote one
19-16 DLC	Length of Data in Bytes This 4-bit field is the length (in bytes) of the Rx data received when FlexCAN is in Pretended Networking mode. This 4-bit field is written by the FlexCAN module, copied from the DLC (Data Length Code) field of the received frame. The DLC field indicates which data bytes are valid.
15-0 —	Reserved

55.5.2.30 Wake Up Message Buffer Register for ID (WMB0_ID - WMB3_ID)

55.5.2.30.1 Offset

Register	Offset
WMB0_ID	B44h
WMB1_ID	B54h
WMB2_ID	B64h
WMB3_ID	B74h

55.5.2.30.2 Function

Each of the four WMBs contains a register to store the ID information of an incoming Rx message.

NOTE

The ID registers are located at B44h for WMB0, B54h for WMB1, B64h for WMB2, and B74h for WMB3.

NOTE

Each module instance supports a different number of registers.

Instance	Register supported	Register not supported
FlexCAN0	WMB0_ID–WMB3_ID	—
FlexCAN1	—	WMB0_ID–WMB3_ID
FlexCAN2	—	WMB0_ID–WMB3_ID

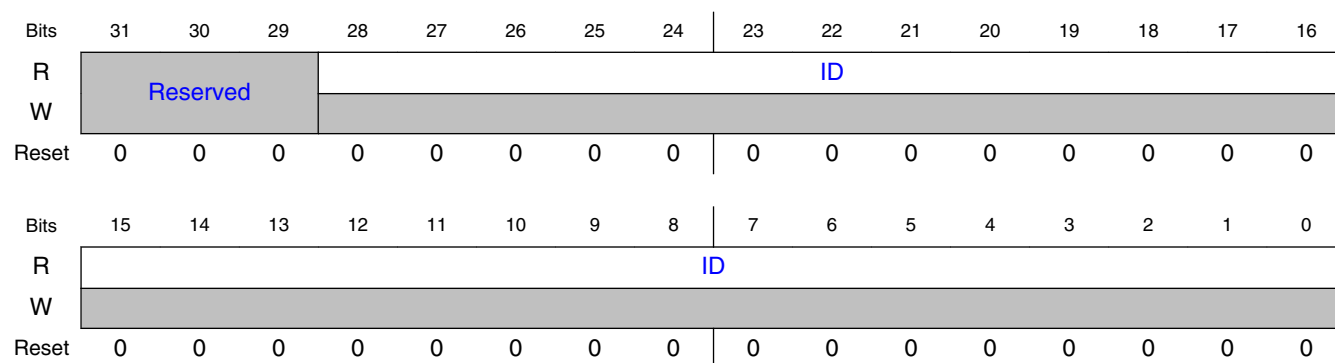
55.5.2.30.3 Diagram**55.5.2.30.4 Fields**

Field	Function
31-29 —	Reserved
28-0 ID	Received ID under Pretended Networking mode This register stores either the 29 bits of the extended frame format (considering the ID[28:0] field), or the 11 bits of the standard frame format (considering the ID[28:18] field only; the remaining bits in the ID[17:0] range have no meaning).

55.5.2.31 Wake Up Message Buffer Register for Data 0-3 (WMB0_D03 - WMB3_D03)

55.5.2.31.1 Offset

Register	Offset
WMB0_D03	B48h
WMB1_D03	B58h
WMB2_D03	B68h
WMB3_D03	B78h

55.5.2.31.2 Function

Each of the four WMBs contains a register to store the data bytes 0 to 3 of the payload information of an incoming Rx message. This register's content is cleared when the incoming matched message is either a remote frame (RTR=1) or a data frame with DLC=0.

NOTE

The Data 0-3 registers are located at B48h for WMB0, B58h for WMB1, B68h for WMB2, and B78h for WMB3.

NOTE

Each module instance supports a different number of registers.

Instance	Register supported	Register not supported
FlexCAN0	WMB0_D03–WMB3_D03	—
FlexCAN1	—	WMB0_D03–WMB3_D03
FlexCAN2	—	WMB0_D03–WMB3_D03

55.5.2.31.3 Diagram

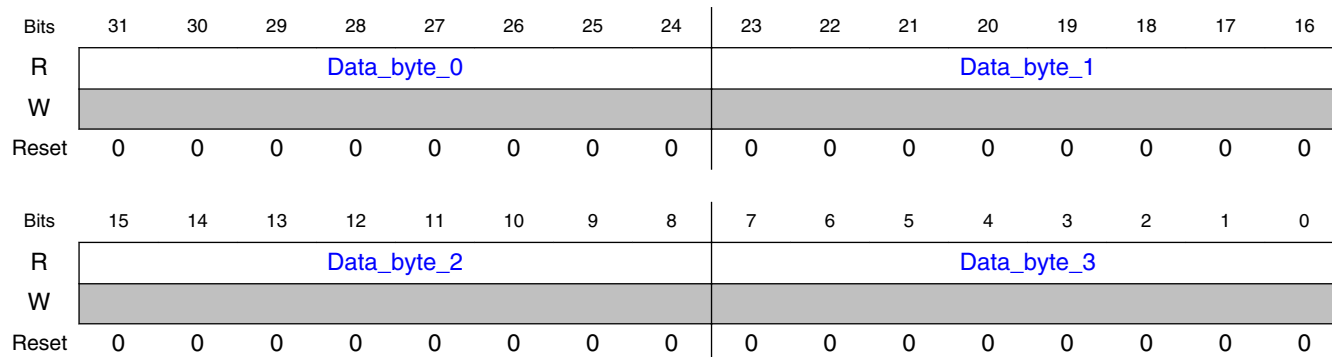

55.5.2.31.4 Fields

Field	Function
31-24 Data_byte_0	Received payload corresponding to the data byte 0 under Pretended Networking mode
23-16 Data_byte_1	Received payload corresponding to the data byte 1 under Pretended Networking mode
15-8 Data_byte_2	Received payload corresponding to the data byte 2 under Pretended Networking mode
7-0 Data_byte_3	Received payload corresponding to the data byte 3 under Pretended Networking mode

55.5.2.32 Wake Up Message Buffer Register Data 4-7 (WMB0_D47 - WMB3_D47)

55.5.2.32.1 Offset

Register	Offset
WMB0_D47	B4Ch
WMB1_D47	B5Ch
WMB2_D47	B6Ch
WMB3_D47	B7Ch

55.5.2.32.2 Function

Each of the four WMBs contains a register to store the data bytes 4 to 7 of the payload information of an incoming Rx message. This register's content is cleared when the incoming matched message is either a remote frame (RTR=1) or a data frame with DLC=0.

NOTE

The Data 4-7 registers are located at B4Ch for WMB0, B5Ch for WMB1, B6Ch for WMB2, and B7Ch for WMB3.

NOTE

Each module instance supports a different number of registers.

Instance	Register supported	Register not supported
FlexCAN0	WMB0_D47–WMB3_D47	—
FlexCAN1	—	WMB0_D47–WMB3_D47
FlexCAN2	—	WMB0_D47–WMB3_D47

55.5.2.32.3 Diagram

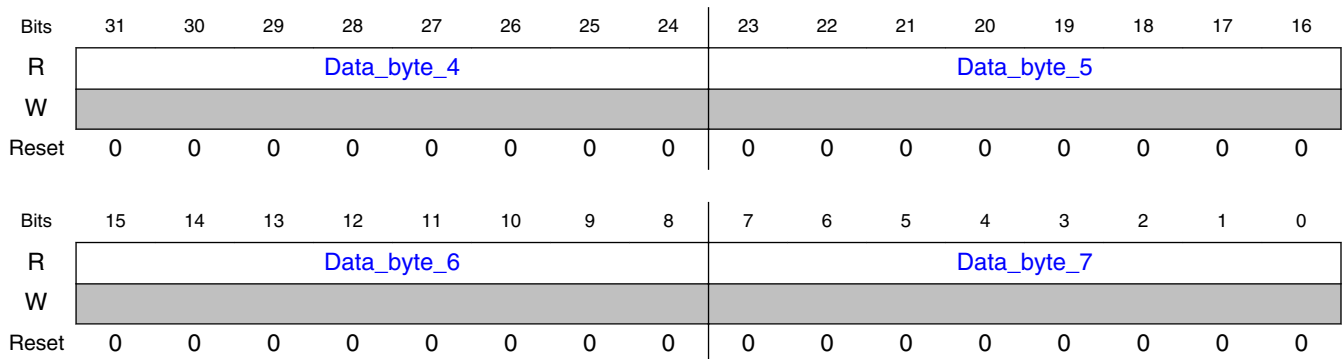

55.5.2.32.4 Fields

Field	Function
31-24 Data_byte_4	Received payload corresponding to the data byte 4 under Pretended Networking mode
23-16 Data_byte_5	Received payload corresponding to the data byte 5 under Pretended Networking mode
15-8	Received payload corresponding to the data byte 6 under Pretended Networking mode

Table continues on the next page...

Field	Function
Data_byte_6	
7-0 Data_byte_7	Received payload corresponding to the data byte 7 under Pretended Networking mode

55.5.2.33 CAN FD Control Register (FDCTRL)

55.5.2.33.1 Offset

Register	Offset
FDCTRL	C00h

55.5.2.33.2 Function

This register contains control bits for the CAN FD operation. It also defines the data size of message buffers allocated in different partitions of RAM (memory blocks) as described in the table below.

When an 8-byte payload is selected:

- Block R0 allocates MB0 to MB31.
- Block R1 allocates MB32 to MB63.

When a payload larger than 8 bytes is selected, the maximum number of MBs in a block is limited as described below:

Table 55-25. Number of message buffers

Payload size	Maximum number of message buffers per RAM block
8 bytes	32
16 bytes	21
32 bytes	12
64 bytes	7

NOTE

One memory block fits exactly 32 MBs with an 8-byte payload. For other possible payload sizes, empty memory may exist between the last MB in a block and the beginning of the next

Memory map/register definition

block. This empty memory corresponds to less than one MB, and must not be used.

The contents of this register are not affected by soft reset.

55.5.2.33.3 Diagram

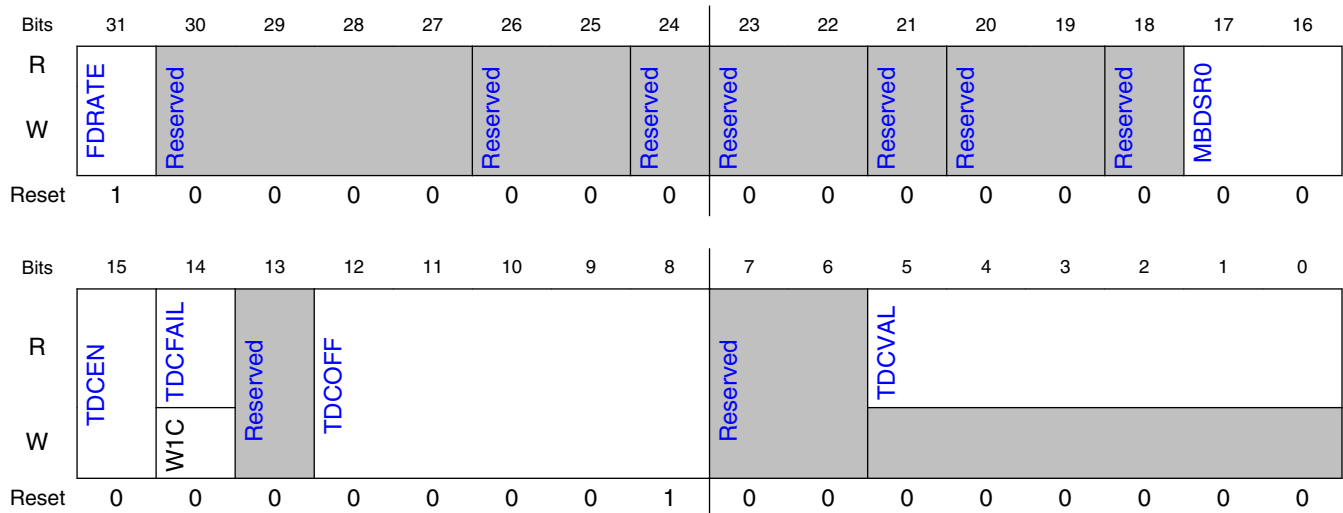

55.5.2.33.4 Fields

Field	Function
31 FDRATE	<p>Bit Rate Switch Enable</p> <p>This bit enables the effect of the Bit Rate Switch (BRS bit) during the data phase of Tx messages. The CPU can write this bit any time. However, its effect turns active only when the CAN bus is in Wait for Bus Idle, Bus Idle, or Bus Off state, or when the current frame under reception or transmission reaches the interframe space.</p> <p>By negating FDCTRL[FDRATE], the CPU can force all bits in CAN FD messages to be transmitted in nominal bit rate, no matter what the value is in the BRS bit of the Tx MBs.</p> <p>0b - Transmit a frame in nominal rate. The BRS bit in the Tx MB has no effect. 1b - Transmit a frame with bit rate switching if the BRS bit in the Tx MB is recessive.</p>
30-27 —	Reserved
26-25 —	Reserved
24 —	Reserved
23-22 —	Reserved
21	Reserved

Table continues on the next page...

Field	Function
—	
20-19 —	Reserved
18 —	Reserved
17-16 MBDSR0	<p>Message Buffer Data Size for Region 0</p> <p>This two-bit field selects the data size (8, 16, 32, or 64 bytes) for region R0 of message buffers allocated in RAM.</p> <p>It can be written in Freeze mode only.</p> <p>00b - Selects 8 bytes per message buffer. 01b - Selects 16 bytes per message buffer. 10b - Selects 32 bytes per message buffer. 11b - Selects 64 bytes per message buffer.</p>
15 TDCEN	<p>Transceiver Delay Compensation Enable</p> <p>This bit can be used to enable and disable the TDC feature. It can be written in Freeze mode only.</p> <p>NOTE: See Transmitter delay compensation in the CAN Protocol standard (ISO 11898-1) for details. NOTE: TDC must be disabled when Loop Back mode is enabled (see CTRL1[LPB]).</p> <p>0b - TDC is disabled 1b - TDC is enabled</p>
14 TDCFAIL	<p>Transceiver Delay Compensation Fail</p> <p>This bit indicates when the Transceiver Delay Compensation (TDC) mechanism is out of range, unable to compensate the transceiver's loop delay and successfully compare the delayed received bits to the transmitted ones (see Transceiver delay compensation). TDCFAIL sets in the first time FlexCAN detects the out of range condition. The CPU needs to write one to clear it.</p> <p>0b - Measured loop delay is in range. 1b - Measured loop delay is out of range.</p>
13 —	Reserved
12-8 TDCOFF	<p>Transceiver Delay Compensation Offset</p> <p>This bit field contains the offset value to be added to the measured transceiver's loop delay in order to define the position of the delayed comparison point when bit rate switching is active. See Transceiver delay compensation for more details on how the loop delay measurement is performed.</p> <p>TDCOFF can be written in Freeze mode only. Its value can be defined in Protocol Engine (PE) Clock periods (CANCLK, see Protocol timing for more details), and must be selected to be smaller than the CAN bit duration in the data bit rate for proper operation.</p> <p>NOTE: It is not recommended to have TDCOFF equal to zero.</p>
7-6 —	Reserved
5-0 TDCVAL	<p>Transceiver Delay Compensation Value</p> <p>This register contains the value of the transceiver loop delay measured from the transmitted EDL to R0 transition edge to the respective received one added to the TDCOFF value specified in the FDCTRL register. This value is an integer multiple of the Protocol Engine (PE) Clock period (CANCLK).</p> <p>See Protocol timing for more details on how the loop delay measurement is performed.</p>

55.5.2.34 CAN FD Bit Timing Register (FDCBT)

55.5.2.34.1 Offset

Register	Offset
FDCBT	C04h

55.5.2.34.2 Function

This register stores the CAN bit timing variables used in the data phase of CAN FD messages when the FDCTRL[FDRATE] is set, compatible with CAN FD specification. FPRES DIV, FPROPSEG, FPSEG1, FPSEG2, and FRJW are used to define the time quantum duration, the number of time quanta per CAN bit, and the sample point position for the data bit rate portion of a CAN FD message with the BRS bit set.

The contents of this register are not affected by soft reset.

NOTE

The sum of the Fast Propagation Segment (FPROPSEG) and Fast Phase Segment 1 (FPSEG1) must be at least two time quanta.

NOTE

The user must ensure bit time settings and protocol engine tolerance are in compliance with the CAN Protocol standard (ISO 11898-1).

55.5.2.34.3 Diagram

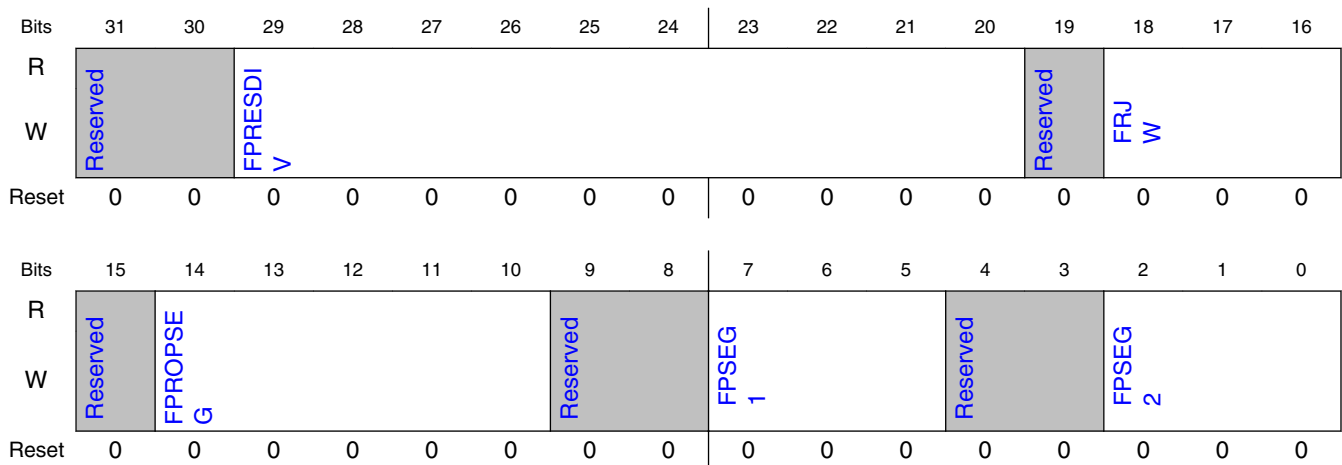

55.5.2.34.4 Fields

Field	Function
31-30 —	Reserved
29-20 FPRES DIV	<p>Fast Prescaler Division Factor</p> <p>This 10-bit field defines the ratio between the PE clock frequency and the serial clock (Sclock) frequency in the data bit rate portion of a CAN FD message with the BRS bit set.</p> <p>The Sclock period defines the time quantum of the CAN FD protocol for the data bit rate. This field can be written only in Freeze mode because it is blocked by hardware in other modes.</p> <p>Sclock frequency = PE clock frequency / (FPRES DIV + 1).</p> <p>NOTE: To minimize errors when processing FD frames, use the same value for FPRES DIV and PRES DIV (in CBT or CTRL1). For more details see the first NOTE in section CAN FD frames.</p>
19 —	Reserved
18-16 FRJW	<p>Fast Resync Jump Width</p> <p>This 3-bit field defines the maximum number of time quanta that a bit time can be changed by one resynchronization in the data bit rate portion of a CAN FD message with the BRS bit set.</p> <p>One time quantum is equal to the Sclock period. This field can be written only in Freeze mode because it is blocked by hardware in other modes.</p> <p>Resync Jump Width = FSJW + 1.</p>
15 —	Reserved
14-10 FPROPSEG	<p>Fast Propagation Segment</p> <p>This 5-bit field defines the length of the propagation segment in the bit time in the data bit rate portion of a CAN FD message with the BRS bit set. This field can be written only in Freeze mode because it is blocked by hardware in other modes.</p> <p>Propagation Segment Time = FPROPSEG × Time-Quanta.</p> <p>Time-Quantum = one Sclock period.</p>
9-8 —	Reserved
7-5 FPSEG1	<p>Fast Phase Segment 1</p> <p>This 3-bit field defines the length of phase segment 1 in the bit time in the data bit rate portion of a CAN FD message with the BRS bit set. This field can be written only in Freeze mode because it is blocked by hardware in other modes.</p> <p>Phase Segment 1 = (FPSEG1 + 1) × Time-Quanta.</p> <p>Time-Quantum = one Sclock period.</p>
4-3 —	Reserved
2-0 FPSEG2	Fast Phase Segment 2

Memory map/register definition

Field	Function
	<p>This 3-bit field defines the length of phase segment 2 in the data bit rate portion of a CAN FD message with the BRS bit set. This field can be written only in Freeze mode because it is blocked by hardware in other modes.</p> <p>Phase Segment 2 = (FPSEG2 + 1) × Time-Quanta.</p> <p>Time-Quantum = one Sclock period.</p>

55.5.2.35 CAN FD CRC Register (FDCRC)

55.5.2.35.1 Offset

Register	Offset
FDCRC	C08h

55.5.2.35.2 Function

This register provides information about the CRC of transmitted messages.

FlexCAN uses different CRC polynomials for different frame formats, as shown below.

The CRC_15 polynomial is used for all frames in CAN format. The CRC_17 polynomial is used for frames in CAN FD format with a DATA FIELD up to sixteen bytes. The CRC_21 polynomial is used for frames in CAN FD format with a DATA FIELD longer than sixteen bytes. Each polynomial shown below results in a Hamming distance of 6. This register is updated at the same time the Tx Interrupt flag is asserted.

$$\text{CRC_15} = \text{C599h}: (x^{15} + x^{14} + x^{10} + x^8 + x^7 + x^4 + x^3 + 1)$$

$$\text{CRC_17} = \text{3685Bh}: (x^{17} + x^{16} + x^{14} + x^{13} + x^{11} + x^6 + x^4 + x^3 + x^1 + 1)$$

$$\text{CRC_21} = \text{302899h}: (x^{21} + x^{20} + x^{13} + x^{11} + x^7 + x^4 + x^3 + 1)$$

Figure 55-28. CRC polynomial used on CAN frame

NOTE

See CRC sequence calculation in the CAN Protocol standard (ISO 11898-1) for details.

55.5.2.35.3 Diagram

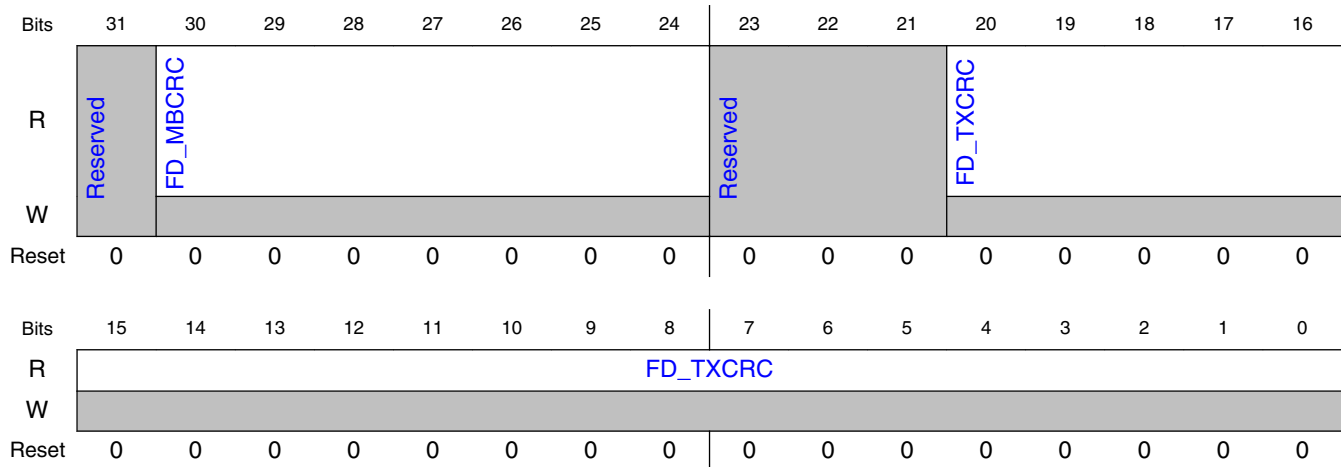

55.5.2.35.4 Fields

Field	Function
31 —	Reserved
30-24 FD_MBCRC	CRC Mailbox Number for FD_TXCRC This field indicates the number of the mailbox corresponding to the value in the FD_TXCRC field, for both FD and non-FD frames. It reports the same information as in CRCR[MBCRC].
23-21 —	Reserved
20-0 FD_TXCRC	Extended Transmitted CRC value This 21-bit field contains the CRC value calculated over the most recent transmitted message. Different CRC polynomials are used for different frame formats. A 15-bit polynomial, CRC_15, is used for all frames in CAN format. The second 17-bit polynomial, CRC_17, is used for frames in CAN FD format with a data field up to sixteen bytes long. The third 21-bit polynomial, CRC_21, is used for frames in CAN FD format with a data field longer than sixteen bytes. For CRC_15 and CRC_17, the 6 most significant bits and the 4 most significant bits are reported as zeros, respectively. For CRC_15, this register has the same content as CRC register.

55.5.3 Message buffer structure

The message buffer structure used by the FlexCAN module is represented in the following figure. Both extended (29-bit identifier) and standard (11-bit identifier) frames used in the CAN specification (Version 2.0 Part B) are represented. Each individual MB is formed by 16, 24, 40, or 72 bytes, depending on the quantity of data bytes allocated for the message payload: 8, 16, 32, or 64 data bytes, respectively.

The memory area 80h–27Fh is used by the mailboxes. When CAN FD is enabled, the exact address for each MB depends on the size of its payload. See [FlexCAN memory partition for CAN FD](#) for more detailed information.

Table 55-26. Message buffer structure — example with 64-byte payload

	31	30	29	28	27	24	23	22	21	20	19	18	17	16	15	8	7	0	
0h	EDL	BRS	ESI		CODE		SRR	IDE	RTR		DLC			TIME STAMP					
4h	PRIO			ID (standard/extended)							ID (extended)								
8h	Data byte 0					Data byte 1					Data byte 2			Data byte 3					
Ch	Data byte 4					Data byte 5					Data byte 6			Data byte 7					
10h	Data byte 8					Data byte 9					Data byte 10			Data byte 11					
14h	Data byte 12					Data byte 13					Data byte 14			Data byte 15					
18h	Data byte 16					Data byte 17					Data byte 18			Data byte 19					
1Ch	Data byte 20					Data byte 21					Data byte 22			Data byte 23					
20h	Data byte 24					Data byte 25					Data byte 26			Data byte 27					
24h	Data byte 28					Data byte 29					Data byte 30			Data byte 31					
28h	Data byte 32					Data byte 33					Data byte 34			Data byte 35					
2Ch	Data byte 36					Data byte 37					Data byte 38			Data byte 39					
30h	Data byte 40					Data byte 41					Data byte 42			Data byte 43					
34h	Data byte 44					Data byte 45					Data byte 46			Data byte 47					
38h	Data byte 48					Data byte 49					Data byte 50			Data byte 51					
3Ch	Data byte 52					Data byte 53					Data byte 54			Data byte 55					
40h	Data byte 56					Data byte 57					Data byte 58			Data byte 59					
44h	Data byte 60					Data byte 61					Data byte 62			Data byte 63					
	= Unimplemented or reserved																		

EDL — Extended Data Length

This bit distinguishes between CAN format and CAN FD format frames. The EDL bit must not be set for message buffers configured to RANSWER with code field 1010b (see table below).

BRS — Bit Rate Switch

This bit defines whether the bit rate is switched inside a CAN FD format frame.

ESI — Error State Indicator

This bit indicates if the transmitting node is error active or error passive.

CODE — Message Buffer Code

This 4-bit field can be accessed (read or write) by the CPU and by the FlexCAN module itself, as part of the message buffer matching and arbitration process. The encoding is shown in [Table 55-27](#) and [Table 55-28](#). See [Functional description](#) for additional information.

Table 55-27. Message buffer code for Rx buffers

CODE description	Rx code BEFORE receive new frame	SRV ¹	Rx code AFTER successful reception ²	RRS ³	Comment
0000b: INACTIVE — MB is not active.	INACTIVE	—	—	—	MB does not participate in the matching process.
0100b: EMPTY — MB is active and empty.	EMPTY	—	FULL	—	When a frame is received successfully (after the Move-in process), the CODE field is automatically updated to FULL.
0010b: FULL — MB is full.	FULL	Yes	FULL	—	The act of reading the C/S word followed by unlocking the MB (SRV) does not make the code return to EMPTY. It remains FULL. If a new frame is moved to the MB after the MB was serviced, the code still remains FULL. See Matching process for matching details related to FULL code.
		No	OVERRUN	—	If the MB is FULL and a new frame is moved to this MB before the CPU services it, the CODE field is automatically updated to OVERRUN. See Matching process

Table continues on the next page...

Table 55-27. Message buffer code for Rx buffers (continued)

CODE description	Rx code BEFORE receive new frame	SRV ¹	Rx code AFTER successful reception ²	RRS ³	Comment
					for details about overrun behavior.
0110b: OVERRUN — MB is being overwritten into a full buffer.	OVERRUN	Yes	FULL	—	If the CODE field indicates OVERRUN and CPU has serviced the MB, when a new frame is moved to the MB then the code returns to FULL.
		No	OVERRUN	—	If the CODE field already indicates OVERRUN, and another new frame must be moved, the MB will be overwritten again, and the code will remain OVERRUN. See Matching process for details about overrun behavior.
1010b: RANSWER ⁴ — A frame was configured to recognize a Remote Request frame and transmit a Response frame in return. ⁵	RANSWER	—	TANSWER(1110b)	0	A Remote Answer was configured to recognize a remote request frame received. After that an MB is set to transmit a response frame. The code is automatically changed to TANSWER (1110b). See Matching process for details. If CTRL2[RRS] is negated, transmit a response frame whenever a remote request frame with the same ID is received.
		—	—	1	This code is ignored during matching and arbitration process. See Matching process for details.

Table continues on the next page...

Table 55-27. Message buffer code for Rx buffers (continued)

CODE description	Rx code BEFORE receive new frame	SRV ¹	Rx code AFTER successful reception ²	RRS ³	Comment
CODE[0]=1: BUSY — FlexCAN is updating the contents of the MB. The CPU must not access the MB.	BUSY ⁶	—	FULL	—	Indicates that the MB is being updated. It will be negated automatically and does not interfere with the next CODE.
		—	OVERRUN	—	

1. SRV: Serviced MB. MB was read and unlocked by reading TIMER or other MB.
2. A frame is considered a successful reception after the frame to be moved to MB (move-in process). See [Move-in](#) for details.
3. Remote Request Stored bit, see "Control 2 register (CTRL2)" for details.
4. Code 1010b is not considered Tx and an MB with this code should not be aborted.
5. Code 1010b must be used in message buffers configured in CAN FD format, having the EDL bit set.
6. Note that for Tx MBs, the BUSY bit should be ignored upon read, except when AEN bit is set in the MCR register. If this bit is asserted, the corresponding MB does not participate in the matching process.

Table 55-28. Message buffer code for Tx buffers

CODE Description	Tx Code BEFORE tx frame	MB RTR	Tx Code AFTER successful transmission	Comment
1000b: INACTIVE — MB is not active	INACTIVE	—	—	MB does not participate in arbitration process.
1001b: ABORT — MB is aborted	ABORT	—	—	MB does not participate in arbitration process.
1100b: DATA — MB is a Tx data frame (MB RTR must be 0)	DATA	0	INACTIVE	Transmit data frame unconditionally once. After transmission, the MB automatically returns to the INACTIVE state.
1100b: REMOTE — MB is a Tx Remote Request frame (MB RTR must be 1)	REMOTE	1	EMPTY	Transmit remote request frame unconditionally once. After transmission, the MB automatically becomes an Rx Empty MB with the same ID.
1110b: TANSWER — MB is a Tx Response frame from an incoming Remote Request frame	TANSWER	—	RANSWER	This is an intermediate code that is automatically written to the MB by the CHI as a result of a match to a remote request frame. The remote response frame will be transmitted unconditionally once,

Table 55-28. Message buffer code for Tx buffers

CODE Description	Tx Code BEFORE tx frame	MB RTR	Tx Code AFTER successful transmission	Comment
				and then the code will automatically return to RANSWER (1010b). The CPU can also write this code with the same effect. The remote response frame can be either a data frame or another remote request frame depending on the RTR bit value. See Matching process and Arbitration process for details.

SRR — Substitute Remote Request

Fixed recessive bit, used only in extended format. It must be set to one by the user for transmission (Tx Buffers) and will be stored with the value received on the CAN bus for Rx receiving buffers. It can be received as either recessive or dominant. If FlexCAN receives this bit as dominant, then it is interpreted as an arbitration loss.

1 = Recessive value is compulsory for transmission in extended format frames

0 = Dominant is not a valid value for transmission in extended format frames

IDE — ID Extended Bit

This field identifies whether the frame format is standard or extended.

1 = Frame format is extended

0 = Frame format is standard

RTR — Remote Transmission Request

This bit affects the behavior of remote frames and is part of the reception filter. See [Table 55-27](#), [Table 55-28](#), and the description of the RRS field in Control 2 register (CTRL2) for additional details.

If FlexCAN transmits this bit as '1' (recessive) and receives it as '0' (dominant), it is interpreted as an arbitration loss. If this bit is transmitted as '0' (dominant), then if it is received as '1' (recessive), the FlexCAN module treats it as a bit error. If the value received matches the value transmitted, it is considered a successful bit transmission.

1 = Indicates the current MB may have a remote request frame to be transmitted if MB is Tx. If the MB is Rx then incoming remote request frames may be stored.

0 = Indicates the current MB has a data frame to be transmitted. In Rx MB it may be considered in matching processes.

NOTE

When configuring CAN FD frames, the RTR bit must be negated.

DLC — Length of Data in Bytes

This 4-bit field is the length (in bytes) of the Rx or Tx data, which is located in offset 8h–Fh of the MB space (see [Table 55-26](#)). In reception, this field is written by the FlexCAN module, copied from the DLC (Data Length Code) field of the received frame. In transmission, this field is written by the CPU and corresponds to the DLC field value of the frame to be transmitted. When RTR = 1, the frame to be transmitted is a remote frame and does not include the data field, regardless of the DLC field (see [Table 55-29](#)).

TIME STAMP — Free-Running Counter Time Stamp

This 16-bit field is a copy of the Free-Running Timer, captured for Tx and Rx frames at the time when the beginning of the Identifier field appears on the CAN bus.

PRIO — Local priority

This 3-bit field is used only when MCR[LPRIO_EN] is set, and it only makes sense for Tx mailboxes. These bits are not transmitted. They are appended to the regular ID to define the transmission priority. See [Arbitration process](#).

ID — Frame Identifier

In standard frame format, only the 11 most significant bits (28 to 18) are used for frame identification in both receive and transmit cases. The 18 least significant bits are ignored. In extended frame format, all bits are used for frame identification in both receive and transmit cases.

DATA BYTE 0 to 63 — Data Field

Up to sixty four bytes can be used for a data frame, depending on the size of payload selected for the message buffers.

For Rx frames, the data is stored as it is received from the CAN bus. DATA BYTE (n) is valid only if n is less than DLC as shown in the table below.

Table 55-29. DATA BYTEs validity

DLC	Valid DATA BYTEs
0	none
1	DATA BYTE 0
2	DATA BYTE 0 to 1
3	DATA BYTE 0 to 2
4	DATA BYTE 0 to 3
5	DATA BYTE 0 to 4
6	DATA BYTE 0 to 5
7	DATA BYTE 0 to 6
8	DATA BYTE 0 to 7
9	DATA BYTE 0 to 11
10	DATA BYTE 0 to 15
11	DATA BYTE 0 to 19
12	DATA BYTE 0 to 23
13	DATA BYTE 0 to 31
14	DATA BYTE 0 to 47
15	DATA BYTE 0 to 63

55.5.4 FlexCAN memory partition for CAN FD

When CAN FD is enabled, the FlexCAN RAM can be partitioned in blocks of 512 bytes. Each block can accommodate a number of message buffers which depends on the configuration provided by FDCTRL[MBDSR_n] bit fields as shown in table below.

Table 55-30. RAM partition

RAM block	Number of MBs with 8 bytes (default range)	Size control bit field in FDCTRL register	Number of MBs of different sizes, per block
0	0 to 31	MBDSR0	MBDSR0=00, 32 MBs with 8 bytes payload MBDSR0=01, 21 MBs with 16 bytes payload MBDSR0=10, 12 MBs with 32 bytes payload MBDSR0=11, 7 MBs with 64 bytes payload

When payload sizes of 16, 32, or 64 bytes are configured in some or all RAM blocks, the total number of MBs and its respective number order may differ from the default configuration of 8 bytes. For example, suppose Block0 is configured to 8 bytes payload, Block1 to 16 bytes, Then the following table indicates how the message buffers will be arranged in RAM.

Table 55-31. RAM partition example

RAM block	Payload size	Number of MBs in the RAM block	Message buffer range
0	FDCTRL[MBDSR0]=00, 8 bytes payload	32	0 to 31

55.5.5 FlexCAN message buffer memory map

The FlexCAN memory buffers are allocated in memory according to the tables below.

Table 55-32. 8-byte message buffers

Address offset (hex)	MBDSR=b00 8-byte payload
0080	MB0
0090	MB1
00A0	MB2
00B0	MB3
00C0	MB4
00D0	MB5
00E0	MB6
00F0	MB7
0100	MB8
0110	MB9
0120	MB10
0130	MB11
0140	MB12
0150	MB13
0160	MB14
0170	MB15
0180	MB16
0190	MB17
01A0	MB18
01B0	MB19

Table continues on the next page...

Table 55-32. 8-byte message buffers (continued)

Address offset (hex)	MBDSR=b00 8-byte payload
01C0	MB20
01D0	MB21
01E0	MB22
01F0	MB23
0200	MB24
0210	MB25
0220	MB26
0230	MB27
0240	MB28
0250	MB29
0260	MB30
0270	MB31

Table 55-33. 16-byte message buffers

Address offset (hex)	MBDSR=b01 16-byte payload
0080	MB0
0098	MB1
00B0	MB2
00C8	MB3
00E0	MB4
00F8	MB5
0110	MB6
0128	MB7
0140	MB8
0158	MB9
0170	MB10
0188	MB11
01A0	MB12
01B8	MB13
01D0	MB14
01E8	MB15
0200	MB16
0218	MB17
0230	MB18
0248	MB19
0260	MB20

Table 55-34. 32-byte message buffers

Address offset (hex)	MBDSR=b10 32-byte payload
0080	MB0
00A8	MB1
00D0	MB2
00F8	MB3
0120	MB4
0148	MB5
0170	MB6
0198	MB7
01C0	MB8
01E8	MB9
0210	MB10
0238	MB11

Table 55-35. 64-byte message buffers

Address offset (hex)	MBDSR=b11 64-byte payload
0080	MB0
00C8	MB1
0110	MB2
0158	MB3
01A0	MB4
01E8	MB5
0230	MB6

55.5.6 Rx FIFO structure

When MCR[RFEN] is set, the memory area 80h–DCh (which is normally occupied by MBs 0–5) is used by the reception FIFO engine.

The region 80h–8Ch contains the output of the FIFO which must be read by the CPU as a message buffer. This output contains the oldest message that has been received but not yet read. The region 90h–DCh is reserved for internal use of the FIFO engine.

An additional memory area, which starts at E0h and may extend up to 2DCh (normally occupied by MBs 6–37) depending on the CTRL2[RFFN] field setting, contains the ID filter table (configurable from 8 to 128 table elements) that specifies filtering criteria for accepting frames into the FIFO.

Out of reset, the ID filter table flexible memory area defaults to E0h and extends only to FCh, which corresponds to MBs 6 to 7 for RFFN = 0, for backward compatibility with previous versions of FlexCAN.

The following shows the Rx FIFO data structure.

Table 55-36. Rx FIFO structure

	31	28	24	23	22	21	20	19	18	17	16	15	8	7	0
80h	IDHIT			SRR	IDE	RTR	DLC			TIME STAMP					
84h	ID standard									ID extended					
88h	Data byte 0			Data byte 1						Data byte 2		Data byte 3			
8Ch	Data byte 4			Data byte 5						Data byte 6		Data byte 7			
90h–DCh	Reserved														
E0h	ID filter table element 0														
E4h	ID filter table element 1														
E8h–2D4h	ID filter table elements 2 to 125														
2D8h	ID filter table element 126														
2DCh	ID filter table element 127														
	= Unimplemented or reserved														

Each ID filter table element occupies an entire 32-bit word and can be compounded by one, two, or four Identifier Acceptance Filters (IDAF) depending on the MCR[IDAM] field setting. The following figures show the IDAF indexation.

The following table shows the three different formats of the ID table elements. Note that all elements of the table must have the same format. See [Rx FIFO](#) for more information.

Table 55-37. ID table structure

Format	31	30	29	24	23	16	15	14	13	8	7	1	0	
A	RTR	IDE	RXIDA (standard = 29–19, extended = 29–1)											
B	RTR	IDE	RXIDB_0 (standard = 29–19, extended = 29–16)				RTR	IDE	RXIDB_1 (standard = 13–3, extended = 13–0)					
C	RXIDC_0 (std/ext = 31–24)			RXIDC_1 (std/ext = 23–16)			RXIDC_2 (std/ext = 15–8)			RXIDC_3 (std/ext = 7–0)				
	= Unimplemented or Reserved													

RTR — Remote frame

This bit specifies if remote frames are accepted into the FIFO if they match the target ID.

1 = Remote frames can be accepted and data frames are rejected

0 = Remote frames are rejected and data frames can be accepted

IDE — Extended frame

Specifies whether extended or standard frames are accepted into the FIFO if they match the target ID.

1 = Extended frames can be accepted and standard frames are rejected

0 = Extended frames are rejected and standard frames can be accepted

RXIDA — Rx frame identifier (Format A)

Specifies an ID to be used as acceptance criteria for the FIFO. In the standard frame format, only the 11 most significant bits (29 to 19) are used for frame identification. In the extended frame format, all bits are used.

RXIDB_0, RXIDB_1 — Rx frame identifier (Format B)

Specifies an ID to be used as acceptance criteria for the FIFO. In the standard frame format, the 11 most significant bits (a full standard ID) (29 to 19 and 13 to 3) are used for frame identification. In the extended frame format, all 14 bits of the field are compared to the 14 most significant bits of the received ID.

RXIDC_0, RXIDC_1, RXIDC_2, RXIDC_3 — Rx frame identifier (Format C)

Specifies an ID to be used as acceptance criteria for the FIFO. In both standard and extended frame formats, all 8 bits of the field are compared to the 8 most significant bits of the received ID.

IDHIT — Identifier acceptance filter hit indicator

This 9-bit field indicates which identifier acceptance filter was hit by the received message that is in the output of the Rx FIFO. See [Rx FIFO](#) for more information.

55.6 Initialization/application information

This section provides instructions for initializing the FlexCAN module.

55.6.1 FlexCAN initialization sequence

For any configuration change/initialization it is required that FlexCAN be put into Freeze mode (see [Freeze mode](#)). Note that the module needs to be initialized after every reset.

The following is a generic initialization sequence applicable to the FlexCAN module:

1. Initialize the Module Configuration register (MCR).
 - a. Enable the individual filtering per MB and reception queue features by setting IRMQ.
 - b. Enable the warning interrupts by setting WRNEN.
 - c. If required, disable frame self reception by setting SRXDIS.
 - d. Enable the Rx FIFO by setting RFEN.
 - e. If Rx FIFO is enabled and DMA is required, set DMA.
 - f. If Pretended Networking mode is required, set PNET_EN.
 - g. Enable the abort mechanism by setting AEN.
 - h. Enable the local priority feature by setting LPRIOEN.
2. Initialize the Control 1 register (CTRL1) and optionally the CAN Bit Timing register (CBT). Initialize also the CAN FD CAN Bit Timing register (FDCBT).
 - a. Determine the bit timing parameters: PROPSEG, PSEG1, PSEG2, and RJW.
 - b. Optionally determine the bit timing parameters: EPROPSEG, EPSEG1, EPSEG2, and ERJW.
 - c. Determine the CAN FD bit timing parameters: FPROPSEG, FPSEG1, FPSEG2, and FRJW.
 - d. Determine the bit rate by programming the PRESDIV field and optionally the EPRESDIV field.
 - e. Determine the CAN FD bit rate by programming the FPRESDIV field.
 - f. Determine the internal arbitration mode (LBUF).
3. Initialize the message buffers.
 - a. The control and status word of all message buffers must be initialized.
 - b. If Rx FIFO was enabled, the ID filter table must be initialized.
 - c. Other entries in each message buffer should be initialized as required.
4. Initialize the Rx Individual Mask registers (RXIMRn).
5. Set required interrupt mask bits in
 - IMASK registers (for all MB interrupts)
 - CTRL1 / CTRL2 registers (for Bus Off and Error interrupts)
6. If Pretended Networking mode is enabled, configure the necessary registers for selective wakeup.
7. Negate MCR[HALT].

After the last step listed above, FlexCAN attempts to synchronize to the CAN bus.

Chapter 56

Synchronous Audio Interface (SAI)

56.1 Chip-specific SAI information

S32K148 has two instances of the SAI module. Other products in the S32K1xx series do not have the SAI module.

56.1.1 SAI configuration

- S32K148 has 2 SAI modules: SAI0, SAI1.
 - SAI0 and SAI1 will always operate asynchronously with respect to each other, which means that SAI0 will operate asynchronously with respect to SAI1, and SAI1 will operate asynchronously with respect to SAI0.
 - The SAI_BCLK (SAI_TX_BCLK, SAI_RX_BCLK), SAI_SYNC (SAI_TX_SYNC, SAI_RX_SYNC), and SAI_DATA (SAI_TX_DATA, SAI_RX_DATA) pins are shared between each module instance's (SAI0, SAI1) receiver and transmitter on S32K148 devices. See the IO Signal Description Input Multiplexing sheet(s) attached to this Reference Manual for details. At any specific time, either the SAI receiver or the SAI transmitter should be active or they should operate synchronously (only one active at a time). The SAI transmitter and SAI receiver should not be configured to operate simultaneously with inconsistent configurations (as mentioned previously).
- Other devices in the S32K14x series do not have any SAI modules; only S32K148 devices have SAI modules.

Table 56-1. SAI module configurations

Feature	SAI0 module	SAI1 module
Channels supported	4	1
FIFO size	8 words	8 words
FRAME length	Maximum = 16 words per frame	Maximum = 16 words per frame
Frame Synchronization	I2S, AC97, and CODEC/DSP interfaces	I2S, AC97, and CODEC/DSP interfaces

NOTE

- SAI functionality is not supported in STOP/VLPS modes.
- Before using SAI_TX_DATAx (SAI_Dx), SAI_SYNC, or SAI_BCLK for input configurations, GPIO_PDDR must be configured for the corresponding pins.
- To correctly generate the SAI’s internal bit clock when TCR2[BCI] bit is set, TCR2[SYNC] must be set to 0x01 in either receiver or transmitter configuration.
- If the SAI_BCLK is enabled with bit fields RCR2[DIV]/TCR2[DIV] > 0 and then disabled by either software or stop mode entry, a software reset of SAI must be issued when enabling the SAI_BCLK. Otherwise, SAI_BCLK will not be generated correctly.

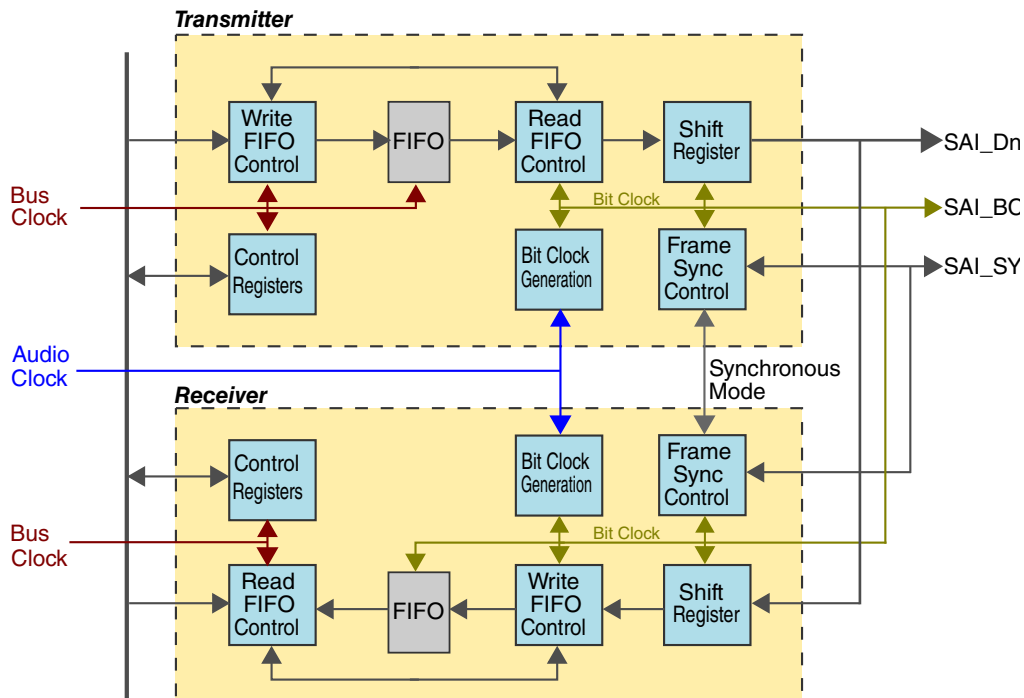

Figure 56-1. S32K148 SAI Block Diagram

56.1.2 Chip-specific register information

The reset value of the PARAM register varies for the two SAI module instances. The following table shows the instance-specific reset values.

Table 56-2. SAI register reset values

Instance	PARAM reset value	Comment
SAI0	0004_0304	PARAM[DATA LINE] reflects support for 4 channels
SAI1	0004_0301	PARAM[DATA LINE] reflects support for 1 channel

56.2 Introduction

The I²S (or I2S) module provides a synchronous audio interface (SAI) that supports full-duplex serial interfaces with frame synchronization such as I²S, AC97, TDM, and codec/DSP interfaces.

56.2.1 Features

Note that some of the features are not supported across all SAI instances; see the chip-specific information in the first section of this chapter.

- Transmitter with independent bit clock and frame sync supporting 4 data lines
- Receiver with independent bit clock and frame sync supporting 4 data lines
- Each data line can support a maximum Frame size of 16 words
- Word size of between 8-bits and 32-bits
- Word size configured separately for first word and remaining words in frame
- Asynchronous 8 x 32-bit FIFO for each transmit and receive data line
- Supports graceful restart after FIFO error
- Supports automatic restart after FIFO error without software intervention
- Supports packing of 8-bit and 16-bit data into each 32-bit FIFO word
- Supports combining multiple data line FIFOs into single data line FIFO

56.2.2 Block diagram

The following block diagram also shows the module clocks.

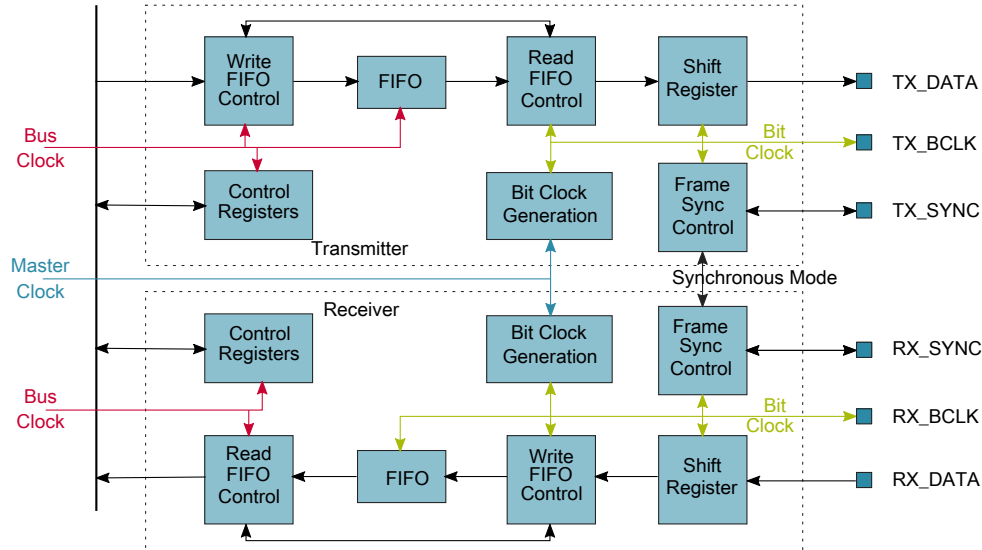

Figure 56-2. I²S/SAI block diagram

56.2.3 Modes of operation

Module power modes include Run mode, and Debug mode.

56.2.3.1 Run mode

In Run mode, the SAI transmitter and receiver operate normally.

56.2.3.2 Debug mode

In Debug mode, the SAI transmitter and/or receiver can continue operating provided the Debug Enable bit is set. When TCSR[DBGE] or RCSR[DBGE] bit is clear and Debug mode is entered, the SAI is disabled after completing the current transmit or receive frame. The transmitter and receiver bit clocks are not affected by Debug mode.

56.3 External signals

Name	Function	I/O
TX_BCLK	Transmit Bit Clock. The bit clock is an input when externally generated and an output when internally generated.	I/O
TX_SYNC	Transmit Frame Sync. The frame sync is an input sampled synchronously by the bit clock when externally generated and an output generated synchronously by the bit clock when internally generated.	I/O
TX_DATA[3:0]	Transmit Data. The transmit data is generated synchronously by the bit clock and is tristated whenever not transmitting a word.	O
RX_BCLK	Receive Bit Clock. The bit clock is an input when externally generated and an output when internally generated.	I/O
RX_SYNC	Receive Frame Sync. The frame sync is an input sampled synchronously by the bit clock when externally generated and an output generated synchronously by the bit clock when internally generated.	I/O
RX_DATA[3:0]	Receive Data. The receive data is sampled synchronously by the bit clock.	I

56.4 Memory map and register definition

A read or write access to an address from offset 0x100 and above will result in a bus error.

56.4.1 I2S register descriptions

56.4.1.1 I2S memory map

SAI0 base address: 4005_4000h

SAI1 base address: 4005_5000h

Memory map and register definition

Offset	Register	Width (In bits)	Access	Reset value
0h	Version ID Register (VERID)	32	RO	0300_0000h
4h	Parameter Register (PARAM)	32	RO	Table 56-2
8h	SAI Transmit Control Register (TCSR)	32	RW	0000_0000h
Ch	SAI Transmit Configuration 1 Register (TCR1)	32	RW	0000_0000h
10h	SAI Transmit Configuration 2 Register (TCR2)	32	RW	0000_0000h
14h	SAI Transmit Configuration 3 Register (TCR3)	32	RW	0000_0000h
18h	SAI Transmit Configuration 4 Register (TCR4)	32	RW	0000_0000h
1Ch	SAI Transmit Configuration 5 Register (TCR5)	32	RW	0000_0000h
20h - 2Ch	SAI Transmit Data Register (TDR0 - TDR3)	32	WORZ	See description
40h - 4Ch	SAI Transmit FIFO Register (TFR0 - TFR3)	32	RO	See description
60h	SAI Transmit Mask Register (TMR)	32	RW	0000_0000h
88h	SAI Receive Control Register (RCSR)	32	RW	0000_0000h
8Ch	SAI Receive Configuration 1 Register (RCR1)	32	RW	0000_0000h
90h	SAI Receive Configuration 2 Register (RCR2)	32	RW	0000_0000h
94h	SAI Receive Configuration 3 Register (RCR3)	32	RW	0000_0000h
98h	SAI Receive Configuration 4 Register (RCR4)	32	RW	0000_0000h
9Ch	SAI Receive Configuration 5 Register (RCR5)	32	RW	0000_0000h
A0h - ACh	SAI Receive Data Register (RDR0 - RDR3)	32	RO	See description
C0h - CCh	SAI Receive FIFO Register (RFR0 - RFR3)	32	RO	See description
E0h	SAI Receive Mask Register (RMR)	32	RW	0000_0000h

56.4.1.2 Version ID Register (VERID)

56.4.1.2.1 Offset

Register	Offset
VERID	0h

56.4.1.2.2 Function

.

56.4.1.2.3 Diagram

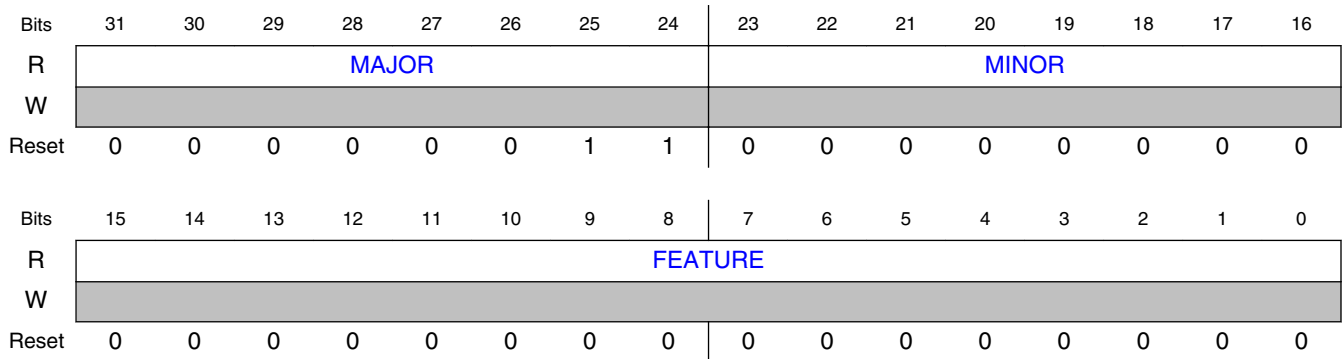

56.4.1.2.4 Fields

Field	Function
31-24 MAJOR	Major Version Number This read only field returns the major version number for the specification.
23-16 MINOR	Minor Version Number This read only field returns the minor version number for the specification.
15-0 FEATURE	Feature Specification Number This read only field returns the feature set number. 0000000000000000b - Standard feature set.

56.4.1.3 Parameter Register (PARAM)

56.4.1.3.1 Offset

Register	Offset
PARAM	4h

56.4.1.3.2 Function

.

56.4.1.3.3 Diagram

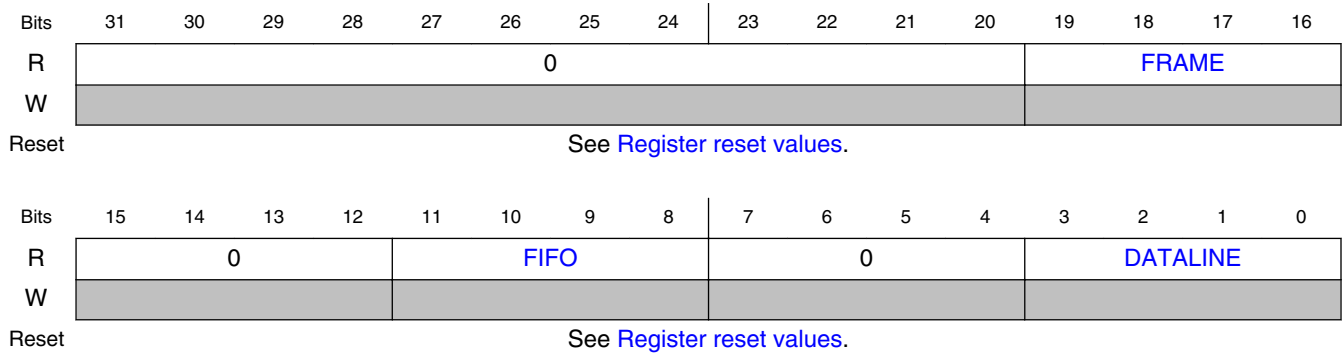

56.4.1.3.4 Register reset values

Register	Reset value
PARAM	SAI0: 0004_0304h SAI1: 0004_0301h

56.4.1.3.5 Fields

Field	Function
31-20 —	Reserved
19-16 FRAME	Frame Size The maximum number of slots per frame is 2 ^{FRAME} .
15-12 —	Reserved
11-8 FIFO	FIFO Size The number of words in each FIFO is 2 ^{FIFO} .
7-4 —	Reserved
3-0 DATALINE	Number of Datalines The number of datalines implemented.

56.4.1.4 SAI Transmit Control Register (TCSR)

56.4.1.4.1 Offset

Register	Offset
TCSR	8h

56.4.1.4.2 Diagram

Bits	31	30	29	28	27	26	25	24	23	22	21	20	19	18	17	16
R	TE	Reserved	DBG E	BC E	0		0	S R	0			WS F	SE F	FE F	FW F	FR F
W							FR					W1C F	W1C F	W1C F		
Reset	0	0	0	0	0	0	0	0	0	0	0	0	0	0	0	0
Bits	15	14	13	12	11	10	9	8	7	6	5	4	3	2	1	0
R	0			WSI E	SEI E	FEI E	FWI E	FRI E	0			0			FWD E	FRD E
W																
Reset	0	0	0	0	0	0	0	0	0	0	0	0	0	0	0	0

56.4.1.4.3 Fields

Field	Function
31 TE	Transmitter Enable Enables/disables the transmitter. When software clears this field, the transmitter remains enabled, and this bit remains set, until the end of the current frame. 0b - Transmitter is disabled. 1b - Transmitter is enabled, or transmitter has been disabled and has not yet reached end of frame.
30 —	Reserved Software should only write zero to this reserved bit.
29 DBGE	Debug Enable Enables/disables transmitter operation in Debug mode. The transmit bit clock is not affected by debug mode. 0b - Transmitter is disabled in Debug mode, after completing the current frame. 1b - Transmitter is enabled in Debug mode.
28 BCE	Bit Clock Enable Enables the transmit bit clock, separately from the TE. This field is automatically set whenever TE is set. When software clears this field, the transmit bit clock remains enabled, and this bit remains set, until the end of the current frame. 0b - Transmit bit clock is disabled. 1b - Transmit bit clock is enabled.
27-26 —	Reserved
25	FIFO Reset

Table continues on the next page...

Memory map and register definition

Field	Function
FR	Empties the FIFO, and sets the FIFO read and write pointers to the same value, which may or may not be zero. Reading this field will always return zero. FIFO pointers should only be reset when the transmitter is disabled or the FIFO error flag is set. 0b - No effect. 1b - FIFO reset.
24 SR	Software Reset When set, resets the internal transmitter logic including the FIFO read and write pointers. Software-visible registers are not affected, except for the status registers. 0b - No effect. 1b - Software reset.
23-21 —	Reserved
20 WSF	Word Start Flag Indicates that the start of the configured word has been detected. Write a logic 1 to this field to clear this flag. 0b - Start of word not detected. 1b - Start of word detected.
19 SEF	Sync Error Flag Indicates that an error in the externally-generated frame sync has been detected. Write a logic 1 to this field to clear this flag. 0b - Sync error not detected. 1b - Frame sync error detected.
18 FEF	FIFO Error Flag Indicates that an enabled transmit FIFO has underrun. Write a logic 1 to this field to clear this flag. 0b - Transmit underrun not detected. 1b - Transmit underrun detected.
17 FWF	FIFO Warning Flag Indicates that an enabled transmit FIFO is empty. 0b - No enabled transmit FIFO is empty. 1b - Enabled transmit FIFO is empty.
16 FRF	FIFO Request Flag Indicates that the number of words in an enabled transmit channel FIFO is less than or equal to the transmit FIFO watermark. 0b - Transmit FIFO watermark has not been reached. 1b - Transmit FIFO watermark has been reached.
15-13 —	Reserved
12 WSIE	Word Start Interrupt Enable Enables/disables word start interrupts. 0b - Disables interrupt. 1b - Enables interrupt.
11 SEIE	Sync Error Interrupt Enable Enables/disables sync error interrupts. 0b - Disables interrupt. 1b - Enables interrupt.
10 FEIE	FIFO Error Interrupt Enable Enables/disables FIFO error interrupts.

Table continues on the next page...

Field	Function
	0b - Disables the interrupt. 1b - Enables the interrupt.
9 FWIE	FIFO Warning Interrupt Enable Enables/disables FIFO warning interrupts. 0b - Disables the interrupt. 1b - Enables the interrupt.
8 FRIE	FIFO Request Interrupt Enable Enables/disables FIFO request interrupts. 0b - Disables the interrupt. 1b - Enables the interrupt.
7-5 —	Reserved
4-2 —	Reserved
1 FWDE	FIFO Warning DMA Enable Enables/disables DMA requests. 0b - Disables the DMA request. 1b - Enables the DMA request.
0 FRDE	FIFO Request DMA Enable Enables/disables DMA requests. 0b - Disables the DMA request. 1b - Enables the DMA request.

56.4.1.5 SAI Transmit Configuration 1 Register (TCR1)

56.4.1.5.1 Offset

Register	Offset
TCR1	Ch

56.4.1.5.2 Diagram

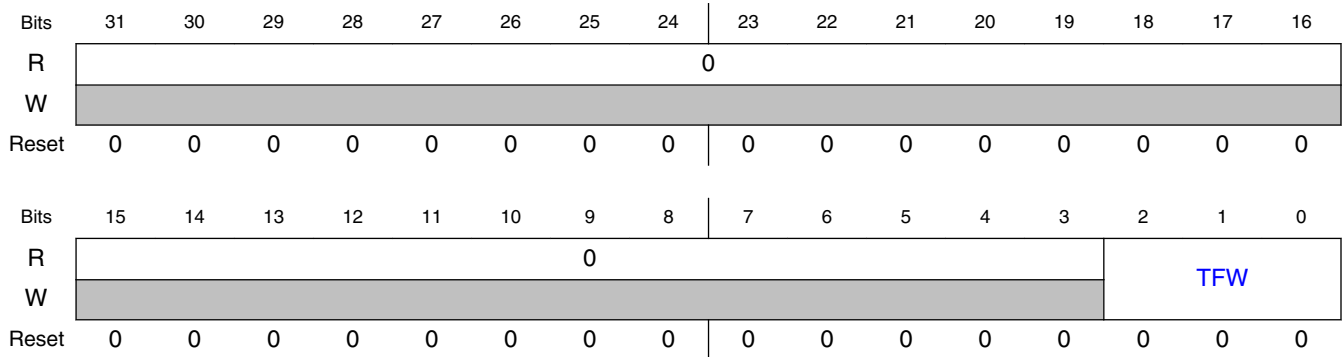

56.4.1.5.3 Fields

Field	Function
31-3 —	Reserved
2-0 TFW	Transmit FIFO Watermark Configures the watermark level for all enabled transmit channels.

56.4.1.6 SAI Transmit Configuration 2 Register (TCR2)

56.4.1.6.1 Offset

Register	Offset
TCR2	10h

56.4.1.6.2 Function

This register must not be altered when TCSR[TE] is set.

56.4.1.6.3 Diagram

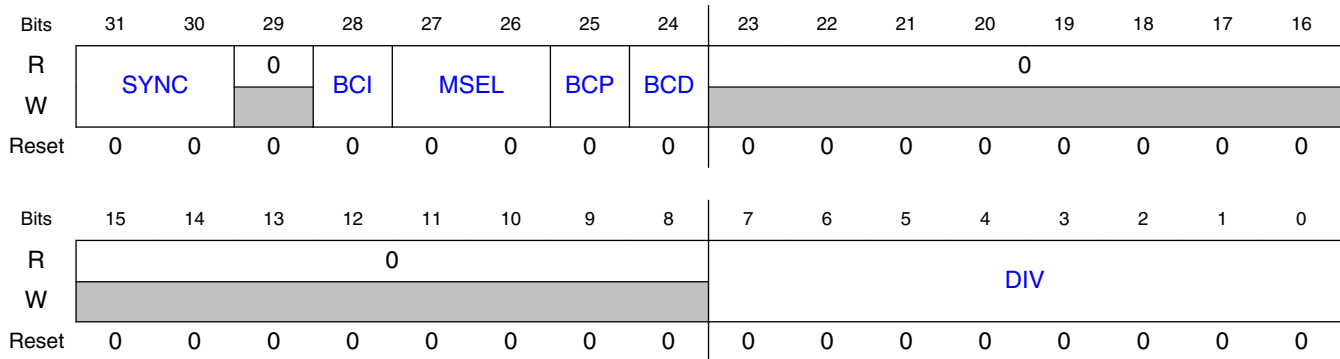

56.4.1.6.4 Fields

Field	Function
31-30 SYNC	Synchronous Mode Configures between asynchronous and synchronous modes of operation. When configured for a synchronous mode of operation, the receiver must be configured for asynchronous operation. 00b - Asynchronous mode. 01b - Synchronous with receiver. 10b - Reserved. 11b - Reserved.
29 —	Reserved
28 BCI	Bit Clock Input When this field is set and using an internally generated bit clock in either synchronous or asynchronous mode, the bit clock actually used by the transmitter is delayed by the pad output delay (the transmitter is clocked by the pad input as if the clock was externally generated). This has the effect of decreasing the data input setup time, but increasing the data output valid time. The slave mode timing from the datasheet should be used for the transmitter when this bit is set. In synchronous mode, this bit allows the transmitter to use the slave mode timing from the datasheet, while the receiver uses the master mode timing. This field has no effect when configured for an externally generated bit clock . 0b - No effect. 1b - Internal logic is clocked as if bit clock was externally generated.
27-26 MSEL	MCLK Select Selects the audio Master Clock option used to generate an internally generated bit clock. This field has no effect when configured for an externally generated bit clock. NOTE: Depending on the device, some Master Clock options might not be available. See the chip-specific information for the meaning of each option. 00b - Bus Clock selected. 01b - Master Clock (MCLK) 1 option selected. 10b - Master Clock (MCLK) 2 option selected. 11b - Master Clock (MCLK) 3 option selected.
25 BCP	Bit Clock Polarity Configures the polarity of the bit clock.

Table continues on the next page...

Memory map and register definition

Field	Function
	0b - Bit clock is active high with drive outputs on rising edge and sample inputs on falling edge. 1b - Bit clock is active low with drive outputs on falling edge and sample inputs on rising edge.
24 BCD	Bit Clock Direction Configures the direction of the bit clock. 0b - Bit clock is generated externally in Slave mode. 1b - Bit clock is generated internally in Master mode.
23-8 —	Reserved
7-0 DIV	Bit Clock Divide Divides down the audio master clock to generate the bit clock when configured for an internal bit clock. The division value is $(DIV + 1) * 2$.

56.4.1.7 SAI Transmit Configuration 3 Register (TCR3)

56.4.1.7.1 Offset

Register	Offset
TCR3	14h

56.4.1.7.2 Diagram

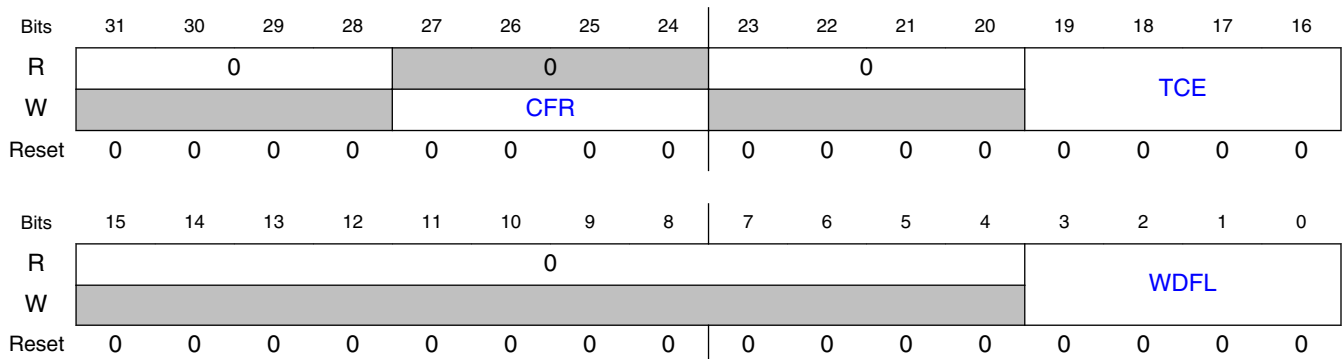

56.4.1.7.3 Fields

Field	Function
31-28 —	Reserved

Table continues on the next page...

Field	Function						
27-24 CFR	<p>Channel FIFO Reset</p> <p>Resets the FIFO pointers for a specific channel. Reading this field will always return zero. FIFO pointers should only be reset when a channel is disabled or the FIFO error flag is set.</p> <p>The width of CFR field = the number of transmit channels (call it N). For example, if CFR is 2 bits wide, then bit position 24 refers to transmit channel 1 FIFO pointer and bit position 25 refers to transmit channel 2 FIFO pointer. Setting bit 24 resets transmit channel 1 FIFO pointer, and setting bit 25 enables transmit channel 2 FIFO pointer. Setting bit N will reset transmit channel N FIFO pointer.</p> <p>0b - No effect. 1b - Transmit data channel N FIFO is reset.</p> <p>NOTE: This field is not supported in every instance. The following table includes only supported registers.</p> <table border="1"> <thead> <tr> <th>Field supported in</th> <th>Field not supported in</th> </tr> </thead> <tbody> <tr> <td>SAI0_TCR3</td> <td>—</td> </tr> <tr> <td>—</td> <td>SAI1_TCR3</td> </tr> </tbody> </table>	Field supported in	Field not supported in	SAI0_TCR3	—	—	SAI1_TCR3
Field supported in	Field not supported in						
SAI0_TCR3	—						
—	SAI1_TCR3						
23-20 —	Reserved						
19-16 TCE	<p>Transmit Channel Enable</p> <p>Enables the corresponding data channel for transmit operation. Changing TCE field will take effect immediately for generating the FIFO request and warning flags, but at the end of each frame for transmit operation.</p> <p>The width of TCE field = the number of transmit channels (call it N). For example, if TCE field is 2 bits wide, then bit position 16 refers to transmit channel 1 and bit position 17 refers to transmit channel 2. Setting bit 16 enables transmit channel 1, and setting bit 17 enables transmit channel 2. Setting bit N will enable transmit channel N.</p> <p>0b - Transmit data channel N is disabled. 1b - Transmit data channel N is enabled.</p> <p>NOTE: This field is not supported in every instance. The following table includes only supported registers.</p> <table border="1"> <thead> <tr> <th>Field supported in</th> <th>Field not supported in</th> </tr> </thead> <tbody> <tr> <td>SAI0_TCR3</td> <td>—</td> </tr> <tr> <td>SAI1_TCR3[16]</td> <td>SAI1_TCR3[19–17]</td> </tr> </tbody> </table>	Field supported in	Field not supported in	SAI0_TCR3	—	SAI1_TCR3[16]	SAI1_TCR3[19–17]
Field supported in	Field not supported in						
SAI0_TCR3	—						
SAI1_TCR3[16]	SAI1_TCR3[19–17]						
15-4 —	Reserved						
3-0 WDFL	<p>Word Flag Configuration</p> <p>Configures which word sets the start of word flag. The value written must be one less than the word number. For example, writing 0 configures the first word in the frame. When configured to a value greater than TCR4[FRSZ], then the start of word flag is never set.</p>						

56.4.1.8 SAI Transmit Configuration 4 Register (TCR4)

56.4.1.8.1 Offset

Register	Offset
TCR4	18h

56.4.1.8.2 Function

This register must not be altered when TCSR[TE] is set.

56.4.1.8.3 Diagram

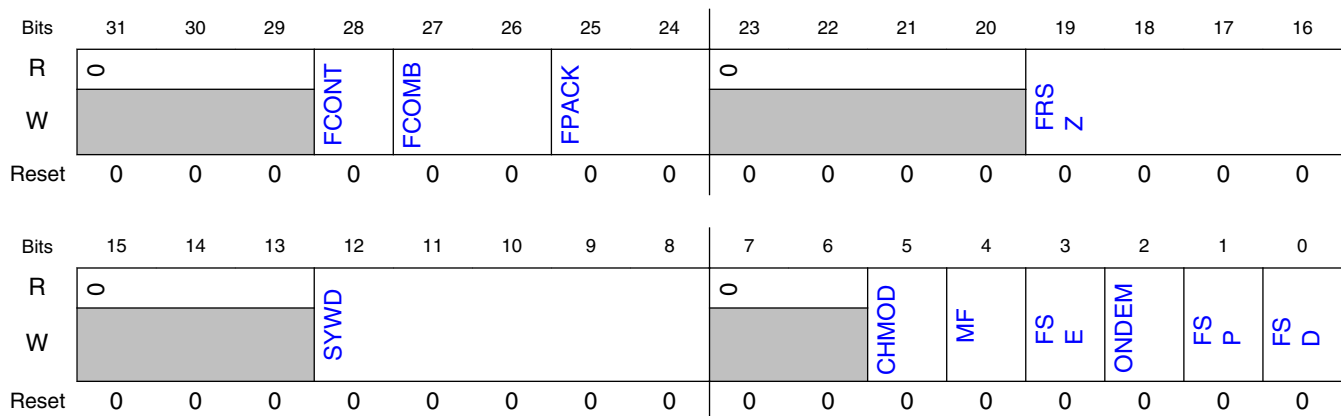

56.4.1.8.4 Fields

Field	Function
31-29 —	Reserved
28 FCONT	FIFO Continue on Error Configures when the SAI will continue transmitting after a FIFO error has been detected. 0b - On FIFO error, the SAI will continue from the start of the next frame after the FIFO error flag has been cleared. 1b - On FIFO error, the SAI will continue from the same word that caused the FIFO error to set after the FIFO warning flag has been cleared.
27-26 FCOMB	FIFO Combine Mode When FIFO combine mode is enabled for FIFO writes, software writing to any FIFO data register will alternate the write among the enabled data channel FIFOs. For example, if two data channels are enabled then the first write will be performed to the first enabled data channel FIFO and the second write will be performed to the second enabled data channel FIFO. Resetting the FIFO or disabling FIFO combine mode for FIFO writes will reset the pointer back to the first enabled data channel.

Table continues on the next page...

Field	Function						
	<p>When FIFO combine mode is enabled for FIFO reads from the transmit shift registers, the transmit data channel output will alternate between the enabled data channel FIFOs. For example, if two data channels are enabled then the first unmasked word will be transmitted from the first enabled data channel FIFO and the second unmasked word will be transmitted from the second enabled data channel FIFO. Since the first word of the frame is always transmitted from the first enabled data channel FIFO, it is recommended that the number of unmasked words per frame is evenly divisible by the number of enabled data channels.</p> <p>NOTE: This field is not supported in every instance. The following table includes only supported registers.</p> <table border="1"> <thead> <tr> <th>Field supported in</th> <th>Field not supported in</th> </tr> </thead> <tbody> <tr> <td>SAI0_TCR4</td> <td>—</td> </tr> <tr> <td>—</td> <td>SAI1_TCR4</td> </tr> </tbody> </table> <p>00b - FIFO combine mode disabled. 01b - FIFO combine mode enabled on FIFO reads (from transmit shift registers). 10b - FIFO combine mode enabled on FIFO writes (by software). 11b - FIFO combine mode enabled on FIFO reads (from transmit shift registers) and writes (by software).</p>	Field supported in	Field not supported in	SAI0_TCR4	—	—	SAI1_TCR4
Field supported in	Field not supported in						
SAI0_TCR4	—						
—	SAI1_TCR4						
25-24 FPACK	<p>FIFO Packing Mode</p> <p>Enables packing of 8-bit data or 16-bit data into each 32-bit FIFO word. If the word size is greater than 8-bit or 16-bit then only the first 8-bit or 16-bits are loaded from the FIFO. The first word in each frame always starts with a new 32-bit FIFO word and the first bit shifted must be configured within the first packed word. When FIFO packing is enabled, the FIFO write pointer will only increment when the full 32-bit FIFO word has been written by software.</p> <p>00b - FIFO packing is disabled 01b - Reserved 10b - 8-bit FIFO packing is enabled 11b - 16-bit FIFO packing is enabled</p>						
23-20 —	Reserved						
19-16 FRSZ	<p>Frame size</p> <p>Configures the number of words in each frame. The value written must be one less than the number of words in the frame. For example, write 0 for one word per frame. The maximum supported frame size is 16 words.</p>						
15-13 —	Reserved						
12-8 SYWD	<p>Sync Width</p> <p>Configures the length of the frame sync in number of bit clocks. The value written must be one less than the number of bit clocks. For example, write 0 for the frame sync to assert for one bit clock only. The sync width cannot be configured longer than the first word of the frame.</p>						
7-6 —	Reserved						
5 CHMOD	<p>Channel Mode</p> <p>Configures if transmit data pins are configured for TDM mode or Output mode.</p> <p>0b - TDM mode, transmit data pins are tri-stated when slots are masked or channels are disabled. 1b - Output mode, transmit data pins are never tri-stated and will output zero when slots are masked or channels are disabled.</p>						

Table continues on the next page...

Memory map and register definition

Field	Function
4 MF	MSB First Configures whether the LSB or the MSB is transmitted first. 0b - LSB is transmitted first. 1b - MSB is transmitted first.
3 FSE	Frame Sync Early 0b - Frame sync asserts with the first bit of the frame. 1b - Frame sync asserts one bit before the first bit of the frame.
2 ONDEM	On Demand Mode When set, and the frame sync is generated internally, a frame sync is only generated when the FIFO warning flag is clear. 0b - Internal frame sync is generated continuously. 1b - Internal frame sync is generated when the FIFO warning flag is clear.
1 FSP	Frame Sync Polarity Configures the polarity of the frame sync. 0b - Frame sync is active high. 1b - Frame sync is active low.
0 FSD	Frame Sync Direction Configures the direction of the frame sync. 0b - Frame sync is generated externally in Slave mode. 1b - Frame sync is generated internally in Master mode.

56.4.1.9 SAI Transmit Configuration 5 Register (TCR5)

56.4.1.9.1 Offset

Register	Offset
TCR5	1Ch

56.4.1.9.2 Function

This register must not be altered when TCSR[TE] is set.

56.4.1.9.3 Diagram

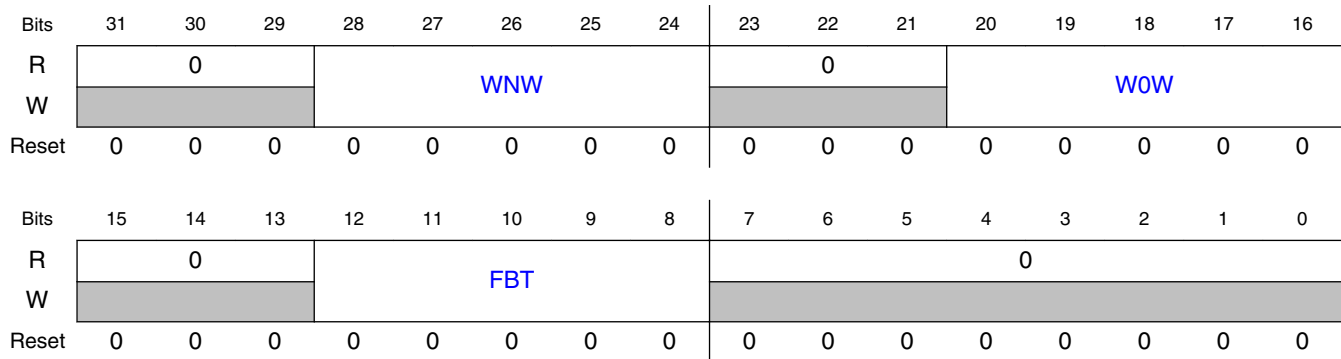

56.4.1.9.4 Fields

Field	Function
31-29 —	Reserved
28-24 WNW	Word N Width Configures the number of bits in each word, for each word except the first in the frame. The value written must be one less than the number of bits per word. Word width of less than 8 bits is not supported.
23-21 —	Reserved
20-16 W0W	Word 0 Width Configures the number of bits in the first word in each frame. The value written must be one less than the number of bits in the first word. Word width of less than 8 bits is not supported if there is only one word per frame.
15-13 —	Reserved
12-8 FBT	First Bit Shifted Configures the bit index for the first bit transmitted for each word in the frame. If configured for MSB First, the index of the next bit transmitted is one less than the current bit transmitted. If configured for LSB First, the index of the next bit transmitted is one more than the current bit transmitted. The value written must be greater than or equal to the word width when configured for MSB First. The value written must be less than or equal to 31-word width when configured for LSB First.
7-0 —	Reserved

56.4.1.10 SAI Transmit Data Register (TDR0 - TDR3)

56.4.1.10.1 Offset

Register	Offset
TDR0	20h
TDR1	24h
TDR2	28h
TDR3	2Ch

NOTE

Each module instance supports a different number of registers.

Register supported	Register not supported
SAI0_T DR0– TDR3	—
SAI1_T DR0	SAI1_T DR1– TDR3

56.4.1.10.2 Diagram

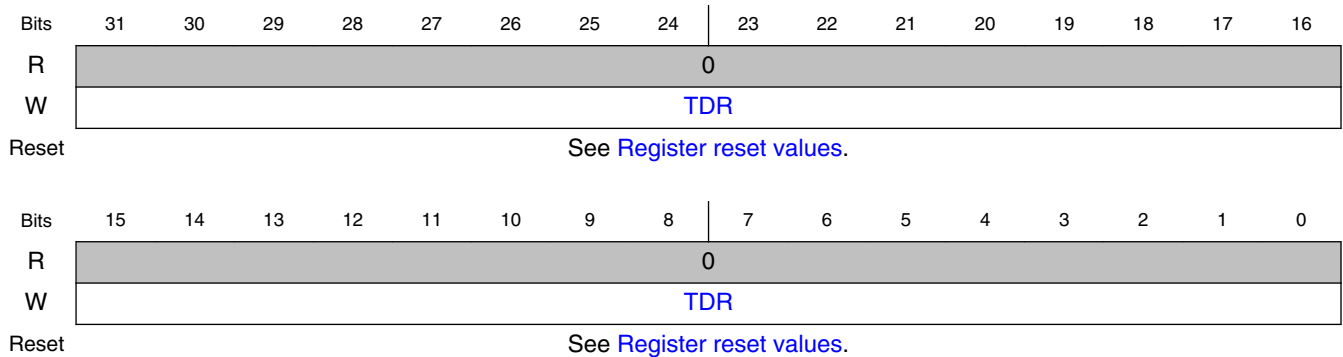

56.4.1.10.3 Register reset values

Register	Reset value
TDR0	SAI0,SAI1: 0000_0000h
TDR1–TDR3	0000_0000h

56.4.1.10.4 Fields

Field	Function
31-0 TDR	Transmit Data Register Writes to this register when the transmit FIFO is not full will push the data written into the transmit data FIFO. Writes to this register when the transmit FIFO is full are ignored.

56.4.1.11 SAI Transmit FIFO Register (TFR0 - TFR3)

56.4.1.11.1 Offset

Register	Offset
TFR0	40h
TFR1	44h
TFR2	48h
TFR3	4Ch

56.4.1.11.2 Function

The MSB of the read and write pointers is used to distinguish between FIFO full and empty conditions. If the read and write pointers are identical, then the FIFO is empty. If the read and write pointers are identical except for the MSB, then the FIFO is full.

NOTE

Each module instance supports a different number of registers.

Register supported	Register not supported
SAI0_T FR0– TFR3	—
SAI1_T FR0	SAI1_T FR1– TFR3

56.4.1.11.3 Diagram

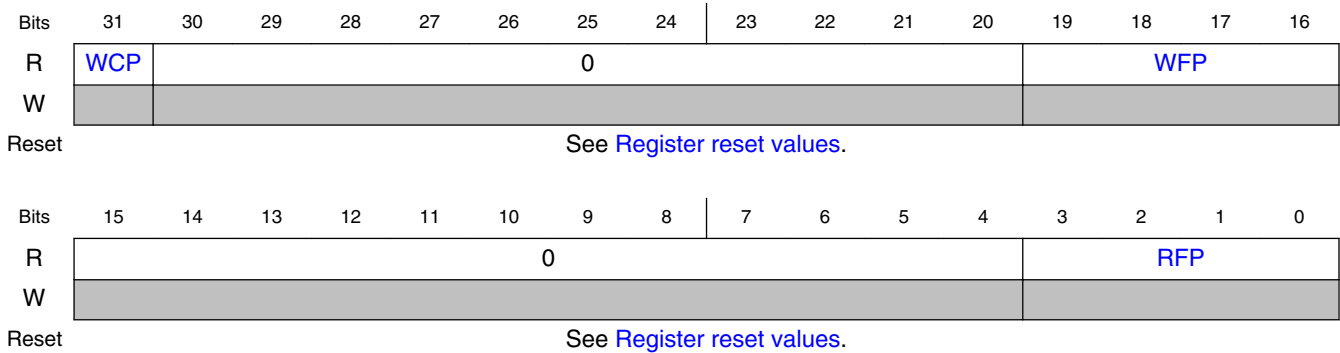

56.4.1.11.4 Register reset values

Register	Reset value
TFR0	SAI0,SAI1: 0000_0000h
TFR1–TFR3	0000_0000h

56.4.1.11.5 Fields

Field	Function						
31 WCP	Write Channel Pointer When FIFO Combine mode is enabled for writes, indicates that this data channel is the next FIFO to be written. NOTE: This field is not supported in every instance. The following table includes only supported registers. <table border="1" style="margin: 10px auto; border-collapse: collapse;"> <thead> <tr> <th style="text-align: center;">Field supported in</th> <th style="text-align: center;">Field not supported in</th> </tr> </thead> <tbody> <tr> <td style="text-align: center;">SAI0_TFR0–TFR3</td> <td style="text-align: center;">—</td> </tr> <tr> <td style="text-align: center;">—</td> <td style="text-align: center;">SAI1_TFR0</td> </tr> </tbody> </table> 0b - No effect. 1b - FIFO combine is enabled for FIFO writes and this FIFO will be written on the next FIFO write.	Field supported in	Field not supported in	SAI0_TFR0–TFR3	—	—	SAI1_TFR0
Field supported in	Field not supported in						
SAI0_TFR0–TFR3	—						
—	SAI1_TFR0						
30-20 —	Reserved						
19-16 WFP	Write FIFO Pointer FIFO write pointer for transmit data channel.						
15-4 —	Reserved						

Table continues on the next page...

Field	Function
3-0	Read FIFO Pointer
RFP	FIFO read pointer for transmit data channel.

56.4.1.12 SAI Transmit Mask Register (TMR)

56.4.1.12.1 Offset

Register	Offset
TMR	60h

56.4.1.12.2 Function

This register is double-buffered and updates:

1. When TCSR[TE] is first set
2. At the end of each frame.

This allows the masked words in each frame to change from frame to frame.

56.4.1.12.3 Diagram

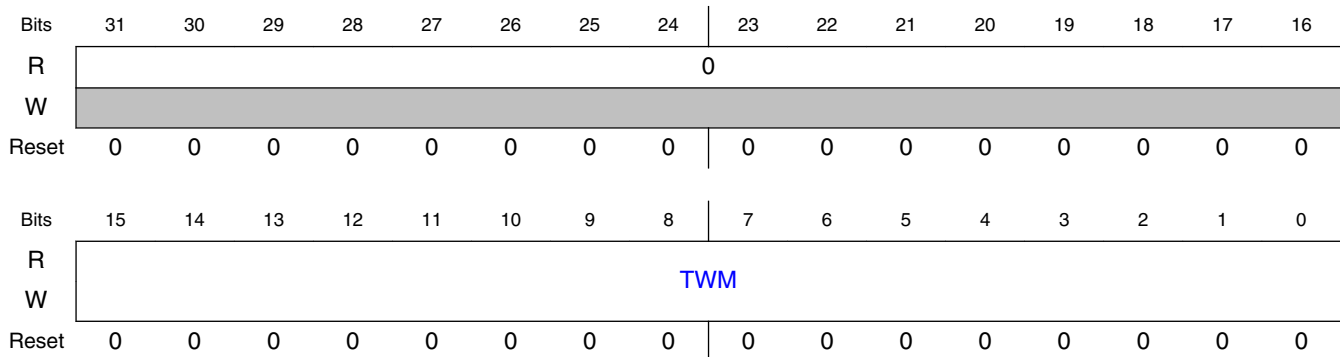

56.4.1.12.4 Fields

Field	Function
31-16	Reserved
—	

Table continues on the next page...

Memory map and register definition

Field	Function
15-0 TWM	Transmit Word Mask Configures whether the transmit word is masked (transmit data pins are tri-stated or drive zero and transmit data not read from FIFO) for the corresponding word in the frame. 0000000000000000b - Word N is enabled. 0000000000000001b - Word N is masked. The transmit data pins are tri-stated or drive zero when masked.

56.4.1.13 SAI Receive Control Register (RCSR)

56.4.1.13.1 Offset

Register	Offset
RCSR	88h

56.4.1.13.2 Diagram

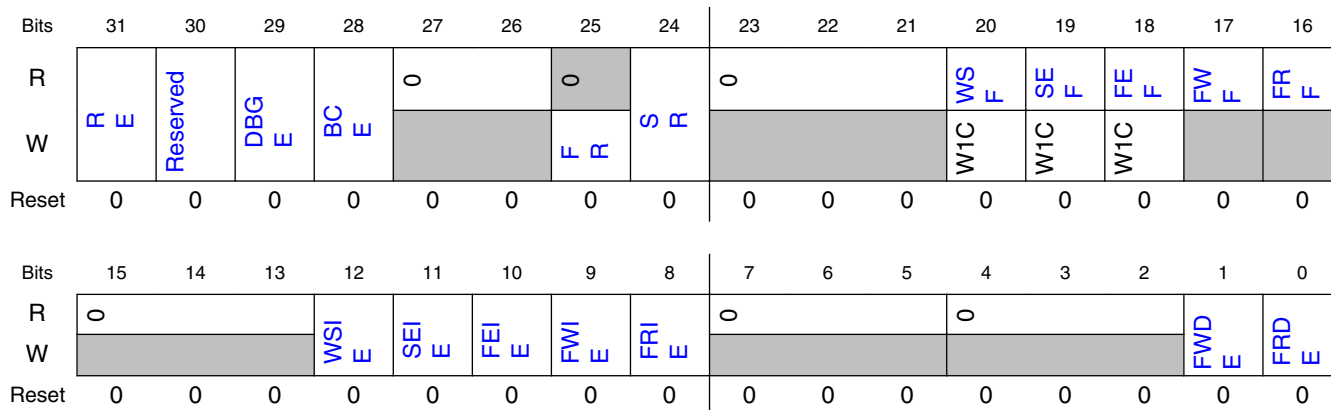

56.4.1.13.3 Fields

Field	Function
31 RE	Receiver Enable Enables/disables the receiver. When software clears this field, the receiver remains enabled, and this bit remains set, until the end of the current frame. 0b - Receiver is disabled. 1b - Receiver is enabled, or receiver has been disabled and has not yet reached end of frame.
30 —	Reserved Software should only write zero to this reserved bit.

Table continues on the next page...

Field	Function
29 DBGE	Debug Enable Enables/disables receiver operation in Debug mode. The receive bit clock is not affected by Debug mode. 0b - Receiver is disabled in Debug mode, after completing the current frame. 1b - Receiver is enabled in Debug mode.
28 BCE	Bit Clock Enable Enables the receive bit clock, separately from RE. This field is automatically set whenever RE is set. When software clears this field, the receive bit clock remains enabled, and this field remains set, until the end of the current frame. 0b - Receive bit clock is disabled. 1b - Receive bit clock is enabled.
27-26 —	Reserved
25 FR	FIFO Reset Empties the FIFO, and sets the FIFO read and write pointers to the same value, which may or may not be zero. Reading this field will always return zero. FIFO pointers should only be reset when the receiver is disabled or the FIFO error flag is set. 0b - No effect. 1b - FIFO reset.
24 SR	Software Reset Resets the internal receiver logic including the FIFO pointers. Software-visible registers are not affected, except for the status registers. 0b - No effect. 1b - Software reset.
23-21 —	Reserved
20 WSF	Word Start Flag Indicates that the start of the configured word has been detected. Write a logic 1 to this field to clear this flag. 0b - Start of word not detected. 1b - Start of word detected.
19 SEF	Sync Error Flag Indicates that an error in the externally-generated frame sync has been detected. Write a logic 1 to this field to clear this flag. 0b - Sync error not detected. 1b - Frame sync error detected.
18 FEF	FIFO Error Flag Indicates that an enabled receive FIFO has overflowed. Write a logic 1 to this field to clear this flag. 0b - Receive overflow not detected. 1b - Receive overflow detected.
17 FWF	FIFO Warning Flag Indicates that an enabled receive FIFO is full. 0b - No enabled receive FIFO is full. 1b - Enabled receive FIFO is full.
16 FRF	FIFO Request Flag Indicates that the number of words in an enabled receive channel FIFO is greater than the receive FIFO watermark. 0b - Receive FIFO watermark not reached. 1b - Receive FIFO watermark has been reached.

Table continues on the next page...

Memory map and register definition

Field	Function
15-13 —	Reserved
12 WSIE	Word Start Interrupt Enable Enables/disables word start interrupts. 0b - Disables interrupt. 1b - Enables interrupt.
11 SEIE	Sync Error Interrupt Enable Enables/disables sync error interrupts. 0b - Disables interrupt. 1b - Enables interrupt.
10 FEIE	FIFO Error Interrupt Enable Enables/disables FIFO error interrupts. 0b - Disables the interrupt. 1b - Enables the interrupt.
9 FWIE	FIFO Warning Interrupt Enable Enables/disables FIFO warning interrupts. 0b - Disables the interrupt. 1b - Enables the interrupt.
8 FRIE	FIFO Request Interrupt Enable Enables/disables FIFO request interrupts. 0b - Disables the interrupt. 1b - Enables the interrupt.
7-5 —	Reserved
4-2 —	Reserved
1 FWDE	FIFO Warning DMA Enable Enables/disables DMA requests. 0b - Disables the DMA request. 1b - Enables the DMA request.
0 FRDE	FIFO Request DMA Enable Enables/disables DMA requests. 0b - Disables the DMA request. 1b - Enables the DMA request.

56.4.1.14 SAI Receive Configuration 1 Register (RCR1)

56.4.1.14.1 Offset

Register	Offset
RCR1	8Ch

56.4.1.14.2 Diagram

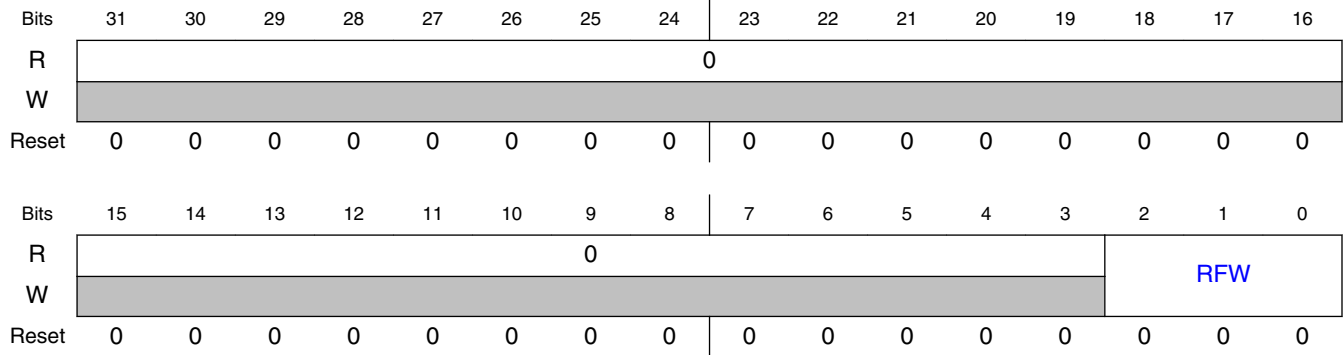

56.4.1.14.3 Fields

Field	Function
31-3 —	Reserved
2-0 RFW	Receive FIFO Watermark Configures the watermark level for all enabled receiver channels.

56.4.1.15 SAI Receive Configuration 2 Register (RCR2)

56.4.1.15.1 Offset

Register	Offset
RCR2	90h

56.4.1.15.2 Function

This register must not be altered when RCSR[RE] is set.

56.4.1.15.3 Diagram

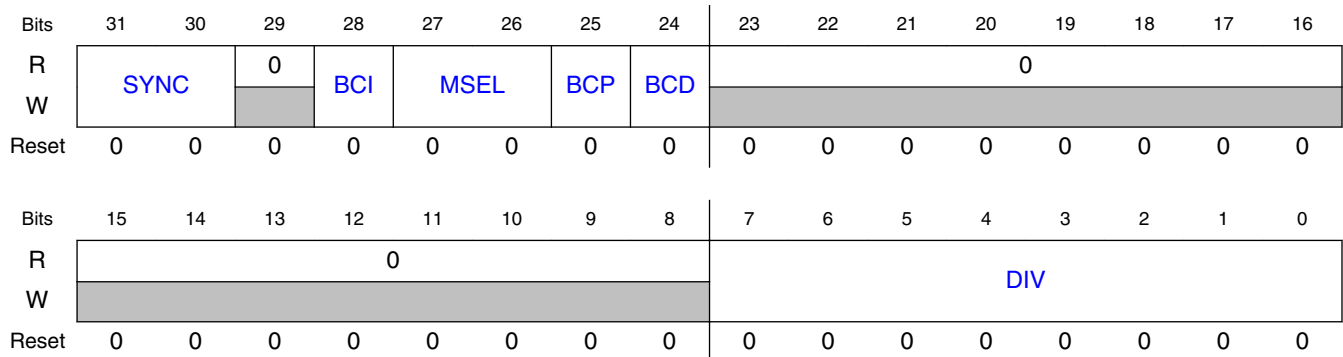

56.4.1.15.4 Fields

Field	Function
31-30 SYNC	Synchronous Mode Configures between asynchronous and synchronous modes of operation. When configured for a synchronous mode of operation, the transmitter must be configured for asynchronous operation. 00b - Asynchronous mode. 01b - Synchronous with transmitter. 10b - Reserved. 11b - Reserved.
29 —	Reserved
28 BCI	Bit Clock Input When this field is set and using an internally generated bit clock in either synchronous or asynchronous mode, the bit clock actually used by the receiver is delayed by the pad output delay (the receiver is clocked by the pad input as if the clock was externally generated). This has the effect of decreasing the data input setup time, but increasing the data output valid time. The slave mode timing from the datasheet should be used for the receiver when this bit is set. In synchronous mode, this bit allows the receiver to use the slave mode timing from the datasheet, while the transmitter uses the master mode timing. This field has no effect when configured for an externally generated bit clock . 0b - No effect. 1b - Internal logic is clocked as if bit clock was externally generated.
27-26 MSEL	MCLK Select Selects the audio Master Clock option used to generate an internally generated bit clock. This field has no effect when configured for an externally generated bit clock. NOTE: Depending on the device, some Master Clock options might not be available. See the chip-specific information for the availability and chip-specific meaning of each option. 00b - Bus Clock selected. 01b - Master Clock (MCLK) 1 option selected. 10b - Master Clock (MCLK) 2 option selected. 11b - Master Clock (MCLK) 3 option selected.
25 BCP	Bit Clock Polarity Configures the polarity of the bit clock.

Table continues on the next page...

Field	Function
	0b - Bit Clock is active high with drive outputs on rising edge and sample inputs on falling edge. 1b - Bit Clock is active low with drive outputs on falling edge and sample inputs on rising edge.
24 BCD	Bit Clock Direction Configures the direction of the bit clock. 0b - Bit clock is generated externally in Slave mode. 1b - Bit clock is generated internally in Master mode.
23-8 —	Reserved
7-0 DIV	Bit Clock Divide Divides down the audio master clock to generate the bit clock when configured for an internal bit clock. The division value is $(DIV + 1) * 2$.

56.4.1.16 SAI Receive Configuration 3 Register (RCR3)

56.4.1.16.1 Offset

Register	Offset
RCR3	94h

56.4.1.16.2 Diagram

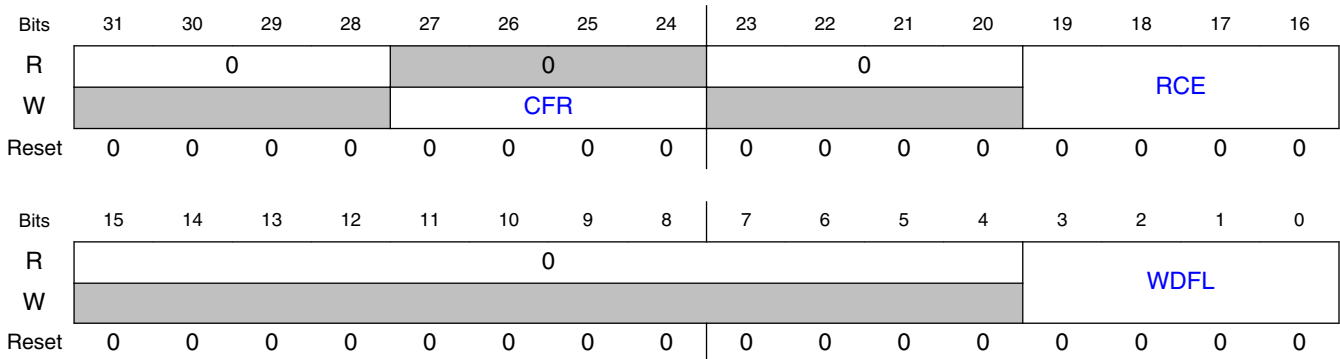

56.4.1.16.3 Fields

Field	Function
31-28 —	Reserved

Table continues on the next page...

Memory map and register definition

Field	Function						
27-24 CFR	<p>Channel FIFO Reset</p> <p>Resets the FIFO pointers for a specific channel. Reading this field will always return zero. FIFO pointers should only be reset when a channel is disabled or the FIFO error flag is set.</p> <p>The width of CFR field = the number of receive channels (call it N). For example, if CFR is 2 bits wide, then bit position 24 refers to receive channel 1 FIFO pointer and bit position 25 refers to receive channel 2 FIFO pointer. Setting bit 24 resets receive channel 1 FIFO pointer, and setting bit 25 enables receive channel 2 FIFO pointer. Setting bit N will reset receive channel N FIFO pointer.</p> <p>0b - No effect. 1b - Receive data channel N FIFO is reset.</p> <p>NOTE: This field is not supported in every instance. The following table includes only supported registers.</p> <table border="1"> <thead> <tr> <th>Field supported in</th> <th>Field not supported in</th> </tr> </thead> <tbody> <tr> <td>SAI0_RCR3</td> <td>—</td> </tr> <tr> <td>—</td> <td>SAI1_RCR3</td> </tr> </tbody> </table>	Field supported in	Field not supported in	SAI0_RCR3	—	—	SAI1_RCR3
Field supported in	Field not supported in						
SAI0_RCR3	—						
—	SAI1_RCR3						
23-20 —	Reserved						
19-16 RCE	<p>Receive Channel Enable</p> <p>Enables the corresponding data channel for receive operation. Changing this field will take effect immediately for generating the FIFO request and warning flags, but at the end of each frame for receive operation.</p> <p>The width of RCE field = the number of receive channels (call it N). For example, if RCE field is 2 bits wide, then bit position 16 refers to receive channel 1 and bit position 17 refers to receive channel 2. Setting bit 16 enables receive channel 1, and setting bit 17 enables receive channel 2. Setting bit N will enable receive channel N.</p> <p>0b - Receive data channel N is disabled. 1b - Receive data channel N is enabled.</p> <p>NOTE: This field is not supported in every instance. The following table includes only supported registers.</p> <table border="1"> <thead> <tr> <th>Field supported in</th> <th>Field not supported in</th> </tr> </thead> <tbody> <tr> <td>SAI0_RCR3</td> <td>—</td> </tr> <tr> <td>SAI1_RCR3[16]</td> <td>SAI1_RCR3[19–17]</td> </tr> </tbody> </table>	Field supported in	Field not supported in	SAI0_RCR3	—	SAI1_RCR3[16]	SAI1_RCR3[19–17]
Field supported in	Field not supported in						
SAI0_RCR3	—						
SAI1_RCR3[16]	SAI1_RCR3[19–17]						
15-4 —	Reserved						
3-0 WDFL	<p>Word Flag Configuration</p> <p>Configures which word the start of word flag is set. The value written should be one less than the word number (for example, write zero to configure for the first word in the frame). When configured to a value greater than the Frame Size field, then the start of word flag is never set.</p>						

56.4.1.17 SAI Receive Configuration 4 Register (RCR4)

56.4.1.17.1 Offset

Register	Offset
RCR4	98h

56.4.1.17.2 Function

This register must not be altered when RCSR[RE] is set.

56.4.1.17.3 Diagram

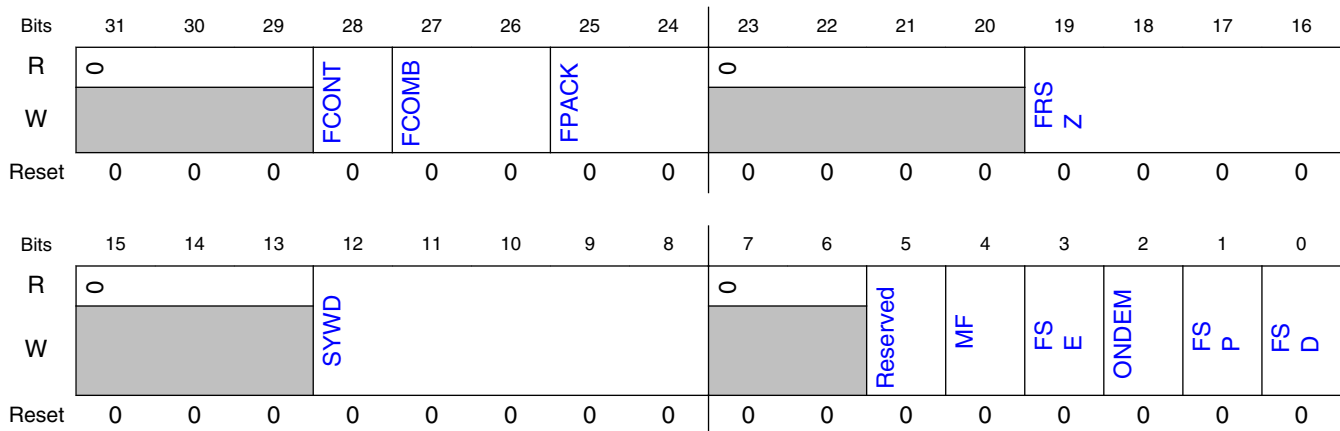

56.4.1.17.4 Fields

Field	Function
31-29 —	Reserved
28 FCONT	FIFO Continue on Error Configures when the SAI will continue receiving after a FIFO error has been detected. 0b - On FIFO error, the SAI will continue from the start of the next frame after the FIFO error flag has been cleared. 1b - On FIFO error, the SAI will continue from the same word that caused the FIFO error to set after the FIFO warning flag has been cleared.
27-26 FCOMB	FIFO Combine Mode When FIFO combine mode is enabled for FIFO reads, software reading any FIFO data register will alternate the read among the enabled data channel FIFOs. For example, if two data channels are enabled then the first read will be performed to the first enabled data channel FIFO and the second read will be performed to the second enabled data channel FIFO. Resetting the FIFO or disabling FIFO combine mode for FIFO reads will reset the pointer back to the first enabled data channel.

Table continues on the next page...

Memory map and register definition

Field	Function						
	<p>When FIFO combine mode is enabled for FIFO writes from the receive shift registers, the first enabled data channel input will alternate between the enabled data channel FIFOs. For example, if two data channels are enabled then the first unmasked received word will be stored in the first enabled data channel FIFO and the second unmasked received word will be stored in the second enabled data channel FIFO. Since the first word of the frame is always stored in the first enabled data channel FIFO, it is recommended that the number of unmasked words per frame is evenly divisible by the number of enabled data channels.</p> <p>NOTE: This field is not supported in every instance. The following table includes only supported registers.</p> <table border="1"> <thead> <tr> <th>Field supported in</th> <th>Field not supported in</th> </tr> </thead> <tbody> <tr> <td>SAI0_RCR4</td> <td>—</td> </tr> <tr> <td>—</td> <td>SAI1_RCR4</td> </tr> </tbody> </table> <p>00b - FIFO combine mode disabled. 01b - FIFO combine mode enabled on FIFO writes (from receive shift registers). 10b - FIFO combine mode enabled on FIFO reads (by software). 11b - FIFO combine mode enabled on FIFO writes (from receive shift registers) and reads (by software).</p>	Field supported in	Field not supported in	SAI0_RCR4	—	—	SAI1_RCR4
Field supported in	Field not supported in						
SAI0_RCR4	—						
—	SAI1_RCR4						
25-24 FPACK	<p>FIFO Packing Mode</p> <p>Enables packing of 8-bit data or 16-bit data into each 32-bit FIFO word. If the word size is greater than 8-bit or 16-bit then only the first 8-bit or 16-bits are stored to the FIFO. The first word in each frame always starts with a new 32-bit FIFO word and the first bit shifted must be configured within the first packed word. When FIFO packing is enabled, the FIFO read pointer will only increment when the full 32-bit FIFO word has been read by software.</p> <p>00b - FIFO packing is disabled 01b - Reserved. 10b - 8-bit FIFO packing is enabled 11b - 16-bit FIFO packing is enabled</p>						
23-20 —	Reserved						
19-16 FRSZ	<p>Frame Size</p> <p>Configures the number of words in each frame. The value written must be one less than the number of words in the frame. For example, write 0 for one word per frame. The maximum supported frame size is 16 words.</p>						
15-13 —	Reserved						
12-8 SYWD	<p>Sync Width</p> <p>Configures the length of the frame sync in number of bit clocks. The value written must be one less than the number of bit clocks. For example, write 0 for the frame sync to assert for one bit clock only. The sync width cannot be configured longer than the first word of the frame.</p>						
7-6 —	Reserved						
5 —	Reserved Software should only write zero to this bit.						
4 MF	<p>MSB First</p> <p>Configures whether the LSB or the MSB is received first.</p>						

Table continues on the next page...

Field	Function
	0b - LSB is received first. 1b - MSB is received first.
3 FSE	Frame Sync Early 0b - Frame sync asserts with the first bit of the frame. 1b - Frame sync asserts one bit before the first bit of the frame.
2 ONDEM	On Demand Mode When set, and the frame sync is generated internally, a frame sync is only generated when the FIFO warning flag is clear. 0b - Internal frame sync is generated continuously. 1b - Internal frame sync is generated when the FIFO warning flag is clear.
1 FSP	Frame Sync Polarity Configures the polarity of the frame sync. 0b - Frame sync is active high. 1b - Frame sync is active low.
0 FSD	Frame Sync Direction Configures the direction of the frame sync. 0b - Frame Sync is generated externally in Slave mode. 1b - Frame Sync is generated internally in Master mode.

56.4.1.18 SAI Receive Configuration 5 Register (RCR5)

56.4.1.18.1 Offset

Register	Offset
RCR5	9Ch

56.4.1.18.2 Function

This register must not be altered when RCSR[RE] is set.

56.4.1.18.3 Diagram

Bits	31	30	29	28	27	26	25	24	23	22	21	20	19	18	17	16
R	0			WNW						0			WOW			
W	[Greyed out]			[Greyed out]						[Greyed out]			[Greyed out]			
Reset	0	0	0	0	0	0	0	0	0	0	0	0	0	0	0	0
Bits	15	14	13	12	11	10	9	8	7	6	5	4	3	2	1	0
R	0			FBT						0						
W	[Greyed out]			[Greyed out]						[Greyed out]						
Reset	0	0	0	0	0	0	0	0	0	0	0	0	0	0	0	0

56.4.1.18.4 Fields

Field	Function
31-29 —	Reserved
28-24 WNW	Word N Width Configures the number of bits in each word, for each word except the first in the frame. The value written must be one less than the number of bits per word. Word width of less than 8 bits is not supported.
23-21 —	Reserved
20-16 W0W	Word 0 Width Configures the number of bits in the first word in each frame. The value written must be one less than the number of bits in the first word. Word width of less than 8 bits is not supported if there is only one word per frame.
15-13 —	Reserved
12-8 FBT	First Bit Shifted Configures the bit index for the first bit received for each word in the frame. If configured for MSB First, the index of the next bit received is one less than the current bit received. If configured for LSB First, the index of the next bit received is one more than the current bit received. The value written must be greater than or equal to the word width when configured for MSB First. The value written must be less than or equal to 31-word width when configured for LSB First.
7-0 —	Reserved

56.4.1.19 SAI Receive Data Register (RDR0 - RDR3)

56.4.1.19.1 Offset

Register	Offset
RDR0	A0h
RDR1	A4h
RDR2	A8h
RDR3	ACh

NOTE

Each module instance supports a different number of registers.

Register supported	Register not supported
SAI0_R DR0– RDR3	—
SAI1_R DR0	SAI1_R DR1– RDR3

56.4.1.19.2 Diagram

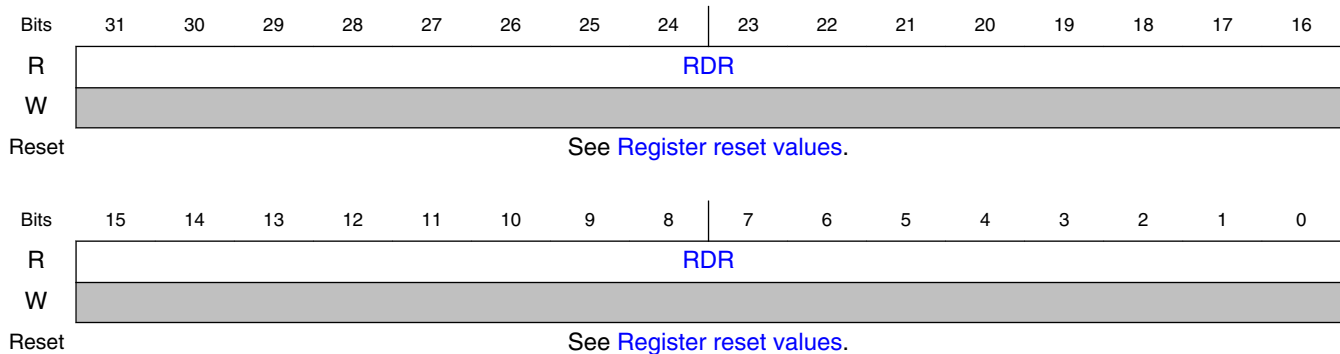

56.4.1.19.3 Register reset values

Register	Reset value
RDR0	SAI0,SAI1: 0000_0000h
RDR1–RDR3	0000_0000h

56.4.1.19.4 Fields

Field	Function
31-0	Receive Data Register
RDR	Reads from this register when the receive FIFO is not empty will return the data from the top of the receive FIFO. Reads from this register when the receive FIFO is empty are ignored.

56.4.1.20 SAI Receive FIFO Register (RFR0 - RFR3)

56.4.1.20.1 Offset

Register	Offset
RFR0	C0h
RFR1	C4h
RFR2	C8h
RFR3	CCh

56.4.1.20.2 Function

The MSB of the read and write pointers is used to distinguish between FIFO full and empty conditions. If the read and write pointers are identical, then the FIFO is empty. If the read and write pointers are identical except for the MSB, then the FIFO is full.

NOTE

Each module instance supports a different number of registers.

Register supported	Register not supported
SAI0_R FR0– RFR3	—
SAI1_R FR0	SAI1_R FR1– RFR3

56.4.1.20.3 Diagram

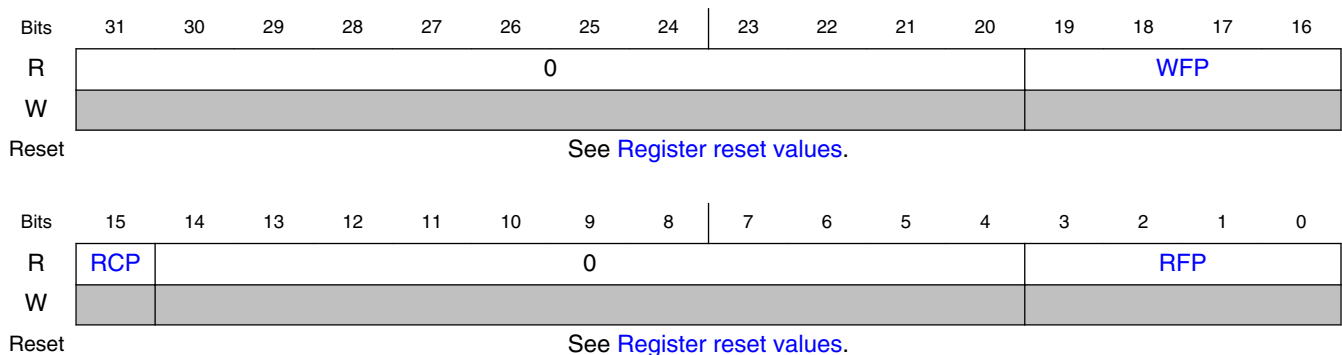

56.4.1.20.4 Register reset values

Register	Reset value
RFR0	SAI0,SAI1: 0000_0000h
RFR1–RFR3	0000_0000h

56.4.1.20.5 Fields

Field	Function						
31-20 —	Reserved						
19-16 WFP	Write FIFO Pointer FIFO write pointer for receive data channel.						
15 RCP	Receive Channel Pointer When FIFO Combine mode is enabled for reads, indicates that this data channel is the next FIFO to be read. NOTE: This field is not supported in every instance. The following table includes only supported registers. <table border="1" data-bbox="431 961 1458 1087"> <thead> <tr> <th>Field supported in</th> <th>Field not supported in</th> </tr> </thead> <tbody> <tr> <td>SAI0_RFR0–RFR3</td> <td>—</td> </tr> <tr> <td>—</td> <td>SAI1_RFR0</td> </tr> </tbody> </table> 0b - No effect. 1b - FIFO combine is enabled for FIFO reads and this FIFO will be read on the next FIFO read.	Field supported in	Field not supported in	SAI0_RFR0–RFR3	—	—	SAI1_RFR0
Field supported in	Field not supported in						
SAI0_RFR0–RFR3	—						
—	SAI1_RFR0						
14-4 —	Reserved						
3-0 RFP	Read FIFO Pointer FIFO read pointer for receive data channel.						

56.4.1.21 SAI Receive Mask Register (RMR)

56.4.1.21.1 Offset

Register	Offset
RMR	E0h

56.4.1.21.2 Function

This register is double-buffered and updates:

1. When RCSR[RE] is first set
2. At the end of each frame

This allows the masked words in each frame to change from frame to frame.

56.4.1.21.3 Diagram

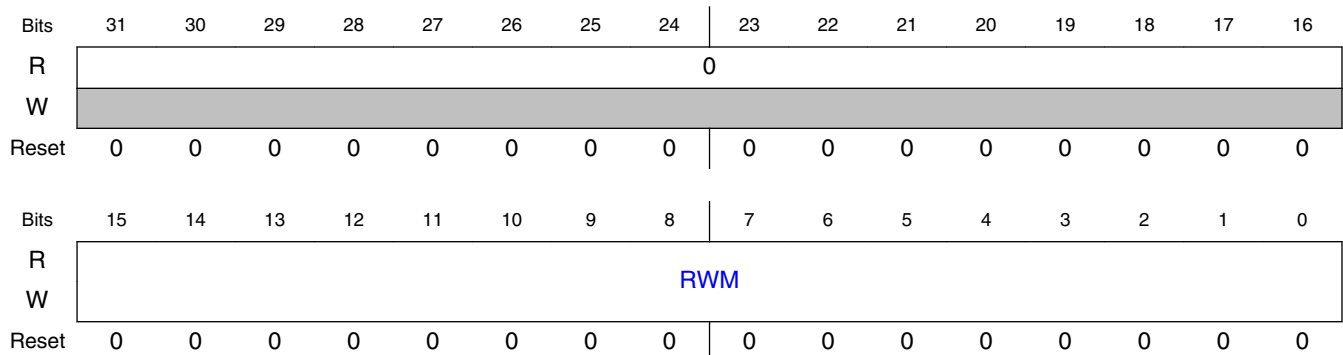

56.4.1.21.4 Fields

Field	Function
31-16 —	Reserved
15-0 RWM	Receive Word Mask Configures whether the receive word is masked (received data ignored and not written to receive FIFO) for the corresponding word in the frame. 0000000000000000b - Word N is enabled. 0000000000000001b - Word N is masked.

56.5 Functional description

This section provides a complete functional description of the block.

56.5.1 SAI clocking

The SAI clocks include:

- The audio master clock
- The bit clock
- The bus clock

56.5.1.1 Audio master clock

The audio master clock is used to generate the bit clock when the receiver or transmitter is configured for an internally generated bit clock. The transmitter and receiver can independently select between the bus clock and up to three audio master clocks to generate the bit clock.

The audio master clock generation and selection is chip-specific. Refer to chip-specific clocking information about how the audio master clocks are generated.

56.5.1.2 Bit clock

The SAI transmitter and receiver support asynchronous free-running bit clocks that can be generated internally from an audio master clock or supplied externally. There is also the option for synchronous bit clock and frame sync operation between the receiver and transmitter or between multiple SAI peripherals.

- If both transmitter and receiver are configured for asynchronous operation, then the transmitter and receiver will each use *their own* bit clock and frame sync.
- If the *transmitter* is configured for asynchronous mode and the receiver is configured for synchronous mode, then both transmitter and receiver will use the *transmitter* bit clock and frame sync.
- If the *receiver* is configured for asynchronous mode and the transmitter is configured for synchronous mode, then both transmitter and receiver will use the *receiver* bit clock and frame sync.

Note that the software configures synchronous or asynchronous mode, and that choice selects the bit clock/frame sync used.

Externally generated bit clocks must be:

- Enabled before the SAI transmitter or receiver is enabled
- Disabled after the SAI transmitter or receiver is disabled and completes its current frames

If the SAI transmitter or receiver is using an externally generated bit clock in asynchronous mode and that bit clock is generated by an SAI that is disabled in stop mode, then the transmitter or receiver should be disabled by software before entering stop mode. This issue does not apply when the transmitter or receiver is in a synchronous mode because all synchronous SAIs are enabled and disabled simultaneously.

56.5.1.3 Bus clock

The bus clock is used by the control and configuration registers and to generate synchronous interrupts and DMA requests.

NOTE

Although there is no specific minimum bus clock frequency specified, the bus clock frequency must be fast enough (relative to the bit clock frequency) to ensure that the FIFOs can be serviced, without generating either a transmitter FIFO underrun or receiver FIFO overflow condition.

56.5.2 SAI resets

The SAI is asynchronously reset on system reset. The SAI has a software reset and a FIFO reset.

56.5.2.1 Software reset

The SAI transmitter includes a software reset that resets all transmitter internal logic, including the bit clock generation, status flags, and FIFO pointers. It does not reset the configuration registers. The software reset remains asserted until cleared by software.

The SAI receiver includes a software reset that resets all receiver internal logic, including the bit clock generation, status flags and FIFO pointers. It does not reset the configuration registers. The software reset remains asserted until cleared by software.

56.5.2.2 FIFO reset

The SAI transmitter includes a FIFO reset that synchronizes the FIFO write pointer to the same value as the FIFO read pointer. This empties the FIFO contents and is to be used after TCSR[FEF] is set, and before the FIFO is re-initialized and TCSR[FEF] is cleared. The FIFO reset is asserted for one cycle only.

The SAI transmitter can also reset the FIFO of individual data channels by setting the appropriate TCR3[CFR] bit. This should only be done when the corresponding TCR3[TCE] bit is clear.

The SAI receiver includes a FIFO reset that synchronizes the FIFO read pointer to the same value as the FIFO write pointer. This empties the FIFO contents and is to be used after the RCSR[FEF] is set and any remaining data has been read from the FIFO, and before the RCSR[FEF] is cleared. The FIFO reset is asserted for one cycle only.

The SAI receiver can also reset the FIFO of individual data channels by setting the appropriate RCR3[CFR] bit. This should only be done when the corresponding RCR3[RCE] bit is clear.

56.5.3 Synchronous modes

The SAI transmitter and receiver can operate synchronously to each other.

56.5.3.1 Synchronous mode

The SAI transmitter and receiver can be configured to operate with synchronous bit clock and frame sync.

If the transmitter bit clock and frame sync are to be used by both the transmitter and receiver:

- The transmitter must be configured for asynchronous operation and the receiver for synchronous operation.
- In synchronous mode, the receiver is enabled only when both the transmitter and receiver are enabled.
- It is recommended that the transmitter is the last enabled and the first disabled.

If the receiver bit clock and frame sync are to be used by both the transmitter and receiver:

- The receiver must be configured for asynchronous operation and the transmitter for synchronous operation.
- In synchronous mode, the transmitter is enabled only when both the receiver and transmitter are both enabled.
- It is recommended that the receiver is the last enabled and the first disabled.

When operating in synchronous mode, only the bit clock, frame sync, and transmitter/receiver enable are shared. The transmitter and receiver otherwise operate independently, although configuration registers must be configured consistently across both the transmitter and receiver.

56.5.4 Frame sync configuration

When enabled, the SAI continuously transmits and/or receives frames of data. Each frame consists of a fixed number of words and each word consists of a fixed number of bits. Within each frame, any given word can be masked causing the receiver to ignore that word and the transmitter to tri-state for the duration of that word.

The frame sync signal is used to indicate the start of each frame. A valid frame sync requires a rising edge (if active high) or falling edge (if active low) to be detected and the transmitter or receiver cannot be busy with a previous frame. A valid frame sync is also ignored (slave mode) or not generated (master mode) for the first four bit clock cycles after enabling the transmitter or receiver.

The transmitter and receiver frame sync can be configured independently with any of the following options:

- Externally generated or internally generated
- Active high or active low
- Assert with the first bit in frame or asserts one bit early
- Assert for a duration between 1 bit clock and the first word length
- Frame length from 1 to 16 words per frame
- Word length to support 8 to 32 bits per word
 - First word length and remaining word lengths can be configured separately
- Words can be configured to transmit/receive MSB first or LSB first

These configuration options cannot be changed after the SAI transmitter or receiver is enabled.

56.5.5 Data FIFO

Each transmit and receive channel includes a FIFO of size 8 x 32-bit. The FIFO data is accessed using the SAI Transmit/Receive Data Registers.

56.5.5.1 Data alignment

Data in the FIFO can be aligned anywhere within the 32-bit wide register through the use of the First Bit Shifted configuration field, which selects the bit index (between 31 and 0) of the first bit shifted.

Examples of supported data alignment and the required First Bit Shifted configuration are illustrated in Figure 56-3 for LSB First configurations and Figure 56-4 for MSB First configurations.

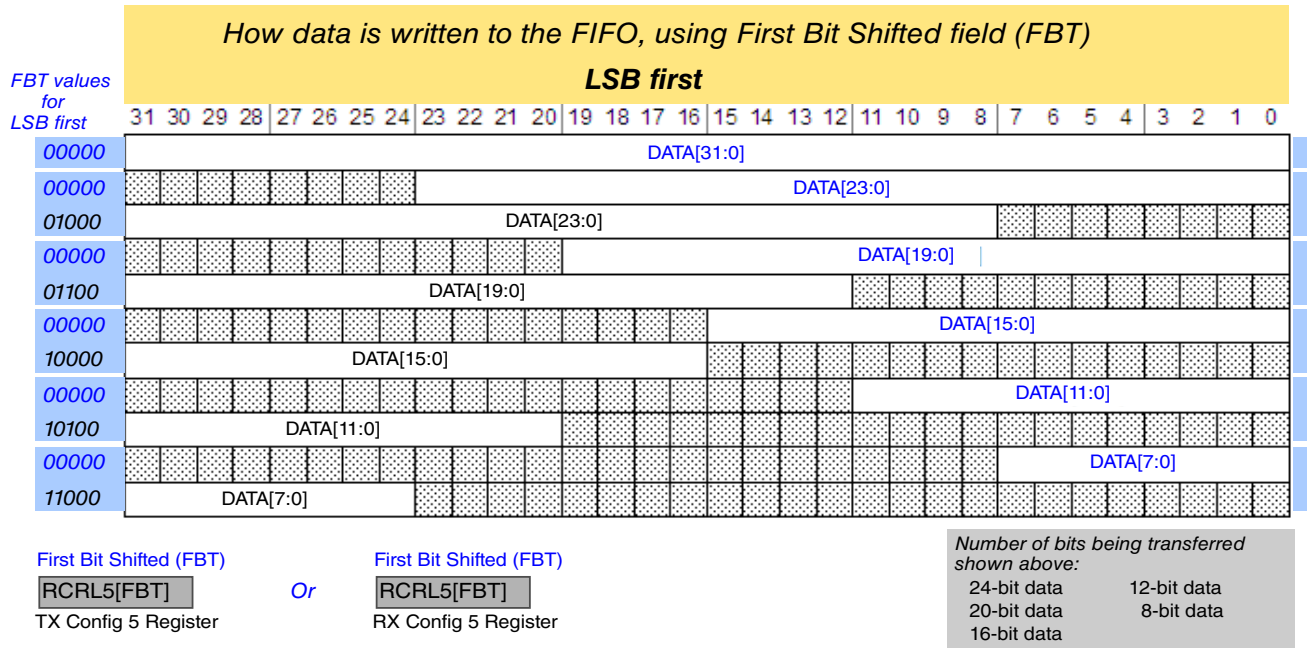

Figure 56-3. SAI first bit shifted, LSB first

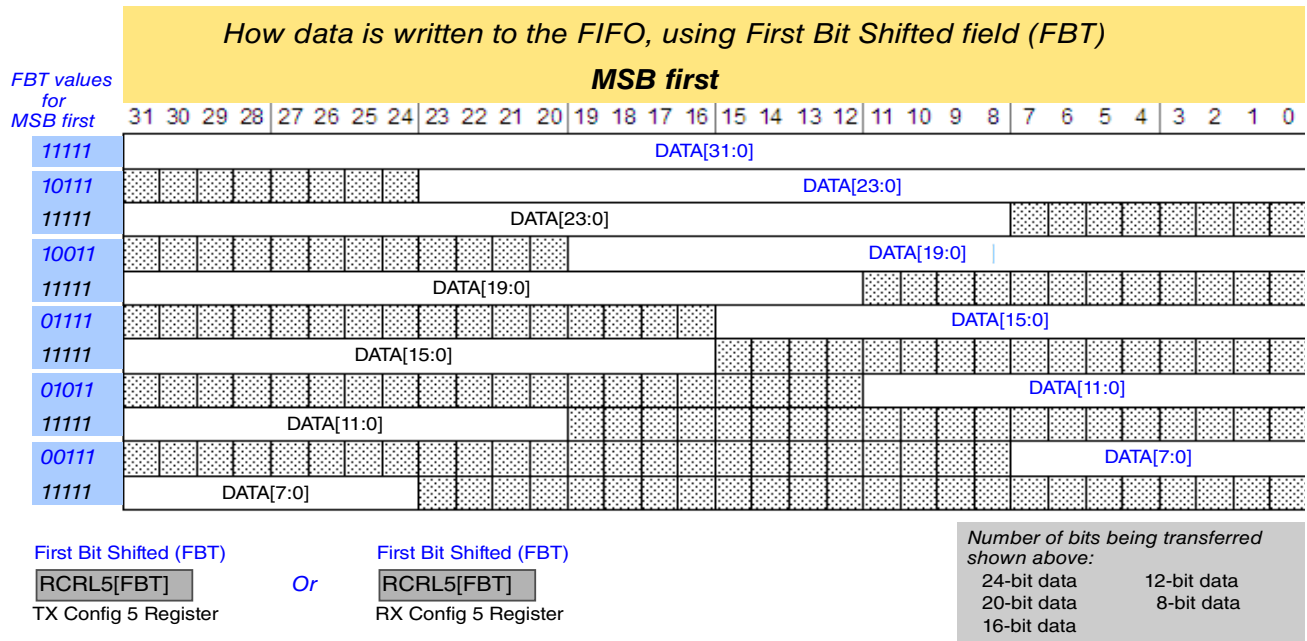

Figure 56-4. SAI first bit shifted, MSB first

56.5.5.2 FIFO pointers

When writing to a Transmit Data Register (TDR_n), the Write FIFO Pointer (WFP) of the corresponding Transmit FIFO Register (TFR_n) increments after each valid write. The SAI supports 8-bit, 16-bit and 32-bit writes to the Transmit Data Register and the FIFO pointer will increment after each individual write. Note that 8-bit writes should only be used when transmitting up to 8-bit data; 16-bit writes should only be used when transmitting up to 16-bit data.

- If the Transmit FIFO is full, then writes to a Transmit Data Register are ignored.
- If the Transmit FIFO is empty, then to avoid a FIFO underrun, the Transmit Data Register must be written at least 3 bit clocks before the start of the next unmasked word. Before enabling the transmitter, the Transmit FIFO should be initialized with data (since after the transmitter is enabled, the transmitter will start a new frame, and if no data is in the FIFO, then the transmitter will immediately give an error).

When reading a Receive Data Register (RDR_n), the Read FIFO Pointer (RFP) of the corresponding Receive FIFO Register (RFR_n) increments after each valid read. The SAI supports 8-bit, 16-bit and 32-bit reads from the RDR and the FIFO pointer will increment after each individual read. Note that 8-bit reads should only be used when receiving up to 8-bit data; 16-bit reads should only be used when receiving up to 16-bit data.

- If the Receive FIFO is empty, then reads from a Receive Data Register are ignored.
- If the Receive FIFO is full, then to avoid a FIFO overrun, the Receive Data Register must be read at least 3 bit clocks before the end of an unmasked word.

56.5.5.3 FIFO packing

FIFO packing supports storing multiple 8-bit or 16-bit data words in one 32-bit FIFO word for the transmitter and/or receiver. While this can be emulated by adjusting the number of bits per word and number of words per frame (for example, one 32-bit word per frame versus two 16-bit words per frame), FIFO packing does not require even multiples of words per frame and fully supports word masking. When FIFO packing is enabled, the FIFO pointers only increment when the full 32-bit FIFO word has been written (transmit) or read (receive) by software, supporting scenarios where different words within each frame are loaded/stored in different areas of memory.

When 16-bit FIFO packing is enabled for transmit, the transmit shift register is loaded at the start of each frame and after every second unmasked transmit word. The first word transmitted is taken from 16-bit word at byte offset \$0 (first bit is selected by TCFG5[FBT] must be configured within this 16-bit word) and the second word transmitted is taken from the 16-bit word at byte offset \$2 (first bit is selected by TCSR5[FBT][3:0]). The transmitter will transmit logic zero until the start of the next word once the 16-bit word has been transmitted.

When 16-bit FIFO packing is enabled for receive, the receive shift register is stored after every second unmasked received word, and at the end of each frame if there is an odd number of unmasked received words in each frame. The first word received is stored in the 16-bit word at byte offset \$0 (first bit is selected by RCFG5[FBT] and must be configured within this 16-bit word) and the second word received is stored in the 16-bit word at byte offset \$2 (first bit is selected by RCSR5[FBT][3:0]). The receiver will ignore received data until the start of the next word once the 16-bit word has been received.

The 8-bit FIFO packing is similar to 16-bit packing except four words are loaded or stored into each 32-bit FIFO word. The first word is loaded/stored in byte offset \$0, second word in byte offset \$1, third word in byte offset \$2 and fourth word in byte offset \$3. The TCFG5[FBT] and/or RCFG5[FBT] must be configured within byte offset \$0.

56.5.5.4 FIFO Combine

FIFO combining mode allows the separate FIFOs for multiple data channels to be used as a single FIFO for either software accesses or a single data channel or both. Note that the enabled data channels must be contiguous and data channel 0 must be enabled when FIFO Combine mode is enabled.

Combining FIFOs for software access (writing transmit FIFO registers, reading receive FIFO registers) allows a DMA controller or software to read or write multiple FIFOs without incrementing the address that is accessed. Once enabled, the first software access to a FIFO register will access the first enabled channel FIFO, while the second access to a FIFO register will access the second enabled channel FIFO. This continues until software accesses the last enabled channel FIFO and the pointer resets back to the first enabled channel FIFO. To reset the pointer manually, software can reset the FIFOs or disable the FIFO combining on software accesses.

Combining FIFOs for transmit data channels allows one data channel to use the FIFOs of all enabled channel FIFOs, with identical data output on each enabled data channel. The transmit shift registers for all enabled data channels are loaded at the start of each frame and every N unmasked words (where N is the number of enabled data channels). The first word transmitted is loaded from the first enabled channel FIFO, while the second word transmitted is loaded from the second enabled channel FIFO, and so on until the end of the frame. Since the first word in each frame is always loaded from the first enabled data channel, it is recommended that the number of unmasked words in each frame is evenly divisible by the number of enabled data channels.

Combining FIFOs for receive data channels allows one data channel to use the FIFOs of all enabled channel FIFOs, with received data from channel 0 stored into each enabled data channel. The receive shift register for all enabled data channels are stored after every N unmasked words (where N is the number of enabled data channels). The first word received is stored to the first enabled channel FIFO, while the second word received is stored to the second enabled channel FIFO, and so on until the end of the frame. Since the first word in each frame is always stored the first enabled data channel, it is recommended that the number of unmasked words in each frame is evenly divisible by the number of enabled data channels.

Note that combining FIFOs for data channels will load or store each channel FIFO at the same time. This means that FIFO error conditions are only checked every N words (where N is the number of enabled data channels) and that the FIFO warning and request flags will assert if any of the enabled data channel meets the warning flag or request flag conditions.

56.5.6 Word mask register

The SAI transmitter and receiver each contain a word mask register, namely TMR and RMR, that can be used to mask any word in the frame. Because the word mask register is double buffered, software can update it before the end of each frame to mask a particular word in the next frame.

The TMR causes the Transmit Data pin to be tri-stated for the length of each selected word and the transmit FIFO is not read for masked words.

The RMR causes the received data for each selected word to be discarded and not written to the receive FIFO.

56.5.7 Interrupts and DMA requests

The SAI transmitter and receiver generate separate interrupts and separate DMA requests, but support the same status flags.

56.5.7.1 FIFO request flag

The FIFO request flag is set based on the number of entries in the FIFO and the FIFO watermark configuration.

The transmit FIFO request flag is set when the number of entries in any of the enabled transmit FIFOs is less than or equal to the transmit FIFO watermark configuration and is cleared when the number of entries in each enabled transmit FIFO is greater than the transmit FIFO watermark configuration.

The receive FIFO request flag is set when the number of entries in any of the enabled receive FIFOs is greater than the receive FIFO watermark configuration and is cleared when the number of entries in each enabled receive FIFO is less than or equal to the receive FIFO watermark configuration.

The FIFO request flag can generate an interrupt or a DMA request.

56.5.7.2 FIFO warning flag

The FIFO warning flag is set based on the number of entries in the FIFO.

The transmit warning flag is set when the number of entries in any of the enabled transmit FIFOs is empty and is cleared when the number of entries in each enabled transmit FIFO is not empty.

The receive warning flag is set when the number of entries in any of the enabled receive FIFOs is full and is cleared when the number of entries in each enabled receive FIFO is not full.

The FIFO warning flag can generate an Interrupt or a DMA request.

56.5.7.3 FIFO error flag

The transmit FIFO error flag is set when the any of the enabled transmit FIFOs underflow. After it is set, all enabled transmit channels will transmit zero data before TCSR[FEF] is cleared.

When TCR4[FCONT] is set, the FIFO will continue transmitting data following an underflow without software intervention. To ensure that data is transmitted in the correct order, the transmitter will continue from the same word number in the frame that caused the FIFO to underflow, but only after new data has been written to the transmit FIFO. Software should still clear the TCSR[FEF] flag, but without reinitializing the transmit FIFOs.

RCSR[FEF] is set when the any of the enabled receive FIFOs overflow. After it is set, all enabled receive channels discard received data until RCSR[FEF] is cleared and the next next receive frame starts. All enabled receive FIFOs should be emptied before RCSR[FEF] is cleared.

When RCR4[FCONT] is set, the FIFO will continue receiving data following an overflow without software intervention. To ensure that data is received in the correct order, the receiver will continue from the same word number in the frame that caused the FIFO to overflow, but only after data has been read from the receive FIFO. Software should still clear the RCSR[FEF] flag, but without emptying the receive FIFOs.

The FIFO error flag can generate only an interrupt.

56.5.7.4 Sync error flag

The sync error flag, TCSR[SEF] or RCSR[SEF], is set when configured for an externally generated frame sync and the external frame sync asserts when the transmitter or receiver is busy with the previous frame. The external frame sync assertion is ignored and the sync error flag is set. When the sync error flag is set, the transmitter or receiver continues checking for frame sync assertion when idle or at the end of each frame.

The sync error flag can generate an interrupt only.

56.5.7.5 Word start flag

The word start flag is set at the start of the second bit clock for the selected word, as configured by the Word Flag register field.

The word start flag can generate an interrupt only.

Chapter 57

Ethernet MAC (ENET)

57.1 Chip-specific ENET information

S32K148 has one instance of the ENET module. Other products in the S32K1xx series do not have the ENET module.

NOTE

- Prior to using ENET_MDIO or ENET_TMRx, GPIO_PDDR needs to be configured for the corresponding pins.
- Enable the Drive strength for the transmitting pads of ENET by setting DSE field of PORT_PCRn register
- Wakeup through magic packet is supported only from STOPx modes and not from VLPS mode. This wakeup is independent of EIMR[WAKEUP] bit field.
- For RMI mode, MII_RMII_TX_CLK in IO Signal Description Input Multiplexing sheet is referred as RMII_REF_CLK.

57.1.1 Software guideline during ENET operation

System frequency must not be changed during ENET operation as this can cause FIFO Underrun condition.

57.2 Introduction

The MAC-NET core, in conjunction with a 10/100-Mbit/s MAC, implements layer 3 network acceleration functions. These functions are designed to accelerate the processing of various common networking protocols, such as IP, TCP, UDP, and ICMP, providing wire speed services to client applications.

57.3 Overview

The core implements a dual-speed 10/100-Mbit/s Ethernet MAC compliant with the IEEE802.3-2002 standard. The MAC layer provides compatibility with half- or full-duplex 10/100-Mbit/s Ethernet LANs.

The MAC operation is fully programmable and can be used in Network Interface Card (NIC), bridging, or switching applications. The core implements the remote network monitoring (RMON) counters according to IETF RFC 2819.

The core also implements a hardware acceleration block to optimize the performance of network controllers providing TCP/IP, UDP, and ICMP protocol services. The acceleration block performs critical functions in hardware, which are typically implemented with large software overhead.

The core implements programmable embedded FIFOs that can provide buffering on the receive path for lossless flow control.

Advanced power management features are available with magic packet detection and programmable power-down modes.

A unified DMA (uDMA), internal to the ENET module, optimizes data transfer between the ENET core and the SoC, and supports an enhanced buffer descriptor programming model to support IEEE 1588 functionality.

The programmable Ethernet MAC with IEEE 1588 integrates a standard IEEE 802.3 Ethernet MAC with a time-stamping module. The IEEE 1588 standard provides accurate clock synchronization for distributed control nodes for industrial automation applications.

57.3.1 Features

57.3.1.1 Ethernet MAC features

- Implements the full 802.3 specification with preamble/SFD generation, frame padding generation, CRC generation and checking
- Supports zero-length preamble
- Dynamically configurable to support 10/100-Mbit/s operation
- Supports 10/100 Mbit/s full-duplex and configurable half-duplex operation
- Compliant with the AMD magic packet detection with interrupt for node remote power management
- Seamless interface to commercial ethernet PHY devices via one of the following:

- a 4-bit Media Independent Interface (MII) operating at 2.5/25 MHz.
- a 4-bit non-standard MII-Lite (MII without the CRS and COL signals) operating at 2.5/25 MHz.
- a 2-bit Reduced MII (RMII) operating at 50 MHz.
- Simple 64-Bit FIFO user-application interface
- CRC-32 checking at full speed with optional forwarding of the frame check sequence (FCS) field to the client
- CRC-32 generation and append on transmit or forwarding of user application provided FCS selectable on a per-frame basis
- In full-duplex mode:
 - Implements automated pause frame (802.3 x31A) generation and termination, providing flow control without user application intervention
 - Pause quanta used to form pause frames — dynamically programmable
 - Pause frame generation additionally controllable by user application offering flexible traffic flow control
 - Optional forwarding of received pause frames to the user application
 - Implements standard flow-control mechanism
- In half-duplex mode: provides full collision support, including jamming, backoff, and automatic retransmission
- Supports VLAN-tagged frames according to IEEE 802.1Q
- Programmable MAC address: Insertion on transmit; discards frames with mismatching destination address on receive (except broadcast and pause frames)
- Programmable promiscuous mode support to omit MAC destination address checking on receive
- Multicast and unicast address filtering on receive based on 64-entry hash table, reducing higher layer processing load
- Programmable frame maximum length providing support for any standard or proprietary frame length
- Statistics indicators for frame traffic and errors (alignment, CRC, length) and pause frames providing for IEEE 802.3 basic and mandatory management information database (MIB) package and remote network monitoring (RFC 2819)
- Simple handshake user application FIFO interface with fully programmable depth and threshold levels
- Provides separate status word for each received frame on the user interface providing information such as frame length, frame type, VLAN tag, and error information
- Multiple internal loopback options
- MDIO master interface for PHY device configuration and management supports two programmable MDIO base addresses, and standard (IEEE 802.3 Clause 22) and extended (Clause 45) MDIO frame formats
- Supports legacy FEC buffer descriptors

57.3.1.2 IP protocol performance optimization features

- Operates on TCP/IP and UDP/IP and ICMP/IP protocol data or IP header only
- Enables wire-speed processing
- Supports IPv4 and IPv6
- Transparent passing of frames of other types and protocols
- Supports VLAN tagged frames according to IEEE 802.1q with transparent forwarding of VLAN tag and control field
- Automatic IP-header and payload (protocol specific) checksum calculation and verification on receive
- Automatic IP-header and payload (protocol specific) checksum generation and automatic insertion on transmit configurable on a per-frame basis
- Supports IP and TCP, UDP, ICMP data for checksum generation and checking
- Supports full header options for IPv4 and TCP protocol headers
- Provides IPv6 support to datagrams with base header only — datagrams with extension headers are passed transparently unmodified/unchecked
- Provides statistics information for received IP and protocol errors
- Configurable automatic discard of erroneous frames
- Configurable automatic host-to-network (RX) and network-to-host (TX) byte order conversion for IP and TCP/UDP/ICMP headers within the frame
- Configurable padding remove for short IP datagrams on receive
- Configurable Ethernet payload alignment to allow for 32-bit word-aligned header and payload processing
- Programmable store-and-forward operation with clock and rate decoupling FIFOs

57.3.1.3 IEEE 1588 features

- Supports all IEEE 1588 frames.
- Allows reference clock to be chosen independently of network speed.
- Software-programmable precise time-stamping of ingress and egress frames

- Timer monitoring capabilities for system calibration and timing accuracy management
- Precise time-stamping of external events with programmable interrupt generation
- Programmable event and interrupt generation for external system control
- Supports hardware- and software-controllable timer synchronization.
- Provides a 4-channel IEEE 1588 timer. Each channel supports input capture and output compare using the 1588 counter.

57.3.2 Block diagram

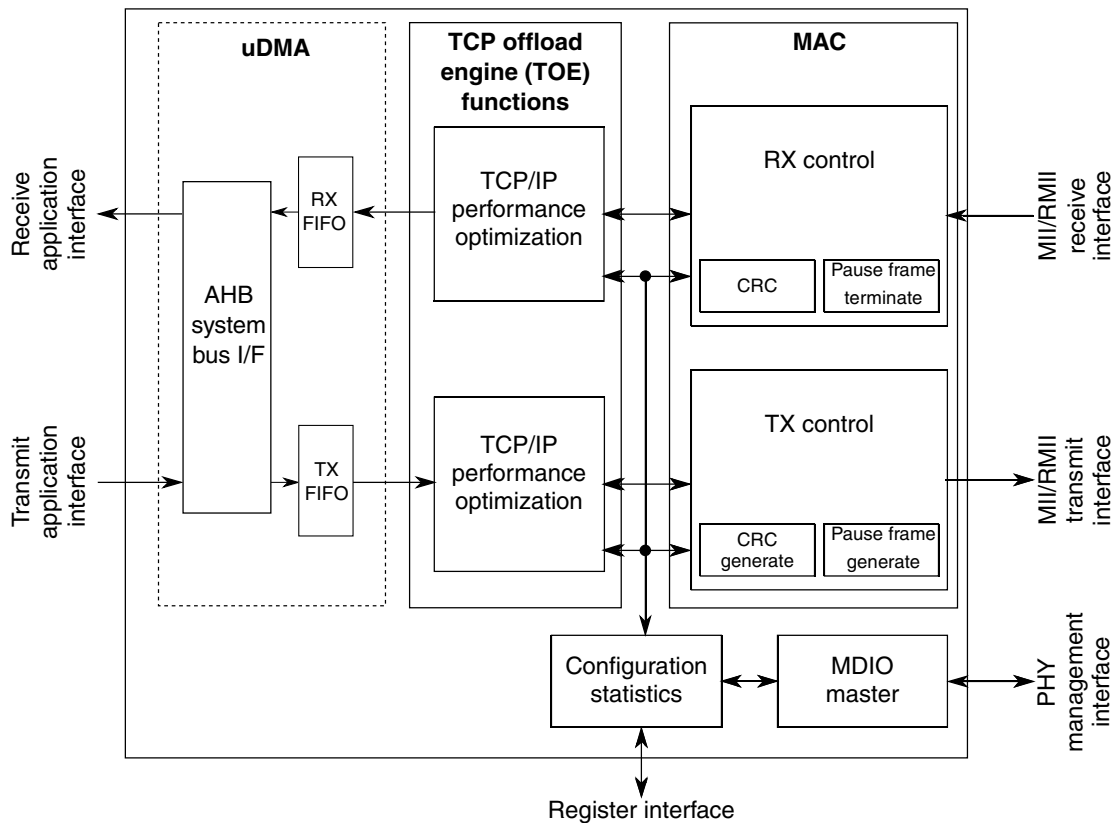

Figure 57-1. Ethernet MAC-NET core block diagram

57.4 External signal description

NOTE

The MII column pertains only to devices that support MII.

External signal description

MII	RMII	Description	I/O
MII_COL	—	Asserted upon detection of a collision and remains asserted while the collision persists. This signal is not defined for full-duplex mode.	I
MII_CRIS	—	Carrier sense. When asserted, indicates transmit or receive medium is not idle. In RMII mode, this signal is present on the RMII_CRIS_DV pin.	I
MII_MDC	RMII_MDC	Output clock provides a timing reference to the PHY for data transfers on the MDIO signal.	O
MII_MDIO	RMII_MDIO	Transfers control information between the external PHY and the media-access controller. Data is synchronous to MDC. This signal is an input after reset.	I/O
MII_RXCLK	—	In MII mode, provides a timing reference for RXDV, RXD[3:0], and RXER.	I
MII_RXDV	RMII_CRIS_DV	Asserting this input indicates the PHY has valid nibbles present on the MII. RXDV must remain asserted from the first recovered nibble of the frame through to the last nibble. Asserting RXDV must start no later than the SFD and exclude any EOF. In RMII mode, this pin also generates the CRIS signal.	I
MII_RXD[3:0]	RMII_RXD[1:0]	Contains the Ethernet input data transferred from the PHY to the media-access controller when RXDV is asserted.	I
MII_RXER	RMII_RXER	When asserted with RXDV, indicates the PHY detects an error in the current frame.	I
MII_TXCLK	—	Input clock, which provides a timing reference for TXEN, TXD[3:0], and TXER.	I
MII_TXD[3:0]	RMII_TXD[1:0]	Serial output Ethernet data. Only valid during TXEN assertion.	O
MII_TXEN	RMII_TXEN	Indicates when valid nibbles are present on the MII. This signal is asserted with the	O

Table continues on the next page...

MII	RMII	Description	I/O
		first nibble of a preamble and is deasserted before the first TXCLK following the final nibble of the frame.	
MII_TXER	—	When asserted for one or more clock cycles while TXEN is also asserted, PHY sends one or more illegal symbols.	O
—	RMII_REF_CLK	In RMII mode, this signal is the reference clock for receive, transmit, and the control interface.	I
1588_TMR _n	1588_TMR _n	<p>Capture/Compare block input/output event bus.</p> <p>When configured for capture and a rising edge is detected, the current timer value is latched and transferred into the corresponding ENET_TCCR_n register for inspection by software.</p> <p>When configured for compare, the corresponding signal 1588_TMR_n is asserted for one cycle when the timer reaches the compare value programmed in ENET_TCCR_n.</p> <p>An interrupt can be triggered if ENET_TCSR_n[TIE] is set.</p> <p>A DMA request can be triggered if ENET_TCSR_n[TDRE] is set.</p>	I/O
ENET_1588_CLKIN	ENET_1588_CLKIN	Alternate IEEE 1588 Ethernet clock input; Clock period should be an integer number of nanoseconds	I

57.5 Memory map/register definition

ENET registers must be read or written with 32-bit accesses. Non-32 bit accesses will terminate with an error.

Reserved bits should be written with 0 and ignored on read. Unused registers read zero and a write has no effect.

This table shows Ethernet registers organization.

Table 57-1. Register map summary

Offset Address	Section	Description
0x0000 – 0x01FF	Configuration	Core control and status registers
0x0200 – 0x03FF	Statistics counters	MIB and Remote Network Monitoring (RFC 2819) registers
0x0400 – 0x0430	1588 control	1588 adjustable timer (TSM) and 1588 frame control
0x0600 – 0x07FC	Capture/Compare block	Registers for the Capture/Compare block

ENET memory map

Address offset (hex)	Register name	Width (in bits)	Access	Reset value	Section/page
4	Interrupt Event Register (ENET_EIR)	32	w1c	0000_0000h	57.5.1/2008
8	Interrupt Mask Register (ENET_EIMR)	32	R/W	0000_0000h	57.5.2/2011
10	Receive Descriptor Active Register (ENET_RDAR)	32	R/W	0000_0000h	57.5.3/2014
14	Transmit Descriptor Active Register (ENET_TDAR)	32	R/W	0000_0000h	57.5.4/2015
24	Ethernet Control Register (ENET_ECR)	32	R/W	F000_0000h	57.5.5/2016
40	MII Management Frame Register (ENET_MMFR)	32	R/W	0000_0000h	57.5.6/2018
44	MII Speed Control Register (ENET_MSCR)	32	R/W	0000_0000h	57.5.7/2018
64	MIB Control Register (ENET_MIBC)	32	R/W	C000_0000h	57.5.8/2021
84	Receive Control Register (ENET_RCR)	32	R/W	05EE_0001h	57.5.9/2022
C4	Transmit Control Register (ENET_TCR)	32	R/W	0000_0000h	57.5.10/2025
E4	Physical Address Lower Register (ENET_PALR)	32	R/W	0000_0000h	57.5.11/2027
E8	Physical Address Upper Register (ENET_PAUR)	32	R/W	0000_8808h	57.5.12/2027
EC	Opcode/Pause Duration Register (ENET_OPD)	32	R/W	0001_0000h	57.5.13/2028
118	Descriptor Individual Upper Address Register (ENET_IAUR)	32	R/W	0000_0000h	57.5.14/2028
11C	Descriptor Individual Lower Address Register (ENET_IALR)	32	R/W	0000_0000h	57.5.15/2029
120	Descriptor Group Upper Address Register (ENET_GAUR)	32	R/W	0000_0000h	57.5.16/2029
124	Descriptor Group Lower Address Register (ENET_GALR)	32	R/W	0000_0000h	57.5.17/2030
144	Transmit FIFO Watermark Register (ENET_TFWR)	32	R/W	0000_0000h	57.5.18/2030
180	Receive Descriptor Ring Start Register (ENET_RDSR)	32	R/W	0000_0000h	57.5.19/2031
184	Transmit Buffer Descriptor Ring Start Register (ENET_TDSCR)	32	R/W	0000_0000h	57.5.20/2032
188	Maximum Receive Buffer Size Register (ENET_MRBR)	32	R/W	0000_0000h	57.5.21/2033

Table continues on the next page...

ENET memory map (continued)

Address offset (hex)	Register name	Width (in bits)	Access	Reset value	Section/page
190	Receive FIFO Section Full Threshold (ENET_RSFL)	32	R/W	0000_0000h	57.5.22/2034
194	Receive FIFO Section Empty Threshold (ENET_RSEM)	32	R/W	0000_0000h	57.5.23/2034
198	Receive FIFO Almost Empty Threshold (ENET_RAEM)	32	R/W	0000_0004h	57.5.24/2035
19C	Receive FIFO Almost Full Threshold (ENET_RAFL)	32	R/W	0000_0004h	57.5.25/2035
1A0	Transmit FIFO Section Empty Threshold (ENET_TSEM)	32	R/W	0000_0000h	57.5.26/2036
1A4	Transmit FIFO Almost Empty Threshold (ENET_TAEM)	32	R/W	0000_0004h	57.5.27/2036
1A8	Transmit FIFO Almost Full Threshold (ENET_TAFL)	32	R/W	0000_0008h	57.5.28/2037
1AC	Transmit Inter-Packet Gap (ENET_TIPG)	32	R/W	0000_000Ch	57.5.29/2037
1B0	Frame Truncation Length (ENET_FTRL)	32	R/W	0000_07FFh	57.5.30/2038
1C0	Transmit Accelerator Function Configuration (ENET_TACC)	32	R/W	0000_0000h	57.5.31/2038
1C4	Receive Accelerator Function Configuration (ENET_RACC)	32	R/W	0000_0000h	57.5.32/2039
200	Reserved Statistic Register (ENET_RMON_T_DROP)	32	R	0000_0000h	57.5.33/2040
204	Tx Packet Count Statistic Register (ENET_RMON_T_PACKETS)	32	R	0000_0000h	57.5.34/2041
208	Tx Broadcast Packets Statistic Register (ENET_RMON_T_BC_PKT)	32	R	0000_0000h	57.5.35/2041
20C	Tx Multicast Packets Statistic Register (ENET_RMON_T_MC_PKT)	32	R	0000_0000h	57.5.36/2042
210	Tx Packets with CRC/Align Error Statistic Register (ENET_RMON_T_CRC_ALIGN)	32	R	0000_0000h	57.5.37/2042
214	Tx Packets Less Than Bytes and Good CRC Statistic Register (ENET_RMON_T_UNDERSIZE)	32	R	0000_0000h	57.5.38/2042
218	Tx Packets GT MAX_FL bytes and Good CRC Statistic Register (ENET_RMON_T_OVERSIZE)	32	R	0000_0000h	57.5.39/2043
21C	Tx Packets Less Than 64 Bytes and Bad CRC Statistic Register (ENET_RMON_T_FRAG)	32	R	0000_0000h	57.5.40/2043
220	Tx Packets Greater Than MAX_FL bytes and Bad CRC Statistic Register (ENET_RMON_T_JAB)	32	R	0000_0000h	57.5.41/2044
224	Tx Collision Count Statistic Register (ENET_RMON_T_COL)	32	R	0000_0000h	57.5.42/2044
228	Tx 64-Byte Packets Statistic Register (ENET_RMON_T_P64)	32	R	0000_0000h	57.5.43/2044

Table continues on the next page...

ENET memory map (continued)

Address offset (hex)	Register name	Width (in bits)	Access	Reset value	Section/page
22C	Tx 65- to 127-byte Packets Statistic Register (ENET_RMON_T_P65TO127)	32	R	0000_0000h	57.5.44/ 2045
230	Tx 128- to 255-byte Packets Statistic Register (ENET_RMON_T_P128TO255)	32	R	0000_0000h	57.5.45/ 2045
234	Tx 256- to 511-byte Packets Statistic Register (ENET_RMON_T_P256TO511)	32	R	0000_0000h	57.5.46/ 2046
238	Tx 512- to 1023-byte Packets Statistic Register (ENET_RMON_T_P512TO1023)	32	R	0000_0000h	57.5.47/ 2046
23C	Tx 1024- to 2047-byte Packets Statistic Register (ENET_RMON_T_P1024TO2047)	32	R	0000_0000h	57.5.48/ 2047
240	Tx Packets Greater Than 2048 Bytes Statistic Register (ENET_RMON_T_P_GTE2048)	32	R	0000_0000h	57.5.49/ 2047
244	Tx Octets Statistic Register (ENET_RMON_T_OCTETS)	32	R	0000_0000h	57.5.50/ 2047
248	Reserved Statistic Register (ENET_IEEE_T_DROP)	32	R	0000_0000h	57.5.51/ 2048
24C	Frames Transmitted OK Statistic Register (ENET_IEEE_T_FRAME_OK)	32	R	0000_0000h	57.5.52/ 2048
250	Frames Transmitted with Single Collision Statistic Register (ENET_IEEE_T_1COL)	32	R	0000_0000h	57.5.53/ 2049
254	Frames Transmitted with Multiple Collisions Statistic Register (ENET_IEEE_T_MCOL)	32	R	0000_0000h	57.5.54/ 2049
258	Frames Transmitted after Deferral Delay Statistic Register (ENET_IEEE_T_DEF)	32	R	0000_0000h	57.5.55/ 2049
25C	Frames Transmitted with Late Collision Statistic Register (ENET_IEEE_T_LCOL)	32	R	0000_0000h	57.5.56/ 2050
260	Frames Transmitted with Excessive Collisions Statistic Register (ENET_IEEE_T_EXCOL)	32	R	0000_0000h	57.5.57/ 2050
264	Frames Transmitted with Tx FIFO Underrun Statistic Register (ENET_IEEE_T_MACERR)	32	R	0000_0000h	57.5.58/ 2051
268	Frames Transmitted with Carrier Sense Error Statistic Register (ENET_IEEE_T_CSERR)	32	R	0000_0000h	57.5.59/ 2051
26C	Reserved Statistic Register (ENET_IEEE_T_SQE)	32	R (reads 0)	0000_0000h	57.5.60/ 2051
270	Flow Control Pause Frames Transmitted Statistic Register (ENET_IEEE_T_FDXFC)	32	R	0000_0000h	57.5.61/ 2052
274	Octet Count for Frames Transmitted w/o Error Statistic Register (ENET_IEEE_T_OCTETS_OK)	32	R	0000_0000h	57.5.62/ 2052
284	Rx Packet Count Statistic Register (ENET_RMON_R_PACKETS)	32	R	0000_0000h	57.5.63/ 2053
288	Rx Broadcast Packets Statistic Register (ENET_RMON_R_BC_PKT)	32	R	0000_0000h	57.5.64/ 2053
28C	Rx Multicast Packets Statistic Register (ENET_RMON_R_MC_PKT)	32	R	0000_0000h	57.5.65/ 2053

Table continues on the next page...

ENET memory map (continued)

Address offset (hex)	Register name	Width (in bits)	Access	Reset value	Section/page
290	Rx Packets with CRC/Align Error Statistic Register (ENET_RMON_R_CRC_ALIGN)	32	R	0000_0000h	57.5.66/ 2054
294	Rx Packets with Less Than 64 Bytes and Good CRC Statistic Register (ENET_RMON_R_UNDERSIZE)	32	R	0000_0000h	57.5.67/ 2054
298	Rx Packets Greater Than MAX_FL and Good CRC Statistic Register (ENET_RMON_R_OVERSIZE)	32	R	0000_0000h	57.5.68/ 2055
29C	Rx Packets Less Than 64 Bytes and Bad CRC Statistic Register (ENET_RMON_R_FRAG)	32	R	0000_0000h	57.5.69/ 2055
2A0	Rx Packets Greater Than MAX_FL Bytes and Bad CRC Statistic Register (ENET_RMON_R_JAB)	32	R	0000_0000h	57.5.70/ 2055
2A4	Reserved Statistic Register (ENET_RMON_R_RESVD_0)	32	R (reads 0)	0000_0000h	57.5.71/ 2056
2A8	Rx 64-Byte Packets Statistic Register (ENET_RMON_R_P64)	32	R	0000_0000h	57.5.72/ 2056
2AC	Rx 65- to 127-Byte Packets Statistic Register (ENET_RMON_R_P65TO127)	32	R	0000_0000h	57.5.73/ 2057
2B0	Rx 128- to 255-Byte Packets Statistic Register (ENET_RMON_R_P128TO255)	32	R	0000_0000h	57.5.74/ 2057
2B4	Rx 256- to 511-Byte Packets Statistic Register (ENET_RMON_R_P256TO511)	32	R	0000_0000h	57.5.75/ 2057
2B8	Rx 512- to 1023-Byte Packets Statistic Register (ENET_RMON_R_P512TO1023)	32	R	0000_0000h	57.5.76/ 2058
2BC	Rx 1024- to 2047-Byte Packets Statistic Register (ENET_RMON_R_P1024TO2047)	32	R	0000_0000h	57.5.77/ 2058
2C0	Rx Packets Greater than 2048 Bytes Statistic Register (ENET_RMON_R_P_GTE2048)	32	R	0000_0000h	57.5.78/ 2059
2C4	Rx Octets Statistic Register (ENET_RMON_R_OCTETS)	32	R	0000_0000h	57.5.79/ 2059
2C8	Frames not Counted Correctly Statistic Register (ENET_IEEE_R_DROP)	32	R	0000_0000h	57.5.80/ 2059
2CC	Frames Received OK Statistic Register (ENET_IEEE_R_FRAME_OK)	32	R	0000_0000h	57.5.81/ 2060
2D0	Frames Received with CRC Error Statistic Register (ENET_IEEE_R_CRC)	32	R	0000_0000h	57.5.82/ 2060
2D4	Frames Received with Alignment Error Statistic Register (ENET_IEEE_R_ALIGN)	32	R	0000_0000h	57.5.83/ 2061
2D8	Receive FIFO Overflow Count Statistic Register (ENET_IEEE_R_MACERR)	32	R	0000_0000h	57.5.84/ 2061
2DC	Flow Control Pause Frames Received Statistic Register (ENET_IEEE_R_FDXFC)	32	R	0000_0000h	57.5.85/ 2061
2E0	Octet Count for Frames Received without Error Statistic Register (ENET_IEEE_R_OCTETS_OK)	32	R	0000_0000h	57.5.86/ 2062
400	Adjustable Timer Control Register (ENET_ATCR)	32	R/W	0000_0000h	57.5.87/ 2062

Table continues on the next page...

ENET memory map (continued)

Address offset (hex)	Register name	Width (in bits)	Access	Reset value	Section/page
404	Timer Value Register (ENET_ATVR)	32	R/W	0000_0000h	57.5.88/2064
408	Timer Offset Register (ENET_ATOFF)	32	R/W	0000_0000h	57.5.89/2065
40C	Timer Period Register (ENET_ATPER)	32	R/W	3B9A_CA00h	57.5.90/2065
410	Timer Correction Register (ENET_ATCOR)	32	R/W	0000_0000h	57.5.91/2066
414	Time-Stamping Clock Period Register (ENET_ATINC)	32	R/W	0000_0000h	57.5.92/2066
418	Timestamp of Last Transmitted Frame (ENET_ATSTMP)	32	R	0000_0000h	57.5.93/2067
604	Timer Global Status Register (ENET_TGSR)	32	R/W	0000_0000h	57.5.94/2067
608	Timer Control Status Register (ENET_TCSR0)	32	R/W	0000_0000h	57.5.95/2068
60C	Timer Compare Capture Register (ENET_TCCR0)	32	R/W	0000_0000h	57.5.96/2069
610	Timer Control Status Register (ENET_TCSR1)	32	R/W	0000_0000h	57.5.95/2068
614	Timer Compare Capture Register (ENET_TCCR1)	32	R/W	0000_0000h	57.5.96/2069
618	Timer Control Status Register (ENET_TCSR2)	32	R/W	0000_0000h	57.5.95/2068
61C	Timer Compare Capture Register (ENET_TCCR2)	32	R/W	0000_0000h	57.5.96/2069
620	Timer Control Status Register (ENET_TCSR3)	32	R/W	0000_0000h	57.5.95/2068
624	Timer Compare Capture Register (ENET_TCCR3)	32	R/W	0000_0000h	57.5.96/2069

57.5.1 Interrupt Event Register (ENET_EIR)

When an event occurs that sets a bit in EIR, an interrupt occurs if the corresponding bit in the interrupt mask register (EIMR) is also set. Writing a 1 to an EIR bit clears it; writing 0 has no effect. This register is cleared upon hardware reset.

NOTE

TxB[INT] and RxBD[INT] must be set to 1 to allow setting the corresponding EIR register flags in enhanced mode, ENET_ECR[EN1588] = 1. Legacy mode does not require these flags to be enabled.

Address: 0h base + 4h offset = 4h

Bit	31	30	29	28	27	26	25	24	23	22	21	20	19	18	17	16
R	0	BABR	BABT	GRA	TXF	TXB	RXF	RXB	MII	EBERR	LC	RL	UN	PLR	WAKEUP	TS_AVAIL
W		w1c	w1c	w1c	w1c	w1c	w1c	w1c	w1c	w1c	w1c	w1c	w1c	w1c	w1c	w1c
Reset	0	0	0	0	0	0	0	0	0	0	0	0	0	0	0	0
Bit	15	14	13	12	11	10	9	8	7	6	5	4	3	2	1	0
R	TS_TIMER															
W	w1c	0	0	0	0	0	0	0	0	0	0	0	0	0	0	0
Reset	0	0	0	0	0	0	0	0	0	0	0	0	0	0	0	0

ENET_EIR field descriptions

Field	Description
31 Reserved	This field is reserved. This read-only field is reserved and always has the value 0.
30 BABR	Babbling Receive Error Indicates a frame was received with length in excess of RCR[MAX_FL] bytes.
29 BABT	Babbling Transmit Error Indicates the transmitted frame length exceeds RCR[MAX_FL] bytes. Usually this condition is caused when a frame that is too long is placed into the transmit data buffer(s). Truncation does not occur.
28 GRA	Graceful Stop Complete This interrupt is asserted after the transmitter is put into a pause state after completion of the frame currently being transmitted. See Graceful Transmit Stop (GTS) for conditions that lead to graceful stop. NOTE: The GRA interrupt is asserted only when the TX transitions into the stopped state. If this bit is cleared by writing 1 and the TX is still stopped, the bit is not set again.
27 TXF	Transmit Frame Interrupt Indicates a frame has been transmitted and the last corresponding buffer descriptor has been updated.
26 TXB	Transmit Buffer Interrupt Indicates a transmit buffer descriptor has been updated.
25 RXF	Receive Frame Interrupt Indicates a frame has been received and the last corresponding buffer descriptor has been updated.

Table continues on the next page...

ENET_EIR field descriptions (continued)

Field	Description
24 RXB	Receive Buffer Interrupt Indicates a receive buffer descriptor is not the last in the frame has been updated.
23 MII	MII Interrupt. Indicates that the MII has completed the data transfer requested.
22 EBERR	Ethernet Bus Error Indicates a system bus error occurred when a uDMA transaction is underway. When this bit is set, ECR[ETHEREN] is cleared, halting frame processing by the MAC. When this occurs, software must ensure proper actions, possibly resetting the system, to resume normal operation.
21 LC	Late Collision Indicates a collision occurred beyond the collision window (slot time) in half-duplex mode. The frame truncates with a bad CRC and the remainder of the frame is discarded.
20 RL	Collision Retry Limit Indicates a collision occurred on each of 16 successive attempts to transmit the frame. The frame is discarded without being transmitted and transmission of the next frame commences. This error can only occur in half-duplex mode.
19 UN	Transmit FIFO Underrun Indicates the transmit FIFO became empty before the complete frame was transmitted. NOTE: In situations where the device has various masters generating high traffic, a FIFO underrun can occur on the transmit FIFO. To avoid transmit FIFO underrun, store and forward can be enabled in ENET_TFWR[STRFWD]. See STRFWD . Also, a higher priority can be set for ENET traffic using available means on the central bus fabric connecting the ENET module.
18 PLR	Payload Receive Error Indicates a frame was received with a payload length error. See Frame Length/Type Verification: Payload Length Check for more information.
17 WAKEUP	Node Wakeup Request Indication Read-only status bit to indicate that a magic packet has been detected. Will act only if ECR[MAGICEN] is set.
16 TS_AVAIL	Transmit Timestamp Available Indicates that the timestamp of the last transmitted timing frame is available in the ATSTMP register.
15 TS_TIMER	Timestamp Timer The adjustable timer reached the period event. A period event interrupt can be generated if ATCR[PEREN] is set and the timer wraps according to the periodic setting in the ATPER register. Set the timer period value before setting ATCR[PEREN].
14–13 Reserved	This field is reserved. This write-only field is reserved. It must always be written with the value 0.
12 Reserved	This field is reserved. This write-only field is reserved. It must always be written with the value 0.
11–9 Reserved	This field is reserved. This write-only field is reserved. It must always be written with the value 0.

Table continues on the next page...

ENET_EIR field descriptions (continued)

Field	Description
8 Reserved	This field is reserved. This write-only field is reserved. It must always be written with the value 0.
Reserved	This field is reserved. This write-only field is reserved. It must always be written with the value 0.

57.5.2 Interrupt Mask Register (ENET_EIMR)

EIMR controls which interrupt events are allowed to generate actual interrupts. A hardware reset clears this register. If the corresponding bits in the EIR and EIMR registers are set, an interrupt is generated. The interrupt signal remains asserted until a 1 is written to the EIR field (write 1 to clear) or a 0 is written to the EIMR field.

Address: 0h base + 8h offset = 8h

Bit	31	30	29	28	27	26	25	24	23	22	21	20	19	18	17	16
R																
W	0	BABR	BABT	GRA	TXF	TXB	RXF	RXB	MII	EBERR	LC	RL	UN	PLR	WAKEUP	TS_AVAIL
Reset	0	0	0	0	0	0	0	0	0	0	0	0	0	0	0	0
Bit	15	14	13	12	11	10	9	8	7	6	5	4	3	2	1	0
R																
W	TS_TIMER	0	0	0	0	0	0	0	0	0	0	0	0	0	0	0
Reset	0	0	0	0	0	0	0	0	0	0	0	0	0	0	0	0

ENET_EIMR field descriptions

Field	Description
31 Reserved	This field is reserved. This write-only field is reserved. It must always be written with the value 0.
30 BABR	BABR Interrupt Mask Corresponds to interrupt source EIR[BABR] and determines whether an interrupt condition can generate an interrupt. At every module clock, the EIR samples the signal generated by the interrupting source. The corresponding EIR BABR field reflects the state of the interrupt signal even if the corresponding EIMR field is cleared. 0 The corresponding interrupt source is masked. 1 The corresponding interrupt source is not masked.
29 BABT	BABT Interrupt Mask

Table continues on the next page...

ENET_EIMR field descriptions (continued)

Field	Description
	<p>Corresponds to interrupt source EIR[BABT] and determines whether an interrupt condition can generate an interrupt. At every module clock, the EIR samples the signal generated by the interrupting source. The corresponding EIR BABT field reflects the state of the interrupt signal even if the corresponding EIMR field is cleared.</p> <p>0 The corresponding interrupt source is masked. 1 The corresponding interrupt source is not masked.</p>
28 GRA	<p>GRA Interrupt Mask</p> <p>Corresponds to interrupt source EIR[GRA] and determines whether an interrupt condition can generate an interrupt. At every module clock, the EIR samples the signal generated by the interrupting source. The corresponding EIR GRA field reflects the state of the interrupt signal even if the corresponding EIMR field is cleared.</p> <p>0 The corresponding interrupt source is masked. 1 The corresponding interrupt source is not masked.</p>
27 TXF	<p>TXF Interrupt Mask</p> <p>Corresponds to interrupt source EIR[TXF] and determines whether an interrupt condition can generate an interrupt. At every module clock, the EIR samples the signal generated by the interrupting source. The corresponding EIR TXF field reflects the state of the interrupt signal even if the corresponding EIMR field is cleared.</p> <p>0 The corresponding interrupt source is masked. 1 The corresponding interrupt source is not masked.</p>
26 TXB	<p>TXB Interrupt Mask</p> <p>Corresponds to interrupt source EIR[TXB] and determines whether an interrupt condition can generate an interrupt. At every module clock, the EIR samples the signal generated by the interrupting source. The corresponding EIR TXF field reflects the state of the interrupt signal even if the corresponding EIMR field is cleared.</p> <p>0 The corresponding interrupt source is masked. 1 The corresponding interrupt source is not masked.</p>
25 RXF	<p>RXF Interrupt Mask</p> <p>Corresponds to interrupt source EIR[RXF] and determines whether an interrupt condition can generate an interrupt. At every module clock, the EIR samples the signal generated by the interrupting source. The corresponding EIR RXF field reflects the state of the interrupt signal even if the corresponding EIMR field is cleared.</p>
24 RXB	<p>RXB Interrupt Mask</p> <p>Corresponds to interrupt source EIR[RXB] and determines whether an interrupt condition can generate an interrupt. At every module clock, the EIR samples the signal generated by the interrupting source. The corresponding EIR RXB field reflects the state of the interrupt signal even if the corresponding EIMR field is cleared.</p>
23 MII	<p>MII Interrupt Mask</p> <p>Corresponds to interrupt source EIR[MII] and determines whether an interrupt condition can generate an interrupt. At every module clock, the EIR samples the signal generated by the interrupting source. The corresponding EIR MII field reflects the state of the interrupt signal even if the corresponding EIMR field is cleared.</p>

Table continues on the next page...

ENET_EIMR field descriptions (continued)

Field	Description
22 EBERR	EBERR Interrupt Mask Corresponds to interrupt source EIR[EBERR] and determines whether an interrupt condition can generate an interrupt. At every module clock, the EIR samples the signal generated by the interrupting source. The corresponding EIR EBERR field reflects the state of the interrupt signal even if the corresponding EIMR field is cleared.
21 LC	LC Interrupt Mask Corresponds to interrupt source EIR[LC] and determines whether an interrupt condition can generate an interrupt. At every module clock, the EIR samples the signal generated by the interrupting source. The corresponding EIR LC field reflects the state of the interrupt signal even if the corresponding EIMR field is cleared.
20 RL	RL Interrupt Mask Corresponds to interrupt source EIR[RL] and determines whether an interrupt condition can generate an interrupt. At every module clock, the EIR samples the signal generated by the interrupting source. The corresponding EIR RL field reflects the state of the interrupt signal even if the corresponding EIMR field is cleared.
19 UN	UN Interrupt Mask Corresponds to interrupt source EIR[UN] and determines whether an interrupt condition can generate an interrupt. At every module clock, the EIR samples the signal generated by the interrupting source. The corresponding EIR UN field reflects the state of the interrupt signal even if the corresponding EIMR field is cleared.
18 PLR	PLR Interrupt Mask Corresponds to interrupt source EIR[PLR] and determines whether an interrupt condition can generate an interrupt. At every module clock, the EIR samples the signal generated by the interrupting source. The corresponding EIR PLR field reflects the state of the interrupt signal even if the corresponding EIMR field is cleared.
17 WAKEUP	WAKEUP Interrupt Mask Corresponds to interrupt source EIR[WAKEUP] register and determines whether an interrupt condition can generate an interrupt. At every module clock, the EIR samples the signal generated by the interrupting source. The corresponding EIR WAKEUP field reflects the state of the interrupt signal even if the corresponding EIMR field is cleared.
16 TS_AVAIL	TS_AVAIL Interrupt Mask Corresponds to interrupt source EIR[TS_AVAIL] register and determines whether an interrupt condition can generate an interrupt. At every module clock, the EIR samples the signal generated by the interrupting source. The corresponding EIR TS_AVAIL field reflects the state of the interrupt signal even if the corresponding EIMR field is cleared.
15 TS_TIMER	TS_TIMER Interrupt Mask Corresponds to interrupt source EIR[TS_TIMER] register and determines whether an interrupt condition can generate an interrupt. At every module clock, the EIR samples the signal generated by the interrupting source. The corresponding EIR TS_TIMER field reflects the state of the interrupt signal even if the corresponding EIMR field is cleared.
14–13 Reserved	This field is reserved. This write-only field is reserved. It must always be written with the value 0.
12 Reserved	This field is reserved. This write-only field is reserved. It must always be written with the value 0.

Table continues on the next page...

ENET_EIMR field descriptions (continued)

Field	Description
11–9 Reserved	This field is reserved. This write-only field is reserved. It must always be written with the value 0.
8 Reserved	This field is reserved. This write-only field is reserved. It must always be written with the value 0.
Reserved	This field is reserved. This write-only field is reserved. It must always be written with the value 0.

57.5.3 Receive Descriptor Active Register (ENET_RDAR)

RDAR is a command register, written by the user, to indicate that the receive descriptor ring has been updated, that is, that the driver produced empty receive buffers with the empty bit set.

Address: 0h base + 10h offset = 10h

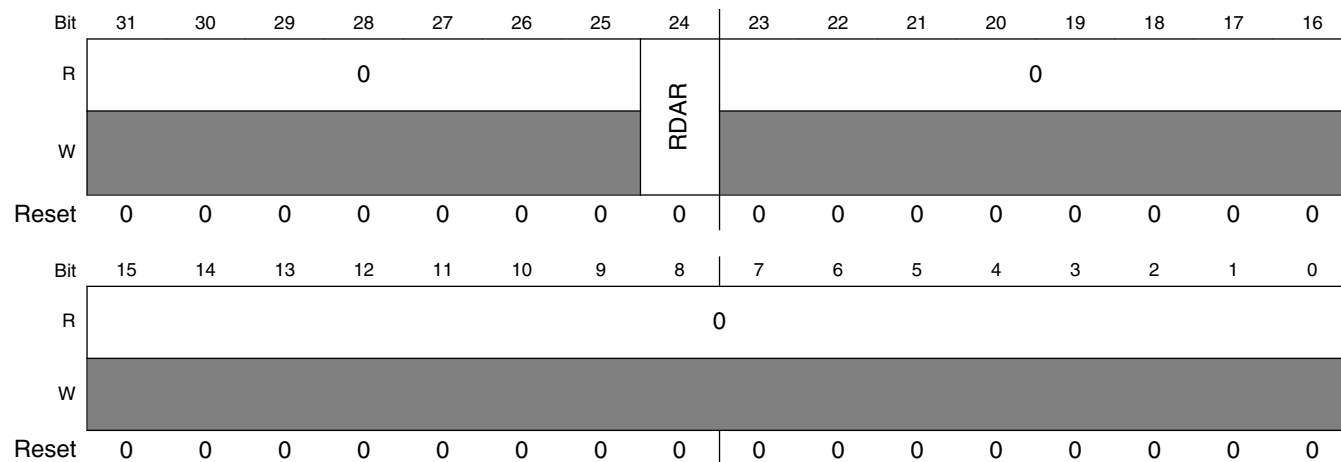

ENET_RDAR field descriptions

Field	Description
31–25 Reserved	This field is reserved. This read-only field is reserved and always has the value 0.
24 RDAR	Receive Descriptor Active Always set to 1 when this register is written, regardless of the value written. This field is cleared by the MAC device when no additional empty descriptors remain in the receive ring. It is also cleared when ECR[ETHEREN] transitions from set to cleared or when ECR[RESET] is set.
Reserved	This field is reserved. This read-only field is reserved and always has the value 0.

57.5.4 Transmit Descriptor Active Register (ENET_TDAR)

The TDAR is a command register that the user writes to indicate that the transmit descriptor ring has been updated, that is, that transmit buffers have been produced by the driver with the ready bit set in the buffer descriptor.

The TDAR register is cleared at reset, when ECR[ETHEREN] transitions from set to cleared, or when ECR[RESET] is set.

Address: 0h base + 14h offset = 14h

Bit	31	30	29	28	27	26	25	24	23	22	21	20	19	18	17	16
R	0							TDAR	0							
W																
Reset	0	0	0	0	0	0	0	0	0	0	0	0	0	0	0	0
Bit	15	14	13	12	11	10	9	8	7	6	5	4	3	2	1	0
R	0															
W																
Reset	0	0	0	0	0	0	0	0	0	0	0	0	0	0	0	0

ENET_TDAR field descriptions

Field	Description
31–25 Reserved	This field is reserved. This read-only field is reserved and always has the value 0.
24 TDAR	Transmit Descriptor Active Always set to 1 when this register is written, regardless of the value written. This bit is cleared by the MAC device when no additional ready descriptors remain in the transmit ring. Also cleared when ECR[ETHEREN] transitions from set to cleared or when ECR[RESET] is set.
Reserved	This field is reserved. This read-only field is reserved and always has the value 0.

57.5.5 Ethernet Control Register (ENET_ECR)

ECR is a read/write user register, though hardware may also alter fields in this register. It controls many of the high level features of the Ethernet MAC, including legacy FEC support through the EN1588 field.

Address: 0h base + 24h offset = 24h

Bit	31	30	29	28	27	26	25	24	23	22	21	20	19	18	17	16
R	Reserved														Reserved	
W	Reserved														Reserved	
Reset	1	1	1	1	0	0	0	0	0	0	0	0	0	0	0	0
Bit	15	14	13	12	11	10	9	8	7	6	5	4	3	2	1	0
R	Reserved				Reserved	Reserved	Reserved	DBSWP	Reserved	DBGEN		EN1588	SLEEP	MAGICEN	ETHEREN	RESET
W	Reserved				Reserved	Reserved	Reserved	DBSWP	Reserved	DBGEN	0	EN1588	SLEEP	MAGICEN	ETHEREN	RESET
Reset	0	0	0	0	0	0	0	0	0	0	0	0	0	0	0	0

ENET_ECR field descriptions

Field	Description
31–18 Reserved	This field is reserved. Always write 1111000000000b to this field.
17–12 Reserved	This field is reserved. Always write 0 to this field.
11 Reserved	This field is reserved. Always write 0 to this field.
10 Reserved	This field is reserved. Always write 0 to this field.
9 Reserved	This field is reserved. Always write 0 to this field.
8 DBSWP	Descriptor Byte Swapping Enable Swaps the byte locations of the buffer descriptors. NOTE: This field must be written to 1 after reset. 0 The buffer descriptor bytes are not swapped to support big-endian devices. 1 The buffer descriptor bytes are swapped to support little-endian devices.
7 Reserved	This field is reserved. Always write 0 to this field.
6 DBGEN	Debug Enable Enables the MAC to enter hardware freeze mode when the device enters debug mode.

Table continues on the next page...

ENET_ECR field descriptions (continued)

Field	Description
	0 MAC continues operation in debug mode. 1 MAC enters hardware freeze mode when the processor is in debug mode.
5 Reserved	This field is reserved. This write-only field is reserved. It must always be written with the value 0.
4 EN1588	EN1588 Enable Enables enhanced functionality of the MAC. 0 Legacy FEC buffer descriptors and functions enabled. 1 Enhanced frame time-stamping functions enabled.
3 SLEEP	Sleep Mode Enable 0 Normal operating mode. 1 Sleep mode.
2 MAGICEN	Magic Packet Detection Enable Enables/disables magic packet detection. NOTE: MAGICEN is relevant only if the SLEEP field is set. If MAGICEN is set, changing the SLEEP field enables/disables sleep mode and magic packet detection. NOTE: EIMR[WAKEUP] must be written to one if Magic packet wakeup is programmed to wake up the chip from low power mode. 0 Magic detection logic disabled. 1 The MAC core detects magic packets and asserts EIR[WAKEUP] when a frame is detected.
1 ETHEREN	Ethernet Enable Enables/disables the Ethernet MAC. When the MAC is disabled, the buffer descriptors for an aborted transmit frame are not updated. The uDMA, buffer descriptor, and FIFO control logic are reset, including the buffer descriptor and FIFO pointers. Hardware clears this field under the following conditions: <ul style="list-style-type: none"> • RESET is set by software • An error condition causes the EBERR field to set. NOTE: <ul style="list-style-type: none"> • ETHEREN must be set at the very last step during ENET configuration/setup/initialization, only <i>after</i> all other ENET-related registers have been configured. • If ETHEREN is cleared to 0 by software then next time ETHEREN is set, the EIR interrupts must be cleared to 0 due to previous pending interrupts. 0 Reception immediately stops and transmission stops after a bad CRC is appended to any currently transmitted frame. 1 MAC is enabled, and reception and transmission are possible.
0 RESET	Ethernet MAC Reset When this field is set, it clears the ETHEREN field.

57.5.6 MII Management Frame Register (ENET_MMFR)

Writing to MMFR triggers a management frame transaction to the PHY device unless MSCR is programmed to zero.

If MSCR is changed from zero to non-zero during a write to MMFR, an MII frame is generated with the data previously written to the MMFR. This allows MMFR and MSCR to be programmed in either order if MSCR is currently zero.

If the MMFR register is written while frame generation is in progress, the frame contents are altered. Software must use the EIR[MII] interrupt indication to avoid writing to the MMFR register while frame generation is in progress.

Address: 0h base + 40h offset = 40h

Bit	31	30	29	28	27	26	25	24	23	22	21	20	19	18	17	16	15	14	13	12	11	10	9	8	7	6	5	4	3	2	1	0
R																																
W	ST	OP	PA			RA			TA		DATA																					
Reset	0	0	0	0	0	0	0	0	0	0	0	0	0	0	0	0	0	0	0	0	0	0	0	0	0	0	0	0	0	0	0	0

ENET_MMFR field descriptions

Field	Description
31–30 ST	Start Of Frame Delimiter See Table 57-39 (Clause 22) or Table 57-41 (Clause 45) for correct value.
29–28 OP	Operation Code See Table 57-39 (Clause 22) or Table 57-41 (Clause 45) for correct value.
27–23 PA	PHY Address See Table 57-39 (Clause 22) or Table 57-41 (Clause 45) for correct value.
22–18 RA	Register Address See Table 57-39 (Clause 22) or Table 57-41 (Clause 45) for correct value.
17–16 TA	Turn Around This field must be programmed to 10 to generate a valid MII management frame.
DATA	Management Frame Data This is the field for data to be written to or read from the PHY register.

57.5.7 MII Speed Control Register (ENET_MSCR)

MSCR provides control of the MII clock (MDC pin) frequency and allows a preamble drop on the MII management frame.

The MII_SPEED field must be programmed with a value to provide an MDC frequency of less than or equal to 2.5 MHz to be compliant with the IEEE 802.3 MII specification. The MII_SPEED must be set to a non-zero value to source a read or write management frame. After the management frame is complete, the MSCR register may optionally be cleared to turn off MDC. The MDC signal generated has a 50% duty cycle except when MII_SPEED changes during operation. This change takes effect following a rising or falling edge of MDC.

For example, if the internal module clock (that is, peripheral bus clock) is 25 MHz, programming MII_SPEED to 0x4 results in an MDC as given in the following equation:

$$\text{MII clock frequency} = 25 \text{ MHz} / ((4 + 1) \times 2) = 2.5 \text{ MHz}$$

The following table shows the optimum values for MII_SPEED as a function of IPS bus clock frequency.

Table 57-2. Programming Examples for MSCR

Internal module clock frequency	MSCR [MII_SPEED]	MDC frequency
25 MHz	0x4	2.50 MHz
33 MHz	0x6	2.36 MHz
40 MHz	0x7	2.50 MHz
50 MHz	0x9	2.50 MHz
66 MHz	0xD	2.36 MHz

Address: 0h base + 44h offset = 44h

Bit	31	30	29	28	27	26	25	24	23	22	21	20	19	18	17	16
R	0															
W																
Reset	0	0	0	0	0	0	0	0	0	0	0	0	0	0	0	0
Bit	15	14	13	12	11	10	9	8	7	6	5	4	3	2	1	0
R	0					HOLDTIME			DIS_	MII_SPEED					0	
W									PRE							
Reset	0	0	0	0	0	0	0	0	0	0	0	0	0	0	0	0

ENET_MSCR field descriptions

Field	Description
31–11 Reserved	This field is reserved. This read-only field is reserved and always has the value 0.
10–8 HOLDTIME	Hold time On MDIO Output IEEE802.3 clause 22 defines a minimum of 10 ns for the hold time on the MDIO output. Depending on the host bus frequency, the setting may need to be increased. 000 1 internal module clock cycle 001 2 internal module clock cycles

Table continues on the next page...

ENET_MSCR field descriptions (continued)

Field	Description
	010 3 internal module clock cycles 111 8 internal module clock cycles
7 DIS_PRE	Disable Preamble Enables/disables prepending a preamble to the MII management frame. The MII standard allows the preamble to be dropped if the attached PHY devices do not require it. 0 Preamble enabled. 1 Preamble (32 ones) is not prepended to the MII management frame.
6-1 MII_SPEED	MII Speed Controls the frequency of the MII management interface clock (MDC) relative to the internal module clock. A value of 0 in this field turns off MDC and leaves it in low voltage state. Any non-zero value results in the MDC frequency of: $1/((\text{MII_SPEED} + 1) \times 2)$ of the internal module clock frequency
0 Reserved	This field is reserved. This read-only field is reserved and always has the value 0.

57.5.8 MIB Control Register (ENET_MIBC)

MIBC is a read/write register controlling and observing the state of the MIB block. Access this register to disable the MIB block operation or clear the MIB counters. The MIB_DIS field resets to 1.

Address: 0h base + 64h offset = 64h

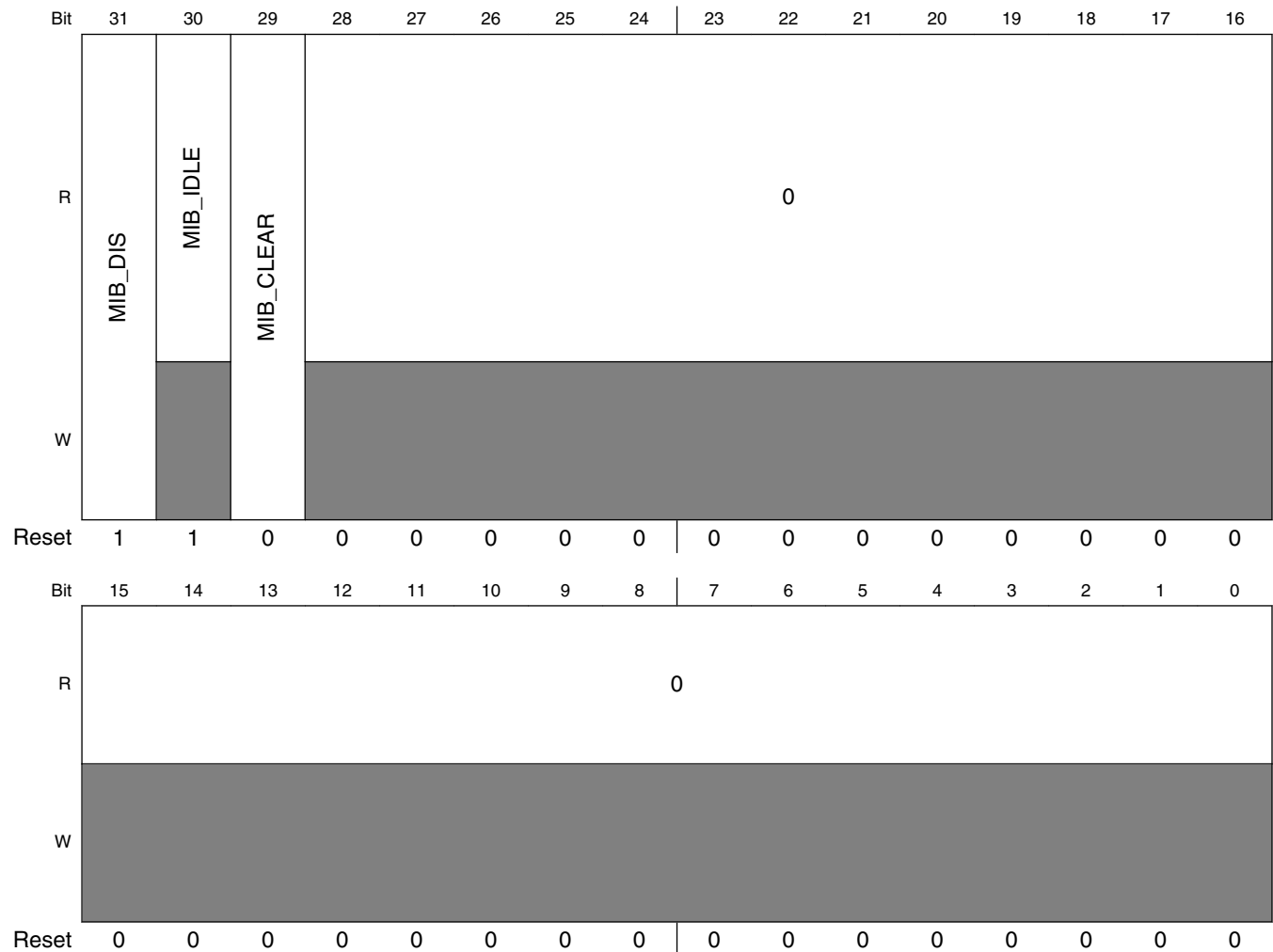

ENET_MIBC field descriptions

Field	Description
31 MIB_DIS	<p>Disable MIB Logic</p> <p>If this control field is set,</p> <p>0 MIB logic is enabled.</p> <p>1 MIB logic is disabled. The MIB logic halts and does not update any MIB counters.</p>

Table continues on the next page...

ENET_MIBC field descriptions (continued)

Field	Description
30 MIB_IDLE	MIB Idle 0 The MIB block is updating MIB counters. 1 The MIB block is not currently updating any MIB counters.
29 MIB_CLEAR	MIB Clear NOTE: This field is not self-clearing. To clear the MIB counters set and then clear this field. 0 See note above. 1 All statistics counters are reset to 0.
Reserved	This field is reserved. This read-only field is reserved and always has the value 0.

57.5.9 Receive Control Register (ENET_RCR)

Address: 0h base + 84h offset = 84h

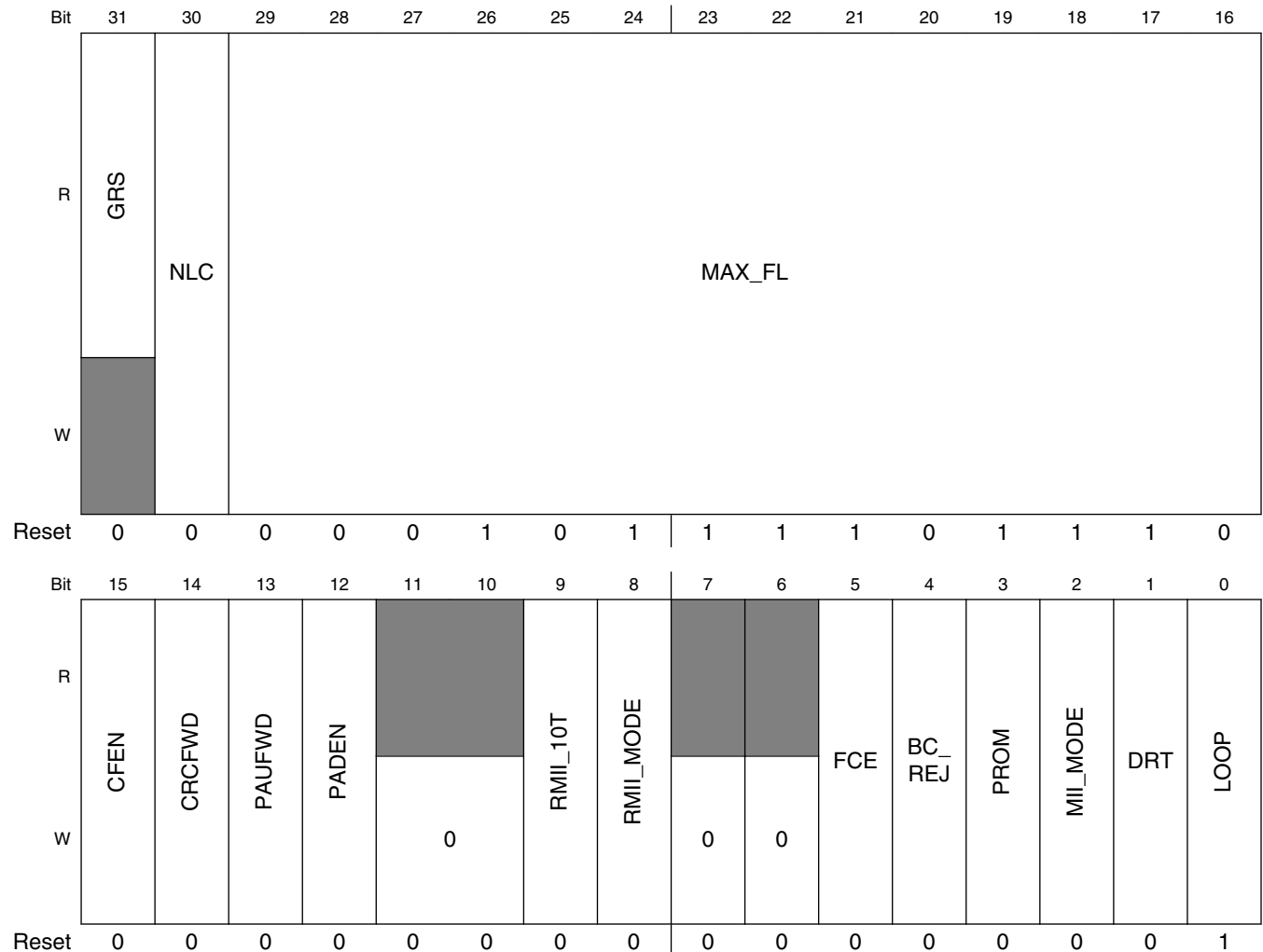

ENET_RCR field descriptions

Field	Description
31 GRS	Graceful Receive Stopped Read-only status indicating that the MAC receive datapath is stopped.
30 NLC	Payload Length Check Disable Enables/disables a payload length check. 0 The payload length check is disabled. 1 The core checks the frame's payload length with the frame length/type field. Errors are indicated in the EIR[PLR] field.
29–16 MAX_FL	Maximum Frame Length Resets to decimal 1518. Length is measured starting at DA and includes the CRC at the end of the frame. Transmit frames longer than MAX_FL cause the BABT interrupt to occur. Receive frames longer than MAX_FL cause the BABR interrupt to occur and set the LG field in the end of frame receive buffer descriptor. The recommended default value to be programmed is 1518 or 1522 if VLAN tags are supported.
15 CFEN	MAC Control Frame Enable Enables/disables the MAC control frame. 0 MAC control frames with any opcode other than 0x0001 (pause frame) are accepted and forwarded to the client interface. 1 MAC control frames with any opcode other than 0x0001 (pause frame) are silently discarded.
14 CRCFWD	Terminate/Forward Received CRC Specifies whether the CRC field of received frames is transmitted or stripped. NOTE: If padding function is enabled (PADEN = 1), CRCFWD is ignored and the CRC field is checked and always terminated and removed. 0 The CRC field of received frames is transmitted to the user application. 1 The CRC field is stripped from the frame.
13 PAUFWD	Terminate/Forward Pause Frames Specifies whether pause frames are terminated or forwarded. 0 Pause frames are terminated and discarded in the MAC. 1 Pause frames are forwarded to the user application.
12 PADEN	Enable Frame Padding Remove On Receive Specifies whether the MAC removes padding from received frames. 0 No padding is removed on receive by the MAC. 1 Padding is removed from received frames.
11–10 Reserved	This field is reserved. This write-only field is reserved. It must always be written with the value 0.
9 RMII_10T	Enables 10-Mbit/s mode of the RMII . 0 100-Mbit/s operation. 1 10-Mbit/s operation.

Table continues on the next page...

ENET_RCR field descriptions (continued)

Field	Description
8 RMII_MODE	<p>RMII Mode Enable</p> <p>Specifies whether the MAC is configured for MII mode or RMII operation .</p> <p>0 MAC configured for MII mode. 1 MAC configured for RMII operation.</p>
7 Reserved	<p>This field is reserved.</p> <p>This write-only field is reserved. It must always be written with the value 0.</p>
6 Reserved	<p>This field is reserved.</p> <p>This write-only field is reserved. It must always be written with the value 0.</p>
5 FCE	<p>Flow Control Enable</p> <p>If set, the receiver detects PAUSE frames. Upon PAUSE frame detection, the transmitter stops transmitting data frames for a given duration.</p>
4 BC_REJ	<p>Broadcast Frame Reject</p> <p>If set, frames with destination address (DA) equal to 0xFFFF_FFFF_FFFF are rejected unless the PROM field is set. If BC_REJ and PROM are set, frames with broadcast DA are accepted and the MISS (M) is set in the receive buffer descriptor.</p>
3 PROM	<p>Promiscuous Mode</p> <p>All frames are accepted regardless of address matching.</p> <p>0 Disabled. 1 Enabled.</p>
2 MII_MODE	<p>Media Independent Interface Mode</p> <p>This field must always be set.</p> <p>0 Reserved. 1 MII or RMII mode, as indicated by the RMII_MODE field.</p>
1 DRT	<p>Disable Receive On Transmit</p> <p>0 Receive path operates independently of transmit (i.e., full-duplex mode). Can also be used to monitor transmit activity in half-duplex mode. 1 Disable reception of frames while transmitting. (Normally used for half-duplex mode.)</p>
0 LOOP	<p>Internal Loopback</p> <p>This is an MII internal loopback, therefore MII_MODE must be written to 1 and RMII_MODE must be written to 0.</p> <p>0 Loopback disabled. 1 Transmitted frames are looped back internal to the device and transmit MII output signals are not asserted. DRT must be cleared.</p>

57.5.10 Transmit Control Register (ENET_TCR)

TCR is read/write and configures the transmit block. This register is cleared at system reset. FDEN can only be modified when ECR[ETHEREN] is cleared.

Address: 0h base + C4h offset = C4h

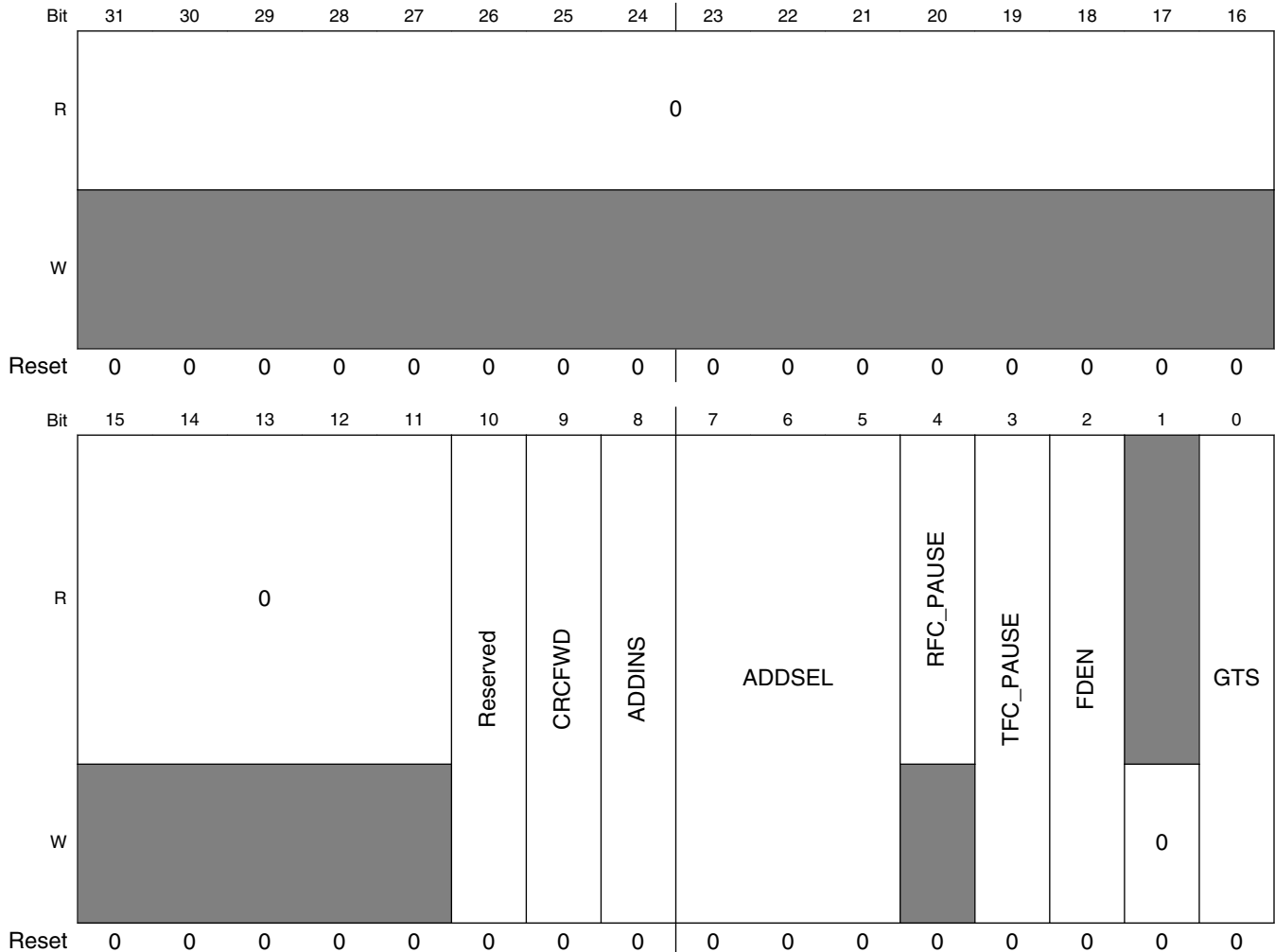

ENET_TCR field descriptions

Field	Description
31-11 Reserved	This field is reserved. This read-only field is reserved and always has the value 0.
10 Reserved	This field is reserved. This field is read/write and must be set to 0.
9 CRCFWD	Forward Frame From Application With CRC

Table continues on the next page...

ENET_TCR field descriptions (continued)

Field	Description
	<p>0 TxBD[TC] controls whether the frame has a CRC from the application.</p> <p>1 The transmitter does not append any CRC to transmitted frames, as it is expecting a frame with CRC from the application.</p>
8 ADDINS	<p>Set MAC Address On Transmit</p> <p>0 The source MAC address is not modified by the MAC.</p> <p>1 The MAC overwrites the source MAC address with the programmed MAC address according to ADDSEL.</p>
7–5 ADDSEL	<p>Source MAC Address Select On Transmit</p> <p>If ADDINS is set, indicates the MAC address that overwrites the source MAC address.</p> <p>000 Node MAC address programmed on PADDR1/2 registers.</p> <p>100 Reserved.</p> <p>101 Reserved.</p> <p>110 Reserved.</p>
4 RFC_PAUSE	<p>Receive Frame Control Pause</p> <p>This status field is set when a full-duplex flow control pause frame is received and the transmitter pauses for the duration defined in this pause frame. This field automatically clears when the pause duration is complete.</p>
3 TFC_PAUSE	<p>Transmit Frame Control Pause</p> <p>Pauses frame transmission. When this field is set, EIR[GRA] is set. With transmission of data frames stopped, the MAC transmits a MAC control PAUSE frame. Next, the MAC clears TFC_PAUSE and resumes transmitting data frames. If the transmitter pauses due to user assertion of GTS or reception of a PAUSE frame, the MAC may continue transmitting a MAC control PAUSE frame.</p> <p>0 No PAUSE frame transmitted.</p> <p>1 The MAC stops transmission of data frames after the current transmission is complete.</p>
2 FDEN	<p>Full-Duplex Enable</p> <p>If this field is set, frames transmit independent of carrier sense and collision inputs. Only modify this bit when ECR[ETHEREN] is cleared.</p>
1 Reserved	<p>This field is reserved.</p> <p>This write-only field is reserved. It must always be written with the value 0.</p>
0 GTS	<p>Graceful Transmit Stop</p> <p>When this field is set, MAC stops transmission after any frame currently transmitted is complete and EIR[GRA] is set. If frame transmission is not currently underway, the GRA interrupt is asserted immediately. After transmission finishes, clear GTS to restart. The next frame in the transmit FIFO is then transmitted. If an early collision occurs during transmission when GTS is set, transmission stops after the collision. The frame is transmitted again after GTS is cleared. There may be old frames in the transmit FIFO that transmit when GTS is reasserted. To avoid this, clear ECR[ETHEREN] following the GRA interrupt.</p>

57.5.11 Physical Address Lower Register (ENET_PALR)

PALR contains the lower 32 bits (bytes 0, 1, 2, 3) of the 48-bit address used in the address recognition process to compare with the destination address (DA) field of receive frames with an individual DA. In addition, this register is used in bytes 0 through 3 of the six-byte source address field when transmitting PAUSE frames.

Address: 0h base + E4h offset = E4h

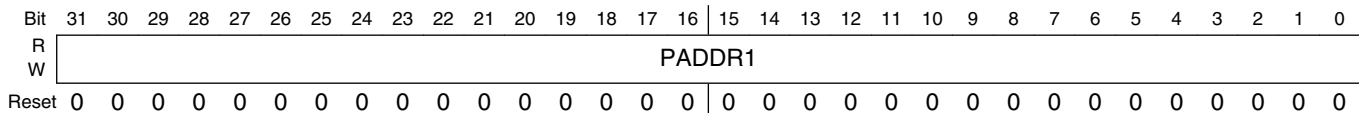

ENET_PALR field descriptions

Field	Description
PADDR1	Pause Address Bytes 0 (bits 31:24), 1 (bits 23:16), 2 (bits 15:8), and 3 (bits 7:0) of the 6-byte individual address are used for exact match and the source address field in PAUSE frames.

57.5.12 Physical Address Upper Register (ENET_PAUR)

PAUR contains the upper 16 bits (bytes 4 and 5) of the 48-bit address used in the address recognition process to compare with the destination address (DA) field of receive frames with an individual DA. In addition, this register is used in bytes 4 and 5 of the six-byte source address field when transmitting PAUSE frames. Bits 15:0 of PAUR contain a constant type field (0x8808) for transmission of PAUSE frames.

Address: 0h base + E8h offset = E8h

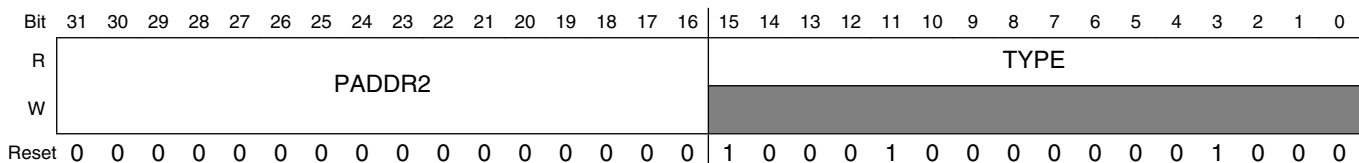

ENET_PAUR field descriptions

Field	Description
31–16 PADDR2	Bytes 4 (bits 31:24) and 5 (bits 23:16) of the 6-byte individual address used for exact match, and the source address field in PAUSE frames.
TYPE	Type Field In PAUSE Frames These fields have a constant value of 0x8808.

57.5.13 Opcode/Pause Duration Register (ENET_OPD)

OPD is read/write accessible. This register contains the 16-bit opcode and 16-bit pause duration fields used in transmission of a PAUSE frame. The opcode field is a constant value, 0x0001. When another node detects a PAUSE frame, that node pauses transmission for the duration specified in the pause duration field. The lower 16 bits of this register are not reset and you must initialize it.

Address: 0h base + ECh offset = ECh

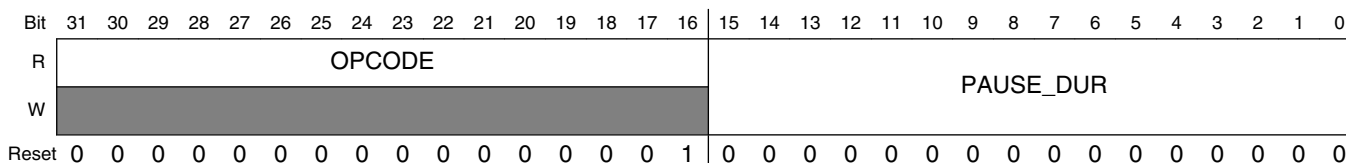

ENET_OPD field descriptions

Field	Description
31–16 OPCODE	Opcode Field In PAUSE Frames These fields have a constant value of 0x0001.
PAUSE_DUR	Pause Duration Pause duration field used in PAUSE frames.

57.5.14 Descriptor Individual Upper Address Register (ENET_IAUR)

IAUR contains the upper 32 bits of the 64-bit individual address hash table. The address recognition process uses this table to check for a possible match with the destination address (DA) field of receive frames with an individual DA. This register is not reset and you must initialize it.

Address: 0h base + 118h offset = 118h

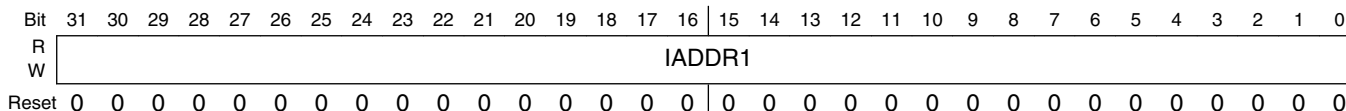

ENET_IAUR field descriptions

Field	Description
IADDR1	Contains the upper 32 bits of the 64-bit hash table used in the address recognition process for receive frames with a unicast address. Bit 31 of IADDR1 contains hash index bit 63. Bit 0 of IADDR1 contains hash index bit 32.

57.5.15 Descriptor Individual Lower Address Register (ENET_IALR)

IALR contains the lower 32 bits of the 64-bit individual address hash table. The address recognition process uses this table to check for a possible match with the DA field of receive frames with an individual DA. This register is not reset and you must initialize it.

Address: 0h base + 11Ch offset = 11Ch

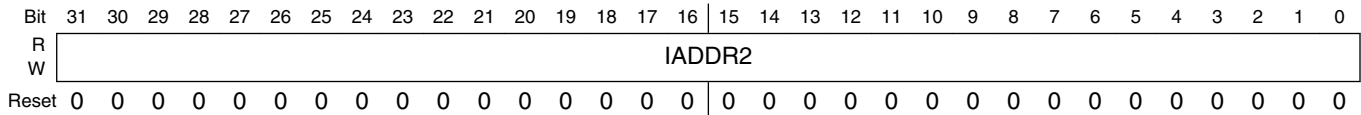

ENET_IALR field descriptions

Field	Description
IADDR2	Contains the lower 32 bits of the 64-bit hash table used in the address recognition process for receive frames with a unicast address. Bit 31 of IADDR2 contains hash index bit 31. Bit 0 of IADDR2 contains hash index bit 0.

57.5.16 Descriptor Group Upper Address Register (ENET_GAUR)

GAUR contains the upper 32 bits of the 64-bit hash table used in the address recognition process for receive frames with a multicast address. You must initialize this register.

Address: 0h base + 120h offset = 120h

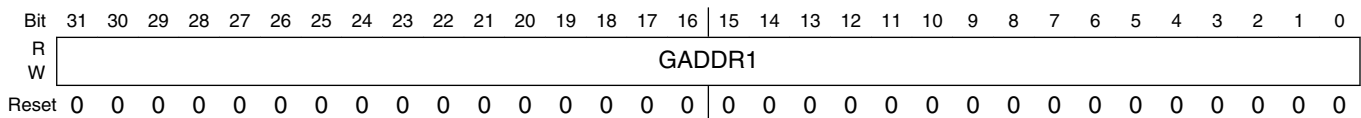

ENET_GAUR field descriptions

Field	Description
GADDR1	Contains the upper 32 bits of the 64-bit hash table used in the address recognition process for receive frames with a multicast address. Bit 31 of GADDR1 contains hash index bit 63. Bit 0 of GADDR1 contains hash index bit 32.

57.5.17 Descriptor Group Lower Address Register (ENET_GALR)

GALR contains the lower 32 bits of the 64-bit hash table used in the address recognition process for receive frames with a multicast address. You must initialize this register.

Address: 0h base + 124h offset = 124h

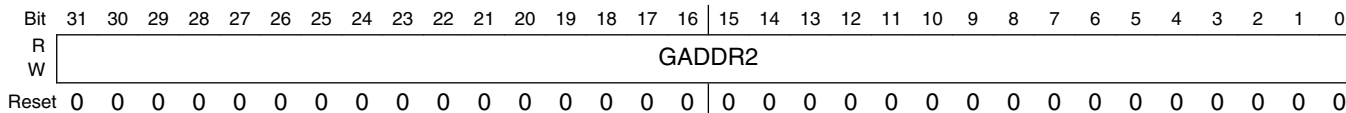

ENET_GALR field descriptions

Field	Description
GADDR2	Contains the lower 32 bits of the 64-bit hash table used in the address recognition process for receive frames with a multicast address. Bit 31 of GADDR2 contains hash index bit 31. Bit 0 of GADDR2 contains hash index bit 0.

57.5.18 Transmit FIFO Watermark Register (ENET_TFWR)

If TFWR[STRFWD] is cleared, TFWR[TFWR] controls the amount of data required in the transmit FIFO before transmission of a frame can begin. This allows you to minimize transmit latency (TFWR = 00 or 01) or allow for larger bus access latency (TFWR = 11) due to contention for the system bus. Setting the watermark to a high value minimizes the risk of transmit FIFO underrun due to contention for the system bus. The byte counts associated with the TFWR field may need to be modified to match a given system requirement, for example, worst-case bus access latency by the transmit data uDMA channel.

When the FIFO level reaches the value the TFWR field and when the STR_FWD is set to '0', the MAC transmit control logic starts frame transmission even before the end-of-frame is available in the FIFO (cut-through operation).

If a complete frame has a size smaller than the threshold programmed with TFWR, the MAC also transmits the Frame to the line.

To enable store and forward on the Transmit path, set STR_FWD to '1'. In this case, the MAC starts to transmit data only when a complete frame is stored in the Transmit FIFO.

Address: 0h base + 144h offset = 144h

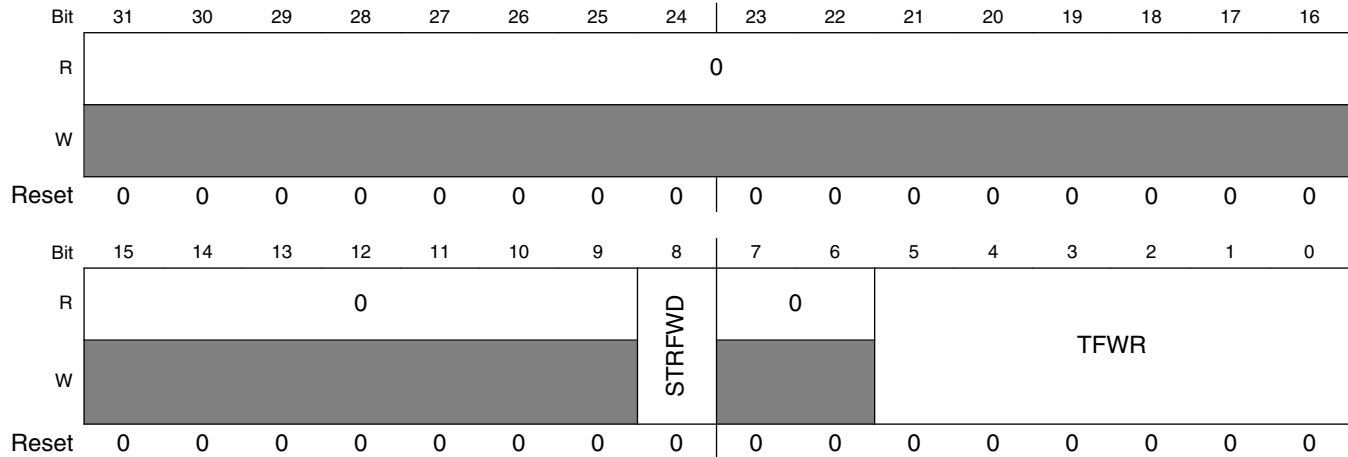

ENET_TFWR field descriptions

Field	Description
31–9 Reserved	This field is reserved. This read-only field is reserved and always has the value 0.
8 STRFWD	Store And Forward Enable 0 Reset. The transmission start threshold is programmed in TFWR[TFWR]. 1 Enabled.
7–6 Reserved	This field is reserved. This read-only field is reserved and always has the value 0.
TFWR	Transmit FIFO Write If TFWR[STRFWD] is cleared, this field indicates the number of bytes, in steps of 64 bytes, written to the transmit FIFO before transmission of a frame begins. NOTE: If a frame with less than the threshold is written, it is still sent independently of this threshold setting. The threshold is relevant only if the frame is larger than the threshold given. 000000 64 bytes written. 000001 64 bytes written. 000010 128 bytes written. 000011 192 bytes written. 011111 1984 bytes written.

57.5.19 Receive Descriptor Ring Start Register (ENET_RDSR)

RDSR points to the beginning of the circular receive buffer descriptor queue in external memory. This pointer must be 64-bit aligned (bits 2–0 must be zero); however, it is recommended to be 128-bit aligned, that is, evenly divisible by 16.

NOTE

This register must be initialized prior to operation

Memory map/register definition

Address: 0h base + 180h offset = 180h

Bit	31	30	29	28	27	26	25	24		23	22	21	20	19	18	17	16
R	R_DES_START																
W																	
Reset	0	0	0	0	0	0	0	0		0	0	0	0	0	0	0	0
Bit	15	14	13	12	11	10	9	8		7	6	5	4	3	2	1	0
R	R_DES_START															0	
W															0		
Reset	0	0	0	0	0	0	0	0		0	0	0	0	0	0	0	0

ENET_RDSR field descriptions

Field	Description
31–3 R_DES_START	Pointer to the beginning of the receive buffer descriptor queue.
2 Reserved	This field is reserved. This write-only field is reserved. It must always be written with the value 0.
Reserved	This field is reserved. This read-only field is reserved and always has the value 0.

57.5.20 Transmit Buffer Descriptor Ring Start Register (ENET_TDSR)

TDSR provides a pointer to the beginning of the circular transmit buffer descriptor queue in external memory. This pointer must be 64-bit aligned (bits 2–0 must be zero); however, it is recommended to be 128-bit aligned, that is, evenly divisible by 16.

NOTE

This register must be initialized prior to operation.

Address: 0h base + 184h offset = 184h

Bit	31	30	29	28	27	26	25	24		23	22	21	20	19	18	17	16
R	X_DES_START																
W																	
Reset	0	0	0	0	0	0	0	0		0	0	0	0	0	0	0	0
Bit	15	14	13	12	11	10	9	8		7	6	5	4	3	2	1	0
R	X_DES_START															0	
W															0		
Reset	0	0	0	0	0	0	0	0		0	0	0	0	0	0	0	0

ENET_TDSR field descriptions

Field	Description
31–3 X_DES_START	Pointer to the beginning of the transmit buffer descriptor queue.

Table continues on the next page...

ENET_TDSR field descriptions (continued)

Field	Description
2 Reserved	This field is reserved. This write-only field is reserved. It must always be written with the value 0.
Reserved	This field is reserved. This read-only field is reserved and always has the value 0.

57.5.21 Maximum Receive Buffer Size Register (ENET_MRBR)

The MRBR is a user-programmable register that dictates the maximum size of all receive buffers. This value should take into consideration that the receive CRC is always written into the last receive buffer.

- R_BUF_SIZE is concatenated with the four least-significant bits of this register and are used as the maximum receive buffer size.
- To allow one maximum size frame per buffer, MRBR must be set to RCR[MAX_FL] or larger.
- To properly align the buffer, MRBR must be evenly divisible by 16. To ensure this, the lower four bits are set to zero by the device.
- To minimize bus usage (descriptor fetches), set MRBR greater than or equal to 256 bytes.

NOTE

This register must be initialized before operation.

Address: 0h base + 188h offset = 188h

Bit	31	30	29	28	27	26	25	24	23	22	21	20	19	18	17	16	15	14	13	12	11	10	9	8	7	6	5	4	3	2	1	0
R	0																R_BUF_SIZE										0					
W	0																0										0					
Reset	0	0	0	0	0	0	0	0	0	0	0	0	0	0	0	0	0	0	0	0	0	0	0	0	0	0	0	0	0	0	0	0

ENET_MRBR field descriptions

Field	Description
31–14 Reserved	This field is reserved. This read-only field is reserved and always has the value 0.
13–4 R_BUF_SIZE	Receive buffer size in bytes. This value, concatenated with the four least-significant bits of this register (which are always zero), is the effective maximum receive buffer size.
Reserved	This field, which is always zero, is the four least-significant bits of the maximum receive buffer size. This field is reserved. This read-only field is reserved and always has the value 0.

57.5.22 Receive FIFO Section Full Threshold (ENET_RSFL)

Address: 0h base + 190h offset = 190h

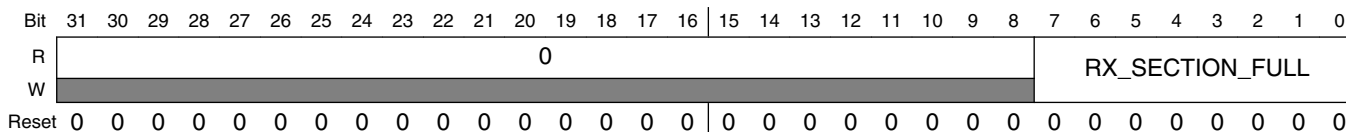

ENET_RSFL field descriptions

Field	Description
31–8 Reserved	This field is reserved. This read-only field is reserved and always has the value 0.
RX_SECTION_FULL	Value Of Receive FIFO Section Full Threshold Value, in 64-bit words, of the receive FIFO section full threshold. Clear this field to enable store and forward on the RX FIFO. When programming a value greater than 0 (cut-through operation), it must be greater than RAEM[RX_ALMOST_EMPTY]. When the FIFO level reaches the value in this field, data is available in the Receive FIFO (cut-through operation).

57.5.23 Receive FIFO Section Empty Threshold (ENET_RSEM)

Address: 0h base + 194h offset = 194h

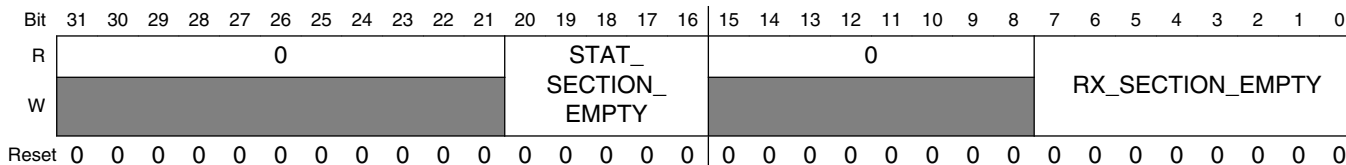

ENET_RSEM field descriptions

Field	Description
31–21 Reserved	This field is reserved. This read-only field is reserved and always has the value 0.
20–16 STAT_SECTION_EMPTY	RX Status FIFO Section Empty Threshold Defines number of frames in the receive FIFO, independent of its size, that can be accepted. If the limit is reached, reception will continue normally, however a pause frame will be triggered to indicate a possible congestion to the remote device to avoid FIFO overflow. A value of 0 disables automatic pause frame generation
15–8 Reserved	This field is reserved. This read-only field is reserved and always has the value 0.
RX_SECTION_EMPTY	Value Of The Receive FIFO Section Empty Threshold Value, in 64-bit words, of the receive FIFO section empty threshold. When the FIFO has reached this level, a pause frame will be issued.

Table continues on the next page...

ENET_RSEM field descriptions (continued)

Field	Description
	<p>A value of 0 disables automatic pause frame generation.</p> <p>When the FIFO level goes below the value programmed in this field, an XON pause frame is issued to indicate the FIFO congestion is cleared to the remote Ethernet client.</p> <p>NOTE: The section-empty threshold indications from both FIFOs are OR'ed to cause XOFF pause frame generation.</p>

57.5.24 Receive FIFO Almost Empty Threshold (ENET_RAEM)

Address: 0h base + 198h offset = 198h

Bit	31	30	29	28	27	26	25	24	23	22	21	20	19	18	17	16	15	14	13	12	11	10	9	8	7	6	5	4	3	2	1	0
R	0																RX_ALMOST_EMPTY															
W																																
Reset	0	0	0	0	0	0	0	0	0	0	0	0	0	0	0	0	0	0	0	0	0	0	0	0	0	0	0	0	0	1	0	0

ENET_RAEM field descriptions

Field	Description
31–8 Reserved	<p>This field is reserved.</p> <p>This read-only field is reserved and always has the value 0.</p>
RX_ALMOST_EMPTY	<p>Value Of The Receive FIFO Almost Empty Threshold</p> <p>Value, in 64-bit words, of the receive FIFO almost empty threshold. When the FIFO level reaches the value programmed in this field and the end-of-frame has not been received for the frame yet, the core receive read control stops FIFO read (and subsequently stops transferring data to the MAC client application). It continues to deliver the frame, if again more data than the threshold or the end-of-frame is available in the FIFO. A minimum value of 4 should be set.</p>

57.5.25 Receive FIFO Almost Full Threshold (ENET_RAFL)

Address: 0h base + 19Ch offset = 19Ch

Bit	31	30	29	28	27	26	25	24	23	22	21	20	19	18	17	16	15	14	13	12	11	10	9	8	7	6	5	4	3	2	1	0
R	0																RX_ALMOST_FULL															
W																																
Reset	0	0	0	0	0	0	0	0	0	0	0	0	0	0	0	0	0	0	0	0	0	0	0	0	0	0	0	0	0	1	0	0

ENET_RAFL field descriptions

Field	Description
31–8 Reserved	<p>This field is reserved.</p> <p>This read-only field is reserved and always has the value 0.</p>
RX_ALMOST_FULL	Value Of The Receive FIFO Almost Full Threshold

Table continues on the next page...

ENET_RAFL field descriptions (continued)

Field	Description
	Value, in 64-bit words, of the receive FIFO almost full threshold. When the FIFO level comes close to the maximum, so that there is no more space for at least RX_ALMOST_FULL number of words, the MAC stops writing data in the FIFO and truncates the received frame to avoid FIFO overflow. The corresponding error status will be set when the frame is delivered to the application. A minimum value of 4 should be set.

57.5.26 Transmit FIFO Section Empty Threshold (ENET_TSEM)

Address: 0h base + 1A0h offset = 1A0h

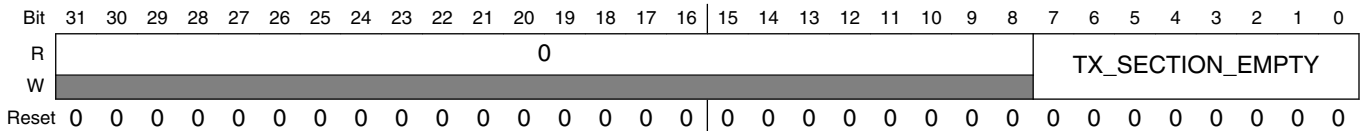

ENET_TSEM field descriptions

Field	Description
31–8 Reserved	This field is reserved. This read-only field is reserved and always has the value 0.
TX_SECTION_EMPTY	Value Of The Transmit FIFO Section Empty Threshold Value, in 64-bit words, of the transmit FIFO section empty threshold. See Transmit FIFO for more information.

57.5.27 Transmit FIFO Almost Empty Threshold (ENET_TAEM)

Address: 0h base + 1A4h offset = 1A4h

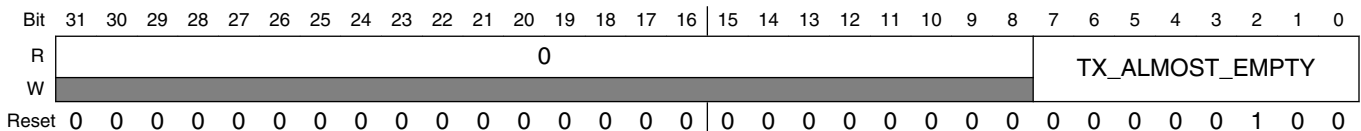

ENET_TAEM field descriptions

Field	Description
31–8 Reserved	This field is reserved. This read-only field is reserved and always has the value 0.
TX_ALMOST_EMPTY	Value of Transmit FIFO Almost Empty Threshold Value, in 64-bit words, of the transmit FIFO almost empty threshold. When the FIFO level reaches the value programmed in this field, and no end-of-frame is available for the frame, the MAC transmit logic, to avoid FIFO underflow, stops reading the FIFO and transmits a frame with an MII error indication. See Transmit FIFO for more information. A minimum value of 4 should be set.

57.5.28 Transmit FIFO Almost Full Threshold (ENET_TAFL)

Address: 0h base + 1A8h offset = 1A8h

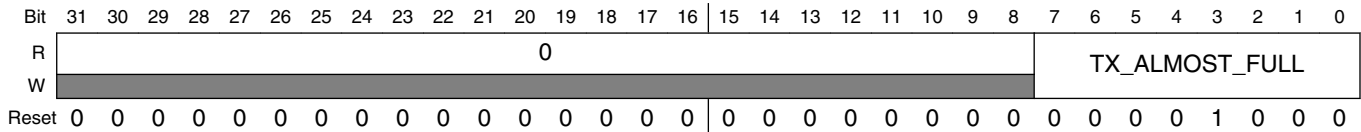

ENET_TAFL field descriptions

Field	Description
31–8 Reserved	This field is reserved. This read-only field is reserved and always has the value 0.
TX_ALMOST_FULL	<p>Value Of The Transmit FIFO Almost Full Threshold</p> <p>Value, in 64-bit words, of the transmit FIFO almost full threshold. A minimum value of six is required . A recommended value of at least 8 should be set allowing a latency of two clock cycles to the application. If more latency is required the value can be increased as necessary (latency = TAFL - 5).</p> <p>When the FIFO level comes close to the maximum, so that there is no more space for at least TX_ALMOST_FULL number of words, the pin ff_tx_rdy is deasserted. If the application does not react on this signal, the FIFO write control logic, to avoid FIFO overflow, truncates the current frame and sets the error status. As a result, the frame will be transmitted with an GMII/MII error indication. See Transmit FIFO for more information.</p> <p>NOTE: A FIFO overflow is a fatal error and requires a global reset on the transmit datapath or at least deassertion of ETHEREN.</p>

57.5.29 Transmit Inter-Packet Gap (ENET_TIPG)

Address: 0h base + 1ACh offset = 1ACh

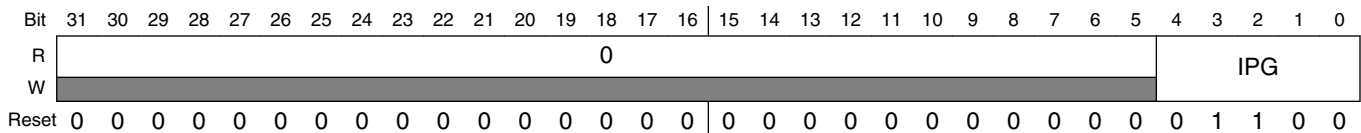

ENET_TIPG field descriptions

Field	Description
31–5 Reserved	This field is reserved. This read-only field is reserved and always has the value 0.
IPG	<p>Transmit Inter-Packet Gap</p> <p>Indicates the IPG, in bytes, between transmitted frames. Valid values range from 8 to 26. If the written value is less than 8 or greater than 26, the internal (effective) IPG is 12.</p> <p>NOTE: The IPG value read will be the value that was written, even if it is out of range.</p>

57.5.30 Frame Truncation Length (ENET_FTRL)

Address: 0h base + 1B0h offset = 1B0h

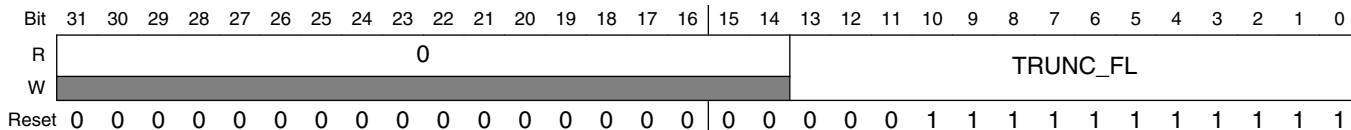

ENET_FTRL field descriptions

Field	Description
31–14 Reserved	This field is reserved. This read-only field is reserved and always has the value 0.
TRUNC_FL	Frame Truncation Length Indicates the value a receive frame is truncated, if it is greater than this value. Must be greater than or equal to RCR[MAX_FL]. NOTE: Truncation happens at TRUNC_FL. However, when truncation occurs, the application (FIFO) may receive less data, guaranteeing that it never receives more than the set limit.

57.5.31 Transmit Accelerator Function Configuration (ENET_TACC)

TACC controls accelerator actions when sending frames. The register can be changed before or after each frame, but it must remain unmodified during frame writes into the transmit FIFO.

The TFWR[STRFWD] field must be set to use the checksum feature.

Address: 0h base + 1C0h offset = 1C0h

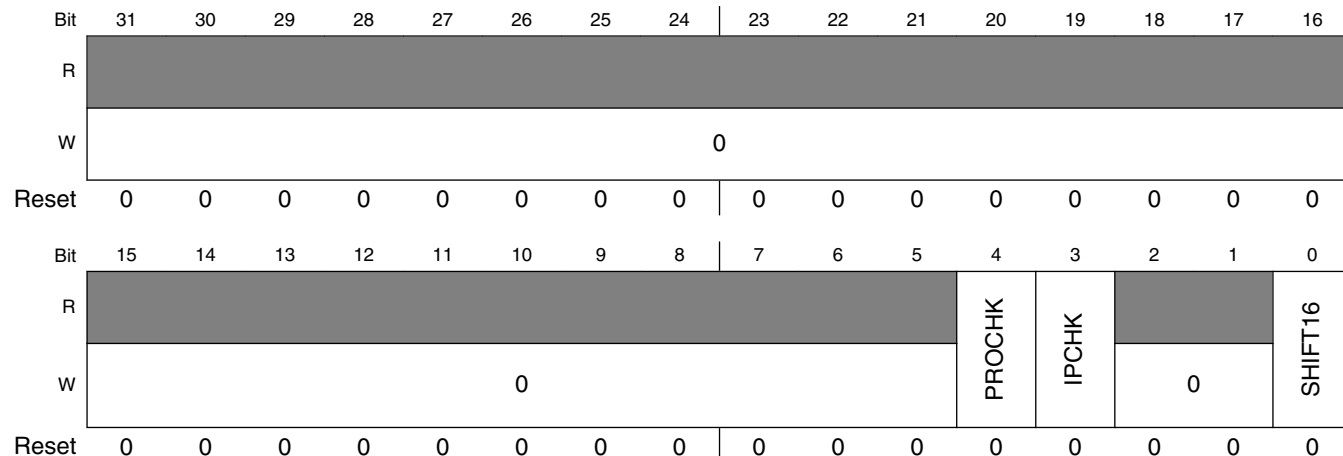

ENET_TACC field descriptions

Field	Description
31–5 Reserved	This field is reserved. This write-only field is reserved. It must always be written with the value 0.
4 PROCHK	Enables insertion of protocol checksum. 0 Checksum not inserted. 1 If an IP frame with a known protocol is transmitted, the checksum is inserted automatically into the frame. The checksum field must be cleared. The other frames are not modified.
3 IPCHK	Enables insertion of IP header checksum. 0 Checksum is not inserted. 1 If an IP frame is transmitted, the checksum is inserted automatically. The IP header checksum field must be cleared. If a non-IP frame is transmitted the frame is not modified.
2–1 Reserved	This field is reserved. This write-only field is reserved. It must always be written with the value 0.
0 SHIFT16	TX FIFO Shift-16 0 Disabled. 1 Indicates to the transmit data FIFO that the written frames contain two additional octets before the frame data. This means the actual frame begins at bit 16 of the first word written into the FIFO. This function allows putting the frame payload on a 32-bit boundary in memory, as the 14-byte Ethernet header is extended to a 16-byte header.

57.5.32 Receive Accelerator Function Configuration (ENET_RACC)

Address: 0h base + 1C4h offset = 1C4h

Bit	31	30	29	28	27	26	25	24	23	22	21	20	19	18	17	16
R	[Reserved]															
W	0															
Reset	0	0	0	0	0	0	0	0	0	0	0	0	0	0	0	0
Bit	15	14	13	12	11	10	9	8	7	6	5	4	3	2	1	0
R	[Reserved]								SHIFT16	LINEDIS	[Reserved]			PRODIS	IPDIS	PADREM
W	0								SHIFT16	LINEDIS	0			PRODIS	IPDIS	PADREM
Reset	0	0	0	0	0	0	0	0	0	0	0	0	0	0	0	0

ENET_RACC field descriptions

Field	Description
31–8 Reserved	This field is reserved. This write-only field is reserved. It must always be written with the value 0.

Table continues on the next page...

ENET_RACC field descriptions (continued)

Field	Description
7 SHIFT16	<p>RX FIFO Shift-16</p> <p>When this field is set, the actual frame data starts at bit 16 of the first word read from the RX FIFO aligning the Ethernet payload on a 32-bit boundary.</p> <p>NOTE: This function only affects the FIFO storage and has no influence on the statistics, which use the actual length of the frame received.</p> <p>0 Disabled. 1 Instructs the MAC to write two additional bytes in front of each frame received into the RX FIFO.</p>
6 LINEDIS	<p>Enable Discard Of Frames With MAC Layer Errors</p> <p>0 Frames with errors are not discarded. 1 Any frame received with a CRC, length, or PHY error is automatically discarded and not forwarded to the user application interface.</p>
5-3 Reserved	<p>This field is reserved. This write-only field is reserved. It must always be written with the value 0.</p>
2 PRODIS	<p>Enable Discard Of Frames With Wrong Protocol Checksum</p> <p>0 Frames with wrong checksum are not discarded. 1 If a TCP/IP, UDP/IP, or ICMP/IP frame is received that has a wrong TCP, UDP, or ICMP checksum, the frame is discarded. Discarding is only available when the RX FIFO operates in store and forward mode (RSFL cleared).</p>
1 IPDIS	<p>Enable Discard Of Frames With Wrong IPv4 Header Checksum</p> <p>0 Frames with wrong IPv4 header checksum are not discarded. 1 If an IPv4 frame is received with a mismatching header checksum, the frame is discarded. IPv6 has no header checksum and is not affected by this setting. Discarding is only available when the RX FIFO operates in store and forward mode (RSFL cleared).</p>
0 PADREM	<p>Enable Padding Removal For Short IP Frames</p> <p>0 Padding not removed. 1 Any bytes following the IP payload section of the frame are removed from the frame.</p>

57.5.33 Reserved Statistic Register (ENET_RMON_T_DROP)

Address: 0h base + 200h offset = 200h

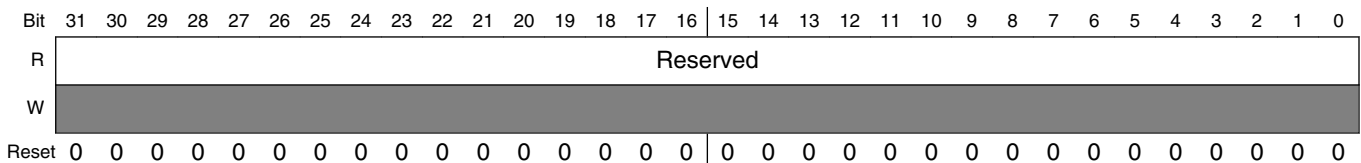

ENET_RMON_T_DROP field descriptions

Field	Description
Reserved	<p>This read-only field always has the value 0.</p> <p>This field is reserved.</p>

57.5.34 Tx Packet Count Statistic Register (ENET_RMON_T_PACKETS)

Address: 0h base + 204h offset = 204h

Bit	31	30	29	28	27	26	25	24	23	22	21	20	19	18	17	16	15	14	13	12	11	10	9	8	7	6	5	4	3	2	1	0					
R	0																TXPKTS																				
W	[Shaded]																																				
Reset	0	0	0	0	0	0	0	0	0	0	0	0	0	0	0	0	0	0	0	0	0	0	0	0	0	0	0	0	0	0	0	0	0	0	0	0	0

ENET_RMON_T_PACKETS field descriptions

Field	Description
31–16 Reserved	This field is reserved. This read-only field is reserved and always has the value 0.
TXPKTS	Packet count Transmit packet count

57.5.35 Tx Broadcast Packets Statistic Register (ENET_RMON_T_BC_PKT)

RMON Tx Broadcast Packets

Address: 0h base + 208h offset = 208h

Bit	31	30	29	28	27	26	25	24	23	22	21	20	19	18	17	16	15	14	13	12	11	10	9	8	7	6	5	4	3	2	1	0							
R	0																TXPKTS																						
W	[Shaded]																																						
Reset	0	0	0	0	0	0	0	0	0	0	0	0	0	0	0	0	0	0	0	0	0	0	0	0	0	0	0	0	0	0	0	0	0	0	0	0	0	0	0

ENET_RMON_T_BC_PKT field descriptions

Field	Description
31–16 Reserved	This field is reserved. This read-only field is reserved and always has the value 0.
TXPKTS	Broadcast packets

57.5.36 Tx Multicast Packets Statistic Register (ENET_RMON_T_MC_PKT)

Address: 0h base + 20Ch offset = 20Ch

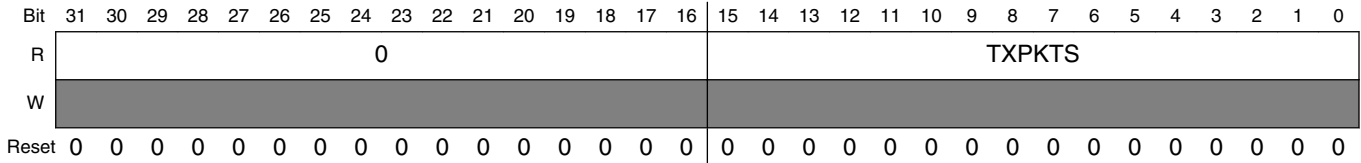

ENET_RMON_T_MC_PKT field descriptions

Field	Description
31–16 Reserved	This field is reserved. This read-only field is reserved and always has the value 0.
TXPKTS	Multicast packets

57.5.37 Tx Packets with CRC/Align Error Statistic Register (ENET_RMON_T_CRC_ALIGN)

Address: 0h base + 210h offset = 210h

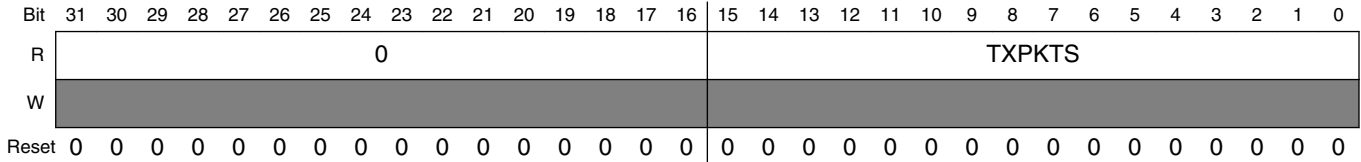

ENET_RMON_T_CRC_ALIGN field descriptions

Field	Description
31–16 Reserved	This field is reserved. This read-only field is reserved and always has the value 0.
TXPKTS	Packets with CRC/align error

57.5.38 Tx Packets Less Than Bytes and Good CRC Statistic Register (ENET_RMON_T_UNDERSIZE)

Address: 0h base + 214h offset = 214h

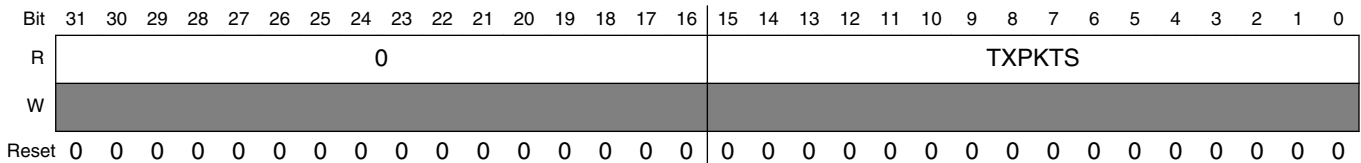

ENET_RMON_T_UNDERSIZE field descriptions

Field	Description
31–16 Reserved	This field is reserved. This read-only field is reserved and always has the value 0.
TXPKTS	Number of transmit packets less than 64 bytes with good CRC

57.5.39 Tx Packets GT MAX_FL bytes and Good CRC Statistic Register (ENET_RMON_T_OVERSIZE)

Address: 0h base + 218h offset = 218h

Bit	31	30	29	28	27	26	25	24	23	22	21	20	19	18	17	16	15	14	13	12	11	10	9	8	7	6	5	4	3	2	1	0
R	0																TXPKTS															
W	[Shaded]																															
Reset	0	0	0	0	0	0	0	0	0	0	0	0	0	0	0	0	0	0	0	0	0	0	0	0	0	0	0	0	0	0	0	0

ENET_RMON_T_OVERSIZE field descriptions

Field	Description
31–16 Reserved	This field is reserved. This read-only field is reserved and always has the value 0.
TXPKTS	Number of transmit packets greater than MAX_FL bytes with good CRC

57.5.40 Tx Packets Less Than 64 Bytes and Bad CRC Statistic Register (ENET_RMON_T_FRAG)

Address: 0h base + 21Ch offset = 21Ch

Bit	31	30	29	28	27	26	25	24	23	22	21	20	19	18	17	16	15	14	13	12	11	10	9	8	7	6	5	4	3	2	1	0
R	0																TXPKTS															
W	[Shaded]																															
Reset	0	0	0	0	0	0	0	0	0	0	0	0	0	0	0	0	0	0	0	0	0	0	0	0	0	0	0	0	0	0	0	0

ENET_RMON_T_FRAG field descriptions

Field	Description
31–16 Reserved	This field is reserved. This read-only field is reserved and always has the value 0.
TXPKTS	Number of packets less than 64 bytes with bad CRC

57.5.41 Tx Packets Greater Than MAX_FL bytes and Bad CRC Statistic Register (ENET_RMON_T_JAB)

Address: 0h base + 220h offset = 220h

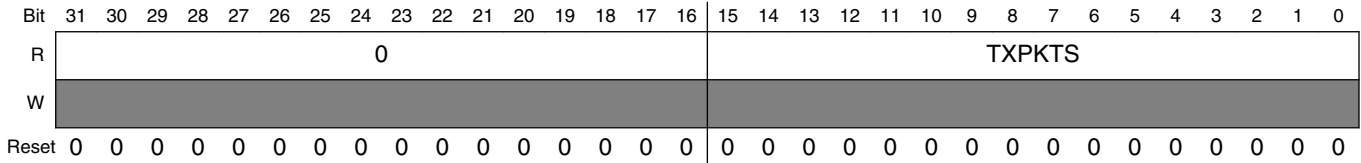

ENET_RMON_T_JAB field descriptions

Field	Description
31–16 Reserved	This field is reserved. This read-only field is reserved and always has the value 0.
TXPKTS	Number of transmit packets greater than MAX_FL bytes and bad CRC

57.5.42 Tx Collision Count Statistic Register (ENET_RMON_T_COL)

Address: 0h base + 224h offset = 224h

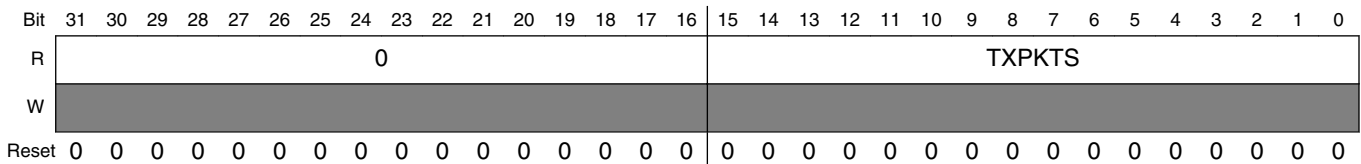

ENET_RMON_T_COL field descriptions

Field	Description
31–16 Reserved	This field is reserved. This read-only field is reserved and always has the value 0.
TXPKTS	Number of transmit collisions

57.5.43 Tx 64-Byte Packets Statistic Register (ENET_RMON_T_P64)

Address: 0h base + 228h offset = 228h

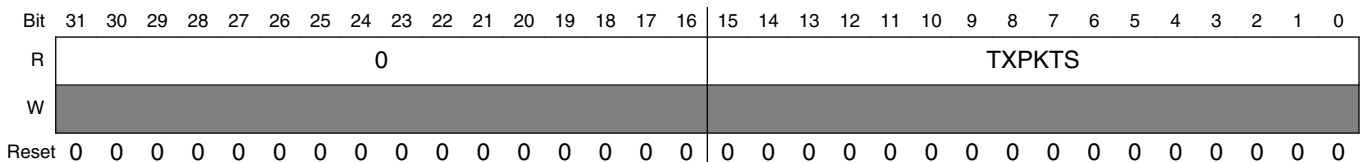

ENET_RMON_T_P64 field descriptions

Field	Description
31–16 Reserved	This field is reserved. This read-only field is reserved and always has the value 0.
TXPKTS	Number of 64-byte transmit packets

57.5.44 Tx 65- to 127-byte Packets Statistic Register (ENET_RMON_T_P65TO127)

Address: 0h base + 22Ch offset = 22Ch

Bit	31	30	29	28	27	26	25	24	23	22	21	20	19	18	17	16	15	14	13	12	11	10	9	8	7	6	5	4	3	2	1	0
R	0																TXPKTS															
W	[Shaded]																															
Reset	0	0	0	0	0	0	0	0	0	0	0	0	0	0	0	0	0	0	0	0	0	0	0	0	0	0	0	0	0	0	0	0

ENET_RMON_T_P65TO127 field descriptions

Field	Description
31–16 Reserved	This field is reserved. This read-only field is reserved and always has the value 0.
TXPKTS	Number of 65- to 127-byte transmit packets

57.5.45 Tx 128- to 255-byte Packets Statistic Register (ENET_RMON_T_P128TO255)

Address: 0h base + 230h offset = 230h

Bit	31	30	29	28	27	26	25	24	23	22	21	20	19	18	17	16	15	14	13	12	11	10	9	8	7	6	5	4	3	2	1	0
R	0																TXPKTS															
W	[Shaded]																															
Reset	0	0	0	0	0	0	0	0	0	0	0	0	0	0	0	0	0	0	0	0	0	0	0	0	0	0	0	0	0	0	0	0

ENET_RMON_T_P128TO255 field descriptions

Field	Description
31–16 Reserved	This field is reserved. This read-only field is reserved and always has the value 0.
TXPKTS	Number of 128- to 255-byte transmit packets

57.5.46 Tx 256- to 511-byte Packets Statistic Register (ENET_RMON_T_P256TO511)

Address: 0h base + 234h offset = 234h

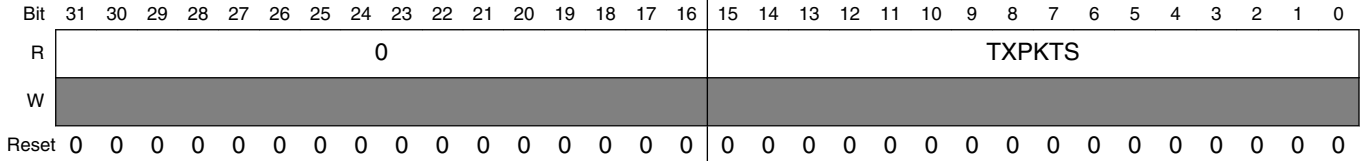

ENET_RMON_T_P256TO511 field descriptions

Field	Description
31–16 Reserved	This field is reserved. This read-only field is reserved and always has the value 0.
TXPKTS	Number of 256- to 511-byte transmit packets

57.5.47 Tx 512- to 1023-byte Packets Statistic Register (ENET_RMON_T_P512TO1023)

Address: 0h base + 238h offset = 238h

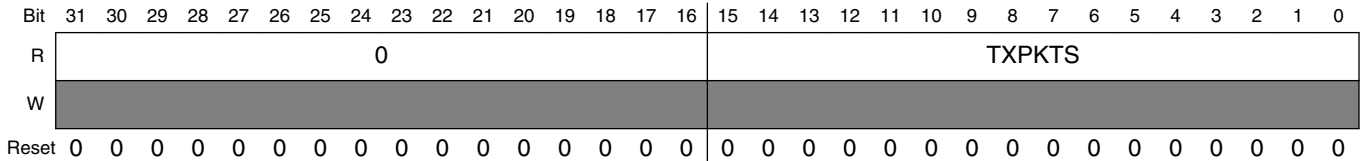

ENET_RMON_T_P512TO1023 field descriptions

Field	Description
31–16 Reserved	This field is reserved. This read-only field is reserved and always has the value 0.
TXPKTS	Number of 512- to 1023-byte transmit packets

57.5.48 Tx 1024- to 2047-byte Packets Statistic Register (ENET_RMON_T_P1024TO2047)

Address: 0h base + 23Ch offset = 23Ch

Bit	31	30	29	28	27	26	25	24	23	22	21	20	19	18	17	16	15	14	13	12	11	10	9	8	7	6	5	4	3	2	1	0		
R	0																TXPKTS																	
W	[Shaded]																																	
Reset	0	0	0	0	0	0	0	0	0	0	0	0	0	0	0	0	0	0	0	0	0	0	0	0	0	0	0	0	0	0	0	0		

ENET_RMON_T_P1024TO2047 field descriptions

Field	Description
31–16 Reserved	This field is reserved. This read-only field is reserved and always has the value 0.
TXPKTS	Number of 1024- to 2047-byte transmit packets

57.5.49 Tx Packets Greater Than 2048 Bytes Statistic Register (ENET_RMON_T_P_GTE2048)

Address: 0h base + 240h offset = 240h

Bit	31	30	29	28	27	26	25	24	23	22	21	20	19	18	17	16	15	14	13	12	11	10	9	8	7	6	5	4	3	2	1	0		
R	0																TXPKTS																	
W	[Shaded]																																	
Reset	0	0	0	0	0	0	0	0	0	0	0	0	0	0	0	0	0	0	0	0	0	0	0	0	0	0	0	0	0	0	0	0		

ENET_RMON_T_P_GTE2048 field descriptions

Field	Description
31–16 Reserved	This field is reserved. This read-only field is reserved and always has the value 0.
TXPKTS	Number of transmit packets greater than 2048 bytes

57.5.50 Tx Octets Statistic Register (ENET_RMON_T_OCTETS)

Address: 0h base + 244h offset = 244h

Bit	31	30	29	28	27	26	25	24	23	22	21	20	19	18	17	16	15	14	13	12	11	10	9	8	7	6	5	4	3	2	1	0		
R	TXOCTS																																	
W	[Shaded]																																	
Reset	0	0	0	0	0	0	0	0	0	0	0	0	0	0	0	0	0	0	0	0	0	0	0	0	0	0	0	0	0	0	0	0		

ENET_RMON_T_OCTETS field descriptions

Field	Description
TXOCTS	Number of transmit octets

57.5.51 Reserved Statistic Register (ENET_IEEE_T_DROP)

Address: 0h base + 248h offset = 248h

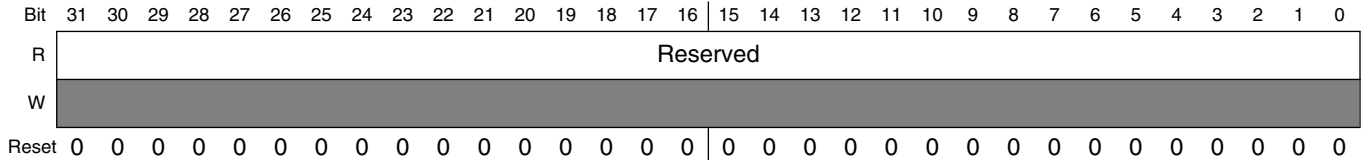

ENET_IEEE_T_DROP field descriptions

Field	Description
Reserved	This read-only field always has the value 0. This field is reserved.

57.5.52 Frames Transmitted OK Statistic Register (ENET_IEEE_T_FRAME_OK)

Address: 0h base + 24Ch offset = 24Ch

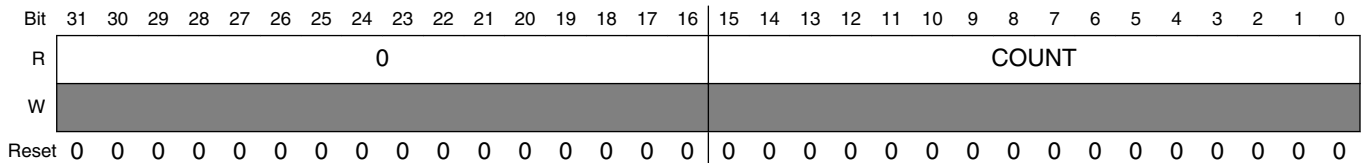

ENET_IEEE_T_FRAME_OK field descriptions

Field	Description
31–16 Reserved	This field is reserved. This read-only field is reserved and always has the value 0.
COUNT	Number of frames transmitted OK NOTE: Does not increment for the broadcast frames when broadcast reject is enabled and promiscuous mode is disabled within the receive control register (RCR).

57.5.53 Frames Transmitted with Single Collision Statistic Register (ENET_IEEE_T_1COL)

Address: 0h base + 250h offset = 250h

Bit	31	30	29	28	27	26	25	24	23	22	21	20	19	18	17	16	15	14	13	12	11	10	9	8	7	6	5	4	3	2	1	0					
R	0																COUNT																				
W	[Shaded]																																				
Reset	0	0	0	0	0	0	0	0	0	0	0	0	0	0	0	0	0	0	0	0	0	0	0	0	0	0	0	0	0	0	0	0	0	0	0	0	0

ENET_IEEE_T_1COL field descriptions

Field	Description
31–16 Reserved	This field is reserved. This read-only field is reserved and always has the value 0.
COUNT	Number of frames transmitted with one collision

57.5.54 Frames Transmitted with Multiple Collisions Statistic Register (ENET_IEEE_T_MCOL)

Address: 0h base + 254h offset = 254h

Bit	31	30	29	28	27	26	25	24	23	22	21	20	19	18	17	16	15	14	13	12	11	10	9	8	7	6	5	4	3	2	1	0						
R	0																COUNT																					
W	[Shaded]																																					
Reset	0	0	0	0	0	0	0	0	0	0	0	0	0	0	0	0	0	0	0	0	0	0	0	0	0	0	0	0	0	0	0	0	0	0	0	0	0	0

ENET_IEEE_T_MCOL field descriptions

Field	Description
31–16 Reserved	This field is reserved. This read-only field is reserved and always has the value 0.
COUNT	Number of frames transmitted with multiple collisions

57.5.55 Frames Transmitted after Deferral Delay Statistic Register (ENET_IEEE_T_DEF)

Address: 0h base + 258h offset = 258h

Bit	31	30	29	28	27	26	25	24	23	22	21	20	19	18	17	16	15	14	13	12	11	10	9	8	7	6	5	4	3	2	1	0							
R	0																COUNT																						
W	[Shaded]																																						
Reset	0	0	0	0	0	0	0	0	0	0	0	0	0	0	0	0	0	0	0	0	0	0	0	0	0	0	0	0	0	0	0	0	0	0	0	0	0	0	0

ENET_IEEE_T_DEF field descriptions

Field	Description
31–16 Reserved	This field is reserved. This read-only field is reserved and always has the value 0.
COUNT	Number of frames transmitted with deferral delay

57.5.56 Frames Transmitted with Late Collision Statistic Register (ENET_IEEE_T_LCOL)

Address: 0h base + 25Ch offset = 25Ch

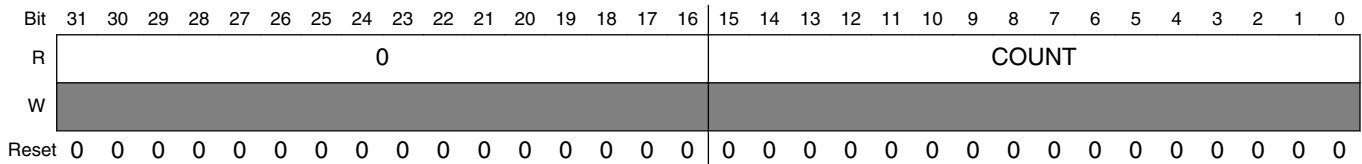

ENET_IEEE_T_LCOL field descriptions

Field	Description
31–16 Reserved	This field is reserved. This read-only field is reserved and always has the value 0.
COUNT	Number of frames transmitted with late collision

57.5.57 Frames Transmitted with Excessive Collisions Statistic Register (ENET_IEEE_T_EXCOL)

Address: 0h base + 260h offset = 260h

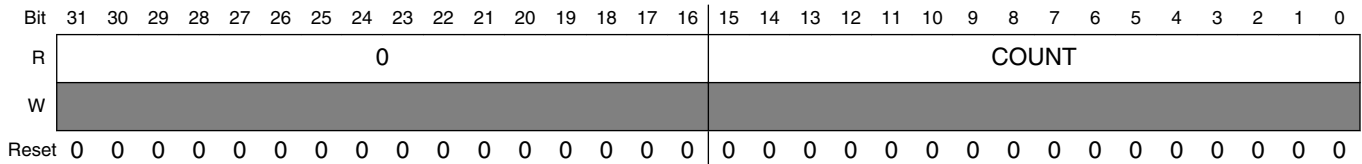

ENET_IEEE_T_EXCOL field descriptions

Field	Description
31–16 Reserved	This field is reserved. This read-only field is reserved and always has the value 0.
COUNT	Number of frames transmitted with excessive collisions

57.5.58 Frames Transmitted with Tx FIFO Underrun Statistic Register (ENET_IEEE_T_MACERR)

Address: 0h base + 264h offset = 264h

Bit	31	30	29	28	27	26	25	24	23	22	21	20	19	18	17	16	15	14	13	12	11	10	9	8	7	6	5	4	3	2	1	0					
R	0																COUNT																				
W	[Shaded]																																				
Reset	0	0	0	0	0	0	0	0	0	0	0	0	0	0	0	0	0	0	0	0	0	0	0	0	0	0	0	0	0	0	0	0	0	0	0	0	0

ENET_IEEE_T_MACERR field descriptions

Field	Description
31–16 Reserved	This field is reserved. This read-only field is reserved and always has the value 0.
COUNT	Number of frames transmitted with transmit FIFO underrun

57.5.59 Frames Transmitted with Carrier Sense Error Statistic Register (ENET_IEEE_T_CSERR)

Address: 0h base + 268h offset = 268h

Bit	31	30	29	28	27	26	25	24	23	22	21	20	19	18	17	16	15	14	13	12	11	10	9	8	7	6	5	4	3	2	1	0						
R	0																COUNT																					
W	[Shaded]																																					
Reset	0	0	0	0	0	0	0	0	0	0	0	0	0	0	0	0	0	0	0	0	0	0	0	0	0	0	0	0	0	0	0	0	0	0	0	0	0	0

ENET_IEEE_T_CSERR field descriptions

Field	Description
31–16 Reserved	This field is reserved. This read-only field is reserved and always has the value 0.
COUNT	Number of frames transmitted with carrier sense error

57.5.60 Reserved Statistic Register (ENET_IEEE_T_SQE)

Address: 0h base + 26Ch offset = 26Ch

Bit	31	30	29	28	27	26	25	24	23	22	21	20	19	18	17	16	15	14	13	12	11	10	9	8	7	6	5	4	3	2	1	0							
R	0																COUNT																						
W	[Shaded]																																						
Reset	0	0	0	0	0	0	0	0	0	0	0	0	0	0	0	0	0	0	0	0	0	0	0	0	0	0	0	0	0	0	0	0	0	0	0	0	0	0	0

ENET_IEEE_T_SQE field descriptions

Field	Description
31–16 Reserved	This field is reserved. This read-only field is reserved and always has the value 0.
COUNT	This read-only field is reserved and always has the value 0. NOTE: Counter not implemented as no SQE information is available.

57.5.61 Flow Control Pause Frames Transmitted Statistic Register (ENET_IEEE_T_FDXFC)

Address: 0h base + 270h offset = 270h

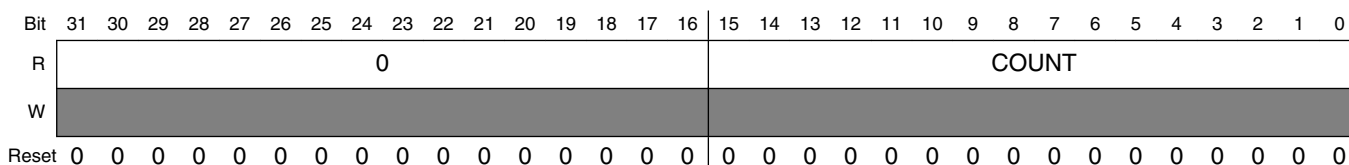

ENET_IEEE_T_FDXFC field descriptions

Field	Description
31–16 Reserved	This field is reserved. This read-only field is reserved and always has the value 0.
COUNT	Number of flow-control pause frames transmitted

57.5.62 Octet Count for Frames Transmitted w/o Error Statistic Register (ENET_IEEE_T_OCTETS_OK)

Address: 0h base + 274h offset = 274h

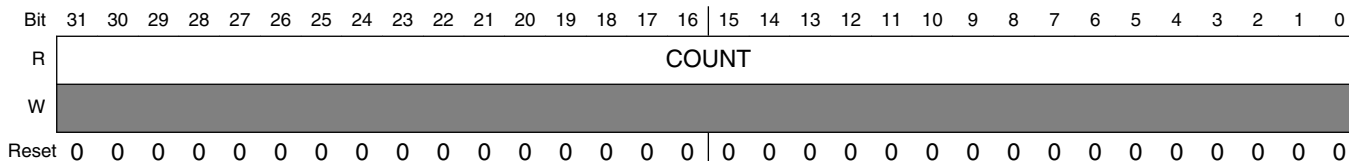

ENET_IEEE_T_OCTETS_OK field descriptions

Field	Description
COUNT	Octet count for frames transmitted without error NOTE Counts total octets (includes header and FCS fields).

57.5.63 Rx Packet Count Statistic Register (ENET_RMON_R_PACKETS)

Address: 0h base + 284h offset = 284h

Bit	31	30	29	28	27	26	25	24	23	22	21	20	19	18	17	16	15	14	13	12	11	10	9	8	7	6	5	4	3	2	1	0					
R	0																COUNT																				
W	[Shaded]																																				
Reset	0	0	0	0	0	0	0	0	0	0	0	0	0	0	0	0	0	0	0	0	0	0	0	0	0	0	0	0	0	0	0	0	0	0	0	0	0

ENET_RMON_R_PACKETS field descriptions

Field	Description
31–16 Reserved	This field is reserved. This read-only field is reserved and always has the value 0.
COUNT	Number of packets received

57.5.64 Rx Broadcast Packets Statistic Register (ENET_RMON_R_BC_PKT)

Address: 0h base + 288h offset = 288h

Bit	31	30	29	28	27	26	25	24	23	22	21	20	19	18	17	16	15	14	13	12	11	10	9	8	7	6	5	4	3	2	1	0						
R	0																COUNT																					
W	[Shaded]																																					
Reset	0	0	0	0	0	0	0	0	0	0	0	0	0	0	0	0	0	0	0	0	0	0	0	0	0	0	0	0	0	0	0	0	0	0	0	0	0	0

ENET_RMON_R_BC_PKT field descriptions

Field	Description
31–16 Reserved	This field is reserved. This read-only field is reserved and always has the value 0.
COUNT	Number of receive broadcast packets

57.5.65 Rx Multicast Packets Statistic Register (ENET_RMON_R_MC_PKT)

Address: 0h base + 28Ch offset = 28Ch

Bit	31	30	29	28	27	26	25	24	23	22	21	20	19	18	17	16	15	14	13	12	11	10	9	8	7	6	5	4	3	2	1	0							
R	0																COUNT																						
W	[Shaded]																																						
Reset	0	0	0	0	0	0	0	0	0	0	0	0	0	0	0	0	0	0	0	0	0	0	0	0	0	0	0	0	0	0	0	0	0	0	0	0	0	0	0

ENET_RMON_R_MC_PKT field descriptions

Field	Description
31–16 Reserved	This field is reserved. This read-only field is reserved and always has the value 0.
COUNT	Number of receive multicast packets

57.5.66 Rx Packets with CRC/Align Error Statistic Register (ENET_RMON_R_CRC_ALIGN)

Address: 0h base + 290h offset = 290h

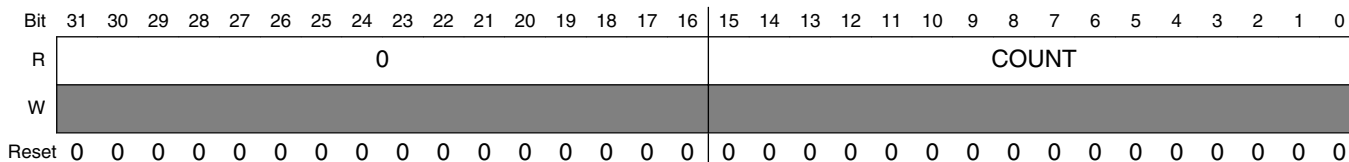

ENET_RMON_R_CRC_ALIGN field descriptions

Field	Description
31–16 Reserved	This field is reserved. This read-only field is reserved and always has the value 0.
COUNT	Number of receive packets with CRC or align error

57.5.67 Rx Packets with Less Than 64 Bytes and Good CRC Statistic Register (ENET_RMON_R_UNDERSIZE)

Address: 0h base + 294h offset = 294h

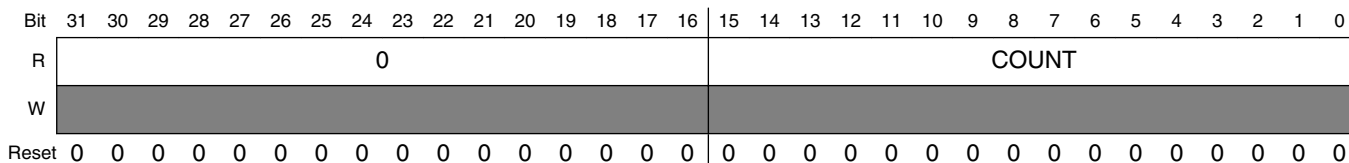

ENET_RMON_R_UNDERSIZE field descriptions

Field	Description
31–16 Reserved	This field is reserved. This read-only field is reserved and always has the value 0.
COUNT	Number of receive packets with less than 64 bytes and good CRC

57.5.68 Rx Packets Greater Than MAX_FL and Good CRC Statistic Register (ENET_RMON_R_OVERSIZE)

Address: 0h base + 298h offset = 298h

Bit	31	30	29	28	27	26	25	24	23	22	21	20	19	18	17	16	15	14	13	12	11	10	9	8	7	6	5	4	3	2	1	0					
R	0																COUNT																				
W	[Shaded]																																				
Reset	0	0	0	0	0	0	0	0	0	0	0	0	0	0	0	0	0	0	0	0	0	0	0	0	0	0	0	0	0	0	0	0	0	0	0	0	0

ENET_RMON_R_OVERSIZE field descriptions

Field	Description
31–16 Reserved	This field is reserved. This read-only field is reserved and always has the value 0.
COUNT	Number of receive packets greater than MAX_FL and good CRC

57.5.69 Rx Packets Less Than 64 Bytes and Bad CRC Statistic Register (ENET_RMON_R_FRAG)

Address: 0h base + 29Ch offset = 29Ch

Bit	31	30	29	28	27	26	25	24	23	22	21	20	19	18	17	16	15	14	13	12	11	10	9	8	7	6	5	4	3	2	1	0							
R	0																COUNT																						
W	[Shaded]																																						
Reset	0	0	0	0	0	0	0	0	0	0	0	0	0	0	0	0	0	0	0	0	0	0	0	0	0	0	0	0	0	0	0	0	0	0	0	0	0	0	0

ENET_RMON_R_FRAG field descriptions

Field	Description
31–16 Reserved	This field is reserved. This read-only field is reserved and always has the value 0.
COUNT	Number of receive packets with less than 64 bytes and bad CRC

57.5.70 Rx Packets Greater Than MAX_FL Bytes and Bad CRC Statistic Register (ENET_RMON_R_JAB)

Address: 0h base + 2A0h offset = 2A0h

Bit	31	30	29	28	27	26	25	24	23	22	21	20	19	18	17	16	15	14	13	12	11	10	9	8	7	6	5	4	3	2	1	0								
R	0																COUNT																							
W	[Shaded]																																							
Reset	0	0	0	0	0	0	0	0	0	0	0	0	0	0	0	0	0	0	0	0	0	0	0	0	0	0	0	0	0	0	0	0	0	0	0	0	0	0	0	0

ENET_RMON_R_JAB field descriptions

Field	Description
31–16 Reserved	This field is reserved. This read-only field is reserved and always has the value 0.
COUNT	Number of receive packets greater than MAX_FL and bad CRC

57.5.71 Reserved Statistic Register (ENET_RMON_R_RESVD_0)

Address: 0h base + 2A4h offset = 2A4h

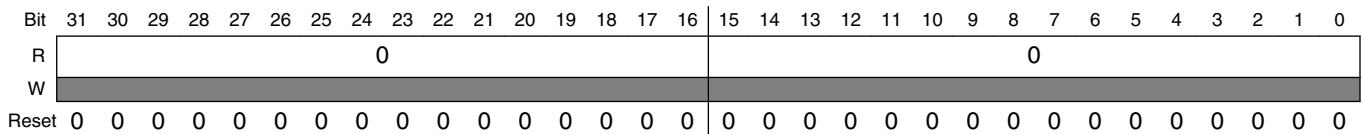

ENET_RMON_R_RESVD_0 field descriptions

Field	Description
31–16 Reserved	This field is reserved. This read-only field is reserved and always has the value 0.
Reserved	This field is reserved. This read-only field is reserved and always has the value 0.

57.5.72 Rx 64-Byte Packets Statistic Register (ENET_RMON_R_P64)

Address: 0h base + 2A8h offset = 2A8h

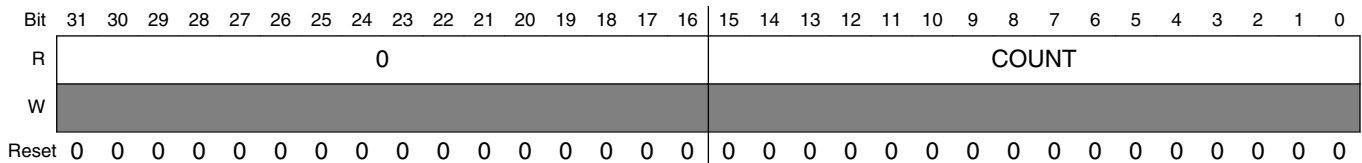

ENET_RMON_R_P64 field descriptions

Field	Description
31–16 Reserved	This field is reserved. This read-only field is reserved and always has the value 0.
COUNT	Number of 64-byte receive packets

ENET_RMON_R_P256TO511 field descriptions

Field	Description
31–16 Reserved	This field is reserved. This read-only field is reserved and always has the value 0.
COUNT	Number of 256- to 511-byte receive packets

57.5.76 Rx 512- to 1023-Byte Packets Statistic Register (ENET_RMON_R_P512TO1023)

Address: 0h base + 2B8h offset = 2B8h

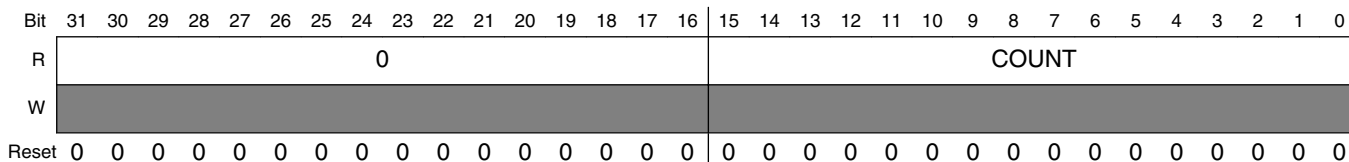

ENET_RMON_R_P512TO1023 field descriptions

Field	Description
31–16 Reserved	This field is reserved. This read-only field is reserved and always has the value 0.
COUNT	Number of 512- to 1023-byte receive packets

57.5.77 Rx 1024- to 2047-Byte Packets Statistic Register (ENET_RMON_R_P1024TO2047)

Address: 0h base + 2BCh offset = 2BCh

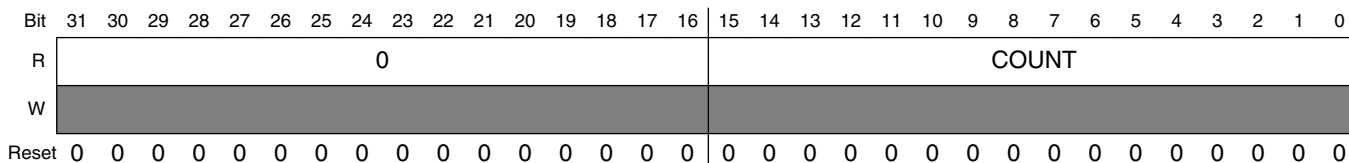

ENET_RMON_R_P1024TO2047 field descriptions

Field	Description
31–16 Reserved	This field is reserved. This read-only field is reserved and always has the value 0.
COUNT	Number of 1024- to 2047-byte receive packets

57.5.78 Rx Packets Greater than 2048 Bytes Statistic Register (ENET_RMON_R_P_GTE2048)

Address: 0h base + 2C0h offset = 2C0h

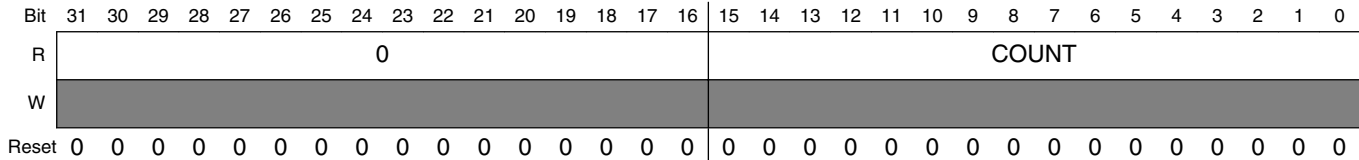

ENET_RMON_R_P_GTE2048 field descriptions

Field	Description
31–16 Reserved	This field is reserved. This read-only field is reserved and always has the value 0.
COUNT	Number of greater-than-2048-byte receive packets

57.5.79 Rx Octets Statistic Register (ENET_RMON_R_OCTETS)

Address: 0h base + 2C4h offset = 2C4h

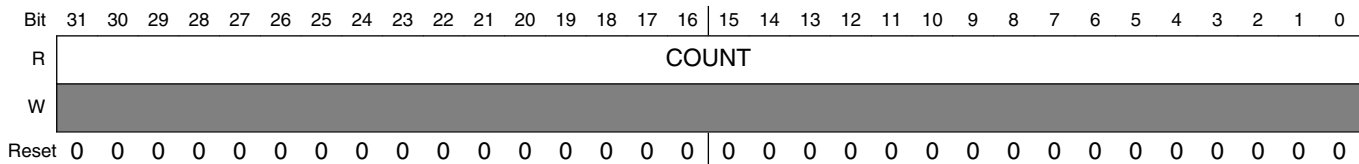

ENET_RMON_R_OCTETS field descriptions

Field	Description
COUNT	Number of receive octets

57.5.80 Frames not Counted Correctly Statistic Register (ENET_IEEE_R_DROP)

Counter increments if a frame with invalid or missing SFD character is detected and has been dropped. None of the other counters increments if this counter increments.

Address: 0h base + 2C8h offset = 2C8h

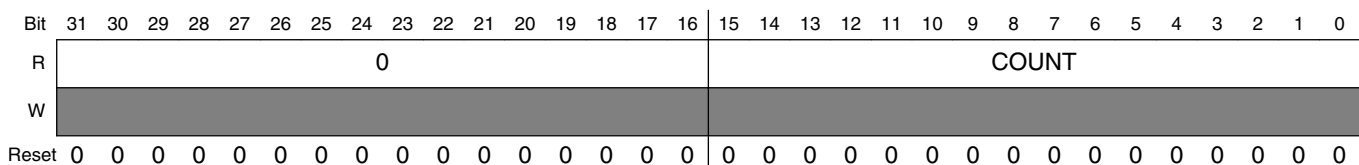

ENET_IEEE_R_DROP field descriptions

Field	Description
31–16 Reserved	This field is reserved. This read-only field is reserved and always has the value 0.
COUNT	Frame count

57.5.81 Frames Received OK Statistic Register (ENET_IEEE_R_FRAME_OK)

Address: 0h base + 2CCh offset = 2CCh

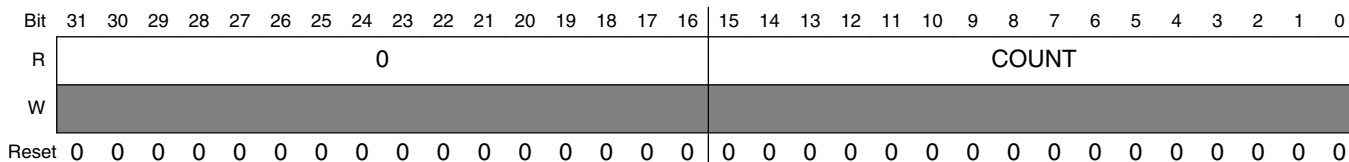

ENET_IEEE_R_FRAME_OK field descriptions

Field	Description
31–16 Reserved	This field is reserved. This read-only field is reserved and always has the value 0.
COUNT	Number of frames received OK

57.5.82 Frames Received with CRC Error Statistic Register (ENET_IEEE_R_CRC)

Address: 0h base + 2D0h offset = 2D0h

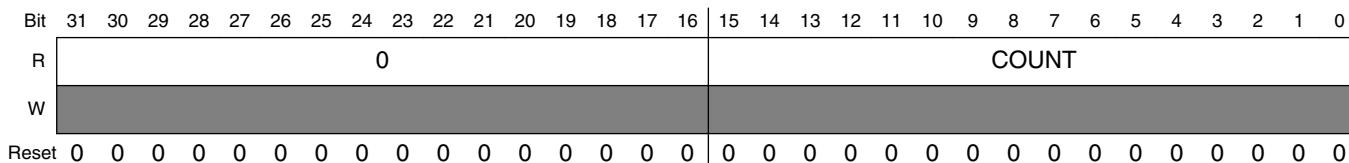

ENET_IEEE_R_CRC field descriptions

Field	Description
31–16 Reserved	This field is reserved. This read-only field is reserved and always has the value 0.
COUNT	Number of frames received with CRC error

57.5.83 Frames Received with Alignment Error Statistic Register (ENET_IEEE_R_ALIGN)

Address: 0h base + 2D4h offset = 2D4h

Bit	31	30	29	28	27	26	25	24	23	22	21	20	19	18	17	16	15	14	13	12	11	10	9	8	7	6	5	4	3	2	1	0		
R	0																COUNT																	
W	[Shaded]																																	
Reset	0	0	0	0	0	0	0	0	0	0	0	0	0	0	0	0	0	0	0	0	0	0	0	0	0	0	0	0	0	0	0	0	0	

ENET_IEEE_R_ALIGN field descriptions

Field	Description
31–16 Reserved	This field is reserved. This read-only field is reserved and always has the value 0.
COUNT	Number of frames received with alignment error

57.5.84 Receive FIFO Overflow Count Statistic Register (ENET_IEEE_R_MACERR)

Address: 0h base + 2D8h offset = 2D8h

Bit	31	30	29	28	27	26	25	24	23	22	21	20	19	18	17	16	15	14	13	12	11	10	9	8	7	6	5	4	3	2	1	0		
R	0																COUNT																	
W	[Shaded]																																	
Reset	0	0	0	0	0	0	0	0	0	0	0	0	0	0	0	0	0	0	0	0	0	0	0	0	0	0	0	0	0	0	0	0	0	

ENET_IEEE_R_MACERR field descriptions

Field	Description
31–16 Reserved	This field is reserved. This read-only field is reserved and always has the value 0.
COUNT	Receive FIFO overflow count

57.5.85 Flow Control Pause Frames Received Statistic Register (ENET_IEEE_R_FDXFC)

Address: 0h base + 2DCh offset = 2DCh

Bit	31	30	29	28	27	26	25	24	23	22	21	20	19	18	17	16	15	14	13	12	11	10	9	8	7	6	5	4	3	2	1	0		
R	0																COUNT																	
W	[Shaded]																																	
Reset	0	0	0	0	0	0	0	0	0	0	0	0	0	0	0	0	0	0	0	0	0	0	0	0	0	0	0	0	0	0	0	0	0	

ENET_IEEE_R_FDXFC field descriptions

Field	Description
31–16 Reserved	This field is reserved. This read-only field is reserved and always has the value 0.
COUNT	Number of flow-control pause frames received

57.5.86 Octet Count for Frames Received without Error Statistic Register (ENET_IEEE_R_OCTETS_OK)

Address: 0h base + 2E0h offset = 2E0h

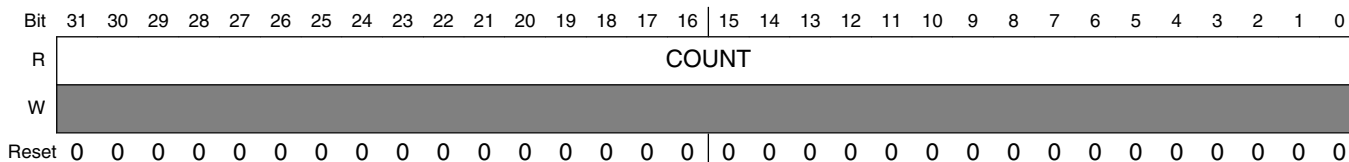

ENET_IEEE_R_OCTETS_OK field descriptions

Field	Description
COUNT	Number of octets for frames received without error
	NOTE: Counts total octets (includes header and FCS fields). Does not increment for the broadcast frames when broadcast reject is enabled and promiscuous mode is disabled within the receive control register (RCR).

57.5.87 Adjustable Timer Control Register (ENET_ATCR)

ATCR command fields can trigger the corresponding events directly. It is not necessary to preserve any of the configuration fields when a command field is set in the register, that is, no read-modify-write is required.

NOTE

The CAPTURE and RESTART fields and bits 12 and 10 must be 0 in order to write to the other fields in this register.

Address: 0h base + 400h offset = 400h

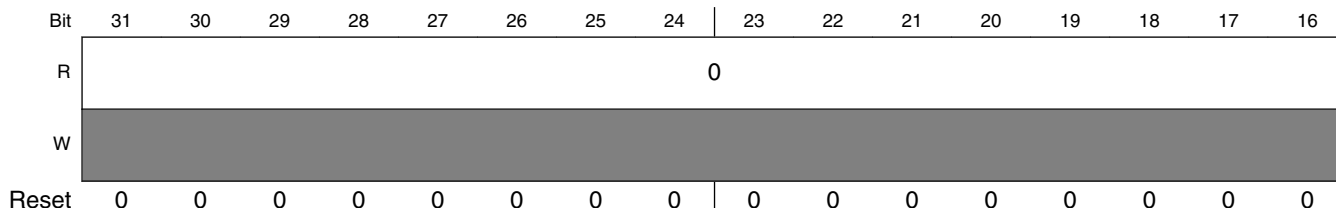

Bit	15	14	13	12	11	10	9	8	7	6	5	4	3	2	1	0
R	0		SLAVE	Reserved	CAPTURE	Reserved	RESTART		PINPER			PEREN	OFFRST	OFFEN		EN
W								0		0	1				0	
Reset	0	0	0	0	0	0	0	0	0	0	0	0	0	0	0	0

ENET_ATCR field descriptions

Field	Description
31–14 Reserved	This field is reserved. This read-only field is reserved and always has the value 0.
13 SLAVE	Enable Timer Slave Mode 0 The timer is active and all configuration fields in this register are relevant. 1 The internal timer is disabled and the externally provided timer value is used. All other fields, except CAPTURE, in this register have no effect. CAPTURE can still be used to capture the current timer value.
12 Reserved	This field is reserved. Always write 0 to this field.
11 CAPTURE	Capture Timer Value When this field is set, all other fields are ignored during a write. This field automatically clears to 0 after the command completes. NOTE: To ensure that the correct time value is read from the ATVR register, a minimum amount of time must elapse from issuing this command to reading the ATVR register. This minimum time is defined by the greater of either six register clock cycles or six 1588/timestamp clock cycles. 0 No effect. 1 The current time is captured and can be read from the ATVR register.
10 Reserved	This field is reserved. Always write 0 to this field.
9 RESTART	Reset Timer Resets the timer to zero. This has no effect on the counter enable. If the counter is enabled when this field is set, the timer is reset to zero and starts counting from there. When set, all other fields are ignored during a write. This field automatically clears to 0 after the command completes. RESTART should be used when the timer is enabled. NOTE: The Reset Timer command requires at least 6 clock cycles of either the register clock or the 1588/timestamp clock, whichever is greater, to complete.
8 Reserved	This field is reserved.
7 PINPER	Enables event signal output assertion on period event. NOTE: Not all devices contain the event signal output. See the chip configuration details. 0 Disable. 1 Enable.
6 Reserved	This field is reserved.

Table continues on the next page...

ENET_ATCR field descriptions (continued)

Field	Description
5 Reserved	This field is reserved. NOTE: This field must be written always with one.
4 PEREN	Enable Periodical Event 0 Disable. 1 A period event interrupt can be generated (EIR[TS_TIMER]) and the event signal output is asserted when the timer wraps around according to the periodic setting ATPER. The timer period value must be set before setting this bit. NOTE: Not all devices contain the event signal output. See the chip configuration details.
3 OFFRST	Reset Timer On Offset Event 0 The timer is not affected and no action occurs, besides clearing OFFEN, when the offset is reached. 1 If OFFEN is set, the timer resets to zero when the offset setting is reached. The offset event does not cause a timer interrupt.
2 OFFEN	Enable One-Shot Offset Event 0 Disable. 1 The timer can be reset to zero when the given offset time is reached (offset event). The field is cleared when the offset event is reached, so no further event occurs until the field is set again. The timer offset value must be set before setting this field.
1 Reserved	This field is reserved.
0 EN	Enable Timer 0 The timer stops at the current value. 1 The timer starts incrementing.

57.5.88 Timer Value Register (ENET_ATVR)

Address: 0h base + 404h offset = 404h

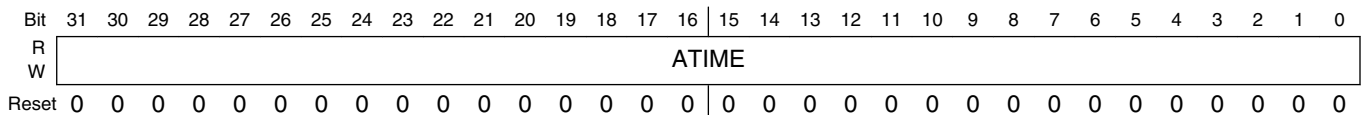

ENET_ATVR field descriptions

Field	Description
ATIME	A write sets the timer. A read returns the last captured value. To read the current value, issue a capture command (i.e., set ATCR[CAPTURE]) prior to reading this register.

57.5.89 Timer Offset Register (ENET_ATOFF)

Address: 0h base + 408h offset = 408h

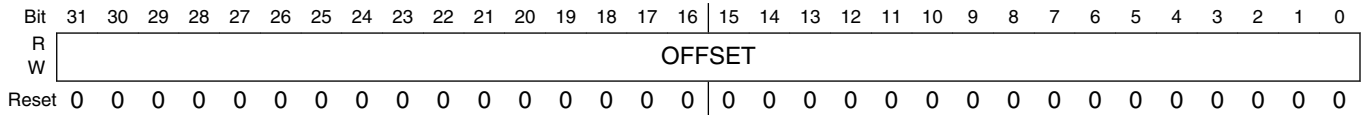

ENET_ATOFF field descriptions

Field	Description
OFFSET	Offset value for one-shot event generation. When the timer reaches the value, an event can be generated to reset the counter. If the increment value in ATINC is given in true nanoseconds, this value is also given in true nanoseconds.

57.5.90 Timer Period Register (ENET_ATPER)

Address: 0h base + 40Ch offset = 40Ch

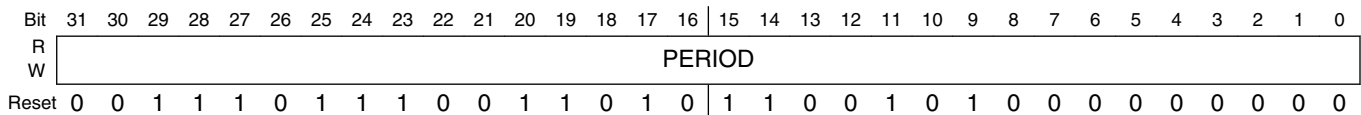

ENET_ATPER field descriptions

Field	Description
PERIOD	<p>Value for generating periodic events. Each instance the timer reaches this value, the period event occurs and the timer restarts. If the increment value in ATINC is given in true nanoseconds, this value is also given in true nanoseconds. The value should be initialized to 1,000,000,000 (1×10^9) to represent a timer wrap around of one second. The increment value set in ATINC should be set to the true nanoseconds of the period of clock <code>ts_clk</code>, hence implementing a true 1 second counter.</p> <p>NOTE: The value of PERIOD has the following constraint:</p> $2^{32} - \text{ENET_ATINC}[\text{INC_COR}] - 3 \times \text{ENET_ATINC}[\text{INC}] \geq \text{PERIOD} > 0.$

57.5.91 Timer Correction Register (ENET_ATCOR)

Address: 0h base + 410h offset = 410h

Bit	31	30	29	28	27	26	25	24		23	22	21	20	19	18	17	16
R	0																
W	COR																
Reset	0	0	0	0	0	0	0	0		0	0	0	0	0	0	0	0
Bit	15	14	13	12	11	10	9	8		7	6	5	4	3	2	1	0
R	COR																
W	COR																
Reset	0	0	0	0	0	0	0	0		0	0	0	0	0	0	0	0

ENET_ATCOR field descriptions

Field	Description
31 Reserved	This field is reserved. This read-only field is reserved and always has the value 0.
COR	Correction Counter Wrap-Around Value Defines after how many timer clock cycles (ts_clk) the correction counter should be reset and trigger a correction increment on the timer. The amount of correction is defined in ATINC[INC_CORR]. A value of 0 disables the correction counter and no corrections occur. NOTE: This value is given in clock cycles, not in nanoseconds as all other values.

57.5.92 Time-Stamping Clock Period Register (ENET_ATINC)

Address: 0h base + 414h offset = 414h

Bit	31	30	29	28	27	26	25	24		23	22	21	20	19	18	17	16
R	0																
W																	
Reset	0	0	0	0	0	0	0	0		0	0	0	0	0	0	0	0
Bit	15	14	13	12	11	10	9	8		7	6	5	4	3	2	1	0
R	0	INC_CORR								0	INC						
W	INC_CORR																
Reset	0	0	0	0	0	0	0	0		0	0	0	0	0	0	0	0

ENET_ATINC field descriptions

Field	Description
31–15 Reserved	This field is reserved. This read-only field is reserved and always has the value 0.
14–8 INC_CORR	Correction Increment Value This value is added every time the correction timer expires (every clock cycle given in ATCOR). A value less than INC slows down the timer. A value greater than INC speeds up the timer.

Table continues on the next page...

ENET_ATINC field descriptions (continued)

Field	Description
7 Reserved	This field is reserved. This read-only field is reserved and always has the value 0.
INC	Clock Period Of The Timestamping Clock (ts_clk) In Nanoseconds The timer increments by this amount each clock cycle. For example, set to 10 for 100 MHz, 8 for 125 MHz, 5 for 200 MHz. NOTE: For highest precision, use a value that is an integer fraction of the period set in ATPER.

57.5.93 Timestamp of Last Transmitted Frame (ENET_ATSTMP)

Address: 0h base + 418h offset = 418h

Bit	31	30	29	28	27	26	25	24	23	22	21	20	19	18	17	16	15	14	13	12	11	10	9	8	7	6	5	4	3	2	1	0
R	TIMESTAMP																															
W																																
Reset	0	0	0	0	0	0	0	0	0	0	0	0	0	0	0	0	0	0	0	0	0	0	0	0	0	0	0	0	0	0	0	0

ENET_ATSTMP field descriptions

Field	Description
TIMESTAMP	Timestamp of the last frame transmitted by the core that had TxBD[TS] set . This register is only valid when EIR[TS_AVAIL] is set.

57.5.94 Timer Global Status Register (ENET_TGSR)

Address: 0h base + 604h offset = 604h

Bit	31	30	29	28	27	26	25	24	23	22	21	20	19	18	17	16
R	0															
W																
Reset	0	0	0	0	0	0	0	0	0	0	0	0	0	0	0	0
Bit	15	14	13	12	11	10	9	8	7	6	5	4	3	2	1	0
R	0												TF3	TF2	TF1	TF0
W													w1c	w1c	w1c	w1c
Reset	0	0	0	0	0	0	0	0	0	0	0	0	0	0	0	0

ENET_TGSR field descriptions

Field	Description
31–4 Reserved	This field is reserved. This read-only field is reserved and always has the value 0.

Table continues on the next page...

ENET_TGSR field descriptions (continued)

Field	Description
3 TF3	Copy Of Timer Flag For Channel 3 0 Timer Flag for Channel 3 is clear 1 Timer Flag for Channel 3 is set
2 TF2	Copy Of Timer Flag For Channel 2 0 Timer Flag for Channel 2 is clear 1 Timer Flag for Channel 2 is set
1 TF1	Copy Of Timer Flag For Channel 1 0 Timer Flag for Channel 1 is clear 1 Timer Flag for Channel 1 is set
0 TF0	Copy Of Timer Flag For Channel 0 0 Timer Flag for Channel 0 is clear 1 Timer Flag for Channel 0 is set

57.5.95 Timer Control Status Register (ENET_TCSRn)

Address: 0h base + 608h offset + (8d × i), where i=0d to 3d

Bit	31	30	29	28	27	26	25	24	23	22	21	20	19	18	17	16
R	0															
W																
Reset	0	0	0	0	0	0	0	0	0	0	0	0	0	0	0	0
Bit	15	14	13	12	11	10	9	8	7	6	5	4	3	2	1	0
R	Reserved					0			TF	TIE		TMODE			0	TDRE
W									w1c							
Reset	0	0	0	0	0	0	0	0	0	0	0	0	0	0	0	0

ENET_TCSRn field descriptions

Field	Description
31–16 Reserved	This field is reserved. This read-only field is reserved and always has the value 0.
15–11 Reserved	This field is reserved. This field must be written with 0.
10–8 Reserved	This field is reserved. This read-only field is reserved and always has the value 0.
7 TF	Timer Flag Sets when input capture or output compare occurs. This flag is double buffered between the module clock and 1588 clock domains. When this field is 1, it can be cleared to 0 by writing 1 to it.

Table continues on the next page...

ENET_TCSR_n field descriptions (continued)

Field	Description
	0 Input Capture or Output Compare has not occurred. 1 Input Capture or Output Compare has occurred.
6 TIE	Timer Interrupt Enable 0 Interrupt is disabled 1 Interrupt is enabled
5–2 TMODE	Timer Mode Updating the Timer Mode field takes a few cycles to register because it is synchronized to the 1588 clock. The version of Timer Mode returned on a read is from the 1588 clock domain. When changing Timer Mode, always disable the channel and read this register to verify the channel is disabled first. 0000 Timer Channel is disabled. 0001 Timer Channel is configured for Input Capture on rising edge. 0010 Timer Channel is configured for Input Capture on falling edge. 0011 Timer Channel is configured for Input Capture on both edges. 0100 Timer Channel is configured for Output Compare - software only. 0101 Timer Channel is configured for Output Compare - toggle output on compare. 0110 Timer Channel is configured for Output Compare - clear output on compare. 0111 Timer Channel is configured for Output Compare - set output on compare. 1000 Reserved 1010 Timer Channel is configured for Output Compare - clear output on compare, set output on overflow. 10X1 Timer Channel is configured for Output Compare - set output on compare, clear output on overflow. 110X Reserved 1110 Timer Channel is configured for Output Compare - pulse output low on compare for one 1588-clock cycle. 1111 Timer Channel is configured for Output Compare - pulse output high on compare for one 1588-clock cycle.
1 Reserved	This field is reserved. This read-only field is reserved and always has the value 0.
0 TDRE	Timer DMA Request Enable 0 DMA request is disabled 1 DMA request is enabled

57.5.96 Timer Compare Capture Register (ENET_TCCR_n)

Address: 0h base + 60Ch offset + (8d × i), where i=0d to 3d

Bit	31	30	29	28	27	26	25	24	23	22	21	20	19	18	17	16	15	14	13	12	11	10	9	8	7	6	5	4	3	2	1	0
R																																
W																																
Reset	0	0	0	0	0	0	0	0	0	0	0	0	0	0	0	0	0	0	0	0	0	0	0	0	0	0	0	0	0	0	0	0

ENET_TCCR_n field descriptions

Field	Description
TCC	<p>Timer Capture Compare</p> <p>This register is double buffered between the module clock and 1588 clock domains.</p> <p>When configured for compare, the 1588 clock domain updates with the value in the module clock domain whenever the Timer Channel is first enabled and on each subsequent compare. Write to this register with the first compare value before enabling the Timer Channel. When the Timer Channel is enabled, write the second compare value either immediately, or at least before the first compare occurs. After each compare, write the next compare value before the previous compare occurs and before clearing the Timer Flag.</p> <p>The compare occurs one 1588 clock cycle after the IEEE 1588 Counter increments past the compare value in the 1588 clock domain. If the compare value is less than the value of the 1588 Counter when the Timer Channel is first enabled, then the compare does not occur until following the next overflow of the 1588 Counter. If the compare value is greater than the IEEE 1588 Counter when the 1588 Counter overflows, or the compare value is less than the value of the IEEE 1588 Counter after the overflow, then the compare occurs one 1588 clock cycle following the overflow.</p> <p>When configured for capture, the value of the IEEE 1588 Counter is captured into the 1588 clock domain and then updated into the module clock domain, provided the Timer Flag is clear. Always read the capture value before clearing the Timer Flag.</p>

57.6 Functional description

This section provides a complete functional description of the MAC-NET core.

57.6.1 Ethernet MAC frame formats

- Minimum length of 64 bytes
- Maximum length of 1518 bytes excluding the preamble and the start frame delimiter (SFD) bytes

An Ethernet frame consists of the following fields:

- Seven bytes preamble
- Start frame delimiter (SFD)
- Two address fields
- Length or type field
- Data field
- Frame check sequence (CRC value)

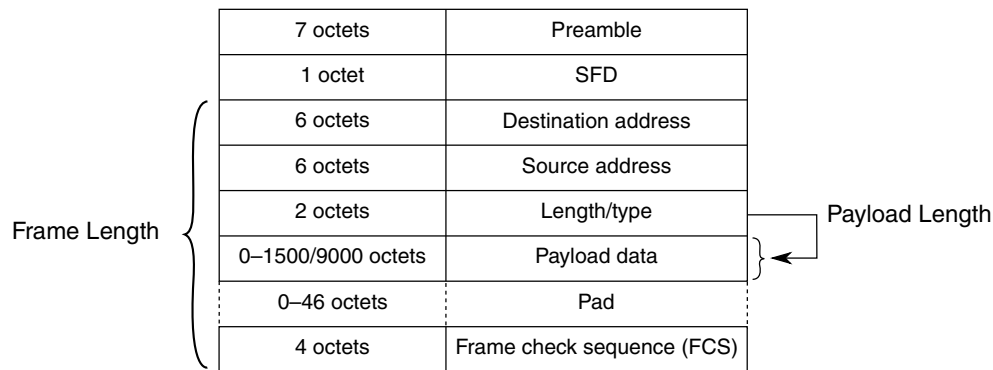

Figure 57-2. MAC frame format overview

Optionally, MAC frames can be VLAN-tagged with an additional four-byte field inserted between the MAC source address and the type/length field. VLAN tagging is defined by the IEEE P802.1q specification. VLAN-tagged frames have a maximum length of 1522 bytes, excluding the preamble and the SFD bytes.

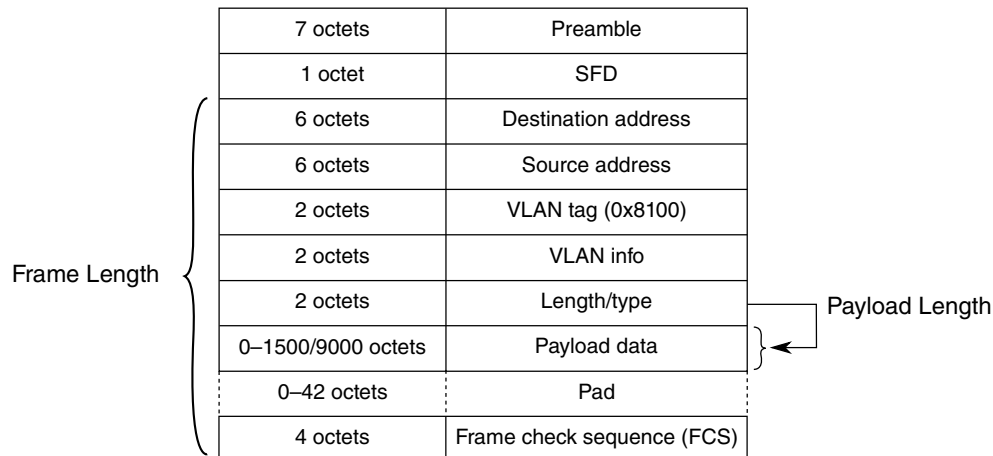

Figure 57-3. VLAN-tagged MAC frame format overview

Table 57-3. MAC frame definition

Term	Description
Frame length	Defines the length, in octets, of the complete frame without preamble and SFD. A frame has a valid length if it contains at least 64 octets and does not exceed the programmed maximum length.
Payload length	The length/type field indicates the length of the frame's payload section. The most significant byte is sent/received first. <ul style="list-style-type: none"> If the length/type field is set to a value less than 46, the payload is padded so that the minimum frame length requirement (64 bytes) is met. For VLAN-tagged frames, a value less than 42 indicates a padded frame. If the length/type field is set to a value larger than the programmed frame maximum length (e.g. 1518) it is interpreted as a type field.
Destination and source address	48-bit MAC addresses. The least significant byte is sent/received first and the first two least significant bits of the MAC address distinguish MAC frames, as detailed in MAC address check .

Note

Although the IEEE specification defines a maximum frame length, the MAC core provides the flexibility to program any value for the frame maximum length.

57.6.1.1 Pause Frames

The receiving device generates a pause frame to indicate a congestion to the emitting device, which should stop sending data.

Pause frames are indicated by the length/type set to 0x8808. The two first bytes of a pause frame following the type, defines a 16-bit opcode field set to 0x0001 always. A 16-bit pause quanta is defined in the frame payload bytes 2 (P1) and 3 (P2) as defined in the following table. The P1 pause quanta byte is the most significant.

Table 57-4. Pause Frame Format (Values in Hex)

1	2	3	4	5	6	7	8	9	10	11	12	13	14
55	55	55	55	55	55	55	D5	01	80	C2	00	00	01
Preamble							SFD	Multicast Destination Address					
15	16	17	18	19	20	21	22	23	24	25	26	27–68	
00	00	00	00	00	00	88	08	00	01	hi	lo	00	
Source Address						Type		Opcode		P1	P2	pad (42)	
69	70	71	72										
26	6B	AE	0A										
CRC-32													

There is no payload length field found within a pause frame and a pause frame is always padded with 42 bytes (0x00).

If a pause frame with a pause value greater than zero (XOFF condition) is received, the MAC stops transmitting data as soon the current frame transfer is completed. The MAC stops transmitting data for the value defined in pause quanta. One pause quanta fraction refers to 512 bit times.

If a pause frame with a pause value of zero (XON condition) is received, the transmitter is allowed to send data immediately (see [Full-duplex flow control operation](#) for details).

57.6.1.2 Magic packets

A magic packet is a unicast, multicast, or broadcast packet, which carries a defined sequence in the payload section.

Magic packets are received and inspected only under specific conditions.

The defined sequence to decode a magic packet is formed with a synchronization stream which consists of six consecutive 0xFF bytes, and is followed by sequence of sixteen consecutive unicast MAC addresses of the node to be awakened.

This sequence can be located anywhere in the magic packet payload. The magic packet is formed with a standard Ethernet header, optional padding, and CRC.

57.6.2 IP and higher layers frame format

For example, an IP datagram specifies the payload section of an Ethernet frame. A TCP datagram specifies the payload section within an IP datagram.

57.6.2.1 Ethernet types

IP datagrams are carried in the payload section of an Ethernet frame. The Ethernet frame type/length field discriminates several datagram types.

The following table lists the types of interest:

Table 57-5. Ethernet type value examples

Type	Description
0x8100	VLAN-tagged frame. The actual type is found 4 octets later in the frame.
0x0800	IPv4
0x0806	ARP
0x86DD	IPv6

57.6.2.2 IPv4 datagram format

The following figure shows the IP Version 4 (IPv4) header, which is located at the beginning of an IP datagram. It is organized in 32-bit words. The first byte sent/received is the leftmost byte of the first word (in other words, version/IHL field).

The IP header can contain further options, which are always padded if necessary to guarantee the payload following the header is aligned to a 32-bit boundary.

The IP header is immediately followed by the payload, which can contain further protocol headers (for example, TCP or UDP, as indicated by the protocol field value). The complete IP datagram is transported in the payload section of an Ethernet frame.

Table 57-6. IPv4 header format

31	30	29	28	27	26	25	24	23	22	21	20	19	18	17	16	15	14	13	12	11	10	9	8	7	6	5	4	3	2	1	0
Version				IHL				TOS				Length																			
Fragment ID								Flags				Fragment offset																			
TTL				Protocol				Header checksum																							
Source address																															
Destination address																															
Options																															

Table 57-7. IPv4 header fields

Field name	Description
Version	4-bit IP version information. 0x4 for IPv4 frames.
IHL	4-bit Internet header length information. Determines number of 32-bit words found within the IP header. If no options are present, the default value is 0x5.
TOS	Type of service/DiffServ field.
Length	Total length of the datagram in bytes, including all octets of header and payload.
Fragment ID, flags, fragment offset	Fields used for IP fragmentation.
TTL	Time-to-live. In effect, is decremented at each router arrival. If zero, datagram must be discarded.
Protocol	Identifier of protocol that follows in the datagram.
Header checksum	Checksum of IP header. For computational purposes, this field's value is zero.
Source address	Source IP address.
Destination address	Destination IP address.

57.6.2.3 IPv6 datagram format

The following figure shows the IP version 6 (IPv6) header, which is located at the beginning of an IP datagram. It is organized in 32-bit words and has a fixed length of ten words (40 bytes). The next header field identifies the type of the header that follows the IPv6 header. It is defined similar to the protocol identifier within IPv4, with new definitions for identifying extension headers. These headers can be inserted between the IPv6 header and the protocol header, which will shift the protocol header accordingly. The accelerator currently only supports IPv6 without extension headers (in other words, the next header specifies TCP, UDP, or ICMP).

The first byte sent/received is the leftmost byte of the first word (in other words, version/traffic class fields).

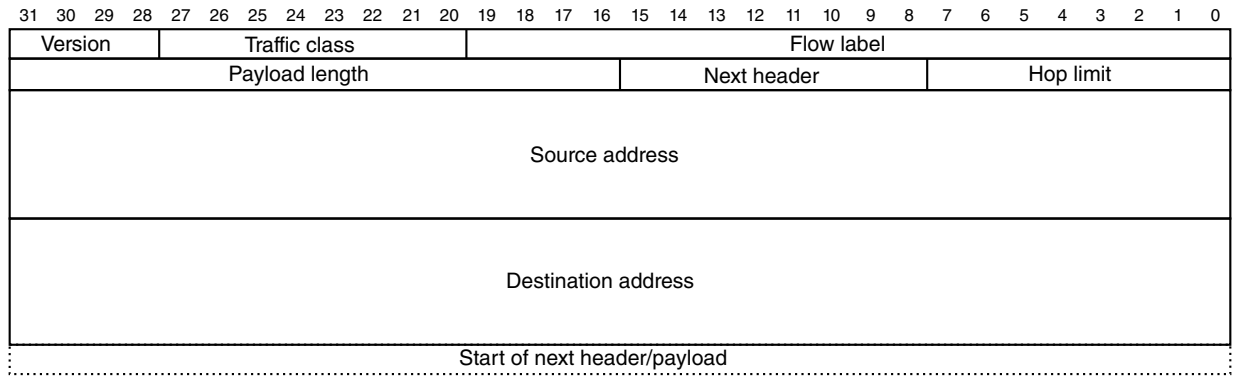

Figure 57-4. IPv6 header format

Table 57-8. IPv6 header fields

Field name	Description
Version	4-bit IP version information. 0x6 for all IPv6 frames.
Traffic class	8-bit field defining the traffic class.
Flow label	20-bit flow label identifying frames of the same flow.
Payload length	16-bit length of the datagram payload in bytes. It includes all octets following the IPv6 header.
Next header	Identifies the header that follows the IPv6 header. This can be the protocol header or any IPv6 defined extension header.
Hop limit	Hop counter, decremented by one by each station that forwards the frame. If hop limit is 0 the frame must be discarded.
Source address	128-bit IPv6 source address.
Destination address	128-bit IPv6 destination address.

57.6.2.4 Internet Control Message Protocol (ICMP) datagram format

An internet control message protocol (ICMP) is found following the IP header, if the protocol identifier is 1. The ICMP datagram has a four-octet header followed by additional message data.

Table 57-9. ICMP header format

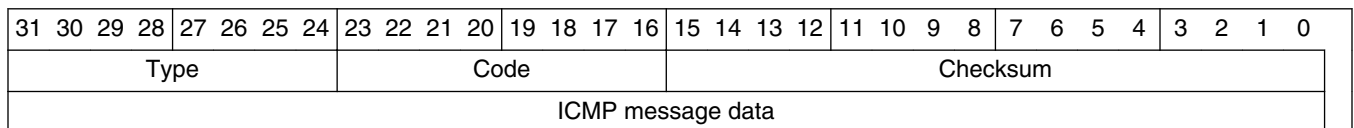

Table 57-10. IP header fields

Field name	Description
Type	8-bit type information
Code	8-bit code that is related to the message type

Table continues on the next page...

Table 57-10. IP header fields (continued)

Field name	Description
Checksum	16-bit one's complement checksum over the complete ICMP datagram

57.6.2.5 User Datagram Protocol (UDP) datagram format

A user datagram protocol header is found after the IP header, when the protocol identifier is 17.

The payload of the datagram is after the UDP header. The header byte order follows the conventions given for the IP header above.

Table 57-11. UDP header format

31	30	29	28	27	26	25	24	23	22	21	20	19	18	17	16	15	14	13	12	11	10	9	8	7	6	5	4	3	2	1	0
Source port																Destination port															
Length																Checksum															

Table 57-12. UDP header fields

Field name	Description
Source port	Source application port
Destination port	Destination application port
Length	Length of user data which immediately follows the header, including the UDP header (that is, minimum value is 8)
Checksum	Checksum over the complete datagram and some IP header information

57.6.2.6 TCP datagram format

A TCP header is found following the IP header, when the protocol identifier has a value of 6.

The TCP payload immediately follows the TCP header.

Table 57-13. TCP header format

31	30	29	28	27	26	25	24	23	22	21	20	19	18	17	16	15	14	13	12	11	10	9	8	7	6	5	4	3	2	1	0
Source port																Destination port															
Sequence number																															
Acknowledgement number																															

Table continues on the next page...

Table 57-13. TCP header format (continued)

Offset	Reserved	Flags	Window
Checksum		Urgent pointer	
Options			

Table 57-14. TCP header fields

Field name	Description
Source port	Source application port
Destination port	Destination application port
Sequence number	Transmit sequence number
Ack. number	Receive sequence number
Offset	Data offset, which is number of 32-bit words within TCP header — if no options selected, defaults to value of 5
Flags	URG, ACK, PSH, RST, SYN, FIN flags
Window	TCP receive window size information
Checksum	Checksum over the complete datagram (TCP header and data) and IP header information
Options	Additional 32-bit words for protocol options

57.6.3 IEEE 1588 message formats

The following sections describe the IEEE 1588 message formats.

57.6.3.1 Transport encapsulation

The precision time protocol (PTP) datagrams are encapsulated in Ethernet frames using the UDP/IP transport mechanism, or optionally, with the newer 1588v2 directly in Ethernet frames (layer 2).

Typically, multicast addresses are used to allow efficient distribution of the synchronization messages.

57.6.3.1.1 UDP/IP

The 1588 messages (v1 and v2) can be transported using UDP/IP multicast messages.

Table 57-15 shows IP multicast groups defined for PTP. The table also shows their respective MAC layer multicast address mapping according to RFC 1112 (last three octets of IP follow the fixed value of 01-00-5E).

Table 57-15. UDP/IP multicast domains

Name	IP Address	MAC Address mapping
DefaultPTPdomain	224.0.1.129	01-00-5E-00-01-81
AlternatePTPdomain1	224.0.1.130	01-00-5E-00-01-82
AlternatePTPdomain2	224.0.1.131	01-00-5E-00-01-83
AlternatePTPdomain3	224.0.1.132	01-00-5E-00-01-84

Table 57-16. UDP port numbers

Message type	UDP port	Note
Event	319	Used for SYNC and DELAY_REQUEST messages
General	320	All other messages (for example, follow-up, delay-response)

57.6.3.1.2 Native Ethernet (PTPv2)

In addition to using UDP/IP frames, IEEE 1588v2 defines a native Ethernet frame format that uses ethertype = 0x88F7. The payload of the Ethernet frame immediately contains the PTP datagram, starting with the PTPv2 header.

Besides others, version 2 adds a peer delay mechanism to allow delay measurements between individual point-to-point links along a path over multiple nodes. The following multicast domains are also defined in PTPv2.

Table 57-17. PTPv2 multicast domains

Name	MAC address
Normal messages	01-1B-19-00-00-00
Peer delay messages	01-80-C2-00-00-0E

57.6.3.2 PTP header

All PTP frames contain a common header that determines the protocol version and the type of message, which defines the remaining content of the message.

All multi-octet fields are transmitted in big-endian order (the most significant byte is transmitted/received first).

The last four bits of versionPTP are at the same position (second byte) for PTPv1 and PTPv2 headers. This allows accurate identification by inspecting the first two bytes of the message.

57.6.3.2.1 PTPv1 header

Table 57-18. Common PTPv1 message header

Offset	Octets	Bits							
		7	6	5	4	3	2	1	0
0	2	versionPTP = 0x0001							
2	2	versionNetwork							
4	16	subdomain							
20	1	messageType							
21	1	sourceCommunicationTechnology							
22	6	sourceUuid							
28	2	sourcePortId							
30	2	sequenceId							
32	1	control							
33	1	0x00							
34	2	flags							
36	4	reserved							

The type of message is encoded in the messageType and control fields as shown in [Table 57-19](#) :

Table 57-19. PTPv1 message type identification

messageType	control	Message Name	Message
0x01	0x0	SYNC	Event message
0x01	0x1	DELAY_REQ	Event message
0x02	0x2	FOLLOW_UP	General message
0x02	0x3	DELAY_RESP	General message
0x02	0x4	MANAGEMENT	General message
other	other	—	Reserved

The field sequenceId is used to non-ambiguously identify a message.

57.6.3.2.2 PTPv2 header

Table 57-20. Common PTPv2 message header

Offset	Octets	Bits							
		7	6	5	4	3	2	1	0
0	1	transportSpecific				messageId			
1	1	reserved				versionPTP = 0x2			
2	2	messageLength							
4	1	domainNumber							
5	1	reserved							
6	2	flags							
8	8	correctionField							
16	4	reserved							
20	10	sourcePortIdentity							
30	2	sequenceId							
32	1	control							
33	1	logMeanMessageInterval							

The type of message is encoded in the field messageId as follows:

Table 57-21. PTPv2 message type identification

messageId	Message name	Message
0x0	SYNC	Event message
0x1	DELAY_REQ	Event message
0x2	PATH_DELAY_REQ	Event message
0x3	PATH_DELAY_RESP	Event message
0x4–0x7	—	Reserved
0x8	FOLLOW_UP	General message
0x9	DELAY_RESP	General message
0xa	PATH_DELAY_FOLLOW_UP	General message
0xb	ANNOUNCE	General message
0xc	SIGNALING	General message
0xd	MANAGEMENT	General message

The PTPv2 flags field contains further details on the type of message, especially if one-step or two-step implementations are used. The one- or two-step implementation is controlled by the TWO_STEP bit in the first octet of the flags field as shown below. Reserved bits are cleared.

Table 57-22. PTPv2 message flags field definitions

Bit	Name	Description
0	ALTERNATE_MASTER	See IEEE 1588 Clause 17.4
1	TWO_STEP	1 Two-step clock 0 One-step clock
2	UNICAST	1 Transport layer address uses a unicast destination address 0 Multicast is used
3	—	Reserved
4	—	Reserved
5	Profile specific	
6	Profile specific	
7	—	Reserved

57.6.4 MAC receive

- Check frame framing
- Remove frame preamble and frame SFD field
- Discard frame based on frame destination address field
- Terminate pause frames
- Check frame length
- Remove payload padding if it exists
- Calculate and verify CRC-32
- Write received frames in the core receive FIFO

If the MAC is programmed to operate in half-duplex mode, it will also check if the frame is received with a collision.

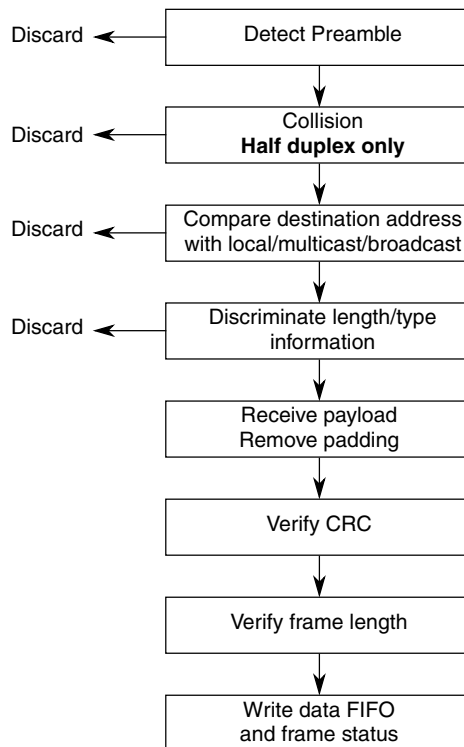

Figure 57-5. MAC receive flow

57.6.4.1 Collision detection in half-duplex mode

If the packet is received with a collision detected during reception of the first 64 bytes, the packet is discarded (if frame size was less than ~14 octets) or transmitted to the user application with an error and RxBD[CE] set.

57.6.4.2 Preamble processing

The IEEE 802.3 standard allows a maximum size of 56 bits (seven bytes) for the preamble, while the MAC core allows any preamble length, including zero length preamble.

The MAC core checks for the start frame delimiter (SFD) byte. If the next byte of the preamble, which is different from 0x55, is not 0xD5, the frame is discarded.

Although the IEEE specification dictates that the inner-packet gap should be at least 96 bits, the MAC core is designed to accept frames separated by only 64 10/100-Mbit/s operation (MII) bits.

The MAC core removes the preamble and SFD bytes.

57.6.4.3 MAC address check

The destination address bit 0 differentiates between multicast and unicast addresses.

- If bit 0 is 0, the MAC address is an individual (unicast) address.
- If bit 0 is 1, the MAC address defines a group (multicast) address.
- If all 48 bits of the MAC address are set, it indicates a broadcast address.

57.6.4.3.1 Unicast address check

If a unicast address is received, the destination MAC address is compared to the node MAC address programmed by the host in the PADDR1/2 registers.

If the destination address matches any of the programmed MAC addresses, the frame is accepted.

If Promiscuous mode is enabled ($\text{RCR}[\text{PROM}] = 1$) no address checking is performed and all unicast frames are accepted.

57.6.4.3.2 Multicast and unicast address resolution

The hash table algorithm used in the group and individual hash filtering operates as follows.

- The 48-bit destination address is mapped into one of 64 bits, represented by 64 bits in $\text{ENET}_n_GAUR/GALR$ (group address hash match) or $\text{ENET}_n_IAUR/IALR$ (individual address hash match).
- This mapping is performed by passing the 48-bit address through the on-chip 32-bit CRC generator and selecting the six most significant bits of the CRC-encoded result to generate a number between 0 and 63.
- The msb of the CRC result selects ENET_n_GAUR (msb = 1) or ENET_n_GALR (msb = 0).
- The five lsbs of the hash result select the bit within the selected register.
- If the CRC generator selects a bit set in the hash table, the frame is accepted; else, it is rejected.

For example, if eight group addresses are stored in the hash table and random group addresses are received, the hash table prevents roughly 56/64 (or 87.5%) of the group address frames from reaching memory. Those that do reach memory must be further filtered by the processor to determine if they truly contain one of the eight desired addresses.

The effectiveness of the hash table declines as the number of addresses increases.

The user must initialize the hash table registers. Use this CRC32 polynomial to compute the hash:

- $FCS(x) = x^{32} + x^{26} + x^{23} + x^{22} + x^{16} + x^{12} + x^{11} + x^{10} + x^8 + x^7 + x^5 + x^4 + x^2 + x^1 + 1$

If Promiscuous mode is enabled ($ENETn_RCR[PROM] = 1$) all unicast and multicast frames are accepted regardless of $ENETn_GAUR/GALR$ and $ENETn_IAUR/IALR$ settings.

57.6.4.3.3 Broadcast address reject

All broadcast frames are accepted if BC_REJ is cleared or $ENETn_RCR[PROM]$ is set. If $PROM$ is cleared when $ENETn_RCR[BC_REJ]$ is set, all broadcast frames are rejected.

Table 57-23. Broadcast address reject programming

PROM	BC_REJ	Broadcast frames
0	0	Accepted
0	1	Rejected
1	0	Accepted
1	1	Accepted

57.6.4.3.4 Miss-bit implementation

For higher layer filtering purposes, $RxBD[M]$ indicates an address miss when the MAC operates in promiscuous mode and accepts a frame that would otherwise be rejected.

If a group/individual hash or exact match does not occur and Promiscuous mode is enabled ($RCR[PROM] = 1$), the frame is accepted and the M bit is set in the buffer descriptor; otherwise, the frame is rejected.

This means the status bit is set in any of the following conditions during Promiscuous mode:

- A broadcast frame is received when BC_REJ is set
- A unicast is received that does not match either:

- Node address (PALR[PADDR1] and PAUR[PADDR2])
- Hash table for unicast (IAUR[IADDR1] and IALR[IADDR2])
- A multicast is received that does not match the GAUR[GADDR1] and GALR[GADDR2] hash table entries

57.6.4.4 Frame length/type verification: payload length check

If the length/type is less than 0x600 and NLC is set, the MAC checks the payload length and reports any error in the frame status word and interrupt bit PLR.

If the length/type is greater than or equal to 0x600, the MAC interprets the field as a type and no payload length check is performed.

The length check is performed on VLAN and stacked VLAN frames. If a padded frame is received, no length check can be performed due to the extended frame payload because padded frames can never have a payload length error.

57.6.4.5 Frame length/type verification: frame length check

When the receive frame length exceeds MAX_FL bytes, the BABR interrupt is generated and the RxBD[LG] bit is set.

The frame is not truncated unless the frame length exceeds the value programmed in ENET_n_FTRL[TRUNC_FL]. If the frame is truncated, RxBD[TR] is set. In addition, a truncated frame always has the CRC error indication set (RxBD[CR]).

57.6.4.6 VLAN frames processing

VLAN frames have a length/type field set to 0x8100 immediately followed by a 16-Bit VLAN control information field.

VLAN-tagged frames are received as normal frames because the VLAN tag is not interpreted by the MAC function, and are pushed complete with the VLAN tag to the user application. If the length/type field of the VLAN-tagged frame, which is found four octets later in the frame, is less than 42, the padding is removed. In addition, the frame status word (RxBD[NO]) indicates that the current frame is VLAN tagged.

57.6.4.7 Pause frame termination

The receive engine terminates pause frames and does not transfer them to the receive FIFO. The quanta is extracted and sent to the MAC transmit path via a small internal clock rate decoupling asynchronous FIFO.

The quanta is written only if a correct CRC and frame length are detected by the control state machine. If not, the quanta is discarded and the MAC transmit path is not paused.

Good pause frames are ignored if `ENETn_RCR[FCE]` is cleared and are forwarded to the client interface when `ENETn_RCR[PAUFWD]` is set.

57.6.4.8 CRC check

The CRC-32 field is checked and forwarded to the core FIFO interface if `ENETn_RCR[CRCFWD]` is cleared and `ENETn_RCR[PADEN]` is cleared. When `CRCFWD` is set (regardless of `PADEN`), the CRC-32 field is checked and terminated (not transmitted to the FIFO).

The CRC polynomial, as specified in the 802.3 standard, is:

- $FCS(x) = x^{32} + x^{26} + x^{23} + x^{22} + x^{16} + x^{12} + x^{11} + x^{10} + x^8 + x^7 + x^5 + x^4 + x^2 + x^1 + 1$

The 32 bits of the CRC value are placed in the frame check sequence (FCS) field with the x^{31} term as right-most bit of the first octet. The CRC bits are thus received in the following order: $x^{31}, x^{30}, \dots, x^1, x^0$.

If a CRC error is detected, the frame is marked invalid and `RxBD[CR]` is set.

57.6.4.9 Frame padding removal

When a frame is received with a payload length field set to less than 46 (42 for VLAN-tagged frames and 38 for frames with stacked VLANs), the zero padding can be removed before the frame is written into the data FIFO depending on the setting of `ENETn_RCR[PADEN]`.

Note

If a frame is received with excess padding (in other words, the length field is set as mentioned above, but the frame has more than 64 octets) and padding removal is enabled, then the

padding is removed as normal and no error is reported if the frame is otherwise correct (for example: good CRC, less than maximum length, and no other error).

57.6.5 MAC transmit

Frame transmission starts when the transmit FIFO holds enough data.

After a transfer starts, the MAC transmit function performs the following tasks:

- Generates preamble and SFD field before frame transmission
- Generates XOFF pause frames if the receive FIFO reports a congestion or if ENET n _TCR[TFC_PAUSE] is set with ENET n _OPD[PAUSE_DUR] set to a non-zero value
- Generates XON pause frames if the receive FIFO congestion condition is cleared or if TFC_PAUSE is set with PAUSE_DUR cleared
- Suspends Ethernet frame transfer (XOFF) if a non-zero pause quanta is received from the MAC receive path
- Adds padding to the frame if required
- Calculates and appends CRC-32 to the transmitted frame
- Sends the frame with correct inter-packet gap (IPG) (deferring)

When the MAC is configured to operate in half-duplex mode, the following additional tasks are performed:

- Collision detection
- Frame retransmit after back-off timer expires

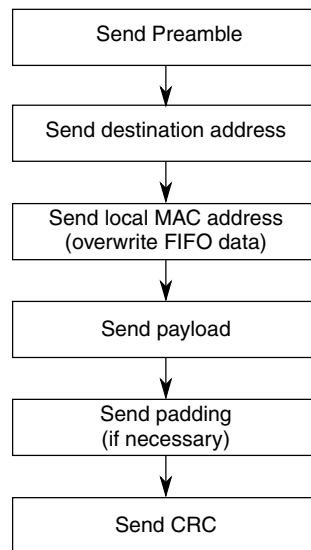

Figure 57-6. Frame transmit overview

57.6.5.1 Frame payload padding

The IEEE specification defines a minimum frame length of 64 bytes.

If the frame sent to the MAC from the user application has a size smaller than 60 bytes, the MAC automatically adds padding bytes (0x00) to comply with the Ethernet minimum frame length specification. Transmit padding is always performed and cannot be disabled.

If the MAC is not allowed to append a CRC (TxBD[TC] = 1), the user application is responsible for providing frames with a minimum length of 64 octets.

57.6.5.2 MAC address insertion

On each frame received from the core transmit FIFO interface, the source MAC address is either:

- Replaced by the address programmed in the PADDR1/2 fields (ENET n _TCR[ADDINS] = 1)
- Transparently forwarded to the Ethernet line (ENET n _TCR[ADDINS] = 0)

57.6.5.3 CRC-32 generation

The CRC-32 field is optionally generated and appended at the end of a frame.

The CRC polynomial, as specified in the 802.3 standard, is:

- $FCS(x) = x^{32} + x^{26} + x^{23} + x^{22} + x^{16} + x^{12} + x^{11} + x^{10} + x^8 + x^7 + x^5 + x^4 + x^2 + x^1 + 1$

The 32 bits of the CRC value are placed in the FCS field so that the x^{31} term is the right-most bit of the first octet. The CRC bits are thus transmitted in the following order: x^{31} , x^{30} , ..., x^1 , x^0 .

57.6.5.4 Inter-packet gap (IPG)

In full-duplex mode, after frame transmission and before transmission of a new frame, an IPG (programmed in ENET n _TIPG) is maintained. The minimum IPG can be programmed between 8 and 26 byte-times (64 and 208 bit-times).

In half-duplex mode, the core constantly monitors the line. Actual transmission of the data onto the network occurs only if it has been idle for a 96-bit time period, and any back-off time requirements have been satisfied. In accordance with the standard, the core begins to measure the IPG from CRS de-assertion.

57.6.5.5 Collision detection and handling — half-duplex operation only

A collision occurs on a half-duplex network when concurrent transmissions from two or more nodes take place. During transmission, the core monitors the line condition and detects a collision when the PHY device asserts COL.

When the core detects a collision while transmitting, it stops transmission of the data and transmits a 32-bit jam pattern. If the collision is detected during the preamble or the SFD transmission, the jam pattern is transmitted after completing the SFD, which results in a minimum 96-bit fragment. The jam pattern is a fixed pattern that is not compared to the actual frame CRC, and has a very low probability (0.532) of having a jam pattern identical to the CRC.

If a collision occurs before transmission of 64 bytes (including preamble and SFD), the MAC core waits for the backoff period and retransmits the packet data (stored in a 64-byte re-transmit buffer) that has already been sent on the line. The backoff period is generated from a pseudo-random process (truncated binary exponential backoff).

If a collision occurs after transmission of 64 bytes (including preamble and SFD), the MAC discards the remainder of the frame, optionally sets the LC interrupt bit, and sets TxBD[LCE].

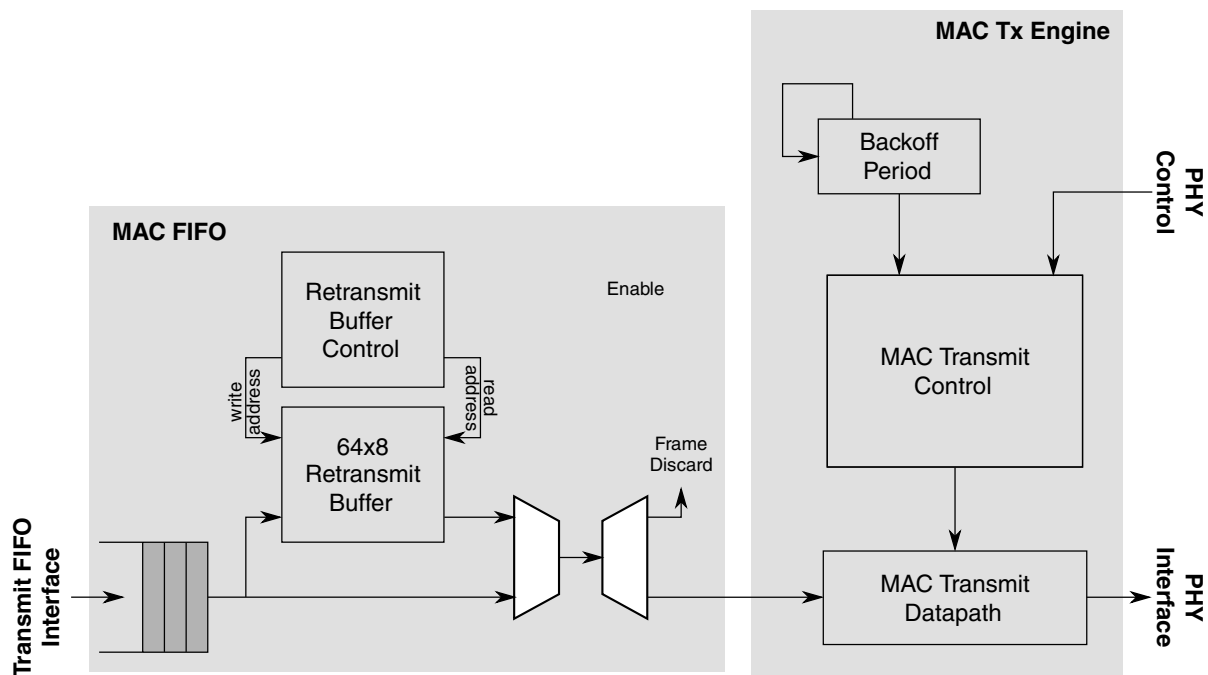

Figure 57-7. Packet re-transmit overview

The backoff time is represented by an integer multiple of slot times. One slot is equal to a 512-bit time period. The number of the delay slot times, before the n^{th} re-transmission attempt, is chosen as a uniformly-distributed random integer in the range:

- $0 < r < 2^k$
- $k = \min(n, N)$; where n is the number of retransmissions and $N = 10$

For example, after the first collision, the backoff period is 0 or 1 slot time. If a collision occurs on the first retransmission, the backoff period is 0, 1, 2, or 3, and so on.

The maximum backoff time (in 512-bit time slots) is limited by $N = 10$ as specified in the IEEE 802.3 standard.

If a collision occurs after 16 consecutive retransmissions, the core reports an excessive collision condition (ENET n _EIR[RL] interrupt field and TxBD[EE]) and discards the current packet from the FIFO.

In networks violating the standard requirements, a collision may occur after transmission of the first 64 bytes. In this case, the core stops the current packet transmission and discards the rest of the packet from the transmit FIFO. The core resumes transmission with the next packet available in the core transmit FIFO.

warning

Ethernet PHYs that support the SQE Test, or "heartbeat," feature must disable this feature. When this feature is enabled,

the PHY asserts the collision signal after a frame is transmitted to indicate to the ENET that the PHY's collision logic is working. This may cause data corruption in the next frame from the ENET. This corrupted frame contains up to 21 zero bytes which start somewhere within the MAC destination address field. The ENET, however, will still generate a good FCS (CRC-32) but with corrupted data.

57.6.6 Full-duplex flow control operation

Three conditions are handled by the core's flow control engine:

- Remote device congestion — The remote device connected to the same Ethernet segment as the core reports congestion and requests that the core stop sending data.
- Core FIFO congestion — When the core's receive FIFO reaches a user-programmable threshold (RX section empty), the core sends a pause frame back to the remote device requesting the data transfer to stop.
- Local device congestion — Any device connected to the core can request (typically, via the host processor) the remote device to stop transmitting data.

57.6.6.1 Remote device congestion

When the MAC transmit control gets a valid pause quanta from the receive path and if `ENETn_RCR[FCE]` is set, the MAC transmit logic:

- Completes the transfer of the current frame.
- Stops sending data for the amount of time specified by the pause quanta in 512 bit time increments.
- Sets `ENETn_TCR[RFC_PAUSE]`.

Frame transfer resumes when the time specified by the quanta expires and if no new quanta value is received, or if a new pause frame with a quanta value set to 0x0000 is received. The MAC also resets `RFC_PAUSE` to zero.

If `ENETn_RCR[FCE]` cleared, the MAC ignores received pause frames.

Optionally and independent of `ENETn_RCR[FCE]`, pause frames are forwarded to the client interface if `PAUFWD` is set.

57.6.6.2 Local device/FIFO congestion

The MAC transmit engine generates pause frames when the local receive FIFO is not able to receive more than a pre-defined number of words (FIFO programmable threshold) or when pause frame generation is requested by the local host processor.

- To generate a pause frame, the host processor sets `ENETn_TCR[TFC_PAUSE]`. A single pause frame is generated when the current frame transfer is completed and `TFC_PAUSE` is automatically cleared. Optionally, an interrupt is generated.
- An XOFF pause frame is generated when the receive FIFO asserts its section empty flag (internal). An XOFF pause frame is generated automatically, when the current frame transfer completes.
- An XON pause frame is generated when the receive FIFO deasserts its section empty flag (internal). An XON pause frame is generated automatically, when the current frame transfer completes.

When an XOFF pause frame is generated, the pause quanta (payload byte P1 and P2) is filled with the value programmed in `ENETn_OPD[PAUSE_DUR]`.

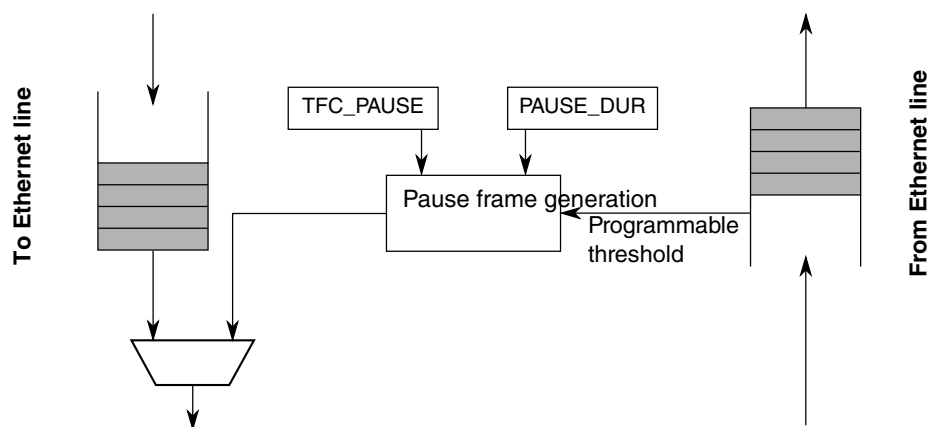

Figure 57-8. Pause frame generation overview

Note

Although the flow control mechanism should prevent any FIFO overflow on the MAC core receive path, the core receive FIFO is protected. When an overflow is detected on the receive FIFO, the current frame is truncated with an error indication set in the frame status word. The frame should subsequently be discarded by the user application.

57.6.7 Magic packet detection

Magic packet detection wakes a node that is put in power-down mode by the node management agent. Magic packet detection is supported only if the MAC is configured in sleep mode.

57.6.7.1 Sleep mode

To put the MAC in Sleep mode, set ENET n _ECR[SLEEP]. At the same time ENET n _ECR[MAGICEN] should also be set to enable magic packet detection.

In addition, if ENET is enabled, write 1 to ENET n _ECR[SLEEP] before entering into low power mode.

When the MAC is in Sleep mode:

- The transmit logic is disabled.
- The FIFO receive/transmit functions are disabled.
- The receive logic is kept in Normal mode, but it ignores all traffic from the line except magic packets. They are detected so that a remote agent can wake the node.

57.6.7.2 Magic packet detection

The core is designed to detect magic packets with the destination address set to:

- Any multicast address
- The broadcast address
- The unicast address programmed in PADDR1/2

When a magic packet is detected, EIR[WAKEUP] is set and none of the statistic registers are incremented.

57.6.7.3 Wakeup

When a magic packet is detected, indicated by $ENETn_EIR[WAKEUP]$, $ENETn_ECR[SLEEP]$ should be cleared to resume normal operation of the MAC. Clearing the SLEEP bit automatically masks $ENETn_ECR[MAGICEN]$, disabling magic packet detection.

57.6.8 IP accelerator functions

57.6.8.1 Checksum calculation

The IP and ICMP, TCP, UDP checksums are calculated with one's complement arithmetic summing up 16-bit values.

- For ICMP, the checksum is calculated over the complete ICMP datagram, in other words without IP header.
- For TCP and UDP, the checksums contain the header and data sections and values from the IP header, which can be seen as a pseudo-header that is not actually present in the data stream.

Table 57-24. IPv4 pseudo-header for checksum calculation

31	30	29	28	27	26	25	24	23	22	21	20	19	18	17	16	15	14	13	12	11	10	9	8	7	6	5	4	3	2	1	0
Source address																															
Destination address																															
Zero				Protocol				TCP/UDP length																							

Table 57-25. IPv6 pseudo-header for checksum calculation

31	30	29	28	27	26	25	24	23	22	21	20	19	18	17	16	15	14	13	12	11	10	9	8	7	6	5	4	3	2	1	0
Source address																															
Destination address																															
TCP/UDP length																															
Zero												Next header																			

The TCP/UDP length value is the length of the TCP or UDP datagram, which is equal to the payload of an IP datagram. It is derived by subtracting the IP header length from the complete IP datagram length that is given in the IP header (IPv4), or directly taken from the IP header (IPv6). The protocol field is the corresponding value from the IP header. The Zero fields are all zeroes.

For IPv6, the complete 128-bit addresses are considered. The next header value identifies the upper layer protocol as either TCP or UDP. It may differ from the next header value of the IPv6 header if extension headers are inserted before the protocol header.

The checksum calculation uses 16-bit words in network byte order: The first byte sent/received is the MSB, and the second byte sent/received is the LSB of the 16-bit value to add to the checksum. If the frame ends on an odd number of bytes, a zero byte is appended for checksum calculation only, and is not actually transmitted.

57.6.8.2 Additional padding processing

According to IEEE 802.3, any Ethernet frame must have a minimum length of 64 octets.

The MAC usually removes padding on receive when a frame with length information is received. Because IP frames have a type value instead of length, the MAC does not remove padding for short IP frames, as it is not aware of the frame contents.

The IP accelerator function can be configured to remove the Ethernet padding bytes that might follow the IP datagram.

On transmit, the MAC automatically adds padding as necessary to fill any frame to a 64-byte length.

57.6.8.3 32-bit Ethernet payload alignment

The data FIFOs allow inserting two additional arbitrary bytes in front of a frame. This extends the 14-byte Ethernet header to a 16-byte header, which leads to alignment of the Ethernet payload, following the Ethernet header, on a 32-bit boundary.

This function can be enabled for transmit and receive independently with the corresponding SHIFT16 bits in the ENET n _TACC and ENET n _RACC registers.

When enabled, the valid frame data is arranged as shown in [Table 57-26](#).

Table 57-26. 64-bit interface data structure with SHIFT16 enabled

63 56	55 48	47 40	39 32	31 24	23 16	15 8	7 0
Byte 5	Byte 4	Byte 3	Byte 2	Byte 1	Byte 0	Any value	Any value
Byte 13	Byte 12	Byte 11	Byte 10	Byte 9	Byte 8	Byte 7	Byte 6
...							

57.6.8.3.1 Receive processing

When `ENETn_RACC[SHIFT16]` is set, each frame is received with two additional bytes in front of the frame.

The user application must ignore these first two bytes and find the first byte of the frame in bits 23–16 of the first word from the RX FIFO.

Note

SHIFT16 must be set during initialization and kept set during the complete operation, because it influences the FIFO write behavior.

57.6.8.3.2 Transmit processing

When `ENETn_TACC[SHIFT16]` is set, the first two bytes of the first word written (bits 15–0) are discarded immediately by the FIFO write logic.

The SHIFT16 bit can be enabled/disabled for each frame individually if required, but can be changed only between frames.

57.6.8.4 Received frame discard

Because the receive FIFO must be operated in store and forward mode (`ENETn_RSFL` cleared), received frames can be discarded based on the following errors:

- The MAC function receives the frame with an error:
 - The frame has an invalid payload length
 - Frame length is greater than `MAX_FL`
 - Frame received with a CRC-32 error
 - Frame truncated due to receive FIFO overflow
 - Frame is corrupted as PHY signaled an error (`RX_ERR` asserted during reception)
- An IP frame is detected and the IP header checksum is wrong
- An IP frame with a valid IP header and a valid IP header checksum is detected, the protocol is known but the protocol-specific checksum is wrong

If one of the errors occurs and the IP accelerator function is configured to discard frames (ENET n _RACC), the frame is automatically discarded. Statistics are maintained normally and are not affected by this discard function.

57.6.8.5 IPv4 fragments

When an IPv4 IP fragment frame is received, only the IP header is inspected and its checksum verified. 32-bit alignment operates the same way on fragments as it does on normal IP frames.

The IP fragment frame payload is not inspected for any protocol headers. As such, a protocol header would only exist in the very first fragment. To assist in protocol-specific checksum verification, the one's-complement sum is calculated on the IP payload (all bytes following the IP header) and provided with the frame status word.

The frame fragment status field (RxBD[FRAG]) is set to indicate a fragment reception, and the one's-complement sum of the IP payload is available in RxBD[Payload checksum].

Note

After all fragments have been received and reassembled, the application software can take advantage of the payload checksum delivered with the frame's status word to calculate the protocol-specific checksum of the datagram.

For example, if a TCP payload is delivered by multiple IP fragments, the application software can calculate the pseudo-header checksum value from the first fragment, and add the payload checksums delivered with the status for all fragments to verify the TCP datagram checksum.

57.6.8.6 IPv6 support

The following sections describe the IPv6 support.

57.6.8.6.1 Receive processing

An Ethernet frame of type 0x86DD identifies an IP Version 6 frame (IPv6) frame. If an IPv6 frame is received, the first IP header is inspected (first ten words), which is available in every IPv6 frame.

If the receive SHIFT16 function is enabled, the IP header is aligned on a 32-bit boundary allowing more efficient processing.

For TCP and UDP datagrams, the pseudo-header checksum calculation is performed and verified.

To assist in protocol-specific checksum verification, the one's-complement sum is always calculated on the IP payload (all bytes following the IP header) and provided with the frame status word. For example, if extension headers were present, their sums can be subtracted in software from the checksum to isolate the TCP/UDP datagram checksum, if required.

57.6.8.6.2 Transmit processing

For IPv6 transmission, the SHIFT16 function is supported to process 32-bit aligned datagrams.

IPv6 has no IP header checksum; therefore, the IP checksum insertion configuration is ignored.

The protocol checksum is inserted only if the next header of the IP header is a known protocol (TCP, UDP, or ICMP). If a known protocol is detected, the checksum over all bytes following the IP header is calculated and inserted in the correct position.

The pseudo-header checksum calculation is performed for TCP and UDP datagrams accordingly.

57.6.9 Resets and stop controls

57.6.9.1 Hardware reset

To reset the Ethernet module, set ENET n _ECR[RESET].

57.6.9.2 Soft reset

When ENET n _ECR[ETHER_EN] is cleared during operation, the following occurs:

- uDMA, buffer descriptor, and FIFO control logic are reset, including the buffer descriptor and FIFO pointers.
- A currently ongoing transmit is terminated by asserting TXER to the PHY.

- A currently ongoing transmit FIFO write from the application is terminated by stopping the write to the FIFO, and all further data from the application is ignored. All subsequent writes are ignored until re-enabled.
- A currently ongoing receive FIFO read is terminated. The RxBD has arbitrary values in this case.

57.6.9.3 Hardware freeze

When the processor enters debug mode and ECR[DBGEN] is set, the MAC enters a freeze state where it stops all transmit and receive activities gracefully.

The following happens when the MAC enters hardware freeze:

- A currently ongoing receive transaction on the receive application interface is completed as normal. No further frames are read from the FIFO.
- A currently ongoing transmit transaction on the transmit application interface is completed as normal (in other words, until writing end-of-packet (EOP)).
- A currently ongoing frame receive is completed normally, after which no further frames are accepted from the MII.
- A currently ongoing frame transmit is completed normally, after which no further frames are transmitted.

57.6.9.4 Graceful stop

During a graceful stop, any currently ongoing transactions are completed normally and no further frames are accepted. The MAC can resume from a graceful stop without the need for a reset (for example, clearing ETHER_EN is not required).

The following conditions lead to a graceful stop of the MAC transmit or receive datapaths.

57.6.9.4.1 Graceful transmit stop (GTS)

When gracefully stopped, the MAC is no longer reading frame data from the transmit FIFO and has completed any ongoing transmission.

In any of the following conditions, the transmit datapath stops after an ongoing frame transmission has been completed normally.

Functional description

- ENET n _TCR[GTS] is set by software.
- ENET n _TCR[TFC_PAUSE] is set by software requesting a pause frame transmission. The status (and register bit) is cleared after the pause frame has been sent.
- A pause frame was received stopping the transmitter. The stopped situation is terminated when the pause timer expires or a pause frame with zero quanta is received.
- MAC is placed in Sleep mode by software or the processor entering Stop mode (see [Sleep mode](#)).
- The MAC is in Hardware Freeze mode.

When the transmitter has reached its stopped state, the following events occur:

- The GRA interrupt is asserted, when transitioned into stopped.
- In Hardware Freeze mode, the GRA interrupt does not wait for the application write completion and asserts when the transmit state machine (in other words, line side of TX FIFO) reaches its stopped state.

57.6.9.4.2 Graceful receive stop (GRS)

When gracefully stopped, the MAC is no longer writing frames into the receive FIFO.

The receive datapath stops after any ongoing frame reception has been completed normally, if any of the following conditions occur:

- MAC is placed in Sleep mode either by the software or the processor is in Stop mode). The MAC continues to receive frames and search for magic packets if enabled (see [Magic packet detection](#)). However, no frames are written into the receive FIFO, and therefore are not forwarded to the application.
- The MAC is in Hardware Freeze mode. The MAC does not accept any frames from the MII.

When the receive datapath is stopped, the following events occur:

- If the RX is in the stopped state, RCR[GRS] is set

- The GRA interrupt is asserted when the transmitter and receiver are stopped
- Any ongoing receive transaction to the application (RX FIFO read) continues normally until the frame end of package (EOP) is reached. After this, the following occurs:
 - When Sleep mode is active, all further frames are discarded, flushing the RX FIFO
 - In Hardware Freeze mode, no further frames are delivered to the application and they stay in the receive FIFO.

Note

The assertion of GRS does not wait for an ongoing FIFO read transaction on the application side of the FIFO (FIFO read).

57.6.9.4.3 Graceful stop interrupt (GRA)

The graceful stopped interrupt (GRA) is asserted for the following conditions:

- In Sleep mode, the interrupt asserts only after both TX and RX datapaths are stopped.
- In Hardware Freeze mode, the interrupt asserts only after both TX and RX datapaths are stopped.
- The MAC transmit datapath is stopped for any other condition (GTS, TFC_PAUSE, pause received).

The GRA interrupt is triggered only once when the stopped state is entered. If the interrupt is cleared while the stop condition persists, no further interrupt is triggered.

57.6.10 IEEE 1588 functions

To allow for IEEE 1588 or similar time synchronization protocol implementations, the MAC is combined with a time-stamping module to support precise time-stamping of incoming and outgoing frames. Set `ENETn_ECR[EN1588]` to enable 1588 support.

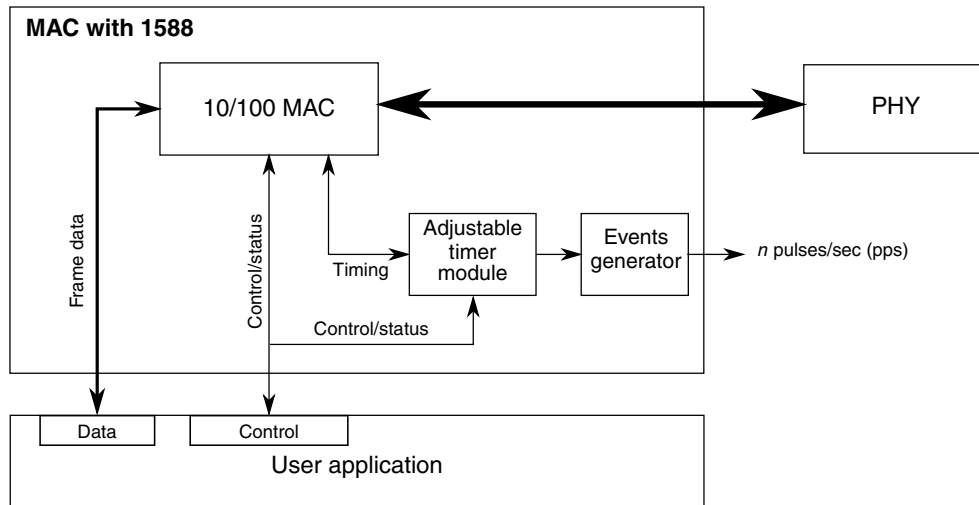

Figure 57-9. IEEE 1588 functions overview

57.6.10.1 Adjustable timer module

The adjustable timer module (TSM) implements the free-running counter (FRC), which generates the timestamps. The FRC operates with the time-stamping clock, which can be set to any value depending on your system requirements.

Through dedicated correction logic, the timer can be adjusted to allow synchronization to a remote master and provide a synchronized timing reference to the local system. The timer can be configured to cause an interrupt after a fixed time period, to allow synchronization of software timers or perform other synchronized system functions.

The timer is typically used to implement a period of one second; hence, its value ranges from 0 to $(1 \times 10^9) - 1$. The period event can trigger an interrupt, and software can maintain the seconds and hours time values as necessary.

57.6.10.1.1 Adjustable timer implementation

The adjustable timer consists of a programmable counter/accumulator and a correction counter. The periods of both counters and their increment rates are freely configurable, allowing very fine tuning of the timer.

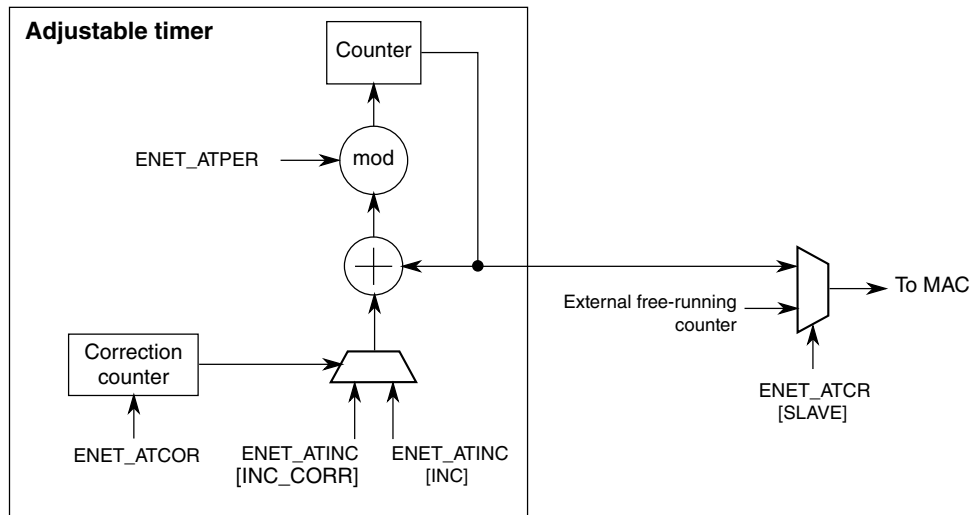

Figure 57-10. Adjustable timer implementation detail

The counter produces the current time. During each time-stamping clock cycle, a constant value is added to the current time as programmed in $ENETn_ATINC$. The value depends on the chosen time-stamping clock frequency. For example, if it operates at 125 MHz, setting the increment to eight represents 8 ns.

The period, configured in $ENETn_ATPER$, defines the modulo when the counter wraps. In a typical implementation, the period is set to 1×10^9 so that the counter wraps every second, and hence all timestamps represent the absolute nanoseconds within the one second period. When the period is reached, the counter wraps to start again respecting the period modulo. This means it does not necessarily start from zero, but instead the counter is loaded with the value $(Current + Inc - (1 \times 10^9))$, assuming the period is set to 1×10^9 .

The correction counter operates fully independently, and increments by one with each time-stamping clock cycle. When it reaches the value configured in $ENETn_ATCOR$, it restarts and instructs the timer once to increment by the correction value, instead of the normal value.

The normal and correction increments are configured in $ENETn_ATINC$. To speed up the timer, set the correction increment more than the normal increment value. To slow down the timer, set the correction increment less than the normal increment value.

The correction counter only defines the distance of the corrective actions, not the amount. This allows very fine corrections and low jitter (in the range of 1 ns) independent of the chosen clock frequency.

By enabling slave mode ($ENETn_ATCR[SLAVE] = 1$), the timer is ignored and the current time is externally provided from one of the external modules. See the Chip Configuration details for which clock source is used. This is useful if multiple modules

within the system must operate from a single timer. When slave mode is enabled, you still must set `ENET n _ATINC[INC]` to the value of the master, since it is used for internal comparisons.

57.6.10.2 Transmit timestamping

Only 1588 event frames need to be time-stamped on transmit. The client application (for example, the MAC driver) should detect 1588 event frames and set `TxBD[TS]` together with the frame.

If `TxBD[TS]` is set, the MAC records the timestamp for the frame in `ENET n _ATSTMP`. `ENET n _EIR[TS_AVAIL]` is set to indicate that a new timestamp is available.

Software implements a handshaking procedure by setting `TxBD[TS]` when it transmits the frame for which a timestamp is needed, and then waits for `ENET n _EIR[TS_AVAIL]` to determine when the timestamp is available. The timestamp is then read from `ENET n _ATSTMP`. This is done for all event frames. Other frames do not use `TxBD[TS]` and, therefore, do not interfere with the timestamp capture.

57.6.10.3 Receive timestamping

When a frame is received, the MAC latches the value of the timer when the frame's start of frame delimiter (SFD) field is detected, and provides the captured timestamp on `RxBD[1588 timestamp]`. This is done for all received frames.

57.6.10.4 Time synchronization

The adjustable timer module is available to synchronize the local clock of a node to a remote master. It implements a free running 32-bit counter, and also contains an additional correction counter.

The correction counter increases or decreases the rate of the free running counter, enabling very fine granular changes of the timer for synchronization, yet adding only very low jitter when performing corrections.

The application software implements, in a slave scenario, the required control algorithm, setting the correction to compensate for local oscillator drifts and locking the timer to the remote master clock on the network.

The timer and all timestamp-related information should be configured to show the true nanoseconds value of a second (in other words, the timer is configured to have a period of one second). Hence, the values range from 0 to $(1 \times 10^9) - 1$. In this application, the seconds counter is implemented in software using an interrupt function that is executed when the nanoseconds counter wraps at 1×10^9 .

57.6.10.5 Input Capture and Output Compare

The Input Capture Output Compare block can be used to provide precise hardware timing for input and output events.

57.6.10.5.1 Input capture

The $TCCR_n$ capture registers latch the time value when the corresponding external event occurs. An event can be a rising-, falling-, or either-edge of one of the 1588_TMR_n signals. An event will cause the corresponding $TCSR_n[TF]$ timer flag to be set, indicating that an input capture has occurred. If the corresponding interrupt is enabled with the $TCSR_n[TIE]$ field, an interrupt can be generated.

57.6.10.5.2 Output compare

The $TCCR_n$ compare registers are loaded with the time at which the corresponding event should occur. When the ENET free-running counter value matches the output compare reference value in the $TCCR_n$ register, the corresponding flag, $TCSR_n[TF]$, is set, indicating that an output compare has occurred. The corresponding interrupt, if enabled by $TCSR_n[TIE]$, will be generated. The corresponding 1588_TMR_n output signal will be asserted according to $TCSR_n[TMODE]$.

NOTE

If $TCSR_n[TMODE]$ is set to 10X1b or 1010b then the timer output pin toggle-on-overflow will occur only when PINPER, PEREN, and EN bits of the ATCR register are one.

57.6.10.5.3 DMA requests

A DMA request can be enabled by setting $TCSR_n[TDRE]$. The corresponding DMA request is generated when the $TCSR_n[TF]$ timer flag is set. When the DMA has completed, the corresponding $TCSR_n[TF]$ flag is cleared.

57.6.11 FIFO thresholds

The core FIFO thresholds are fully programmable to dynamically change the FIFO operation.

For example, store and forward transfer can be enabled by a simple change in the FIFO threshold registers.

The thresholds are defined in 64-bit words.

The receive and transmit FIFOs both have a depth of 256 words.

57.6.11.1 Receive FIFO

Four programmable thresholds are available, which can be set to any value to control the core operation.

Table 57-27. Receive FIFO thresholds definition

Register	Description
ENET n _RSFL [RX_SECTION_F ULL]	<p>When the FIFO level reaches the ENETn_RSFL value, the MAC status signal is asserted to indicate that data is available in the receive FIFO (cut-through operation). Once asserted, if the FIFO empties below the threshold set with ENETn_RAEM and if the end-of-frame is not yet stored in the FIFO, the status signal is deasserted again.</p> <p>If a frame has a size smaller than the threshold (in other words, an end-of-frame is available for the frame), the status is also asserted.</p> <p>To enable store and forward on the receive path, clear ENETn_RSFL. The MAC status signal is asserted only when a complete frame is stored in the receive FIFO.</p> <p>When programming a non-zero value to ENETn_RSFL (cut-through operation) it should be greater than ENETn_RAEM.</p>
ENET n _RAEM [RX_ALMOST_E MPTY]	<p>When the FIFO level reaches the ENETn_RAEM value, and the end-of-frame has not been received, the core receive read control stops the FIFO read (and subsequently stops transferring data to the MAC client application).</p> <p>It continues to deliver the frame, if again more data than the threshold or the end-of-frame is available in the FIFO.</p> <p>Set ENETn_RAEM to a minimum of six.</p>
ENET n _RAFL [RX_ALMOST_F ULL]	<p>When the FIFO level approaches the maximum and there is no more space remaining for at least ENETn_RAFL number of words, the MAC control logic stops writing data in the FIFO and truncates the receive frame to avoid FIFO overflow.</p> <p>The corresponding error status is set when the frame is delivered to the application.</p> <p>Set ENETn_RAFL to a minimum of 4.</p>
ENET n _RSEM [RX_SECTION_E MPTY]	<p>When the FIFO level reaches the ENETn_RSEM value, an indication is sent to the MAC transmit logic, which generates an XOFF pause frame. This indicates FIFO congestion to the remote Ethernet client.</p> <p>When the FIFO level goes below the value programmed in ENETn_RSEM, an indication is sent to the MAC transmit logic, which generates an XON pause frame. This indicates the FIFO congestion is cleared to the remote Ethernet client.</p> <p>Clearing ENETn_RSEM disables any pause frame generation.</p>

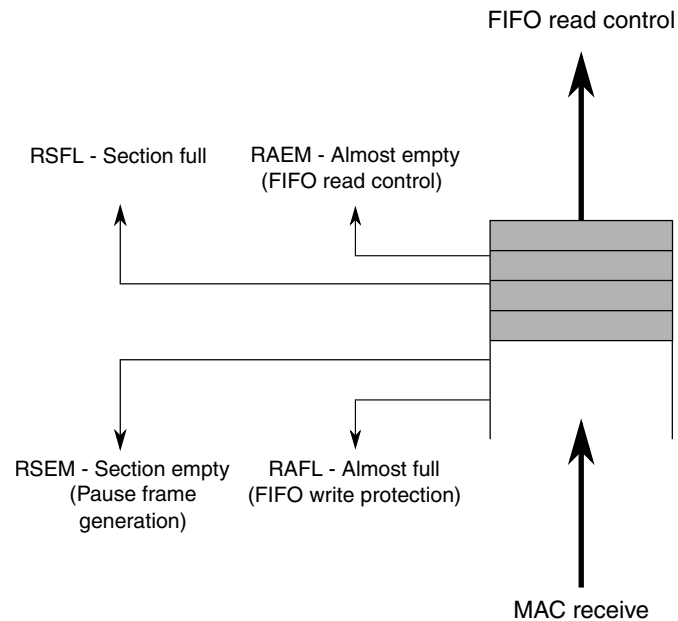

Figure 57-11. Receive FIFO overview

57.6.11.2 Transmit FIFO

Four programmable thresholds are available which control the core operation.

Table 57-28. Transmit FIFO thresholds definition

Register	Description
ENET n _TAEM [TX_ALMOST_EMPTY]	When the FIFO level reaches the ENET n _TAEM value and no end-of-frame is available for the frame, the MAC transmit logic avoids a FIFO underflow by stopping FIFO reads and transmitting the Ethernet frame with an MII error indication. Set ENET n _TAEM to a minimum of 4.
ENET n _TAFL [TX_ALMOST_FULL]	When the FIFO level approaches the maximum, so that there is no more space for at least ENET n _TAFL number of words, the MAC deasserts its control signal to the application. If the application does not react on this signal, the FIFO write control logic avoids FIFO overflow by truncating the current frame and setting the error status. As a result, the frame is transmitted with an MII error indication. Set ENET n _TAFL to a minimum of 4. Larger values allow more latency for the application to react on the MAC control signal deassertion, before the frame is truncated. A typical setting is 8, which offers 3–4 clock cycles of latency to the application to react on the MAC control signal deassertion.
ENET n _TSEM [TX_SECTION_EMPTY]	When the FIFO level reaches the ENET n _TSEM value, a MAC status signal is deasserted to indicate that the transmit FIFO is getting full. This gives the ENET module an indication to slow or stop its write transaction to avoid a buffer overflow. This is a pure indication function to the application. It has no effect within the MAC. When ENET n _TSEM is 0, the signal is never deasserted.
ENET n _TFWR	When the FIFO level reaches the ENET n _TFWR value and when STRFWD is cleared, the MAC transmit control logic starts frame transmission before the end-of-frame is available in the FIFO (cut-through operation).

Table 57-28. Transmit FIFO thresholds definition

Register	Description
	<p>If a complete frame has a size smaller than the ENET_n_TFWR threshold, the MAC also transmits the frame to the line.</p> <p>To enable store and forward on the transmit path, set STRFWD. In this case, the MAC starts to transmit data only when a complete frame is stored in the transmit FIFO.</p>

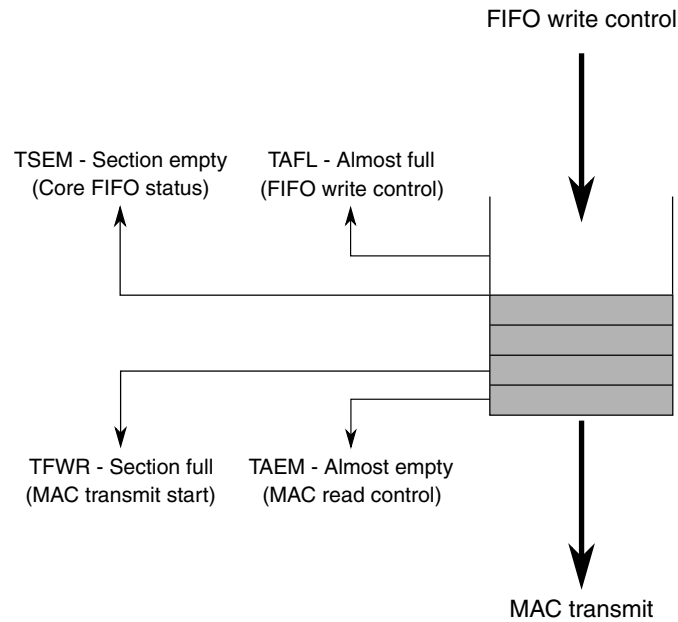

Figure 57-12. Transmit FIFO overview

57.6.12 Loopback options

The core implements external and internal loopback options, which are controlled by the ENET_n_RCR register fields found here.

Table 57-29. Loopback options

Register field	Description
LOOP	<p>Internal MII loopback. The MAC transmit is returned to the MAC receive. No data is transmitted to the external interfaces.</p> <p>In MII internal loopback, MII_TXCLK and MII_RXCLK must be provided with a clock signal (2.5 MHz for 10 Mbit/s, and 25 MHz for 100 Mbit/s)</p>

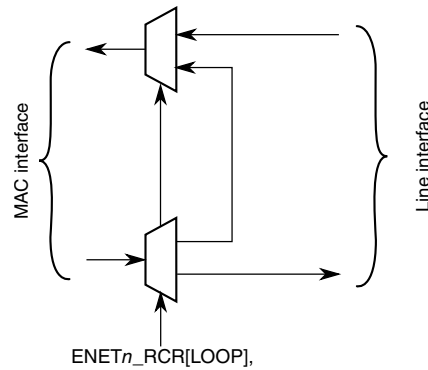

Figure 57-13. Loopback options

57.6.13 Legacy buffer descriptors

To support the Ethernet controller on previous chips, legacy FEC buffer descriptors are available. To enable legacy support, write 0 to ENET n _ECR[1588EN].

NOTE

- The legacy buffer descriptor tables show the byte order for little-endian chips. [DBSWP](#) must be set to 1 after reset to enable little-endian mode.

57.6.13.1 Legacy receive buffer descriptor

The following table shows the legacy FEC receive buffer descriptor. [Table 57-33](#) contains the descriptions for each field.

Table 57-30. Legacy FEC receive buffer descriptor (RxBD)

	Byte 1								Byte 0							
	15	14	13	12	11	10	9	8	7	6	5	4	3	2	1	0
Offset + 0	Data length															
Offset + 2	E	RO1	W	RO2	L	—	—	M	BC	MC	LG	NO	—	CR	OV	TR
Offset + 4	Rx data buffer pointer — low halfword															
Offset + 6	Rx data buffer pointer — high halfword															

57.6.13.2 Legacy transmit buffer descriptor

The following table shows the legacy FEC transmit buffer descriptor. [Table 57-35](#) contains the descriptions for each field.

Table 57-31. Legacy FEC transmit buffer descriptor (TxBD)

	Byte 1								Byte 0							
	15	14	13	12	11	10	9	8	7	6	5	4	3	2	1	0
Offset + 0	Data Length															
Offset + 2	R	TO1	W	TO2	L	TC	ABC ¹	—	—	—	—	—	—	—	—	—
Offset + 4	Tx Data Buffer Pointer — low halfword															
Offset + 6	Tx Data Buffer Pointer — high halfword															

1. This field is not supported by the uDMA.

57.6.14 Enhanced buffer descriptors

This section provides a description of the enhanced operation of the driver/uDMA via the buffer descriptors.

It is followed by a detailed description of the receive and transmit descriptor fields. To enable the enhanced features, set ENET_n_ECR[1588EN].

NOTE

The enhanced buffer descriptor tables show the byte order for little-endian chips. [DBSWP](#) must be set to 1 after reset to enable little-endian mode.

57.6.14.1 Enhanced receive buffer descriptor

The following table shows the enhanced uDMA receive buffer descriptor. [Table 57-33](#) contains the descriptions for each field.

Table 57-32. Enhanced uDMA receive buffer descriptor (RxBD)

	Byte 1								Byte 0							
	15	14	13	12	11	10	9	8	7	6	5	4	3	2	1	0
Offset + 0	Data length															
Offset + 2	E	RO1	W	RO2	L	—	—	M	BC	MC	LG	NO	—	CR	OV	TR
Offset + 4	Rx data buffer pointer – low halfword															
Offset + 6	Rx data buffer pointer – high halfword															

Table continues on the next page...

Table 57-33. Receive buffer descriptor field definitions (continued)

Word	Field	Description
		The information needed for this field comes from the promiscuous_miss(ff_rx_err_stat[26]) sideband signal.
Offset + 2	7 BC	Set if the DA is broadcast (FFFF_FFFF_FFFF).
Offset + 2	6 MC	Set if the DA is multicast and not BC.
Offset + 2	5 LG	Receive frame length violation. Written by the MAC. A frame length greater than RCR[MAX_FL] was recognized. This field is valid only if the L field is set. The receive data is not altered in any way unless the length exceeds TRUNC_FL bytes.
Offset + 2	4 NO	Receive non-octet aligned frame. Written by the MAC. A frame that contained a number of bits not divisible by 8 was received, and the CRC check that occurred at the preceding byte boundary generated an error or a PHY error occurred. This field is valid only if the L field is set. If this field is set, the CR field is not set.
Offset + 2	3	Reserved, must be cleared.
Offset + 2	2 CR	Receive CRC or frame error. Written by the MAC. This frame contains a PHY or CRC error and is an integral number of octets in length. This field is valid only if the L field is set.
Offset + 2	1 OV	Overflow. Written by the MAC. A receive FIFO overrun occurred during frame reception. If this field is set, the other status fields, M, LG, NO, and CR, lose their normal meaning and are zero. This field is valid only if the L field is set.
Offset + 2	0 TR	Set if the receive frame is truncated (frame length >TRUNC_FL). If the TR field is set, the frame must be discarded and the other error fields must be ignored because they may be incorrect.
Offset + 4	15–0 Data buffer pointer low	Receive data buffer pointer, low halfword
Offset + 6	15–0 Data buffer pointer high	Receive data buffer pointer, high halfword The receive buffer pointer, containing the address of the associated data buffer, must always be evenly divisible by 16. The buffer must reside in memory external to the MAC. The Ethernet controller never modifies this value.
Offset + 8	15–13 VPCP	VLAN priority code point. This field is written by the uDMA to indicate the frame priority level. Valid values are from 0 (best effort) to 7 (highest). This value can be used to prioritize different classes of traffic (e.g., voice, video, data). This field is only valid if the L field is set.
Offset + 8	12–6	Reserved, must be cleared.
Offset + 8	5 ICE	IP header checksum error. This is an accelerator option. This field is written by the uDMA. Set when either a non-IP frame is received or the IP header checksum was invalid. An IP frame with less than 3 bytes of payload is considered to be an invalid IP frame. This field is only valid if the L field is set.
Offset + 8	4 PCR	Protocol checksum error. This is an accelerator option. This field is written by the uDMA. Set when the checksum of the protocol is invalid or an unknown protocol is found and checksumming could not be performed. This field is only valid if the L field is set.
Offset + 8	3	Reserved, must be cleared.
Offset + 8	2 VLAN	VLAN. This is an accelerator option. This field is written by the uDMA. It means that the frame has a VLAN tag. This field is valid only if the L field is set.

Table continues on the next page...

Table 57-33. Receive buffer descriptor field definitions (continued)

Word	Field	Description
Offset + 8	1 IPV6	IPV6 Frame. This field is written by the uDMA. This field indicates that the frame has an IPv6 frame type. If this field is not set it means that an IPv4 or other protocol frame was received. This field is valid only if the L field is set.
Offset + 8	0 FRAG	IPv4 Fragment. This is an accelerator option. This field is written by the uDMA. It indicates that the frame is an IPv4 fragment frame. This field is only valid when the L field is set.
Offset + A	15 ME	MAC error. This field is written by the uDMA. This field means that the frame stored in the system memory was received with an error (typically, a receive FIFO overflow). This field is only valid when the L field is set.
Offset + A	14–11	Reserved, must be cleared.
Offset + A	10 PE	PHY Error. This field is written by the uDMA. Set to "1" when the frame was received with an Error character on the PHY interface. The frame is invalid. This field is valid only when the L field is set.
Offset + A	9 CE	Collision. This field is written by the uDMA. Set when the frame was received with a collision detected during reception. The frame is invalid and sent to the user application. This field is valid only when the L field is set.
Offset + A	8 UC	Unicast. This field is written by the uDMA, and means that the frame is unicast. This field is valid regardless of whether the L field is set.
Offset + A	7 INT	Generate RXB/RXF interrupt. This field is set by the user to indicate that the uDMA is to generate an interrupt on the <i>dma_int_rxb / dma_int_rxfevent</i> .
Offset + A	6–0	Reserved, must be cleared.
Offset + C	15–0 Payload checksum	Internet payload checksum. This is an accelerator option. It is the one's complement sum of the payload section of the IP frame. The sum is calculated over all data following the IP header until the end of the IP payload. This field is valid only when the L field is set.
Offset + E	15–11 Header length	Header length. This is an accelerator option. This field is written by the uDMA. This field is the sum of 32-bit words found within the IP and its following protocol headers. If an IP datagram with an unknown protocol is found, then the value is the length of the IP header. If no IP frame or an erroneous IP header is found, the value is 0. The following values are minimum values if no header options exist in the respective headers: <ul style="list-style-type: none"> • ICMP/IP: 6 (5 IP header, 1 ICMP header) • UDP/IP: 7 (5 IP header, 2 UDP header) • TCP/IP: 10 (5 IP header, 5 TCP header) This field is only valid if the L field is set.
Offset + E	10–8	Reserved, must be cleared.
Offset + E	7–0 Protocol type	Protocol type. This is an accelerator option. The 8-bit protocol field found within the IP header of the frame. It is valid only when ICE is cleared. This field is valid only when the L field is set.
Offset + 10	15–0	Reserved, must be cleared.
Offset + 12	15 BDU	Last buffer descriptor update done. Indicates that the last BD data has been updated by uDMA. This field is written by the user (=0) and uDMA (=1).
Offset + 12	14–0	Reserved, must be cleared.
Offset + 14	15–0	This value is written by the uDMA. It is only valid if the L field is set.
Offset + 16		

Table continues on the next page...

Table 57-33. Receive buffer descriptor field definitions (continued)

Word	Field	Description
	1588 timestamp	
Offset + 18 – Offset + 1E	15–0	Reserved, must be cleared.

57.6.14.2 Enhanced transmit buffer descriptor

Table 57-34. Enhanced transmit buffer descriptor (TxBD)

	Byte 1								Byte 0							
	15	14	13	12	11	10	9	8	7	6	5	4	3	2	1	0
Offset + 0	Data length															
Offset + 2	R	TO1	W	TO2	L	TC	—	—	—	—	—	—	—	—	—	—
Offset + 4	Tx Data Buffer Pointer – low halfword															
Offset + 6	Tx Data Buffer Pointer – high halfword															
Offset + 8	TXE	—	UE	EE	FE	LCE	OE	TSE	—	—	—	—	—	—	—	—
Offset + A	—	INT	TS	PINS	IINS	—	—	—	—	—	—	—	—	—	—	—
Offset + C	—	—	—	—	—	—	—	—	—	—	—	—	—	—	—	—
Offset + E	—	—	—	—	—	—	—	—	—	—	—	—	—	—	—	—
Offset + 10	—	—	—	—	—	—	—	—	—	—	—	—	—	—	—	—
Offset + 12	BDU	—	—	—	—	—	—	—	—	—	—	—	—	—	—	—
Offset + 14	1588 timestamp – low halfword															
Offset + 16	1588 timestamp – high halfword															
Offset + 18	—	—	—	—	—	—	—	—	—	—	—	—	—	—	—	—
Offset + 1A	—	—	—	—	—	—	—	—	—	—	—	—	—	—	—	—
Offset + 1C	—	—	—	—	—	—	—	—	—	—	—	—	—	—	—	—
Offset + 1E	—	—	—	—	—	—	—	—	—	—	—	—	—	—	—	—

Table 57-35. Enhanced transmit buffer descriptor field definitions

Word	Field	Description
Offset + 0	15–0	Data length, written by user.
	Data Length	Data length is the number of octets the MAC should transmit from this BD's data buffer. It is never modified by the MAC.
Offset + 2	15	Ready. Written by the MAC and you.
	R	0 The data buffer associated with this BD is not ready for transmission. You are free to manipulate this BD or its associated data buffer. The MAC clears this field after the buffer has been transmitted or after an error condition is encountered.

Table continues on the next page...

Table 57-35. Enhanced transmit buffer descriptor field definitions (continued)

Word	Field	Description
		1 The data buffer, prepared for transmission by you, has not been transmitted or currently transmits. You may write no fields of this BD after this field is set.
Offset + 2	14 TO1	Transmit software ownership. This field is reserved for software use. This read/write field is not modified by hardware and its value does not affect hardware.
Offset + 2	13 W	Wrap. Written by user. 0 The next buffer descriptor is found in the consecutive location 1 The next buffer descriptor is found at the location defined in ETDSR.
Offset + 2	12 TO2	Transmit software ownership. This field is reserved for use by software. This read/write field is not modified by hardware and its value does not affect hardware.
Offset + 2	11 L	Last in frame. Written by user. 0 The buffer is not the last in the transmit frame 1 The buffer is the last in the transmit frame
Offset + 2	10 TC	Transmit CRC. Written by user, and valid only when L is set. 0 End transmission immediately after the last data byte 1 Transmit the CRC sequence after the last data byte This field is valid only when the L field is set.
Offset + 2	9 ABC	Append bad CRC. Note: This field is not supported by the uDMA and is ignored.
Offset + 2	8–0	Reserved, must be cleared.
Offset + 4	15–0 Data buffer pointer low	Tx data buffer pointer, low halfword
Offset + 6	15–0 Data buffer pointer high	Tx data buffer pointer, high halfword. The transmit buffer pointer, containing the address of the associated data buffer, must always be evenly divisible by 8. The buffer must reside in memory external to the MAC. This value is never modified by the Ethernet controller.
Offset + 8	15 TXE	Transmit error occurred. This field is written by the uDMA. This field indicates that there was a transmit error of some sort reported with the frame. Effectively this field is an OR of the other error fields including UE, EE, FE, LCE, OE, and TSE. This field is valid only when the L field is set.
Offset + 8	14	Reserved, must be cleared.
Offset + 8	13 UE	Underflow error. This field is written by the uDMA. This field indicates that the MAC reported an underflow error on transmit. This field is valid only when the L field is set.
Offset + 8	12 EE	Excess Collision error. This field is written by the uDMA. This field indicates that the MAC reported an excess collision error on transmit. This field is valid only when the L field is set.
Offset + 8	11 FE	Frame with error. This field is written by the uDMA. This field indicates that the MAC reported that the uDMA reported an error when providing the packet. This field is valid only when the L field is set.
Offset + 8	10 LCE	Late collision error. This field is written by the uDMA. This field indicates that the MAC reported that there was a Late Collision on transmit. This field is valid only when the L field is set.

Table continues on the next page...

Table 57-35. Enhanced transmit buffer descriptor field definitions (continued)

Word	Field	Description
Offset + 8	9 OE	Overflow error. This field is written by the uDMA. This field indicates that the MAC reported that there was a FIFO overflow condition on transmit. This field is only valid when the L field is set.
Offset + 8	8 TSE	Timestamp error. This field is written by the uDMA. This field indicates that the MAC reported a different frame type than a timestamp frame. This field is valid only when the L field is set.
Offset + 8	7–0	Reserved, must be cleared.
Offset + A	15	Reserved, must be cleared.
Offset + A	14 INT	Generate interrupt flags. This field is written by the user. This field is valid regardless of the L field and must be the same for all EBD for a given frame. The uDMA does not update this value.
Offset + A	13 TS	Timestamp. This field is written by the user. This indicates that the uDMA is to generate a timestamp frame to the MAC. This field is valid regardless of the L field and must be the same for all EBD for the given frame. The uDMA does not update this value.
Offset + A	12 PINS	Insert protocol specific checksum. This field is written by the user. If set, the MAC's IP accelerator calculates the protocol checksum and overwrites the corresponding checksum field with the calculated value. The checksum field must be cleared by the application generating the frame. The uDMA does not update this value. This field is valid regardless of the L field and must be the same for all EBD for a given frame.
Offset + A	11 IINS	Insert IP header checksum. This field is written by the user. If set, the MAC's IP accelerator calculates the IP header checksum and overwrites the corresponding header field with the calculated value. The checksum field must be cleared by the application generating the frame. The uDMA does not update this value. This field is valid regardless of the L field and must be the same for all EBD for a given frame.
Offset + A	10–0	Reserved, must be cleared.
Offset + C	15–0	Reserved, must be cleared.
Offset + E	15–0	Reserved, must be cleared.
Offset + 10	15–0	Reserved, must be cleared.
Offset + 12	15 BDU	Last buffer descriptor update done. Indicates that the last BD data has been updated by uDMA. This field is written by the user (=0) and uDMA (=1).
Offset + 12	14–0	Reserved, must be cleared.
Offset + 14	15–0	This value is written by the uDMA . It is valid only when the L field is set.
Offset + 16	1588 timestamp	
Offset + 18–Offset + 1E	15–0	Reserved, must be cleared.

57.6.15 Client FIFO application interface

The FIFO interface is completely asynchronous from the Ethernet line, and the transmit and receive interface can operate at a different clock rate.

All transfers to/from the user application are handled independently of the core operation, and the core provides a simple interface to user applications based on a two-signal handshake.

57.6.15.1 Data structure description

The data structure defined in the following tables for the FIFO interface must be respected to ensure proper data transmission on the Ethernet line. Byte 0 is sent to and received from the line first.

Table 57-36. FIFO interface data structure

	63	56 55	48 47	40 39	32 31	24 23	16 15	8 7	0
Word 0	Byte 7	Byte 6	Byte 5	Byte 4	Byte 3	Byte 2	Byte 1	Byte 0	
Word 1	Byte 15	Byte 14	Byte 13	Byte 12	Byte 11	Byte 10	Byte 9	Byte 8	
...	...								

The size of a frame on the FIFO interface may not be a modulo of 64-bit.

The user application may not care about the Ethernet frame formats in full detail. It needs to provide and receive an Ethernet frame with the following structure:

- Ethernet MAC destination address
- Ethernet MAC source address
- Optional 802.1q VLAN tag (VLAN type and info field)
- Ethernet length/type field
- Payload

Frames on the FIFO interface do not contain preamble and SFD fields, which are inserted and discarded by the MAC on transmit and receive, respectively.

- On receive, CRC and frame padding can be stripped or passed through transparently.
- On transmit, padding and CRC can be provided by the user application, or appended automatically by the MAC independently for each frame. No size restrictions apply.

Note

On transmit, if ENET n _TCR[ADDINS] is set, bytes 6–11 of each frame can be set to any value, since the MAC overwrites the bytes with the MAC address programmed in the ENET n _PAUR and ENET n _PALR registers.

Table 57-37. FIFO interface frame format

Byte number	Field
0–5	Destination MAC address
6–11	Source MAC address
12–13	Length/type field
14–N	Payload data

VLAN-tagged frames are supported on both transmit and receive, and implement additional information (VLAN type and info).

Table 57-38. FIFO interface VLAN frame format

Byte number	Field
0–5	Destination MAC address
6–11	Source MAC address
12–15	VLAN tag and info
16–17	Length/type field
18–N	Payload data

Note

The standard defines that the LSB of the MAC address is sent/received first, while for all the other header fields — in other words, length/type, VLAN tag, VLAN info, and pause quanta — the MSB is sent/received first.

57.6.15.2 Data structure examples

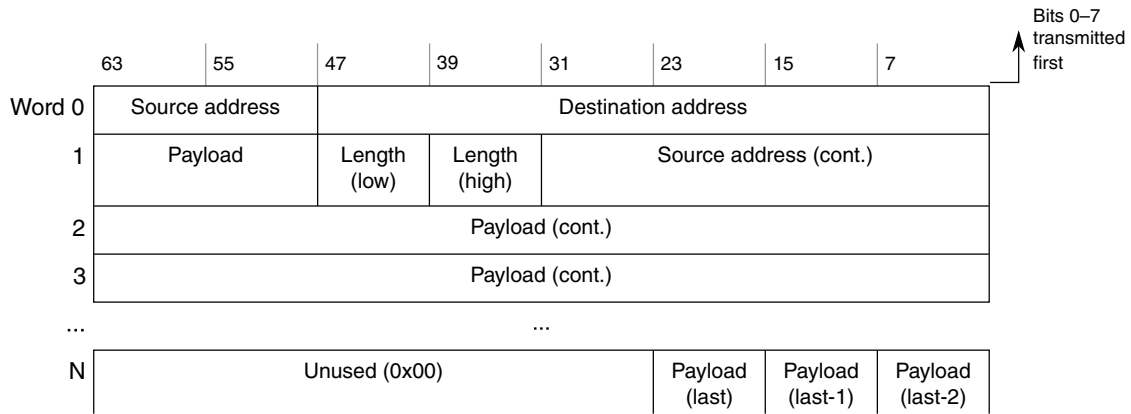

Figure 57-14. Normal Ethernet frame 64-bit mapping example

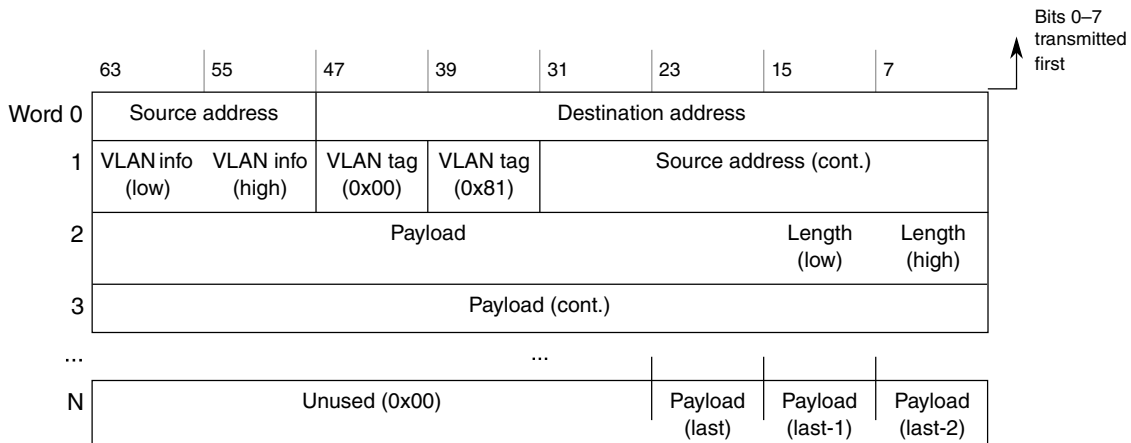

Figure 57-15. VLAN-tagged frame 64-bit mapping example

If CRC forwarding is enabled (CRCFWD = 0), the last four valid octets of the frame contain the FCS field. The non-significant bytes of the last word can have any value.

57.6.15.3 Frame status

A MAC layer status word and an accelerator status word is available in the receive buffer descriptor.

The status is available with each frame with the last data of the frame.

If the frame status contains a MAC layer error (for example, CRC or length error), RxBD[ME] is also set with the last data of the frame.

57.6.16 FIFO protection

57.6.16.1 Transmit FIFO underflow

During a frame transfer, when the transmit FIFO reaches the almost empty threshold with no end-of-frame indication stored in the FIFO, the MAC logic:

- Stops reading data from the FIFO
- Asserts the MII error signal (MII_TXER) (1 in Figure 57-16) to indicate that the fragment already transferred is not valid
- Deasserts the MII transmit enable signal (MII_TXEN) to terminate the frame transfer (2)

After an underflow, when the application completes the frame transfer (3), the MAC transmit logic discards any new data available in the FIFO until the end of packet is reached (4) and sets the enhanced TxBD[UE] field.

The MAC starts to transfer data on the MII interface when the application sends a new frame with a start of frame indication (5).

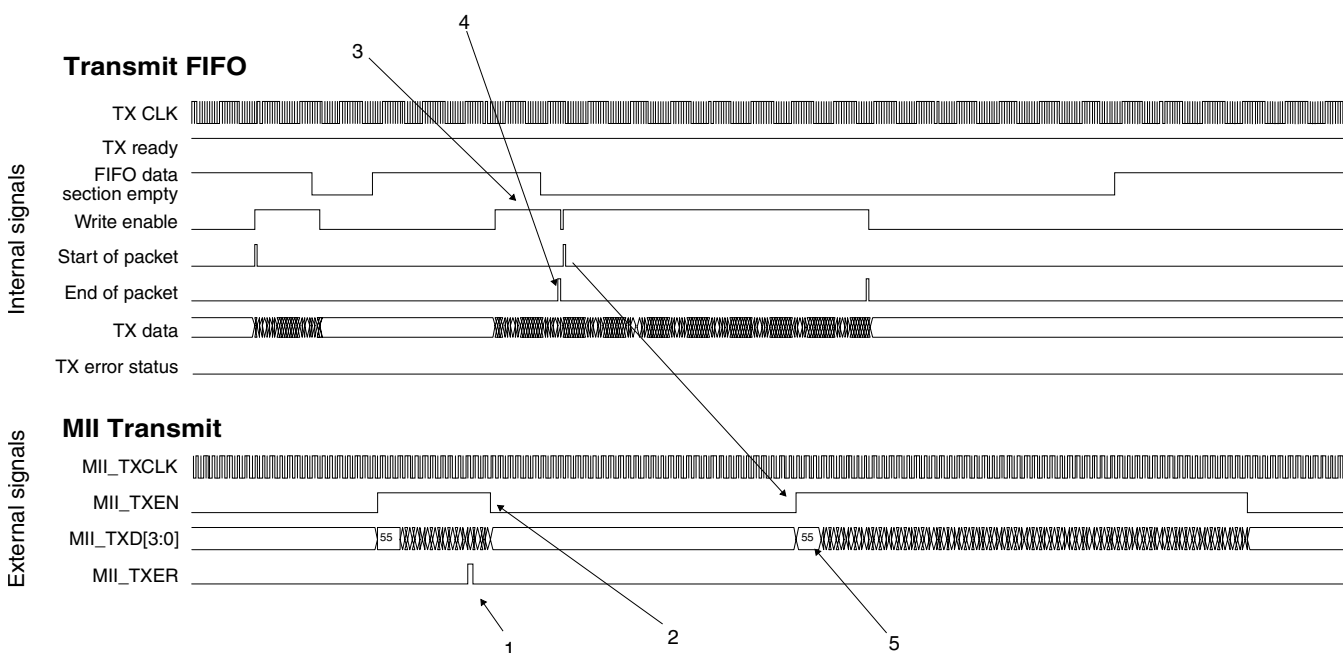

Figure 57-16. Transmit FIFO underflow protection

57.6.16.2 Transmit FIFO overflow

On the transmit path, when the FIFO reaches the programmable almost full threshold, the internal MAC ready signal is deasserted. The application should stop sending new data.

However, if the application keeps sending data, the transmit FIFO overflows, corrupting contents that were previously stored. The core logic sets the enhanced TxBD[OE] field for the next frame transmitted to indicate this overflow occurrence.

Note

Overflow is a fatal error and must be addressed by resetting the core or clearing ENET n _ECR[ETHER_EN], to clear the FIFOs and prepare for normal operation again.

57.6.16.3 Receive FIFO overflow

During a frame reception, if the client application is not able to receive data (1), the MAC receive control truncates the incoming frame when the FIFO reaches the programmable almost-full threshold to avoid an overflow.

The frame is subsequently received on the FIFO interface with an error indication (enhanced RxBd[ME] field set together with receive end-of-packet) (2) with the truncation error status field set (3).

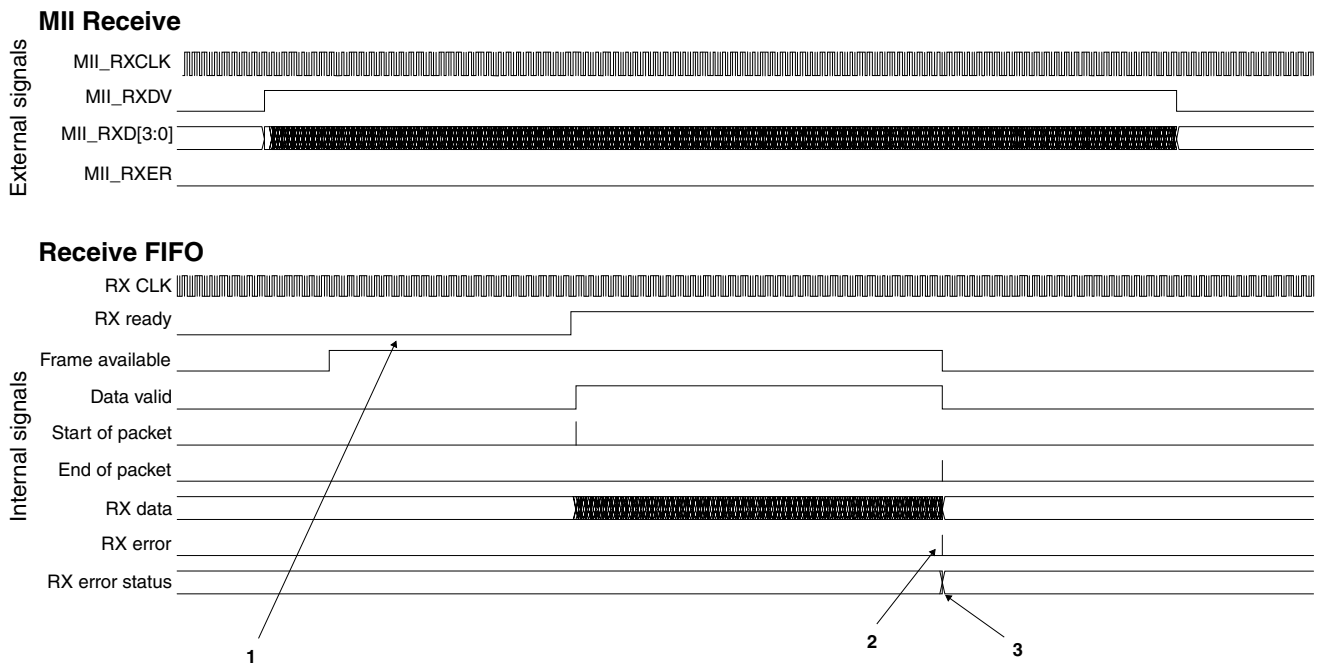

Figure 57-17. Receive FIFO overflow protection

57.6.17 Reference clock

The input clocks to the ENET module must meet the specifications in the following table.

Functional description

Ethernet speed mode	Ethernet bus clock	Minimum ENET system clock
10 Mbit/s	2.5 MHz	5 MHz
100 Mbit/s	25.0 MHz	50 MHz

57.6.18 PHY management interface

The MDIO interface is a two-wire management interface. The MDIO management interface implements a standardized method to access the PHY device management registers.

The core implements a master MDIO interface, which can be connected to up to 32 PHY devices.

57.6.18.1 MDIO clause 22 frame format

The core MDIO master controller communicates with the slave (PHY device) using frames that are defined in the following table.

A complete frame has a length of 64 bits made up of an optional 32-bit preamble, 14-bit command, 2-bit bus direction change, and 16-bit data. Each bit is transferred on the rising edge of the MDIO clock (MDC signal). The MDIO data signal is tri-stated between frames.

The core PHY management interface supports the standard MDIO specification (IEEE 802.3 Clause 22).

Table 57-39. MDIO clause 22 frame structure

ST	OP	PHYADR	REGADR	TA	DATA
----	----	--------	--------	----	------

Table 57-40. MDIO frame field descriptions

Field	Description
ST (2 bits)	Start indication field, programmed with ENET n _MMFR[ST] and equal to 01 for Standard MDIO (Clause 22).
OP (2 bits)	Opcode defines type of operation. Programmed with ENET n _MMFR[OP]. 01 Write operation 10 Read operation
PHYADR (5 bits)	Five-bit PHY device address, programmed with ENET n _MMFR[PA]. Up to 32 devices can be addressed.

Table continues on the next page...

Table 57-40. MDIO frame field descriptions (continued)

Field	Description
REGADR (5 bits)	Five-bit register address, programmed with ENET _n _MMFR[RA]. Each PHY can implement up to 32 registers.
TA (2 bits)	Turnaround time, programmed with ENET _n _MMFR[TA]. Two bit-times are reserved for read operations to switch the data bus from write to read. The PHY device presents its register contents in the data phase and drives the bus from the second bit of the turnaround phase.
Data (16 bits)	Data, set by ENET _n _MMFR[DATA]. Written to or read from the PHY

57.6.18.2 MDIO clause 45 frame format

The extended MDIO frame structure defined in IEEE 802.3 Clause 45 introduces indirect addressing. First, a write transaction to an address register is done, followed by a write or read transaction which will put the 16-bit data in the register or retrieve the register contents respectively. A preamble of 32 bits of logical ones is sent prior to every transaction. The MDIO data signal is tri-stated between frames.

The extended MDIO defines four transactions, which are determined by the two-bit opcode field.

Table 57-41. MDIO clause 45 frame structure

ST	OP	PRTAD	DEVAD	TA	ADDR/DATA
----	----	-------	-------	----	-----------

All bits are transmitted from left to right (Preamble bits first) and all fields have their Most-Significant bit sent first (leftmost in above table). The complete frame has a length of 64 bits (32-bit preamble, 14-bit command, 2-bit bus direction change, 16-bit data). Each bit is transferred with the rising edge of the MDIO clock (MDC).

The fields and transactions are summarized in the following tables.

Table 57-42. MDIO clause 45 frame field descriptions

Field	Description
ST	Start indication. Indicates the end of the preamble and start of the frame. This value is 00 for extended MDIO (Clause 45) frames.
OP	Opcode defines if a read or write operation is performed and is programmed with ENET _n _MMFR[OP]. See Table 57-43 for more information. 00 Address write 01 Write operation 10 Read inc. operation

Table continues on the next page...

Table 57-42. MDIO clause 45 frame field descriptions (continued)

Field	Description
	11 Read operation
PRTAD	The port address specifies a MDIO port. Each Port can have up to 32 devices which each can have a separate set of registers.
DEVAD	Device address. Up to 32 devices can be addressed (within a port).
TA	Turnaround time, programmed with ENET n _MMFR[TA]. Two bit-times are reserved for read operations to switch the data bus from write to read. The PHY device presents its register contents in the data phase and drives the bus from the second bit of the turnaround phase.
ADDR/DATA	16-bit address (for address write) or data, set by ENET n _MMFR[DATA], written to or read from the PHY.

Table 57-43. MDIO Clause 45 Transactions

Transaction Type	Description
Address	A write transaction to the internal address register of the device/port. The data section of the frame contains the value to be stored in the device's internal address "pointer" register for further transactions.
Write	Data write to a register. The 16 bit data will be written to the register identified by the device-internal address.
Read	Data is read from the register identified by the device-internal address.
Read inc.	Read with address postincrement. The register identified by the device-internal address is read. After this, the device-internal address is incremented. If the address register is all '1' (0xFFFF) no increment is done (i.e. increment does not wrap around).

57.6.18.3 MDIO clock generation

The MDC clock is generated from the internal bus clock (i.e., IPS bus clock) divided by the value programmed in ENET n _MSCR[MII_SPEED].

57.6.18.4 MDIO operation

To perform an MDIO access, set the MDIO command register (ENET n _MMFR) according to the description provided in MII Management Frame Register (ENET n _MMFR).

To check when the programmed access completes, read the ENET n _EIR[MII] field.

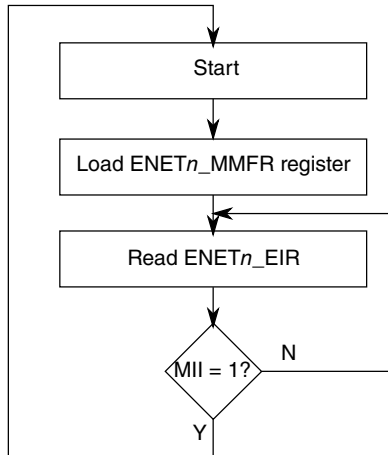

Figure 57-18. MDIO access overview

57.6.19 Ethernet interfaces

The following Ethernet interfaces are implemented:

- Fast Ethernet MII (Media Independent Interface)
- RMII 10/100 using interface converters/gaskets

The following table shows how to configure ENET registers to select each interface.

Mode	RCR[RMII_10T]	RCR[RMII_MODE]
MII - 10 Mbit/s	—	0
MII - 100 Mbit/s	—	0
RMII - 10 Mbit/s	1	1
RMII - 100 Mbit/s	0	1

57.6.19.1 RMII interface

In RMII receive mode, for normal reception following assertion of CRS_DV, RXD[1:0] is 00 until the receiver determines that the receive event has a proper start-of-stream delimiter (SSD).

Functional description

The preamble appears (RXD[1:0]=01) and the MACs begin capturing data following detection of SFD.

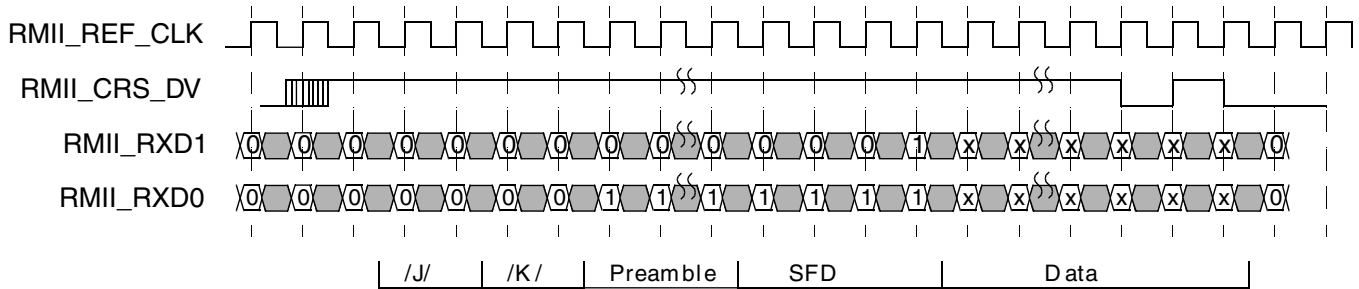

Figure 57-19. RMIi receive operation

If a false carrier is detected (bad SSD), then RXD[1:0] is 10 until the end of the receive event. This is a unique pattern since a false carrier can only occur at the beginning of a packet where the preamble is decoded (RXD[1:0] = 01).

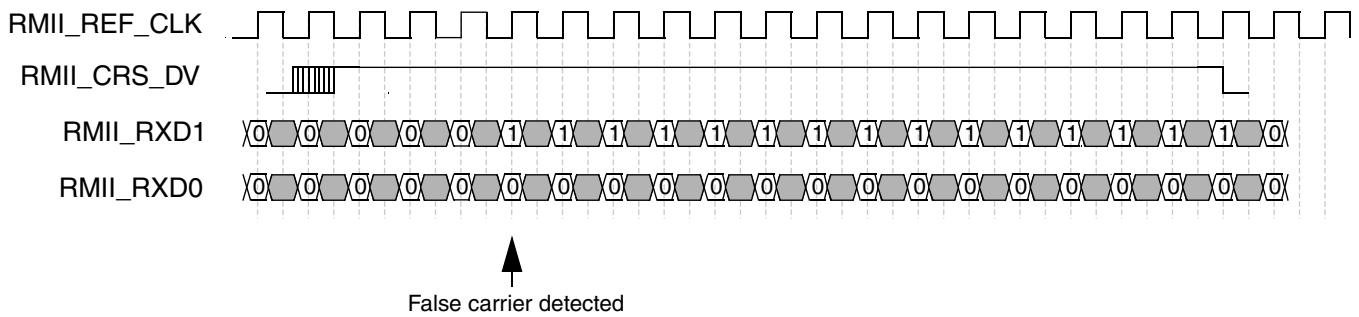

Figure 57-20. RMIi receive operation with false carrier

In RMIi transmit mode, TXD[1:0] provides valid data for each REF_CLK period while TXEN is asserted.

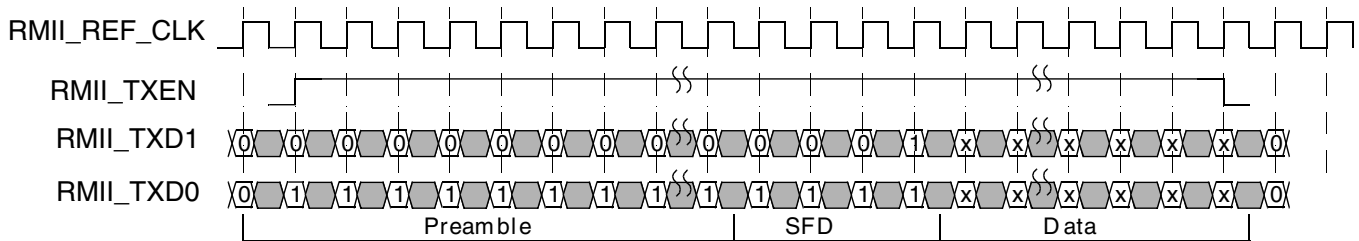

Figure 57-21. RMIi transmit operation

57.6.19.2 MII Interface — transmit

On transmit, all data transfers are synchronous to MII_TXCLK rising edge. The MII data enable signal MII_TXEN is asserted to indicate the start of a new frame, and remains asserted until the last byte of the frame is present on the MII_TXD[3:0] bus.

Between frames, MII_TXEN remains deasserted.

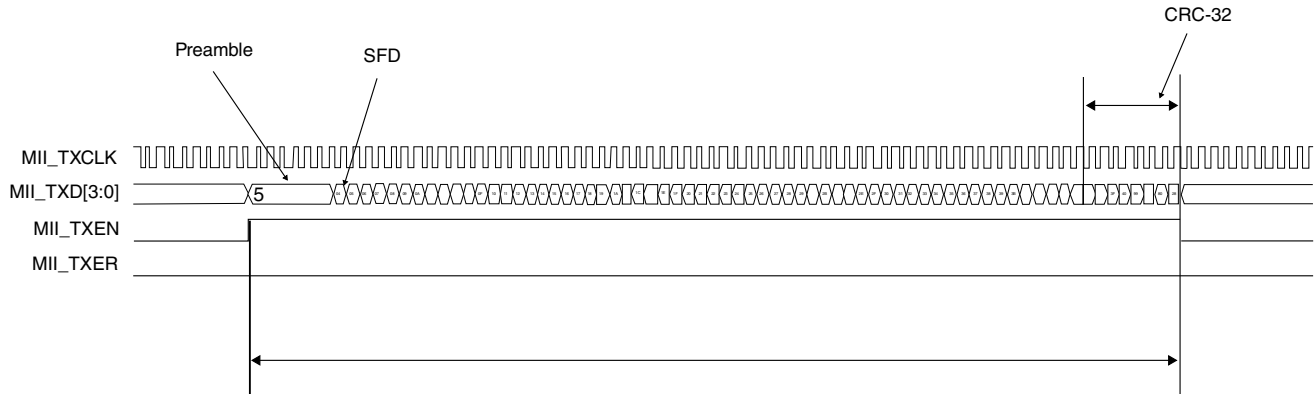

Figure 57-22. MII transmit operation

If a frame is received on the FIFO interface with an error (for example, RxBDF[ME] set) the frame is subsequently transmitted with the MII_TXER error signal for one clock cycle at any time during the packet transfer.

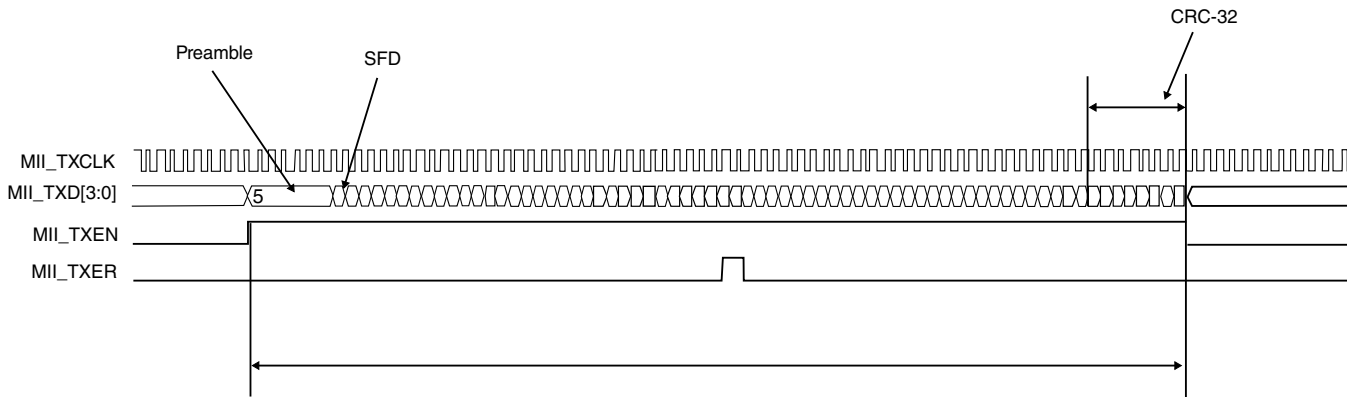

Figure 57-23. MII transmit operation — errored frame

57.6.19.2.1 Transmit with collision — half-duplex

When a collision is detected during a frame transmission (MII_COL asserted), the MAC stops the current transmission, sends a 32-bit jam pattern, and re-transmits the current frame.

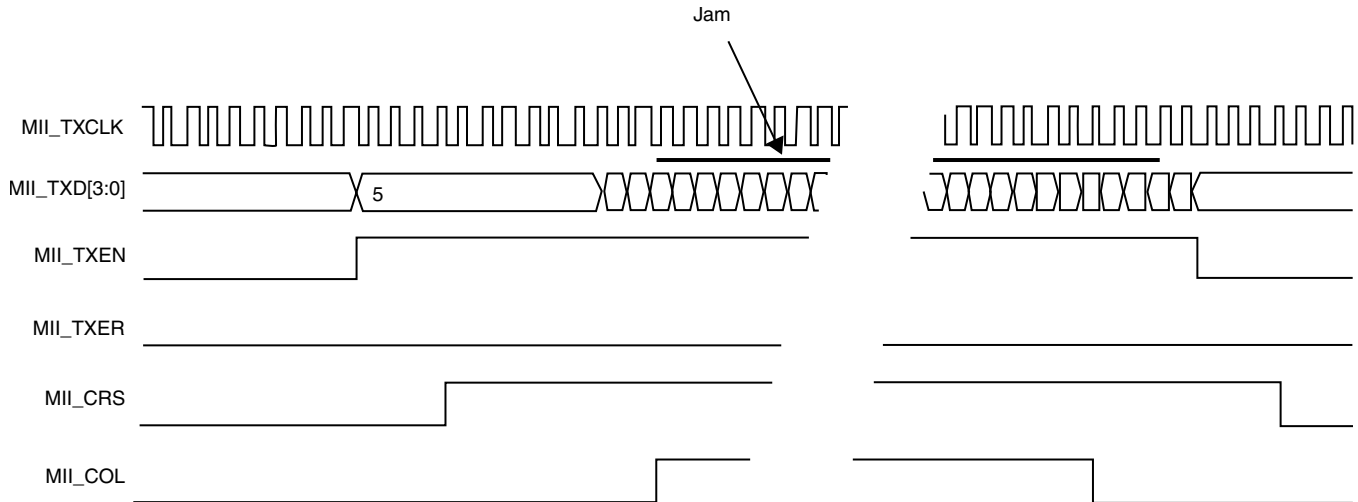

Figure 57-24. MII transmit operation — transmission with collision

57.6.19.3 MII interface — receive

On receive, all signals are sampled on the MII_RXCLK rising edge. The MII data enable signal, MII_RXDV, is asserted by the PHY to indicate the start of a new frame and remains asserted until the last byte of the frame is present on MII_RXD[3:0] bus.

Between frames, MII_RXDV remains deasserted.

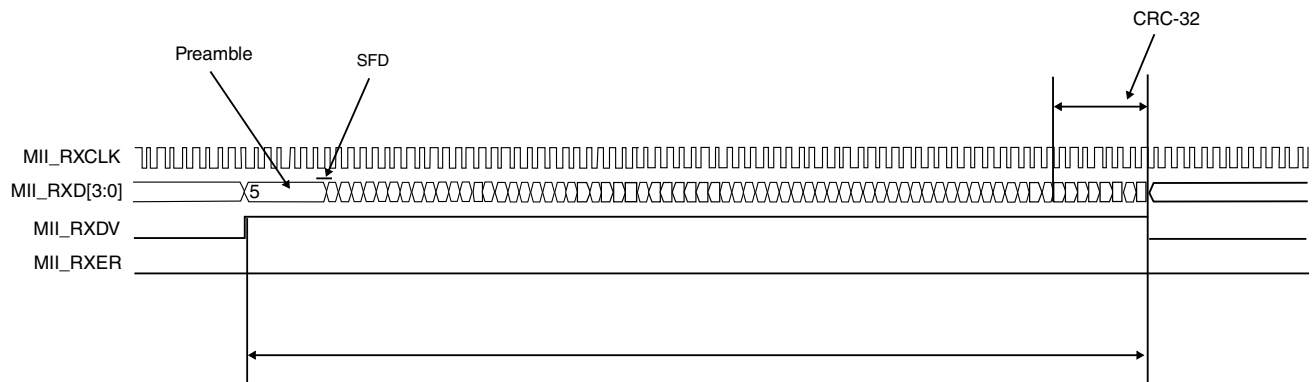

Figure 57-25. MII receive operation

If the PHY detects an error on the frame received from the line, the PHY asserts the MII error signal, MII_RXER, for at least one clock cycle at any time during the packet transfer.

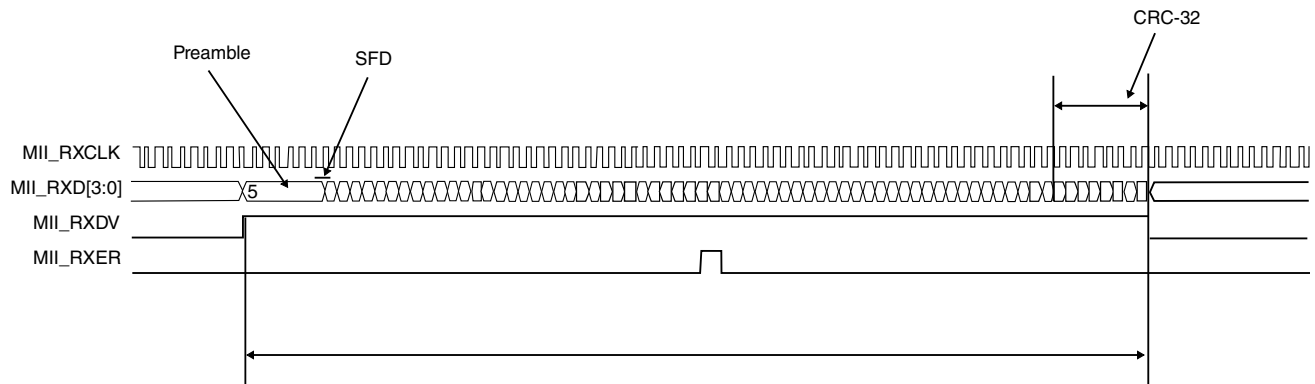

Figure 57-26. MII receive operation — errored frame

A frame received on the MII interface with a PHY error indication is subsequently transferred on the FIFO interface with RxBD[ME] set.

Chapter 58

Debug

58.1 Introduction

The debug capability on this device is based on the Arm CoreSight™ architecture and is configured on each device to provide the maximum flexibility as allowed by the restrictions of the pinout and other available resources.

Table 58-1. Supported debug interfaces

Chip	Supported debug interfaces			
	IEEE 1149.1 JTAG	Serial Wire Debug(SWD)	SWO	4-pin parallel trace port ¹
S32K116	No ²	Yes	No	No ³
S32K118	No ²	Yes	No	No ³
S32K142	Yes	Yes	Yes	No
S32K144 and S32K144W	Yes	Yes	Yes	No
S32K146	Yes	Yes	Yes	No
S32K148	Yes	Yes	Yes	Yes

1. Overrides the value of Supported Port Size Register of TPIU (at location 0x000)
2. JTAG protocol available only for Boundary Scan
3. 1 KB of MTB RAM present to store trace data

The basic Cortex debug architecture is very flexible. The following diagrams shows the topology of the core debug architecture and its components.

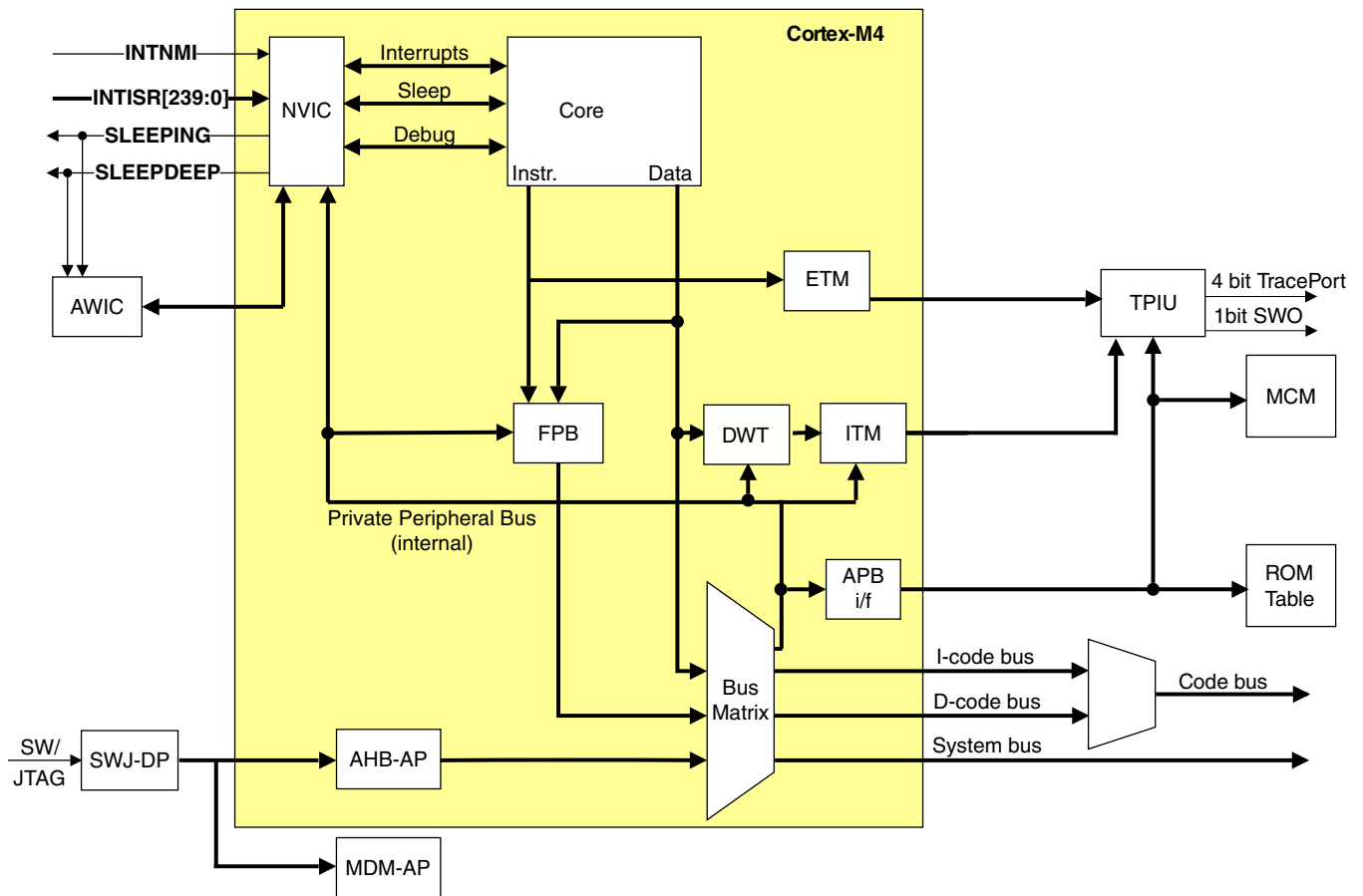

Figure 58-1. Cortex-M4 debug topology

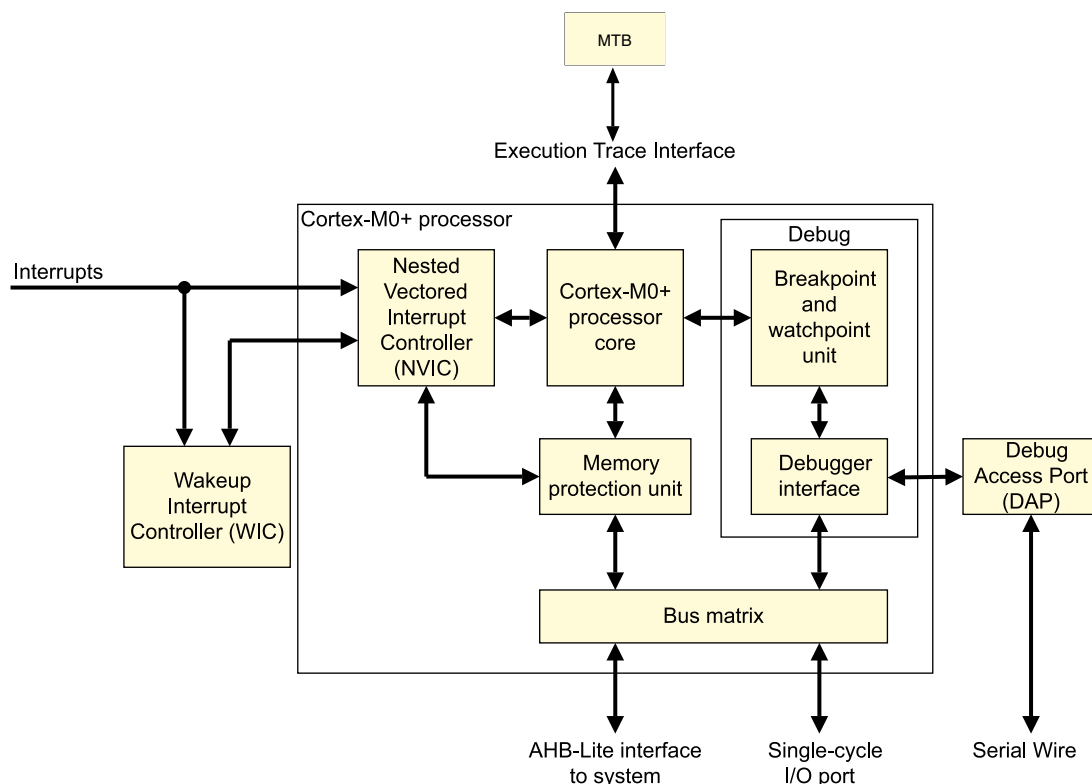

Figure 58-2. Cortex-M0+ debug topology

The following table presents a brief description of each of the debug components.

Table 58-2. Debug components description

Module	Description
SWJ-DP (Serial Wire and JTAG - Debug Port)	Modified Debug Port with support for SWD, JTAG
AHB-AP (AMBA High-performance Bus - Access Port)	AHB Master Interface from JTAG to debug module and SOC system memory maps
MDM-AP (Miscellaneous Debug Module - Access Port)	Provides centralized control and status registers for an external debugger to control the device.
ROM Table	Identifies which debug IP is available.
Core Debug	Singlestep, Register Access, Run, Core Status
ITM (Instruction Trace Macrocell)	S/W Instrumentation Messaging + Simple Data Trace Messaging + Watchpoint Messaging
ETM (Embedded Trace Macrocell)	Used for instruction trace
DWT (Data and Address Watchpoints)	4 data and address watchpoints
FPB (Flash Patch and Breakpoints)	<p>The FPB implements hardware breakpoints and patches code and data from code space to system space.</p> <p>The FPB unit contains two literal comparators for matching against literal loads from Code space, and remapping to a corresponding area in System space.</p> <p>The FPB also contains six instruction comparators for matching against instruction fetches from Code space, and remapping to a corresponding area in System space. Alternatively, the six instruction comparators can</p>

Table continues on the next page...

Table 58-2. Debug components description (continued)

Module	Description
	individually configure the comparators to return a Breakpoint Instruction (BKPT) to the processor core on a match, providing hardware breakpoint capability.
Breakpoint and Watchpoint unit	2 hardware breakpoints available
TPIU (Trace Port Interface Unit)	Asynchronous Mode (1-pin) = TRACE_SWO (available on JTAG_TDO). Supports 4 pin trace output and a single pin SWO.
MTB	Logs trace information of JUMP instructions and stores it in MTB RAM.

58.2 CM4 and CM0+ ROM table

The ROM table is used to hold the information about the debug components.

Table 58-3. Bit assignments in the ROM table

Bits	Name	Description
[31:12]	Address offset	Base address of the component, relative to the ROM address. Negative values are permitted using two's complement. ComponentAddress = ROMAddress + (AddressOffset SHL 12).
[11:2]	-	Reserved SBZ.
[1]	Format	1 = 32-bit format. In the DAP Debug ROM this is set to 1. 0 = 8-bit format.
[0]	Entry present	Set HIGH to indicate an entry is present.

Table 58-4. CM4 ROM table

Component	Base address
SCS	0xE000E000
DWT	0xE0001000
FPB	0xE0002000
ITM	0xE0000000
TPIU + SWO	0xE0040000
ETM ¹	0xE0041000

1. Present in S32K148 variant only

Table 58-5. CM0+ ROM table

Component	Base address
MTB	0xF0000000
MTB_DWT	0xF0001000

Table continues on the next page...

Table 58-5. CM0+ ROM table (continued)

Component	Base address
CM0 + SCU	0xE000E000
CM0 + DWT	0xE0001000
CM0 + BPU	0xE0002000

58.3 Debug port

The configuration of the JTAG controller, and debug port, is illustrated in the following figure.

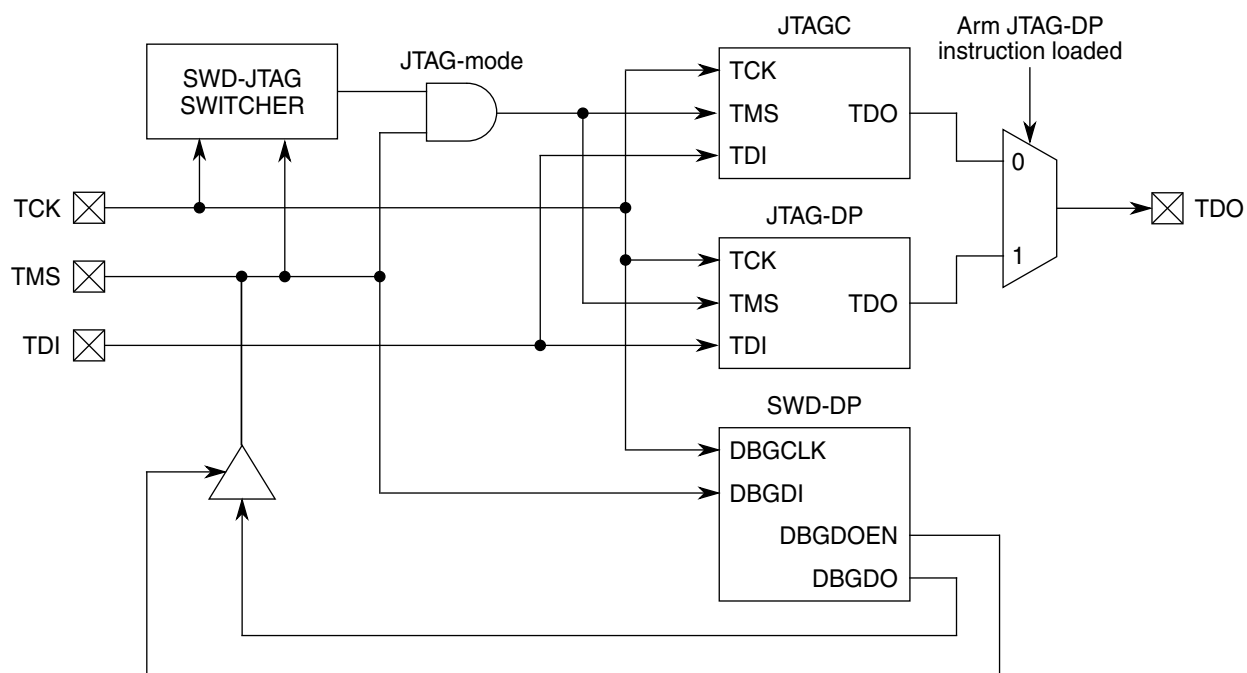

Figure 58-3. Modified debug port for CM4 core

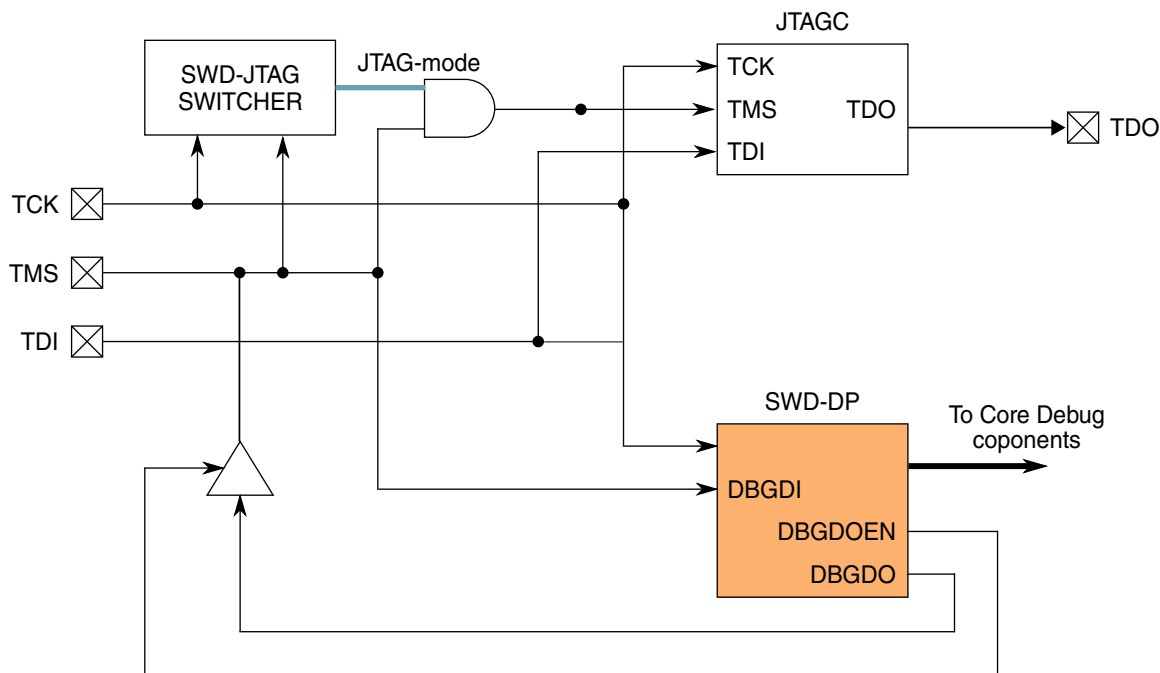

Figure 58-4. Modified debug port for CM0+ core

The debug port comes out of reset in standard JTAG mode and is switched into SWD mode by the following sequences. Once the mode has been changed, unused debug pins can be reassigned to any of their alternative muxed functions.

NOTE

AP Abort command is not supported in S32K11x. For stalled AP transaction, reset needs to be issued.

58.3.1 JTAG-to-SWD change sequence

1. Send more than 50 TCK cycles with TMS (SWDIO) =1
2. Send the 16-bit sequence on TMS (SWDIO) = 0111_1001_1110_0111 (MSB transmitted first)
3. Send more than 50 TCK cycles with TMS (SWDIO) =1

NOTE

See the Arm documentation for the CoreSight DAP Lite for restrictions.

58.4 Debug port pin descriptions

After POR, all debug port pins default to their JTAG functionality and can later be reassigned to their alternate functionalities. In SWD mode, JTAG_TDI can be configured for alternate GPIO functions.

Table 58-6. Debug port pins

Pin name	JTAG debug port		SWD debug port		Internal pull-up/down
	Type	Description	Type	Description	
JTAG_TMS/ SWD_DIO	I/O	JTAG Test Mode Selection	I/O	Serial Wire Data	Pull-up
JTAG_TCLK/ SWD_CLK	I	JTAG Test Clock	I	Serial Wire Clock	Pull-down
JTAG_TDI	I	JTAG Test Data Input	-	-	Pull-up
JTAG_TDO/ TRACE_SWO	O	JTAG Test Data Output	O	Trace output over a single pin	N/C

58.5 System TAP connection

The system JTAG controller is connected in parallel to the Arm Test Access Port (TAP) controller. The system JTAG controller Instruction Register (IR) codes overlay the Arm JTAG controller IR codes without conflict. Refer to the IR codes table for a list of the available IR codes. The output of the TAPs (TDO) are muxed based on the IR code which is selected. This design is fully JTAG compliant and appears to the JTAG chain as a single TAP. At power on reset, Arm's IDCODE (IR = 1110b) is selected.

58.5.1 IR codes

Table 58-7. JTAG instructions

Instruction	Code[3:0]	Instruction summary
IDCODE ¹	0000	Selects device identification register for shift
SAMPLE/PRELOAD	0010	Selects boundary scan register for shifting, sampling, and preloading without disturbing functional operation
SAMPLE	0011	Selects boundary scan register for shifting and sampling without disturbing functional operation
EXTEST	0100	Selects boundary scan register while applying preloaded values to output pins and asserting functional reset

Table continues on the next page...

Table 58-7. JTAG instructions (continued)

Instruction	Code[3:0]	Instruction summary
HIGHZ	1001	Selects bypass register while three-stating all output pins and asserting functional reset
CLAMP	1100	Selects bypass register while applying preloaded values to output pins and asserting functional reset
Arm_IDCODE ²	1110	Arm JTAG-DP Instruction
BYPASS	1111	Selects bypass register for data operations
Factory debug reserved	0101, 0110, 0111, 1101	Intended for factory debug only
Arm JTAG-DP Reserved ²	1000, 1010, 1011, 1110	These instructions will go the Arm JTAG-DP controller. Please see the Arm JTAG-DP documentation for more information on these instructions.
Reserved ³	All other opcodes	Decoded to select bypass register

1. Device IDCODE can only be read in JTAG mode.
2. Reserved for S32K11x variants
3. The manufacturer reserves the right to change the decoding of reserved instruction codes in the future

58.6 MDM-AP status and control registers

Through the Arm Debug Access Port (DAP), the debugger has access to the status and control elements, implemented as registers on the DAP bus as shown in [Figure 58-5](#). These registers provide additional control and status for low power mode recovery and typical run-control scenarios. The status register bits also allow the debugger to get updated status of the core without having to initiate a bus transaction across the crossbar switch, thus remaining less intrusive during a debug session.

These DAP control and status registers are not memory mapped within the system memory map and are only accessible via the DAP using JTAG or SWD. The MDM-AP is accessible as Debug Access Port 1 with the available registers shown in the table below.

Table 58-8. MDM-AP register summary

Address	Register	Description
0x0100_0000	Status	See MDM-AP Status Register
0x0100_0004	Control	See MDM-AP Control Register
0x0100_00FC	ID	Read-only identification register that always reads as 0x001C_0000 ¹

1. This value is applicable only for S32K14x devices.

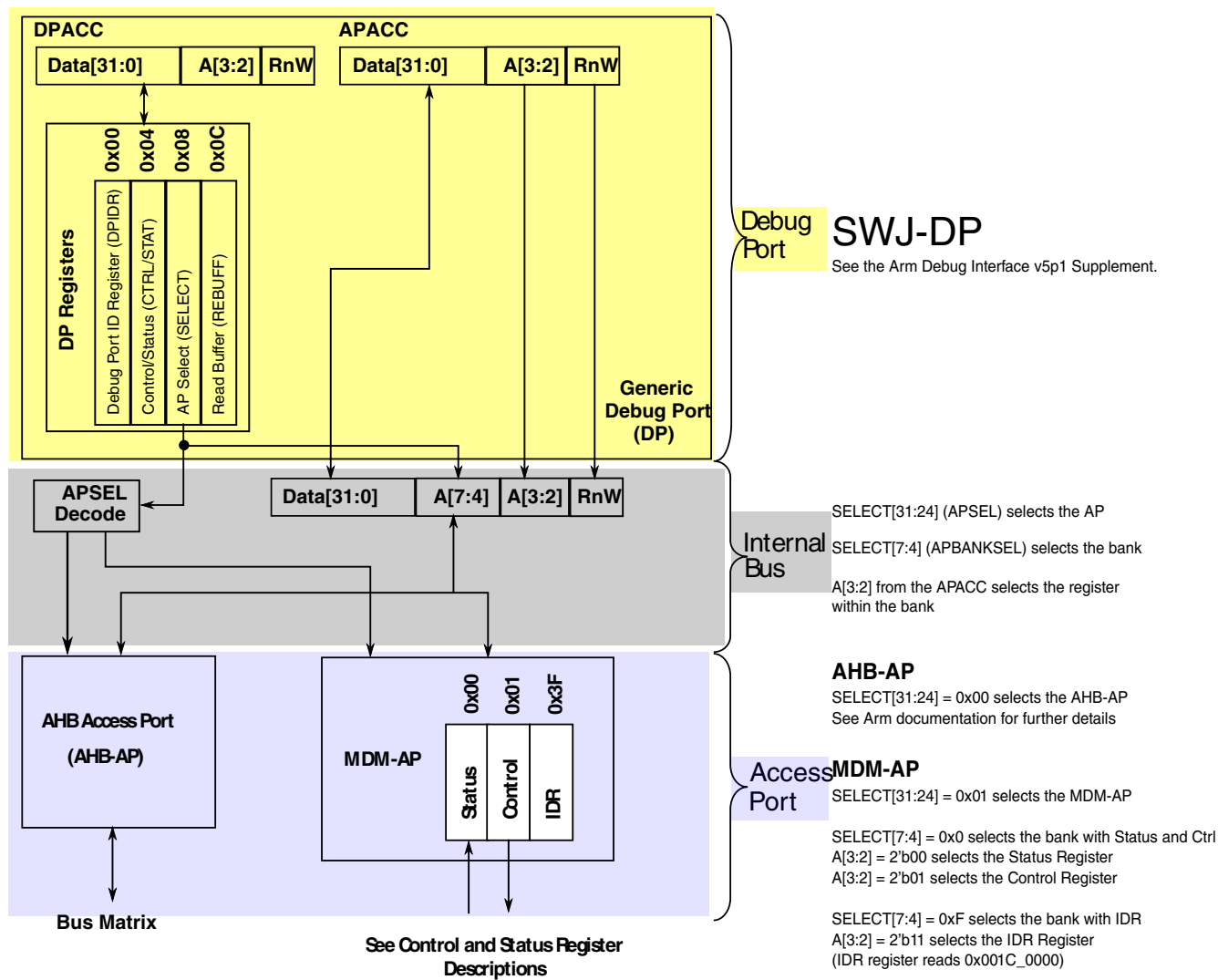

Figure 58-5. MDM AP addressing

58.6.1 MDM-AP Control Register

Table 58-9. MDM-AP Control Register assignments

Bit	Name	Command available in secure mode?	Description
0	Flash memory mass erase in progress	Yes	Set to cause mass erase. Cleared by hardware after mass erase operation completes. When mass erase is disabled (via MEEN and SEC settings), the erase request does not occur and the Flash Mass Erase in Progress bit continues to assert until the next system reset.
1	Debug disable	No	Set to disable debug. Clear to allow debug operation.
2	Debug request	No	Set to force the core to halt.

Table continues on the next page...

Table 58-9. MDM-AP Control Register assignments (continued)

Bit	Name	Command available in secure mode?	Description
			If the core is in a stop mode, this bit can be used to wake up the core and transition to a halted state.
3	System reset request	No	Set to force a system reset. The system remains held in reset until this bit is cleared.
4	Core hold reset	No	Configuration bit to control core operation at the end of system reset sequencing. 0: Normal operation - Release the core from reset along with the rest of the system at the end of system reset sequencing. 1: Suspend operation - Hold the core in reset at the end of reset sequencing. After the system enters this suspended state, clearing this control bit immediately releases the core from reset and CPU operation begins.
5 – 7	Reserved	No	
8	Timestamp disable ¹	No	Set this bit to disable the 48-bit global trace timestamp counter during debug halt mode when the core is halted. 0: The timestamp counter continues to count assuming trace is enabled. (default) 1: The timestamp counter freezes when the core has halted (debug halt mode).
9 – 31	Reserved for future use	No	

1. Reserved for S32K11x variants

58.6.2 MDM-AP Status Register

Table 58-10. MDM-AP Status Register assignments

Bit	Name	Description
0	Flash memory mass erase acknowledge	This bit is cleared on debug reset. The bit is also cleared at the launch of a mass erase command due to writing the Mass Erase in Progress bit in the MDM AP Control Register. This bit is set after the flash memory control logic has started the mass erase operation. When mass erase is disabled (via MEEN and SEC settings), an erase request due to setting the bit is not acknowledged.
1	Flash memory ready	Indicates flash memory has been initialized and the debugger can be configured even if the system is continuing to be held in reset via the debugger.
2	System security	Indicates the security state. When secure, the debugger does not have access to the system bus or any memory mapped peripherals. This bit indicates when the part is locked and no system bus access is possible.
3	System reset	Indicates the system reset state. 0: System is in reset 1: System is not in reset

Table continues on the next page...

Table 58-10. MDM-AP Status Register assignments (continued)

Bit	Name	Description
4	Reserved	
5	Mass erase enable	Indicates whether the MCU can be mass erased 0: Mass erase is disabled 1: Mass erase is enabled
6	Backdoor access key enable	Indicates whether the MCU has the backdoor access key enabled. See the FTFE_FSEC[KEYEN] bit for more information. 0: Disabled 1: Enabled
7	LP enabled	Decode of LPLLSM control bits to indicate that VLPS is the selected power mode the next time the Arm core enters Deep Sleep. 0: Low Power Stop Mode is not enabled 1: Low Power Stop Mode is enabled Usage is intended for debug operation in which Run to VLPS is attempted. Per debug definition, the system actually enters the Stop state. A debugger should interpret deep sleep indication (with SLEEPDEEP and SLEEPING asserted) in conjunction with this bit asserted as the debugger-VLPS status indication.
8	Very low power mode	Indicates current power mode is VLPx. This bit is not 'sticky' and should always represent whether VLPx is enabled or not. This bit is used by the debugger to throttle JTAG TCK frequency up/down.
9 – 10	Reserved	Always reads as 0.
11 – 15	Reserved for future use	Always read as 0.
16	Core halted	Indicates the core has entered debug halt mode
17	Core SLEEPDEEP	Indicates the core has entered a low power mode
18	Core SLEEPING	SLEEPING==1 and SLEEPDEEP==1 indicates stop or VLPS mode.
19 – 31	Reserved for future use	Always reads as 0.

58.7 Debug resets

The debug system receives the following sources of reset:

- Debug reset (CDBGSTREQ bit within the SWJ-DP CTRL/STAT register) in the TCLK domain that allows the debugger to reset the debug logic ¹
- System POR reset

Conversely, the debug system is capable of generating system reset using the following mechanism:

1. This reset is not available in S32K11x variants.

- A system reset in the DAP control register which allows the debugger to hold the system in reset
- SYSRESETREQ bit in the NVIC application interrupt and reset control register

58.8 AHB-AP

AHB-AP provides the debugger access to all memory and registers in the system, including processor registers through the NVIC. System access is independent of the processor status. AHB-AP does not perform back-to-back transactions on the bus, so all transactions are non-sequential. AHB-AP can perform unaligned and bit-band transactions. AHB-AP transactions bypass the FPB, so the FPB cannot remap AHB-AP transactions. SWJ/SW-DP-initiated transaction aborts drive an AHB-AP-supported sideband signal called HABORT. This signal is driven into the Bus Matrix, which resets the Bus Matrix state, so that AHB-AP can access the Private Peripheral Bus for last ditch debugging such as read/stop/reset the core. AHB-AP transactions are little-endian.

The MPU includes default settings and protections for the Region Descriptor 0 (RGD0) such that the Debugger always has access to the entire address space and those rights cannot be changed by the core or any other bus master.

For a short period at the start of a system reset event, the system security status is being determined and debugger access to all AHB-AP transactions is blocked. The MDM-AP Status register is accessible and can be monitored to determine when this initial period is completed. After this initial period, if system reset is held via assertion of the RESET_b pin, the debugger has access via the bus matrix to the private peripheral bus to configure the debug IP even while system reset is asserted. While in system reset, access to other memory and register resources, accessed over the crossbar switch, is blocked.

58.9 ITM

The Instrumentation Trace Macrocell (ITM) is an application-driven trace source that supports printf style debugging to trace operating system and application events, and emits diagnostic system information. The ITM emits trace information as packets. There are four sources that can generate packets. If multiple sources generate packets at the same time, the ITM arbitrates the order in which packets are output. The four sources in decreasing order of priority are:

1. Software trace: Software can write directly to ITM stimulus registers. This emits packets.
2. Hardware trace: The DWT generates these packets, and the ITM emits them.

3. Time stamping: Timestamps are emitted relative to packets. The ITM contains a 21-bit counter to generate the timestamp. The counter is clocked either by the Cortex-M4 clock or by the bit clock rate of the Serial Wire Viewer (SWV) output.
4. Global system timestamping: Timestamps can optionally be generated using a system-wide 48-bit count value.

58.10 Core trace connectivity

Following table provides Core trace connectivity across S32K1xx devices.

Table 58-11. Core Trace Connectivity

Chip	Feature
S32K116, S32K118	Trace data generated by the CM0+ core can be stored in MTB RAM.
S32K142, S32K144, S32K144W, and S32K146	DWT and ITM trace data can be traced out only through SWO interface.
S32K148	DWT, ETM and ITM trace data can be traced out through SWO or 4 pin parallel trace port.

58.11 TPIU

The TPIU is a trace data drain that acts as a bridge between the on-chip trace data to a data stream that is captured by a *Trace Port Analyzer* (TPA).

Table 58-12. S32K14x TPIU

Chip	Feature
S32K16, 118	Not present
S32K142, S32K144, S32K144W, and S32K146	The TPIU in the device supports a limited subset of the full TPIU functionality (only SWO mode), to minimize gatecount for a simple debug solution.
S32K148	For applications which require high trace bandwidth, 4 pin trace interface can be used. SWO mode can be used only in SWD mode as it uses the same pin as JTAG TDO.

Maximum trace clock for SWO is 20 MHz. Maximum trace clock for 4-pin trace interface mapped to:

- Fast pads is 80 MHz
- Slow pads is 20 MHz

This can be configured through [System Clock Divider Register 4 \(CLKDIV4\)](#) register.

58.12 DWT

The DWT provides debug functionality. It contains four comparators, each of which can be configured as a hardware watchpoint, a PC sampler event trigger, or a data address sampler event trigger. The first comparator, DWT_COMP0, can also compare against the clock cycle counter, CYCCNT. The second comparator, DWT_COMP1, can also be used as a data comparator. DWT also contains counters for:

- Clock cycles (CYCCNT)
- Folded instructions
- Load store unit (LSU) operations
- Sleep cycles
- CPI (all instruction cycles except for the first cycle)
- Interrupt overhead

An event is emitted each time a counter overflows.

The DWT can be configured to emit PC samples at defined intervals, and to emit interrupt event information.

NOTE

The MTB_DWT_FCT[FUNCTION]=0100 (i.e. Instruction Fetch) is only valid when DATAVMATCH=0.

58.13 MTB

The Micro Trace Buffer (MTB) provides a simple execution trace capability for the Cortex-M0+ processor. When enabled, the MTB records changes in program flow reported by the Cortex-M0+ processor, via the execution trace interface, into a configurable region of the MTB SRAM. Subsequently, an off-chip debugger may extract the trace information, which would allow reconstruction of an instruction flow trace. The MTB does not include any form of load/store data trace capability or tracing of any other information. In addition to providing the trace capability, the MTB also operates as a simple AHB-Lite SRAM controller. The system bus masters, including the processor, have read/write access to all of the SRAM via the AHB-Lite interface, allowing the memory to be also used to store program and data information. The MTB simultaneously stores the trace information into an attached SRAM and allows bus masters to access the memory. The MTB ensures that trace information write accesses to the SRAM take priority over accesses from the AHB-Lite interface.

The MTB includes trace control registers for configuring and triggering the MTB functions. The MTB also supports triggering via TSTART and TSTOP control functions in the MTB DWT module.

58.14 Debug in low-power modes

In low-power modes, in which the debug modules are kept static or powered off, the debugger cannot gather any debug data for the duration of the low-power mode. In the case that the debugger is held static, the debug port returns to full functionality as soon as the low-power mode exits and the system returns to a state with active debug. In the case that the debugger logic is powered off, the debugger is reset upon recovery and must be reconfigured after the low power mode is exited.

Debug Power Up and System Power Up signals from the debug port are monitored by the power mode entry logic as indications that a debugger is active. These signals can be changed in RUN and VLPR. If the debug signal is active and the system attempts to enter stop or VLPS, FCLK continues to run to support core register access. In these modes in which FCLK is left active, the debug modules have access to core registers but not to system memory resources accessed via the crossbar switch.

With debug enabled, transitions from Run directly to VLPS are not allowed and result in the system entering Stop mode instead. Status bits within the MDM-AP Status register can be evaluated to determine this pseudo-VLPS state. Note that with debug enabled, transitions from Run→VLPR→VLPS are still possible but also result in the system entering Stop mode instead.

58.14.1 Debug module state in low-power modes

The following table shows the state of the debug modules in low power modes. These terms are used:

- FF = Full functionality. In VLPR the system frequency is limited, but if a module does not have a limitation in its functionality, it is still listed as FF.
- static = Module register states and associated memories are retained.
- OFF = Modules are powered off; module is in reset state upon wakeup.

Table 58-13. Debug module state in low-power modes

Module	STOP ¹	VLPR	VLPS
Debug Port	FF	FF	OFF
AHB-AP	FF	FF	OFF

Table continues on the next page...

Table 58-13. Debug module state in low-power modes (continued)

Module	STOP ¹	VLPR	VLPS
ITM	FF	FF	OFF
TPIU	FF	FF	OFF
DWT	FF	FF	OFF
ETM	FF	FF	OFF
MTB	FF	FF	OFF

1. Debugger state in STOP1 and STOP2 is same as in STOP.

58.15 Debug and security

When security is enabled (FSEC[SEC] != 10), the debug port capabilities are limited to prevent exploitation of secure data. In the secure state, the debugger still has access to the MDM-AP Status Register and can determine the current security state of the device. In the case of a secure device, the debugger also has the capability of performing a mass erase operation via writes to the MDM-AP Control Register. In the case of a secure device that has mass erase disabled (FSEC[MEEN] = 10), attempts to mass erase via the debug interface are blocked.

Chapter 59

JTAG Controller (JTAGC)

59.1 Chip-specific JTAGC information

In the JTAGC's [Device identification register](#), the value of the Part Identification Number (PIN) field varies across the products in the S32K1xx series. The following table provides the PIN value for each product.

Table 59-1. JTAG ID register's PIN value

Chip	PIN value
S32K116	0b0100110100
S32K118	0b0100110000
S32K142	0b0100111000
S32K144	0b0100111101
S32K144W	0b0101010100
S32K146	0b0101000100
S32K148	0b0101010000

59.2 Introduction

The JTAGC block provides the means to test chip functionality and connectivity while remaining transparent to system logic when not in test mode. Testing is performed via a boundary scan technique, as defined in the IEEE 1149.1-2001 standard. All data input to and output from the JTAGC block is communicated in serial format.

59.2.1 Block diagram

The following is a simplified block diagram of the JTAG Controller (JTAGC) block. See the chip-specific configuration information as well as [Register description](#) for more information about the JTAGC registers.

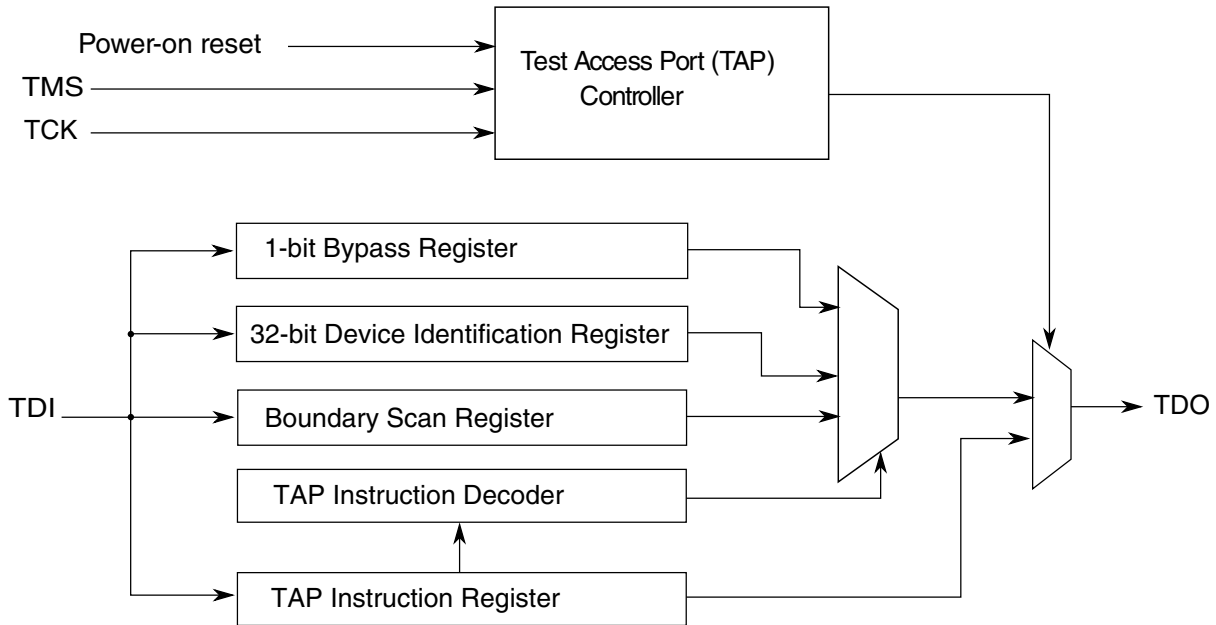

Figure 59-1. JTAG (IEEE 1149.1) block diagram

59.2.2 Features

The JTAGC block is compliant with the IEEE 1149.1-2001 standard, and supports the following features:

- IEEE 1149.1-2001 Test Access Port (TAP) interface
 - Four pins (TDI, TMS, TCK, and TDO)
- Instruction register that supports several IEEE 1149.1–2001 defined instructions as well as several public and private device-specific instructions (see [JTAGC block instructions](#) for a list of supported instructions).
- Bypass register, boundary scan register, and device identification register
- TAP controller state machine that controls the operation of the data registers, instruction register, and associated circuitry

59.2.3 Modes of operation

The JTAGC block uses a power-on reset indication as its primary reset signals. Several IEEE 1149.1–2001 defined test modes are supported, as well as a bypass mode.

59.2.3.1 Reset

The JTAGC block is placed in reset when:

- Power-on reset is asserted
- TMS input is held high for enough consecutive rising edges of TCK to sequence the TAP controller state machine into the Test-Logic-Reset state

Holding TMS high for five consecutive rising edges of TCK guarantees entry into the Test-Logic-Reset state regardless of the current TAP controller state. Asserting power-on reset results in asynchronous entry into the reset state.

When in reset, the following actions occur:

- The TAP controller is forced into the Test-Logic-Reset state, thereby disabling the test logic and allowing normal operation of the on-chip system logic to continue unhindered.
- The instruction register is loaded with the IDCODE instruction.

59.2.3.2 IEEE 1149.1–2001 defined test modes

The JTAGC block supports several IEEE 1149.1–2001 defined test modes. A test mode is selected by loading the appropriate instruction into the instruction register when the JTAGC is enabled. Supported test instructions include EXTEST, HIGHZ, CLAMP, SAMPLE, and SAMPLE/PRELOAD.

Each instruction defines the set of data register(s) that may operate and interact with the on-chip system logic when the instruction is current. Only one test data register path is enabled to shift data between TDI and TDO for each instruction.

The boundary scan register is enabled for serial access between TDI and TDO when the EXTEST, SAMPLE, or SAMPLE/PRELOAD instructions are active. The single-bit bypass register shift stage is enabled for serial access between TDI and TDO when the following instructions are active:

- BYPASS
- HIGHZ
- CLAMP

The functionality of each test mode is explained in more detail in [JTAGC block instructions](#).

59.2.3.3 Bypass mode

When no test operation is required, the BYPASS instruction can be loaded to place the JTAGC block into bypass mode. When in bypass mode, the single-bit bypass shift register is used to provide a minimum-length serial path to shift data between TDI and TDO.

59.3 External signal description

The JTAGC consists of a set of signals that connect to off-chip development tools and allow access to test support functions. The JTAGC signals are outlined in the following table and described in the following sections.

Table 59-2. JTAGC signal properties

Name	I/O	Function	Reset state
TCK	Input	Test clock	Weak pulldown
TDI	Input	Test data in	Weak pullup
TDO	Output	Test data out	High Z ¹
TMS	Input	Test mode select	Weak pullup

1. TDO output buffer enable is negated when the JTAGC is not in the Shift-IR or Shift-DR states. A weak pull may be implemented at the TDO pad for use when JTAGC is inactive.

59.3.1 Test clock input (TCK)

Test Clock Input (TCK) is an input pin used to synchronize the test logic and control register access through the TAP.

59.3.2 Test data input (TDI)

Test Data Input (TDI) is an input pin that receives serial test instructions and data. TDI is sampled on the rising edge of TCK.

59.3.3 Test data output (TDO)

Test Data Output (TDO) is an output pin that transmits serial output for test instructions and data. TDO is tristateable and is actively driven only in the Shift-IR and Shift-DR states of the TAP controller state machine, which is described in [TAP controller state machine](#).

59.3.4 Test mode select (TMS)

Test Mode Select (TMS) is an input pin used to sequence the IEEE 1149.1-2001 test control state machine. TMS is sampled on the rising edge of TCK.

59.4 Register description

This section provides a detailed description of the JTAGC block registers accessible through the TAP interface, including data registers and the instruction register. Individual bit-level descriptions and reset states of each register are included. These registers are not memory-mapped and can only be accessed through the TAP.

59.4.1 Instruction register

The JTAGC block uses a 4-bit instruction register as shown in the following figure.

The instruction register allows instructions to be loaded into the block to select the test to be performed, or the test data register to be accessed, or both. Instructions are shifted in through TDI when the TAP controller is in the Shift-IR state, and latched on the falling edge of TCK in the Update-IR state. The latched instruction value can only be changed in the Update-IR and Test-Logic-Reset TAP controller states.

Synchronous entry into the Test-Logic-Reset state results in the IDCODE instruction being loaded on the falling edge of TCK. Asynchronous entry into the Test-Logic-Reset state results in asynchronous loading of the IDCODE instruction. During the Capture-IR TAP controller state, the instruction shift register is loaded with the value 0b1, making this value the register's read value when the TAP controller is sequenced into the Shift-IR state.

	3	2	1	0
R	0	0	0	1
W	Instruction Code			
Reset:	0	0	0	1

Figure 59-2. Instruction register

59.4.2 Bypass register

The bypass register is a single-bit shift register path selected for serial data transfer between TDI and TDO when the following instructions are active:

- BYPASS
- HIGHZ
- CLAMP

After entry into the Capture-DR state, the single-bit shift register is set to a logic 0. Therefore, the first bit shifted out after selecting the bypass register is always a logic 0.

59.4.3 Device identification register

The device identification (JTAG ID) register, shown in the following figure, allows the revision number, part number, manufacturer, and design center responsible for the design of the part to be determined through the TAP.

The device identification register is selected for serial data transfer between TDI and TDO when the IDCODE instruction is active. Entry into the Capture-DR state when the device identification register is selected loads the IDCODE into the shift register to be shifted out on TDO in the Shift-DR state. No action occurs in the Update-DR state.

	31	30	29	28	27	26	25	24	23	22	21	20	19	18	17	16
R	Part Revision Number				Design Center						Part Identification Number					
W																
Reset	PRN				DC						PIN					
	15	14	13	12	11	10	9	8	7	6	5	4	3	2	1	0
R	Part Identification Number				Manufacturer Identity Code											1
W																
Reset	PIN (contd.)				MIC											1

The following table describes the device identification register functions. The device identification register values are described in the chip-specific JTAGC information.

Table 59-3. Device identification register field descriptions

Field	Description
PRN	Part Revision Number. Contains the revision number of the part.
DC	Design Center. Indicates the design center.
PIN	Part Identification Number. Contains the part number of the device.

Table continues on the next page...

Table 59-3. Device identification register field descriptions (continued)

Field	Description
MIC	Manufacturer Identity Code. Contains the reduced Joint Electron Device Engineering Council (JEDEC) ID .
IDCODE ID	IDCODE Register ID. Identifies this register as the device identification register and not the bypass register. Always set to 1.

59.4.4 Boundary scan register

The boundary scan register is connected between TDI and TDO when the EXTEST, SAMPLE, or SAMPLE/PRELOAD instructions are active. It is used to:

- Capture input pin data
- Force fixed values on output pins
- Select a logic value and direction for bidirectional pins

Each bit of the boundary scan register represents a separate boundary scan register cell, as described in the IEEE 1149.1-2001 standard and discussed in [Boundary scan](#). The size of the boundary scan register and bit ordering is device-dependent and can be found in the device BSDL file.

59.5 Functional description

This section explains the JTAGC functional description.

59.5.1 JTAGC reset configuration

When in reset, the TAP controller is forced into the Test-Logic-Reset state, thus disabling the test logic and allowing normal operation of the on-chip system logic. In addition, the instruction register is loaded with the IDCODE instruction.

59.5.2 IEEE 1149.1-2001 (JTAG) TAP

The JTAGC block uses the IEEE 1149.1-2001 TAP for accessing registers. This port can be shared with other TAP controllers on the MCU. Ownership of the port is determined by the value of the currently loaded instruction.

Functional description

Data is shifted between TDI and TDO through the selected register starting with the least significant bit, as illustrated in the following figure. This applies for the instruction register, test data registers, and the bypass register.

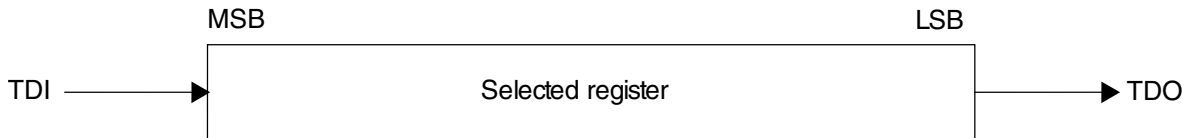
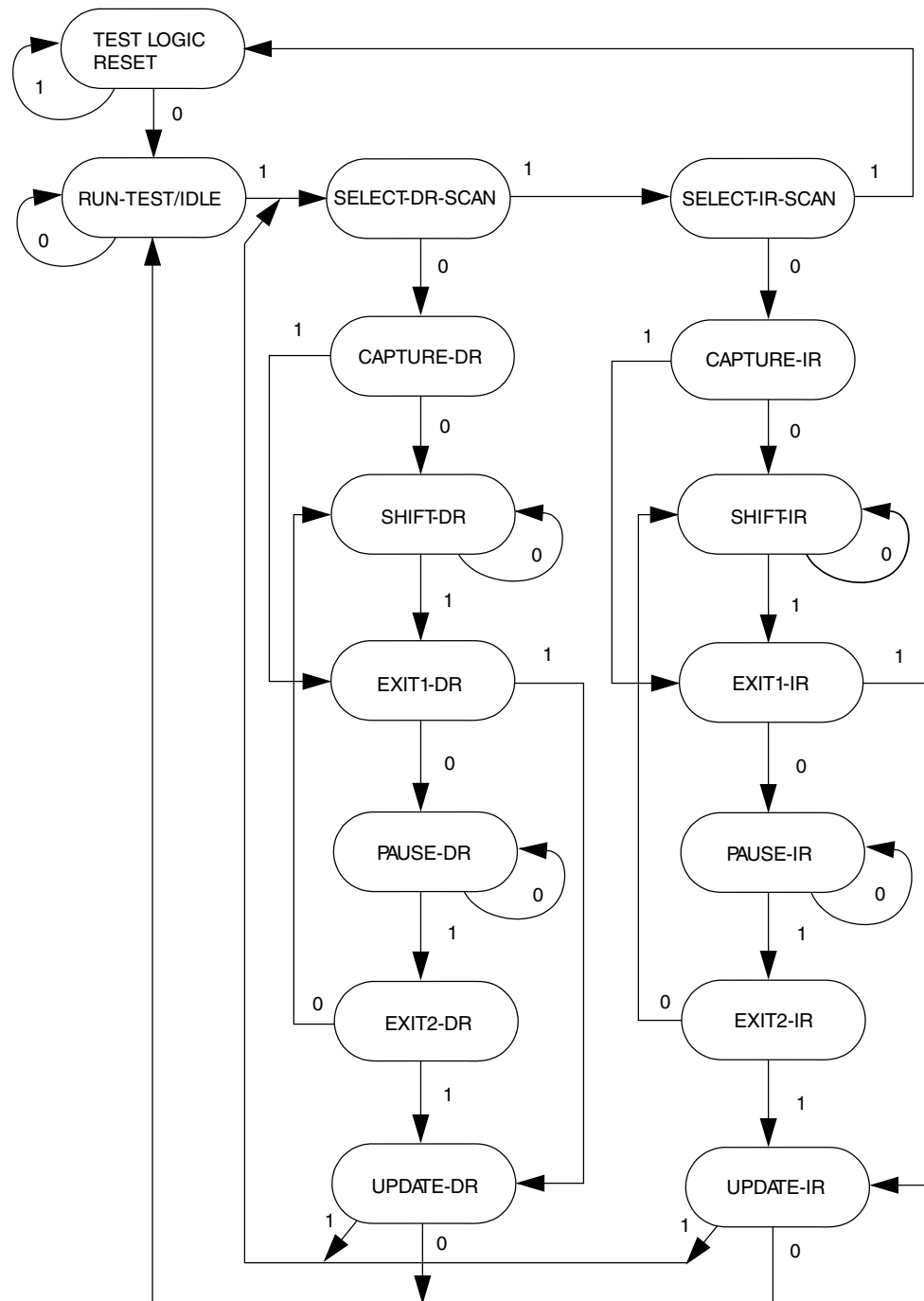

Figure 59-3. Shifting data through a register

59.5.3 TAP controller state machine

The TAP controller is a synchronous state machine that interprets the sequence of logical values on the TMS pin.

The following figure shows the machine's states. The value shown next to each state is the value of the TMS signal sampled on the rising edge of the TCK signal. As the figure shows, holding TMS at logic 1 when clocking TCK through a sufficient number of rising edges also causes the state machine to enter the Test-Logic-Reset state.



The value shown adjacent to each state transition in this figure represents the value of TMS at the time of a rising edge of TCK.

Figure 59-4. IEEE 1149.1-2001 TAP controller finite state machine

59.5.3.1 Enabling the TAP controller

The JTAGC TAP controller is enabled by setting the JTAGC enable to a logic 1 value.

59.5.3.2 Selecting an IEEE 1149.1-2001 register

Access to the JTAGC data registers is achieved by loading the instruction register with any of the JTAGC block instructions when the JTAGC is enabled. Instructions are shifted in via the Select-IR-Scan path and loaded in the Update-IR state. At this point, all data register access is performed via the Select-DR-Scan path.

The Select-DR-Scan path is used to read or write the register data by shifting in the data (LSB first) during the Shift-DR state. When reading a register, the register value is loaded into the IEEE 1149.1-2001 shifter during the Capture-DR state. When writing a register, the value is loaded from the IEEE 1149.1-2001 shifter to the register during the Update-DR state. When reading a register, there is no requirement to shift out the entire register contents. Shifting may be terminated after the required number of bits have been acquired.

59.5.4 JTAGC block instructions

The JTAGC block implements the IEEE 1149.1-2001 defined instructions listed in the following table. This section gives an overview of each instruction. See the IEEE 1149.1-2001 standard for more details. All undefined opcodes are reserved.

Table 59-4. 4-bit JTAG instructions

Instruction	Code[3:0]	Instruction summary
IDCODE	0000	Selects device identification register for shift
SAMPLE/PRELOAD	0010	Selects boundary scan register for shifting, sampling, and preloading without disturbing functional operation
SAMPLE	0011	Selects boundary scan register for shifting and sampling without disturbing functional operation
EXTEST	0100	Selects boundary scan register and applies preloaded values to output pins. NOTE: Execution of this instruction asserts functional reset.
Factory debug reserved	0101	Intended for factory debug only
Factory debug reserved	0110	Intended for factory debug only. See chip-specific information for possible alternate usage of this code.
Factory debug reserved	0111	Intended for factory debug only
Arm JTAG-DP Reserved	1000	This instruction goes the Arm JTAG-DP controller. See the Arm JTAG-DP documentation for more information.
HIGHZ	1001	Selects bypass register and tristates all output pins. NOTE: Execution of this instruction asserts functional reset.
Arm JTAG-DP Reserved	1010	This instruction goes the Arm JTAG-DP controller. See the Arm JTAG-DP documentation for more information.

Table continues on the next page...

Table 59-4. 4-bit JTAG instructions (continued)

Instruction	Code[3:0]	Instruction summary
Arm JTAG-DP Reserved	1011	This instruction goes the Arm JTAG-DP controller. See the Arm JTAG-DP documentation for more information.
CLAMP	1100	Selects bypass register and applies preloaded values to output pins. NOTE: Execution of this instruction asserts functional reset.
Arm JTAG-DP Reserved	1110	This instruction goes the Arm JTAG-DP controller. See the Arm JTAG-DP documentation for more information.
BYPASS	1111	Selects bypass register for data operations

59.5.4.1 IDCODE instruction

IDCODE selects the 32-bit device identification register as the shift path between TDI and TDO. This instruction allows interrogation of the MCU to determine its version number and other part identification data. IDCODE is the instruction placed into the instruction register when the JTAGC block is reset.

59.5.4.2 SAMPLE/PRELOAD instruction

The SAMPLE/PRELOAD instruction has two functions:

- The SAMPLE portion of the instruction obtains a sample of the system data and control signals present at the MCU input pins, and just before the boundary scan register cells at the output pins. This sampling occurs on the rising edge of TCK in the Capture-DR state when the SAMPLE/PRELOAD instruction is active. The sampled data is viewed by shifting it through the boundary scan register to the TDO output during the Shift-DR state. Both the data capture and the shift operation are transparent to system operation.
- The PRELOAD portion of the instruction initializes the boundary scan register cells before selecting the EXTEST or CLAMP instructions to perform boundary scan tests. This is achieved by shifting in initialization data to the boundary scan register during the Shift-DR state. The initialization data is transferred to the parallel outputs of the boundary scan register cells on the falling edge of TCK in the Update-DR state. The data is applied to the external output pins by the EXTEST or CLAMP instruction. System operation is not affected.

59.5.4.3 SAMPLE instruction

The SAMPLE instruction obtains a sample of the system data and control signals present at the MCU input pins, and just before the boundary scan register cells at the output pins. This sampling occurs on the rising edge of TCK in the Capture-DR state when the SAMPLE instruction is active. The sampled data is viewed by shifting it through the boundary scan register to the TDO output during the Shift-DR state. There is no defined action in the Update-DR state. Both the data capture and the shift operation are transparent to system operation.

59.5.4.4 EXTEST external test instruction

EXTEST selects the boundary scan register as the shift path between TDI and TDO. It allows testing of off-chip circuitry and board-level interconnections by driving preloaded data contained in the boundary scan register onto the system output pins. Typically, the preloaded data is loaded into the boundary scan register using the SAMPLE/PRELOAD instruction before the selection of EXTEST. EXTEST asserts the internal system reset for the MCU to force a predictable internal state when performing external boundary scan operations.

59.5.4.5 ENABLE_SOC_DATA1 instruction

The ENABLE_SOC_DATA1 instruction captures SoC data and selects the SOC_DATA register for connection as the shift path between TDI and TDO.

59.5.4.6 HIGHZ instruction

HIGHZ selects the bypass register as the shift path between TDI and TDO. When HIGHZ is active all output drivers are placed in an inactive drive state (for example, high impedance). HIGHZ also asserts the internal system reset for the MCU to force a predictable internal state.

59.5.4.7 CLAMP instruction

CLAMP allows the state of signals driven from MCU pins to be determined from the boundary scan register when the bypass register is selected as the serial path between TDI and TDO. CLAMP enhances test efficiency by reducing the overall shift path to a single

bit (the bypass register) when conducting an EXTEST type of instruction through the boundary scan register. CLAMP also asserts the internal system reset for the MCU to force a predictable internal state.

59.5.4.8 BYPASS instruction

BYPASS selects the bypass register, creating a single-bit shift register path between TDI and TDO. BYPASS enhances test efficiency by reducing the overall shift path when no test operation of the MCU is required. This allows more rapid movement of test data to and from other components on a board that are required to perform test functions. When the BYPASS instruction is active the system logic operates normally.

59.5.5 Boundary scan

The boundary scan technique allows signals at component boundaries to be controlled and observed through the shift-register stage associated with each pad. Each stage is part of a larger boundary scan register cell, and cells for each pad are interconnected serially to form a shift-register chain around the border of the design. The boundary scan register consists of this shift-register chain, and is connected between TDI and TDO when the EXTEST, SAMPLE, or SAMPLE/PRELOAD instructions are loaded. The shift-register chain contains a serial input and serial output, as well as clock and control signals.

59.6 Initialization/application information

The test logic is a static logic design, and TCK can be stopped in either a high or low state without loss of data. However, the system clock is not synchronized to TCK internally. Any mixed operation using both the test logic and the system functional logic requires external synchronization.

To initialize the JTAGC block and enable access to registers, the following sequence is required:

1. Place the JTAGC in reset through TAP controller state machine transitions controlled by TMS.
2. Load the appropriate instruction for the test or action to be performed.

Appendix A

S32K1XX Reference Manual release history

Table A-1. S32K1XX Reference Manual release history

Rev. No	Release date
14	23 September 2021
13	13 Apr 2020
12.1	28 Feb 2020
12	07 Feb 2020
11	27 June 2019
10	09 May 2019
9	18 September 2018
8	18 June 2018
7	19 April 2018
6	08 December 2017
5	18 October 2017
4	02 June 2017
3	14 March 2017
2	09 February 2017
1	12 August 2016



Appendix B

Release Notes for Revision 14

B.1 General changes

- In [Fast IRC Control Status Register \(SCG_FIRCCSR\)](#), changed the bit FIRCERR to Reserved.

B.2 About This Manual changes

- In [Audience](#), removed note 'Technical information for S32K14xW ...'

B.3 Introduction changes

- No substantial content changes

B.4 Memory map changes

- No substantial content changes

B.5 Signal multiplexing changes

- No substantial content changes

B.6 Security Overview changes

- No substantial content changes

B.7 Safety Overview changes

- No substantial content changes

B.8 CM0+ Overview changes

- No substantial content changes

B.9 CM4 Overview changes

- No substantial content changes

B.10 MTB changes

- No substantial content changes

B.11 MCM changes

B.11.1 Chip-specific MCM information changes

- No substantial content changes

B.11.2 MCM changes

- No substantial content changes

B.12 SIM changes

B.12.1 Chip-specific SIM information changes

- In [Miscellaneous control register 0 \(MISCTRL0\)](#), changed MGRAM to Internal scratch RAM (This is an internal RAM, accessible only within flash and not by any master) and changed MGATE to flash internal.

B.12.2 SIM changes

- Updated description of SDID register

B.13 PORT changes

B.13.1 Chip-specific PORT information changes

- No substantial content changes

B.13.2 Port Control and Interrupts (PORT) changes

- No substantial content changes

B.14 GPIO changes

B.14.1 Chip-specific GPIO information changes

- No substantial content changes

B.14.2 GPIO module changes

- No substantial content changes

B.15 AXBS-Lite changes

B.15.1 Chip-specific AXBS-Lite information changes

- No substantial content changes

B.15.2 AXBS_Lite module changes

- No substantial content changes

B.16 MPU changes

B.16.1 Chip-specific MPU information changes

- In [Chip-specific MPU information](#), added note "RGD0_WORD2[M1PE] bit field is not used in S32K116 and S31K118".

B.16.2 MPU module changes

- No substantial content changes

B.17 AIPS-Lite changes

B.17.1 Chip-specific AIPS information changes

- No substantial content changes

B.17.2 AIPS_Lite module changes

- No substantial content changes

B.18 DMAMUX changes

B.18.1 Chip-specific DMAMUX information changes

- No substantial content changes

B.18.2 DMAMUX module changes

- No substantial content changes

B.19 eDMA changes

B.19.1 Chip-specific eDMA information changes

- No substantial content changes

B.19.2 eDMA2 module changes

- Marked CR[VERSION] field reserved.
- In [eDMA basic data flow](#) updated statement 'eDMA engine address path channel x or y registers' to 'eDMA engine's internal register file' and statement '...load it into the address path channel x or y registers' to '.... load it into the internal register file'.
- In [eDMA initialization](#) updated statement 'As the TCD is read, the first transfer is initiated on the internal' to 'As the TCD is read, the first transfer is initiated on the system bus'.
- In [Channel linking](#) updated value of TCDn_CSR[MAJOR_LINKCH] from 0x7 to 0x3, updated 'TCD12_CSR[START] bit' to 'TCD2_CSR[START] bit', and 'TCD7_CSR[START] bit' to 'TCD3_CSR[START] bit'
- Updated the bit field value description of field [EDBG](#).
- Re-structured and re-aligned the sections outline.
- Replaced section "Introductin" with "Overview".
- Replaced section heading "eDMA system block diagram" with "Block diagram".
- Added Clocks section under Functional description.
- In [Table 18-2](#) modified the first bullet list of address path cloumn.
- Editorial changes
- Removed section 'Clocks'.
- Removed statement 'otherwise, a configuration error is reported' from TCDn_BITER_ELINKYES and TCDn_BITER_ELINKNO.

B.20 TRGMUX changes

B.20.1 Chip-specific TRGMUX information changes

- No substantial content changes

B.20.2 TRGMUX module changes

- No substantial content changes

B.21 EWM changes

B.21.1 Chip-specific EWM information changes

- No substantial content changes

B.21.2 EWM module changes

- No substantial content changes

B.22 EIM changes

B.22.1 Chip-specific EIM information changes

- No substantial content changes

B.22.2 EIM changes

- No substantial content changes

B.23 ERM changes

B.23.1 Chip-specific ERM information changes

- No substantial content changes

B.23.2 ERM module changes

- No substantial content changes

B.24 WDOG changes

B.24.1 Chip-specific WDOG information changes

- No substantial content changes

B.24.2 WDOG module changes

- No substantial content changes

B.25 CRC module changes

- Removed the specific mode names from the section [Low-power modes \(Stop\)](#).
- Added the section [Use cases](#).
- Editorial changes throughout.
- Editorial changes throughout.
- Added the note "Write access to the register.....if a transfer error occurs", to [Memory map and register descriptions](#).

B.26 Reset and Boot changes

- No substantial content changes

B.27 RCM changes

B.27.1 Chip-specific RCM information changes

- No substantial content changes

B.27.2 RCM changes

- No substantial content changes

B.28 Clock Distribution changes

- No substantial content changes

B.29 SCG changes

B.29.1 Chip-specific SCG information changes

B.29.2 SCG changes

- No substantial content changes

B.30 PCC changes

B.30.1 Chip-specific PCC information changes

- No substantial content changes

B.30.2 PCC module changes

- No substantial content changes

B.31 CMU changes

B.31.1 CMU changes

- No substantial content changes

B.31.2 CMU_FC module changes

- No substantial content changes

B.32 Memories and memory interfaces changes

- [SRAM sizes](#)
 - For the details on SRAM size added reference to datasheet

B.33 PRAMC changes

- No substantial content changes

B.34 LMEM changes

B.34.1 Chip-specific LMEM information changes

- No substantial content changes

B.34.2 LMEM module changes

- No substantial content changes

B.35 MSCM changes

B.35.1 Chip-specific MSCM information changes

- No substantial content changes

B.35.2 MSCM changes

- No substantial content changes

B.36 FMC changes

B.36.1 Chip-specific FMC changes

- No substantial content changes

B.36.2 FMC changes

- No substantial content changes

B.37 FTFC changes

B.37.1 Chip-specific FTFC information changes

B.37.2 FTFC changes

- No substantial content changes

B.38 FTFM changes

- Update flash command timing values.

B.39 QSPI changes

B.39.1 Chip-specific QSPI information changes

- No substantial content changes

B.39.2 QuadSPI changes

- No substantial content changes

B.40 Power Management changes

- In [Table 39-4](#), for 12-bit ADC changed the VLPR from OFF to FF (Only SIRC as a source).
- In [Table 39-4](#), added row for SYSTICK module.

B.41 SMC changes

- No substantial content changes

B.42 PMC changes

B.42.1 Chip-specific PMC changes

- No substantial content changes

B.42.2 PMC module changes

- In [Low Voltage Reset \(LVR\) Operation](#), added a note.

B.43 ADC Configuration changes

- In [Table 43-1](#) and [Table 43-2](#) added information for S32K142W.

B.44 ADC changes

B.44.1 Chip-specific ADC information changes

- No substantial content changes

B.44.2 ADC module changes

- No substantial content changes

B.45 CMP changes

B.45.1 Chip-specific CMP changes

- In section [Table 45-1](#), added S32K142W information.

B.45.2 CMP changes

- Minor correction in C1[INNSEL]: "... selected for the minus input of the comparator".

B.46 PDB changes

B.46.1 Chip-specific PDB information changes

- In [Table 46-1](#), added S32K142W information.

B.46.2 PDB changes

- No substantial content changes

B.47 FTM changes

B.47.1 Chip-specific FTM information changes

- Added [FTM fixed frequency clock](#) .

B.47.2 FTM module changes

- No substantial content changes

B.48 LPIT changes

B.48.1 Chip-specific LPIT information changes

- No substantial content changes

B.48.2 LPIT module changes

- No substantial content changes

B.49 LPTMR changes

B.49.1 Chip-specific LPTMR information changes

- No substantial content changes

B.49.2 LPTMR module changes

- No substantial content changes

B.50 RTC changes

B.50.1 Chip-specific RTC changes

- No substantial content changes

B.50.2 RTC module changes

- No substantial content changes

B.51 LPSPI changes

B.51.1 Chip-specific LPSPI information changes

- No substantial content changes

B.51.2 LPSPI module changes

- No substantial content changes

B.52 LPI2C changes

B.52.1 Chip-specific LPI2C information changes

- No substantial content changes

B.52.2 LPI2C module changes

- No substantial content changes

B.53 LPUART changes

B.53.1 Chip-specific LPUART information changes

- No substantial content changes

B.53.2 LPUART module changes

- No substantial content changes

B.54 FlexIO changes

B.54.1 Chip-specific FlexIO changes

- No substantial content changes

B.54.2 FlexIO module changes

- No substantial content changes

B.55 FlexCAN changes

B.55.1 Chip-specific FlexCAN information changes

- No substantial content changes

B.55.2 FlexCAN module changes

- In [FlexCAN initialization sequence](#) changed "The FlexCAN module may be reset in three ways" to "You can reset FlexCAN in the following ways."
- In [Error and Status 1 Register \(ESR1\)](#), added the following text to all read-only error-flag fields: "After a read operation, the field's value clears to 0."
- Made editorial changes.
- Made editorial changes.
- Removed Introduction section.
- Added the following sections:
 - [Block diagram](#)
 - [Clocks](#)
 - [Reset](#)
- In [Features](#), changed the heading to Features.
- Moved [Modes of operation](#) under "Functional Description".
- Moved [Modes of operation details](#) under "Modes of operation".
- Moved [Clock domains and restrictions](#) under "Clocks".
- In [FlexCAN initialization sequence](#), removed the reset related content.
- In [Modes of operation](#) under CAN FD Active mode replaced sentence "FD Protocol and CAN 2.0 Protocol 2.0" with "FD, Standard (2.0) and 2.0B Protocol".
- In [Clock domains and restrictions](#), removed the texts "and is derived from the peripheral clock" and "and is derived directly from a crystal oscillator clock, so that very low jitter performance can be achieved on the CAN bus" as internal.
- In [Error and Status 1 Register \(ESR1\)](#), added MCR[WRNEN] in the text "CPU must clear this flag before disabling MCR[WRNEN]".
- In [Error and Status 1 Register \(ESR1\)](#), added note "Reading Host can clear these field".
- In [Control 1 Register \(CTRL1\)](#), moved the text "This bit can be written in Freeze mode only because it is blocked by hardware in other modes" after the notes.
- In [Bus interface](#), added table "Access permissions".
- In [Clocks](#), changed the text from "Clock Controller Module (CCM)" to "chip clocking chapter".

B.56 SAI changes

B.56.1 Chip-specific SAI changes

- No substantial content changes

B.56.2 SAI module changes

- No substantial content changes

B.57 ENETchanges

B.57.1 Chip-specific ENET changes

- No substantial content changes

B.57.2 ENET module changes

- No substantial content changes

B.58 Debug changes

- In [MDM-AP status and control registers](#), added footnote "This value is applicable only for S32K14x devices".

B.59 JTAGC changes

B.59.1 Chip-specific JTAGC information changes

- No substantial content changes

B.59.2 JTAGC module changes

- No substantial content changes

How to Reach Us:**Home Page:**nxp.com**Web Support:**nxp.com/support

Information in this document is provided solely to enable system and software implementers to use NXP products. There are no express or implied copyright licenses granted hereunder to design or fabricate any integrated circuits based on the information in this document. NXP reserves the right to make changes without further notice to any products herein.

NXP makes no warranty, representation, or guarantee regarding the suitability of its products for any particular purpose, nor does NXP assume any liability arising out of the application or use of any product or circuit, and specifically disclaims any and all liability, including without limitation consequential or incidental damages. "Typical" parameters that may be provided in NXP data sheets and/or specifications can and do vary in different applications, and actual performance may vary over time. All operating parameters, including "typicals," must be validated for each customer application by customer's technical experts. NXP does not convey any license under its patent rights nor the rights of others. NXP sells products pursuant to standard terms and conditions of sale, which can be found at the following address: nxp.com/SalesTermsandConditions.

While NXP has implemented advanced security features, all products may be subject to unidentified vulnerabilities. Customers are responsible for the design and operation of their applications and products to reduce the effect of these vulnerabilities on customer's applications and products, and NXP accepts no liability for any vulnerability that is discovered. Customers should implement appropriate design and operating safeguards to minimize the risks associated with their applications and products.

NXP, the NXP logo, NXP SECURE CONNECTIONS FOR A SMARTER WORLD, COOLFLUX, EMBRACE, GREENCHIP, HITAG, I2C BUS, ICODE, JCOP, LIFE VIBES, MIFARE, MIFARE CLASSIC, MIFARE DESFire, MIFARE PLUS, MIFARE FLEX, MANTIS, MIFARE ULTRALIGHT, MIFARE4MOBILE, MIGLO, NTAG, ROADLINK, SMARTLX, SMARTMX, STARPLUG, TOPFET, TRENCHMOS, UCODE, Freescale, the Freescale logo, AltiVec, C-5, CodeTEST, CodeWarrior, ColdFire, ColdFire+, C-Ware, the Energy Efficient Solutions logo, Kinetis, Layerscape, MagniV, mobileGT, PEG, PowerQUICC, Processor Expert, QorIQ, QorIQ Qonverge, Ready Play, SafeAssure, the SafeAssure logo, StarCore, Symphony, VortiQa, Vybrid, Airfast, BeeKit, BeeStack, CoreNet, Flexis, MXC, Platform in a Package, QUICC Engine, SMARTMOS, Tower, TurboLink, and UMEMS are trademarks of NXP B.V. All other product or service names are the property of their respective owners. AMBA, Arm, Arm7, Arm7TDMI, Arm9, Arm11, Artisan, big.LITTLE, Cordio, CoreLink, CoreSight, Cortex, DesignStart, DynamIQ, Jazelle, Keil, Mali, Mbed, Mbed Enabled, NEON, POP, RealView, SecurCore, Socrates, Thumb, TrustZone, ULINK, ULINK2, ULINK-ME, ULINK-PLUS, ULINKpro, μ Vision, Versatile are trademarks or registered trademarks of Arm Limited (or its subsidiaries) in the US and/or elsewhere. The related technology may be protected by any or all of patents, copyrights, designs and trade secrets. All rights reserved. Oracle and Java are registered trademarks of Oracle and/or its affiliates. The Power Architecture and Power.org word marks and the Power and Power.org logos and related marks are trademarks and service marks licensed by Power.org.

© 2015–2021 NXP B.V.

Document Number S32K1XXRM
Revision 14, 09/2021

